



امداد خودرو فارما

تلفن شبانه روزی: ۰۲۱-۸۸۸۶۲۰۱۵

FarmaSOS.com

GLA

2016



CLA



Mercedes-Benz



UPDATE YOUR STATUS

WHAT YOU DRIVE REVEALS WHAT DRIVES YOU. THE ATHLETIC, ADVANCED AND AFFORDABLE CLA LETS YOU LIVE IT UP. WITHOUT HAVING TO LIVE IT DOWN.



تلفن: شنبه روزی، ۰۸۵-۸۸۸۶۳۰۲۱

FarmaSOS.com

KNOCKOUT PROFILE, KNOCKOFF PRICE

It's easy to admire a car's styling. But when a car has true style, that's something else. It's also fun to find a good deal. But so much better when it turns out to be the real deal. The CLA doesn't merely wear the illustrious Star in its grille. It earns it—with the innovation of its engineering, the reward of its performance, and a design that reflects not just its own shining character, but yours. True style comes from confidence and from competence. It comes from within. It's why the CLA fits in so well in the Mercedes-Benz family of cars—and stands out next to every other car at its price.

EMBRACE THE CURVES

SCULPTED SHEET METAL ENVELOPS THE CLA LIKE TIGHT, TONED MUSCLE.
THE WAY ITS CHASSIS CLINGS TO A CURVY ROAD IS JUST AS SEDUCTIVE.



اراد خودرو فارما

تلفن شبانه روزی: ۰۲۱-۸۸۸۶۳۰۸۵

Farma95.com

ONLY THE WIND WON'T NOTICE IT

Razor-sharp yet fluid, the CLA's lines are honed to achieve class-leading aerodynamics. So it can slice through the air and grip the road, while it cuts the clutter and captures admiring eyes. Frameless side glass and a tensed, arching roofline express pure coupe passion, yet its four doors open to a roomy cabin. And to reflect not only its own vibrant personality but yours, the CLA offers countless ways to assert your style. Like the glistening chrome diamond-block grille of the Sport Package. The deep black cues of the Night Package. And 17", 18" or 19" wheels,¹ so you can make the most of those curves.



امداد خودرو فارما

تلفن شماره ۰۲۱-۸۸۸۶۲۰۸۵

FarmaSOS.com

GET IT CUSTOM- TAILORED

LUXURY LEADERSHIP TO RACING CHAMPIONSHIPS,
THE SPACIOUS, SPORTY CLA CABIN IS INSPIRED
EQUALLY BY ALL OF ITS FAMILY VALUES. IT'LL SEAT
YOU COMFORTABLY. IT'LL SUIT YOU PERFECTLY.



فارس سوس
تلفن: ۰۲۱-۸۸۸۶۲۰۸۵
FarmaSOS.com



REWARDS IN EVERY CORNER

With deep bolsters, adjustable cushion length, and racecar-inspired integrated head restraints, the CLA's power front sport seats inspire you to enjoy its handling anywhere you drive. Its spacious rear seats are designed much like the fronts, so your passengers can feel embraced anywhere they sit. Front and rear cabins provide center armrests and cupholders. And numerous details merge function with artful design—like LED ambient lighting not just in the console and footwells but under the front head restraints, too. Or round, twist-click dash vents—like you'd find in a private jet—that keep you traveling in style.

DEPTH IN EVERY SURFACE

While the CLA cabin can seat five with ease, it's far from a "one size fits all" design. Sporty gauges, colorful displays and intuitive controls are set off by elegant chrome and satin metallic trim. The winglike dash can be accented with sleek Anthracite trim, racy brushed aluminum, or two types of hand-polished wood. Standard MB-Tex upholstery combines the look of leather with easy care and lasting suppleness. Options include rich leather with topstitching of the dash and doors, or the bold Sport Package Plus—a suite of exterior and chassis upgrades whose cockpit features suedelike DINAMICA and red accents. What's beneath a CLA's surfaces helps make you feel at ease in other important ways. Steam-expanded foams—a process pioneered by Mercedes-Benz—eliminate harsh chemicals, while products from flax, coconut and olives sustainably support numerous cabin elements.

TAKE IT TO THE BANK

EFFICIENCY IS MORE THAN CLASS-LEADING MPG.² THE LEAN, NIMBLE CLA PAYS PERFORMANCE DIVIDENDS, FROM BANKED CORNERS TO FLAT-OUT HIGHWAYS.

ایراد خودرو فارما

تلفن: ۰۲۱-۸۸۸۶۳۰۸۵

FarmaSOS.com



PAYBACK ON OUTSTANDING BALANCE

In the business world, they say time is money. In the CLA 250, time is everything. It's the currency of quickness, from its 6.9-second 0-60 rush³ to the 150,000 spins/minute of its turbo at max boost. Time is what puts you ahead: The Direct Injection and multispark ignition can fine-tune themselves in a millisecond. Its dual-clutch 7-speed automatic can change gears faster than a human can shift a manual gearbox. And its available 4MATIC[®] all-wheel drive⁴ and new adjustable suspension can both respond to the road in real time. As for having a great time, that's the payoff of driving a CLA.



UNLOCK THE NEXT LEVEL

AFTER CREATING THE MOST POWERFUL 4-CYLINDER ENGINE IN PRODUCTION,
WHAT DID THE RACERS AT MERCEDES-AMG DO? HINT: IT WASN'T A VICTORY LAP.
MEET THE NEW BOSS: THE EVEN MORE POWERFUL, 375-HP 2016 AMG CLA 45.



اراد خودرو فارما

تلفن شبانه روزی: ۰۲۱-۸۸۸۶۲۰۸۵

FarmaSOS.com

"One man, one engine" is more than a motto for AMG. It's a guiding philosophy and a process rooted in racing, where precision and endurance are proven in record time. The heart of a Mercedes-AMG CLA 45 is its turbocharged 4-cylinder engine. Each one is crafted by the hands of its own "master," an expert who visually inspects and records every component, and computer-verifies each torque spec. Only after the engine is individually bench-tested does it earn its master's signature, on a metal plaque the builder affixes to its cover. This degree of detail-obsession is evident throughout the vehicle—from its mighty brake hardware, to its expanded range of DYNAMIC SELECT driving modes, to its performance-focused cockpit.

The handcrafted 2.0-liter turbo-4 of the CLA 45 is a rousing symphony of superlatives: The most powerful 4-cylinder in production, it grows even stronger for 2016, to 375 hp and 350 lb-ft of torque. Its twin-scroll turbo quickly spools up to 165,000 rpm to produce class-leading boost—26.1 psi max—and the industry's highest hp/liter. With torque-vectoring AMG Performance 4MATIC® and a more aggressively geared AMG SPEEDSHIFT® DCT 7-speed, it can catapult to 60 mph in 4.1 seconds.³ And beyond its standard AMG chassis and 18" AMG® wheels,⁴ its performance options include a new AMG DYNAMIC PLUS Package: two-stage damping, limited-slip front differential, a RACE mode, and 167-mph top speed.⁵



امداد خودرو فارما

تلفن شبانه: ۰۲۱ ۸۸۸۶۲ ۸۵

FarmaSOS.com

AMG
DRIVING PERFORMANCE



امداد خودرو فارما

تلفن شبانه روزی: ۰۲۱-۸۸۸۶۲۰۸۵

FarmaSOS.com

KEEP A SAFE DISTANCE AHEAD

WHEN SECONDS MATTER MOST, SO DO FIRSTS. IT'S WHY MERCEDES-BENZ ENGINEERS KEEP THINKING UP NEW WAYS TO MAKE EVERY CAR SAFER.

Every effort of Mercedes-Benz safety engineers goes toward a singular goal: accident-free driving. They're also keenly aware that achieving this goal only for the vehicles they design would be pointless. The roads can only be safe for someone when they're safe for everyone. The 1951 patent for the first crumple zone is one of more than 88,000 that Mercedes-Benz has earned in the past 130 years. Energy-absorbing front and rear deformation zones flank a reinforced "safety cell" for the passengers. But the idea did more than better protect the occupants of a Mercedes-Benz. It eventually became the way all automobiles are made, thereby helping protect everyone on the road better. Over the decades, countless breakthroughs that were

pioneered under the Three-Pointed Star have gone on to become the safety standards for all automobiles—like the Antilock Braking System (ABS), the Electronic Stability Program (ESP®), emergency-sensing Brake Assist (BAS®), the seat-belt Emergency Tensioning Device (ETD), and side curtain air bags. For many of these inventions, Mercedes-Benz has chosen not to enforce their patents—since some things are too important not to share. As a result, you can expect to see some of the groundbreaking advancements of today's Mercedes-Benz on other cars in a few years. That said, sometimes the future is only milliseconds ahead of you. And nobody prepares you for it like the engineers who've spent decades thinking about it.



COLLISION PREVENTION ASSIST PLUS

Radar-based technology alerts you if you're following a vehicle too quickly or too closely. As soon as you start to brake, Adaptive Brake Assist automatically adjusts the braking to an ideal level, to help prevent a collision or reduce its severity. The system can apply the brakes autonomously from speeds up to 65 mph. It can also activate PRE-SAFE®, the predictive system that can tighten the front seat belts and close the windows in the moments before a collision.⁶

ATTENTION ASSIST

By continuously monitoring as many as 70 parameters of driving behavior, ATTENTION ASSIST® can alert you both visually and audibly if it detects signs of driver-drowsiness on long trips. Its enhanced sensitivity helps the system detect drivers who begin their trip drowsy. A display in the gauge cluster can help you track your own attention level and driving time along your journey.⁷

BLIND SPOT ASSIST AND LANE KEEPING ASSIST

When you're driving at speeds above approximately 20 mph, optional radar technology helps sense when a vehicle enters the blind-spot area on either side of your vehicle, and alerts you by illuminating an icon in the side mirror.⁸ By monitoring visible road markings when you're driving faster than 37 mph, optional Lane Keeping Assist helps detect unintended drifting off-course. If it senses lane drift, the system alerts you by vibrating the steering wheel.⁷

4MATIC ALL-WHEEL DRIVE

In any season, on any road, available 4MATIC® all-wheel drive adds confidence and control. Lightweight and nimble, this advanced generation of variable-torque 4MATIC was developed especially for the CLA. It continually monitors for slippage at each wheel, and can instantly send up to 50% of the engine's torque to the rear wheels in response to changing driving conditions.⁴



امداد خود روفارما

تلفن شبانه روزی: ۰۲۱-۸۸۸۶۲۰۸۵

FarmaSOS.com

KNOW
WHAT'S NEXT

THE CLA IS EQUIPPED WITH SAFETY INNOVATIONS YOU MIGHT NOT SEE ON OTHER CARS FOR YEARS. BUT WHY WAIT? USING RADAR AND OTHER ADVANCED SENSORS, YOUR CLA CAN ALSO KEEP AN EYE ON YOUR IMMEDIATE FUTURE, TO HELP YOU GET OUT OF DANGER BEFORE YOU'RE IN IT.

Please see endnotes at back of brochure.

EMERGENCY-SENSING BRAKE ASSIST

The Brake Assist system (BAS[®]) senses emergency braking based on the speed at which you press the brake pedal. If it detects a panic situation, it immediately applies maximum available power boost. By eliminating the delay caused by a common human tendency not to brake hard enough, soon enough, Brake Assist can potentially reduce the overall stopping distance—a benefit that may help you avoid a collision. Letting up on the brake pedal releases Brake Assist.⁹

DISTRONIC PLUS

Radar-based cruise control adapts your set speed to the flow of traffic ahead, automatically slowing until your path is clear again. If the vehicle ahead slows to a stop, optional DISTRONIC PLUS[®] can brake to a full halt. When the traffic starts to go, you can resume with just a tap of the accelerator pedal or cruise control lever—or it will resume automatically if the stop is less than a second.¹⁰

ADAPTIVE BRAKING TECHNOLOGY

A suite of advancements pioneered by Mercedes-Benz has gone on to become an industry standard. If you lift off the accelerator pedal quickly, Predictive Brake Priming pre-charges the brakes for more immediate response when you apply them. In the rain, Automatic Brake Drying periodically sweeps water build-up from the discs. Hill-Start Assist helps prevent rollback in uphill starts. And a brake HOLD feature can make long red lights or stopped traffic a little easier.⁷

PARKTRONIC WITH ACTIVE PARKING ASSIST

An optional system can size up open parking spaces as you drive by. When you decide to back into one, it can expertly steer and brake for you—and steer you back out later. In any low-speed maneuver, PARKTRONIC's ultrasonic sensors in the bumpers help detect nearby objects within its field of view. Audible and visual indicators in the cabin help you navigate tight spaces with confidence.



TAKE A GOOD LOOK

EASY TO USE AND EASY ON THE EYES, THE CLA PAIRS FUNCTION WITH FLAIR.



ابدانورد و جانا

تلفن شبانه روزی: ۰۲۱-۸۸۸۶۲۰۸۵

FarmaSOS.com

ERGONOMIC STIMULUS PACKAGE

The CLA cockpit takes good looks to the next level, with illustrated color displays, crisp analog gauges, and a design you can't help but pause to admire when you're not focusing on the road. And when you are on the move, its ergonomic design looks even better. Readouts are clear at a glance. Key controls are at your fingertips, like a multifunction steering wheel with shift paddles. And all its features feel like second nature from the first time you use them.



تلفن شبانه روزی: ۰۲۱ ۸۸۸۶۲۰۸۵

FarmaSOS.com

A CLA may drive on the same roads, to the same destinations, as other cars, but it'll take you far beyond the ordinary along the way. It can make the world your playlist, with standard HD Radio™ stations, Bluetooth® audio and a USB port. And with music options that start nationwide with SiriusXM Radio,¹¹ and go global with Web-based streaming audio.¹² You can search via Google or Yelp in your car, and send the result directly to the COMAND® navigation.¹³ It all comes together via an intuitive central controller—on the console, where your hand rests comfortably—and a big, sleek color screen that's in your natural line of sight. From the pushbutton KEYLESS-START and dual-zone climate control, to the available multicolor ambient lighting, the CLA attends to all your senses by focusing on each of them. What you see looks right. What you hear sounds rich. And what you touch feels premium and precise.



FROM MULTICOLOR ILLUMINATION TO MULTIMEDIA ENTERTAINMENT, THE CLA IS ENGINEERED TO TAKE FAR-REACHING TECHNOLOGY CLOSER TO PERFECTION. IT'S EASY TO REACH, AND EVEN EASIER TO GRASP.

EXPAND YOUR SCOPE



TRAVEL WITHOUT RESERVATIONS IN THE VERSATILE CLA. TAKE OUT A FEW FRIENDS. TAKE ON A WEEKEND'S LUGGAGE. OR TAKE IN THE NIGHTTIME SKY. WHETHER YOU'RE GOING OUT ON THE TOWN OR OUT OF TOWN, THE OUTGOING CLA IS UP FOR IT ANYTIME YOU ARE.

EXTEND YOUR STAY





Within the profile and performance of a sporty coupe, the CLA's cabin provides the refinement of a Mercedes-Benz luxury sedan. There's room for five, plus a generous, richly finished trunk, and the versatility of split-folding rear seats with a center-armrest pass-through.¹⁴ The digital dual-zone climate control filters dust and pollen from the air, and includes adjustable vents for the rear cabin. The available heated front seats automatically cycle through their three levels of heating—for rapid warmth, followed by lasting comfort. The Panorama roof can let all five CLA passengers take in the sunshine or the romance of a starry night. Its large power-operated panel of heat-rejecting glass tilts up to vent the cabin, or slides open for a breeze. And for everyone's enjoyment, harman/kardon® has developed a 450-watt digital surround sound system that's tailored precisely to the CLA's cabin acoustics.



FEEL TOGETHER WHEREVER

IT'S PERFECTLY NATURAL TO DEVELOP AN EMOTIONAL ATTACHMENT TO YOUR MERCEDES-BENZ. WITH MBRACE, ENJOYING A TECHNOLOGICAL CONNECTION IS JUST AS EASY.

With Mercedes-Benz mbrace[®], your car is only a click away. Five years of mbrace Connect benefits and services¹² come standard with every new 2016 Mercedes-Benz, providing you with remote access to your vehicle from your smartphone or computer. With the mbrace Mobile App,¹⁵ you can lock, unlock and locate your car—and more. You can access Google and Yelp from your car with an ever-evolving variety of in-vehicle apps. You can send destinations to your car's available COMAND[®] navigation system from your computer or phone. Even your car can reach out, with remote diagnostics and a direct connection to Mercedes-Benz Roadside Assistance.¹⁶ Three additional packages bring you even more connections—from added safety and security, to a personal concierge, to streaming music and in-car WiFi for you and your friends. With mbrace, your Mercedes-Benz helps you stay connected not just to your car, but to your world—from anywhere you are, and wherever tomorrow takes you.

mbrace Connect 5 years included

State-of-the-art convenience with remote vehicle access, in-vehicle apps and over-the-air updates

Package includes:

- mbrace Mobile App for Android or iPhone
- Remote lock/unlock and other vehicle features via Mobile App
- Access to mbrace Web services at mbrace.MBUSA.com
- Remote diagnostics with direct dealer connection
- Over-the-air updates of many mbrace features and apps
- An evolving selection of Mercedes-Benz Apps, such as:
 - Google[™] Local Search
 - Yelp
 - Fuel station finder with prices
 - Weather reports locally and around the world
 - Airport flight status
 - Local movie theater showtimes
- Valet Protect
- Viewable traffic cams in many metro markets

mbrace Secure

6-month trial included
Requires mbrace Connect

Added peace of mind from safety and security features for you, your family, and your vehicle

Package includes:

- Automatic Collision Notification
- Emergency calling from your car's SOS button or the Mobile App
- Automatic Alarm Notification
- Stolen vehicle location assistance
- Agent-assisted remote locking and unlocking
- Dealer connect

mbrace Concierge

3-month trial included
Requires mbrace Secure

Personal assistance from highly knowledgeable professionals with access to a world of resources

Package includes:

- Personal concierges to help you stay more productive on the road, or from the Mobile App on your smartphone
- Expert recommendations and reservations for dining out, and for tickets to events
- Turn-by-turn directions from a live assistant or sent to your car
- Travel assistance, including reservations and changes for hotels, airlines and car rentals
- Answers to most any question, help with most any request

mbrace Entertain

3-month trial included
Requires mbrace Secure

Online, on-the-road enjoyment from streaming entertainment to maps, along with in-car WiFi

Package includes:

- Streaming audio and data via widely available 3G coverage
- In-car WiFi with secure connection of up to four devices
- Online maps, powered by Google
- A selection of streaming audio apps, including:
 - Tuneln[®] radio
 - iHeartRadio[®] Available starting Fall 2015
 - Mercedes-Benz Radio

WiFi and online maps require Multimedia Package

Mercedes me is a new online destination for Mercedes-Benz drivers, where you can access vehicle info, get more from your mbrace features, learn more about your car, and follow the exciting world of Mercedes-Benz. Take a tour at MBUSA.com/me



CAR IN YOUR POCKET

The mbrace Mobile App on your iPhone or Android phone lets you remote-control a number of car features from anywhere your phone has service. You can lock or unlock the doors. Locate your car on a map from up to a mile away. Or flash its lights and sound the horn. You can even look up an address, and send it directly to your car's COMAND navigation system.

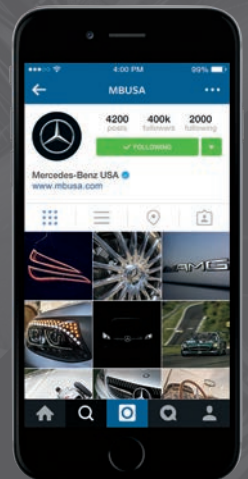

OUR WORLD IS YOURS

The online world of Mercedes-Benz is one of many ways you can enjoy being part of the family. You can keep up to date with news and events, or take in an entertaining film. You can get more from your vehicle with helpful tutorial videos and downloadable manuals. And you can check out photos from other Mercedes-Benz drivers and fans, and best of all, share yours as well.



BUILD YOUR OWN

MBUSA.com/CLA

Specifications

	CLA 250 Coupe	AMG CLA 45 Coupe
Engine	Type	2.0-liter turbo Direct Injection gasoline inline-4
	Power	208 hp @ 5,500 rpm
	Torque	258 lb-ft @ 1,250-4,000 rpm
Transmission	7-speed dual-clutch automatic with steering-wheel shift paddles	7-speed AMG SPEEDSHIFT® DCT dual-clutch automatic with console-mounted E-SELECT electronic gear selector and steering-wheel shift paddles
Acceleration, 0-60 mph³	6.9 sec	4.1 sec
Wheels	17" 5-spoke with all-season Extended Mobility tires ¹	18" AMG twin 5-spoke with high-performance tires ¹
Suspension	4-wheel independent strut front/multilink rear	AMG Sport Suspension, 4-wheel independent strut front/multilink rear
Drivetrain	Front-wheel drive or 4MATIC® all-wheel drive	AMG Performance 4MATIC all-wheel drive

امداد خودرو فارما

Dimensions

	CLA 250 Coupe	AMG CLA 45 Coupe
Wheelbase	106.3"	106.3"
Overall length	182.3"	184.7"
Overall height	56.6"	55.7"
Overall width	80.0" (with mirrors)	80.0" (with mirrors)
Curb weight	3,252 lbs 4MATIC: 3,384 lbs	3,450 lbs
Headroom (front/rear)	38.2" / 35.4" with Panorama roof: 37.0" / 35.6"	38.2" / 35.4" with Panorama roof: 37.0" / 35.6"
Legroom (front/rear)	40.2" / 27.1"	40.2" / 27.1"
Shoulder room (front/rear)	56.0" / 53.2"	56.0" / 53.2"
Cargo capacity	13.1 cu ft	13.1 cu ft

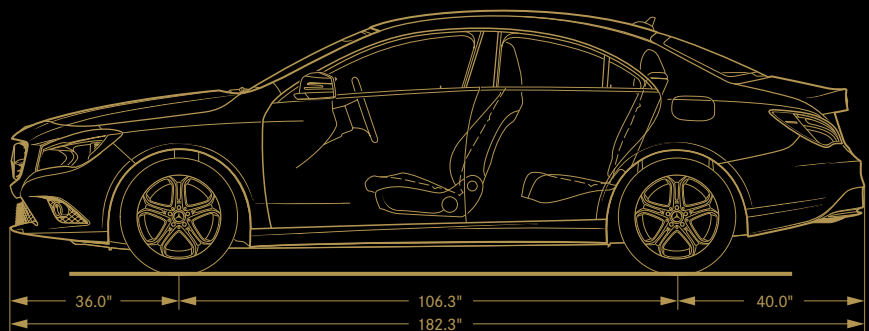
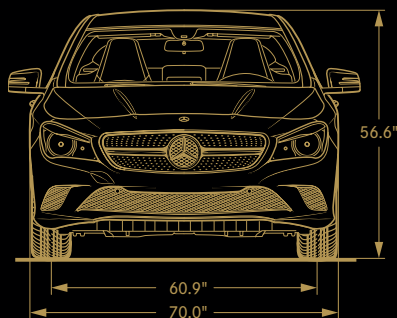

KEY STANDARD FEATURES

CLA 250 Coupe
AMG CLA 45 Coupe

Performance and efficiency

- ● ECO Start/Stop system
 - — DYNAMIC SELECT with ECO, Sport and Manual modes
 - ● AMG DYNAMIC SELECT with Comfort, Sport, Sport+ and Individual modes
 - ● AMG sport exhaust
-
- ● Electric parking brake with automatic release in Drive
 - ● AMG high-performance braking system
 - ● Torque-vectoring Curve Dynamic Assist

Safety and security

- ● COLLISION PREVENTION ASSIST PLUS
 - ● ATTENTION ASSIST®
-
- ● Electronic Stability Program (ESP®)
 - ● Adaptive braking technology: Predictive Brake Priming, Automatic Brake Drying, Hill-Start Assist, and Brake HOLD feature
 - ● Emergency-sensing Brake Assist (BAS®)
 - ● Advanced Tire Pressure Monitoring System
-
- ● 10-way air bag protection
-
- — Daytime Running Lamps, partial-LED taillamps
 - ● LED Daytime Running Lamps, LED taillamps
 - ● Automatic light-sensing headlamps
 - ● Bi-Xenon headlamps
-
- ● SmartKey remote locking
 - ● Pushbutton KEYLESS-START
 - ● Antitheft alarm system with remote panic feature

CLA 250 Coupe
AMG CLA 45 Coupe

Comfort and convenience

- ● Power driver seat with 3-position memory
 - ● Power front passenger seat with 3-position memory
 - ● Sport front seats with adjustable cushion length and racing-inspired integrated head restraints
 - ● 60/40-split folding rear seats¹⁴
 - ● Folding rear center armrest with pass-through
-
- ● Tilt/telescoping steering column
 - ● Multifunction steering wheel with leather trim
 - ● Flat-bottom sport steering wheel
-
- ● Dual-zone digital automatic climate control
 - ● Front and rear cupholders
 - ● Amber ambient cabin lighting
-
- ● Rain-sensing windshield wipers
 - ● Heated power side mirrors

Entertainment and navigation

- ● 7" high-resolution central screen
 - ● Central controller
 - ● High-resolution color multifunction display in instrument cluster
-
- ● Bluetooth® audio streaming
 - ● Hands-free Bluetooth interface
 - ● USB audio port and Media Interface
 - ● In-dash CD player with MP3 capability and SD card reader
 - ● HD Radio™ receiver
 - ● Rewiring for accessory Garmin® MAP PILOT® navigation system
-
- ● Mercedes-Benz mbrace®
 - ● 5 years of mbrace Connect services¹²

● Standard ○ Optional — Not available

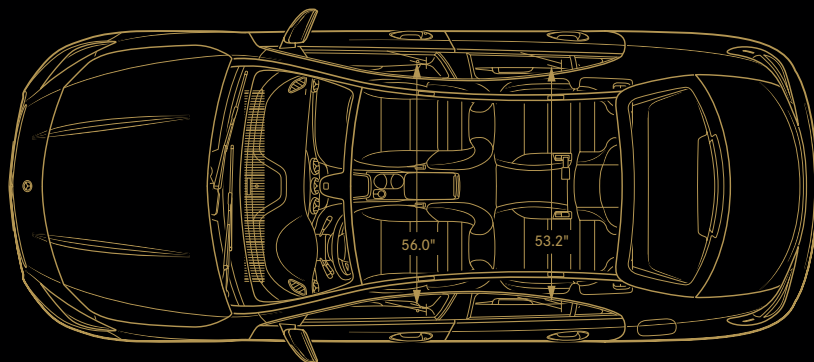
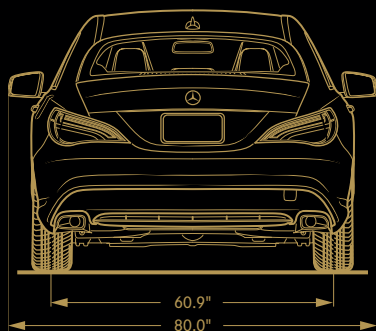



CLA 250

امداد خودرو فارما

تلفن: ۰۲۱ ۸۸۶۲۱۵

FarmaSUS.com



CLA 250 Coupe
AMG CLA 45 Coupe

Option Packages

Premium Package	○ ○
<ul style="list-style-type: none"> • Heated front seats • KEYLESS-GO® • harman/kardon LOGIC7® surround sound system • SiriusXM Radio with 6-month All Access trial¹¹ • Auto-dimming driver-side and inside rearview mirrors • Compass display in inside mirror, garage door opener 	

Multimedia Package <i>Requires Premium Package</i>	○ ○
<ul style="list-style-type: none"> • 8" high-resolution central screen • Rearview camera¹⁷ • COMAND® hard-drive navigation¹³ • No-charge navigation map updates for 3 years • 5 years of SiriusXM Traffic and Weather service¹¹ • Smartphone Integration¹⁸ with Apple CarPlay™ • In-dash DVD/CD player, Dolby® Digital 5.1 sound • Voice control with learning feature for audio, phone and navigation 	

Interior Package <i>Requires Premium Package</i>	○ ○
<ul style="list-style-type: none"> • Leather upholstery, topstitched MB-Tex upper dash and door trim • Multicolor LED ambient lighting (12 colors and 5 dimming levels) 	

Sport Package <i>N/A with Sport Package Plus</i>	○ -
<ul style="list-style-type: none"> • Sport body styling • Chrome diamond-block grille • 18" AMG® multispoke wheels (Silver)¹ 	

Night Package <i>Requires Sport Package</i>	○ -
<ul style="list-style-type: none"> • Gloss Black exterior accents • 18" AMG multispoke wheels (Black)¹ 	

Sport Package Plus <i>N/A with Night Package or Sport Package</i>	○ -
<ul style="list-style-type: none"> • Sport Plus body styling with red accent stripes in bumpers • Chrome diamond-block grille • 18" AMG triple-spoke wheels with wider high-performance tires¹ • Perforated front brakes with red-painted calipers • Performance suspension, steering, transmission Sport mode, and exhaust • Black MB-Tex/DINAMICA upholstery with red topstitching • Topstitched MB-Tex upper dash and door trim, red seat belts • Flat-bottom sport steering wheel • Aluminum dash trim, brushed aluminum pedals 	

AMG DYNAMIC PLUS Package	- ○
<ul style="list-style-type: none"> • AMG Adaptive Suspension with Comfort and Sport modes • AMG limited-slip front differential • RACE mode, Race Start function and raised top speed⁵ 	

AMG Performance Studio Package	- ○
<p><i>N/A with AMG Exterior Carbon Fiber Package or Night Package</i></p> <ul style="list-style-type: none"> • Gloss Black front air-dam splitter, side mirror caps, side-window trim, side-sill inserts, rear spoiler and rear diffuser • Orange accents on grille, wheels, side mirrors and rear diffuser • Matte black lower body striping • 19" AMG multispoke wheels¹ (Black/Orange) • AMG Performance front seats by Recaro® • Black MB-Tex/DINAMICA upholstery with Orange/White stripes and orange topstitching • MB-Tex upper dash and door trim with orange topstitching • AMG Performance steering wheel (Black/Orange) • AMG Performance dash trim with exclusive graphic and orange trim 	

● Standard ○ Optional - Not available

CLA 250 Coupe
AMG CLA 45 Coupe

Option Packages *continued*

AMG Exterior Carbon Fiber Package	- ○
<p><i>N/A with AMG Night Package or Performance Studio Package</i></p> <ul style="list-style-type: none"> • Carbon fiber front air-dam splitter, side mirror caps, side-sill inserts and rear diffuser 	

AMG Night Package	- ○
<p><i>N/A with AMG Exterior Carbon Fiber Package or Performance Studio Package</i></p> <ul style="list-style-type: none"> • Gloss Black exterior accents • Black chrome tailpipes 	

Driver Assistance Package	○ ○
<ul style="list-style-type: none"> • DISTRONIC PLUS® adaptive cruise control¹⁰ • Blind Spot Assist® • Lane Keeping Assist⁷ 	

Individual options

4MATIC® all-wheel drive <i>AMG Performance 4MATIC on AMG CLA 45</i>	○ ●
Sport-tuned suspension	○ ●
Adjustable suspension with Comfort and Sport modes	○ -
AMG Adaptive Suspension with Comfort and Sport modes	- ○
AMG Performance exhaust	- ○
Red-painted brake calipers <i>N/A with AMG Performance Studio Package</i>	- ○

Blind Spot Assist <i>Also in Driver Assistance Package</i>	○ ○
PARKTRONIC with Active Parking Assist	○ ○
KEYLESS-GO <i>Also in Premium Package</i>	○ ○
Rearview camera ¹⁷ <i>Also in Multimedia Package</i>	○ ○

Panorama roof <i>تلفن شبانه ۰۲۱-۸۸۶۲۰۸۸</i>	○ ○
Front fender badge and/or decklid badge deletion	- ○
AMG carbon fiber rear spoiler, or rear spoiler plus side mirror caps	- ○

Heated front seats <i>Also in Premium Package</i>	○ ○
Power front passenger seat with 3-position memory	○ ●
AMG Performance front seats <i>Also in AMG Performance Studio Package</i>	- ○
AMG Performance steering wheel <i>Also in AMG Performance Studio Package</i>	- ○

harman/kardon LOGIC7 sound system <i>Also in Premium Package</i>	○ ○
Smartphone Integration ¹⁸ with Apple CarPlay <i>Also in Multimedia Package</i>	○ ○
Multicolor LED ambient lighting (12 colors and 5 dimming levels)	○ ○
AMG illuminated front door sills	- ○

Aluminum dash trim <i>Also in Sport Package Plus</i>	○ ●
Burl Walnut or Black Ash wood dash trim	○ ○
Carbon fiber dash trim	- ○

18" twin 5-spoke wheels ¹ <i>N/A with Sport Package or Sport Package Plus</i>	○ -
19" AMG 16-spoke wheels ¹ (Silver or Black) <i>N/A with AMG Performance Studio Package</i>	- ○

AMG wheel center caps with concealed lugs <i>Requires 18" wheels</i>	- ○
--	-----

Metallic or <i>designo</i> paintwork	○ ○
--------------------------------------	-----

Accessories *Selected items shown at left*

18" twin 5-spoke wheels ¹ (Black/Polished)	○ -
Wheel center caps <i>Various styles available</i>	○ ○

Illuminated Star <i>N/A with Driver Assistance Package</i>	○ ○
Rear spoiler	○ ○
Front spoiler <i>N/A with Sport Package or Sport Package Plus</i>	○ ●

Garmin® MAP PILOT® SD card-based integrated navigation system ¹³	○ ○
<i>N/A with Multimedia Package</i>	

COLOR AND TRIM

UPHOLSTERY STYLES



Sport seats in MB-Tex

- CLA 250



Sport seats in leather

- CLA 250 *Interior Package (shown)*
- AMG CLA 45 *Interior Package*



Sport seats in MB-Tex with DINAMICA inserts

- CLA 250 *Sport Package Plus (shown)*
- AMG CLA 45



AMG Performance seats

- AMG CLA 45 *Available in MB-Tex/DINAMICA (shown) or leather*
Also included in AMG Performance Studio Package

FarmaSOS.com

UPHOLSTERY COLORS

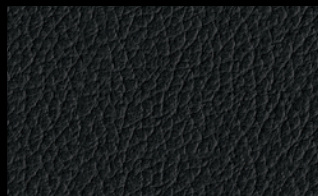

Black
MB-Tex or leather



Ash
MB-Tex or leather

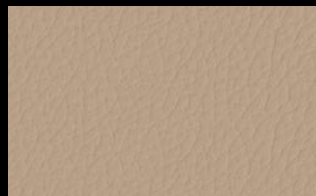

Beige
MB-Tex



Brown
Leather



Black
MB-Tex/DINAMICA
Includes red stitching and seat belts

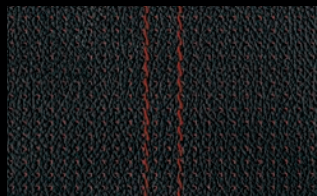

Black "Red Cut"
Leather
Includes red stitching and seat belts

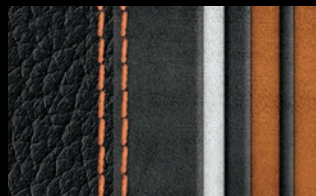

Black with Orange/White stripes
MB-Tex/DINAMICA
Included in AMG Performance Studio Package

INTERIOR TRIM

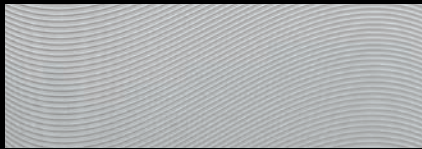

Anthracite
● CLA 250



Aluminum
● AMG CLA 45 ○ CLA 250

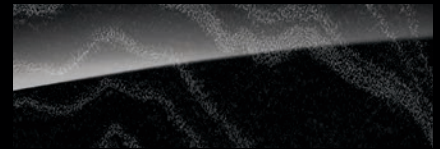

Black Ash wood
○ CLA 250, AMG CLA 45

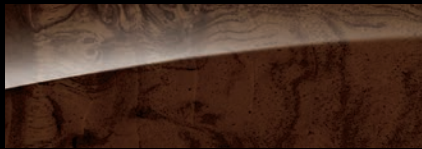

Burl Walnut wood
○ CLA 250, AMG CLA 45

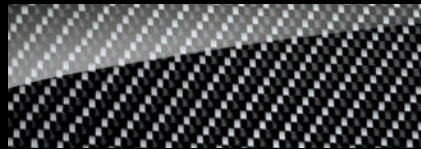

Carbon fiber
○ AMG CLA 45



AMG Performance graphic
○ AMG CLA 45 AMG Performance Studio Package

امداد خودرو فارما

PAINTWORK

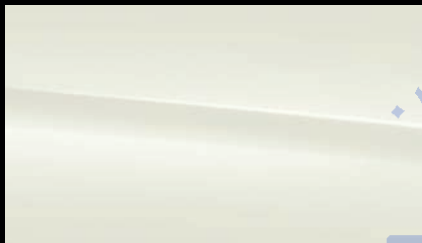

Cirrus White



Jupiter Red



Night Black



Cocoa Brown metallic



Cosmos Black metallic

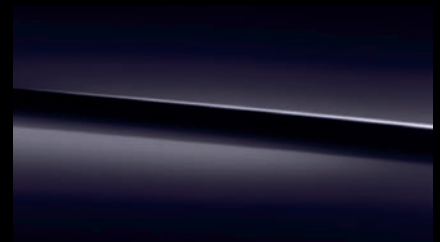

Northern Lights Violet metallic



Polar Silver metallic

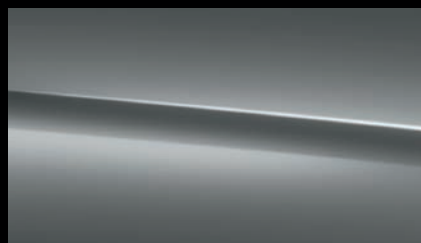

Mountain Grey metallic



designo Magno Polar Silver (matte finish)

FarmaSOS.com

تلفن شماره روزی: ۰۲۱-۸۸۸۶۲۰۸۵

WHEEL CHOICES

● Standard ○ Optional



17" 5-spoke
● CLA 250



18" twin 5-spoke
○ CLA 250



18" AMG® multispoke (Silver)
○ CLA 250 Sport Package



18" AMG multispoke (Black)
○ CLA 250 Night Package



18" AMG triple-spoke (Black)
○ CLA 250 Sport Package Plus



18" AMG twin 5-spoke
● AMG CLA 45



18" 16-spoke (Silver)
○ AMG CLA 45



18" 16-spoke (Black)
○ AMG CLA 45



18" multispoke (Black/Orange)
○ AMG CLA 45 Performance Studio Package

©2015 Mercedes-Benz USA, LLC • 303 Perimeter Center North, Atlanta, GA 30346 • 1-800-FOR-MERCEDES • MBUSA.com

Marketing Communications. All illustrations and specifications contained in this brochure are based on the latest product information available at the time of publication. Mercedes-Benz reserves the right to make changes at any time, without notice, to colors, materials, equipment, specifications and models. Any variations in colors shown are due to reproduction variations of the printing process. Illustrations may include test situations. Some vehicles may be shown with non-U.S. equipment. Some vehicles are shown with optional equipment. Apple CarPlay, iPad, iPhone and iPod are trademarks, registered trademarks or service marks of Apple Inc. Bluetooth is a registered trademark of Bluetooth SIG, Inc. Garmin is a registered trademark of Garmin Ltd Corp, George Town, Cayman Islands. Android and Google Maps are registered trademarks of Google Inc. harman/kardon and LOGIC7 are registered trademarks of Harman International Industries, Inc. HD Radio is a proprietary trademark of iBiquity Digital Corporation. Recaro is a registered trademark of Keiper Recaro GmbH, Remscheid, Germany. Sirius, XM and all related marks and logos are trademarks of Sirius XM Radio Inc. Tuneln is a registered service mark of Tuneln, Inc. Twitter is a registered trademark of Twitter, Inc. Yelp is a registered trademark of Yelp Inc.

ENDNOTES

- Lower aspect ratio tires and accompanying wheels provide substantially increased treadwear, increased tire noise and reduced ride comfort. Serious wheel and tire damage may occur if the vehicle is operated on rough or damaged road surfaces or upon encountering road debris or obstacles. These tires are not designed for use on snow and ice. Winter tires mounted on appropriately sized and approved wheels are recommended for driving in those conditions. CLA models are not provided with a spare tire. Models with high-performance tires are provided with TIREFIT sealant and a portable air pump.
- Comparative claim based on 2016 EPA estimated fuel economy for CLA250 and key market competitors with standard 4-cylinder engine and automatic transmission. Figures for CLA are preliminary estimates. Please see your dealer for final figures. Compare the estimated mpg to the estimated mpg of other vehicles. You may get different mileage depending on how fast you drive, weather conditions and trip length. Your actual highway mileage will probably be less than the highway estimate.
- Stated rates of acceleration are estimated based upon manufacturer's track results and may vary depending on model, environmental and road surface conditions, driving style, elevation and vehicle load.
- No system, regardless of how advanced, can overcome the laws of physics or correct careless driving. Please always wear your seat belt. Performance is limited by available traction, which snow, ice and other conditions can affect. Always drive carefully, consistent with conditions. Best performance in snow is obtained with winter tires.
- Always obey local speed and traffic laws.
- COLLISION PREVENTION ASSIST PLUS may not be sufficient to avoid an accident. It does not react to certain stationary objects, nor recognize or predict the curvature and/or lane layout of the road or every movement of vehicles ahead. It is the driver's responsibility at all times to be attentive to traffic and road conditions, and to provide the steering, braking and other driving inputs necessary to retain control of the vehicle. Drivers are cautioned not to wait for the system's alerts before braking, as that may not afford sufficient time and distance to brake safely. Autonomous braking is available at speeds between approximately 5 and 65 mph for moving vehicles, or 5 and 31 mph for stationary objects.
- Driving while drowsy or distracted is dangerous and must be avoided. ATTENTION ASSIST[®] and/or Lane Keeping Assist may be insufficient to alert a fatigued or distracted driver of lane drift and cannot be relied on to avoid an accident or serious injury. Lane Keeping Assist operates at speeds above approximately 37 mph.
- Blind Spot Assist may not be sufficient to avoid all accidents involving vehicles in your blind spot and does not estimate the speed of approaching vehicles. It must not be used as a sole substitute for driver awareness and checking of surrounding traffic conditions. Blind Spot Assist operates at speeds above approximately 20 mph.
- Braking effectiveness also depends on proper brake maintenance, and tire and road conditions.
- DISTRONIC PLUS[®] adaptive cruise control is no substitute for active driving involvement. It does not adapt cruising speed in response to stationary objects, nor does it predict the curvature and lane layout of the road ahead or the movement of vehicles ahead. It is the driver's responsibility at all times to be attentive to traffic and road conditions, and to provide the steering, braking and other driving inputs necessary to retain control of the vehicle. Drivers are cautioned not to wait for the DISTRONIC Proximity Warning System before braking, as that may not afford sufficient time and distance to brake safely.
- The purchase or lease of a new, satellite radio-enabled vehicle includes a 6-month introductory subscription to the Sirius All Access package, as well as a 5-year introductory subscription to SiriusXM Traffic and SiriusXM Weather when equipped with the Multimedia Package. SiriusXM Traffic and Weather services are available for select markets. SiriusXM Satellite Radio, SiriusXM Traffic and SiriusXM Weather subscriptions are sold separately or as a package after trial period. If you decide to continue your subscription after your trial, the plan you choose will automatically renew and you will be charged according to your chosen payment method at then-current rates. Fees and taxes apply. To cancel you must call SiriusXM at 1-866-635-2349. See SiriusXM Customer Agreement for complete terms at siriusxm.com. All fees and programming subject to change.
- All Mercedes-Benz mbrace[®] services operate only where cellular and Global Positioning System satellite signals are available, which are provided by third parties and not within the control of Mercedes-Benz USA, LLC. Five years of the mbrace Connect package are included with new-vehicle sales and leases at an authorized Mercedes-Benz dealer. Subscriber Agreement is required for service to be active. Some services are only available on select vehicles. Your PIN is required in order to use certain services. Some services may be limited or restricted in some areas. Apps may be introduced and updated at varying dates, and may also require a vehicle software update. Driver is responsible for complying with traffic and other laws. See your dealer or MBUSA.com/mbrace for details, including a list of compatible smartphones. Streaming Internet-based features require Multimedia Package plus an active subscription to the mbrace Entertain Package. Connection may be limited by cellular signal.
- While the navigation system provides directional assistance, the driver must remain focused on safe driving behavior, including paying attention to traffic and street signs. The driver should utilize the system's audio cues while driving and should only consult the map or visual displays once the vehicle has been stopped in a safe place. Maps do not cover all areas or all routes within an area.
- Unsecured cargo can become hazardous in a collision. Always secure cargo using the floor-mounted tie-downs.
- The mbrace Mobile App is compatible with Apple iPhone[®] models running iOS 7.0 or later, and Android-based phones running OS 2.3 or later. Please visit MBUSA.com/mbrace for more information.
- Roadside Assistance repairs may involve charges for parts, service and towing. Vehicle must be accessible from main roads. Depending on the circumstance, these services may be provided by an outside provider, courtesy of Mercedes-Benz Roadside Assistance. Restricted roadways, acts of nature and vehicle accessibility may limit our ability to provide services to you. For full details, eligibility requirements, and limitations/exclusions of Sign and Drive services, as well as the Roadside Assistance Program, please see your dealer.
- Rearview camera does not audibly notify driver of nearby objects and is not a substitute for actively checking around the vehicle for any obstacles or people. Images displayed may be limited by camera field of view, weather, lighting conditions and the presence of dirt, ice or snow on the cameras.
- Introduction dates vary. Please see your dealer. Apple CarPlay[™] requires a compatible iPhone[®] plugged into vehicle's USB port. Connection to apps and streaming services may be limited by cellular signal. Data usage will be routed through connected iPhone and is subject to fees, charges and restrictions in user's wireless plan. Visit MBUSA.com for more information.



The personal rewards of striving to be the best are even more meaningful in the development of young people than they are for automobiles. Instilling the values of leadership, goal-setting, discipline and teamwork in youth is an investment in everyone's future. It's why Mercedes-Benz USA is collaborating with the Laureus Sport for Good Foundation, with an ongoing commitment to train and place hundreds of coaches for after-school and in-school sports programs in communities around the country. Sports offer kids more than the chance to be physically active and have fun. It's also an opportunity to have a mentor who can guide them, help them learn how to deal with major life issues, and help them grow stronger not just physically but in their character. As a Mercedes-Benz driver, you become a part of this effort to give hundreds of thousands of kids a better life today, and all of us a brighter tomorrow.

Learn more about how Mercedes-Benz USA believes in giving back at MBUSA.com/community