

امداد خودرو فارما

تلفن شبانه روزی: ۰۲۱-۸۸۸۶۲۰۸۵

FarmasOS.com



2016



تلفن شماره بیزی: ۰۲۱ ۸۸۸۶۲۰۸۵

Farmasys.com

SL



Mercedes-Benz

FIRST LOVE FOREVER

*FEW CARS INSPIRE LOVE AT FIRST SIGHT LIKE A ROADSTER.
NO ROADSTER MAKES THE PASSION ENDURE LIKE AN SL.*



امداد خودرو فارما

تلفن: ۰۲۱-۸۸۶۲۰۰۰

FarmaSOS.com

ENDLESS DEVOTION TO INSTANT DESIRE

Remember when you saw your first SL? Maybe you admired it in a photograph in a magazine, or glimmering on the auto show carpet. Perhaps you witnessed it capturing a checkered flag in Italy, or caught a glimpse as your neighbor whisked off to work. Wherever it was, it didn't just stay in your mind. It got into your heart that someday it would be you behind the wheel—the sound of each rev carried off by the wind. The feel of each corner hugging you back. And the idea that, just out of view, someone is catching a glimpse of you driving your SL—and thinking “someday that will be me.”



امداد خودرو فارما

تلفن شبانه روزی: ۰۲۱-۸۸۰۰۰۰۰۰

FarmaSS.com

FUTURE HERITAGE

*THE SL HAS A HISTORY OF MAKING HISTORY, PRECISELY
BECAUSE IT'S ALWAYS FOCUSED ON WHAT COMES NEXT.*

امداد خودرو فارما

تلفن شبانه روزی: ۰۲۱-۸۸۸۶۲۰۸۵

FarmaSOS.com



IN THE MOMENT, AHEAD OF ITS TIME

What makes every SL an icon comes from the fact that it's always reached for the stars rather than resting on its laurels. The legacy evident in its design is always one of leaping ahead. Its body is made from aluminum—much like the original SL—for exceptional strength with light weight. The all-year, all-day, all-night enjoyment of its convertible top has been advanced by every SL generation. Today's fully automatic power hardtop, Panorama glass roof and MAGIC SKY CONTROL® electrically variable tint are all SL firsts. Its ongoing legacy of innovation is why driving one never gets old.

امداد خودرو فارما

تلفن شبانه روزی: ۰۲۱-۸۸۸۶۲۰۸۵

FarmaSOS.com



ALL FOR THE TWO OF YOU

THE ESSENCE OF A SPORTS CAR IS FOUND IN
ITS PERFECT PAIRINGS: A COCKPIT TAILORED
FOR TWO, THE SKY ABOVE AND ROAD BELOW,
AND THE BOND BETWEEN YOU AND YOUR SL.



فارسوس

تلفن شبانه روزی: ۰۲۱-۸۸۸۶۲۰۸۵

FarmaSOS.com



STAR TREATMENT

The perfect roadster experience is more than a drive—it's a romance with the road. And while some sun-worshipping is sure to be enjoyed, the SL shares its virtues at other times as well. The twin power seats can offer cooling ventilation in summer, and soothing heat in winter. On those in-between evenings, AIRSCARF® can envelop your neck and shoulders in warm air—a virtual scarf that extends the top-down driving season. Even with the power hardtop up, the standard Panorama roof's tinted skylight lets you bask in sunshine, ride in shade, or drive with the stars.

SOLAR FLAIR

Precisely tailored leather, fitted by hand to each seat, is a treasured SL tradition. The seamless integration of advanced technology is another. Case in point: An advanced treatment of the SL's leather—even the extra-smooth and supple Nappa leather—helps it reflect sunlight. Not only do the seats stay appreciably cooler on summer days, it also enhances their enduring beauty. The contrasting-color topstitching that details each seat continues to the dash and console. You can also opt for exquisitely crafted, hand-selected *designo* Nappa leather in eight dramatic color schemes. Cabin accents include your choice of three hand-finished woods, sleek aluminum, or genuine carbon fiber. And beneath the surface, steam-expanded foams—a process pioneered by Mercedes-Benz—eliminate harmful chemicals, while products from flax, coconut and olives support the seats and many trim components. The SL puts you at one with the outside world.



ایران خودرو فارما

تلفن: ۰۲۱-۸۸۸۶۲۰۸۵

FarmaSOS.com

UNBRIDLED PRECISION

WITH TWIN TURBOS AND A WIND-SLICING BODY, YOU CAN ALWAYS FEEL THE RUSH OF THE AIR IN AN SL. EVEN WHEN THE TOP IS UP.



FarmaSOS.com

TAKING THE REINS IS A TOTAL RELEASE

The true test of a roadster is not a breezy cruise in the countryside. It's a tight corner on a racetrack. A sudden twist in an unfamiliar road. The need to merge this instant. Or to stop even sooner. An SL turns extreme pressure into composed confidence. Any of four biturbo engines—V-6, two V-8s, or a V-12—will rapidly demonstrate that. So will either of two suspensions: One can adapt in 10 milliseconds. The other is fully active. With every torque vectoring, paddle-shifting, adaptive braking move, you'll feel it: An SL is a rush. And a breeze.

HANDCRAFTED BY RACERS

MERCEDES-AMG IS NO MERE SPONSOR OF RACING. AMG IS PEOPLE WHO DEVELOP, BUILD AND RACE RACECARS. AND THEY WIN. THEN THEY DEVELOP AND CRAFT HIGH-PERFORMANCE STREET CARS. AND YOU WIN.

ایراد خودرو فارس

تلفن شبانه روزی: ۰۲۱-۶۶۱۱۱۱۱۱

FaynaSOS.com



“One man, one engine” is more than a motto for AMG. It’s a guiding philosophy and a process rooted in racing, where precision and endurance are proven in record time. The heart of a Mercedes-AMG SL 63 or SL 65 is its biturbo engine. Each one is crafted by the hands of its own master engine builder, who visually inspects and records every component, and computer-verifies each torque spec. Only after the engine is individually bench-tested does it earn his signature—on a metal plaque that he affixes atop its cover. This degree of detail-obsession is evident throughout the car—from its mighty brake hardware to its range of driver-selected modes to its finely stitched, hand-fitted Nappa leather upholstery.

The AMG SL 63’s biturbo V-8 outpours 577 hp and 664 lb-ft of torque. With a 7-speed multiclutch AMG SPEEDSHIFT® transmission and staggered-width 19" AMG® wheels,¹ it can catapult you to 60 mph in 4.1 seconds.² In the AMG SL 65, a biturbo V-12 generates a dominating 621 hp, 738 lb-ft of torque, and 0–60 in 3.9 seconds. Along with a 7-speed AMG SPEEDSHIFT® PLUS transmission, its AMG wheels and tires are staggered in both width and diameter: 19" front/20" rear. In either model, AMG-calibrated Active Body Control (ABC®) teams up with a limited-slip differential, multistage ESP® and Torque Vectoring Brake, all to deliver the agility that AMG drivers have cherished—on road and track—for decades.



AMG
DRIVING PERFORMANCE

DEFENDING CHAMPION

ON THE RACETRACK OR THE ROAD, SAFETY IS AN INTEGRAL PART OF PERFORMANCE. THE SL HAS LONG SET THE PACE FOR SPORTS-CAR SAFETY. ITS POP-UP ROLL BARS ARE A BENCHMARK OF OPEN-ROADSTER OCCUPANT PROTECTION. ITS PIONEERING ADAPTIVE BRAKING TECHNOLOGY SET AN INDUSTRY STANDARD – NOT JUST FOR SPORTS CARS, BUT FOR ALL CARS. WHEN IT COMES TO DEFENDING YOUR SAFETY, IT'S FAST AND STEADY THAT WINS THE RACE.

تلفن شبانه روزی: ۰۲۱-۸۸۸۶۲۰۸۵

FarmaSOS.com

NIGHT VIEW ASSIST PLUS

When you're driving in darkness, available Night View Assist® PLUS projects invisible infrared beams and reads them with a special camera. A supplement to what the standard active Bi-Xenon headlamps reveal through the windshield, the system can display a clearer, additional real-time view of the road ahead on the central in-dash screen. Its advanced technology can also help it identify pedestrians and animals along a dark roadway, and point them out on-screen.³

ATTENTION ASSIST

By continuously monitoring as many as 70 parameters of driving behavior, ATTENTION ASSIST® can alert you both visually and audibly if it detects signs of driver-drowsiness on long trips. Its enhanced sensitivity helps the system detect drivers who begin their trip drowsy. A display in the gauge cluster can help you track your own attention level and driving time along your journey.⁴

ACTIVE LANE KEEPING ASSIST

By monitoring visible road markings at speeds above 37 mph, Active Lane Keeping Assist helps detect unintended drifting off-course, and alerts you by vibrating the steering wheel. If you continue to drift, it can selectively brake individual wheels to help guide the car back into its lane. It can also help detect and alert you to overtaking vehicles, vehicles you'll need to overtake if you change lanes, and even oncoming traffic in the adjacent lane.⁴

ACTIVE BLIND SPOT ASSIST

When driving above 20 mph, radar technology helps sense when a vehicle enters the blind-spot area on either side of you, and alerts you by illuminating an icon in the side mirror. A warning tone sounds if you activate a turn signal while a vehicle is detected. And if you begin to change lanes, advanced active technology can help guide the car back by applying the brakes on one side.⁵



امداد خودرو فارما

تلفن شبانه روزی: ۰۲۱-۸۸۸۶۲۰۸۵

FarmaSOS.com

DISTRONIC PLUS WITH PRE-SAFE BRAKE

Radar-based cruise control adapts your set speed to the flow of traffic ahead, automatically slowing until your path is clear again. If the vehicle ahead slows to a stop, DISTRONIC PLUS[®] can brake to a full halt. When traffic starts to go, you can resume with just a tap.⁶ And whether you're using the cruise control or not, PRE-SAFE[®] Brake can help detect an impending collision and automatically apply up to 100% braking force to help reduce the severity of impact.⁷

POP-UP ROLL BARS

In 1989, the Mercedes-Benz SL introduced the industry's first pop-up roll bar, a significant advancement in convertible safety that continues to enhance protection today. If sensors in the SL detect that a rollover is about to occur, a pair of high-strength roll bars deploy from beneath the rear cabin trim in less than a third of a second, to help preserve and protect the occupant space.⁸

PARKTRONIC WITH ACTIVE PARKING ASSIST

As you drive by parallel parking spaces, sensors help you size them up. When you decide to back into one, Active Parking Assist can park your SL virtually hands-free—expertly steering the car while you operate the pedals. In any low-speed maneuver, PARKTRONIC uses ultrasonic sensors in the bumpers to help detect nearby objects within the system's field of view. Audible and visual indicators in the SL's cabin help you negotiate tight spaces with confidence.

NECK-PRO ACTIVE HEAD RESTRAINTS

In the event of a rear impact exceeding a preset threshold, NECK-PRO[®] active head restraints instantly move forward and slightly upward, to help reduce the distance between each head restraint and the seated occupant's head. This action helps to reduce the likelihood or severity of whiplash-type neck injuries.

INSIGHTFUL OUTLOOK

THE MOST REWARDING VIEW FROM AN SL IS CONTAINED WITHIN ITS COCKPIT.



تلفن شماره روزی: ۰۲۱-۸۸۸۶۲۰۸۵

FarmaSOS.com

NO DETAIL OVERLOOKED, NOR OVERDONE

Even amid the most picturesque landscape, the scenery you'll likely enjoy most in your SL is literally inside your SL. Its driving controls are elegantly rendered in satin aluminum and hand-stitched leather. Circular air vents would look perfectly at home in a private jet. The central display stays vivid, even in sunshine. And the SL pays equal attention to how you feel, seamlessly adjusting its climate control to sunlight, humidity, and even if the power top and windows are open.



امداد خودرو فارما

تلفن شبانه روزی: ۰۲۱-۸۸۸۶۲۰۸۵

FarmaSOS.com

ACCELERATING PROGRESS

No other roadster wraps cutting-edge innovation in time-honored craftsmanship like the SL has for generations. Its power hardtop flips and folds into the trunk in seconds, leaving room for two golf bags. Its elegant electronic shifter and classic dashtop analog clock let you keep time with the SL's performance. With in-car Internet and Cloud-based apps,⁹ the SL's user-friendly technologies keep you feeling fully connected.

Its innovative entertainment systems let you freely escape. Choose from two surround sound systems—from industry leader harman/kardon[®] or audiophile favorite Bang & Olufsen.[®] Both team up with the clever FrontBass[®] system, in which the front body structure doubles as bass enclosures. And with SPLITVIEW, your passenger can watch a DVD movie¹⁰ on the in-dash color display while you continue to see its navigation or audio screens from behind the wheel.



*AN SL HAS ALWAYS BEEN MORE THAN A WORK OF ART.
IT'S CONTINUALLY REDEFINED THE STATE OF THE ART.*

ADVANCED BY TRADITION



TOGETHER WHEREVER

IT'S PERFECTLY NATURAL TO DEVELOP AN EMOTIONAL ATTACHMENT TO YOUR MERCEDES-BENZ. WITH MBRACE, ENJOYING A TECHNOLOGICAL CONNECTION IS JUST AS EASY.

With Mercedes-Benz mbrace[®], your car is only a click away. Five years of mbrace Connect benefits and services⁹ come standard with every new 2016 Mercedes-Benz, providing you with remote access to your vehicle from your smartphone or computer. With the mbrace Mobile App,¹¹ you can lock, unlock and locate your car—and more—from your phone. You can access Google and Yelp from your car with an ever-evolving variety of in-vehicle apps. You can send destinations to your car's standard COMAND[®] navigation system from your computer or phone. Even your car can reach out, with remote diagnostics and a direct connection to Mercedes-Benz Roadside Assistance.¹² Three additional packages bring you even more connections—from added safety to a personal concierge to streaming music from all around the globe. With mbrace, your Mercedes-Benz helps you stay connected not just to your car, but to your world—from anywhere you are, and wherever tomorrow takes you.

mbrace Connect

5 years included

State-of-the-art convenience with remote vehicle access, in-vehicle apps and over-the-air updates

Package includes:

- mbrace Mobile App for Android or iPhone
- Remote lock/unlock and other vehicle features via Mobile App
- Access to mbrace Web services at mbrace.MBUSA.com
- Remote diagnostics with direct dealer connection
- Over-the-air updates of many mbrace features and apps
- An evolving selection of Mercedes-Benz Apps, such as:
 - Google[™] Local Search
 - Yelp
 - Fuel station finder with prices
 - Weather reports locally and around the world
 - Airport flight status
 - Local movie theater showtimes
- Valet Protect
- Viewable traffic cams in many metro markets

mbrace Secure

6-month trial included
Requires mbrace Connect

Added peace of mind from safety and security features for you, your family, and your vehicle

Package includes:

- Automatic Collision Notification
- Emergency calling from your car's SOS button or the Mobile App
- Automatic Alarm Notification
- Stolen vehicle location assistance
- Agent-assisted remote locking and unlocking
- Dealer connect

mbrace Concierge

3-month trial included
Requires mbrace Secure

Personal assistance from highly knowledgeable professionals with access to a world of resources

Package includes:

- Personal concierges to help you stay more productive on the road, or from the Mobile App on your smartphone
- Expert recommendations and reservations for dining out, and for tickets to events
- Turn-by-turn directions from a live assistant or sent to your car
- Travel assistance, including reservations and changes for hotels, airlines and car rentals
- Answers to most any question, help with most any request

mbrace Entertain

3-month trial included
Requires mbrace Secure

Online, on-the-road enjoyment from streaming entertainment to online maps

Package includes:

- Streaming audio and data via widely available 3G coverage
- Online maps, powered by Google
- A selection of streaming audio apps, including:
 - TuneIn[®] radio
 - iHeart Radio[®] Available starting Fall 2015
 - Mercedes-Benz Radio



فارس خودرو فارما

تلفن شماره ۰۲۱-۸۸۸۶۲۰۸۵

FarmasOS.com



CAR IN YOUR POCKET

The mbrace Mobile App on your iPhone or Android phone includes a number of remote vehicle controls among its many useful features. You can lock and unlock the doors from any distance. Locate your car on a map. Or flash its lights and sound the horn. You can even look up an address, and send it directly to your car's COMAND navigation system.

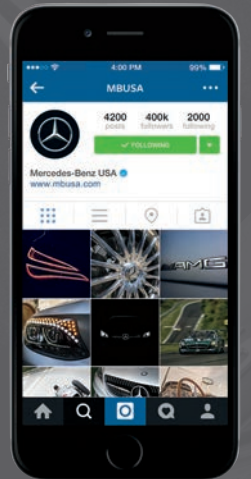

OUR WORLD IS YOURS

The online world of Mercedes-Benz is one of many ways you can enjoy being part of the family. You can keep up to date with news and events, or take in an entertaining film. You can get more from your vehicle with helpful tutorial videos and downloadable manuals. And you can check out photos from other Mercedes-Benz drivers and fans, and best of all, share yours as well.



BUILD YOUR OWN

MBUSA.com/SL

Specifications	SL 400	SL 550	AMG SL 63	AMG SL 65	
Engine	Type	3.0-liter biturbo Direct Injection V-6	4.7-liter biturbo Direct Injection V-8	Handcrafted AMG 5.5-liter biturbo Direct Injection V-8	Handcrafted AMG 6.0-liter biturbo V-12
	Power	329 hp @ 5,250-6,000 rpm	449 hp @ 5,250 rpm	577 hp @ 5,500 rpm	621 hp @ 4,800-5,400 rpm
	Torque	354 lb-ft @ 1,600-4,000 rpm	516 lb-ft @ 1,800-3,500 rpm	644 lb-ft @ 2,250-3,450 rpm	738 lb-ft @ 2,300-4,300 rpm
Transmission	7-speed automatic with shift paddles	7-speed automatic with shift paddles	7-speed AMG SPEEDSHIFT® MCT with shift paddles	7-speed AMG SPEEDSHIFT PLUS with shift paddles	
Acceleration, 0-60 mph²	5.1 sec	4.5 sec	4.1 sec	3.9 sec	
Wheels	Staggered-width 18" twin 5-spoke with Extended Mobility tires ¹	Staggered-width 18" twin 5-spoke with Extended Mobility tires ¹	Staggered-width 19" AMG® twin 5-spoke ¹	Staggered-width 19" front/20" rear AMG® forged 10-spoke ¹	
Suspension	4-wheel multilink with Adaptive Damping and Direct-steer	4-wheel multilink with Adaptive Damping and Direct-steer	4-wheel multilink with AMG-calibrated Active Body Control (ABC®)	4-wheel multilink with AMG-calibrated Active Body Control (ABC®)	
Drivetrain	Rear-wheel drive	Rear-wheel drive	Rear-wheel drive	Rear-wheel drive	

امداد خودرو فارما

Dimensions	SL 400	SL 550	AMG SL 63	AMG SL 65
Wheelbase	101.8"	101.8"	101.8"	101.8"
Overall length	181.6"	181.6"	182.4"	182.4"
Overall height	51.8" (w/top up)	51.8" (w/top up)	51.2" (w/top up)	51.2" (w/top up)
Overall width	82.6" (w/mirrors)	82.6" (w/mirrors)	82.6" (w/mirrors)	82.6" (w/mirrors)
Curb weight	3,836 lbs	4,001 lbs	4,118 lbs	4,211 lbs
Headroom	39.1"	39.1"	39.1"	39.1"
Legroom	42.8"	42.8"	42.8"	42.8"
Shoulder room	55.5"	55.5"	55.5"	55.5"
Cargo capacity	13.5 cu ft (top up) 8.5 cu ft (top down)	13.5 cu ft (top up) 8.5 cu ft (top down)	13.5 cu ft (top up) 8.5 cu ft (top down)	13.5 cu ft (top up) 8.5 cu ft (top down)

تلفن شعبه فروش: ۰۲۱-۸۸۸۶۲۰۸۵

FarmasOS.com

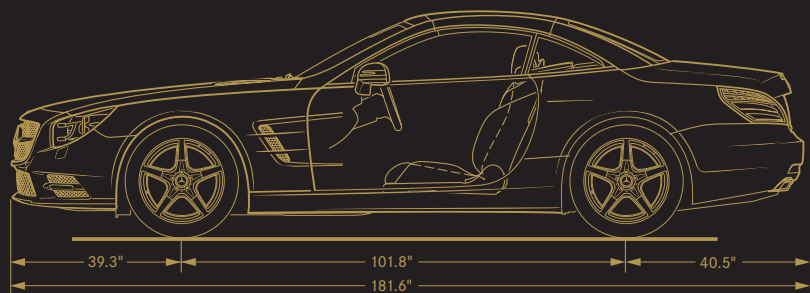
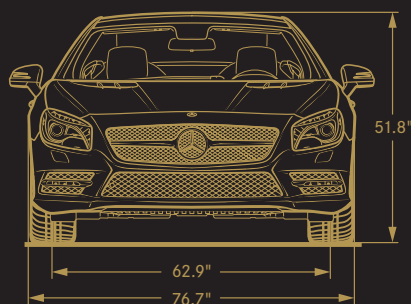

KEY STANDARD FEATURES

SL 400
SL 550
AMG SL 63
AMG SL 65

Performance and efficiency

- ● ● ● ECO Start/Stop system
- ● ● ● Manual shift mode for transmission
- — ● ● AMG limited-slip differential

Safety and security

- ● ● ● High-strength aluminum body structure
- ● ● ● ATTENTION ASSIST®
- ● ● ● PRE-SAFE®
- ○ ○ ● Night View Assist® PLUS
- ● ● ● Electronic Stability Program (ESP®)
- ● ● ● Adaptive braking technology: Predictive Brake Priming, Automatic Brake Drying, Hill-Start Assist, and Brake HOLD feature
- ● ● ● Emergency-sensing Brake Assist (BAS®)
- ● ● ● Advanced Tire Pressure Monitoring System
- ● ● ● 8-way air bag protection
- ● ● ● NECK-PRO® head restraints
- ● ● ● Dual automatic pop-up roll bars®
- ● ● ● LED Daytime Running Lamps
- ● ● ● LED taillamps
- ● ● ● Bi-Xenon headlamps with Active Curve Illumination
- ● ● ● Adaptive Highbeam Assist
- ● ● ● Corner-illuminating front lamps
- ● ● ● MAGIC VISION CONTROL® heated wiper/washer system
- ● ● ● Rearview camera¹³
- ● ● ● PARKTRONIC w/Active Parking Assist
- ● ● ● SmartKey remote locking and starting system
- ● ● ● KEYLESS-GO®
- ● ● ● Antitheft alarm system with remote panic feature

SL 400
SL 550
AMG SL 63
AMG SL 65

Comfort and convenience

- ● ● ● Heated 14-way power seats with memory
- ● ● ● Ventilated front seats
- ● ● ● Active multicontour seats with massage feature
- ● ● ● AIRSCARF® neck-level heating system
- ● ● ● Power tilt/telescoping steering column
- ● ● ● Multifunction steering wheel w/Nappa leather trim
- ● ● ● Power retractable hardtop
- ● ● ● Panorama roof w/sliding interior sunshade
- ○ ○ ● MAGIC SKY CONTROL® electrically variable tinted roof panel
- ● ● ● Dual-zone digital automatic climate control
- ● ● ● Power windblocker
- ○ ○ ● Soft-close doors
- ● ● ● Easy-pack system w/power tilt-up of stowed hardtop
- ● ● ● Electronic trunk closer w/HANDS-FREE ACCESS
- ● ● ● Rain-sensing windshield wipers
- ● ● ● Heated power side mirrors w/power fold-in
- ● ● ● Auto-dimming driver-side and inside rearview mirrors

Entertainment and navigation

- ● ● ● COMAND® system with central controller
- ● ● ● COMAND navigation w/80GB hard drive
- ● ● ● SiriusXM Traffic and Weather w/5 years of service¹⁴
- ● ● ● Voice control w/learning feature
- ● ● ● No-charge navigation map updates for 3 years
- ● ● ● harman/kardon LOGIC7® sound system
- ○ ○ ● Bang & Olufsen® BeoSound™ premium sound system
- ● ● ● Bluetooth® audio streaming, hands-free Bluetooth interface
- ● ● ● USB audio port, in-dash DVD/CD player and SD card reader
- ● ● ● SiriusXM Radio w/6-month All Access trial¹⁴
- ● ● ● HD Radio™ receiver
- ● ● ● Mercedes-Benz mbrace®
- ● ● ● 5 years of mbrace Connect services⁹

● Standard ○ Optional — Not available

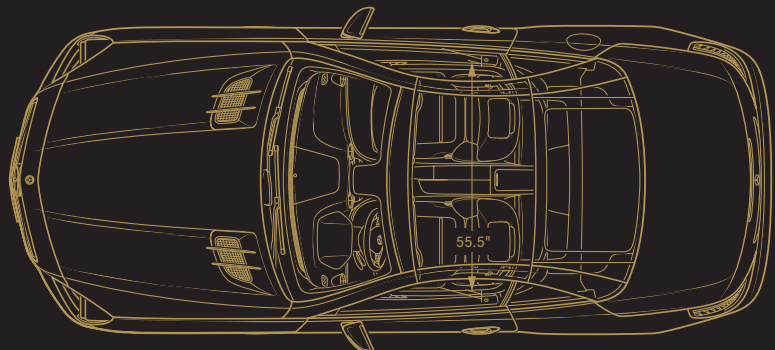
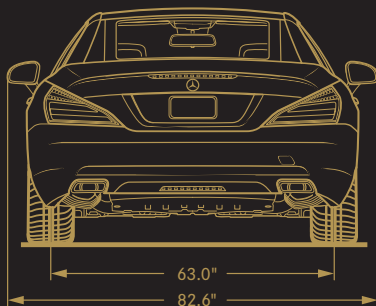



فارس خودرو فارما

تلفن شبکه روزانه ۰۲۱-۸۸۸۸۰۰۰۰

FarmaSOS.com

Option Packages

	SL 400	SL 550	AMG SL 63	AMG SL 65
Premium Package	○	●	●	●
<ul style="list-style-type: none"> Rearview camera¹³ PARKTRONIC with Active Parking Assist Ventilated seats Active multicontour seats with massage feature AIRSCARF® neck-level heating system KEYLESS-GO® with HANDS-FREE ACCESS Electronic trunk closer 				
Sport Wheel Package	○	○	-	-
<ul style="list-style-type: none"> 19" AMG® 5-spoke wheels¹ Painted front brake calipers with Mercedes-Benz lettering Perforated rear brake discs Sport steering wheel with perforated leather side grips and silver shift paddles 				
AMG Exterior Carbon Fiber Package	-	-	○	○
<i>Not available with AMG High-contrast Styling Package</i>				
<ul style="list-style-type: none"> Carbon fiber front air-dam cross-strut, rear valence and rear diffuser Carbon fiber side mirror covers Carbon fiber side sill inserts 				
AMG High-contrast Styling Package¹⁵	-	-	○	○
<i>Not available with AMG Exterior Carbon Fiber Package</i>				
<ul style="list-style-type: none"> Gloss Black hardtop, rear spoiler, side mirror covers, and exterior and interior details Black chrome AMG tailpipes Exclusive 19" front/20" rear AMG 10-spoke forged-alloy wheels¹ with black inlays Black diamond-stitched Nappa leather upholstery with <i>designo</i> Platinum White elements AMG Performance steering wheel in Black DINAMICA/Platinum White Nappa leather <i>designo</i> Black Piano Lacquer wood trim, or optional carbon fiber trim AMG floor mats with white borders 				
Driver Assistance Package <i>Requires Premium Package</i>	○	○	○	●
<ul style="list-style-type: none"> DISTRONIC PLUS® with PRE-SAFE® Brake⁶ Active Blind Spot Assist⁵ Active Lane Keeping Assist⁴ 				

Individual options

	SL 400	SL 550	AMG SL 63	AMG SL 65
Active Body Control (ABC®)	○	○	●	●
AMG Carbon Ceramic Braking System ¹⁶	-	-	○	○
Red-painted brake calipers	-	-	○	○
Panorama roof with MAGIC SKY CONTROL®	○	○	○	●
Soft-close doors	○	○	○	○
Bang & Olufsen® BeoSound™ Premium Sound System	○	○	○	●
SPLITVIEW® front-seat entertainment system ¹⁰	○	○	○	○
Night View Assist PLUS ³	○	○	○	●
AMG Performance Media	-	-	○	○
19" twin 5-spoke wheels ¹	○	○	-	-
19" multispoke wheels ¹	○	○	-	-
19" front/20" rear AMG forged 10-spoke wheels ¹ (Silver)	-	-	○	●
19" front/20" rear AMG forged 10-spoke wheels ¹ (Black)	-	-	○	○
Wood/leather steering wheel	○	○	○	○
AMG Performance steering wheel with DINAMICA side grips	-	-	○	△
Illuminated door sills	○	○	●	●
Nappa leather upholstery	○	○	●	-
Exclusive Nappa leather upholstery	-	-	-	●
<i>designo</i> Exclusive Nappa leather interior treatment	○	○	○	○
Black Ash, Burl Walnut or Satin Brown Poplar wood trim	△	△	△	△
Aluminum trim	△	△	△	△
Carbon fiber trim	○	○	●	●
<i>designo</i> Black Piano Lacquer wood trim	○	○	○	○
<i>designo</i> Champagne White Piano Lacquer wood trim	○	○	○	○
<i>designo</i> Natural Bamboo trim	○	○	○	○
Accessories <i>Selected items shown at left</i>				
18" 5-spoke wheels ¹	○	○	-	-
19" multispoke wheels ¹	○	○	-	-
Wheel hub inserts <i>Various styles available</i>	○	○	○	○
Car cover in Noah® fabric <i>Lock and cable available separately</i>	○	○	○	○
UVS-100™ sunshade	○	○	○	○
Exterior and interior car care kits	○	○	○	○
All-season floor mats	○	○	○	○
Cargo area tray	○	○	○	○

● Standard ○ Optional △ No-charge option - Not available

COLOR AND TRIM

UPHOLSTERY STYLES



Leather
● SL 400, SL 550



Nappa leather
○ SL 400, SL 550



AMG Nappa leather
● AMG SL 63



AMG Exclusive Nappa leather
● AMG SL 65

UPHOLSTERY COLORS

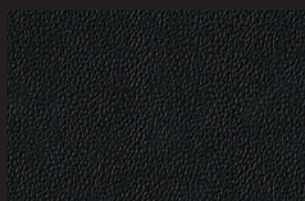

Black
All upholstery styles



Bengal Red/Black
All upholstery styles



Crystal Grey/Dark Grey
SL 400/SL 550 standard leather



Ginger Beige/Esspresso Brown
All upholstery styles



Nut Brown/Black
SL 400/SL 550 Nappa leather

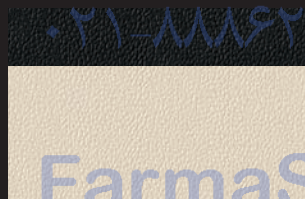

Porcelain/Black
All Nappa leather upholstery styles

designo UPHOLSTERY COLORS



designo Tuscany Beige Pearl
Exclusive Nappa leather¹⁷

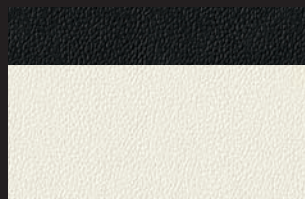

designo Deep White
Exclusive Nappa leather¹⁷



designo Light Brown
Exclusive Nappa leather¹⁷

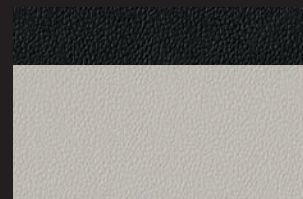

designo Platinum White
Exclusive Nappa leather¹⁷



designo Sand
Exclusive Nappa leather¹⁷



designo Sienna Brown
Exclusive Nappa leather¹⁷



designo Classic Red
Exclusive Nappa leather¹⁷



designo Titanium Grey Pearl
Exclusive Nappa leather¹⁷

INTERIOR TRIM



Aluminum

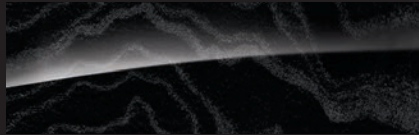

Black Ash wood



Satin Brown Poplar wood



Burl Walnut wood



Carbon fiber

PAINTWORK



Black

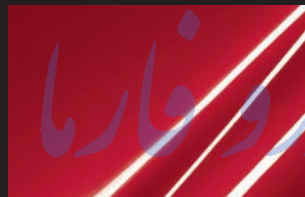

Mars Red

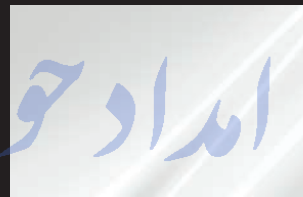

Polar White

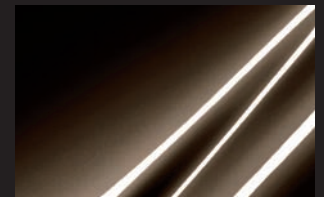

Dolomite Brown metallic



Lunar Blue metallic



Iridium Silver metallic



Magnetite Black metallic



Obsidian Black metallic



Selenite Grey metallic¹⁸



Shadow Grey (matte)¹⁹

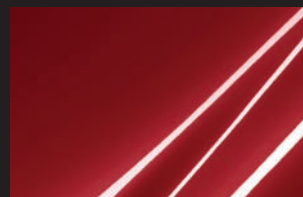

designo Cardinal Red metallic¹⁹



designo Diamond White metallic¹⁹

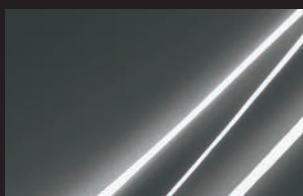

designo Graphite metallic¹⁷

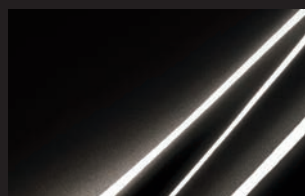

designo Mocha Black metallic¹⁷



designo Magno Alanite Grey (matte)¹⁷



designo Magno Cashmere White (matte)¹⁷

WHEEL CHOICES



18" twin 5-spoke¹
● SL 400, SL 550



19" twin 5-spoke¹
○ SL 400, SL 550



19" multispoke¹
○ SL 400, SL 550



19" AMG[®] 5-spoke¹
○ SL 400, SL 550 Sport Wheel Package



19" AMG twin 5-spoke¹
● AMG SL 63



19" front/20" rear AMG forged 10-spoke, Silver¹
● AMG SL 65 ○ AMG SL 63



19" front/20" rear AMG forged 10-spoke, Black¹
○ AMG SL 63, AMG SL 65



19" front/20" rear AMG forged 10-spoke¹
○ AMG High-contrast styling Package

©2015 Mercedes-Benz USA, LLC • One Mercedes Drive, Montvale, NJ 07645 • 1-800-FOR-MERCEDES • MBUSA.com

Marketing Communications. All illustrations and specifications contained in this brochure are based on the latest product information available at the time of publication. Mercedes-Benz reserves the right to make changes at any time, without notice, to colors, materials, equipment, specifications and models. Any variations in colors shown are due to reproduction variations of the printing process. Illustrations may include test situations. Some vehicles may be shown with non-U.S. equipment. Some vehicles are shown with optional equipment. iPad, iPhone and iPod are registered trademarks or service marks of Apple Inc. Bang & Olufsen and BeoSound are registered trademarks of Bang & Olufsen a/s. Bluetooth is a registered trademark of Bluetooth SIG, Inc. Android and Google Maps are registered trademarks of Google Inc. harman/kardon and LOGIC7 are registered trademarks of Harman International Industries, Inc. HD Radio is a proprietary trademark of iBiquity Digital Corporation. Sirius, XM and all related marks and logos are trademarks of Sirius XM Radio Inc. Tuneln is a registered service mark of Tuneln, Inc. Twitter is a registered trademark of Twitter, Inc. Yelp is a registered trademark of Yelp Inc.

ENDNOTES

- 1 Lower aspect ratio tires and accompanying wheels provide substantially increased treadwear, increased tire noise and reduced ride comfort. Serious wheel and tire damage may occur if the vehicle is operated on rough or damaged road surfaces or upon encountering road debris or obstacles. These tires are not designed for use on snow and ice. Winter tires mounted on appropriately sized and approved wheels are recommended for driving in those conditions. Models equipped with Extended Mobility tires are not provided with a spare tire. AMG models are provided with TIREFIT sealant and a portable air pump.
- 2 Stated rates of acceleration are estimated based upon manufacturer's track results and may vary depending on model, environmental and road surface conditions, driving style, elevation and vehicle load.
- 3 Night View Assist® PLUS does not replace the use of headlamps and must not be used as the primary visual source for the driver.
- 4 Driving while drowsy or distracted is dangerous and must be avoided. ATTENTION ASSIST® and/or Lane Keeping Assist may be insufficient to alert a fatigued or distracted driver of lane drift and cannot be relied on to avoid an accident or serious injury. Lane Keeping Assist operates at speeds above approximately 37 mph.
- 5 Blind Spot Assist may not be sufficient to avoid all accidents involving vehicles in your blind spot and does not estimate the speed of approaching vehicles. It must not be used as a sole substitute for driver awareness and checking of surrounding traffic conditions. Blind Spot Assist operates at speeds above approximately 20 mph.
- 6 DISTRONIC PLUS® adaptive cruise control is no substitute for active driving involvement. It does not adapt cruising speed in response to stationary objects, nor does it predict the curvature and lane layout of the road ahead or the movement of vehicles ahead. It is the driver's responsibility at all times to be attentive to traffic and road conditions, and to provide the steering, braking and other driving inputs necessary to retain control of the vehicle. Drivers are cautioned not to wait for the DISTRONIC Proximity Warning System before braking, as that may not afford sufficient time and distance to brake safely.
- 7 Braking effectiveness also depends on proper brake maintenance, and tire and road conditions.
- 8 The roll bar system is designed to enhance the level of rollover protection compared to a vehicle without one. No system, regardless of how advanced, can eliminate the chance of injury in an accident. Please always wear your seat belt.
- 9 All Mercedes-Benz mbrace® services operate only where cellular and Global Positioning System satellite signals are available, which are provided by third parties and not within the control of Mercedes-Benz USA, LLC. Five years of the mbrace Connect package are included, starting on the original retail sale or lease date from an authorized Mercedes-Benz dealer. Subscriber Agreement is required for service to be active. Some services are only available on select vehicles. Your PIN is required in order to use certain services. Some services may be limited or restricted in some areas. Apps may be introduced, updated or removed at varying dates, and may also require a vehicle software update. Driver is responsible for complying with traffic and other laws. See your dealer or MBUSA.com/mbrace for details, including a list of compatible smartphones. Streaming Internet-based features require an active subscription to the mbrace Entertain Package. Connection may be limited by cellular signal.
- 10 System availability and use are not yet approved in some states. See your dealer for the latest information, and check local laws regarding the use of front-seat video displays in your area. Driver can also view the entertainment features while the gear selector is in Park.
- 11 The mbrace Mobile App is compatible with Apple iPhone® models running iOS 7.0 or later, and Android-based phones running OS 2.3 or later. Please visit MBUSA.com/mbrace for more information.
- 12 Roadside Assistance repairs may involve charges for parts, service and towing. Vehicle must be accessible from main roads. Depending on the circumstance, these services may be provided by an outside provider, courtesy of Mercedes-Benz Roadside Assistance. Restricted roadways, acts of nature and vehicle accessibility may limit our ability to provide services to you. For full details, eligibility requirements, and limitations/exclusions of Sign and Drive services, as well as the Roadside Assistance Program, please see your dealer.
- 13 Rearview camera does not audibly notify driver of nearby objects and is not a substitute for actively checking around the vehicle for any obstacles or people. Images displayed may be limited by camera field of view, weather, lighting conditions and the presence of dirt, ice or snow on the cameras.
- 14 The purchase or lease of a new, satellite radio-enabled vehicle includes a 6-month introductory subscription to the Sirius All Access package, as well as a 5-year introductory subscription to SiriusXM Traffic and SiriusXM Weather. SiriusXM Traffic and Weather services are available for select markets. SiriusXM Satellite Radio, SiriusXM Traffic and SiriusXM Weather subscriptions are sold separately or as a package after trial period. If you decide to continue your subscription after your trial, the plan you choose will automatically renew and you will be charged according to your chosen payment method at then-current rates. Fees and taxes apply. To cancel you must call SiriusXM at 1-866-635-2349. See SiriusXM Customer Agreement for complete terms at siriusxm.com. All fees and programming subject to change.
- 15 AMG High-contrast Styling Package is available with Black, Magnetite Black (with matching roof), Obsidian Black (with matching roof), Selenite Grey, Shadow Grey, Iridium Silver, *designo* Diamond White, or *designo* Magno Cashmere White paint. Roof is painted Black with all colors except when noted as matching. Package is not available in combination with other color and trim choices, wheel options, or AMG Exterior Carbon Fiber Package.
- 16 The carbon-ceramic brakes are designed expressly for high-performance braking. It is a characteristic of their materials and design that brake noise/squeal may result, along with differing brake pedal feel at lower brake temperatures compared to higher operating temperatures.
- 17 Extra-cost option. Some *designo* paint and leather options may require additional production time. Please see your dealer.
- 18 Introduction dates vary. Please see your dealer.
- 19 Extra-cost option.



The personal rewards of striving to be the best are even more meaningful in the development of young people than they are for automobiles. Instilling the values of leadership, goal-setting, discipline and teamwork in youth is an investment in everyone's future. It's why Mercedes-Benz USA is collaborating with the Laureus Sport for Good Foundation, with an ongoing commitment to train and place hundreds of coaches for after-school and in-school sports programs in communities around the country. Sports offer kids more than the chance to be physically active and have fun. It's also an opportunity to have a mentor who can guide them, help them learn how to deal with major life issues, and help them grow stronger not just physically but in their character. As a Mercedes-Benz driver, you become a part of this effort to give hundreds of thousands of kids a better life today, and all of us a brighter tomorrow.

Learn more about how Mercedes-Benz USA believes in giving back at MBUSA.com/community