



تلفن شبانه روزی: ۰۲۱-۸۸۸۶۲۰۸۵

FarmaSOS.com

Mercedes-Benz

C-Class

Operator's Manual

Symbols

Trademarks:

- BabySmart™ is a trademark of Siemens Automotive Corp.
- Bluetooth® is a registered trademark of Bluetooth SIG Inc.
- ESP® is a registered trademark of Daimler.
- HomeLink® is a registered trademark of Prince, a Johnson Controls Company.
- Logic 7® is a registered trademark of Harman International Industries, Incorporated.
- Microsoft® is a registered trademark of Microsoft Corporation in the U.S.A. and other countries.
- SIRIUS and related marks are trademarks of SIRIUS XM Radio Inc.
- Windows media® is a registered trademark of Microsoft Corporation in the U.S.A. and other countries.

The following symbols are found in this Operator's Manual:

Warning!

Warning notices draw your attention to hazards that may endanger your health or life, or the health or life of others.

 Highlights hazards that may result in damage to your vehicle.

 Helpful hints or further information you may find useful.

▶ This symbol points to instructions for you to follow.

▶ A number of these symbols appearing in succession indicates a multiple-step procedure.

▷ page This symbol tells you where to look for further information on a topic.

▷▷ This continuation symbol marks a warning or procedure which is continued on the next page.

Display Text in displays, such as the control system, are printed in the type shown here.

امداد خودرو فارما

تلفن شبانه روزی: ۰۸۵ ۸۶۲ ۰۸۵

FarmaSOS.com

Our company and staff congratulate you on the purchase of your new Mercedes-Benz.

Your selection of our product is a demonstration of your trust in our company name. Furthermore, it exemplifies your desire to own an automobile that will be as easy as possible to operate and will provide years of service.

Your Mercedes-Benz represents the efforts of many skilled engineers and craftsmen. To help assure your driving pleasure, and also the safety of you and your passengers, we ask you to make a small investment of time:

- Please read this manual carefully, then return it to your vehicle where it will be handy for your reference.
- Please follow the recommendations contained in this manual. They are designed to acquaint you with the operation of your Mercedes-Benz.
- Please pay attention to the warnings and cautions contained in this manual. They are designed to help improve the safety of the vehicle operator and occupants.

We extend our best wishes for many miles of safe, pleasurable driving.

Mercedes-Benz USA, LLC

A Daimler Company

امداد خودرو فارما

تلفن شبانه روزی: ۰۲۱-۸۸۶۲۰۸۵

FarmaSOS.com

امداد خودرو فارما

تلفن شبانه روزی: ۰۲۱-۸۸۸۶۲۰۸۵

FarmaSOS.com

Index	4	At a glance	25
Introduction	20	Safety and security	35
		Controls in detail	69
		Operation	221
		Practical hints	267
		Technical data	331

امداد خودرو فارما

تلفن شبانه روزی: ۰۲۱-۸۸۸۶۲۰۸۵

FarmaSOS.com

1, 2, 3 ...

4-ETS

see ETS/4-ETS

4MATIC

see All-wheel drive (4MATIC)

9 1 1 Emergency calls 173**A****ABS (Antilock Brake System)** 61

Indicator lamp 298

Messages in the multifunction
display 280, 281**Accessory weight** 250**Accidents** 105

Air bags 37

Emergency calls (Tele Aid) 212

Emergency calls (Telephone) 173

NECK-PRO active front head
restraints 52**Active Bi-Xenon headlamps**

see Headlamps

Adaptive Brake 62**Additives**

Engine oil 353

Gasoline 355

Address change 21**Advanced Tire Pressure****Monitoring System (Advanced****TPMS)** 234Messages in the multifunction
display 277**Air bags** 37

Emergency call upon deployment .. 212

Front, driver and passenger 40

Front passenger front air bag off
indicator lamp (Canada

only) 46, 307

Front passenger front air bag off
indicator lamp (USA only) 42, 308

Knee bag 40

Messages in the multifunction
display 272OCS (Occupant Classification
System) 42

Pelvis 41

Safety guidelines 39

Side impact 41

Window curtain 42

**Air conditioning refrigerant and
lubricant** 354**Air distribution** 194**Air pressure**

see Tire inflation pressure

Air pressure (tires) 250**Air recirculation mode** 195**Air volume** 194**Alarm system**

see Anti-theft systems

All-wheel drive (4MATIC) 183**Alternator**

Messages in the multifunction

display 290

Alternator (Technical data)

see Vehicle specification

AMG menu 123**Anticorrosion/antifreeze** 357**Antilock Brake System**

see ABS

Anti-theft systems 66

Anti-theft alarm system 67

Immobilizer 66

Aquaplaning

see Hydroplaning

Armrest, front

Storage compartments 206

Armrest, rear

Storage compartment 206

Ashtrays 209**Aspect ratio (tires)** 250**Audio menu** 126**Audio system** 136

Adjusting volume 144

Audio and telephone operation 136

Audio AUX mode 166

Bluetooth® settings 147

CD mode 158

Components 137

MP3 mode 158

Operating safety 137

Radio operation 148

Satellite radio 152

Switching on and off 144

- System settings 147
 Telephone 167
- Auto-dimming rear view mirrors** 87
- Automatic central locking** 74, 135
- Automatic headlamp mode** 91
- Automatic interior lighting control** 95
- Automatic locking when driving** 135
- Automatic shift program** 111
- Automatic transmission** 108
- Automatic shift program 111
- Gear range indicator 111
- Gear ranges 111
- Gear selector lever 108
- Hill-start assist system 183
- Kickdown 110
- Kickdown (manual shift program) .. 115
- Manual shift program 113
- One-touch gearshifting 112
- Program mode indicator 112
- Program mode selector switch
 (automatic shift program) 111
- Program mode selector switch
 (manual shift program) 113, 114
- Shifting procedure 109
- Steering wheel gearshift control 112
- Transmission position indicator 109
- Transmission positions 109
- AUX socket** 166
- Axle oils** 351
- B**
- BabySmart™**
- Air bag deactivation system 46
- Self-test 47
- Back button** 141
- Backrest**
- see Seats
- Backup lamps**
- Messages in the multifunction
 display 292
- Replacing bulbs 314
- Bar (air pressure unit)** 250
- BAS (Brake Assist System)** 61
- Batteries, SmartKey**
- Checking condition 73
- Replacing 312
- Battery, Vehicle** 321
- Charging 323
- Jump starting 323
- Messages in the multifunction
 display 290
- Bead (tire)** 250
- Beverage holders**
- see Cup holders
- Bluetooth® settings** 147
- Brake Assist System**
- see BAS
- Brake fluid**
- Checking level 228
- Messages in the multifunction
 display 282
- Brake lamps**
- ♦ Cleaning lenses 263
- Replacing bulbs 314
- Brake pads**
- Messages in the multifunction
 display 279
- Brakes** 255
- High-performance brake system 256
- Parking brake 105
- Warning lamp 298
- Break-in period** 222
- Bulbs**
- see Replacing bulbs
- C**
- CAC (Customer Assistance Center)** ... 23
- California retail buyers and lessees, important notice for** 21
- Calls (phone)** 128, 167
- Can holders**
- see Cup holders
- Capacities and recommended fuel/lubricants** 349
- Cargo tie-down rings** 203
- Carpets, cleaning** 265
- CD player** 158
- Center console**
- Lower part 32
- Upper part 31
- Central locking**
- Automatic 74, 135
- KEYLESS-GO 71

- Locking/unlocking from inside 75
 SmartKey 70
Central locking/unlocking switch 75
Certification label 332
Children in the vehicle
 Air bags 37
 BabySmart™ air bag deactivation
 system 46
 Child safety locks (rear doors) 59
 Child seat anchors – LATCH-type
 (ISOFIX) 58
 Indicator lamp, front passenger
 front air bag off (Canada only) 46
 Indicator lamp, front passenger
 front air bag off (USA only) 42
 Infant and child restraint systems 55
 ISOFIX (Child seat anchors –
 LATCH-type) 58
 OCS (Occupant Classification
 System) 42
 Override switch 59
 Safety notes 54
 Tether anchorage points 57
 Top tether 57
Child safety
 see Children in the vehicle
**Child seat anchors – LATCH-type
 (ISOFIX)**
 see Children in the vehicle
**Chrome-plated exhaust tip,
 cleaning** 266
Cigarette lighter 209
Clear button 142
Climate control system
 Air conditioning 191
 Air conditioning refrigerant 354
 Air distribution 194
 Air recirculation mode 195
 Air volume 194
 Automatic mode 192
 Deactivating system 191
 Front defroster 194
 Maximum cooling MAX COOL 195
 Temperature 192
Clock 29, 132
Cockpit 27
Cold tire inflation pressure 250
Collapsible wheel chock 269
COMAND system
 see separate COMAND system
 operating instructions
Combination gauge 28
Combination switch 93
Compass 210
Control system 118
 Multifunction display 120
 Multifunction steering wheel 118
 Resetting to factory settings 130
Control system menus 121
 AMG 123
 Audio 126
 Navi 126
 Service 129
 Settings 130
 Telephone 128
 Trip 121
Control system submenus
 Convenience 135
 Instrument cluster 131
 Lighting 133
 Time/Date 132
 Vehicle 135
Convenience submenu
 Easy-entry/exit feature 136
 Fold-in function for exterior rear
 view mirrors 136
Coolant
 Anticorrosion/antifreeze 357
 Capacities 351
 Checking level 227
 Messages in the multifunction
 display 288
 Temperature gauge 117
 Warning lamp 305
Coolant temperature gauge 28
**Corner-illuminating front fog
 lamps** 94
Cruise control 180
 Activating 181
 Canceling 181
 Changing the set speed 182
 Last stored speed 183
 Lever 181
 Messages in the multifunction
 display 275

Resume function	183
Setting current speed	181
Cup holders	207
Curb weight	250
Customer Assistance Center (CAC) ...	23
Customer Relations Department	23

D

Dashboard

see Instrument cluster

Data recording	23
Date, Setting	133
Daytime running lamp mode	91
Switching on or off	133

Deep water

see Standing water

Defogging (windshield)	195
-------------------------------------	-----

Defroster

Front (Climate control system)	194
Rear window	196

Delayed shut-off

Exterior lamps	134
Interior lighting	135

Department of Transportation

see DOT

Difficulties

While driving	104
With starting	102

Dimensions (vehicle)

see Vehicle specification

Direction of rotation (tires)	242
--	-----

Displays

Maintenance service indicator	259
Messages in the multifunction display	270
Multifunction display	120
Symbol messages	279
Text messages	272
Trip computer	121
Vehicle status message memory ...	129
Vehicle system settings	130

Door control panel	33
---------------------------------	----

Door handles	33
---------------------------	----

Doors

Child safety locks	59
Locking/unlocking (KEYLESS-GO) ...	71
Locking/unlocking (SmartKey)	70

Messages in the multifunction display	286
Opening from inside	74
Remote door lock (Tele Aid)	216
Remote door unlock (Tele Aid)	215
Unlocking (Mechanical key)	309

DOT (Department of Transportation)

Drinking and driving	254
-----------------------------------	-----

Driving

Abroad	257
Hydroplaning	257
Instructions	101, 254
In winter	253
Problems	104
Safety systems	60
Systems	180
Through standing water	257

Driving and parking

Safety notes	101
--------------------	-----

Driving off	103, 257
--------------------------	----------

Driving safety systems

ABS	61
Adaptive Brake	62
BAS	61
EBP	62
ESP®	62
ETS/4-ETS	63

Driving systems

All-wheel drive (4MATIC)	183
Cruise control	180
Dynamic handling package with sport driving mode	184
Hill-start assist system	183
Parktronic system	185
Rear view camera	188

Driving tips, automatic transmission

Dynamic handling package with sport driving mode	184
---	-----

E

E85 (ethanol fuel)	355
---------------------------------	-----

Easy-entry/exit feature	85, 136
--------------------------------------	---------

EBP (Electronic Brake Proportioning)	62
---	----

- Electrical system**
 Improper work on or modifications 22
 Power outlets 210
- Electrical system (Technical data)**
 see Vehicle specification
- Electronic Stability Program**
 see ESP®
- Electronic Traction System**
 see ETS/4-ETS
- Emergency, in case of**
 First aid kit 268
 Flat tire 317
 Hazard warning flasher 93
 Roadside Assistance 21, 214
 Towing the vehicle 325
- Emergency calls**
 Tele Aid 212
 Telephone 173
- Emergency operations**
 Remote door lock (Tele Aid) 216
 Remote door unlock (Tele Aid) 215
 Trunk lid, emergency release 76
- Emergency Tensioning Device**
 see ETD
- Emission control** 258
 Information label 333
 System warranties 20
- Engine**
 Break-in recommendations 222
 Cleaning 262
 Compartment 224
 Malfunction indicator lamp 305
 Messages in the multifunction display 288
 Number 333
 Starting 101
 Turning off 106
- Engine (Technical data)**
 see Vehicle specification
- Engine coolant**
 see Coolant
- Engine oil**
 Adding 226
 Additives 353
 Checking level 226
 Consumption 225
- Messages in the multifunction display 291
 Oil dipstick 226
 Recommended engine oils and oil filter 353
- ESP® (Electronic Stability Program)** 62
 ETS/4-ETS 63
 Messages in the multifunction display 280, 281, 283
 Warning lamp 302
- ETD (Emergency Tensioning Device)** 52
 Safety guidelines 39
- Ethanol fuel (E85)** 355
- ETS/4-ETS (Electronic Traction System)** 63
- Express operation**
 Panorama roof 200
 Power windows 98
 Tilt/sliding sunroof 196
- Exterior lamp switch** 90
- Exterior rear view mirrors** 86
 Fold-in function 88
 Parking position 87
 Power-folding 88
 Switching fold-in function on or off 136
- Exterior view of vehicle** 26

F

- Fastening the seat belts** 50
- First aid kit** 268
- Flat tire** 317
 Lowering the vehicle 321
 Mounting the spare wheel 318
 Preparing the vehicle 318
 Spare wheel 317, 349
- Flexible Fuel Vehicles** 355
- Floor mats** 220
- Fluids**
 Automatic transmission fluid 350
 Brake fluid 351
 Capacities 349
 Engine coolant 351
 Engine oil 350
 Manual transmission oil 350

Power steering fluid	351
Washer and headlamp cleaning system	352
Fog lamps	92
Messages in the multifunction display	292, 294
Fold-in function for exterior rear view mirrors	88
Four-wheel drive see All-wheel drive (4MATIC)	
Front air bags see Air bags	
Front axle oil	351
Front lamps see Headlamps	
Front passenger front air bag	40
Messages in the multifunction display	272
Front passenger front air bag off indicator lamp (Canada only)	46, 307
Front passenger front air bag off indicator lamp (USA only)	42, 308
Front seat head restraints see Head restraints	
Fuel	222
Additives	355
Capacity, fuel tank	352
Drive sensibly-safe fuel	254
Ethanol fuel (E85)	355
Fuel consumption (Flexible Fuel Vehicle)	355
Fuel consumption statistics	122
Fuel filler flap and cap	223
Fuel tank reserve warning lamp	304
Premium unleaded gasoline	354
Refueling	222
Requirements	354
Switching (Flexible Fuel Vehicle)	355
Fuel filler flap	223
Opening manually	310
Fuel gauge	28, 118
Fuels, coolants, lubricants etc.	349
Fuel tank Capacity	352
Fuel filler flap and cap	223
Refueling	222
Fuses	328

G

Garage door opener	32, 216
Gasoline see Fuel	
GAWR (Gross Axle Weight Rating) ...	251
Gear range	111
Indicator	111
Limiting	112
Shifting into optimal	113
Gear selector lever	108
Cleaning	265
Gearshift pattern	108
Lock	102, 108
Shifting procedure	109
Transmission position indicator	109
Transmission positions	109
Gearshift lever	107
Gearshift pattern	107

Generator

 see Alternator

Global locking/unlocking

 see Key, SmartKey

Glove box	205
------------------------	-----

Gross Axle Weight Rating

 see GAWR

Gross Vehicle Weight

 see GVW

Gross Vehicle Weight Rating

 see GVWR

GVW (Gross Vehicle Weight)	251
---	-----

GVWR (Gross Vehicle Weight Rating)	251
---	-----

H

Halogen headlamps

 see Headlamps

Hard plastic trim items, cleaning	265
---	-----

Hazard warning flasher	93
-------------------------------------	----

Headlamp cleaning system	93
---------------------------------------	----

Headlamps

 Active Bi-Xenon headlamps
 90 |

 Automatic headlamp mode
 91 |

 Bi-Xenon
 90, 314 |

 Cleaning lenses
 263 |

 Cleaning system
 93 |

 Daytime running lamp mode
 91 |

Delayed shut-off	134
Halogen	314
High-beam flasher	93
High-beam headlamps	93
Low-beam headlamps	91
Messages in the multifunction display	292
Replacing bulbs	313
Switch	90

Headliner and shelf below rear

window, cleaning and care of	265
---	-----

Head restraints

Adjustment	79, 82
Folding back	83
NECK-PRO active front head restraints	52
Rear seat head restraints	83

Height adjustment

Seat belt outlet	51
Seats	79

High-beam flasher	93
--------------------------------	----

High-beam headlamps	93, 314
----------------------------------	---------

High-performance brake system	256
--	-----

Hill-start assist system	183
---------------------------------------	-----

Hood	224
-------------------	-----

Messages in the multifunction display	286
---	-----

Horn	27
-------------------	----

Hydroplaning	257
---------------------------	-----

I

Identification labels	332
------------------------------------	-----

Identification number, vehicle

(VIN)	333
-------------	-----

Ignition	78, 102
-----------------------	---------

Immobilizer	66
--------------------------	----

Infant and child restraint systems

see Children in the vehicle

Inflation pressure

see Tires, Inflation pressure

Inside door handle	74
---------------------------------	----

Instrument cluster	28, 116
---------------------------------	---------

Illumination	117
Lamps	297
Multifunction display	120

Instrument lighting

see Instrument cluster, Illumination

Instrument panel

see Instrument cluster

Instruments and controls

see Cockpit

Interior lighting

Delayed shut-off	135
Emergency lighting	95
Front	95
Front reading lamps	95
Rear	95
Rear reading lamps	95

Interior rear view mirror	86
--	----

Auto-dimming rear view mirrors	87
--------------------------------------	----

Interior storage spaces

see Storage compartments

Intermittent wiping	96
----------------------------------	----

Rain sensor	96
-------------------	----

ISOFIX (Child seat anchors – LATCH-type)

see Children in the vehicle

J

Jack	269
-------------------	-----

Jump starting	323
----------------------------	-----

K

Key, Mechanical

Loss of	73
Replacing	74
Unlocking/locking manually	309
Valet locking	77

Key, SmartKey

Battery check lamp	73
Checking batteries	73
Factory setting	71, 73
Global locking (KEYLESS-GO)	73
Global locking (SmartKey)	71
Global unlocking (KEYLESS-GO)	73
Global unlocking (SmartKey)	71
Important notes on KEYLESS-GO	72
Locking/unlocking	70
Loss of	73

- Messages in the multifunction display 286
 - Opening, trunk 75
 - Opening and closing the power tilt/sliding sunroof or the panorama roof 99
 - Opening and closing the windows 99
 - Remote control 70
 - Replacing 74
 - Replacing batteries 312
 - Restoring to factory setting 71, 73
 - Selective setting 71, 73
 - Starter switch positions 77
 - KEYLESS-GO**
 - Starter switch positions 78
 - Kickdown** 110
 - Kickdown (manual shift program)** ... 115
 - Kilopascal (air pressure unit)** 251
 - Knee bag** 40
- L**
- Labels**
 - Certification 332
 - Emission control information 333
 - Tire and Loading Information placard 238
 - Tire inflation pressure 231
 - Lamps, exterior**
 - Exterior lamp switch 90
 - Front 314
 - Messages in the multifunction display 292
 - Rear 314
 - Switching on/off 90
 - Lamps, indicator and warning**
 - ABS 29, 298
 - Brakes 28, 298
 - Center console 31
 - Coolant 28, 305
 - Engine malfunction 28, 305
 - ESP® 28, 302
 - ESP® OFF 28, 303
 - Fog lamps 92
 - Front fog lamps 28
 - Front passenger front air bag off (Canada only) 46, 307
 - Front passenger front air bag off (USA only) 42, 308
 - Fuel tank reserve 28, 304
 - High-beam headlamps 28, 93
 - Instrument cluster 28, 297
 - Low-beam headlamps 28, 91
 - Low tire pressure/TPMS malfunction telltale 28, 306
 - Rear fog lamp 28
 - Seat belt telltale 29, 51, 301
 - SRS 28, 36, 302
 - Turn signals 28
 - LATCH-type child seat anchors (ISOFIX)**
 - see Children in the vehicle
 - License plate lamps**
 - Messages in the multifunction display 294
 - Light alloy wheels, cleaning** 265
 - Lighter**
 - see Cigarette lighter
 - Lighting** 90
 - Daytime running lamp mode 91
 - Exterior 90
 - Interior 95
 - Limp-home mode** 116
 - Load index (tires)** 246, 251
 - Loading**
 - see Vehicle loading
 - Locator lighting** 134
 - Locking the vehicle**
 - KEYLESS-GO 71
 - Manually 310
 - SmartKey 70
 - Loss of**
 - Key 73
 - Service and Warranty Information booklet 332
 - Low-beam headlamps** 91
 - Exterior lamp switch 90
 - Replacing bulbs 314
 - Switching on 91
 - Lubricants** 349
 - Lumbar support** 82

M	
Maintenance	21
Maintenance System	
Service indicator display	259
Service indicator message	259
Service term exceeded	259
Manual headlamp mode (Low-beam headlamps)	91
Manual shift program	113
Manual transmission	107
Gearshift lever	107
Hill-start assist system	183
Maximum engine speed	
see Vehicle specification	
Maximum loaded vehicle weight	251
Maximum load rating (tires)	251
Maximum permissible tire inflation pressure	251
Mechanical key	
see Key, Mechanical	
Media interface	205
Memory function	89
Menus	
see Control system menus	
Minispare wheel	
see Spare wheel	
Mirrors	86
Auto-dimming rear view mirrors	87
Exterior rear view mirror parking position	87
Exterior rear view mirrors	86
Interior rear view mirror	86
Memory function	89
Power-folding exterior rear view mirrors	88
Vanity mirror	208
MON (Motor Octane Number)	354
Motor Octane Number	
see MON	
MP3 mode	158
Multifunction display	120
Symbol messages	279
Text messages	272
Vehicle status messages	270
Multifunction display messages	
ABS	280, 281
Active headlamps	292
Advanced TPMS	277
Air bags	272
Alternator	290
Backrests	286
Battery	290
Brake fluid	282
Brake pads	279
Child seat	275
Coolant	288
Corner-illuminating front fog lamps	295
Cruise control	275
Doors	286
EBP	281
Engine oil	291
ESP®	280, 281, 283
Fog lamps	292, 294
Front passenger front air bag	272
Gas cap	291
High-beam lamps	293
Hood	286
License plate lamps	294
Light sensor	294
Low-beam lamps	294
Parking brake	281
Parking lamps	293
Power steering	288
Reserve fuel	291
Reverse lamp	292
Side marker lamps	293
SmartKey	286
SmartKey with KEYLESS-GO	286
SRS	284
Tail lamps	295
Tele Aid	284
Tire inflation pressure	276, 296
Tire pressure monitor	277
Tires	276, 296
Trunk	286
Turn signals	296
Multifunction steering wheel	
Adjustment	84
Buttons	118
Cleaning	265
Easy-entry/exit feature	85, 136
Gearshift control	112
Memory function	89
Overview	29

N

Navigation system	
see Separate operating instructions	
Navi menu	126
NECK-PRO active front head restraints	52
Resetting	311
Nets, parcel	203
Normal occupant weight	251
Number, vehicle identification (VIN)	333

O

Occupant Classification System	
see OCS (Occupant Classification System)	
Occupant distribution	251
Occupant safety	
Air bags	37
BabySmart™	46
Children and air bags	37
Children in the vehicle	54
Child seat anchors – LATCH-type (ISOFIX)	58
Fastening the seat belts	50
Front passenger front air bag off indicator lamp (Canada only)	46, 307
Front passenger front air bag off indicator lamp (USA only)	42, 308
Infant and child restraint systems	55
Introduction	36
ISOFIX (Child seat anchors – LATCH-type)	58
OCS (Occupant Classification System)	42
Seat belts	39, 48
OCS (Occupant Classification System)	42
Self-test	46
Odometer	121
Oil, oil level	
see Engine oil	
On-board computer	
see Control system	
One-touch gearshifting	112

Operating safety	22
Ornamental moldings, cleaning	263
Overhead control panel	32

P

Paintwork, cleaning	261
Paintwork code	333
Panic alarm	60
Panorama roof with power tilt/sliding panel	200
Cleaning	264
Operation	200
Roller sunblinds	199
Synchronizing	201
Parcel nets	203
Parking	105
Parktronic system	185
Parking brake	105
Messages in the multifunction display	281
Parking position	
Exterior rear view mirrors	87
Transmission position	109
Parktronic system	
Cleaning system sensors	263
Malfunction	187
Minimum distance	186
Sensor range	185
Switching on/off	187
System sensors	185
Warning indicators	186
Parts service	332
PASS AIR BAG OFF indicator lamp (Canada only)	
see Front passenger front air bag off indicator lamp (Canada only)	
PASS AIR BAG OFF indicator lamp (USA only)	
see Front passenger front air bag off indicator lamp (USA only)	
Passenger safety	
see Occupant safety	
Pedals	254
Pelvis air bags	41
Phone	
see Telephone	
Plastic parts, cleaning	265

- Power assistance** 255
- Power outlets** 210
- Power seats**
see Seats
- Power steering**
Messages in the multifunction display 288
- Power tilt/sliding sunroof**
Operation 196
Synchronizing 199
- Power washer** 261
- Power windows** 98
Cleaning 264
Operation 98
Rear door window, override switch 59
Synchronizing 99
- Practical hints** 268
- Problems**
While driving 104
With vehicle 23
With wipers 97
- Product information** 20
- Production options weight** 251
- Program mode selector switch**
Automatic shift program 111
Manual shift program 113, 114
- Proximity key**
see Key, SmartKey
- PSI (air pressure unit)** 251
- R**
- RACETIMER** 124
- Radio** 148
Satellite radio 152
Selecting stations 126
- Radio transmitters** 258
- Rain sensor**
see Intermittent wiping
- Rear axle oil** 351
- Rear center console ashtray**
see Ashtrays
- Rear doors**
Child safety locks 59
- Rear door window**
Override switch 59
- Rear fog lamp**
see Fog lamps
- Rear lamps**
see Tail lamps
- Rear seat head restraints**
see Head restraints
- Rear view camera** 188
Cleaning the camera lens 263
- Rear window defroster** 196
- Recommended tire inflation pressure** 230, 251
- Refrigerant, air conditioning** 354
- Refueling** 222
- Regular checks** 224
- Reminder, Seat belt**
see Seat belts, Telltale
- Remote control**
see Key, SmartKey
- Remote door lock (Tele Aid)** 216
- Remote door unlock (Tele Aid)** 215
- Replacing**
Key 74
- Replacing bulbs** 313
- Reporting safety defects** 23
- Research Octane Number**
see RON
- Reserve fuel**
Messages in the multifunction display 291
Warning lamp 304
- Restraint systems**
see Occupant safety
- Retaining hooks** 203
- Rims** 251, 344
- Roadside Assistance** 21, 214
- Roller sunblinds** 199
- RON (Research Octane Number)** 354
- Roof rack** 203
- Rubber parts, cleaning** 265
- S**
- Safety**
Driving safety systems 60
Occupant safety 36
Reporting defects 23
- Safety belts**
see Seat belts

- Satellite radio** 152
- Seat belt force limiter** 52
- Seat belts** 48
- Children in the vehicle 54
 - Cleaning 265
 - Fastening 50
 - Height adjustment 51
 - Proper use of 49
 - Safety guidelines 39
 - Safety notes 48
 - Telltale 301
- Seat heating** 84
- Seating capacity** 239
- Seats** 79
- Adjustment 79
 - Easy-entry/exit feature 85
 - Heating 84
 - Memory function 89
 - Messages in the multifunction display 286
 - Split rear seat bench 204
- Securing cargo**
- Cargo tie-down rings 203
- Selective setting**
- see Key, SmartKey
- Selector lever**
- see Gear selector lever
- Self-test**
- BabySmart™ 47
 - OCS (Occupant Classification System) 46
 - Tele Aid 212
- Service**
- see Maintenance
- Service, parts** 332
- Service and warranty information** 20
- Service intervals**
- see Maintenance System, Service indicator message
- Service life (tires)** 243
- Service menu** 129
- Settings**
- Factory setting (KEYLESS-GO) 73
 - Factory setting (SmartKey) 71
 - Memory function 89
 - Menu 130
 - Selective setting (KEYLESS-GO) 73
 - Selective setting (SmartKey) 71
- Self below rear window, cleaning** .. 265
- Side impact air bags** 41
- Side marker lamps**
- Cleaning lenses 263
 - Messages in the multifunction display 293
 - Replacing bulbs 314
- Sidewall (tires)** 252
- SmartKey**
- see Key, SmartKey
- SmartKey with KEYLESS-GO**
- see Key, SmartKey
- Snow chains** 253
- Snow tires**
- ♦ see Winter tires
- Spare wheel** 344
- Mounting 318
 - Storage location 270
- Speedometer** 28
- Speed settings**
- Cruise control 181
 - Resume function 183
- SRS (Supplemental Restraint System)**
- Indicator lamp 36, 302
 - Messages in the multifunction display 284
- Standing water, driving through** 257
- Starter switch positions**
- KEYLESS-GO 78
 - SmartKey 77
- Starting difficulties (engine)** 102
- Starting the engine** 101
- Steering column**
- see Multifunction steering wheel, Adjustment
- Steering wheel**
- see Multifunction steering wheel
- Steering wheel gearshift control** 112
- Stolen Vehicle Recovery Services** ... 216
- Storage compartments** 205
- Storing tires** 244
- Sunroof**
- see Power tilt/sliding sunroof
- Sunshade**
- Rear window 208

Sun visors 208

T

Tachometer 28, 117

Overspeed range 117

Tail lamps 314

Cleaning lenses 263

Messages in the multifunction display 295

Replacing bulbs 314

Tar stains 261

Technical data

Air conditioning refrigerant 352, 354

Brake fluid 351, 354

Capacities fuels, coolants, lubricants etc. 349

Coolant 351, 356

Engine oil additives 353

Engine oils 350, 353

Fuel requirements 354

Gasoline additives 355

Identification labels 332

Premium unleaded gasoline 354

Rims and tires 344

Spare wheel 349

Vehicle specification C 250 334

Vehicle specification

C 250 4MATIC 335

Vehicle specification

C 250 4MATIC Sport 336

Vehicle specification C 250 Sport .. 334

Vehicle specification C 300 337

Vehicle specification

C 300 4MATIC 339

Vehicle specification

C 300 4MATIC Sport 340

Vehicle specification C 300 Sport .. 338

Vehicle specification C 350 341

Vehicle specification

C 350 4MATIC 343

Vehicle specification C 350 Sport .. 342

Vehicle specification C 63 AMG 343

Washer and headlamp cleaning system 352, 358

Technical data (dimensions)

see Vehicle specification

Technical data (electrical system)

see Vehicle specification

Technical data (engine)

see Vehicle specification

Technical data (weights)

see Vehicle specification

Tele Aid 211

Emergency calls 212

Information button 215

Initiating an emergency call manually 213

Messages in the multifunction display 284

Remote door lock 216

Remote door unlock 215

Roadside Assistance button 214

Search & Send 215

SOS button 213

Stolen Vehicle Recovery Services .. 216

System self-test 212

Telephone 167

Answering/ending a call 128

Call lists 176

Emergency calls "9 1 1" 173

Hands-free microphone 33

Making calls 177

Menu 128

Operation 128

Phone book 128, 174

Redialing 129

Temperature

Coolant 117

Interior temperature 192

Outside 118

Tether anchorage points

see Children in the vehicle

Tie-down rings 203

Tightening torque

Wheels 321

Time setting 132

TIN (Tire Identification Number) 252

Tire and Loading Information

placard 238

Tire and loading terminology 250

Tire Identification Number

see TIN

- Tire inflation pressure**
- Checking 232
 - Important notes on 231
 - Label on the inside of fuel filler flap 231
 - Placard on driver's door B-pillar 238
- Tire labeling** 246
- Tire load rating** 251
- Tire ply composition and material used** 252
- Tire pressure loss warning system** . 233
- Tires** 229, 344
- Advanced Tire Pressure Monitoring System (Advanced TPMS) 234
 - Air pressure 230
 - Care and maintenance 243
 - Cleaning 244
 - Direction of rotation, spinning 242
 - Important notes on tire inflation pressure 231
 - Inflation pressure 232
 - Information placard 238
 - Inspection 243
 - Labeling 246
 - Load index 246, 251
 - Load rating 251
 - Messages in the multifunction display 276, 296
 - Ply composition and material used 252
 - Problems under-/overinflation 232
 - Retreads 229
 - Rims and tires (technical data) 344
 - Rotation 245
 - Service life 243
 - Sizes 344
 - Snow chains 253
 - Speed rating 247, 252
 - Storing 244
 - Temperature 231, 245
 - Terminology 250
 - Tire Identification Number 252
 - Tire pressure loss warning system . 233
 - TPMS low tire pressure/malfunction telltale 306
 - Traction 244, 252
 - Tread 252
 - Tread depth 243, 252
 - Treadwear 244
 - Treadwear indicators 243, 252
 - Vehicle maximum load on 252
 - Wear pattern 245
 - Winter tires 252, 344
- Tire speed rating** 247, 252
- Top tether**
see Children in the vehicle
- Total load limit** 252
- Towing**
- Towing eye bolt 326
 - Vehicle 325
- Towing eye bolt** 326
- Traction** 244, 252
- Transfer case** 116
- Transmission**
see Automatic transmission or Manual transmission
- Transmission fluid level** 227
- Transmission gear selector lever**
see Gear selector lever
- Transmission positions** 109
- Traveling abroad** 257
- Tread (tires)** 252
- Tread depth (tires)** 243, 252
- Treadwear** 244
- Treadwear indicators (tires)** 243, 252
- Trip menu** 121
- Trunk**
- Closing 76
 - Fuse box 329
 - Messages in the multifunction display 286
 - Opening 75
 - Tie-down rings 203
 - Trunk lid emergency release 76
 - Unlocking manually 309
 - Valet locking 77
- Turning off the engine** 106
- Turn signals** 93
- Cleaning lenses 263
 - Indicator lamps 28
 - Messages in the multifunction display 296
 - Replacing bulbs 314

- U**
- Uniform Tire Quality Grading Standards** 244, 252
 - Units**
 - Selecting speedometer display mode 131
 - Unleaded gasoline, premium** 354
 - Unlocking the vehicle**
 - KEYLESS-GO 71
 - Manually 309
 - SmartKey 70
 - Upholstery, cleaning** 266
 - Useful features** 207
- V**
- Valet locking** 77
 - Vehicle**
 - Battery 321
 - Care 260
 - Control system 118
 - Identification Number (VIN) 332
 - Locking/unlocking 70
 - Lowering (wheel change) 321
 - Modifications and alterations, 321
 - Operating safety 22
 - Towing 325
 - Unlocking/locking manually 309
 - Vehicle dimensions**
 - see Vehicle specification
 - Vehicle Identification Number (VIN)** 332
 - Vehicle jack**
 - see Jack
 - Vehicle lighting** 90
 - Vehicle loading**
 - Cargo tie-down rings 203
 - Instructions 202
 - Load limit 239
 - Roof rack 203
 - Split rear seat bench 204
 - Terminology 250
 - Vehicle maximum load on the tire** ... 252
 - Vehicle specification**
 - C 250 334
 - C 250 4MATIC 335
 - C 250 4MATIC Sport 336
 - C 250 Sport 334
 - C 300 337
 - C 300 4MATIC 339
 - C 300 4MATIC Sport 340
 - C 300 Sport 338
 - C 350 341
 - C 350 4MATIC 343
 - C 350 Sport 342
 - C 63 AMG 343
 - Vehicle status message memory** 129
 - Vehicle tool kit** 268
 - Vehicle washing**
 - see Vehicle care
 - Vehicle weights**
 - see Vehicle specification
- W**
- Warning sounds**
 - Driver's or passenger's seat belt 51
 - Parking brake 281
 - Parktronic system 187
 - Seat belt telltale 301
 - Warranty coverage** 332
 - Washer and headlamp cleaning system** 358
 - Washer fluid**
 - Mixing ratio 358
 - Refilling 228
 - Washing the vehicle** 260
 - Wear pattern (tires)** 245
 - Weights (vehicle)**
 - see Vehicle specification
 - Wheel**
 - Changing 317
 - Removing 320
 - Spare 317
 - Tightening torque 321
 - Wheels, sizes** 344
 - Wheels, Tires and** 229
 - Window curtain air bags** 42
 - Windows**
 - see Power windows
 - Windows, cleaning** 264
 - Windshield**
 - Cleaning wiper blades 264
 - Defogging 195

Washer fluid	358
Wipers	96
Windshield wipers	
Replacing wiper blades	316
Winter driving	
Instructions	253
Snow chains	253
Tires	252
Winter tires	252, 344
Wood trims, cleaning	266

امداد خودرو فارما

تلفن شبانه روزی: ۰۲۱-۸۸۸۶۲۰۸۵

FarmaSOS.com

Product Information

Please observe the following in your own best interest:

We recommend using Genuine Mercedes-Benz Parts as well as conversion parts and accessories explicitly approved by us for your vehicle model.

We have tested these parts to determine their reliability, safety and special suitability for Mercedes-Benz vehicles.

We are unable to make an assessment for other products and therefore cannot be held responsible for them, even if in individual cases an official approval or authorization by governmental or other agencies should exist. Use of such parts and accessories could adversely affect the safety, performance or reliability of your vehicle. Please do not use them.

Genuine Mercedes-Benz Parts and pre-approved conversion parts and accessories are available at any authorized Mercedes-Benz Center. In addition, you will receive comprehensive information on permissible technical modifications and expert installations.

Operator's Manual

Notes

This Operator's Manual contains a great deal of useful information. We urge you to read it carefully and familiarize yourself with the vehicle before driving.

For your own safety and longer service life of the vehicle, we urge you to follow the instructions and warnings contained in this Operator's Manual. Ignoring them could result in damage to the vehicle or personal injury to you or others. Vehicle damage caused by failure to follow instructions is not covered by the Mercedes-Benz Limited Warranty.

We continuously strive to improve our product and ask for your understanding that we reserve the right to make changes in design and equipment. Therefore, information, illustrations, and descriptions in this Operator's Manual might differ from your vehicle.

Vehicle equipment

Your vehicle may have some or all of the equipment described in this manual.

Therefore, you may find explanations for optional equipment not installed in your vehicle. If you have any questions about operating particular equipment, any authorized Mercedes-Benz Center will be glad to demonstrate the proper procedures.

Optional equipment is also described in this manual, including operating instructions wherever necessary. Since they are special-order items, the descriptions and illustrations herein may vary slightly from the actual equipment of your vehicle.

If there are any equipment details that are not shown or described in this Operator's Manual, any authorized Mercedes-Benz Center will be glad to inform you of correct care and operating procedures. The Operator's Manual and Maintenance Booklet are important documents and should be kept with the vehicle.

Service and warranty information

The Service and Warranty Information booklet contains detailed information about the warranties covering your Mercedes-Benz, including:

- New Vehicle Limited Warranty
- Emission System Warranty
- Emission Performance Warranty
- California, Connecticut, Maine, Massachusetts, New York, Pennsylvania,

Rhode Island, and Vermont Emission Control System Warranty

- State Warranty Enforcement Laws (Lemon Laws)

Mercedes-Benz USA, LLC
Customer Assistance Center
One Mercedes Drive
Montvale, NJ 07645-0350

Important notice for California retail buyers and lessees of Mercedes-Benz automobiles

Under California law you may be entitled to a replacement of your vehicle or a refund of the purchase price or lease price, if after a reasonable number of repair attempts Mercedes-Benz USA, LLC and/or its authorized repair or service facilities fail to fix one or more substantial defects or malfunctions in the vehicle that are covered by its express warranty. During the period of 18 months from original delivery of the vehicle or the accumulation of 18 000 miles (approximately 29 000 km) on the odometer of the vehicle, whichever occurs first, a reasonable number of repair attempts is presumed for a retail buyer or lessee if one or more of the following occurs:

- (1) the same substantial defect or malfunction results in a condition that is likely to cause death or serious bodily injury if the vehicle is driven, that defect or malfunction has been subject to repair two or more times, and you have directly notified Mercedes-Benz USA, LLC in writing of the need for its repair,
- (2) the same substantial defect or malfunction of a less serious nature than category (1) has been subject to repair four or more times and you have directly notified us in writing of the need for its repair, or
- (3) the vehicle is out of service by reason of repair of the same or different substantial defects or malfunctions for a cumulative total of more than 30 calendar days.

Written notification should not be sent to a dealer, it should be addressed to

Maintenance

The Maintenance Booklet describes all the necessary maintenance work which should be performed at regular intervals.

Always have the Maintenance Booklet with you when you take the vehicle to an authorized Mercedes-Benz Center for service. The service advisor will record each service in the booklet for you.

Roadside Assistance

The Mercedes-Benz Roadside Assistance Program provides factory-trained technical help in the event of a breakdown. Calls to the toll-free Roadside Assistance number

1-800-FOR-MERCedes (1-800-367-6372)
(in the USA) 1-800-387-0100 (in Canada)

will be answered by Mercedes-Benz Customer Assistance Representatives 24 hours a day, 365 days a year.

For additional information refer to the Mercedes-Benz Roadside Assistance Program brochure (in the USA) or the Roadside Assistance section of the Service and Warranty Information Booklet (in Canada) in your vehicle literature portfolio.

Change of address or ownership

If you change your address, be sure to send in the "Change of Address Notice" found in the Service and Warranty Information Booklet, or simply call the Mercedes-Benz Customer Assistance Center (in the USA) at 1-800-FOR-MERCedes (1-800-367-6372), or Customer Service (in Canada) at 1-800-387-0100. This will assist us in

contacting you in a timely manner should the need arise.

If you sell your Mercedes, please leave all literature with the vehicle to make it available to the next operator.

If you bought this vehicle used, be sure to send in the “Notice of Purchase of Used Car” found in the Service and Warranty Information Booklet, or call the Mercedes-Benz Customer Assistance Center (in the USA) at 1-800-FOR-MERCEdes (1-800-367-6372), or Customer Service (in Canada) at 1-800-387-0100.

Operating your vehicle outside the USA or Canada

If you plan to operate your vehicle in foreign countries, please be aware that:

- Service facilities or replacement parts may not be readily available.
- Unleaded gasoline for vehicles with catalytic converters may not be available; the use of leaded fuels will damage the catalysts.
- Gasoline may have a considerably lower octane rating, and improper fuel can cause engine damage.

Certain Mercedes-Benz models are available for delivery in Europe under our European Delivery Program. For details, consult an authorized Mercedes-Benz Center or write to:

In the USA:

Mercedes-Benz USA, LLC
European Delivery Department
One Mercedes Drive
Montvale, NJ 07645-0350

In Canada:

Mercedes-Benz Canada, Inc.
European Delivery Department
98 Vanderhoof Avenue
Toronto, Ontario M4G 4C9

Operating safety

Warning!

Work improperly carried out on electronic components and associated software could cause them to cease functioning. Because the vehicle's electronic components are interconnected, any modifications made may produce an undesired effect on other systems. Electronic malfunctions could seriously impair the operating safety of your vehicle.

Contact an authorized Mercedes-Benz Center for repairs or modifications to electronic components.

Other improper work or modifications on the vehicle could also have a negative impact on the operating safety of the vehicle.

Some safety systems only function while the engine is running. You should therefore never turn off the engine while driving.

Warning!

Heavy blows against the vehicle underbody or tires/wheels may cause serious damage and impair the operating safety of your vehicle.

Such blows can be caused, for example, by running over an obstacle, road debris or a pothole. If you feel a sudden significant vibration or ride disturbance, or you suspect that damage to your vehicle as occurred:

- turn on your hazard warning flashers
- slow down carefully
- drive with caution to an area which is a safe distance from the road

Inspect the vehicle underbody and tires/wheels for possible damage. If the vehicle appears unsafe, have it towed to the nearest authorized Mercedes-Benz Center or other qualified maintenance or repair facility for further inspection or repairs.

Proper use of the vehicle

Proper use of the vehicle requires that you are familiar with the following information and rules:

- the safety precautions in this manual
- the “Technical data” section in this manual
- traffic rules and regulations
- motor vehicle laws and safety standards

Warning!

Various warning labels are attached to your vehicle. These warning labels are intended to make you and others aware of various risks. Do not remove any of these warning labels unless explicitly instructed to do so by information on the label itself. Removing warning labels may cause you and others to be unaware of certain risks which may result in an accident and/or personal injury.

Problems with your vehicle

If you should experience a problem with your vehicle, particularly one that you believe may affect its safe operation, we urge you to contact an authorized Mercedes-Benz Center immediately to have the problem diagnosed and corrected if required. If the matter is not handled to your satisfaction, please discuss the problem with the Mercedes-Benz Center management or, if necessary, contact us at one of the following addresses:

In the USA:

Customer Assistance Center
Mercedes-Benz USA, LLC
One Mercedes Drive
Montvale, NJ 07645-0350

In Canada:

Customer Relations Department
Mercedes-Benz Canada, Inc.
98 Vanderhoof Avenue
Toronto, Ontario M4G 4C9

Reporting safety defects

For the USA only:

The following text is published as required of manufacturers under Title 49, Code of U.S. Federal Regulations, Part 575 pursuant to the “National Traffic and Motor Vehicle Safety Act of 1966”.

Reporting safety defects

If you believe that your vehicle has a defect which could cause a crash or could cause injury or death, you should immediately inform the National Highway Traffic Safety Administration (NHTSA) in addition to notifying Mercedes-Benz USA, LLC.

If NHTSA receives similar complaints, it may open an investigation, and if it finds that a safety defect exists in a group of vehicles, it may order a recall and remedy campaign. However, NHTSA cannot become involved in individual problems between you, your dealer, or Mercedes-Benz USA, LLC.

To contact NHTSA, you may call the Vehicle Safety Hotline toll-free at 1-888-327-4236

(TTY: 1-800-424-9153); go to www.safercar.gov; or write to:

Administrator, NHTSA Headquarters,
1200 New Jersey Avenue, SE, West Building,
Washington, DC 20590.

You can also obtain other information about motor vehicle safety from www.safercar.gov.

Vehicle data recording

Information regarding electronic recording devices

(Including notice pursuant to California Code § 9951)

Please note that your vehicle is equipped with devices that can record vehicle systems data and, if equipped with the Tele Aid system, may transmit some data in certain accidents.

This information helps, for example, to diagnose vehicle systems after a collision and to continuously improve vehicle safety. Daimler may access the information and share it with others

- for safety research or vehicle diagnosis purposes
- with the consent of the vehicle owner or lessee
- in response to an official request by law enforcement or other government agency
- for use in dispute resolution involving Daimler, its affiliates or sales/service organization and/or
- as otherwise required or permitted by law

Please check the Tele Aid subscription service agreement for details regarding the information that may be recorded or transmitted via that system.

تلفن شبانه روزی: ۰۲۱-۸۸۸۶۲۰۸۵

FarmaSOS.com

Exterior view	26
Cockpit	27
Instrument cluster	28
Multifunction steering wheel	29
Center console	31
Overhead control panel	32
Door control panel, seat adjustment	33

امداد خودرو فارما

تلفن شبانه روزی: ۰۲۱-۸۸۸۶۲۰۸۵

FarmaSOS.com



Exterior view

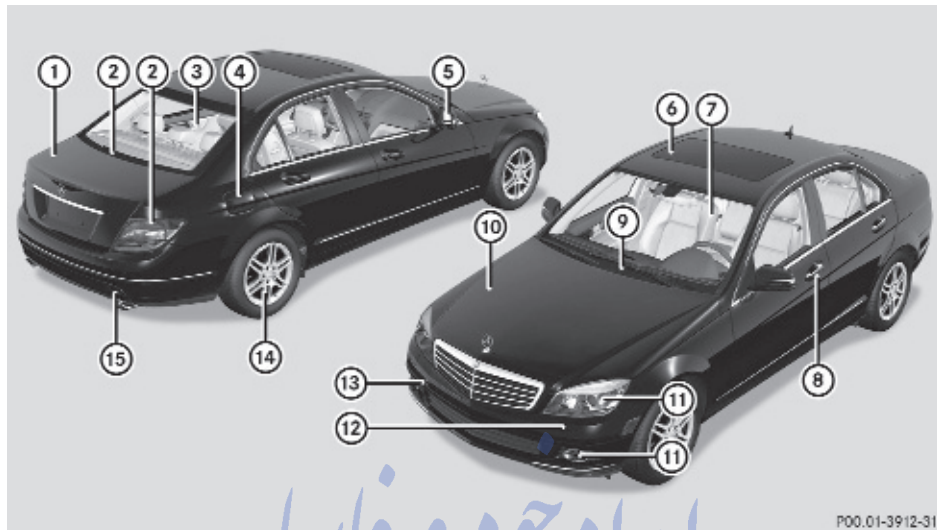

P00.01-3912-31

- i** This Operator's Manual describes all features, standard or optional, potentially available for your vehicle at the time of purchase. Please be aware that your vehicle might not be equipped with all features described in this manual.

	Function	Page	Function	Page		
①	Trunk:		⑧	Doors:		
	Locking and unlocking	70, 309		Locking and unlocking	70, 309	
	Opening and closing	75		⑨	Wipers	96
	Valet locking	77			Wiper blades, replacing	316
②	Rear lamps	314	Wiper blades, cleaning	264		
	③	Rear window defroster	196	⑩	Hood	224
Fuel filler flap		222	⑪		Front lamps	314
④	Exterior rear view mirrors	86		⑫	Headlamp cleaning system	93
		Power tilt/sliding sunroof	196		⑬	Front towing eye
⑤	Panorama roof with power tilt/sliding panel	199	⑭	Tires and wheels		229
	Windshield:			Rims and tires	344	
⑥	Wiping with washer fluid	97	⑮	Rear towing eye	326	
	Cleaning	264				

Cockpit

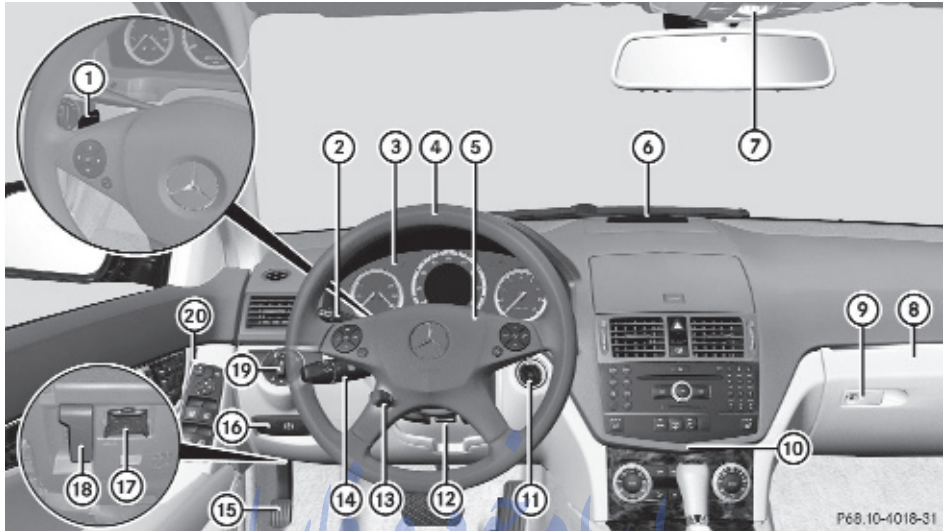

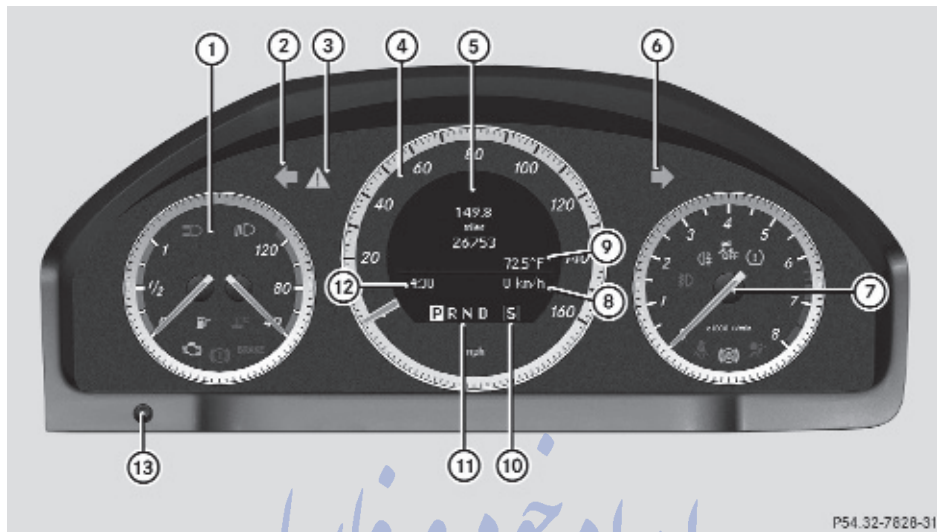

Function	Page	Function	Page
① Steering wheel gearshift control	112	⑫ Steering wheel release handle (manual)	85
② Cruise control lever	180	⑬ Steering wheel adjustment stalk (electrical)	85
③ Instrument cluster	116	⑭ Combination switch: Turn signals Wipers High beam	93 96 93
④ Multifunction steering wheel	118	⑮ Parking brake pedal	105
⑤ Horn		⑯ Parking brake release	105
⑥ Front Parktronic warning indicators, Canada only	186	⑰ On-board diagnostics (OBD) socket	
⑦ Overhead control panel	32	⑱ Hood lock release	224
⑧ Glove box	205	⑲ Exterior lamp switch	90
⑨ Glove box lock	206	⑳ Door control panel and seat adjustment/memory	33
⑩ Center console	31		
⑪ Starter switch KEYLESS-GO start/stop button	77 78		

Instrument cluster









P54.32-7828-31

	Function	Page		Function	Page
①	Combination gauge with:		③	ESP® warning lamp	62, 302
	Fuel gauge	118	④	Speedometer	
	Fuel tank reserve warning lamp	304	⑤	Multifunction display	120
	Coolant temperature gauge	117	⑥	Right turn signal indicator lamp	93
	Coolant temperature warning lamp	305	⑦	Tachometer with:	
	Indicator/warning lamps:			Front fog lamps indicator lamp	92
	High-beam headlamp indicator lamp	93		Rear fog lamp indicator lamp	92
	Low-beam headlamp indicator lamp	91		ESP OFF warning lamp, C 63 AMG only	64, 302
	Engine malfunction indicator lamp	305		Combination low tire pressure/TPMS malfunction telltale, USA only	234, 306
	BRAKE Brake warning lamp, USA only	300		Supplemental Restraint System (SRS) indicator lamp	36, 302
	Brake warning lamp, Canada only	300			
②	Left turn signal indicator lamp	93			

Function	Page
 Antilock Brake System (ABS) indicator lamp	61, 298
 Seat belt telltale	51, 301
⑧ Outside temperature (manual transmission) Permanent display: Outside temperature or speedometer (automatic transmission)	118 118, 132
⑨ Outside temperature (automatic transmission)	118, 132
⑩ Program mode indicator (automatic transmission)	111
⑪ Transmission position indicator/gear range indicator (automatic transmission) Additional speedometer (manual transmission)	109, 111 132
⑫ Digital clock	132
⑬ Instrument cluster illumination	117

Multifunction steering wheel











Function	Page
① Multifunction display	120
② Press button  : to end a call to reject an incoming call Press button  : to answer a call to dial ¹ to redial ¹ Press button  or  : to set the volume to operate the RACETIMER ² Press button  to mute	128 128 128 128 129 126 124
③ Press button  to activate the Voice Control System ³	

¹ Function only available in telephone menu.

² AMG vehicles only.

³ The Voice Control System is only available with the COMAND system. Refer to separate operating instructions.

	Function	Page
④	Press button  briefly:	
	to go to the next higher menu level	120
	to confirm display message	120
	to cancel the Voice Control System ³	
	Press and hold button  to select the standard display	120
⑤	Press button  or  :	120
	to call up line for main menus	
	to scroll to the left or right to select menus	
	Press button  or  briefly:	120
	to select submenus	
	to scroll up or down through lists	
	to select previous or next track, scene, or stored station within Audio menu	126
	to switch to the phone book and select a name or number within Tel menu	128
	Press and hold button  or  :	120
	to select previous or next track or scene with quick search or to select previous or next station in waveband (if no station list is available) within Audio menu	126
to start the quick search in the phone book within Tel menu	128	

	Function	Page
	Press button  :	
	to confirm selection or message	120
	to switch to the phone book ¹	128
	to dial a selected phone number ¹	128

امداد خودرو فارما

تلفن شبانه روزی: ۰۸۵-۸۸۶۲۰۸۵

PharmaSOS.com

³ The Voice Control System is only available with the COMAND system. Refer to separate operating instructions.

¹ Function only available in telephone menu.

Center console

Upper part

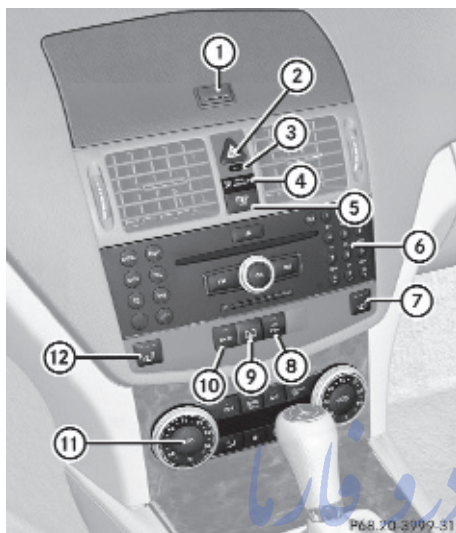

	Function	Page
⑧	Parktronic system deactivation switch, Canada only	187
⑨	Rear window sunshade switch	208
⑩	Sport driving mode on/off button	184
⑪	Dual-zone automatic climate control	189
	Rear window defroster	196
⑫	Seat heating, driver's side	84

At a glance

	Function	Page
①	Audio display cover	139
②	Hazard warning flasher switch	93
③	Alarm system indicator lamp	67
④	Front passenger front air bag off indicator lamp, USA only	42, 308
	Front passenger front air bag off indicator lamp, Canada only	46, 307
⑤	Electronic Stability Program (ESP [®]) switch	63
⑥	Audio system or COMAND system, see separate operating instructions	136
⑦	Seat heating, front passenger side	84

تلفن شبانه روزی: ۰۸۵-۸۸۸۶۰۰۱

FarmaSOS.com

Lower part

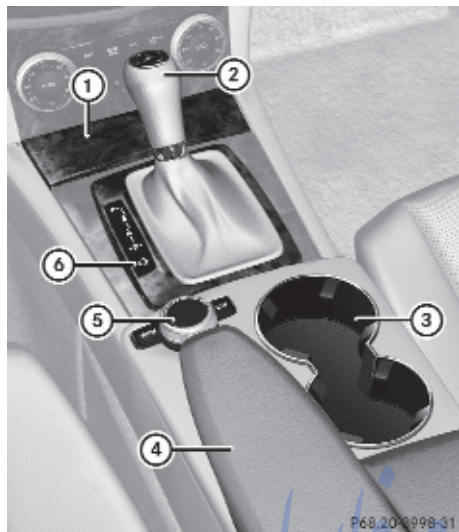

P68.20-999-31

	Function	Page
①	Ashtray Cigarette lighter	209 209
②	Gear shift lever for manual transmission Gear selector lever for automatic transmission	107 108
③	Cup holder	207
④	Front armrest storage compartments	206
⑤	Audio controller COMAND controller (see separate operating instructions)	140
⑥	Program mode selector switch for automatic transmission	111

Overhead control panel



P82.00-2682-31

	Function	Page
①	Rear interior lighting on/off	95
②	Interior lighting control	95
③	Right reading lamp on/off	95
④	Power tilt/sliding sunroof switch or Power tilt/sliding panel switch	196 200
⑤	Information button (Tele Aid system)	215
⑥	SOS button (Tele Aid system)	213
⑦	Interior rear view mirror	86
⑧	Integrated electronic compass	210
⑨	Garage door opener	216

Function	Page
⑩ Hands-free microphone for Tele Aid (emergency call system), telephone and Voice Control System ⁴	
⑪ Roadside Assistance button (Tele Aid system)	2 14
⑫ Left reading lamp on/off	95
⑬ Front interior lighting on/off	95

Door control panel, seat adjustment

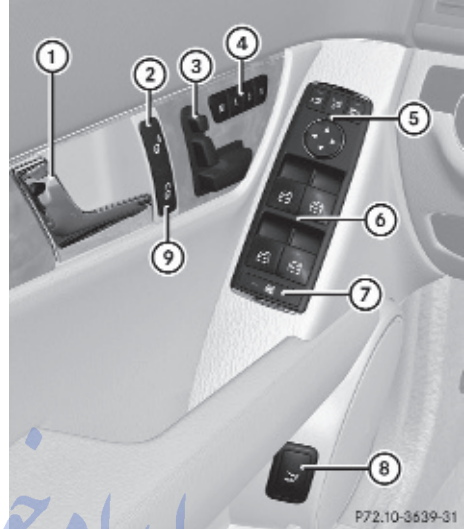

Door control panel, vehicles with memory function

Function	Page
① Inside door handle	74
② Central unlocking switch	75
③ Seat adjustment	82
④ Memory function (for storing seat, exterior mirror, and steering wheel settings)	89
⑤ Exterior rear view mirrors adjustment	86
Power-folding exterior rear view mirrors, Canada only	88
⑥ Switches for opening/closing front and rear door windows	98
⑦ Rear door window override switch	59

⁴ The Voice Control System is only available with the COMAND system. Refer to separate operating instructions.

	Function	Page
⑧	Trunk opening switch	75
⑨	Central locking switch	75



Seat adjustment, vehicles without memory function

	Function	Page
③	Seat adjustment	80

تلفن شبانه روزی: ۰۲۱-۸۸۸۶۲۰۸۵

FarmaSOS.com

Vehicle equipment	36
Occupant safety	36
Panic alarm	60
Driving safety systems	60
Anti-theft systems	66

امداد خودرو فارما

تلفن شبانه روزی: ۰۲۱-۸۸۸۶۲۰۸۵

FarmaSOS.com



Vehicle equipment

- i** This Operator's Manual describes all features, standard or optional, potentially available for your vehicle at the time of purchase. Please be aware that your vehicle might not be equipped with all features described in this manual.

Occupant safety

Introduction

In this section you will learn the most important facts about the restraint system components of the vehicle.

The restraint systems are:

- Seat belts
- Child restraints
- Lower Anchors and Tethers for Children (LATCH) also known as ISOFIX

Additional protection potential is provided by:

- Supplemental Restraint System (SRS) with
 - Air bags
 - Air bag control unit (with crash sensors)
 - Emergency Tensioning Device (ETD) for seat belts
 - Seat belt force limiter
- NECK-PRO active front head restraints
- Air bag system components with
 - Front passenger front air bag off indicator lamp
 - USA only: Front passenger seat with Occupant Classification System (OCS)
 - Canada only: Front passenger seat with BabySmart™ air bag deactivation system

Although the systems are independent, their protective functions work in conjunction with each other.

Warning!

Modifications to or work improperly conducted on restraint system components or their wiring, as well as tampering with interconnected electronic systems, can lead to the restraint systems no longer functioning as intended.

Air bags or Emergency Tensioning Devices (ETDs), for example, could deploy inadvertently or fail to deploy in accidents although the deceleration threshold for air bag deployment is exceeded. Therefore, never modify the restraint systems. Do not tamper with electronic components or their software.

- i** See “Children in the vehicle” (▷ page 54) for information on
- infants and children traveling with you in the vehicle
 - restraint systems for infants and children

SRS indicator lamp

The SRS system conducts a self-test when the ignition is switched on and in regular intervals while the engine is running. This facilitates detection of system malfunctions.

The SRS indicator lamp  in the instrument cluster comes on when the ignition is switched on. It goes out no later than a few seconds after the engine has been started.

The SRS components are in operational readiness when the SRS indicator lamp  is not lit while the engine is running.

⚠ Warning!

The SRS self-check has detected a malfunction when the SRS indicator lamp



- does not come on at all
- fails to go out after approximately 4 seconds after the engine was started
- comes on after the engine was started or while driving

For your safety, we strongly recommend that you contact an authorized Mercedes-Benz Center immediately to have the system checked. Otherwise the SRS may not be activated when needed in an accident, which could result in serious or fatal injury. The SRS might also deploy unexpectedly and unnecessarily which could also result in injury as well.

In addition, improper work on the SRS creates a risk of rendering the SRS inoperative or causing unintended air bag deployment. Work on the SRS must therefore only be performed by qualified technicians. Contact an authorized Mercedes-Benz Center.

If it is necessary to modify an air bag system to accommodate a person with disabilities, contact an authorized Mercedes-Benz Center. USA only: Call our Customer Assistance Center at 1-800-FOR-MERCEDES (1-800-367-6372) for details.

Air bags**⚠ Warning!**

Air bags are designed to reduce the potential of injury and fatality in certain

- frontal impacts (front air bags and driver's side knee bag)
- side impacts (side impact air bags, window curtain air bags and pelvis air bags)

However, no system available today can completely eliminate injuries and fatalities.

Deployment of the air bags temporarily releases a small amount of dust from the air bags. This dust, however, is neither harmful to your health, nor does it indicate a fire in the vehicle. The dust might cause some temporary breathing difficulty for people with asthma or other breathing trouble. To avoid this, you may wish to get out of the vehicle as soon as it is safe to do so. If you have any breathing difficulty but cannot get out of the vehicle after the air bag inflates, then get fresh air by opening a window or door.

⚠ Warning!

To reduce the risk of injury when the front air bags inflate, it is very important for the driver and front passenger to always be in a properly seated position and to wear their respective seat belt.

For maximum protection in the event of a collision always be in normal seated position with your back against the seat backrest. Fasten your seat belt and make sure it is properly positioned on your body.

Since the air bag inflates with considerable speed and force, a proper seating position and correct positioning of the hands on the steering wheel will help to keep you at a safe distance from the air bag. Occupants who are not wearing their seat belt, are not seated properly or are too close to the air bag can be seriously injured or killed by an air bag as it inflates with great force instantaneously:

- Sit with the seat belt properly fastened in a position that is as upright as possible with your back against the seat backrest.
- Move the driver's seat as far back as possible, still permitting proper operation of vehicle controls. The distance from the center of the driver's chest to the center of the air bag cover on the steering wheel must be at least 10 inches (25 cm) or more. You should be able to accomplish this by adjusting the seat and steering wheel. If

you have any difficulties, please contact an authorized Mercedes-Benz Center.

- Do not lean your head or chest close to the steering wheel or dashboard.
- Keep hands on the outside of the steering wheel rim. Placing hands and arms inside the rim can increase the risk and potential severity of hand/arm injury when the driver front air bag inflates.
- Adjust the front passenger seat as far as possible rearward from the dashboard when the seat is occupied.
- Occupants, especially children, should never place their bodies or lean their heads in the area of the door where the side impact air bag inflates. This could result in serious injuries or death should the side impact air bag be deployed. Always sit as upright as possible, wear the seat belt properly and use an appropriately sized infant restraint, toddler restraint, or booster seat recommended for the size and weight of the child.
- Canada only: Children 12 years old and under must never ride in the front seat, except in a Mercedes-Benz authorized BabySmart™ compatible child seat, which operates with the BabySmart™ air bag deactivation system installed in the vehicle to deactivate the front passenger front air bag when it is installed properly. Otherwise they will be struck by the air bag when it inflates in a crash. If this happens, serious or fatal injury will result.

Failure to follow these instructions can result in severe injuries to you or other occupants.

If you sell your vehicle, it is important that you make the buyer aware of this safety information. Be sure to give the buyer this Operator's Manual.

Warning!

Accident research shows that the safest place for children in an automobile is in a rear seat.

There is a possibility for a side impact air bag-related injury if occupants, especially children, are not properly seated or restrained when next to a side impact air bag which needs to deploy rapidly in a side impact in order to do its job.

To help avoid the possibility of injury, please follow these guidelines:

- (1) Always sit as upright as possible, wear the seat belt properly, and for children 12 years old and under, use an appropriately sized infant restraint, toddler restraint, or booster seat recommended for the size and weight of the child.
- (2) Always wear seat belts properly.

Air bags are designed to deploy only in certain

- frontal impacts (front air bags and driver's side knee bag)
- side impacts (side impact air bags, pelvis air bags and window curtain air bags) if the system determines the need for air bag deployment

Only in the event of such a situation will they provide their supplemental protection.

The driver and passengers should always wear their seat belts. Otherwise it is not possible for the air bags to provide their supplemental protection.

In case of other types of impacts and impacts below air bag deployment thresholds, air bags will not deploy. The driver and passengers will then be protected to the extent possible by a properly fastened seat belt. A properly fastened seat belt is also needed to provide the best possible protection in a rollover.

Air bags are not a substitute for seat belts. Always wear your seat belt, regardless of whether or not your vehicle is equipped with air bags.

It is important to your safety and that of your passengers to have deployed air bags

replaced and to have any malfunctioning air bags repaired. This will help to make sure the air bags will continue to provide supplemental crash protection for occupants.

Safety guidelines for the seat belt, Emergency Tensioning Device (ETD) and air bag

Warning!

- Damaged seat belts or seat belts that have been subjected to stress in an accident must be replaced. Their anchoring points must also be checked. Only use seat belts installed or supplied by an authorized Mercedes-Benz Center.
- Air bags and pyrotechnic Emergency Tensioning Devices (ETDs) contain perchlorate material, which may require special handling and regard for the environment. Check with your local government's disposal guidelines. California residents, see www.dtsc.ca.gov/HazardousWaste/Perchlorate/index.cfm.
- Air bags and ETDs are designed to function on a one-time-only basis. An air bag or ETD that has deployed must be replaced.
- Do not pass seat belts over sharp edges. They could tear.
- Do not make any modification that could change the effectiveness of the seat belts.
- Do not bleach or dye seat belts as this may severely weaken them. In a crash they may not be able to provide adequate protection.
- No modifications of any kind may be made to any components or wiring of the SRS.
- Do no change or remove any component or part of the SRS.
- Do not install additional trim material, seat covers, badges, etc. over the steering wheel hub, front passenger front air bag cover, outboard sides of the seat backrests, door trim panels, or door frame trims.
- Do not install additional electrical/ electronic equipment on or near SRS components and wiring.
- Keep area between air bags and occupants free of objects (e.g. packages, purses, umbrellas, etc.).
- Do not hang items such as coat hangers from the coat hooks or handles over the door. These items may be thrown around in the vehicle and cause head and other injuries when the window curtain air bag is deployed.
- Air bag system components will be hot after an air bag has inflated. Do not touch them.
- Never place your feet on the instrument panel, dashboard, or on the seat. Always keep both feet on the floor in front of the seat.
- Improper repair work on the SRS creates a risk of rendering the SRS inoperative or causing unintended air bag deployment. Work on the SRS must therefore only be performed by qualified technicians. Contact an authorized Mercedes-Benz Center.
- For your protection and the protection of others, when scrapping the air bag unit or ETD, our safety instructions must be followed. These instructions are available from any authorized Mercedes-Benz Center.
- Given the considerable deployment speed, required inflation volume, and the material of the air bags, there is the possibility of abrasions or other, potentially more serious injuries resulting from air bag deployment.

If you sell your vehicle, we strongly recommend that you inform the subsequent owner that the vehicle is equipped with SRS. Also refer them to the applicable section in the Operator's Manual.

Front air bags

 Observe Safety notes, see page 37.



Driver's front air bag ① and front passenger front air bag ② are designed to provide increased protection for the driver and front passenger against the risk of injuries to the head and thorax.

Driver and front passenger front air bag and driver's side knee bag are deployed

- in the event of certain frontal impacts
- if the system determines that air bag deployment can offer additional protection to that provided by the seat belt
- depending on whether the respective seat belt is in use
- independently of the side impact air bags, pelvis air bags and/or the window curtain air bags

The front air bags in this vehicle have been designed to inflate in two stages. This allows the air bags to have different rates of inflation. The rate of inflation is based on the vehicle deceleration rate as assessed by the air bag control unit.

Vehicles with OCS, USA only: The front passenger front air bag deployment is additionally influenced by the passenger's weight category as identified by the Occupant Classification System (OCS) (▷ page 42).



Vehicles with OCS, USA only: The lighter the front passenger-side occupant, the higher the vehicle deceleration rate required for second

stage inflation of the front passenger front air bag.

The air bags will not deploy in impacts which do not exceed the system's preset deployment thresholds. You will then be protected by the fastened seat belts.

The front air bags will not deploy in the event of a rollover unless the vehicle's rate of longitudinal deceleration or acceleration exceeds the preset deployment threshold for the front air bags.

The front passenger front air bag will only be deployed if

- vehicles with OCS, USA only: the system, based on OCS weight sensor readings, detects that the front passenger seat is occupied
- the  indicator lamp in the center console is not lit (USA only: (▷ page 42), Canada only: (▷ page 46))
- the impact exceeds a preset deployment threshold
-  Vehicles with BabySmart™ air bag deactivation system (Canada only): Do not place objects heavier than 20 lb (9 kg) on the front passenger seat. This could cause the front or side impact air bag on the front passenger side to deploy in a crash which exceeds the system's deployment threshold.

Knee bag

Knee bag ③ is designed to provide increased protection for the driver against the risk of injuries to the knees, thighs and lower legs.

Knee bag ③ is located on the driver side lower instrument panel. It is designed to operate together with the driver front air bag in certain frontal impacts if the system determines that air bag deployment can offer additional protection to that provided by the seat belt. Knee bag ③ operates best in conjunction with a properly positioned and fastened seat belt.

Side impact air bags

⚠ Observe Safety notes, see page 37.

⚠ Warning!

The pressure sensors for side impact air bag control are located in the doors. Do not modify any components of the doors or door trim panels including, for example, the addition of door speakers.

Improper repair work on the doors or the modification or addition of components to the doors create a risk of rendering the side impact air bags inoperative or causing unintended air bag deployment. Work on the doors must therefore only be performed by qualified technicians. Contact an authorized Mercedes-Benz Center.



Side impact air bags ① are designed to provide increased protection for the thorax but not the head, neck and arms of the driver or front passenger.

The side impact air bags ① are deployed

- on the impacted side of the vehicle
- in instances with a high rate of lateral vehicle deceleration or acceleration
- regardless of whether the seat belts on the impacted side of the vehicle are in use
- independently of the front air bags
- independently of the ETDs

Vehicles with OCS (USA only): The front passenger side impact air bag will not deploy if the OCS senses that the front passenger

seat is empty and the front passenger seat belt is not fastened. With the front passenger seat empty and the seat belt fastened, the front passenger side impact air bag will deploy independently of the empty seat.

Whether a seat belt is recognized as fastened depends on whether or not the latch plate is properly inserted into the buckle.

Side impact air bags ① are not deployed in side impacts which do not exceed the system's deployment threshold.

Side impact air bags ① will not deploy in the event of a rollover unless the vehicle's rate of lateral deceleration or acceleration exceeds the preset deployment threshold for side impact air bags ①.

! Vehicles with BabySmart™ air bag deactivation system (Canada only): Do not place objects heavier than 20 lb (9 kg) on the front passenger seat. This could cause the front or side impact air bag on the front passenger side to deploy in a crash which exceeds the system's deployment threshold.

⚠ Warning!

Only use seat covers which have been tested and approved by Mercedes-Benz for your vehicle model. Using other seat covers may interfere with or prevent the deployment of the side impact air bags and/or pelvis air bags. Contact an authorized Mercedes-Benz Center for availability.

Pelvis air bags

⚠ Observe Safety notes, see page 37.

Pelvis air bags are not available on C 63 AMG.

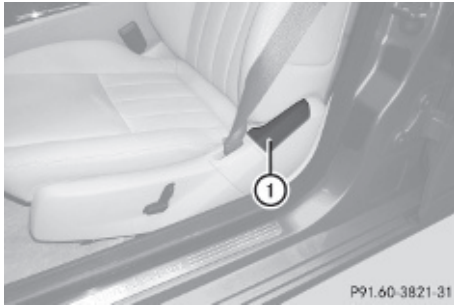

Pelvis air bags ① are designed to provide increased protection for the pelvis.

Pelvis air bags ① are deployed

- in instances with a high rate of lateral vehicle deceleration or acceleration
- on the impacted side of the vehicle
- independently of whether the seat belt is in use
- independently of the front air bags
- independently of the ETDs

Vehicles with OCS, USA only: Front passenger pelvis air bag ① will not deploy if the OCS senses that the front passenger seat is empty and the front passenger seat belt is not fastened. With the front passenger seat empty and the seat belt fastened, front passenger pelvis air bag ① will deploy independently of the empty seat. Whether a seat belt is recognized as fastened depends on whether or not the latch plate is properly inserted into the buckle.

Pelvis air bags ① are not deployed in side impacts which do not exceed the system's deployment threshold.

Pelvis air bags ① will not deploy in the event of a rollover unless the vehicle's rate of lateral deceleration or acceleration exceeds the preset deployment threshold for pelvis air bags ①.

Warning!

Only use seat covers which have been tested and approved by Mercedes-Benz for your vehicle model. Using other seat covers may

interfere with or prevent the deployment of the side impact air bags and/or pelvis air bags. Contact an authorized Mercedes-Benz Center for availability.

Window curtain air bags

 **Observe Safety notes, see page 37.**

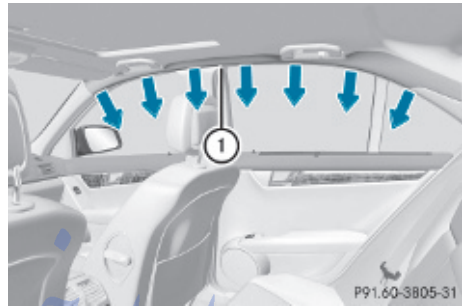

Window curtain air bags ① are designed to provide increased protection for the head but not the chest or arms.

Window curtain air bags ① are deployed

- on the impacted side of the vehicle
- in instances with a high rate of lateral vehicle deceleration or acceleration
- independently of the front air bags
- regardless of whether the front passenger seat is occupied
- regardless of whether the seat belt on the impacted side of the vehicle is in use

Window curtain air bags ① are not deployed in impacts which do not exceed the system's deployment threshold.

Window curtain air bags ① deploy in the area indicated by the arrows.

Occupant Classification System

The Occupant Classification System (OCS) is standard equipment in USA.

The OCS activates or deactivates the front passenger front air bag automatically. The respective status is based on the classified

occupant weight category determined by weight sensor readings from the front passenger seat.

The system does not deactivate

- the front passenger side impact air bag
- the pelvis air bag
- the window curtain air bag
- the Emergency Tensioning Devices (ETDs)

To be classified correctly, the front passenger must sit

- with the seat belt properly fastened
- in a position that is as upright as possible with the back against the seat backrest
- with the feet on the floor



If the occupant's weight is transferred to another object in the vehicle (e.g. by leaning on armrests), the OCS may not be able to properly approximate the occupant's weight category.

If your seat, including the trim cover and cushion, needs to be serviced in any way, take the vehicle to an authorized Mercedes-Benz Center.

Only seat accessories approved by Mercedes-Benz may be used.

Both the driver and the front passenger should always use the  indicator lamp as an indication of whether or not the front passenger is properly positioned.

Warning!



If the  indicator lamp illuminates when an adult or someone larger than a small individual is in the front passenger seat, have the front passenger reposition himself or herself in the seat until the  indicator lamp goes out.

In the event of a collision, the air bag control unit will not allow front passenger front air bag deployment when the OCS has classified the front passenger seat occupant as weighting as much as or less than a typical 12-month-old child in a standard child restraint or if the

front passenger seat is classified as being empty.



When the OCS senses that the front passenger seat occupant is classified as being up to or less than the weight of a typical 12-month-old child in a standard child restraint, the  indicator lamp will illuminate when the engine is started and remain illuminated, indicating that the front passenger front air bag is deactivated.

When the OCS senses that the front passenger seat is classified as being empty, the  indicator lamp will illuminate when the engine is started and remain illuminated, indicating that the front passenger front air bag is deactivated.

When the OCS senses that the front passenger seat occupant is classified as being heavier than the weight of a typical 12-month-old child seated in a standard child restraint or as being a small individual (such as a young teenager or a small adult), the  indicator lamp will illuminate for approximately 6 seconds when the engine is started and then, depending on occupant weight sensor readings from the seat, remain illuminated or go out. With the  indicator lamp illuminated, the front passenger front air bag is deactivated. With the  indicator lamp out, the front passenger front air bag is activated.

When the OCS senses that the front passenger seat occupant is classified as an adult or someone larger than a small individual, the  indicator lamp will illuminate for approximately 6 seconds when the engine is started and then goes out, indicating that the front passenger front air bag is activated.

If the  indicator lamp is illuminated, the front passenger front air bag is deactivated and will not be deployed.

If the   indicator lamp is not illuminated, the front passenger front air bag is activated and will be deployed

- in the event of certain frontal impacts
- if impact exceeds a preset deployment threshold
- independently of the side impact air bags or pelvis air bag

If the front passenger front air bag is deployed, the rate of inflation will be influenced by

- the rate of relevant vehicle deceleration as assessed by the air bag control unit
- the front passenger's weight category as identified by the OCS

For more information on air bag display messages in the multifunction display, see (▷ page 272).

Warning!











According to accident statistics, children are safer when properly restrained in the rear seating positions than in the front seating position. Thus, we strongly recommend that children be placed in the rear seats whenever possible. Regardless of seating position, children 12 years old and under must be seated and properly secured in an appropriate infant restraint, toddler restraint, or booster seat recommended for the size and weight of the child.

The infant or child restraint must be properly secured with the vehicle's seat belt, the seat belt and top tether strap, or lower anchors and top tether strap, fully in accordance with the child seat manufacturer's instructions.

Occupants, especially children, should always sit as upright as possible, wear the seat belt properly and use an appropriately sized infant restraint, toddler restraint, or booster seat recommended for the size and weight of the child.

Children can be killed or seriously injured by an inflating air bag. Note the following important information when circumstances require you to place a child in the front passenger seat:

- Your vehicle is equipped with air bag technology designed to deactivate the front passenger front air bag in your vehicle when the system senses the weight of a typical 12-month-old child or less along with the weight of a standard appropriate child restraint on the front passenger seat.
- A child in a rear-facing child restraint on the front passenger seat will be seriously injured or even killed if the front passenger front air bag inflates in a collision which could occur under some circumstances, even with the air bag technology installed in your vehicle. The only means to completely eliminate this risk is to never place a child in a rear-facing child restraint in the front seat. We therefore strongly recommend that you always place a child in a rear-facing child restraint in a backseat.

- If you must install a rear-facing child restraint on the front passenger seat because circumstances require you to do so, make sure the   indicator lamp is illuminated, indicating that the front passenger front air bag is deactivated. Should the   indicator lamp not illuminate or go out while the restraint is installed, please check installation. Periodically check the   indicator lamp while driving to make sure the   indicator lamp is illuminated. If the   indicator lamp goes out or remains out, do not transport a child on the front passenger seat until the system has been repaired.

A child in a rear-facing child restraint on the front passenger seat will be seriously

injured or even killed if the front passenger front air bag inflates.

- If you have to place a child in a forward-facing child restraint on the front passenger seat, move the seat as far back as possible, use the proper child restraint recommended for the age, size and weight of the child, and secure child restraint with the vehicle's seat belt according to the child seat manufacturer's instructions. For children larger than the typical 12-month-old child, the front passenger front air bag may or may not be activated.

Deployment of the driver front air bag does not mean that the front passenger front air bag also should have deployed.



The OCS may have determined

- that the seat was empty or occupied by the weight up to or less than that of a typical 12-month-old child seated in a standard child restraint – both of which are instances where the system suppresses deployment of the front passenger front air bag even though the impact met the criteria and was of sufficient severity to deploy the driver front air bag
- that the seat was occupied by a small individual (such as a young teenager or a small adult) or a child who weighs more than the weight of a typical 12-month-old child in a standard child restraint – both of which are instances where the system may suppress deployment of the front passenger front air bag even though the impact met the criteria and was of sufficient severity to deploy the driver front air bag



 indicator lamp ① will be illuminated, except with the SmartKey removed from the starter switch or with the starter switch in position 0.

Warning!







If the red SRS indicator lamp  in the instrument cluster and the  indicator lamp are lit at the same time, there is a malfunction in the OCS. The front passenger front air bag will be deactivated in this case. Have the system checked by qualified technicians as soon as possible. Contact an authorized Mercedes-Benz Center.

Only have the seat repaired or replaced at an authorized Mercedes-Benz Center.



In order to ensure proper operation of the air bag system and OCS:

- Sit with the seat belt properly fastened in a position that is as upright as possible with your back against the seat backrest.
- While seated, an occupant should not position him/herself in such a way as to cause the occupant's weight to be lifted from the seat bottom as this may result in the OCS being unable to correctly approximate the occupant's weight category.
- Read and observe all warnings in this chapter.

OCS Self-test

After turning the SmartKey in the starter switch to position **1** or **2** or pressing the KEYLESS-GO start/stop button once or twice, the   indicator lamp illuminates. If an adult occupant is properly sitting on the front passenger seat and the system classifies the occupant as an adult, the   indicator lamp will illuminate and go out after approximately 6 seconds. If the seat is not occupied and the system classifies the front passenger seat as being empty, the   indicator lamp will illuminate and not go out.

Warning!

If the   indicator lamp does not illuminate, the system is not functioning. You must contact an authorized Mercedes-Benz Center before seating any child on the front passenger seat.

For more information, see the “Practical hints” section (▷ page 308).

Warning!

Never place anything between seat cushion and child seat (e.g. pillow), since it reduces the effectiveness of the OCS. The bottom and back of the child seat must make full contact with the passenger seat cushion and backrest.

If necessary, adjust the tilt of the passenger seat backrest.

An incorrectly mounted child seat could cause injuries to the child in case of an accident, instead of increasing protection for the child.

Follow the manufacturer’s instructions for installation of child seats.

BabySmart™ air bag deactivation system

The BabySmart™ air bag deactivation system is standard equipment in Canada.

Warning!

According to accident statistics, children are safer when properly restrained in the rear seating positions than in the front seating position. Thus, we strongly recommend that children be placed in the rear seats whenever possible. Regardless of seating position, children 12 years old and under must be seated and properly secured in an appropriate infant restraint, toddler restraint, or booster seat recommended for the size and weight of the child.





The infant or child restraint must be properly secured with the vehicle’s seat belt, the seat belt and top tether strap, or lower anchors and top tether strap, fully in accordance with the child seat manufacturer’s instructions.

Occupants, especially children, should always sit as upright as possible, wear the seat belt properly and use an appropriately sized infant restraint, toddler restraint, or booster seat recommended for the size and weight of the child.

Children can be killed or seriously injured by an inflating air bag. Note the following important information when circumstances require you to place a child in the front passenger seat:

- Children 12 years old and under must never ride in the front seat, except in a Mercedes-Benz authorized BabySmart™ compatible child seat, which operates with the BabySmart™ system installed in the vehicle to deactivate the front passenger front air bag when it is installed properly. Otherwise they will be struck by the air bag when it inflates in a crash. If this happens, serious or fatal injury will result.
- A child in a rear-facing child restraint on the front passenger seat will be seriously injured or even killed if the front passenger front air bag inflates in a collision which could occur under some circumstances, even with the air bag technology installed in your vehicle. The only means to

completely eliminate this risk is to never place a child in a rear-facing child restraint in the front seat. We therefore strongly recommend that you always place a child in a rear-facing child restraint in a backseat.



- If you must install a BabySmart™ compatible rear-facing child restraint on the front passenger seat because circumstances require you to do so, make sure the  indicator lamp is illuminated, indicating that the front passenger front air bag is deactivated. Should the  indicator lamp not illuminate or go out while the restraint is installed, please check installation. Periodically check the  indicator lamp while driving to make sure the  indicator lamp is illuminated. If the  indicator lamp goes out or remains out, do not transport a child on the front passenger seat until the system has been repaired.

A child in a rear-facing child restraint on the front passenger seat will be seriously injured or even killed if the front passenger front air bag inflates.

- If you have to place a child in a forward-facing child restraint on the front passenger seat, move the seat as far back as possible, use the proper child restraint recommended for the age, size and weight of the child, and secure child restraint with the vehicle's seat belt according to the child seat manufacturer's instructions.

Warning!

When using a BabySmart™ compatible child seat on the front passenger seat, the front passenger front air bag will not deploy only if the  indicator lamp remains illuminated.

Please be sure to check the  indicator lamp every time you use a BabySmart™ compatible child seat on the front passenger seat. Should the 

indicator lamp go out while the restraint is installed, please check installation. If the  indicator lamp remains out, do not use the BabySmart™ restraint to transport a child on the front passenger seat until the system has been repaired.



Special BabySmart™ compatible child seats, designed for use with the Mercedes-Benz system, are required for use with the BabySmart™ air bag deactivation system. Please contact an authorized Mercedes-Benz Center for information on availability. With the special child seat installed properly, the front passenger front air bag will not deploy.

 indicator lamp ① will be illuminated, except with the SmartKey removed from the starter switch or with the starter switch in position **0**.

The system does not deactivate



- the side impact air bag
- the pelvis air bag
- the window curtain air bag
- the Emergency Tensioning Device (ETD)

Self-test BabySmart™ without special child seat installed

After turning the SmartKey in the starter switch to position **1** or **2** or pressing the KEYLESS-GO start/stop button once or twice, the  indicator lamp comes on for approximately 6 seconds and then goes out.

If the  WASER
AIR BAG OFF indicator lamp should not come on or is continuously lit, the system is not functioning. You must see an authorized Mercedes-Benz Center before seating any child on the front passenger seat. More information can be found in the “Practical hints” section (▷ page 307).

Warning!

Do not place powered-on laptops, mobile phones, electronic tags such as those used in ski passes and like electronic devices on the front passenger seat. Signals from such devices may interfere with the BabySmart™ air bag deactivation system. Such signal interference may cause the  WASER
AIR BAG OFF indicator lamp not to come on during self-test. The SRS indicator lamp  and/or the  WASER
AIR BAG OFF indicator lamp could be continuously lit, indicating that the system is not functioning. The front passenger front air bag could deploy inadvertently or fail to deploy in an accident.

Warning!

The BabySmart™ air bag deactivation system will ONLY work with a special child seat designed to operate with it. It will not work with child seats which are not BabySmart™ compatible.

Never place anything between seat cushion and child seat (e.g. pillow), since it reduces the effectiveness of the BabySmart™ air bag deactivation system. The bottom of the child seat must make full contact with the front passenger seat cushion. An incorrectly mounted child seat could cause injuries to the child in case of an accident, instead of protecting the child.

Follow the manufacturer's instructions for installation of special child seats.

Seat belts

Safety notes

The use of seat belts and infant and child restraint systems is required by law in all 50 states, the District of Columbia, the U.S. territories and all Canadian provinces.

Even where this is not the case, all vehicle occupants should have their seat belts fastened whenever the vehicle is in motion.

-  See “Children in the vehicle” (▷ page 54) for information on
 - infants and children traveling with you in the vehicle
 - restraint systems for infants and children

Warning!

Always fasten your seat belt before driving off. Always make sure all of your passengers are properly restrained. You and your passengers should always wear seat belts.

Failure to wear and properly fasten and position your seat belt greatly increases your risk of injuries and their likely severity in an accident.

If you are ever in an accident, your injuries can be considerably more severe without your seat belt properly buckled. Without your seat belt buckled, you are much more likely to hit the interior of the vehicle or be ejected from it. You can be seriously injured or killed.

In the same crash, the possibility of injury or death is lessened if you are properly wearing your seat belt. The air bags can only protect as intended if the occupants are properly wearing their seat belts.

Warning!

Never ride in a moving vehicle with the seat backrest in an excessively reclined position as this can be dangerous. You could slide under the seat belt in a collision. If you slide under it, the seat belt would apply force at the abdomen or neck. That could cause serious or even fatal injuries. The seat backrest and

seat belt provide the best restraint when the wearer is in a position that is as upright as possible and the seat belt is properly positioned on the body.

Warning!

Never let more people ride in the vehicle than there are seat belts available. Make sure everyone riding in the vehicle is correctly restrained with a separate seat belt. Never use a seat belt for more than one person at a time.

Warning!

Damaged seat belts or seat belts that have been subjected to stress in an accident must be replaced. Also, the seat belt anchoring points must be checked.

Only use seat belts which have been approved by Mercedes-Benz.

Do not make any modifications to the seat belts. This can lead to unintended activation of the ETDs or to their failure to activate when necessary.

Do not bleach or dye seat belts as this may severely weaken them. In a crash they may not be able to provide adequate protection.

Have all work carried out only by qualified technicians. Contact an authorized Mercedes-Benz Center.

Proper use of seat belts

Warning!

USE SEAT BELTS PROPERLY

- Seat belts can only protect when used properly. Never wear seat belts in any other way than as described in this section, as that could result in serious injuries in case of an accident.
- Each occupant should wear their seat belt at all times, because seat belts help reduce the likelihood of and potential severity of injuries in accidents, including rollovers. The integrated restraint system includes

SRS (driver front air bag, driver side knee bag, front passenger front air bag, side impact air bags, pelvis air bags, window curtain air bags for side windows), Emergency Tensioning Devices (ETDs), seat belt force limiters, and front seat knee bolsters.

The system is designed to enhance the protection offered to properly belted occupants in certain frontal (front air bags, driver's side knee bag, and ETDs) and side (side impact air bags, pelvis air bags, window curtain air bags, and ETDs) impacts which exceed preset deployment thresholds.

- Never wear the shoulder belt under your arm, against your neck or off your shoulder. In a frontal crash, your body would move too far forward. That would increase the chance of head and neck injuries. The seat belt would also apply too much force to the ribs or abdomen, which could severely injure internal organs such as your liver or spleen. Adjust the seat belt so that the shoulder section is located as close as possible to the middle of the shoulder. It should not touch the neck. Never pass the shoulder portion of the seat belt under your arm.
- Position the lap belt as low as possible on your hips and not across the abdomen. If the lap belt is positioned across your abdomen, it could cause serious injuries in a crash.
- Never wear seat belts over rigid or breakable objects in or on your clothing, such as eyeglasses, pens, keys etc., as these might cause injuries.
- Make sure the seat belt is always fitted snugly. Take special care of this when wearing loose clothing.
- Never use a seat belt for more than one person at a time. Do not fasten a seat belt

around a person and another person or other objects at the same time.

- Seat belts should not be worn twisted. In a crash, you would not have the full width of the seat belt to distribute impact forces. The twisted seat belt against your body could cause injuries.
- Pregnant women should also always use a lap/shoulder belt. The lap belt portion should be positioned as low as possible on the hips to avoid any possible pressure on the abdomen.
- Place the seat backrest in a position that is as upright as possible.
- Check your seat belt during travel to make sure it is properly positioned.
- Never place your feet on the instrument panel, dashboard, or on the seat. Always keep both feet on the floor in front of the seat.
- When using a seat belt to secure infant restraints, toddler restraints, or children in booster seats, always follow the child seat manufacturer's instructions.

Warning!

Do not pass seat belts over sharp edges. They could tear.

Do not allow the seat belt to get caught in the door or in the seat adjustment mechanism. This could damage the seat belt.

Never attempt to make modifications to seat belts. This could impair the effectiveness of the seat belts.

Fastening the seat belts

Warning!

According to accident statistics, children are safer when properly restrained in the rear seating positions than in the front seating position. Thus, we strongly recommend that children be placed in the rear seats whenever possible. Regardless of seating position,

children 12 years old and under must be seated and properly secured in an appropriately sized infant restraint, toddler restraint, or booster seat recommended for the size and weight of the child. For additional information, see "Children in the vehicle". A child's risk of serious or fatal injuries is significantly increased if the child restraints are not properly secured in the vehicle and/or the child is not properly secured in the child restraint.

Warning!

Vehicles with BabySmart™ air bag deactivation system, Canada only: Children 12 years old and under must never ride in the front seat, except in a Mercedes-Benz authorized BabySmart™ compatible child seat, which operates with the BabySmart™ system installed in the vehicle to deactivate the front passenger front air bag when it is installed properly. Otherwise they will be struck by the air bag when it inflates in a crash. If this happens, serious or fatal injury will result. تلفن شماره

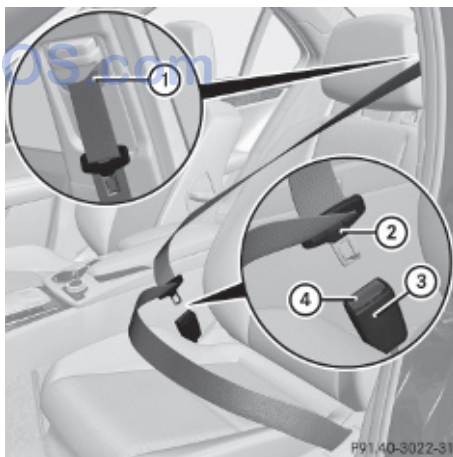

- ▶ With a smooth motion, pull the seat belt out of seat belt outlet ①.
- ▶ Place the shoulder portion of the seat belt across the top of your shoulder and the lap portion across your hips.

- ▶ Push latch plate ② into buckle ③ until it clicks.
- ▶ If necessary, adjust the seat belt to the correct height (▷ page 51).
- ▶ If necessary, tighten the lap portion to a snug fit by pulling shoulder portion up.

All lap/shoulder belts except the driver's seat belt have special seat belt retractors to secure child restraints properly. For more information on special seat belt retractors, see "Infant and child restraint systems" (▷ page 55).

To release the seat belt with seat belt release button ④, see (▷ page 51).

Seat belt outlet height adjustment

You can adjust the height of the seat belt outlet for the driver's and front passenger seat.

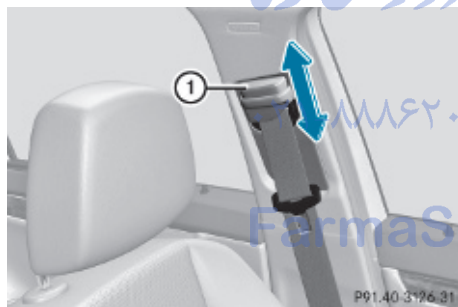

- ▶ **Raising:** Slide the seat belt outlet height adjuster upward.
The seat belt outlet height adjuster engages in different positions.
- ▶ **Lowering:** Press and hold release button ①.
- ▶ Slide the seat belt outlet height adjuster downward.
- ▶ Release release button ① and make sure the seat belt outlet height adjuster engages into place.

Releasing the seat belts

- ▶ Press seat belt release button ④ (▷ page 50).
Allow the retractor to completely rewind the seat belt by guiding latch plate ② (▷ page 50).

❗ Make sure the seat belt retracts completely. Otherwise the seat belt and/or latch plate could get caught or pinched in the door or in the seat mechanism. This can damage the seat belt and impair its effectiveness, and/or cause damage to the door and/or door trim panel. Such damage is not covered by the Mercedes-Benz Limited Warranty.



Damaged seat belts must be replaced. Contact an authorized Mercedes-Benz Center.



Enhanced seat belt reminder system

When the engine is started, the seat belt telltale  will always illuminate for 6 seconds to remind you and your passengers to fasten your seat belts.

If the driver's seat belt is not fastened when the engine is started, an additional warning chime will sound. The warning chime goes out after approximately 6 seconds or once the driver's seat belt is fastened.

If after these 6 seconds the driver's or the front passenger's seat belt (with the front passenger seat occupied) is not fastened with front doors closed,

- the seat belt telltale  remains illuminated for as long as either the driver's or front passenger's seat belt is not fastened.
- and if the vehicle speed once exceeds 15 mph (25 km/h), the seat belt telltale  starts flashing and a warning chime sounds with increasing intensity for a maximum of 60 seconds or until the driver's and front passenger's seat belt are fastened.

If you and/or your passenger release the seat belt during driving, the seat belt telltale  starts flashing and the warning chime sounds as described before. If the driver's or the front passenger's seat belt remains unfastened after 60 seconds, the warning chime stops sounding, the seat belt telltale  stops flashing but continues to be illuminated.

After a vehicle standstill, the warning chime is reactivated and the seat belt telltale  is flashing again if the vehicle speed once exceeds 15 mph (25 km/h).

The seat belt telltale  will only go out if both the driver's and the front passenger's seat belt (with the front passenger seat occupied) are fastened, or the vehicle is standing still and a front door is opened. For more information, see "Practical hints" (▷ page 301).

Emergency Tensioning Device (ETD), seat belt force limiter

The seat belts for the front seats and rear outer seats are equipped with ETDs and seat belt force limiters.

The ETDs are designed to activate in the following cases:

- in frontal or rear-end impacts exceeding the system's preset deployment threshold
- in side impacts exceeding the system's preset deployment threshold on the far side of the impact
- if the restraint systems are operational and functioning correctly, see "SRS indicator lamp" (▷ page 36)

The ETDs for the front seats will only activate if the front seat belts are fastened (latch plate properly inserted into buckle).

The ETDs for the rear seats will activate with or without the respective seat belts fastened.

In an impact, the ETDs remove slack from the seat belts in such a way that the seat belts fit more snugly against the body. Seat belt force

limiters, when activated, are employed to help reduce the peak force exerted by the seat belts on occupants during a crash.

i The ETDs do not correct an incorrect seat position or incorrectly worn seat belts.

The ETDs do not pull occupants back toward the seat backrest.

Warning!

Pyrotechnic ETDs that were activated must be replaced.

For your safety, when disposing of the pyrotechnic ETDs always follow our safety instructions. These are available at any authorized Mercedes-Benz Center.

NECK-PRO active front head restraints (except C 63 AMG)

The NECK-PRO active front head restraints are intended to offer the driver and front passenger increased protection from whiplash-type injuries. In the event of a rear-end collision, the NECK-PRO active front head restraints on the front seats are designed to move forward in the direction of travel. They thus provide the head with increased support earlier on in the collision sequence. The NECK-PRO active front head restraints will move forward whether the seats are occupied or not.

Warning!

Do not attach any objects (e.g. hangers) to the head restraint posts. Otherwise, the NECK-PRO active front head restraints may not be able to function properly or offer the intended degree of protection they were designed for in the event of a rear-end collision.

Warning!

Only use seat or head restraint covers which have been tested and approved by Mercedes-Benz for your vehicle model.

Using other seat or head restraint covers may interfere with or prevent the activation of the

NECK-PRO active front head restraints and/or the deployment of the front side impact air bags or pelvis air bags.

Contact an authorized Mercedes-Benz Center for availability.

When the NECK-PRO active front head restraints have been triggered in an accident, the NECK-PRO active front head restraints must be reset. Otherwise, the NECK-PRO active front head restraints cannot offer any additional protection in the event of another rear-end collision.

For information on resetting the activated NECK-PRO active front head restraints, see “Resetting activated head restraints” (▷ page 311).

You cannot remove the NECK-PRO active front head restraints.

Warning!

For your protection, drive only with properly positioned head restraints.

Adjust the head restraint so that it is as close to the head as possible and the center of the head restraint supports the back of the head at eye level. This will reduce the potential for injury to the head and neck in the event of an accident or similar situation.

For information on head restraint adjustment, see “Head restraint height” (▷ page 82), or see “Head restraint fore and aft adjustment” (▷ page 82).

Correct driver seat adjustment

Warning!

In order to avoid possible loss of vehicle control the following must be done before the vehicle is put into motion:

- seat adjustment
- head restraint adjustment
- steering wheel adjustment

- rear view mirror adjustment
- fastening of seat belts

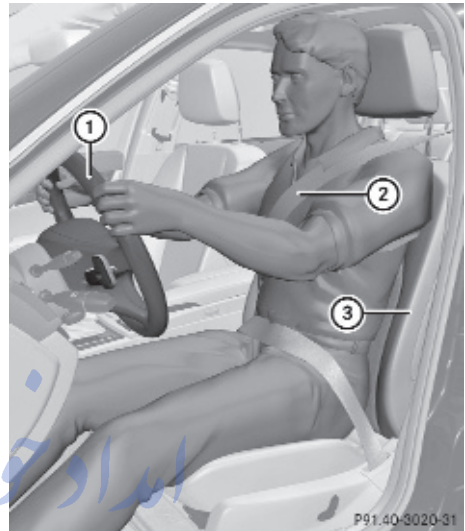

Steering wheel

Observe Safety notes, see page 84.

- Position steering wheel ① properly. See (▷ page 85) for manual adjustment and (▷ page 85) for electrical adjustment.

Make sure:

- You can reach the steering wheel with your arms slightly bent at the elbows.
- You can move your legs freely.
- All displays (including malfunction and indicator lamps) on the instrument cluster are clearly visible.

Seat belt

Observe Safety notes, see page 48.

- Fasten and position your seat belt ② correctly (▷ page 50).

Make sure:

- The seat belt is always fitted snugly.
- Adjust the seat belt so that the shoulder section is located as close as possible to the middle of the shoulder.
- Place the lap portion of the seat belt as low as possible on your hips.

Seat and head restraint

 **Observe Safety notes, see page 79.**

- ▶ Position seat ③ and head restraint properly. See (▶ page 80) for seat and head restraint adjustment.

Observe the following points:

- Always be in a properly seated position.
- The position should be as far rearward from the front air bag in the steering wheel as possible, while still permitting proper operation of vehicle controls.
- Adjust the seat to a comfortable seating position that still allows you to reach the accelerator/brake pedal safely.
- The seat must be adjusted so that you can correctly fasten and position your seat belt.
- The seat backrest must be in a position that is as nearly upright as possible.
- Adjust the seat cushion so that the front edge of the seat cushion lightly supports your legs.
- Adjust the head restraint so that it is as close to the head as possible and the center of the head restraint supports the back of the head at eye level.
- Never place hands under the seat or near any moving parts while the seat is being adjusted.

Children in the vehicle

Safety notes

If an infant or child is traveling with you in the vehicle:

- ▶ Secure the child using an infant or child restraint appropriate to the age and size of the child.
- ▶ Make sure the infant or child is properly secured at all times while the vehicle is in motion.

Warning!

When leaving the vehicle, always remove the SmartKey from the starter switch. Always take the SmartKey with you and lock the vehicle. Do not leave children unattended in the vehicle, even if they are secured in a child restraint system, or with access to an unlocked vehicle. A child's unsupervised access to a vehicle could result in an accident and/or serious personal injury. The children could

- injure themselves on parts of the vehicle
- be seriously or fatally injured through excessive exposure to extreme heat or cold
- injure themselves or cause an accident with vehicle equipment that can be operated even if the SmartKey is removed from the starter switch or removed from the vehicle, such as seat adjustment, steering wheel adjustment, or the memory function

If children open a door, they could injure other persons or get out of the vehicle and injure themselves or be injured by following traffic. Do not expose the child restraint system to direct sunlight. The child restraint system's metal parts, for example, could become very hot, and the child could be burned by these parts.

Warning!

Do not carry heavy or hard objects in the passenger compartment or trunk unless they are firmly secured in place.

Unsecured or improperly positioned cargo increases a child's risk of injury in the event of

- strong braking maneuvers
- sudden changes of direction
- an accident

Infant and child restraint systems

 **Observe Safety notes, see page 54.**

We recommend all infants and children be properly restrained at all times while the vehicle is in motion.

Canada only:

Only use a BabySmart™ compatible child restraint for the front passenger seat in this vehicle.

All lap/shoulder belts except the driver's seat belt have special seat belt retractors for secure fastening of child restraints.

To fasten a child restraint, follow the child restraint manufacturer's instructions for mounting.

To activate the special seat belt retractor:

- ▶ Pull the shoulder belt out completely and let it retract.
During seat belt retraction, a ratcheting sound can be heard to indicate that the special seat belt retractor is activated.
The seat belt is now locked.
- ▶ Push down on child restraint to take up any slack.

To deactivate the special seat belt retractor:

- ▶ Release the seat belt buckle and let the seat belt retract completely.
The seat belt can then again be used in the usual manner.

To deactivate the special seat belt retractor for the front passenger seat, the front passenger seat must be in the most backward position.

Warning!

Never release the seat belt buckle while the vehicle is in motion, since the special seat belt retractor will be deactivated.

- i** Information on child seats with mounting fittings for tether anchorages (▷ page 57).

For information on LATCH-type (ISOFIX) child seat anchors (▷ page 58).

The use of infant or child restraints is required by law in all 50 states, the District of Columbia, the U.S. territories and all Canadian provinces.

Infants and small children should be seated in an appropriate infant or child restraint system. They must be properly secured in accordance with the manufacturer's instructions for the child restraint. All infant or child restraint systems must comply with U.S. Federal Motor Vehicle Safety Standards 213 and 225 and Canadian Motor Vehicle Safety Standards 213 and 210.2.

A statement by the child restraint manufacturer of compliance with these standards can be found on the instruction label on the restraint and in the instruction manual provided with the restraint.

When using any infant restraint, toddler restraint, or booster seat, make sure to carefully read and follow all manufacturer's instructions for installation and use.

Please read and observe warning labels affixed to the inside of the vehicle and to infant or child restraints.

Warning!

According to accident statistics, children are safer when properly restrained in the rear seating positions than in the front seating position. Thus, we strongly recommend that children be placed in the rear seats whenever possible. Regardless of seating position, children 12 years old and under must be seated and properly secured in an appropriate





infant restraint, toddler restraint, or booster seat recommended for the size and weight of the child.

The infant or child restraint must be properly secured with the vehicle's seat belt, the seat belt and top tether strap, or lower anchors and top tether strap, fully in accordance with the child seat manufacturer's instructions.

Occupants, especially children, should always sit as upright as possible, wear the seat belt properly and use an appropriately sized infant restraint, toddler restraint, or booster seat recommended for the size and weight of the child.

Children can be killed or seriously injured by an inflating air bag. Note the following important information when circumstances require you to place a child in the front passenger seat:

- USA only: Your vehicle is equipped with air bag technology designed to deactivate the front passenger front air bag in your vehicle when the system senses the weight of a typical 12-month-old child or less along with the weight of a standard appropriate child restraint on the front passenger seat.
- USA only: For children larger than the typical 12-month-old child, the front passenger front air bag may or may not be activated. Always make sure the  indicator lamp is illuminated, indicating that the front passenger front air bag is deactivated.
- Canada only: Children 12 years old and under must never ride in the front seat, except in a Mercedes-Benz authorized BabySmart™ compatible child seat, which operates with the BabySmart™ system installed in the vehicle to deactivate the front passenger front air bag when it is installed properly. Otherwise they will be struck by the air bag when it inflates in a crash. If this happens, serious or fatal injury will result.

- A child in a rear-facing child restraint on the front passenger seat will be seriously injured or even killed if the front passenger front air bag inflates in a collision which could occur under some circumstances, even with the air bag technology installed in your vehicle. The only means to completely eliminate this risk is to never place a child in a rear-facing child restraint in the front seat. We therefore strongly recommend that you always place a child in a rear-facing child restraint in a backseat.
- If you must install a rear-facing child restraint on the front passenger seat because circumstances require you to do so, make sure the  indicator lamp is illuminated, indicating that the front passenger front air bag is deactivated. Should the  indicator lamp not illuminate or go out while the restraint is installed, please check installation. Periodically check the  indicator lamp while driving to make sure the  indicator lamp is illuminated. If the  indicator lamp goes out or remains out, do not transport a child on the front passenger seat until the system has been repaired.

A child in a rear-facing child restraint on the front passenger seat will be seriously injured or even killed if the front passenger front air bag inflates.

- If you have to place a child in a forward-facing child restraint on the front passenger seat, move the seat as far back as possible, use the proper child restraint recommended for the age, size and weight of the child, and secure child restraint with the vehicle's seat belt according to the child seat manufacturer's instructions.

Warning!

Infants and small children should never share a seat belt with another occupant. During an accident, they could be crushed between the occupant and seat belt.

A child's risk of serious or fatal injuries is significantly increased if the child restraints are not properly secured in the vehicle and/or the child is not properly secured in the child restraint.

Children too big for a toddler restraint must ride in seats using regular seat belts. Position shoulder belt across chest and shoulder, not face or neck. A booster seat may be necessary to achieve proper seat belt positioning for children over 41 lb (18 kg) until they reach a height where a lap/shoulder belt fits properly without a booster.

When the child restraint is not in use, remove it from the vehicle or secure it with the seat belt to prevent the child restraint from becoming a projectile in the event of an accident.

Installation of infant and child restraint systems

 **Observe Safety notes, see page 54.**

Warning!

Always lock the seat backrests in their upright position when the rear seats are occupied by passengers. Lock the seat backrests in their upright position before installing top tether straps or when the extended cargo compartment is not in use. Make sure that seat backrests are secured properly by pushing and pulling on the seat backrests. If a seat backrest is not locked properly, the seat backrest could fold. The child seat would no longer be supported properly or positioned to provide its intended benefit. That could cause serious or even fatal injuries.

This vehicle is equipped with tether anchorages for a top tether strap at each of the rear seating positions.

Top tether straps enable an additional connection to be made between child restraint systems secured with LATCH-type (ISOFIX) anchors and rear seats. This can further reduce the risk of injury.

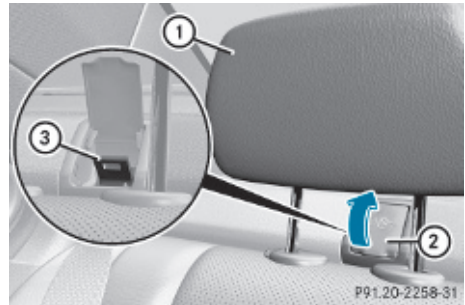

- ▶ Move the respective head restraint ① to its uppermost position (▷ page 83).
- ▶ Lift up anchorage ring cover ② from anchorage ring ③.

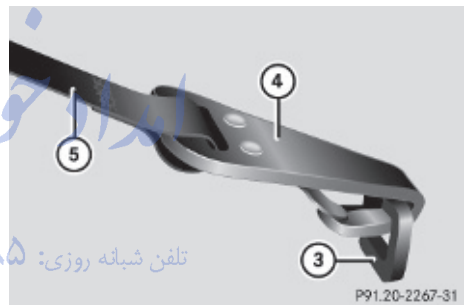

- ▶ Guide top tether strap ⑤ between head restraint ① and top of the seat backrest.
- ▶ Securely fasten hook ④, which is part of top tether strap ⑤, to anchorage ring ③.

Make sure

- hook ④ is attached to anchorage ring ③ beyond the safety catch, as illustrated
- top tether strap ⑤ is not twisted
- head restraint ① is installed (if removable) and positioned such that top tether strap ⑤ can pass freely between head restraint ① and top of the seat backrest
- ▶ Lower head restraint ① if necessary (▷ page 83).

Once hook ④ is attached, the child restraint itself can be secured.

- ▶ Install the child restraint system and tighten top tether strap ⑤ according to the child restraint manufacturer's instructions.

After removing the child restraint system and top tether strap ⑤:

- ▶ Pull down and close anchorage ring cover ② from respective anchorage ring ③.

Child seat anchors – LATCH-type (ISOFIX)

 **Observe Safety notes, see page 54.**

Warning!

Children too big for a toddler restraint must ride in seats using regular seat belts. Position shoulder belt across chest and shoulder, not face or neck.

A booster seat may be necessary to achieve proper seat belt positioning for children over 41 lb (18 kg) until they reach a height where a lap/shoulder belt fits properly without a booster.

Install child seat according to manufacturer's instructions.

The child seat must be firmly attached to both anchors.

An incorrectly mounted child seat may come loose during an accident which could result in serious injury or death to the child.

Damaged or impact damaged child seats or child seat mounting fittings must be replaced.

Each rear outer seat has two LATCH-type (ISOFIX) anchors for the installation of a LATCH-type (ISOFIX) child seat with matching mounting fittings.

Non-LATCH-type (ISOFIX) child seats may also be used and can be installed using the vehicle's seat belt system. Install child seat according to the manufacturer's instructions.

Vehicles with non-foldable rear bench seat: The LATCH-type (ISOFIX) anchors are blended with covers. Vehicles with split rear bench seat: The LATCH-type (ISOFIX) anchors are located between the seat cushion and the backrest.

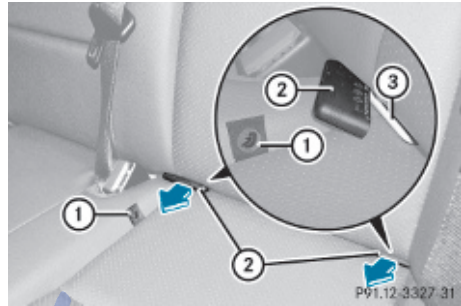

Non-foldable rear bench seat

Information sign ① indicates the position of anchor ③.

- ▶ Remove anchorage ring covers ② from anchors ③ by pulling it in direction of arrow.
- ▶ Store anchorage ring covers ②, for example in the storage compartment of the rear center armrest.

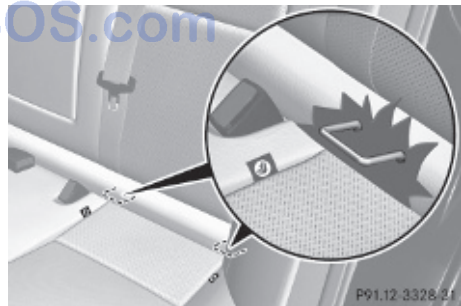

Split rear bench seat, child seat anchors

- ▶ Install a LATCH-type (ISOFIX) child seat according to the manufacturer's instructions.
A rigid connection between the child seat and the body of the vehicle is established.
- ▶ Make sure that the seat belt for the rear center seat can operate freely with a child seat installed.

Child safety

Child safety locks

 **Observe Safety notes, see page 54.**

 **Warning!**

Children could open a rear door from the inside. This may cause serious personal injury or an accident. Therefore, secure the rear doors with the child safety locks whenever children are riding in the back seats of the vehicle.

The child safety locks on the rear doors enable you to secure each rear door individually. You cannot open a secured rear door from the inside. You can open the rear door from the outside when the vehicle is unlocked.

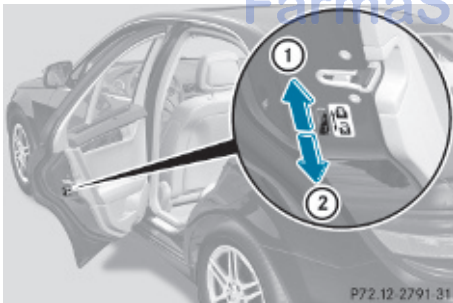

- ▶ **Securing:** Press the lever up in direction of arrow ①.
- ▶ Check to make sure the child safety locks are working properly.
- ▶ **Releasing:** Press the lever down in direction of arrow ②.

Override switch

 **Observe Safety notes, see page 54.**

With the override switch you can disable the rear door window switches in the rear door panels. This can be useful, for instance, when you have children riding in the rear passenger compartment.

 **Warning!**

Activate the override switch when children are riding in the back seats of the vehicle. The children may otherwise injure themselves, e.g. by becoming trapped in the rear door window opening.



- ▶ **Activating:** Press override switch ①. Indicator lamp ② comes on.

The rear door windows can no longer be operated using the respective switch located in the rear doors.

You can still operate the rear door windows using the switches located on the door control panel of the driver's door.

- ▶ **Deactivating:** Press override switch ① again.

The rear door windows can be operated again using the respective switch located in the rear doors.

For more information on power windows, see the "Controls in detail" section (▷ page 98).

Panic alarm



- ▶ **Activating:** Press and hold **PANIC** button ① for at least 1 second. An audible alarm and flashing exterior lamps will operate.
 - ▶ **Deactivating:** Press **PANIC** button ① again.
- or
- ▶ Insert the SmartKey into the starter switch.
- or
- ▶ Press the KEYLESS-GO start/stop button. The SmartKey with KEYLESS-GO must be inside the vehicle.

i USA only:

This device complies with Part 15 of the FCC Rules. Operation is subject to the following two conditions:

1. This device may not cause harmful interference, and
2. this device must accept any interference received, including interference that may cause undesired operation.

Any unauthorized modification to this device could void the user's authority to operate the equipment.

i Canada only:

This device complies with RSS-210 of Industry Canada. Operation is subject to the following two conditions:

1. This device may not cause interference, and
2. this device must accept any interference received, including interference that may cause undesired operation of the device.

Any unauthorized modification to this device could void the user's authority to operate the equipment.

Driving safety systems

Introduction

This section contains information about the following driving safety systems:

- ABS (Antilock Brake System)
- Adaptive Brake
- BAS (Brake Assist System)
- EBK (Electronic Brake Proportioning)
- ESP® (Electronic Stability Program)

- i** In winter operation, the maximum effectiveness of most of the driving systems described in this section is only achieved with winter tires, or snow chains as required.

Safety notes

⚠ Warning!

The following factors increase the risk of accidents:

- Excessive speed, especially in turns
- Wet and slippery road surfaces
- Following another vehicle too closely

The driving safety systems described in this section cannot reduce these risks or prevent the natural laws of physics from acting on the

vehicle. They cannot increase braking or steering efficiency beyond that afforded by the condition of the vehicle brakes and tires or the traction afforded.

Only a safe, attentive, and skillful driver can prevent accidents.

The capabilities of a vehicle equipped with the driving safety systems described in this section must never be exploited in a reckless or dangerous manner which could jeopardize the user's safety or the safety of others.

Always adjust your driving style to the prevailing road and weather conditions and keep a safe distance to other road users and objects on the street.

If a driving system malfunctions, other driving safety systems may also switch off. Observe indicator and warning lamps that may come on as well as messages in the multifunction display that may appear.

ABS

 **Observe Safety notes, see page 60.**

Warning!

Do not pump the brake pedal. Use firm, steady brake pedal pressure instead. Pumping the brake pedal defeats the purpose of the ABS and significantly reduces braking effectiveness.

The Antilock Brake System (ABS) regulates the brake pressure so that the wheels do not lock during braking. This allows you to maintain the ability to steer your vehicle.

The ABS is functional above a speed of approximately 5 mph (8 km/h) independent of road surface conditions.

On slippery road surfaces, the ABS will respond even to light brake pressure.

The ABS indicator lamp  in the instrument cluster comes on when you switch on the ignition. It goes out when the engine is running.

Braking

At the instant one of the wheels is about to lock up, a slight pulsation can be felt in the brake pedal. The pulsation indicates that the ABS is in the regulating mode.

► Keep firm and steady pressure on the brake pedal while you feel the pulsation.

Continuous, steady brake pedal pressure yields the advantages provided by the ABS, namely braking power and the ability to steer the vehicle.

The pulsating brake pedal can be an indication of hazardous road conditions and functions as a reminder to take extra care while driving.

Emergency brake maneuver

► Keep continuous full pressure on the brake pedal.

Warning!

If the ABS malfunctions, other driving safety systems such as the BAS or the ESP® are also switched off. Observe indicator and warning lamps that may come on as well as messages in the multifunction display that may appear.

If the ABS malfunctions, the wheels may lock during hard braking, reducing steering capability and extending the braking distance.

BAS

 **Observe Safety notes, see page 60.**

The Brake Assist System (BAS) operates in emergency situations. If you apply the brakes very quickly, the BAS provides full brake boost automatically, thereby potentially reducing the braking distance.

► Apply continuous full braking pressure until the emergency braking situation is over. The ABS will prevent the wheels from locking.

When you release the brake pedal, the brakes function again as normal. The BAS is then deactivated.

Warning!

If the BAS malfunctions, the brake system still functions, but without the additional brake boost available that the BAS would normally provide in an emergency braking maneuver. Therefore, the braking distance may increase.

Adaptive Brake

Adaptive Brake provides a high level of braking safety as well as increased braking comfort. Adaptive Brake takes driver and vehicle characteristics into consideration, thus achieving an optimal braking effect. In addition, Adaptive Brake provides the hill-start assist system (▷ page 183). For more information on the brake system, see (▷ page 255).

EBP

Observe Safety notes, see page 60.

The Electronic Brake Proportioning (EBP) enhances braking effectiveness by allowing the rear brakes to supply a greater proportion of the braking effort in straight-line braking without a loss of vehicle stability.

Warning!

If the EBP malfunctions, the brake system will still function with full brake boost. However, the rear wheels could lock up during emergency braking situations, for example. You could lose control of the vehicle and cause an accident.

Adapt your driving style to the changed driving characteristics.

ESP®

Observe Safety notes, see page 60.

The Electronic Stability Program (ESP®) is operational as soon as the engine is running. It monitors the vehicle's traction (force of adhesive friction between the tires and the road surface) and handling.

The ESP® recognizes that the vehicle deviates from the direction of travel as intended by the driver. By applying brakes to individual wheels and by limiting the engine output, the ESP® works to stabilize the vehicle. The ESP® is especially useful while driving off and on wet or slippery road surfaces. The ESP® also stabilizes the vehicle during braking and steering maneuvers.

The ESP® warning lamp  in the instrument cluster comes on when you switch on the ignition. It goes out when the engine is running.

The ESP® warning lamp  in the instrument cluster flashes when the ESP® is engaged. *تلفن شماره رو.*

Warning!

Never switch off the ESP® when you see the ESP® warning lamp  flashing in the instrument cluster. In this case proceed as follows:

- When driving off, apply as little throttle as possible.
- While driving, ease up on the accelerator pedal.
- Adapt your speed and driving style to the prevailing road conditions.

Failure to observe these guidelines could cause the vehicle to skid. The ESP® cannot prevent accidents resulting from excessive speed.

i Vehicle status messages in the multifunction display (▷ page 270) will refer to the ESP® as ESC.

! Vehicles with 4MATIC:

Only conduct operational or performance tests on a two-axle dynamometer. If such tests are necessary, contact an authorized Mercedes-Benz Center. You could otherwise seriously damage the brake system or the transfer case which is not covered by the Mercedes-Benz Limited Warranty.

! Vehicles with 4MATIC:

Because the ESP® operates automatically, the engine and ignition must be shut off (SmartKey in starter switch position **0** or **1** or KEYLESS-GO start/stop button in position **0** or **1**) when the parking brake is being tested on a brake test dynamometer.

Active braking action through the ESP® may otherwise seriously damage the brake system which is not covered by the Mercedes-Benz Limited Warranty.

! Vehicles without 4MATIC:

Because the ESP® operates automatically, the engine and ignition must be shut off (SmartKey in starter switch position **0** or **1** or KEYLESS-GO start/stop button in position **0** or **1**) when the parking brake is being tested on a brake test dynamometer or the vehicle is being towed with the front axle raised.

Active braking action through the ESP® may otherwise seriously damage the brake system which is not covered by the Mercedes-Benz Limited Warranty.

! The ESP® will only function properly if you use wheels of the recommended tire size as specified in the “Technical data” section of this Operator’s Manual.**i** The cruise control switches off automatically when the ESP® engages.**Electronic Traction System (ETS/4-ETS)****⚠ Observe Safety notes, see page 60.**

The ETS (Electronic Traction System) and 4-ETS (four-wheel Electronic Traction System, vehicles with 4MATIC only) are components of the ESP®. The ETS/4-ETS improves the vehicle’s ability to utilize available traction, especially under slippery road conditions by applying the brakes to a spinning wheel. Vehicles with 4MATIC also transfer more power to the wheel(s) with traction.

When you switch off the ESP®, the ETS/4-ETS is still enabled.

Switching the ESP® off or on (except C 63 AMG)**⚠ Warning!**

The ESP® should not be switched off during normal driving other than in the circumstances described below. Disabling the system will reduce vehicle stability in driving maneuvers.

Do not switch off the ESP® when a spare wheel is mounted.

To improve the vehicle’s traction, switch off the ESP®. This allows the drive wheels to spin and thus cut into surfaces for better grip, for example

- when driving with snow chains
- in deep snow
- in sand or gravel

⚠ Warning!



Switch on the ESP® immediately if the aforementioned circumstances do not apply anymore. Otherwise the ESP® will not stabilize the vehicle when it is starting to skid or a wheel is spinning.

When you switch off the ESP[®],

- the ESP[®] will not stabilize the vehicle
- the engine output is not limited, which allows the drive wheels to spin and thus cut into surfaces for better grip
- the ETS/4-ETS will still apply the brakes to a spinning wheel
- the ESP[®] continues to operate when you are braking
- the cruise control cannot be activated
- the cruise control switches off if activated

i When the ESP[®] is switched off and one or more drive wheels are spinning, the ESP[®] warning lamp  in the instrument cluster flashes. However, the ESP[®] will then not stabilize the vehicle.





► **Switching off:** With the engine running, press ESP[®] switch  until the ESP[®] warning lamp  in the instrument cluster comes on. The ESP[®] is switched off.

Warning!

When the ESP[®] warning lamp  is illuminated continuously, the ESP[®] is switched off or is not operational due to a malfunction. Vehicle stability in standard driving maneuvers is reduced.

Adapt your speed and driving to the prevailing road conditions and to the non-operating status of the ESP[®].

! Avoid spinning of a drive wheel for an extended period with the ESP[®] switched off. This may cause serious damage to the drivetrain which is not covered by the Mercedes-Benz Limited Warranty.

► **Switching on:** Press ESP[®] switch  until the ESP[®] warning lamp  in the instrument cluster goes out. You are now again in normal driving mode with the ESP[®] switched on.

C 63 AMG

Switching ESP[®] SPORT on or off

Warning!

ESP[®] SPORT should not be switched on during normal driving.

Switching ESP[®] SPORT on will result in the following:

- no restriction to engine torque
- system-supported traction control is limited

ESP[®] SPORT is designed for driving on closed tracks when the vehicle's natural oversteer and understeer characteristics are desired and requires a highly skilled and experienced driver able to handle these critical driving situations.

You could lose control of your vehicle and cause an accident.

Please be aware of these limits when you switch on ESP[®] SPORT.

Do not switch on ESP[®] SPORT when a spare wheel is mounted.

To improve the vehicle's traction, switch on ESP[®] SPORT. This allows the drive wheels to spin and thus cut into surfaces for better grip, for example

- when driving with snow chains
- in deep snow
- in sand or gravel

⚠ Warning!



Switch off ESP® SPORT and switch on the ESP® immediately if the aforementioned circumstances do not apply anymore. Otherwise ESP® SPORT will only stabilize the vehicle to a limited extent when it is starting to skid or a wheel is spinning.

When you switch on ESP® SPORT



- the ESP® stabilizes the vehicle only to a limited extent
- the engine output is limited, but only to the extent that allows the drive wheels to spin and thus cut into surfaces for better grip
- the ETS will still apply the brakes to a spinning wheel
- the ESP® continues to operate when you are braking hard
- the cruise control cannot be activated
- the cruise control switches off if activated

- i** When ESP® SPORT is switched on and one or more drive wheels are spinning, the ESP® warning lamp  in the instrument cluster flashes. However, the ESP® will then stabilize the vehicle only to a limited extent.



- Switching on:** With the engine running, press ESP® SPORT switch  briefly. The ESP® warning lamp  in the instrument cluster comes on. The message

ESC-SPORT appears in the multifunction display.

- Switching off:** With the engine running, press ESP® SPORT switch  briefly. The ESP® warning lamp  in the instrument cluster goes out. The message ESC-ON appears in the multifunction display.

ESP® SPORT switches off automatically when you turn off the engine. When starting the engine, the ESP® is activated automatically.

- i** Vehicle status messages in the multifunction display (▷ page 270) will refer to the ESP® as ESC.

Switching the ESP® off or on**⚠ Warning!**

The ESP® should not be switched off during normal driving.

Disabling of the system will result in the following:

- no restriction to engine torque
- loss of system-supported traction control

“ESP® OFF” is designed for driving on closed tracks when the vehicle’s natural oversteer and understeer characteristics are desired and requires a highly skilled and experienced driver able to handle these critical driving situations.

You could lose control of your vehicle and cause an accident.

Please be aware of these limits when you switch off the ESP®.

Do not switch off the ESP® when a spare wheel is mounted.

To improve the vehicle’s traction, switch off the ESP®. This allows the drive wheels to spin and thus cut into surfaces for better grip, for example

- when driving with snow chains
- in deep snow
- in sand or gravel

⚠ Warning!



Switch on the ESP® immediately if the aforementioned circumstances do not apply anymore. Otherwise the ESP® will not stabilize the vehicle when it is starting to skid or a wheel is spinning.

When you switch off the ESP®,

- the ESP® will not stabilize the vehicle
- the engine output is not limited, which allows the drive wheels to spin and thus cut into surfaces for better grip
- the ETS will still apply the brakes to a spinning wheel
- the ESP® continues to operate when you are braking hard
- the cruise control cannot be activated
- the cruise control switches off if activated



- i** When the ESP® is switched off and one or more drive wheels are spinning, the ESP® warning lamp  in the instrument cluster does not flash. The ESP® will then not stabilize the vehicle.



- **Switching off:** With the engine running, press ESP® SPORT switch ① until the ESP® warning lamp  and the ESP OFF warning lamp  in the instrument cluster come on. The message ESC-OFF appears in the multifunction display.



- i** Vehicle status messages in the multifunction display (▷ page 270) will refer to the ESP® as ESC.

⚠ Warning!

When the ESP® warning lamp  and the ESP® OFF warning lamp  are illuminated continuously, the ESP® is switched off. Vehicle stability in standard driving maneuvers is reduced.

Adapt your speed and driving to the prevailing road conditions and to the non-operating status of the ESP®.

- !** Avoid spinning of a drive wheel for an extended period with the ESP® switched off. This may cause serious damage to the drivetrain which is not covered by the Mercedes-Benz Limited Warranty.

- **Switching on:** With the engine running, press ESP® SPORT switch ① briefly. The ESP® warning lamp  and the ESP® OFF warning lamp  in the instrument cluster go out. The message ESC-ON appears in the multifunction display.

Anti-theft systems

Immobilizer

The immobilizer prevents unauthorized persons from starting your vehicle.

When leaving the vehicle, always take the SmartKey with you and lock the vehicle. The engine can be started by anyone with a valid SmartKey that is left inside the vehicle.

Activating

- **With SmartKey:** Remove the SmartKey from the starter switch.
- **With KEYLESS-GO:** Turn off the engine and open the driver's door.

Deactivating

► Switch on the ignition.

i Starting the engine will also deactivate the immobilizer.

In the event that the engine cannot be started (yet the vehicle's battery is charged), the system is not operational. Contact an authorized Mercedes-Benz Center or call 1-800-FOR-MERCEDES (in the USA) or 1-800-387-0100 (in Canada).

Anti-theft alarm system

Once the alarm system has been armed, a visual and audible alarm is triggered when someone opens

- a door
- the trunk
- the hood

The alarm will stay on even if the activating element, a door, for example, is closed immediately.

The alarm system will also be triggered when

- the vehicle is opened with the mechanical key
- a door is opened from the inside
- the trunk is opened with the emergency release button

To cancel the alarm after it has been triggered, see "Canceling the alarm" (► page 68).

i If the alarm stays on for more than 30 seconds, the Tele Aid system initiates a call to the Customer Assistance Center automatically. The Tele Aid system will initiate the call provided that

- you have subscribed to the Tele Aid service
- the Tele Aid service has been activated properly
- the necessary mobile phone, power supply and GPS coverage are available



► **Arming:** Lock the vehicle with the SmartKey or with KEYLESS-GO.

The turn signal lamps flash three times and an acoustic warning sounds three times to indicate that the vehicle is locked. Indicator lamp **1** flashes to indicate that the alarm system is armed.

i If the turn signal lamps do not flash three times and the acoustic warning does not sound three times, a door or the trunk may not be properly closed.



Close the respective element.

► **Disarming:** Unlock the vehicle with the SmartKey or with KEYLESS-GO. The turn signal lamps flash once and an acoustic warning sounds once to indicate that the alarm system is disarmed.

- i** Unless you open a door or the trunk within approximately 40 seconds after unlocking the vehicle:
- The vehicle will be locked again.
 - The anti-theft alarm system will be rearmed.

Canceling the alarm

To cancel the alarm, do one of the following:

- ▶ Insert the SmartKey into the starter switch.
- ▶ Press button  or  on the SmartKey.

In vehicles with KEYLESS-GO:

- ▶ Grasp an outside door handle.
The SmartKey must be within 3 ft (1 m) of the vehicle.
- ▶ Press the KEYLESS-GO start/stop button.
The SmartKey must be inside the vehicle.

تلفن شبانه روزی: ۰۲۱-۸۸۸۶۲۰۸۵

FarmaSOS.com

Vehicle equipment	70
Locking and unlocking	70
Starter switch positions	77
Seats	79
Multifunction steering wheel	84
Mirrors	86
Memory function	89
Lighting	90
Wipers	96
Power windows	98
Driving and parking	101
Manual transmission	107
Automatic transmission	108
Transfer case	116
Instrument cluster	116
Control system	118
Audio system	136
Driving systems	180
Climate control system	189
Rear window defroster	196
Power tilt/sliding sunroof	196
Panorama roof with power tilt/ sliding panel	199
Loading and storing	202
Useful features	207



ایزاد خودرو فارما

۰۲۱-۸۸۸۶۲۰۸۵

FarmaSO.com

Vehicle equipment

i This Operator's Manual describes all features, standard or optional, potentially available for your vehicle at the time of purchase. Please be aware that your vehicle might not be equipped with all features described in this manual.

Locking and unlocking

Notes

⚠ Observe Safety notes, see page 54.

When unlocking or locking the vehicle with the SmartKey an acoustic signal sounds. The acoustic signal is activated at the factory. If you wish to deactivate the feature, or adjust its signal volume, contact an authorized Mercedes-Benz Center.

When unlocking the vehicle, all turn signal lamps flash once. An acoustic signal sounds once, and the locking knobs in the doors move up. The anti-theft alarm system is disarmed.

When locking the vehicle, all turn signal lamps flash three times. An acoustic signal sounds three times, and the locking knobs in the doors move down. The anti-theft alarm system is armed.

All doors and the trunk must be closed.

If you cannot lock or unlock the vehicle with the SmartKey, the batteries in the SmartKey are discharged, the SmartKey is malfunctioning, or the vehicle battery is drained.

- ▶ Check the batteries in the SmartKey (▷ page 73) and replace them if necessary.
- ▶ Use the mechanical key to unlock the driver's door and the trunk (▷ page 309).

▶ Use the mechanical key to lock the vehicle (▷ page 310).

▶ Have the vehicle battery and the vehicle battery connections checked at an authorized Mercedes-Benz Center.

If the SmartKey is malfunctioning, contact Roadside Assistance or an authorized Mercedes-Benz Center.

SmartKey

Your vehicle comes supplied with two SmartKeys, each with remote control and a removable mechanical key.

The SmartKey centrally locks and unlocks

- the doors
- the trunk lid
- the fuel filler flap



- ① Lock button
- ② Unlock button for trunk lid
- ③ Unlock button

i USA only:

This device complies with Part 15 of the FCC Rules. Operation is subject to the following two conditions:

1. This device may not cause harmful interference, and
2. this device must accept any interference received, including interference that may cause undesired operation.

Any unauthorized modification to this device could void the user's authority to operate the equipment.

i Canada only:

This device complies with RSS-210 of Industry Canada. Operation is subject to the following two conditions:

1. This device may not cause interference, and
2. this device must accept any interference received, including interference that may cause undesired operation of the device.

Any unauthorized modification to this device could void the user's authority to operate the equipment.

Factory setting

► **Global unlocking:** Press button .



Unless you open a door or the trunk within approximately 40 seconds after unlocking the vehicle:

- The vehicle will be locked again.
- The anti-theft alarm system will be rearmed.

► **Global locking:** Press button .

Selective setting

If you frequently travel alone, you may wish to reprogramm the SmartKey. Pressing button  will then only unlock the driver's door and the fuel filler flap.

► **Switching on/off:** Press and hold buttons  and  simultaneously for approximately 6 seconds until the battery check lamp (▷ page 73) flashes twice.

The SmartKey will then function as follows:

► **Unlocking driver's door and fuel filler flap:** Press button  once.

► **Global unlocking:** Press button  twice.

► **Global locking:** Press button .

KEYLESS-GO

Vehicles equipped with KEYLESS-GO come with two SmartKeys with KEYLESS-GO, each with remote control and a removable mechanical key.

The KEYLESS-GO function is integrated into the SmartKey. The validity of the SmartKey is checked every time you grasp an outside door handle.

When the SmartKey is valid, your vehicle unlocks

- the doors
- the trunk lid
- the fuel filler flap

i USA only: تلفن

This device complies with Part 15 of the FCC Rules. Operation is subject to the following two conditions:

1. This device may not cause harmful interference, and
2. this device must accept any interference received, including interference that may cause undesired operation.

Any unauthorized modification to this device could void the user's authority to operate the equipment.

i Canada only:

This device complies with RSS-210 of Industry Canada. Operation is subject to the following two conditions:

1. This device may not cause interference, and
2. this device must accept any interference received, including interference that may cause undesired operation of the device.

Any unauthorized modification to this device could void the user's authority to operate the equipment.

Important notes on using KEYLESS-GO

- You can also use the SmartKey with KEYLESS-GO like a normal SmartKey (> page 70).
- You can combine KEYLESS-GO functions with normal SmartKey functions (e.g. unlocking with KEYLESS-GO and locking with button ).
- Always carry the SmartKey with you.
- Never store the SmartKey together with
 - electronic items such as a mobile phone or another SmartKey
 - metallic objects such as coins or metal foil
 Doing so could impair the function of the KEYLESS-GO system.
- To lock or unlock the vehicle, the SmartKey must be located outside the vehicle within approximately 3 ft (1 m) of a door or the trunk.
- When the vehicle has been parked for more than 72 hours, the KEYLESS-GO function is deactivated. Pull an outside door handle and switch on the ignition once to activate the KEYLESS-GO function.
- If the SmartKey is positioned farther away from the vehicle, the system may no longer recognize the SmartKey. The vehicle

cannot be locked or the engine started via the KEYLESS-GO system.

- If the SmartKey is removed from the vehicle (e.g. if a passenger exits the vehicle with the SmartKey)
 - when pressing the KEYLESS-GO start/stop button or trying to lock the vehicle with the outside door handle the message **Key Not Detected** appears in the multifunction display
 - with the engine running, the red message **Key Not Detected** appears in the multifunction display while driving off

Find the SmartKey or change its present location immediately (e.g. place it on the front passenger seat or insert it in shirt pocket).

- If you have started the engine with the KEYLESS-GO start/stop button, you can turn it off again by
 - pressing the KEYLESS-GO start/stop button
 - inserting the SmartKey into the starter switch when the vehicle is at a standstill and the automatic transmission is in park position **P**
 - The vehicle could be inadvertently unlocked if the SmartKey is within 3 ft (1 m) of the vehicle and
 - an outside door handle is splashed with water
 - or
 - you attempt to clean an outside door handle
 - Remember that the engine can be started by anyone with a SmartKey that is left inside the vehicle.
- Possibility 1** (One SmartKey in the vehicle, one SmartKey outside the vehicle):
- If you leave the SmartKey behind when exiting and locking the vehicle, no message appears in the multifunction display.

Possibility 2 (One SmartKey in the vehicle, no SmartKey outside the vehicle):

When exiting and trying to lock the vehicle, the message **Key Detected in Vehicle** appears in the multifunction display. The vehicle will not be locked.

Factory setting

► **Global unlocking:** Grasp an outside door handle.

Unless you open a door or the trunk within approximately 40 seconds after unlocking the vehicle:

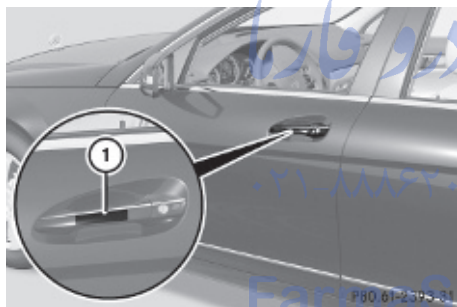

- The vehicle will be locked again.
- The anti-theft alarm system will be rearmed.



► **Global locking:** Touch outside of a door handle ①.

Selective setting

If you frequently travel alone, you may wish to reprogram the SmartKey. Grasping the driver's outside door handle will then only unlock the driver's door and the fuel filler flap.

► **Switching on/off:** Press and hold buttons  and  simultaneously for approximately 6 seconds until the battery check lamp (> page 73) flashes twice.

KEYLESS-GO will then function as follows:

► **Unlocking driver's door and fuel filler flap:** Grasp the driver's outside door handle.

► **Global unlocking:** Grasp any outside door handle other than the driver's outside door handle.

► **Global locking:** Touch outside of a door handle ①.

Checking SmartKey batteries

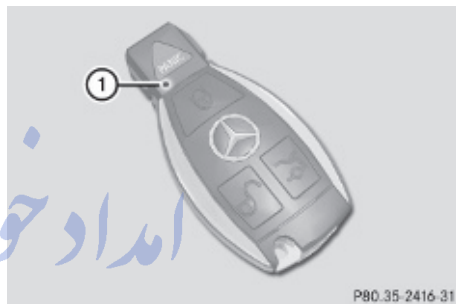



► Press button  or  on the SmartKey.

Battery check lamp ① comes on briefly to indicate that the SmartKey batteries are in order.

If the battery check lamp does not come on briefly during check, the SmartKey batteries are discharged.

► Replace the batteries (> page 312).

i You can obtain the required batteries at any authorized Mercedes-Benz Center.

i If the batteries are checked within signal range of the vehicle, pressing button  or  will lock or unlock the vehicle accordingly.

Loss of the SmartKey

If you lose your SmartKey or mechanical key, you should do the following:

- ▶ Have the SmartKey deactivated by an authorized Mercedes-Benz Center.
- ▶ Report the loss of the SmartKey or the mechanical key to your car insurance company immediately.
- ▶ Have the mechanical lock replaced if necessary.

Any authorized Mercedes-Benz Center will be glad to supply you with a replacement. For information on replacing the SmartKey, see “Replacing the SmartKey” (▷ page 74).

Replacing the SmartKey

Only you, or someone authorized by you can order a replacement key from any Mercedes-Benz Center. In order to do so, the Mercedes-Benz Center will require proof of identity and vehicle ownership with original documents, including the following:

If you are the current owner of the vehicle:

- the vehicle’s current state registration
- a current identity card, passport, or drivers license

If you are an authorized person:

- the vehicle’s current state registration
- a current identity card, passport, or drivers license for the authorized individual
- signed and dated authorization from the owner of the vehicle for which the key is being requested

i Duplicated or photocopied documentation will not be accepted.

Activating the key

Once you, or an authorized person, has provided the appropriate documents, the Mercedes-Benz Center will need to synchronize the key to your vehicle before it can be used. In order to do so, the Mercedes-Benz Center need access to your vehicle.

Opening the doors from the inside

You can open a door from the inside even when it is locked unless it is secured with the child safety lock (▷ page 59).

Open door only when conditions are safe to do so.

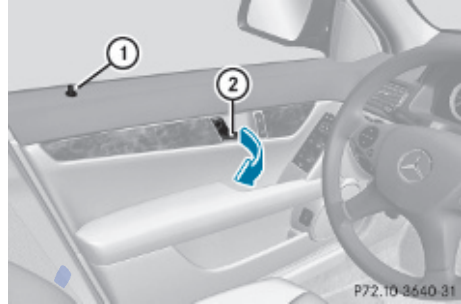

Example illustration driver’s door

If the vehicle has previously been locked with the SmartKey or with KEYLESS-GO, opening a door from the inside will trigger the anti-theft alarm system.

To cancel the alarm, see (▷ page 68).

- ▶ **Front doors:** Pull on inside door handle ② on the respective front door.

If the door was locked, locking knob ① will move up.

- ▶ **Rear doors:** Pull up locking knob on the respective rear door to unlock door.
- ▶ Pull on the inside door handle on the respective rear door.

Automatic central locking

The doors and the trunk lock automatically when the vehicle is set into motion.

You can open a locked front door from the inside. Open door only when conditions are safe to do so.

The doors are designed to unlock automatically after an accident if the force of the impact exceeds a preset threshold.

The vehicle locks automatically when the ignition is switched on and the wheels are

turning at a vehicle speed of above 9 mph (15 km/h). You could therefore lock yourself out when the vehicle is pushed or towed or is on a test stand.

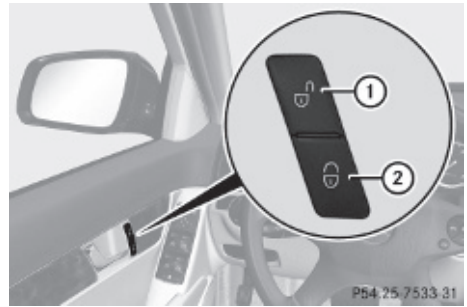
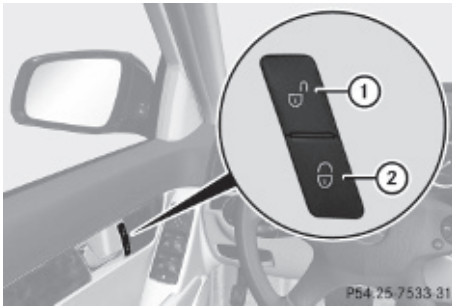

► **Switching off:** Press and hold central unlocking switch ① until an acoustic signal sounds.

► **Switching on:** Press and hold central locking switch ② until an acoustic signal sounds.

- ❗ If you press and hold either switch and no acoustic signal sounds, the respective setting has already been selected.
- ❗ You can also switch on or off the automatic central locking using the control system (▷ page 135).

► **Locking:** Press central locking switch ②. When the front passenger door is closed, the vehicle locks.

► **Unlocking:** Press central unlocking switch ①.

You can open a locked front door from the inside. Open door only when conditions are safe to do so.

If the vehicle was previously locked with the central locking switch

- and the SmartKey is set to factory settings, the complete vehicle is unlocked when a front door is opened from the inside
- and the SmartKey is set to selective settings, only the front door opened from the inside is unlocked

Locking and unlocking from the inside

⚠ **Observe Safety notes, see page 54.**

You can lock or unlock the vehicle from the inside using the central locking or unlocking switch. This can be useful, for example, if you want to lock the vehicle before starting to drive.

The central locking or unlocking switch does not lock or unlock the fuel filler flap.

Opening the trunk

⚠ **Warning!**

Make sure the trunk is closed when the engine is running and while driving. Among other dangers, deadly carbon monoxide (CO) gases may enter vehicle interior resulting in unconsciousness and death.

❗ When you open the trunk, the trunk lid swings open upwards. Always make sure there is sufficient overhead clearance.

You can open the trunk when the vehicle is stationary.

A minimum height clearance of 5.9 ft (1.80 m) is required to open the trunk lid.

Opening the trunk from the outside

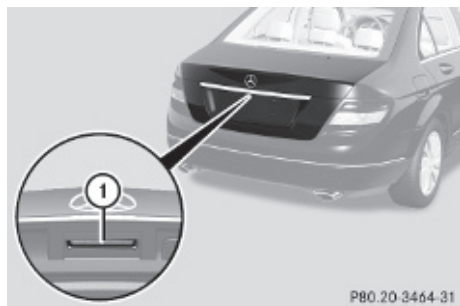

▶ Press and hold button  (▷ page 70) on the SmartKey until the trunk unlocks and begins to open.

or

▶ Pull on handle ①.

In vehicles without KEYLESS-GO: The vehicle must be unlocked.

If the trunk does not open, it is still locked separately (▷ page 77).

Opening the trunk from the inside



▶ Press remote trunk opening switch ① until the trunk begins to open.

If the trunk does not open, it is still locked separately (▷ page 77).

Closing the trunk

Warning!

Make sure the trunk is closed when the engine is running and while driving. Among other dangers, deadly carbon monoxide (CO) gases may enter vehicle interior resulting in unconsciousness and death.

Warning!

To prevent possible personal injury, always keep hands and fingers away from the trunk opening when closing the trunk lid. Be especially careful when small children are around.

Observe Safety notes, see page 54.

Do not leave the SmartKey in the open trunk. You may lock yourself out.

If the vehicle was previously locked centrally with the SmartKey or KEYLESS-GO, the trunk lid will lock automatically when closed. All turn signal lamps flash three times and an acoustic signal sounds three times to confirm locking. تلفن شبانه روزی: ۰۲۱۷۷۷۷۷۷۷



- ▶ Lower the trunk lid using handle ① or ②.
- ▶ Close trunk lid with hands placed flat on trunk lid.

Trunk lid emergency release

The trunk lid can be opened from inside the trunk with the emergency release button.

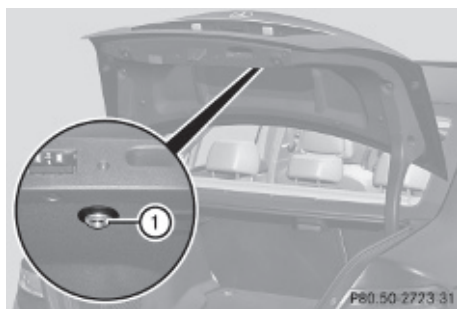

- ▶ Briefly press emergency release button ①.

The emergency release button unlocks and opens the trunk while the vehicle is standing still or in motion.

Illumination of the emergency release button:

- The button flashes for 30 minutes after opening the trunk.
- The button flashes for 60 minutes after closing the trunk.

The emergency release button does not open the trunk, if the vehicle battery is discharged or disconnected.

Valet locking

You can lock the trunk separately with the mechanical key. This denies unauthorized access to the trunk, e.g. when you valet park the vehicle.

- ▶ Leave only the SmartKey less its mechanical key with the vehicle.

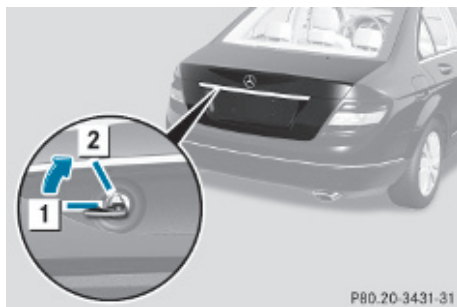

- ▶ **Valet locking:** Close the trunk.
- ▶ Remove the mechanical key from the SmartKey (▷ page 309).
- ▶ Insert the mechanical key in the trunk lid lock.
- ▶ Turn the mechanical key clockwise to position ② and remove the mechanical key in that position to lock the trunk.

The trunk remains locked even when the vehicle is centrally unlocked.

You can then only open the trunk with the mechanical key.

- ▶ **Canceling:** Insert the mechanical key in the trunk lid lock.
- ▶ Turn the mechanical key counterclockwise to neutral position ① and remove the mechanical key in that position to unlock the trunk.
You can now open the trunk.

Starter switch positions

SmartKey تلفن

⚠ Observe Safety notes, see page 54.



Starter switch

- ① For removing SmartKey
Vehicles with automatic transmission: Gear selector lever must be in park position **P**.
- ② Power supply for some electrical consumers, e.g. wipers

- 2 Ignition (power supply for all electrical consumers) and driving position
- 3 Starting position

When you switch on the ignition, all lamps in the instrument cluster come on. The low-beam headlamp indicator lamp, high-beam headlamp indicator lamp, turn signal indicator lamps, and the indicator lamps for the fog lamps will only come on if activated. If a lamp in the instrument cluster fails to come on when the ignition is switched on, have it checked and replaced if necessary. If a lamp in the instrument cluster remains on after starting the engine or comes on while driving, refer to “Lamps in instrument cluster” (▷ page 297).

If the SmartKey is left in starter switch position **0** for an extended period of time, it can no longer be turned in the starter switch. In this case, the steering is locked. To unlock, remove SmartKey from the starter switch and reinsert.

The steering is locked when the SmartKey is removed from the starter switch.

- ▶ Always remove the SmartKey from the starter switch when the engine is not in operation. This will help to prevent accelerated vehicle battery discharge or a completely discharged vehicle battery.

If the SmartKey cannot be turned in the starter switch, the vehicle battery may not be sufficiently charged.

- ▶ Check the vehicle battery and charge it if necessary (▷ page 323).

or

- ▶ Get a jump start (▷ page 323).

- i** If the SmartKey does not belong to the vehicle, the SmartKey can be turned in the starter switch. However, the ignition does not switch on and the engine does not start.

KEYLESS-GO

⚠ Observe Safety notes, see page 54.

Vehicles equipped with the KEYLESS-GO feature are supplied with a SmartKey with integrated KEYLESS-GO function and a removable KEYLESS-GO start/stop button.

The KEYLESS-GO start/stop button must be inserted in the starter switch and the SmartKey present in the vehicle.

Pressing the KEYLESS-GO start/stop button without depressing the brake pedal corresponds to the various starter switch positions (▷ page 77).

Pressing the KEYLESS-GO start/stop button with the brake pedal firmly depressed will start the engine (▷ page 101).

The KEYLESS-GO start/stop button can be pulled out of the starter switch easily. You can then insert the SmartKey into the starter switch.

- i** The KEYLESS-GO start/stop button does not need to be removed from the starter switch when you leave the vehicle. However, always take the SmartKey with you when you leave the vehicle. As long as the SmartKey is in the vehicle, the vehicle's electrical systems can be switched on or the engine can be started using the KEYLESS-GO start/stop button.

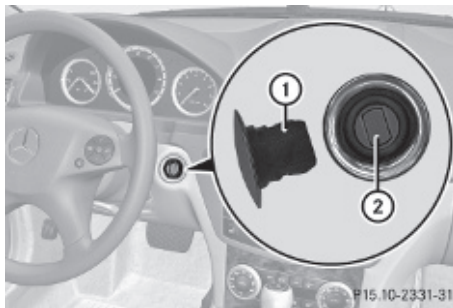

- ① KEYLESS-GO start/stop button
- ② Starter switch

▶ Insert the KEYLESS-GO start/stop button into the starter switch (if not inserted already).

i Allow for 2 seconds until the system has detected the KEYLESS-GO start/stop button.

▶ Vehicles with manual transmission: Shift the manual transmission into the neutral position (no gear selected).

or

▶ Vehicles with automatic transmission: Shift the automatic transmission into neutral position **N**.

▶ Do not depress the brake pedal.

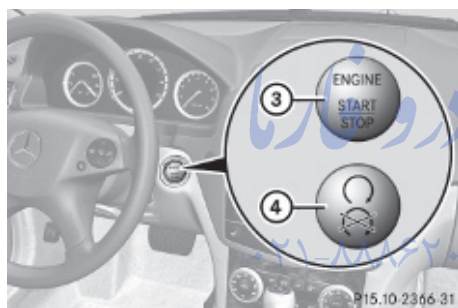

KEYLESS-GO start/stop button

③ USA only

④ Canada only

Position 0

Before you press the KEYLESS-GO start/stop button, the vehicle's on-board electronics have status **0** (as with SmartKey removed).

Position 1

▶ Press the KEYLESS-GO start/stop button once.

This supplies power for some electrical consumers, e.g. wipers.

i When you now open the driver's door, the power supply is switched off.

Ignition (or position 2)

▶ Press the KEYLESS-GO start/stop button twice.

This supplies power for all electrical consumers.

When you switch on the ignition, all lamps in the instrument cluster come on. The low-beam headlamp indicator lamp, high-beam headlamp indicator lamp, turn signal indicator lamps, and the indicator lamps for the fog lamps will only come on if activated. If a lamp in the instrument cluster fails to come on when the ignition is switched on, have it checked and replaced if necessary. If a lamp in the instrument cluster remains on after starting the engine or comes on while driving, refer to "Lamps in instrument cluster" (▶ page 297).

i When you now press the KEYLESS-GO start/stop button once and the driver's door is open, the power supply is switched off.

Seats

Safety notes

⚠ Warning!

In order to avoid possible loss of vehicle control the following must be done before the vehicle is put into motion:

- seat adjustment
- head restraint adjustment
- steering wheel adjustment
- rear view mirror adjustment
- fastening of seat belts

⚠ Warning!

Do not adjust the driver's seat while driving. Adjusting the seat while driving could cause the driver to lose control of the vehicle.

Never ride in a moving vehicle with the seat backrest in an excessively reclined position as

this can be dangerous. You could slide under the seat belt in a collision. If you slide under it, the seat belt would apply force at the abdomen or neck. That could cause serious or fatal injuries. The seat backrest and seat belts provide the best restraint when the wearer is in a position that is as upright as possible and seat belts are properly positioned on the body.

Warning!

Your seat must be adjusted so that you can correctly fasten your seat belt.

Observe the following points:

- Adjust the seat backrest until your arms are slightly angled when holding the steering wheel.
- Adjust the seat to a comfortable seating position that still allows you to reach the accelerator/brake pedal safely. The position should be as far back as possible with the driver still able to operate the controls properly.
- Adjust the head restraint so that it is as close to the head as possible. The center of the head restraint must support the back of the head at eye level.
- Never place hands under the seat or near any moving parts while a seat is being adjusted.

Failure to do so could result in an accident and/or serious personal injury.

Warning!

The power seats can be operated at any time. Therefore, do not leave children unattended in the vehicle, or with access to an unlocked vehicle. A child's unsupervised access to a vehicle could result in an accident and/or serious personal injury.

Warning!

According to accident statistics, children are safer when properly restrained in the rear seating positions than in the front seating

position. Thus, we strongly recommend that children be placed in the rear seats whenever possible. Regardless of seating position, children 12 years old and under must be seated and properly secured in an appropriately sized infant restraint, toddler restraint, or booster seat recommended for the size and weight of the child. For additional information, see "Children in the vehicle".

A child's risk of serious or fatal injuries is significantly increased if the child restraints are not properly secured in the vehicle and/or the child is not properly secured in the child restraint.

Warning!

For your protection, drive only with properly positioned head restraints.

Adjust the head restraint so that it is as close to the head as possible and the center of the head restraint supports the back of the head at eye level. This will reduce the potential for injury to the head and neck in the event of an accident or similar situation.

Do not drive the vehicle without the seat head restraints. Head restraints are intended to help reduce injuries during an accident.

Seat adjustment

-  When moving the seats, make sure there are no items in the footwell or behind the seats. Otherwise, you could damage the seats and/or the items.

Semi-electrical seat adjustment

This seat adjustment is only available on C 63 AMG.

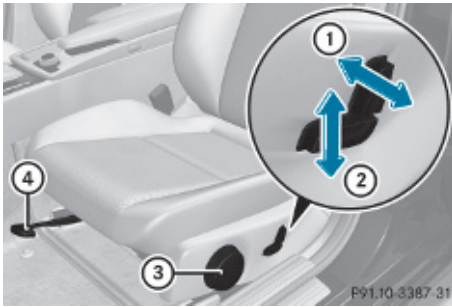

i AMG vehicles are equipped with a seat with an integrated head restraint. It is therefore not possible to set the height and angle of the head restraint.

- ▶ **Seat backrest tilt:** Press the switch forward or backward in direction of arrow ①.
- ▶ **Seat height:** Press the switch up or down in direction of arrow ②.
- ▶ **Seat cushion tilt:** Turn handwheel ③ forward or backward until your upper legs are lightly supported.
- ▶ **Seat fore and aft adjustment:** Lift handle ④.
- ▶ Slide the seat to the desired position.
- ▶ Allow handle ④ to reengage with an audible click.
- ▶ Check for proper engagement before driving.

Power seats

The seat adjustment switch is located on the entry side of each front seat base. The seat adjustment switches for vehicles with memory function are located on the front doors.

i Vehicles without memory function:

The seats can be adjusted within 5 minutes after either front door has been opened. The counter resets each time

- you open or close a front door
- you insert the SmartKey into the starter switch
- you remove the SmartKey from the starter switch
- you switch the ignition on or off

Just like in vehicles with memory function, the power seats can be operated at any time when the ignition is switched on.

i Vehicles with memory function:

The memory function (> page 89) lets you store the settings for the seat position together with the settings for the steering wheel and the exterior rear view mirrors.

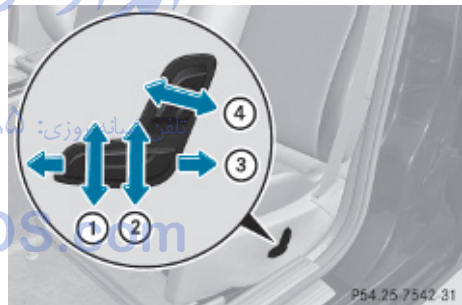

Vehicles without memory function

i AMG vehicles are equipped with a seat with an integrated head restraint. It is therefore not possible to set the height and angle of the head restraint.

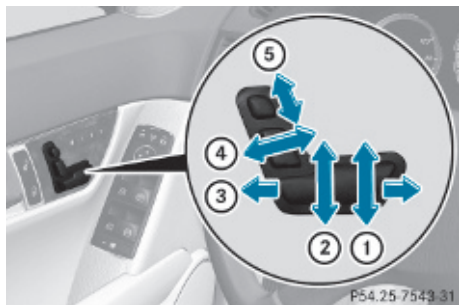

Vehicles with memory function

- ▶ **Seat fore and aft adjustment:** Press the switch forward or backward in direction of arrow ③.
- ▶ **Seat backrest tilt:** Press the switch forward or backward in direction of arrow ④.
- ▶ **Seat height:** Press the switch up or down in direction of arrow ②.
- ▶ **Seat cushion tilt:** Press the switch up or down in direction of arrow ① until your upper legs are lightly supported.
- ▶ **Head restraint height (vehicles with memory function):** Press the switch up or down in direction of arrow ⑤.

Head restraint height adjustment, manual

This feature is only available in vehicles without memory function.

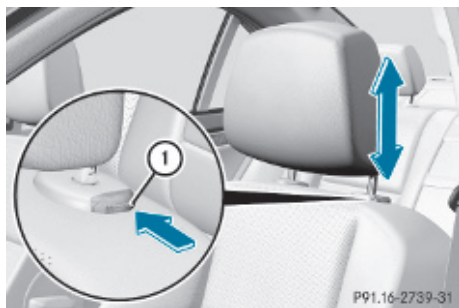

- ▶ **Raising:** Adjust the height of the head restraint by pulling it upward.
- ▶ **Lowering:** Press release button ① and push down on the head restraint.

Head restraint fore and aft adjustment



- ▶ Push or pull on the lower edge of the head restraint cushion to the desired position.

Lumbar support

You can adjust the contour of the front seat's lumbar support to help enhance support to your spine.

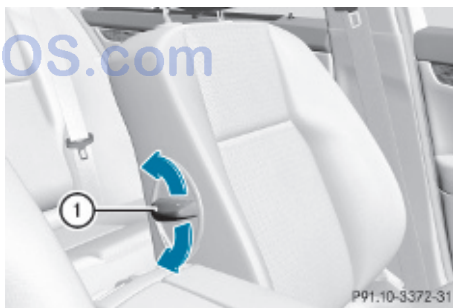

- ▶ Move adjustment lever ① in direction of the arrows until you have reached a comfortable seating position.

Seat with adaptive backrest

This feature is only available on C 63 AMG.

The contour of the front seat backrests can be individually adjusted to provide optimum support for your back.

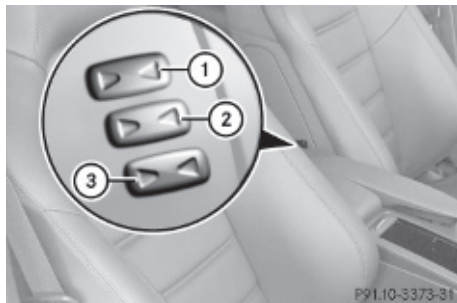

- ▶ Switch on the ignition.
 - ▶ **Upper back support:** Use button ① to adjust the upper back support to the desired position.
 - ▶ **Lumbar region support:** Use button ② to adjust the lumbar region support to the desired position.
 - ▶ **Lateral support:** Use button ③ to adjust the lateral support to the desired position.
- i** If, after a period of time, the seat no longer provides the desired contour, then repeat the adjustment procedure.

Rear seat head restraints

Warning!

For your protection, drive only with properly positioned head restraints.

Adjust the head restraint in such a way that it is as close to the head as possible and the center of the head restraint supports the back of the head at eye level. This will reduce the potential for injury to the head and neck in the event of an accident or similar situation.

With a rear seat occupied, make sure to move the respective head restraint up from the lowest non-use position and have the occupant adjust the head restraint properly.

Do not drive the vehicle without the seat head restraints installed when the rear seats are occupied. Head restraints are intended to help reduce injuries during an accident.

Rear seat head restraint height adjustment

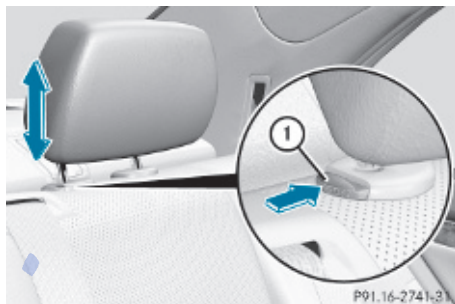

- ▶ **Raising:** Pull head restraint upward to the desired position.
- ▶ **Lowering:** Press release button ① and push down on head restraint.

Rear seat head restraint fore and aft adjustment



- ▶ Adjust the head restraint to the desired position by pushing or pulling on the lower edge of the head restraint cushion.

Rear seat head restraints, removing and installing (vehicles with split foldable rear seat backrest)

- i** The rear seat head restraints cannot be removed on vehicles which do not have the split foldable rear seat backrest.

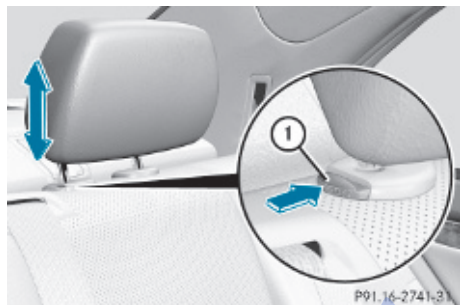

- ▶ **Removing:** Unlock the rear seat backrest (> page 204) and fold it slightly forward.
- ▶ Pull head restraint to its highest position.
- ▶ Press release button (1) and pull out head restraint.
- ▶ **Installing:** Position the head restraints so that the notches on the rod are on the left when looking in the direction of travel.
- ▶ Insert head restraint and push it down until it engages.
- ▶ Fold the rear seat backrest back until it engages.

Seat heating

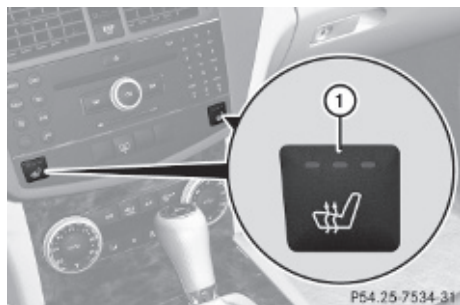

The red indicator lamps in seat heating switch (1) come on to show which heating level you have selected.

The seat heating switches from level **3** (high) to level **2** after approximately 5 minutes.

The seat heating switches from level **2** to level **1** (low) after approximately 10 minutes.

After approximately 20 minutes in level **1**, the seat heating switches off automatically.

- ▶ Switch on the ignition.
- ▶ **Switching on:** Press seat heating switch (1).

Three red indicator lamps in seat heating switch (1) come on.

- ▶ Press seat heating switch (1) repeatedly until the desired seat heating level is set.

- ▶ **Switching off:** Press seat heating switch (1) repeatedly until all indicator lamps go out.

If there is insufficient voltage the seat heating switches off automatically.

The seat heating will switch back on again automatically as soon as sufficient voltage is available.

Multifunction steering wheel

Safety notes

Warning!

Do not adjust the steering wheel while driving. Adjusting the steering wheel while driving, or driving without the steering wheel adjustment feature locked could cause the driver to lose control of the vehicle.

The electrical steering wheel adjustment feature can be operated at any time. Therefore, do not leave children unattended in the vehicle, or with access to an unlocked vehicle. A child's unsupervised access to a vehicle could result in an accident and/or serious personal injury.

Make sure

- you can reach the steering wheel with your arms slightly bent at the elbows
- you can move your legs freely
- all displays (including malfunction and indicator lamps) on the instrument cluster are clearly visible

Steering wheel adjustment, manual

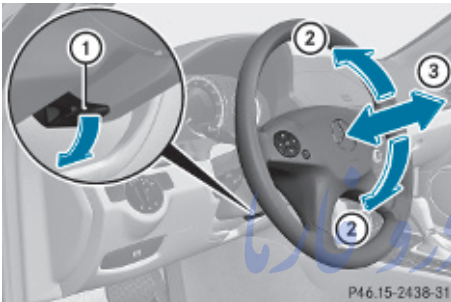

- ① Release handle
- ② Adjusting steering wheel, up or down
- ③ Adjusting steering wheel, in or out

- ▶ **Unlocking:** Pull release handle ① out to its stop limit.
- ▶ Move steering wheel to the desired position.
- ▶ **Locking:** Push release handle ① all the way up until it engages.
- ▶ Make sure the steering wheel is securely locked by trying to move it up and down as well as in and out before driving off.

Steering wheel adjustment, electrical

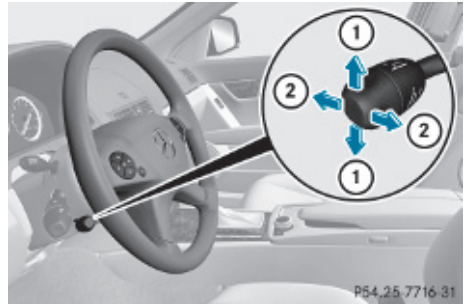

- ▶ **Adjusting steering wheel up or down:** Move stalk in direction of arrows ①.
- ▶ **Adjusting steering wheel in or out:** Move stalk in direction of arrows ②.

i The memory function (▷ page 89) lets you store the settings for the steering wheel together with the settings for the seat position and the exterior rear view mirrors.

Easy-entry/exit feature

This feature allows the driver an easier entry into and exit from the vehicle. When entering and exiting the vehicle, the steering wheel is in its uppermost position.

The easy-entry/exit feature can be activated or deactivated in the Convenience submenu of the control system (▷ page 135).

⚠ Warning!

You must make sure no one can become trapped or injured by the moving steering wheel when the easy-entry/exit feature is activated.

To stop steering wheel movement, move steering wheel adjustment stalk or press one of the memory position buttons.

Do not leave children unattended in the vehicle, or with access to an unlocked vehicle. Children could open the driver's door and unintentionally activate the easy-entry/exit

feature, which could result in an accident and/or serious personal injury.

With the easy-entry/exit feature activated, the steering wheel will return to its last set position when you close the driver's door with the ignition switched on. The steering wheel will also return to its last set position when you insert the SmartKey into the starter switch or press the KEYLESS-GO start/stop button once with the driver's door closed.

- ❗ The last set steering wheel position is stored when the ignition is switched off or the position is stored in memory (> page 89).

With the easy-entry/exit feature activated, the steering wheel tilts upwards when you remove the SmartKey from the starter switch. The steering wheel also tilts upwards when you open the driver's door with the SmartKey in starter switch position **0** or **1** or the KEYLESS-GO start/stop button in position **1**.

- ❗ When the current position for the steering wheel is in the uppermost tilt position, the steering wheel will no longer be able to move upward when the easy-entry/exit feature is activated.

The adjustment procedure is briefly interrupted when the engine is started.

⚠ Warning!

Let the system complete the adjustment procedure before setting the vehicle in motion. All steering wheel adjustment must be completed before setting the vehicle in motion. Driving off with the steering wheel still adjusting could cause the driver to lose control of the vehicle.

Crash-responsive exit aid

When you open the driver's door after an accident has occurred, the steering column moves up. The position of the SmartKey in the starter switch is insignificant. This function facilitates exiting as well as rescue of vehicle occupants.

The crash-responsive exit aid can only be triggered when the easy-entry/exit feature is activated via the control system.

Mirrors

Notes

Adjust the interior and exterior rear view mirrors before driving so that you have a good view of the road and traffic conditions.

Interior rear view mirror

- ▶ Adjust the interior rear view mirror manually.

Interior rear view mirror, antiglare position



- ▶ Tilt the mirror to the antiglare position by moving lever ① towards the windshield. The interior rear view mirror is dimmed.

Exterior rear view mirrors

⚠ Warning!

Exercise care when using the passenger-side exterior rear view mirror. The mirror surface is convex (outwardly curved surface for a wider field of view). Objects in mirror are closer than they appear. Check your interior rear view mirror and glance over your shoulder before changing lanes.



- ▶ Switch on the ignition.
- ▶ Press button ① for the driver's side exterior rear view mirror or button ② for the passenger-side exterior rear view mirror.

The indicator lamp in the respective button comes on.

If you do not make adjustments to the selected exterior rear view mirror within 15 seconds, the indicator lamp goes out. You will then have to select the desired exterior rear view mirror again before adjustments can be made. Adjustments can only be made with the indicator lamp for the respective exterior rear view mirror button illuminated.

- ▶ Press adjustment button ③ up, down, left or right according to the desired setting.

! If an exterior rear view mirror was forcibly hit from the front, manually snap it back into place.

i At low ambient temperatures, the exterior rear view mirrors will be heated automatically.

Auto-dimming rear view mirrors

The exterior rear view mirror on the driver's side and the interior rear view mirror will respond automatically to glare when the ignition is switched on and incoming light from headlamps falls on the sensor in the interior rear view mirror.

The rear view mirrors will not react if the automatic transmission is set to reverse gear **R** (manual transmission to reverse gear) or the interior lighting is switched on.

⚠ Warning!

The auto dimming function does not react if incoming light is not aimed directly at sensors in the interior rear view mirror.

The interior rear view mirror and the exterior rear view mirror on the driver's side do not react, for example, if the rear window sunshade is in raised position.

Light hitting the mirror(s) at certain angles (incident light) could blind you. As a result, you may not be able to observe traffic conditions and could cause an accident.

Exterior rear view mirror parking position

To assist during parking maneuvers, you can set the passenger-side exterior rear view mirror so that you can see the rear wheel and the road curb.

Setting and storing the parking position

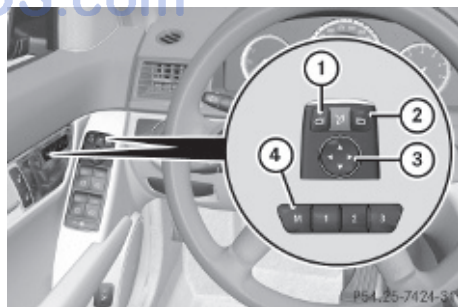

- ▶ Switch on the ignition.
- ▶ Press button ②, to select the passenger-side exterior rear view mirror.

- ▶ Shift the automatic transmission into reverse gear **R** (manual transmission to reverse gear).
The passenger-side exterior rear view mirror moves to the preset parking position.
- ▶ Adjust the passenger-side exterior rear view mirror with adjustment button ③ so that you see the rear wheel and the road curb.
The exterior rear view mirror parking position is stored.

Vehicles with memory function: You can also store the parking position using the memory button **M** ④:

- ▶ Switch on the ignition.
- ▶ Press button ②, to select the passenger-side exterior rear view mirror.
- ▶ Adjust the passenger-side exterior rear view mirror with adjustment button ③ so that you see the rear wheel and the road curb.
- ▶ Press memory button **M** ④ and within 3 seconds, press one of the arrows of adjustment button ③.
The parking position is stored if the exterior rear view mirror does not move.

i If the exterior rear view mirror does move, repeat the above steps. After the setting is stored, you can move the exterior rear view mirror again.

Calling up the parking position

- ▶ Switch on the ignition.
- ▶ Press button ②, to select the passenger-side exterior rear view mirror.
- ▶ Shift the automatic transmission into reverse gear **R** (manual transmission to reverse gear).
The passenger-side exterior rear view mirror moves to the stored parking position.

The passenger-side exterior rear view mirror returns to its previously stored driving position

- 10 seconds after you have put the gear selector lever out of reverse gear **R** (manual transmission out of reverse)
- immediately once your vehicle exceeds a speed of approximately 6 mph (10 km/h)
- immediately when you press button ① to select the driver's side exterior rear view mirror

Power-folding exterior rear view mirrors

This feature is only available in Canada vehicles.

! Before you drive the vehicle through an automatic car wash, fold in the exterior rear view mirrors. Otherwise they may get damaged.

Folding in and out automatically

The function must be activated in the Convenience submenu (▷ page 136).

The exterior rear view mirrors fold in automatically as soon as the vehicle is locked from the outside.

The exterior rear view mirrors fold out automatically as soon as the vehicle is unlocked and the driver's or front passenger door is subsequently opened.

Resetting the automatic exterior rear view mirror fold-in function

You need to reset the automatic exterior rear view mirror fold-in function whenever the battery was disconnected or discharged.



- ▶ Switch on the ignition.
- ▶ Briefly press button ①.

i You need to manually fold in the mirrors once, so that the automatic fold-in function will work, see “Setting fold-in function for exterior rear view mirrors” (▷ page 136).

Folding in and out manually

The exterior rear view mirrors can vibrate if they are not folded out completely.

- ▶ Switch on the ignition.
- ▶ **Folding in:** Briefly press button ①. Both exterior rear view mirrors fold in.
- i** At speeds above approximately 9 mph (15 km/h), you will not be able to fold the exterior mirrors in.
- ▶ **Folding out:** Briefly press button ①. Both exterior rear view mirrors fold out.

! If an exterior rear view mirror housing is forcibly pushed forward (hit from the rear), reposition it manually by applying firm pressure until it snaps back into place.

If an exterior rear view mirror housing is forcibly pushed rearward (hit from the front), press button ① to fold mirrors in. Then press button ① again to fold mirrors out. Do not force mirrors by hand as this may damage the adjustment mechanism.

The mirror housing is then properly positioned and you can adjust the mirror in the usual manner.

Memory function

Notes

With the memory function you can store up to three different configurations per front seat.

Each memory position button on the driver's side can store all of the following settings:

- Seat position
- Steering wheel position
- Exterior rear view mirrors' position

⚠ Warning!

Do not activate the memory function while driving. Activating the memory function while driving could cause the driver to lose control of the vehicle.

Each memory position button on the front passenger side can store the setting of the seat position.



Storing positions into memory

- ▶ Adjust the seats.
- ▶ On the driver's side, also adjust the steering wheel and exterior rear view mirrors to the desired positions.
- ▶ Press memory button **M** once and within 3 seconds press memory position button **1**, **2** or **3**.

When the settings are stored to the selected position, an acknowledgement signal sounds.

Recalling positions from memory

- ▶ Press and hold desired memory position button **1**, **2** or **3** until the seat has moved to the stored position completely. On the driver's side, also wait for the steering wheel and exterior rear view mirrors to move to the stored position.
- i** Releasing the memory position button stops movement to the stored positions immediately.

Lighting

Notes

- i** If you drive in countries with left-hand driving, you must have the headlamps modified for symmetrical low beams. Relevant information can be obtained at any authorized Mercedes-Benz Center.
- i** Vehicles equipped with active Bi-Xenon headlamps:
The active Bi-Xenon headlamps increase usable illumination over conventional headlamps because they follow the curvature of the road ahead. The beams of the active Bi-Xenon headlamps shift to either side according to the vehicle's steering angle and speed.

Exterior lamp switch

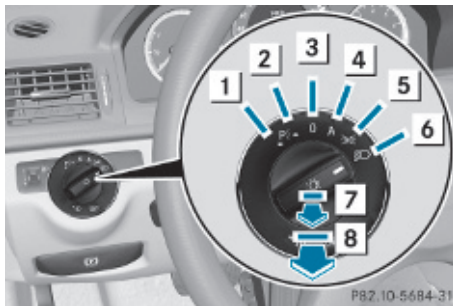

- | | | |
|----------|----------|--|
| 1 | | Standing lamps, left |
| 2 | | Standing lamps, right |
| 3 | 0 | Off
Daytime running lamp mode |
| 4 | A | Automatic headlamp mode
Daytime running lamp mode |
| 5 | | Parking lamps (also tail lamps, license plate lamps, side marker lamps and instrument panel lamps) |
| 6 | | Low-beam headlamps or high-beam headlamps |
| 7 | | Front fog lamps |
| 8 | | Rear fog lamp |

- i** The exterior lamps (except standing lamps or parking lamps) go out automatically when you remove the SmartKey from the starter switch or open the driver's door with the ignition switched off.

When the parking lamps or the rear fog lamp are switched on and you remove the SmartKey from the starter switch and open the driver's door, an acoustic signal sounds.

In addition the message **Switch Off Lights** appears in the multifunction display.

Switch off the parking lamps or the rear fog lamp manually.

- !** Failure to switch off the parking lamps when leaving the vehicle may result in a discharged battery.

Low-beam headlamps

The low-beam headlamps can be switched on and off with the exterior lamp switch.

- ▶ Switch on the ignition.
- ▶ **Switching on:** Turn the exterior lamp switch to position .

The following lamps come on:

- Low-beam headlamps
- Tail lamps
- Parking lamps
- License plate lamps
- Side marker lamps
- Instrument panel lamps
- Green indicator lamp  in the instrument cluster

- ▶ **Switching off:** Turn the exterior lamp switch to position .

Automatic headlamp mode

The following lamps come on and go out automatically depending on the brightness of the ambient light:





- Low-beam headlamps
- Tail lamps
- Parking lamps
- License plate lamps
- Side marker lamps

Warning!

If the exterior lamp switch is set to , the headlamps will not automatically come on under foggy conditions.

To minimize risk to you and to others, activate headlamps by turning exterior lamp switch to  when driving or when traffic and/or

ambient lighting conditions require you to do so.

In low ambient lighting conditions, only switch from position  to  with the vehicle at a standstill in a safe location. Switching from  to  will briefly switch off the headlamps. Doing so while driving in low ambient lighting conditions may result in an accident.

The automatic headlamp feature is only an aid to the driver. The driver is responsible for the operation of the vehicle's lights at all times.

- ▶ **Switching on:** Turn the exterior lamp switch to position .

The following lamps come on and go out depending on the brightness of the ambient light with the SmartKey in starter switch position 1 or the KEYLESS-GO start/stop button pressed once:

- Tail lamps
- Parking lamps
- License plate lamps
- Side marker lamps



When the engine is running, the low-beam headlamps will also come on and turn off automatically.

Canada only: High-beam headlamps are only available in low ambient lighting conditions.

Daytime running lamp mode

In Canada, the daytime running lamp mode is mandatory and therefore in a constant mode. In the USA, the daytime running lamp mode is deactivated by default.

- ▶ Activate the daytime running lamp mode using the control system, see "Switching daytime running lamp mode on or off (USA only)" (▷ page 133).

- ▶ Turn the exterior lamp switch to position  or .

When the engine is running, the low-beam headlamps come on.



In low ambient lighting conditions, the following lamps will come on additionally:

- Tail lamps
- Parking lamps
- License plate lamps
- Side marker lamps

With the daytime running lamp mode activated and the engine running, you cannot switch off the low-beam headlamps manually.

Canada only



You can only switch on the high-beam headlamps in low ambient lighting conditions. The high-beam flasher is available at all times. When the engine is running, and you

- shift from a driving position to park position **P** with the vehicle at a standstill (vehicles with automatic transmission) or the parking brake is engaged, the low-beam headlamps will go out with a delay of 3 minutes
- turn the exterior lamp switch to position , the low-beam headlamps, the tail and parking lamps, the license plate lamps and the side marker lamps come on
- turn the exterior lamp switch to position , the manual headlamp mode has priority over the daytime running lamp mode

The corresponding exterior lamps come on (▷ page 90).

USA only

You can only switch on the high-beam headlamps in low ambient lighting conditions. The high-beam flasher is available at all times.



When the engine is running, and you turn the exterior lamp switch to position  or , the manual headlamp mode has priority over the daytime running lamp mode.



The corresponding exterior lamps come on (▷ page 90).

Fog lamps





Fog lamps cannot be switched on with the exterior lamp switch in position .

Warning!

In low ambient lighting or foggy conditions, only switch from position  to  with the vehicle at a standstill in a safe location.

Switching from  to  will briefly switch off the headlamps. Doing so while driving in low ambient lighting conditions may result in an accident.

Fog lamps will operate with the parking lamps and/or the low-beam headlamps on. Fog lamps should only be used in conjunction with low-beam headlamps. Consult your State or Province Motor Vehicle Regulations regarding permissible lamp operation.

- ▶ Switch on the ignition.
- ▶ Turn the exterior lamp switch to position  or  (▷ page 90).
- ▶ **Switching on front fog lamps:** Pull out the exterior lamp switch to first stop. The green indicator lamp  in the instrument cluster comes on.
- ▶ **Switching on rear fog lamp:** Pull out the exterior lamp switch to second stop. The rear fog lamp, the front fog lamps, the green  and the yellow indicator lamp  in the instrument cluster come on.
- ▶ **Switching off front fog lamps/rear fog lamp:** Push in the exterior lamp switch to its stop.

Locator lighting

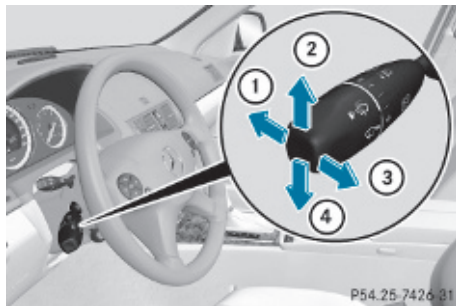

The locator lighting is described in the “Control system” section, see “Switching locator lighting on or off” (▷ page 134).

Combination switch



Turn signals

- ▶ Press the combination switch in direction of arrow ② or ④.

The corresponding turn signal indicator lamp  or  in the instrument cluster flashes.



The combination switch resets automatically after major steering wheel movements.

To signal minor directional changes:

- ▶ Press the combination switch only to the point of resistance in direction of arrow ② or ④ and release.

The corresponding turn signal lamps will flash three times.

High beam

- ▶ Turn the exterior lamp switch to position  (> page 90).
 - ▶ **Switching on:** Push the combination switch in direction of arrow ①.
- The high-beam headlamp indicator lamp  in the instrument cluster comes on.
- ▶ **Switching off:** Pull the combination switch in direction of arrow ③ to its original position.

i Also note the information on high-beam headlamps with activated automatic headlamp mode (> page 91) or the daytime running lamp mode (> page 91).

High-beam flasher

- ▶ **Switching on:** Pull the combination switch briefly in direction of arrow ③.

Hazard warning flasher

The hazard warning flasher can be switched on at all times, even with the SmartKey removed from the starter switch.

The hazard warning flasher comes on automatically when an air bag deploys.

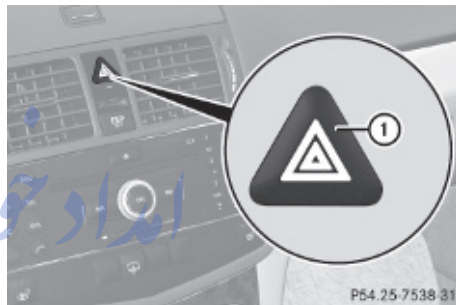

- ▶ **Switching on:** Press hazard warning flasher switch ①.

All turn signal lamps are flashing.

i With the hazard warning flasher activated and the combination switch set for either left or right turn, only the respective left or right turn signals will operate when the ignition is switched on.

- ▶ **Switching off:** Press hazard warning flasher switch ① again.

i If the hazard warning flasher has been activated automatically, press hazard warning flasher switch ① to switch it off.

Headlamp cleaning system

The headlamps will be cleaned with a high-pressure water jet automatically when the engine is running and you have

- switched on the headlamps

and

- the windshield wipers have wiped the windshield with washer fluid for the first time

The headlamps are cleaned every tenth time the windshield is washed with washer fluid.

The counter resets when you switch off the ignition.

For information on filling up the washer reservoir, see “Washer system and headlamp cleaning system” (▷ page 228).

Corner-illuminating front fog lamps

The corner-illuminating front fog lamps improve illumination of the area in the direction into which you are turning.

The corner-illuminating front fog lamps will only operate

- in low ambient lighting conditions
- at vehicle speeds below 25 mph (40 km/h)
- with the front fog lamps switched off
- when the engine is running

Switching on

- ▶ Turn the exterior lamp switch to position  or **A**.

or

- ▶ Activate the daytime running lamp mode (▷ page 91).
- ▶ Switch on the left or right turn signal, depending on whether you are turning left or right.

The respective front fog lamp comes on. If you have switched on the turn signal for one side but turn the steering wheel in the other direction, the corner-illuminating

front fog lamp on the side of the turn signal comes on.

or

- ▶ Turn the steering wheel in the desired direction.

Driving forward: The front fog lamp on the side of your steering direction comes on.

Driving in reverse: The front fog lamp opposite to your steering direction comes on.

The corner-illuminating front fog lamps will come on automatically depending on the steering angle, even if you did not switch on either turn signal. If the corner-illuminating front fog lamps came on automatically, they will also go out automatically depending on the steering angle and vehicle speed.

The corner-illuminating front fog lamps temporarily come on on both sides of the vehicle if you turn the steering wheel in one direction and then again in the other direction shortly thereafter.

The corner-illuminating front fog lamp remains lit for a short time only. It then goes out automatically.

Switching off

- ▶ Switch off the left or right turn signal.

or

- ▶ Steer straight ahead.

i There may be a brief delay before the corner-illuminating front fog lamps go out.

Interior lighting in the front



- ① Rear interior lighting on/off
- ② Automatic control on/off
- ③ Right front reading lamp on/off
- ④ Front interior lighting on/off
- ⑤ Left front reading lamp on/off
- ⑥ Front reading lamps
- ⑦ Front interior lighting

Automatic control

- **Activating:** Press button .

Button disengages and sits flush with the other buttons.

The interior lighting comes on, when you

- unlock the vehicle
- remove the SmartKey from the starter switch (Interior Lighting Delay: must be switched on (► page 135))
- open a door

- i** If a door remains open, the interior lamps go out automatically after approximately 5 minutes.

- **Deactivating:** Press button .
Button engages.

Manual control

- !** An interior lamp switched on manually does not go out automatically.

Leaving an interior lamp switched on for an extended period of time with the engine turned off could result in a discharged battery.

- **Switching front interior lighting on/off:** Press switch .
- **Switching rear interior lighting on/off:** Press switch .
- **Switching front reading lamps on/off:** Press respective button .

Emergency lighting

When the interior lighting is set to automatic mode, the interior lighting comes on automatically if the vehicle is involved in an accident.

Switching off:

- Press hazard warning flasher switch (► page 93).

or

- Unlock the vehicle with the SmartKey.

Interior lighting in the rear

- !** An interior lamp switched on manually does not go out automatically.

Leaving an interior lamp switched on for an extended period of time with the engine turned off could result in a discharged battery.

۰۲۱-۸۸۶۲۰۸۵

FarmaSOS.com

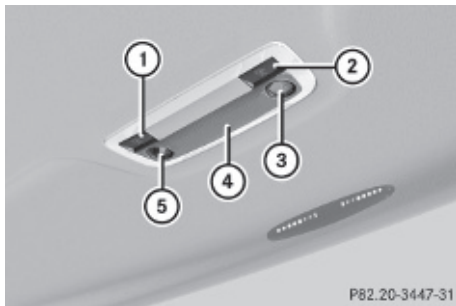

- ① Right rear reading lamp on/off
- ② Left rear reading lamp on/off
- ③ Left reading lamp
- ④ Rear interior lamp
- ⑤ Right reading lamp

► Switching rear reading lamps on/off:

Press respective reading lamp switch



Wipers

Notes

- !** Do not operate the wipers when the windshield is dry. Dust that accumulates on a windshield might scratch the glass and/or damage the wiper blades when wiping occurs on a dry windshield. If it is necessary to operate the wipers in dry weather conditions, always operate the wipers with washer fluid.
- !** If the windshield wipers leave smears on the windshield after the car has been driven through an automatic car wash, then wax or other residue is on the windshield. Shortly after washing the car in an automatic car wash, clean the windshield with washer fluid.

Windshield wipers

- Observe notes on page (► page 96).

Switching on/off

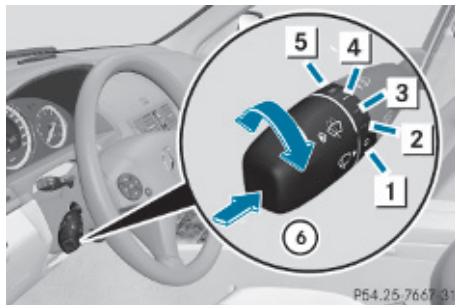

Combination switch

- ① Windshield wipers off
- ② Slow intermittent wiping⁵
- ③ Fast intermittent wiping⁶
- ④ Slow continuous wiping
- ⑤ Fast continuous wiping
- ⑥ Single wipe/ Wiping with washer fluid تلفن

- Switch on the ignition.
- Turn the combination switch to the desired position, depending on the intensity of the rain.

- i** When the windshield wipers are switched on and you stop the vehicle, the wipers operate more slowly.

Intermittent wiping

Only switch on intermittent wiping under wet weather conditions or in the presence of precipitation.

- !** Vehicles with rain sensor: Do not leave windshield wipers on an intermittent setting when the vehicle is taken to an automatic car wash or during windshield cleaning. Windshield wipers will operate in



⁵ Rain sensor operation with low sensitivity.

⁶ Rain sensor operation with high sensitivity.

the presence of water sprayed on the windshield, and windshield wipers may be damaged as a result.

! Vehicles with rain sensor: If you have set intermittent wiping, dirt on the surface of the rain sensor or optical effects may cause the windshield wipers to wipe in an undesired fashion. This could then damage the windshield wiper blades or scratch the windshield. You should therefore switch off the windshield wipers when weather conditions are dry.

Vehicles with rain sensor: Intermittent wiping interval is dependent on the wetness of the windshield. After the initial wipe, pauses between wipes are controlled by the rain sensor automatically.

► Turn the combination switch to position  or . Intermittent wiping starts with selected wiping interval.

Intermittent wiping is interrupted when the vehicle is at a standstill and a front door is opened. This protects persons getting into or out of the vehicle from being sprayed.

Intermittent wiping will be continued when all doors are closed and

- the clutch pedal is depressed (vehicles with manual transmission)
- or
- the automatic transmission is in drive position **D** or reverse gear **R** (vehicles with automatic transmission)
- or
- the wiper setting is changed using the combination switch

Single wipe

► Press the combination switch briefly in direction of arrow  to the resistance point. The windshield wipers wipe one time without washer fluid.

Wiping with washer fluid

► Press the combination switch in direction of arrow  past the resistance point. The windshield wipers operate with washer fluid.

i To prevent smears on the windshield or noisy/chattering wiper blades, wipe with washer fluid every now and then even when it is raining.

For information on filling up the washer reservoir, see “Washer system and headlamp cleaning system” (▷ page 228).



For information on cleaning the headlamps with washer fluid, see “Headlamp cleaning system” (▷ page 93).

Problems with wipers

! If anything blocks the windshield wipers (leaves, snow, etc.), switch them off immediately.

For safety reasons, do the following before attempting to remove any blockage:

- Stop the vehicle in a safe location.
- Remove the SmartKey from the starter switch.
- or
- Turn off the engine by pressing the KEYLESS-GO start/stop button and open the driver’s door (with the driver’s door open, starter switch is in position **0**, same as with SmartKey removed from starter switch).
- Engage the parking brake.
- Remove blockage.
- Turn the windshield wipers on again.

If the windshield wipers fail to function at all with the combination switch in position  or ,

- set the combination switch to the next higher wiper speed
- have the windshield wipers checked at the nearest authorized Mercedes-Benz Center

Power windows

Opening and closing

The door windows are opened and closed electrically. The switches for all door windows are located on the driver's door control panel. The switches for the respective door windows are located on the front passenger door and on the rear doors.

- i** Operating the rear door windows from the rear is not possible when you activate the override switch (▷ page 59).

⚠ Observe Safety notes, see page 54.

⚠ Warning!

When opening or closing the door windows, make sure there is no danger of anyone being harmed by the opening/closing procedure.

The door windows are equipped with the express operation and automatic reversal function. If in express operation mode a door window encounters an obstruction that blocks its path, the automatic reversal function will stop the door window and open it slightly.

The door windows operate differently when the switch is pulled and held. See the "Closing when a door window is blocked" section in this chapter for details.

The closing of the door windows can be immediately halted by releasing the switch or, if the switch was pulled past the resistance point and released, by either pressing or pulling the respective switch.

If a door window encounters an obstruction that blocks its path in a circumstance where you are closing the door windows by pressing and holding button  on the SmartKey or by pressing and holding the sensor surface (vehicles with KEYLESS-GO) on an outside door handle, the automatic reversal function will not operate.

Activate the override switch when children are riding in the back seats of the vehicle. The children may otherwise injure themselves, e.g. by becoming trapped in the door window opening.

⚠ Warning!

Do not keep any part of your body up against the window pane when opening a window. The downward motion of the pane may pull that part of your body down between the window pane and the door frame and trap it there. If there is a risk of entrapment, release the switch and pull it to close the window.

- i** You can also open or close the door windows using the SmartKey, see "Summer opening feature" (▷ page 99) and "Convenience closing feature" (▷ page 100).

- i** After switching off the ignition or removing the SmartKey from the starter switch, you can operate the door windows until you open the driver's or front passenger door. If no door was opened you can operate the door windows for up to 5 minutes.

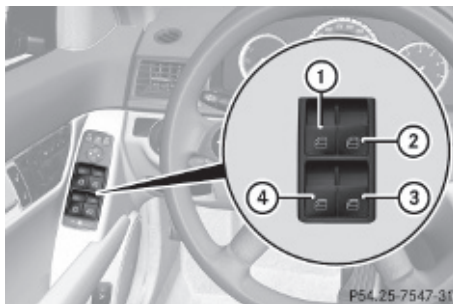

- ▶ Switch on the ignition.
- ▶ **Opening/closing:** Press or pull and hold switch ① to ④ to the resistance point. The corresponding door window moves downward or upward until you release the switch.
- ▶ **Express operation:** Press or pull switch ① to ④ past the resistance point and release. The corresponding door window opens or closes completely.
- ▶ **Stopping during express operation:** Press or pull the respective switch again.

Closing when a door window is blocked

Warning!

Make sure that nobody can become trapped and be seriously or even fatally injured when closing a door window with greater force or without automatic reversal function.

If the upward movement of a door window is blocked during the closing procedure, the door window will stop and open slightly.

- ▶ Immediately after the door window has stopped because it was blocked, pull and hold the respective switch upward until the door window is fully closed. The door window closes with greater force.

If the door window is blocked again and opens slightly:

- ▶ Immediately after the door window was blocked, pull and hold the respective switch upward until the door window is fully closed. The door window closes without automatic reversal function.

Warning!

Pulling and holding the switch to close the door window immediately after it had been blocked two times will cause the door window to close without any reversal function for as long as you hold the switch.

Synchronizing door windows

The door windows must be synchronized if they cannot be fully closed (express operation).

Each door window must be synchronized separately.

- ▶ Close all doors.
- ▶ Switch on the ignition.
- ▶ Pull and hold switch ①, ②, ③ or ④ (> page 98) until the respective door window is closed. The door window opens again slightly.
- ▶ Pull and hold the respective switch once more immediately until the door window is closed completely.
- ▶ Hold the respective switch for approximately 1 second. The door window is synchronized.

Summer opening feature

When the weather is warm, you can ventilate the vehicle before driving off by simultaneously

- opening the door windows
- opening the tilt/sliding sunroof
- opening the panorama roof with power tilt/sliding panel and roller sunblinds

The summer opening feature can only be activated via the remote control of the SmartKey. The SmartKey must be in close proximity to the driver's outside door handle.

- ▶ Aim the transmitter eye of the SmartKey at the driver's outside door handle.

Vehicles with tilt/sliding sunroof

- ▶ Press and hold button  on the SmartKey until the door windows and the



tilt/sliding sunroof have reached the desired position.

The vehicle unlocks.



- ▶ Release button  on the SmartKey to interrupt the opening procedure.

Vehicles with panorama roof with power tilt/sliding panel

When roller sunblinds are extended:

- ▶ Press and hold button  on the SmartKey.
The vehicle unlocks.
The door windows open and the roller sunblinds begin to retract after approximately 1 second.
- ▶ With the door windows opened and the roller sunblinds fully retracted, press and hold button  on the SmartKey again.
The tilt/sliding panel opens.
- ▶ Release button  on the SmartKey to interrupt the opening procedure.

When roller sunblinds are retracted:

- ▶ Press and hold button  on the SmartKey.
The door windows and the tilt/sliding panel opens after approximately 1 second.
- ▶ Release button  on the SmartKey to interrupt the opening procedure.

Convenience closing feature

When locking the vehicle, you can simultaneously close



- the door windows
- the tilt/sliding sunroof
- the panorama roof with power tilt/sliding panel

Afterward, you can extend the roller sunblinds of the panorama roof with power tilt/sliding panel.

Warning!

When closing the door windows and the tilt/sliding sunroof or panorama roof with power tilt/sliding panel, make sure there is no danger of anyone being harmed by the closing procedure.

If potential danger exists, proceed as follows:





- Release button  to stop the closing procedure. To open, press and hold button . To continue the closing procedure after making sure that there is no danger of anyone being harmed by the closing procedure, press and hold button .

Vehicles with KEYLESS-GO:

- Release the sensor surface on the outside door handle to stop the closing procedure.
- Immediately pull on the same outside door handle and hold firmly. The door windows and the tilt/sliding sunroof or panorama roof with power tilt/sliding panel will open for as long as the door handle is held but the door not opened.

With SmartKey

The SmartKey must be in close proximity to the driver's outside door handle.

- ▶ Aim transmitter eye of the SmartKey at the driver's outside door handle.
- ▶ Press and hold button  on the SmartKey until the door windows and the tilt/sliding sunroof or panorama roof with power tilt/sliding panel are closed completely.
- ▶ Release button  on the SmartKey to interrupt the closing procedure.
- ▶ **Vehicles with panorama roof with power tilt/sliding panel:** Press and hold button  on the SmartKey once more.
The roller sunblinds extend.
- ▶ Release button  on the SmartKey to interrupt the extending procedure.

تلفن شماره روزی: ۰۵۱۸۸۶۲۰۸۵

Formasoft.com

With KEYLESS-GO

The SmartKey with KEYLESS-GO must be located outside the vehicle within approximately 3 ft (1 m) of a door.

- ▶ Close all doors.
- ▶ Touch and hold the sensor surface on an outside door handle (▷ page 71) until the door windows and the tilt/sliding sunroof or panorama roof with power tilt/sliding panel are closed completely.
- ❗ Make sure you are only touching the sensor surface.
- ▶ Release the sensor surface to interrupt the closing procedure.
- ▶ **Vehicles with panorama roof with power tilt/sliding panel:** Touch and hold the sensor surface once more. The roller sunblinds extend.
- ▶ Release the sensor surface to interrupt the extending procedure.

Driving and parking

Safety notes

⚠ Warning!

Make sure absolutely no objects are obstructing the pedals' range of movement. Keep the driver's footwell clear of all obstacles. If there are any floor mats or carpets in the footwell, make sure the pedals still have sufficient clearance.

During sudden driving or braking maneuvers the objects could get caught between or under the pedals. You could then no longer brake or accelerate. This could lead to accidents and injury.

⚠ Warning!

With the engine not running, there is no power assistance for the brake and steering systems. In this case, it is important to keep in mind that a considerably higher degree of

effort is necessary to brake and steer the vehicle. Adapt your driving accordingly.

Starting the engine

⚠ Warning!

Inhalation of exhaust gas is hazardous to your health. All exhaust gas contains carbon monoxide (CO), and inhaling it can cause unconsciousness and possible death.

Do not run the engine in confined areas (such as a garage) which are not properly ventilated. If you think that exhaust gas fumes are entering the vehicle while driving, have the cause determined and corrected immediately. If you must drive under these conditions, drive only with at least one window fully open at all times.

Manual transmission

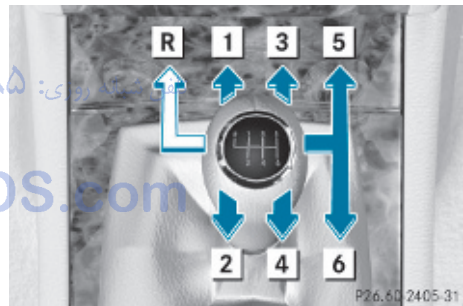

Gearshift pattern for manual transmission

- R** Reverse gear
- 1** to **6** Forward gears

For more information, see "Manual transmission" (▷ page 107).

- ▶ Depress the brake pedal.
- ▶ Make sure the manual transmission is in the neutral position (no gear selected).
- ▶ Fully depress the clutch pedal. Otherwise the engine cannot be started due to the integrated safety interlock.

Automatic transmission



Gearshift pattern for automatic transmission

- P** Park position with gear selector lever lock
- R** Reverse gear
- N** Neutral position
- D** Drive position

For more information, see “Automatic transmission” (▷ page 108).

- ▶ Make sure the automatic transmission is in park position **P**.

With SmartKey

- ▶ Do not depress the accelerator pedal.
- ▶ Turn the SmartKey in the starter switch to position **3** (▷ page 77) and release it. The engine starts automatically.

With KEYLESS-GO

Warning!

As long as the SmartKey is in your vehicle, the vehicle can be started. Therefore, never leave children unattended in the vehicle, as they could otherwise accidentally start the engine.

When leaving the vehicle, always take the SmartKey with you and lock the vehicle. Do not leave children unattended in the vehicle, or with access to an unlocked vehicle. A child's unsupervised access to a vehicle could result in an accident and/or serious personal injury.

You can start your vehicle without the SmartKey in the starter switch using the KEYLESS-GO start/stop button.

The SmartKey must be located in the vehicle.

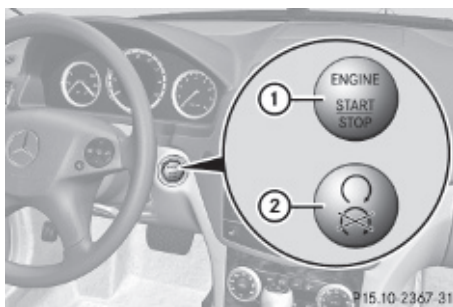

KEYLESS-GO start/stop button

- ① USA only
- ② Canada only

- ▶ Make sure the KEYLESS-GO start/stop button is inserted in the starter switch (▷ page 78).

- i** To start the engine with the SmartKey instead of the KEYLESS-GO function, remove the KEYLESS-GO start/stop button from the starter switch. Proceed as described in “With SmartKey” (▷ page 102).

- ▶ Depress the brake pedal during the starting procedure.
- ▶ Do not depress the accelerator pedal.
- ▶ Press the KEYLESS-GO start/stop button once. The engine starts automatically.

Starting difficulties

- !** Remember that extended starting attempts can drain the battery.

The engine does not start. You can hear the starter.

There could be a malfunction in the engine electronics or in the fuel supply system.

Carry out the following steps:

- ▶ If you are starting the engine with the SmartKey: Turn the SmartKey in the starter switch to position **0** and repeat the starting procedure.
- ▶ If you are starting the engine with KEYLESS-GO: Close any doors that may be open to allow for better detection of the SmartKey.

or

- ▶ Remove the KEYLESS-GO start/stop button from the starter switch.
- ▶ Start the engine with the SmartKey as radio signals from another source may be interfering with the KEYLESS-GO function.
- ▶ Repeat the starting procedure.

If the engine does not start after several starting attempts:

- ▶ Contact an authorized Mercedes-Benz Center or call Roadside Assistance.

The engine does not start. You cannot hear the starter.

The battery may not be charged sufficiently.

- ▶ Get a jump start (▷ page 323).

If the engine will not start despite a jump start:

- ▶ Contact an authorized Mercedes-Benz Center or call Roadside Assistance.

The starter has been exposed to excessive temperatures.

- ▶ Let the starter cool for about 2 minutes.
- ▶ Repeat the starting procedure.

If the engine does not start after several starting attempts:

- ▶ Contact an authorized Mercedes-Benz Center or call Roadside Assistance.

Driving off

Warning!

On slippery road surfaces, never downshift in order to obtain braking action. This could result in drive wheel slip and reduced vehicle control. Your vehicle's ABS will not prevent this type of loss of control.

- ❗ Do not run a cold engine at high engine speeds. Running a cold engine at high engine speeds may shorten the service life of the engine. This is not covered by the Mercedes-Benz Limited Warranty.

C 63 AMG: At engine temperatures below 68°F (20°C), the engine's maximum speed is restricted in order to protect it from damage. Avoid driving your vehicle at full speed when the engine is cold to prevent premature engine wear and/or diminished comfort.

- ❗ If an acoustic warning sounds and the message Release Parking Brake appears in the multifunction display when driving off, you have forgotten to release the parking brake.

Release the parking brake.

- ❗ Avoid spinning of a drive wheel. This may cause serious damage to the drivetrain which is not covered by the Mercedes-Benz Limited Warranty.

- ❗ Simultaneously depressing the accelerator pedal and applying the brakes reduces engine performance and causes premature brake and drivetrain wear which is not covered by the Mercedes-Benz Limited Warranty.

- i Once the vehicle is in motion, the automatic central locking function engages and the locking knobs in the doors move down.

The automatic central locking function can be switched off (▷ page 135).

Manual transmission

- ▶ Depress the brake pedal.
- ▶ Fully depress the clutch pedal.
- ❗ Only shift the manual transmission into reverse gear **R** when the vehicle is stopped. Otherwise the manual transmission could be damaged.
- ▶ Shift the manual transmission into **1st** gear or reverse gear **R**.
- ▶ If engaged, release the parking brake.
- ▶ Release the brake pedal.
- ▶ Simultaneously slowly release the clutch pedal and carefully depress the accelerator pedal.
- ❗ Avoid driving at excessive engine speeds. This may result in serious engine damage that is not covered by the Mercedes-Benz Limited Warranty.
Shift gear in a timely manner.

For more information on driving, see “Driving instructions” (▷ page 254).

Automatic transmission

Warning!

It is dangerous to shift the automatic transmission out of park position **P** or neutral position **N** if the engine speed is higher than idle speed. If your foot is not firmly on the brake pedal, the vehicle could accelerate quickly forward or in reverse. You could lose control of the vehicle and hit someone or something. Only shift into gear when the engine is idling normally and when your right foot is firmly on the brake pedal.

- ❗ Only shift the automatic transmission into reverse gear **R** or park position **P** when the vehicle is stopped. Otherwise the automatic transmission could be damaged.

- ▶ Depress the brake pedal.
The gear selector lever lock is released.
- ▶ Shift the automatic transmission into drive position **D** or reverse gear **R**.
- ❗ Shifting the automatic transmission out of park position **P** is only possible with the brake pedal depressed.
Only depressing the brake pedal releases the gear selector lever lock.

- ▶ Wait for the gear selection process to complete before setting the vehicle in motion.
 - ▶ If engaged, release the parking brake.
 - ▶ Release the brake pedal.
 - ▶ Carefully depress the accelerator pedal.
After a cold start, the automatic transmission shifts at a higher engine speed. This allows the catalytic converter to reach its operating temperature earlier.
- For more information on driving, see “Driving instructions” (▷ page 254).

Problems while driving

The engine runs erratically and misfires

- An ignition cable may be damaged.
- The engine electronics may not be operating properly.
- Unburned gasoline may have entered the catalytic converter and damaged it.
- ▶ Give very little gas.
- ▶ Have the problem checked at an authorized Mercedes-Benz Center as soon as possible.

The coolant temperature is above 248°F (120°C)

The coolant is too hot and is no longer cooling the engine.

- ▶ Stop the vehicle in a safe location as soon as possible.
- ▶ Turn off the engine immediately.

تلفن شماره روزی: ۰۸۵-۸۸۶۲۰۲۱

FarmaSOS.com

- ▶ Allow the engine and coolant to cool off.
- ▶ Check the coolant level and add coolant if necessary (▷ page 227).

In case of accident

If the vehicle is leaking fuel:

- ▶ Do not start the engine under any circumstances.
- ▶ Exit the vehicle at a safe distance from the roadway.
- ▶ Notify local fire and/or police authorities.

If the extent of the damage cannot be determined:

- ▶ Contact an authorized Mercedes-Benz Center or call Roadside Assistance.

If no damage on major assemblies, fuel system, and engine mount can be determined:

- ▶ Start the engine in the usual manner.

- Automatic transmission: Shift the automatic transmission into park position **P**.
- Slowly release the brake pedal.
- When parked on an incline, always turn the front wheels towards the road curb.
- Turn the SmartKey in the starter switch to position **0** and remove the SmartKey from the starter switch, or press the KEYLESS-GO start/stop button.
- Take the SmartKey with you and lock the vehicle when leaving.

Warning!

Manual transmission:

Wait until the vehicle is stationary before removing the SmartKey from the starter switch. The vehicle cannot be steered when the SmartKey is removed from the starter switch.

Parking

Warning!

Do not park this vehicle in areas where combustible materials such as grass, hay or leaves can come into contact with the hot exhaust system. These materials could be ignited and cause a vehicle fire.

Vehicle movement can cause serious personal injury or damage to the vehicle or the vehicle drivetrain. Therefore, always do the following before turning off the engine and leaving the vehicle:

- Keep right foot on the brake pedal.
- Engage the parking brake.
- Manual transmission: Shift the manual transmission into **1st** gear or reverse gear **R**.

Parking brake

Warning!

Engaging the parking brake while the vehicle is in motion can cause the rear wheels to lock up. You could lose control of the vehicle and cause an accident. In addition, the vehicle's brake lights do not light up when the parking brake is engaged.

Warning!

When leaving the vehicle, always remove the SmartKey from the starter switch, take it with you, and lock the vehicle. Do not leave children unattended in the vehicle, or with access to an unlocked vehicle. Children could release the parking brake and/or shift the automatic transmission out of park position **P** (manual transmission: shift into the neutral position), either of which could result in an accident and/or serious personal injury.

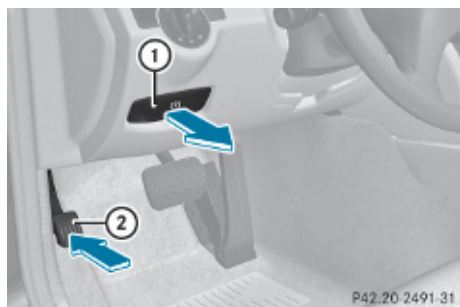

- ▶ **Releasing:** Pull on release handle ①.
When the ignition is switched on or the engine is running, the brake warning lamp **BRAKE** (USA only) or **(D)** (Canada only) in the instrument cluster goes out.
- ▶ **Engaging:** Step on parking brake pedal ② firmly.
When the engine is running, the brake warning lamp **BRAKE** (USA only) or **(D)** (Canada only) in the instrument cluster comes on.

Turning off the engine

Warning!

Do not turn off the engine before the vehicle has come to a complete stop. With the engine not running, there is no power assistance for the brake and steering systems. In this case, it is important to keep in mind that a considerably higher degree of effort is necessary to brake and steer the vehicle.

- ▶ Manual transmission: Shift the manual transmission into **1st** gear or reverse gear **R**.
 - ▶ Automatic transmission: Shift the automatic transmission into park position **P**.
 - ▶ Engage the parking brake.
- i** Always engage the parking brake in addition to shifting the automatic transmission into park position **P** (manual

transmission: shifting into **1st** gear or reverse gear **R**).

With SmartKey

- ▶ Turn the SmartKey in the starter switch to position **0**.
- ▶ Remove the SmartKey from the starter switch.

Automatic transmission: The SmartKey can only be removed from the starter switch with the automatic transmission in park position **P**.

With KEYLESS-GO

- ▶ Press the KEYLESS-GO start/stop button. With the driver's door closed, the starter switch is now in position **1**. With the driver's door opened, the starter switch is set to position **0**, same as the SmartKey removed from the starter switch (▶ page 77).

If an acoustic warning sounds, you have tried to turn off the engine with the KEYLESS-GO start/stop button while the automatic transmission was not in park position **P**.

Read and observe messages that may appear in the multifunction display (▶ page 276).

- i** In an emergency you can turn off the engine while driving by pressing and holding the KEYLESS-GO start/stop button for approximately 3 seconds.

If you have started the engine with the KEYLESS-GO start/stop button and cannot turn it off as described above:

- ▶ Remove the KEYLESS-GO start/stop button from the starter switch.
- ▶ Insert the SmartKey into the starter switch. The engine turns off. The starter switch is in position **0** (▶ page 77).

Manual transmission

Introduction

For information on driving with a manual transmission, see “Driving and parking” (▷ page 101).

Warning!

Make sure absolutely no objects are obstructing the pedals' range of movement. Keep the driver's footwell clear of all obstacles. If there are any floor mats or carpets in the footwell, make sure the pedals still have sufficient clearance.

During sudden driving or braking maneuvers the objects could get caught between or under the pedals. You could then no longer brake or accelerate. This could lead to accidents and injury.

Warning!

When working on the vehicle, engage the parking brake and shift the manual transmission into **1st** gear or reverse gear **R**. Otherwise the vehicle could roll away which could result in an accident and/or serious personal injury.

- !** Allow the engine to warm up under low load use. Do not place full load on the engine until the operating temperature has been reached.

Avoid spinning of a drive wheel for an extended period when driving off on slippery road surfaces.

This may cause serious damage to the engine and the drivetrain which is not covered by the Mercedes-Benz Limited Warranty.

Gearshift lever

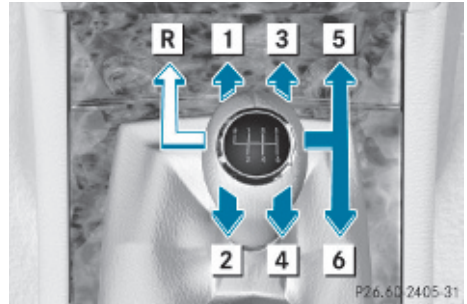

Gearshift pattern for manual transmission

- R** Reverse gear
- 1** to **6** Forward gears

Warning!

On slippery road surfaces, never downshift in order to obtain braking action. This could result in drive wheel slip and reduced vehicle control. Your vehicle's ABS will not prevent this type of loss of control.

- !** When you are shifting the manual transmission into the **5th** or **6th** gear, make sure you move the gearshift lever to the right. Otherwise, you could accidentally shift into the **3rd** or **4th** gear and damage the manual transmission.

Downshifting gears leading to overrevving the engine can result in engine damage that is not covered by the Mercedes-Benz Limited Warranty.

Never hold the vehicle stopped on a hill by using the clutch pedal. The clutch may be damaged which is not covered by the Mercedes-Benz Limited Warranty.

- !** Avoid driving at excessive engine speeds. This may result in serious engine damage that is not covered by the Mercedes-Benz Limited Warranty.
- Shift gear in a timely manner.

Shifting into reverse gear R

! Only shift the manual transmission into reverse gear **R** when the vehicle is stopped. Otherwise the manual transmission could be damaged.

- ▶ Stop the vehicle completely.
- ▶ Fully depress the clutch pedal.
- ▶ Shift the manual transmission into the neutral position (no gear selected).
- ▶ Move the gearshift lever to the left until you feel a certain resistance.
- ▶ Push the gearshift lever past this resistance and hold.
- ▶ Move the gearshift lever forward to select reverse gear **R**.

Automatic transmission

Introduction

For information on driving with an automatic transmission, see “Driving and parking” (▷ page 101).

⚠ Warning!

Make sure absolutely no objects are obstructing the pedals' range of movement. Keep the driver's footwell clear of all obstacles. If there are any floor mats or carpets in the footwell, make sure the pedals still have sufficient clearance.

During sudden driving or braking maneuvers the objects could get caught between or under the pedals. You could then no longer brake or accelerate. This could lead to accidents and injury.

! Allow the engine to warm up under low load use. Do not place full load on the engine until the operating temperature has been reached.

Avoid spinning of a drive wheel for an extended period when driving off on slippery road surfaces.

This may cause serious damage to the engine and the drivetrain which is not covered by the Mercedes-Benz Limited Warranty.

- i** During the brief warm-up, transmission upshifting is delayed. This allows the catalytic converter to heat up more quickly to operating temperature.

Gear selector lever

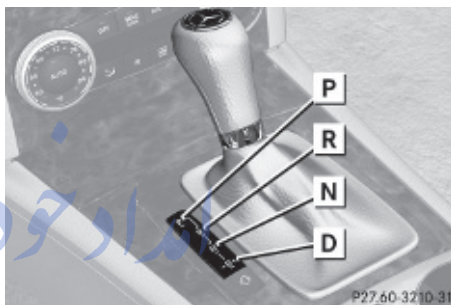

Gearshift pattern for automatic transmission

- P** Park position with gear selector lever lock
- R** Reverse gear
- N** Neutral position
- D** Drive position

⚠ Warning!

It is dangerous to shift the automatic transmission out of park position **P** or neutral position **N** if the engine speed is higher than idle speed. If your foot is not firmly on the brake pedal, the vehicle could accelerate quickly forward or in reverse. You could lose control of the vehicle and hit someone or something. Only shift into gear when the engine is idling normally and when your right foot is firmly on the brake pedal.

! Only shift the automatic transmission into reverse gear **R** or park position **P** when the vehicle is stopped. Otherwise the automatic transmission could be damaged.

i Shifting the automatic transmission out of park position **P** is only possible with the brake pedal depressed.

Only depressing the brake pedal releases the gear selector lever lock.

i The current gear selector lever position corresponds with the current transmission position.

The current transmission position **P**, **R**, **N**, or **D** appears in the multifunction display (▷ page 109).

There are additional indicators on the cover of the shifting gate showing the current gear selector lever position.

The indicators come on when you insert the SmartKey into the starter switch, and go out when you remove the SmartKey from the starter switch.

sporty driving. The degree to which you perceive double-clutching acoustically varies depending on the selected program mode.

Transmission positions

The current transmission position appears in the multifunction display.



① Transmission position indicator

Shifting procedure

The automatic transmission selects individual gears automatically, depending on

- the selected gear range (▷ page 111)
- the selected program mode:
 - C/S** (▷ page 111)
 - or
 - M** (vehicles with dynamic handling package and C 63 AMG only) (▷ page 113)
- the position of the accelerator pedal
- the vehicle speed

With drive position **D** selected, you can influence transmission shifting by

- limiting the gear range
- extending the gear range
- changing the gears manually (vehicles with dynamic handling package and C 63 AMG only)

C 63 AMG:

Double-clutching is active when downshifting in all program modes. Double-clutching reduces load-alteration effects and supports

	Effect
P	<p>Park position</p> <p>Shift the automatic transmission into park position P only when the vehicle is stopped. The park position is not intended to serve as a brake when the vehicle is parked. Rather, the driver should always engage the parking brake in addition to shifting the automatic transmission into park position P to secure the vehicle.</p> <p>The SmartKey can only be removed from the starter switch with the gear selector lever in park position P. With the SmartKey removed from the starter switch, the gear selector lever is locked in park position P. If the vehicle's electrical system is malfunctioning, the gear selector lever could remain locked in park position P. To unlock the gear selector lever manually, see "Manually unlocking the gear selector lever" (▷ page 311).</p>
R	<p>Reverse gear</p> <p>Shift the automatic transmission into reverse gear R only when the vehicle is stopped.</p>

	Effect
N	<p>Neutral position</p> <p>No power is transmitted from the engine to the drive axle. When the brakes are released, the vehicle can be moved freely (pushed or towed).</p> <p>To avoid damage to the transmission, never shift the automatic transmission into neutral position N while driving.</p> <p>Exception: If the ESP® is switched off or malfunctioning, shift the automatic transmission into neutral position N if the vehicle is in danger of skidding.</p> <p>! Coasting the vehicle, or driving for any other reason with the automatic transmission in neutral position N can result in transmission damage that is not covered by the Mercedes-Benz Limited Warranty.</p>
D	<p>Drive position</p> <p>The automatic transmission shifts automatically. All forward gears are available.</p>

Driving tips

Kickdown

Use the kickdown when you want maximum acceleration.

► **U.S. vehicles except AMG vehicles:**

Fully depress the accelerator pedal.

Depending on the engine speed the automatic transmission shifts into a lower gear.

► **Canada vehicles and AMG vehicles:**

Depress the accelerator pedal past the point of resistance.

Depending on the engine speed the automatic transmission shifts into a lower gear.

Working on the vehicle

Warning!

When working on the vehicle, engage the parking brake and shift the automatic transmission into park position **P**. Otherwise the vehicle could roll away which could result in an accident and/or serious personal injury.

Gear ranges

With the automatic transmission in drive position **D** and driving in automatic program mode **C** or **S**, you can limit or extend the gear range, see “One-touch gearshifting” (▷ page 112).

The current gear range appears in the multifunction display.



① Gear range indicator

	Effect
3	With this selection you can use the braking effect of the engine.
2	Allows the use of the engine's braking effect when driving <ul style="list-style-type: none"> • on steep downgrades • in mountainous regions • under extreme operating conditions
1	For maximum use of the engine's braking effect on very steep or lengthy downgrades.

Automatic shift program



Program mode selector switch

C Comfort	For comfort driving
S Sport	For sporty driving

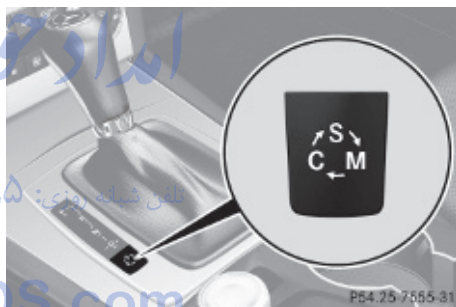

Program mode selector switch on C 63 AMG

C Comfort	For standard driving
S Sport	For sporty driving
M Manual	For manual gearshifting

The current program mode appears in the multifunction display.



① Program mode indicator

You should only change the program mode when the automatic transmission is in park position **P**.

Automatic program mode **S** will not be stored. When the engine is turned off with the automatic program mode **S** selected, the automatic transmission will go to the automatic program mode **C** when the engine is restarted.

- ▶ Press the program mode selector switch repeatedly until the letter of the desired program mode appears in the multifunction display.

For selecting automatic program mode (**C** or **S**) on vehicles with dynamic handling package, see “Dynamic handling package with sport driving mode” (▷ page 184).

Selecting program mode **C** means:

- The vehicle starts out more gentle, both forward and reverse, except when driving off with full throttle.
- Traction and driving stability are improved on icy roads.
- Upshifts occur earlier even when you give more gas. The engine then operates at lower revolutions and the wheels are less likely to spin.

Selecting program mode **S** means that upshifts occur later.

One-touch gearshifting

With the automatic transmission in drive position **D** and driving in automatic program mode **C** or **S**, you can limit or extend the gear range using the gear selector lever or the steering wheel gearshift control.

Steering wheel gearshift control is available on vehicles with dynamic handling package and on C 63 AMG only.

Vehicles with dynamic handling package and C 63 AMG: For information on using the gear selector lever or the steering wheel gearshift control in manual program mode **M**, see “Manual shift program” (▷ page 113).



Steering wheel gearshift control (example illustration)

- ❗ You cannot shift with the steering wheel gearshift control when the automatic transmission is in park position **P**, neutral position **N**, or reverse gear **R**.

Limiting gear range

⚠ Warning!

On slippery road surfaces, never downshift in order to obtain braking action. This could result in drive wheel slip and reduced vehicle control. Your vehicle's ABS will not prevent this type of loss of control.

- ▶ Briefly press the gear selector lever to the left in the **D-** direction.

or

- ▶ Briefly pull left gearshift control ①.
The automatic transmission will shift into the next lower gear as permitted by the shift program. This action simultaneously limits the gear range of the automatic transmission.

- ① To avoid overrevving the engine when downshifting, the automatic transmission will not shift into a lower gear if the engine's maximum speed would be exceeded.

Extending gear range

- ▶ Briefly press the gear selector lever to the right in the **D+** direction.

or

- ▶ Briefly pull right gearshift control ②.
The automatic transmission will shift into the next higher gear as permitted by the shift program. This action simultaneously extends the gear range of the automatic transmission.

- ① If you press on the accelerator pedal when the engine has reached the revolution limit of the current gear range, the automatic transmission will upshift beyond any gear range limit selected.

Canceling gear range limit

- ▶ Press and hold the gear selector lever to the right in the **D+** direction until the gear range indicator disappears from the multifunction display.

or

- ▶ Pull and hold right gearshift control ② until the gear range indicator disappears from the multifunction display.
The automatic transmission will shift from the current gear range directly into drive position **D**.

Shifting into optimal gear range

- ▶ Press and hold the gear selector lever to the left in the **D-** direction.

or

- ▶ Pull and hold left gearshift control ①.
The automatic transmission will select the gear range suited for optimal acceleration and deceleration automatically. This will involve shifting down one or more gears.

Manual shift program

The manual shift program is available on vehicles with dynamic handling package and on C 63 AMG only.

Manual program mode **M** differs with regard to spontaneity, response time, and shifting smoothness from automatic program mode **S**.

In manual program mode **M**, system-controlled automatic gearshifting is switched off. You need to change the gears by manually upshifting or downshifting using the gear selector lever or the steering wheel gearshift control.



Program mode selector switch on vehicles with dynamic handling package

M Manual

For manual gearshifting



Program mode selector switch on C 63 AMG

C Comfort	For standard driving
S Sport	For sporty driving
M Manual	For manual gearshifting

The current program mode appears in the multifunction display (▷ page 112).

For information on automatic program mode (**C** or **S**), see “Automatic shift program” (▷ page 111) and “One-touch gearshifting” (▷ page 112).

Activating manual shift program

- ▶ Vehicles with dynamic handling package:
Press the program mode selector switch once.
M appears in the multifunction display.
The automatic transmission switches to manual program mode **M**. Automatic shifting is switched off. The gear range is not limited.
- ▶ C 63 AMG: Press the program mode selector switch repeatedly until **M** appears in the multifunction display.
The automatic transmission switches to manual program mode **M**. Automatic shifting is switched off. The gear range is not limited.

You can change the gears manually with drive position **D** selected. You can upshift or downshift through the gears in succession.

i Vehicles with dynamic handling package: Manual program mode **M** will not be stored. When the engine is turned off with manual program mode **M** selected, the automatic transmission will go to automatic program mode **C** when the engine is restarted.

i C 63 AMG: Manual program mode **M** will not be stored. When the engine is turned off with manual program mode **M** selected, the automatic transmission will go to automatic program mode (**C** or **S**) when the engine is restarted.

Upshifting

i Vehicles with dynamic handling package: If you press on the accelerator pedal when the engine has reached the revolution limit of the current gear, the automatic transmission will upshift beyond manual program mode **M** selected.

! C 63 AMG:

In manual program mode **M**, the automatic transmission will not upshift, even if the engine has reached its overrevving range. Shift up into the next gear before the engine has reached its overrevving range. Make absolutely certain that the engine speed does not reach the red marking on the tachometer. Otherwise the engine could be damaged which is not covered by the Mercedes-Benz Limited Warranty.

- ▶ Briefly press the gear selector lever to the right in the **D+** direction.

or

- ▶ Briefly pull right gearshift control ② (▷ page 112).
The automatic transmission shifts into the next higher gear.

Upshift indicator (C 63 AMG only)



In manual program mode **M**, upshift indicator ② in the multifunction display advises you to upshift before the engine reaches the overspeed range. Thus you can drive at the maximum engine speed for each gear without overrevving the engine.

- ▶ Shift the automatic transmission from current gear ① into the next higher gear. The fuel supply will otherwise be interrupted to prevent the engine from overrevving.

Downshifting

⚠ Warning!

On slippery road surfaces, never downshift in order to obtain braking action. This could result in drive wheel slip and reduced vehicle control. Your vehicle's ABS will not prevent this type of loss of control.

- ▶ Briefly press the gear selector lever to the left in the **D**- direction.

or

- ▶ Briefly pull left gearshift control ① (▷ page 112). The automatic transmission shifts into the next lower gear.

- ① Vehicles with dynamic handling package: To avoid overrevving the engine when downshifting, the automatic transmission will not shift into a lower gear if the engine's maximum speed would be exceeded.

- ① For maximum acceleration, press and hold the gear selector lever to the left in the **D**- direction or pull and hold the left gearshift control. Depending on the engine speed the automatic transmission selects the optimal gear for maximum acceleration.

- ① When you brake or stop, the automatic transmission shifts down into a gear from which you can easily accelerate or take off.

Kickdown

AMG vehicles: Using the kickdown while driving in manual program mode **M** is not possible.

All vehicles except AMG vehicles: You can also use the kickdown while driving in manual program mode **M** when you want maximum acceleration.

- ▶ **U.S. vehicles:** Fully depress the accelerator pedal. Depending on the engine speed the automatic transmission shifts into a lower gear.
- ▶ **Canada vehicles:** Depress the accelerator pedal past the point of resistance. Depending on the engine speed the automatic transmission shifts into a lower gear.

- ① You cannot shift with the gear selector lever or the steering wheel gearshift control when using the kickdown.

Deactivating manual shift program

- ▶ Vehicles with dynamic handling package: Press the program mode selector switch once more.

The last selected automatic program mode **C** or **S** appears in the multifunction display.

or

- ▶ Restart the engine.
The automatic transmission will go to the last selected automatic program mode (**C** or **S**).
- ▶ C 63 AMG: Press the program mode selector switch repeatedly until **C** or **S** appears in the multifunction display.

or

- ▶ Restart the engine.
The automatic transmission will go to automatic program mode (**C** or **S**).

Manual program mode **M** is not stored.

Emergency operation (limp-home mode)

If vehicle acceleration becomes less responsive or sluggish or the automatic transmission no longer shifts, the automatic transmission is most likely operating in limp-home (emergency operation) mode. In this mode only second gear and reverse gear **R** can be selected.

- ▶ Stop the vehicle in a safe location.
- ▶ Shift the automatic transmission into park position **P**.
- ▶ Turn off the engine.
- ▶ Wait at least 10 seconds before restarting.
- ▶ Restart the engine.
- ▶ Shift the automatic transmission into drive position **D** (for second gear) or reverse gear **R**.
- ▶ Have the automatic transmission checked at an authorized Mercedes-Benz Center as soon as possible.

Transfer case

This section applies to vehicles equipped with all-wheel drive (4MATIC) only. Both the front and rear axles are powered at all times when the vehicle is being operated.

! Only conduct operational or performance tests on a two-axle dynamometer. If such tests are necessary, contact an authorized Mercedes-Benz Center. You could otherwise seriously damage the brake system or the transfer case which is not covered by the Mercedes-Benz Limited Warranty.

! Because the ESP[®] operates automatically, the engine and ignition must be shut off (SmartKey in starter switch position **0** or **1** or KEYLESS-GO start/stop button in position **0** or **1**) when the parking brake is being tested on a brake test dynamometer.

Active braking action through the ESP[®] may otherwise seriously damage the brake system which is not covered by the Mercedes-Benz Limited Warranty.

Instrument cluster

Introduction

For a full view illustration of the instrument cluster, see “Instrument cluster” (▷ page 28).

! Warning!

No messages will be displayed if either the instrument cluster or the multifunction display is inoperative.

As a result, you will not be able to see information about your driving conditions, such as

- speed
- outside temperature
- warning/indicator lamps

- malfunction/warning messages
- failure of any systems

Driving characteristics may be impaired.

If you must continue to drive, do so with added caution. Contact an authorized Mercedes-Benz Center as soon as possible.

The language setting for the multifunction display can be changed with the audio system (▷ page 148) or with the COMAND system. Vehicles with COMAND system: Refer to separate operating instructions.

Activating the instrument cluster

The instrument cluster is activated when you

- open the driver's door
- switch on the ignition

Adjusting the instrument cluster illumination



► **To brighten illumination:** Turn dimmer ① clockwise.

► **To dim illumination:** Turn dimmer ① counterclockwise.

i The instrument cluster illumination is dimmed or brightened automatically to suit ambient light conditions.

The instrument cluster illumination will also be adjusted automatically when you switch on the vehicle's exterior lamps.

Coolant temperature gauge

The coolant temperature gauge is located on the left side in the instrument cluster (▷ page 28).

⚠ Warning!

Driving when your engine is overheated can cause some fluids which may have leaked into the engine compartment to catch fire. You could be seriously burned.

Steam from an overheated engine can cause serious burns which can occur just by opening the engine hood. Stay away from the engine if you see or hear steam coming from it.

Stop the vehicle in a safe location away from other traffic. Turn off the engine, get out of the vehicle and do not stand near the vehicle until the engine has cooled down.

During severe operating conditions, e.g. stop-and-go traffic, the coolant temperature may rise close to 248°F (120°C), i.e. close to the red zone of the temperature gauge.

! Excessive coolant temperature triggers a warning in the multifunction display.

The engine should not be operated with a coolant temperature above 248°F (120°C), i.e. in the red zone of the coolant temperature gauge. Doing so may cause serious engine damage which is not covered by the Mercedes-Benz Limited Warranty.

Tachometer

The red marking on the tachometer (▷ page 28) denotes excessive engine speed.

! Avoid driving at excessive engine speeds, as it may result in serious engine damage that is not covered by the Mercedes-Benz Limited Warranty.

To help protect the engine, the fuel supply is interrupted if the engine is operated within the red marking.

Outside temperature indicator

The outside temperature indicator is displayed in the multifunction display (▷ page 120).

Warning!

The outside temperature indicator is not designed to serve as an ice-warning device and is therefore unsuitable for that purpose.

Indicated temperatures just above the freezing point do not guarantee that the road surface is free of ice. The road may still be icy, especially in wooded areas or on bridges.

Fuel gauge

The fuel gauge is on the left-hand side of the instrument cluster (▷ page 28). Once the fuel level has fallen below the reserve mark, the yellow fuel tank reserve warning lamp  for the fuel reserve comes on.

Control system

Introduction

The control system is activated as soon as the starter switch is in position 2.

The control system enables you to call up information about your vehicle and to change vehicle settings.

For example, you can use the control system to find out when your vehicle is next due for maintenance service, to call up statistical data on your vehicle, and much more.

Warning!

A driver's attention to the road and traffic conditions must always be his/her primary focus when driving.

For your safety and the safety of others, selecting features through the multifunction steering wheel should only be done by the

driver when traffic and road conditions permit it to be done safely.

Bear in mind that at a speed of just 30 mph (approximately 50 km/h), your vehicle is covering a distance of 44 feet (approximately 14 m) every second.

The control system relays information to the multifunction display.





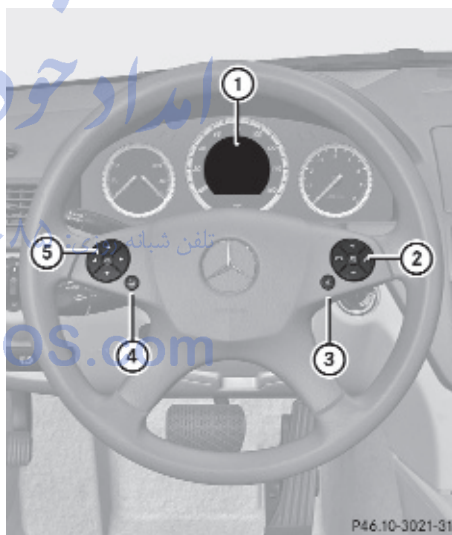

Multifunction steering wheel

The displays in the multifunction display and the settings in the control system are controlled by using the buttons on the multifunction steering wheel.















① Multifunction display

② Press button

-  to end a call
-  to reject an incoming call
-  to answer a call
-  to dial⁷
-  to redial⁷
-  to mute

⁷ Function only available in telephone menu.

	Press button  to set the volume  to operate the RACETIMER ⁸
③	Press button  to activate the Voice Control System ⁹
④	Press button briefly  to cancel the Voice Control System ⁹ to go back to confirm messages
	Press and hold button  to select the standard display
⑤	Press button  to call up line for menus and to  select menus
	Press button briefly  to select submenu or scroll  through lists within Audio menu to select previous or next track, scene or stored station within Te1 menu to switch to the phone book and select a name or number

	Press and hold button  within Audio menu to select a track or scene with quick search or to select previous or next station in station list or wave band  within Te1 menu to start the quick search in the phone book
	Press button  to confirm selection or messages

Depending on the selected menu, pressing the buttons on the multifunction steering wheel will alter what appears in the multifunction display.

The information available in the multifunction display is arranged in menus and accompanying functions and submenus.

The individual functions are then found within the relevant menu (radio or CD operations under Audio, for example). These functions serve to call up relevant information or to customize the settings for your vehicle.

It is helpful to think of the menus, and the functions within each menu, as being arranged in a circular pattern.



In the Settings menu, instead of functions, you will find a number of submenus for calling up and changing settings. For instructions on using these submenus, see “Settings menu” (> page 130).



The number of menus available in the system depends on which optional equipment is installed in your vehicle.

⁸ AMG vehicles only.

⁹ The Voice Control System is only available with the COMAND system. Refer to separate operating instructions.

Using the control system

▶ **To select a menu:** Press button  or .

▶ **To select a submenu:** Press button  or .



▶ **To go to the next higher menu level:** Press button .

▶ **To select the standard display:** Press button  repeatedly until the standard display featuring the odometer and speedometer appears.

or

▶ Press and hold button  until the standard display featuring the trip odometer and the main odometer appears.

▶ **To confirm selection:** Press button .

▶ **To confirm display message:** Press button  or . The control system saves certain display messages. Calling up display messages (> page 129).

For information about warning and malfunction messages appearing in the multifunction display (> page 270).

- ③ Outside temperature indicator
- ④ Automatic transmission program mode indicator
- ⑤ Transmission position/gear range indicator (automatic transmission)
Additional speedometer (manual transmission)
- ⑥ Digital clock

Settings, functions, submenus as well as any malfunctions appear in the text field.

For more information on menus displayed in the multifunction display, see “Menus and submenus” (> page 121).

Multifunction display



- ① Text field
- ② Line for main menus

امداد خودرو فارما

تلفن شبانه روزی: ۰۸۵۶۲۰۸۵

FarmaSOS.com

Menus and submenus

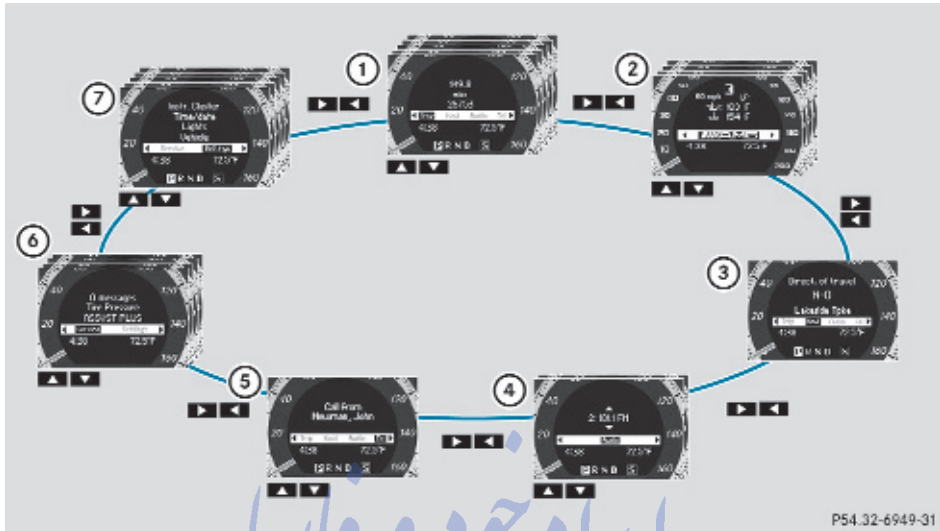

P54.32-6949-31

	Function
①	Trip menu (▷ page 121)
②	AMG¹⁰ menu (▷ page 123)
③	Navi menu (▷ page 126)
④	Audio menu (▷ page 126)
⑤	Tel menu (▷ page 128)
⑥	Service menu (▷ page 129)
⑦	Settings menu (▷ page 130)

- Fuel consumption statistics since last reset (▷ page 122)
- Resetting values (▷ page 122)
- Remaining driving range and current fuel consumption (▷ page 123)
- Digital Speedometer (▷ page 123)

Standard display

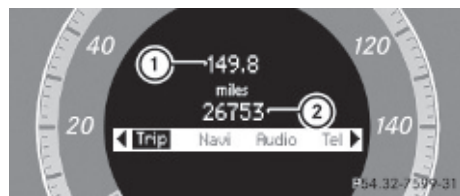

P54.32-7599-31

Trip menu

In the Trip menu, you can show an additional display for the speedometer and call up or reset your vehicle's statistical data.

The following information is available:

- Standard display (▷ page 121)
- Fuel consumption statistics since start (▷ page 122)

In the standard display, the trip odometer ① and the main odometer ② appear in the multifunction display.

If another display appears instead of the standard display:

- ▶ Press button ◀ or ▶ to select the Trip menu.

or





¹⁰ AMG vehicles only.

- ▶ Press button  repeatedly until the standard display appears.

or

- ▶ Press and hold button  until the standard display appears.

Fuel consumption statistics since start



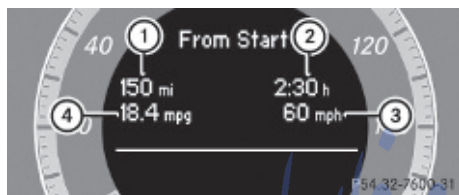

- ▶ Press button  or  to select the Trip menu.
- ▶ Press button  or  to select From Start.



- ① Distance driven since start
- ② Time elapsed since start
- ③ Average speed since start
- ④ Average fuel consumption since start

All statistics stored since the last engine start will be reset approximately 4 hours after the SmartKey in the starter switch is turned to position **0** or removed from the starter switch. Resetting will not occur if you turn the SmartKey back to position **1** or **2** within this time period.

Fuel consumption statistics since last reset

- ▶ Press button  or  to select the Trip menu.
- ▶ Press button  or  to select From Reset.

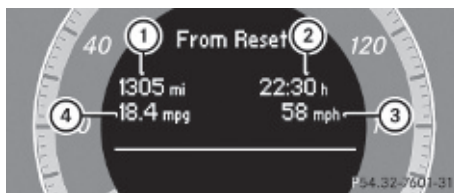





- ① Distance driven since last reset
- ② Time elapsed since last reset
- ③ Average speed since last reset
- ④ Average fuel consumption since last reset

Resetting values

You can reset the values for the following functions:

- Trip odometer
- Fuel consumption statistics since start
- Fuel consumption statistics since last reset



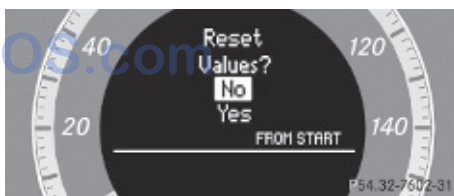

- ▶ Press button  or  to select the Trip menu.
- ▶ Press button  or  to select the function you wish to reset.
- ▶ Press button .



Example illustration: Reset fuel consumption statistics since start

- ▶ Press button  to select Yes.
- ▶ Press button  to confirm.

Remaining driving range and current fuel consumption



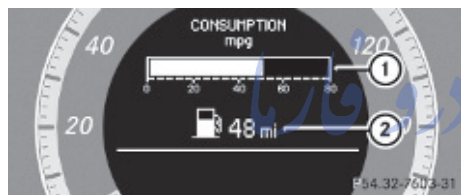

- ▶ Press button  or  to select the Trip menu.
 - ▶ Press button  or  to select the estimated remaining driving range and current fuel consumption display.
- Note that the values are calculated based on the current fuel tank level and the current driving style. Make sure to refuel in time.

If only very little fuel is left in the tank, a vehicle at the fuel pump  appears instead of the estimated remaining driving range.



- ① Current fuel consumption¹¹
- ② Estimated remaining driving range

Digital speedometer

- ▶ Press button  or  to select the Trip menu.
- ▶ Press button  or  to select the digital speedometer.

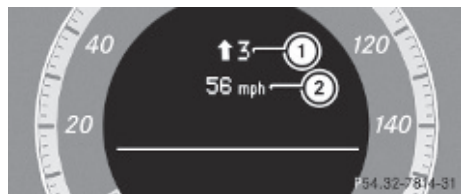



Example illustration for upshift indicator

- ① Upshift indicator¹²
- ② Digital speedometer

The shift indicator is meant as a recommendation for an economical driving style. Always observe traffic conditions, as your driving style is determined in the first instance by the traffic situation.

AMG menu

This function is only available in AMG vehicles.



- ▶ Press button  or  to select the AMG menu.



- ① Digital speedometer
- ② Gear indicator
- ③ Upshift indicator
- ④ Engine oil temperature indicator
- ⑤ Coolant temperature indicator

The engine oil temperature flashes if the engine oil temperature has not yet reached 176°F (80°C). During this time, avoid driving at full engine speed.

The upshift indicator ③ indicates that the engine has reached the overrevving range. The upshift indicator ③ blocks other messages in the multifunction display until you have shifted up.

Use buttons  or  to select the following functions in the AMG menu:

¹¹ Not available on AMG vehicles.

¹² Vehicles with manual transmission only

- SETUP (▷ page 124)
- RACETIMER (▷ page 124)
- Overall analysis (▷ page 125)
- Lap analysis (▷ page 126)

SETUP

- ▶ Press button or to select the AMG menu.
- ▶ Press button to select SETUP.

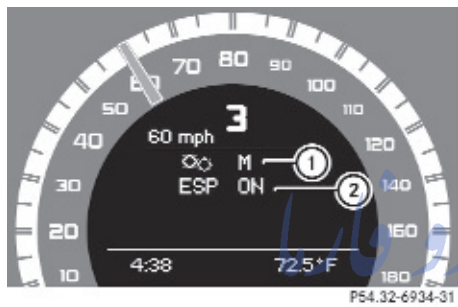

- ① Automatic transmission program mode indicator
- ② ESP mode indicator

RACETIMER

Warning!

The RACETIMER feature is only for use on roads and in conditions where high speed driving is permitted. Racing on public roads is prohibited under all circumstances. The driver is and must always remain responsible for following posted speed limits.

The RACETIMER allows you to time and save driving stretches.

- ▶ Press button or to select the AMG menu.
- ▶ Press button repeatedly until the RACETIMER appears in the multifunction display.

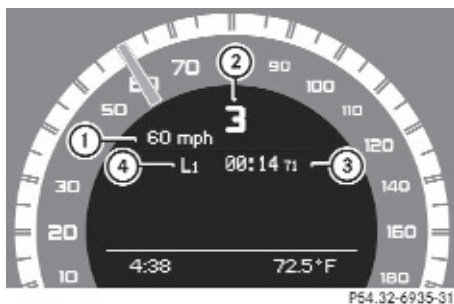

- ① Digital speedometer
- ② Gear indicator
- ③ RACETIMER
- ④ Lap number

You can start the RACETIMER when the engine is running or the starter switch is in position **2** (▷ page 77).

While the RACETIMER is being displayed, you cannot adjust the audio volume using buttons or .

- ▶ **Starting:** Press button .

- ▶ **Displaying intermediate time:** Press button while the timer is running. The intermediate time is shown for 5 seconds.

- ▶ **Stopping:** Press button .

When you stop the vehicle and turn the SmartKey to position **1** (▷ page 77) or, in vehicles with KEYLESS-GO, turn off the engine and do not open the driver's door, the RACETIMER stops timing. Timing is resumed when you press button after switching the ignition back on or restarting the engine.

Saving lap time and starting a new lap

You can save up to 16 laps.

- ▶ Press button while the timer is running. The intermediate time will be shown for 5 seconds.
- ▶ Press button within 5 seconds. The intermediate time shown will be saved as a lap time.

The RACETIMER begins timing the new lap. The new lap begins to be timed as soon as the intermediate time is called up.



- ① Gear indicator
- ② RACETIMER
- ③ Best lap time
- ④ Lap number

Resetting current lap

- ▶ Press button while the timer is running. The timer stops.
- ▶ Press button . The lap time is reset to "0".

Deleting all laps

It is not possible to delete a single saved lap.

- ▶ Press button while the timer is running. The timer stops.
- ▶ Press button . The reset menu appears in the multifunction display.

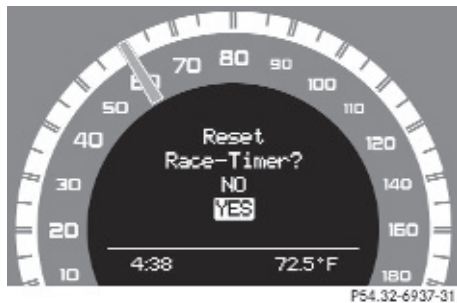

- ▶ Press button to select Yes and confirm with button . The saved laps are deleted.

Overall analysis

This function is only available if you have saved at least one lap and have stopped the RACETIMER.

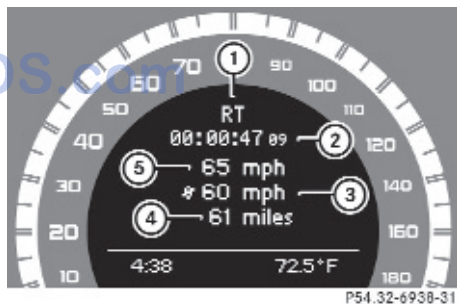

- ▶ Press button or to select the AMG menu.
- ▶ Press button repeatedly until the overall analysis appears in the multifunction display.



- ① Overall analysis of RACETIMER
- ② Overall driving time
- ③ Average speed
- ④ Overall distance driven
- ⑤ Maximum speed



Lap analysis

This function is only available if you have saved at least two laps and have stopped the RACETIMER.

- ▶ Press button  or  to select the AMG menu.
- ▶ Press button  repeatedly until the lap analysis appears in the multifunction display.

Each lap is shown in its own submenu. The fastest lap is indicated by flashing symbol ①.



- ① Lap number
 - ② Lap time
 - ③ Average speed during lap
 - ④ Lap length
 - ⑤ Maximum speed during lap
- ▶ Press button  or  to see other lap analyses.

Navi menu

The Navi menu contains the functions needed to operate your navigation system.

- ▶ Press button  or  to select the Navi menu.

The message shown in the multifunction display depends on the status of the navigation system:

- With the COMAND system switched on or off and route guidance not activated, the direction of travel and, if applicable,

the name of the street currently traveled on appear in the multifunction display.

- With the COMAND system switched on and route guidance activated, maneuver instructions appear in the multifunction display.

Please refer to separate COMAND system operating instructions for instructions on how to activate the route guidance system.



Audio menu

The functions in the Audio menu operate the audio equipment which you have currently switched on.

The following functions are available:

- Selecting radio station (▷ page 126)
- Operating audio devices/audio media (▷ page 127)
- Operating video DVD (▷ page 127)

If the audio system or the COMAND system is currently switched off, the message Audio Off appears in the multifunction display.

- ▶ **To adjust the volume:** Press button  or  on the multifunction steering wheel.

Selecting radio station

- ❗ The SIRIUS XM Satellite Radio is treated as a radio application.

Additional optional satellite radio equipment and a subscription to a satellite radio service provider are required for satellite radio operation. Contact an authorized Mercedes-Benz Center for details and availability for your vehicle.

For more information on satellite radio operation, see “Satellite radio” (▷ page 152).

Vehicles with COMAND system:
Refer to separate COMAND system operating instructions.

- ▶ Switch on the audio system (▷ page 144) and select radio mode.



Vehicles with COMAND system:
Refer to separate COMAND system operating instructions.

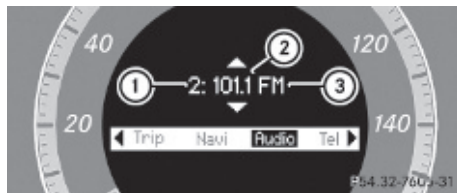

- ▶ Press button  or  to select the Audio menu.
The currently tuned station appears in the multifunction display.



Example illustration for FM radio

- ① Stored memory position
- ② Station frequency
- ③ Wave band setting

- ▶ **Selecting next or previous stored station:** Press button  or  briefly to select a stored station.

- ▶ **Selecting next or previous station in wave band:** Press and hold button  or  to select a station.

You can only store new stations using the corresponding feature on the radio (▷ page 151).



Vehicles with COMAND system:
Refer to separate COMAND system operating instructions.

You can also operate the radio in the usual manner.

Operating audio devices/audio media

- ▶ Switch on the audio system and select the CD or MP3 mode (▷ page 158).

Vehicles with COMAND system:
Refer to separate COMAND system operating instructions.

- ▶ Press button  or  to select the Audio menu. The settings for the currently

being played audio device/audio media appear in the multifunction display.



Example illustration

- ① Disc number
- ② Current track



- ▶ **Selecting next or previous track:** Press button  or  briefly.

- ▶ **Selecting a track from the track list (quick search):** Press and hold button  or .

The current track does not appear during Audio AUX mode operation.

Operating video DVD



This function is only available if your vehicle is equipped with the COMAND system.

- ▶ Switch on the COMAND system and select DVD-Video. Refer to separate COMAND system operating instructions.
- ▶ Press button  or  to select the Audio menu.



- ① Disc number
- ② Current scene

- ▶ **Selecting next or previous scene:** Press button  or  briefly.

- ▶ **Selecting a scene from the scene list (quick search):** Press and hold button  or .

Tel menu



Warning!

A driver's attention to the road must always be his/her primary focus when driving. For your safety and the safety of others, we recommend that you pull over to a safe location and stop before placing or taking a telephone call. If you choose to use the telephone while driving, please use the hands-free device and only use the telephone when weather, road and traffic conditions permit.

Some jurisdictions prohibit the driver from using a mobile phone while driving a vehicle.

Bear in mind that at a speed of just 30 mph (approximately 50 km/h), your vehicle is covering a distance of 44 feet (approximately 14 m) every second.

You can connect your telephone to the audio system (▷ page 167) or to the COMAND system via Bluetooth®, see separate COMAND system operating instructions.

- ▶ Switch on the audio system (▷ page 144) or the COMAND system, see separate COMAND system operating instructions.
- ▶ Press button  or  to select the Tel menu.

One of the following messages will appear in the multifunction display:

- No Service: No network is available.
- Ready for Bluetooth Telephony...: The telephone has not been connected to the audio system or COMAND system via Bluetooth® yet.
 - ▶ Connect the telephone to the audio system or COMAND system via Bluetooth®.
- Phone READY or name of the network provider (if available): The telephone has found a network and is ready for use. You can operate it using the control system.

Answering a call

When your telephone is ready to receive calls, you can answer a call at any time. In the multifunction display you will then see the following message:

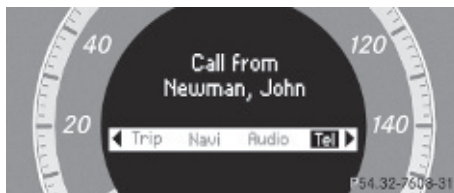

Example illustration

- ▶ Press button .

You have answered the call.

The caller's number appears only if it is transmitted.

The caller's name appears only if the number and the name are stored in the phone book.







Ending a call or rejecting an incoming call





- ▶ Press button .

Dialing a number from the phone book

When your telephone is ready to receive calls, you may select and dial a number from the phone book at any time.

- i** To use the phone book of the audio system you can import business cards (vCards) from external Bluetooth® phones into your audio system's phone book (▷ page 174). Vehicles with COMAND, see separate operating instructions.

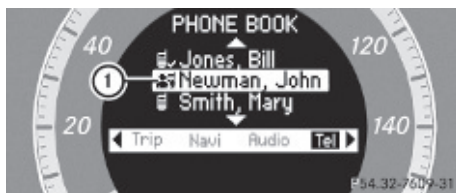

- ▶ Press button  or  to select the Tel menu.
- ▶ Press button  or  or  to switch to the phone book. The stored names are displayed in ascending alphabetical order.
- ▶ Press button  or  to select the desired entry.

If you press and hold button  or  the system scrolls rapidly through the list of names (quick search). After holding button  or  for a short while the scrolling speed increases. Release the button to stop the quick search. The search stops automatically at the end of the list.



Example illustration

① Selected name from the phone book

▶ If the Symbol  appears on the right-hand side of the name several entries are present for the same name: Press button  or  and select the desired entry.



▶ Press button  or .

The control system dials the selected phone number.

If the connection is successful and this feature is supported by your network provider, the name of the party (if stored in your phone book) you are calling will appear in the multifunction display.

The control system stores the dialed number in the redial memory.

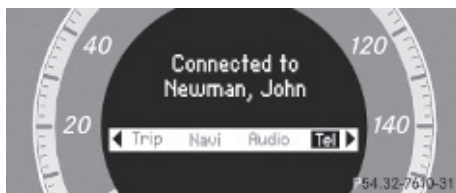

or

▶ Press button  or  if you do not want to make the call.





Redialing

The control system stores the most recently dialed phone numbers. This eliminates the need to search through your entire phone book.

▶ Press button  or  to select the Tel menu.

▶ Press button .

▶ Press button  or  to select the desired number or name.

▶ Press button  or .

The control system dials the selected phone number.

Service menu

In the Service menu the following functions are available:

- Vehicle status message memory (▷ page 129)
- Restarting the tire pressure loss warning system (Canada only) (▷ page 234)
- Checking tire inflation pressure electronically with the Advanced TPMS (USA only) (▷ page 234)
- Calling up the maintenance service indicator display (▷ page 259)



Vehicle status message memory

Use the vehicle status message memory function to scan malfunction and warning messages that may be stored in the system. Such messages appear in the multifunction display and are based on conditions or system status the vehicle's system has recorded.





Warning!

Malfunction and warning messages are only indicated for certain systems and are intentionally not very detailed. The malfunction and warning messages are simply a reminder with respect to the

operation of certain systems. They do not replace the owner's and/or driver's responsibility to maintain the vehicle's operating safety. Have all required maintenance and safety checks performed on the vehicle. Bring the vehicle to an authorized Mercedes-Benz Center to address the malfunction and warning messages.

- ▶ Press button  or  to select the Service menu.
If conditions have occurred causing status messages to be recorded, the number of messages appears in the multifunction display:



- ▶ Press button  or  to select the messages function.
- ▶ Press button  to confirm.
The stored messages will now be displayed in the order in which they have occurred. For malfunction and warning messages, see "Vehicle status messages in the multifunction display" (▷ page 270).
- ▶ Use button  or  to scroll through the messages.

If you turn the SmartKey in the starter switch to position **0** and then back to position **2**, all messages will be deleted from the message memory.

Settings menu

Introduction





In the Settings menu there are two functions: The function Factory Setting (▷ page 130), with which you can reset the settings to the original factory settings and a

collection of submenus (▷ page 130) with which you can make individual settings for your vehicle.



Resetting to factory settings

You can reset most of the settings of the submenus to the factory settings.



For safety reasons, the function Daytime Running Lamps in the Lights submenu cannot be reset while driving.

- ▶ Press button  or  to select the Settings menu.
- ▶ Press button  or  to select the Factory Setting function.
- ▶ Press button .
The function Reset All Settings? appears in the multifunction display.



- ▶ Press button  or  to select Yes or No. Select Yes if you want to reset to factory settings.
- ▶ Press button  to confirm.
The confirmation message appears in the multifunction display.

Submenus in the Settings menu

- ▶ Press button  or  to select the Settings menu.



- ▶ Press button or to select a submenu.

Scroll down with button , scroll up with button .

With the selection marker on the desired submenu, use the button to access the individual functions within that submenu. Once within the submenu, you can use button to move to the next function or button to move to the previous function within that submenu.

The following lists show what settings can be changed within the various menus. Detailed instructions on making individual settings can be found on the following pages.

Instrument cluster submenu

- Selecting speedometer display mode (▷ page 131)
- Showing or hiding additional speedometer¹³ (▷ page 132)
- Permanent display¹⁴ (speed display or outside temperature) (▷ page 132)

Time/Date submenu

- Setting the time (▷ page 132)
- Setting the date (▷ page 133)

Lights submenu

- Switching daytime running lamp mode on or off (USA only) (▷ page 133)
- Switching locator lighting on or off (▷ page 134)
- Switching interior lighting delayed shut-off on or off (▷ page 135)

Vehicle submenu

- Switching automatic central locking on or off (▷ page 135)

Convenience submenu

- Activating easy-entry/exit feature (▷ page 136)
- Switching fold-in function for exterior rear view mirrors on or off (Canada only) (▷ page 136)

Instrument cluster submenu

Access the Instr. Cluster submenu via the Settings menu. Use the Instr. Cluster submenu to change the instrument cluster display settings.

The following functions are available:

- Selecting speedometer display mode (▷ page 131)
- Showing or hiding additional speedometer¹⁵ (▷ page 132)
- Permanent display¹⁶ (speed display or outside temperature) (▷ page 132)

Selecting speedometer display mode

- ▶ Press or to select the Settings menu.
- ▶ Press button or to select the Instr. Cluster submenu.
- ▶ Press button .
- ▶ Press button or to select the Display Unit Speed-/Odometer: function.
The current setting is shown.



¹³ Vehicles with manual transmission

¹⁴ Vehicles with automatic transmission

¹⁵ Vehicles with manual transmission

¹⁶ Vehicles with automatic transmission

- ▶ Press button **[OK]** to change the setting. Depending on the previous setting the Display Unit Speed-/Odometer: will be set to miles or km.

The selected display unit is valid for:

- Odometer and trip odometer
- Trip computer
- Digital speedometer in the trip menu
- Cruise control
- Navigation displays

Showing or hiding additional speedometer (vehicles with manual transmission)

You can have an additional digital speedometer shown on the multifunction display. The speed is shown in the unit of kilometers/hour (USA) or miles/hour (Canada).

- ▶ Press button **[◀]** or **[▶]** to select the Settings menu.
- ▶ Press button **[▼]** or **[▲]** to select the Instr. Cluster submenu.
- ▶ Press button **[OK]**.
- ▶ Press button **[▼]** or **[▲]** to select the Additional Speedometer function. The current setting is shown.



- ▶ Press button **[OK]** to change the current status. Depending on the previous status, the additional speedometer will be switched On or Off.

Permanent display (vehicles with automatic transmission)

You can use the Permanent Display: function to choose to display either the outside temperature or the speed in kilometers (USA) or miles (Canada) permanently.

- ▶ Press button **[◀]** or **[▶]** to select the Settings menu.
- ▶ Press button **[▼]** or **[▲]** to select the Instr. Cluster submenu.
- ▶ Press button **[OK]**.
- ▶ Press button **[▼]** or **[▲]** to select the Permanent Display: function. The current setting is shown.



- ▶ Press button **[OK]** to change the current status. Depending on the previous status, the Permanent Display: will be switched between Outside temperature or Speedometer (km/h) (USA)/ Speedometer (miles) (Canada).

Time/Date submenu

Access the Time/Date submenu via the Settings menu. Use the Time/Date submenu to change the time and date display settings.

The following functions are available:

- Setting the time (▷ page 132)
- Setting the date (▷ page 133)

Setting the time

This function is not available if your vehicle is equipped with the COMAND system and navigation module.

Vehicles with COMAND system:

For information on setting the time in the COMAND system, refer to the separate COMAND system operating instructions.

- ▶ Press button or to select the Settings menu.
- ▶ Press button or to select the Time/date submenu.
- ▶ Press button .
- ▶ Press button or to select the Time function.
- ▶ Press button .

The current time appears in the multifunction display.

- ▶ To set a new time press button again.
- ▶ Press button or to select the setting you wish to change: hours or minutes.



- ▶ Press button or to change the setting which is highlighted.
- ▶ Press button to store the entry.

Setting the date

This function is not available if your vehicle is equipped with the COMAND system and navigation module.

Vehicles with COMAND system:

For information on setting the date in the COMAND system, refer to the separate COMAND system operating instructions.

- ▶ Press button or to select the Settings menu.
- ▶ Press button or to select the Time/date submenu.
- ▶ Press button .

- ▶ Press button or to select the Date function.
 - ▶ Press button .
- The current date appears in the multifunction display.
- ▶ To set a new date press button again.
 - ▶ Press button or to select the setting you wish to change: month, day or year.



- ▶ Press button or to change the setting which is highlighted.
- ▶ Press button to store the entry.

Lights submenu

Access the Lights submenu via the Settings menu. Use the Lights submenu to change the lamp and lighting settings on your vehicle.

The following functions are available:

- Switching daytime running lamp mode on or off (USA only) (▷ page 133)
- Switching locator lighting function on or off (▷ page 134)
- Switching interior lighting delayed shut-off on or off (▷ page 135)

Switching daytime running lamp mode on or off (USA only)

- ▶ Press button or to select the Settings menu.
- ▶ Press button or to select the Lights submenu.

- ▶ Press button .
- ▶ Press button or to select the Daytime Running Lamps: function. The current setting Enabled or Disabled is shown.

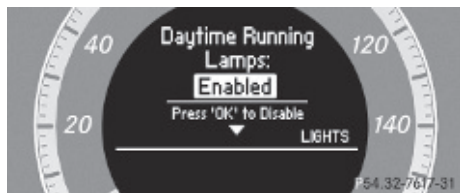

- ▶ Press button to change the current status. Depending on the previous status, the Daytime Running Lamps: mode will be Enabled or Disabled.

With Daytime Running Lamps mode enabled and the exterior lamp switch at position or , the low-beam headlamps are switched on when the engine is running.

In low ambient light conditions the following lamps will come on additionally:

- Parking lamps
- Tail lamps
- License plate lamps
- Side marker lamps

For more information on the daytime running lamp mode, see (▶ page 91).

- i** Make sure the exterior lamp switch is set to or when you switch off the daytime running lamps while driving at night.

For safety reasons, resetting all the functions of all submenus to the factory settings while driving (▶ page 130) will not deactivate the daytime running lamp mode.

The following message appears in the multifunction display:

Cannot Be Completely Reset to Factory Settings while Driving..

Switching locator lighting on or off

With the Locator Lighting: function activated and the exterior lamp switch in position

- the exterior lamps will come on during darkness when the vehicle is unlocked with the SmartKey.

The lamps will go out when the driver's door is opened.

If you do not open the driver's door after unlocking the vehicle with the SmartKey, the lamps will go out automatically after approximately 40 seconds.

- the exterior lamps will remain on for 15 seconds during darkness after exiting the vehicle and closing all doors.

If, after turning off the engine, you do not open or close a door, the lamps will automatically go out after 60 seconds.

The following lamps will come on

- Parking lamps
- Tail lamps
- License plate lamps
- Side marker lamps
- Front fog lamps

- ▶ Press button or to select the Settings menu.

- ▶ Press button or to select the Lights submenu.

- ▶ Press button .

- ▶ Press button or to select the Locator Lighting: function. The current setting Enabled or Disabled is shown.



- ▶ Press button **[OK]** to change the current status.

Depending on the previous status, the Locator Lighting: function will be Enabled or Disabled.

You can temporarily deactivate the headlamps delayed shut-off feature:

- ▶ Before exiting the vehicle, turn the SmartKey in the starter switch to position **0**.
- ▶ Then turn it to position **2** and back to position **0**.
The headlamps delayed shut-off feature is deactivated. It will reactivate as soon as you start the engine.

Switching interior lighting delayed shut-off on or off

Use this function to set whether you would like the interior lighting to remain on for 10 seconds during darkness after you have removed the SmartKey from the starter switch.

- ▶ Press button **[◀]** or **[▶]** to select the Settings menu.
- ▶ Press button **[▼]** or **[▲]** to select the Lights submenu.
- ▶ Press button **[OK]**.
- ▶ Press button **[▼]** or **[▲]** to select the Interior Lighting Delay: function. The current setting Enabled or Disabled is shown.



- ▶ Press button **[OK]** to change the current status.
Depending on the previous status, the interior lighting delayed shut-off feature will be Enabled or Disabled.

Vehicle submenu

Access the Vehicle submenu via the Settings menu. Use the Vehicle submenu to set the automatic central locking.

Switching automatic central locking on or off

Use this function to switch the automatic central locking on or off. With the automatic central locking activated, the vehicle is locked centrally at a vehicle speed of approximately 9 mph (15 km/h).

- ▶ Press button **[◀]** or **[▶]** to select the Settings menu.
- ▶ Press button **[▼]** or **[▲]** to select the Vehicle submenu.
- ▶ Press button **[OK]**.
- ▶ Press button **[▼]** or **[▲]** to select the Automatic Door Lock: function. The current setting Enabled or Disabled is shown.

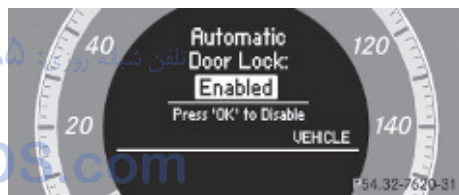

- ▶ Press button **[OK]** to change the current status.
Depending on the previous status, the Automatic Door Lock: feature will be Enabled or Disabled.

Convenience submenu

Access the Convenience submenu via the Settings menu. Use the Convenience submenu to activate the easy-entry/exit feature (> page 136), or to set the fold-in function for exterior rear view mirrors (> page 136).

Activating easy-entry/exit feature







Use this function to activate and deactivate the easy-entry/exit feature (▷ page 85).

Warning!

You must make sure no one can become trapped or injured by the moving steering wheel when the easy-entry/exit feature is activated.

To stop steering wheel movement, move steering wheel adjustment stalk or press one of the memory position buttons.

Do not leave children unattended in the vehicle, or with access to an unlocked vehicle. Children could open the driver's door and unintentionally activate the easy-entry/exit feature, which could result in an accident and/or serious personal injury.

- ▶ Press button  or  to select the Settings menu.
- ▶ Press button  or  to select the Convenience submenu.
- ▶ Press button .
- ▶ Press button  or  to select the Easy Entry/Exit: function. The current setting Enabled or Disabled is shown.



- ▶ Press button  to change the current status. Depending on the previous status, the Easy Entry/Exit: feature will be Enabled or Disabled.







Switching fold-in function for exterior rear view mirrors on or off

This feature is only available in Canada vehicles.

Use this function to set the exterior rear view mirrors to be folded in automatically when you lock your vehicle.

With this function set to Enabled and the exterior rear view mirrors folded in using the button on the door control panel (▷ page 88), the exterior rear view mirrors will not fold out when you switch on the ignition. You will then have to fold out the exterior rear view mirrors using the button on the door control panel (▷ page 88).

Make sure both exterior rear view mirrors are folded out completely before driving off.

- ▶ Press button  or  to select the Settings menu.
- ▶ Press button  or  to select the Convenience submenu.
- ▶ Press .
- ▶ Press button  or  to select the Fold Mirrors in when Locking: function.

The current setting Enabled or Disabled is shown.

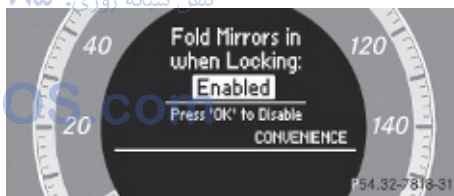

- ▶ Press button  to change the current status. Depending on the previous status, the automatic fold-in function for exterior rear view mirrors will be Enabled or Disabled.

Audio system

Audio and telephone operation

These instructions are intended to help you become familiar with your Mercedes-Benz audio system. They contain useful tips and a detailed description of the user functions.

Warning!

In order to avoid distraction which could lead to an accident, the driver should enter system settings with the vehicle at a standstill and operate the system only when road and traffic conditions permit. Always pay full attention to traffic conditions first before operating system controls while driving.

Bear in mind that at a speed of just 30 mph (approximately 50 km/h), your vehicle is covering a distance of 44 feet (approximately 14 m) every second.

Audio system overview



	Item
①	Audio display (▷ page 139)
②	Opening button (▷ page 139)
③	Audio control unit (▷ page 138)

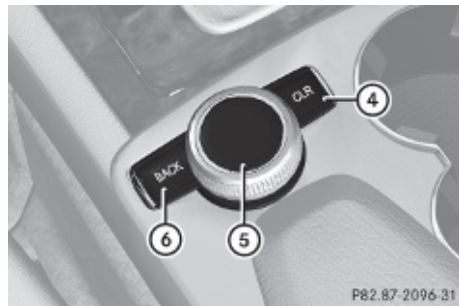

	Item
④	Clear button (▷ page 142)
⑤	Audio controller (▷ page 140)
⑥	Back button (▷ page 141)

Operating safety

Warning!

Any alterations made to electronic components can cause malfunctions.

The radio, amplifier, CD changer, satellite radio, and telephone are interconnected. When one of the components is not operational or has not been removed/replaced properly, the function of other components may be impaired.

This condition might seriously impair the operating safety of your vehicle.

We recommend that you have any service work on electronic components carried out at an authorized Mercedes-Benz Center.

Audio system components

With the audio system you can operate the following main functions:

- Audio function with the radio, Satellite radio, disc (CD audio or MP3 mode) and Audio AUX
- the mobile phone with the phone book
- various system settings

The audio system consists of the following:

- Audio control unit
- Audio display
- Audio controller with buttons **BACK** and **CLR**

In addition, the audio system can also be operated with the multifunction steering wheel (▷ page 118).

In these instructions, the keypad (right side of audio control unit) and the function buttons are referred to as “buttons”.

Audio control unit overview

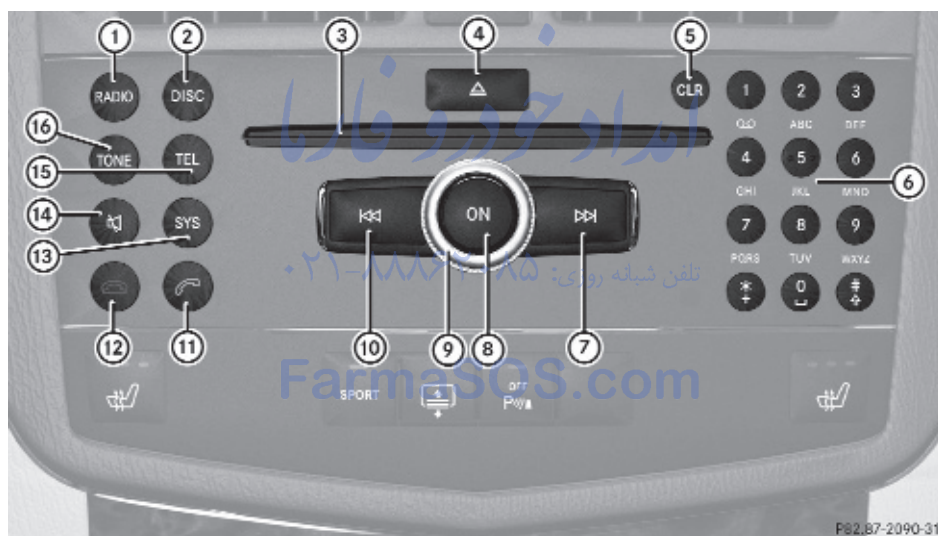

F82.B7-2090-31

	Item
①	Switching to radio mode (▷ page 149) Calling up wave bands (▷ page 149) Switching on Sat mode (▷ page 154)
②	Switching to CD audio or MP3 mode (▷ page 158)
③	Disc slot

Audio control unit

With the audio control unit you can

- switch the audio system on/off
- adjust the volume
- select the operating modes
- enter telephone numbers and accept, reject, initiate and end telephone calls
- load and eject CDs

- | | |
|---|---|
| ④ | Load/eject button (▷ page 161) |
| ⑤ | Clear button for deleting digits or entire entries (▷ page 178)
Entering a passcode (▷ page 171)
Entering a telephone number (▷ page 177) |

- ⑥ Keypad
 - Tuning to a station via the station memory (▷ page 150)
 - Storing stations manually (▷ page 151)
 - Entering a passcode (▷ page 171)
 - Entering a phone number (▷ page 177)
 - Sending DTMF tones (▷ page 180)
 - CD changer: Selecting a CD (▷ page 162)
 - CD: Entering a track number directly (▷ page 164)
- ⑦ Tuning to a station via station search (▷ page 150)
 - Fast forward (▷ page 165)
 - Skipping forwards to a track (▷ page 165)
- ⑧ Switching audio system on/off (▷ page 144)
- ⑨ Adjusting the volume (▷ page 144)
- ⑩ Tuning to a station via station search (▷ page 150)
 - Fast rewind (▷ page 165)
 - Skipping backwards to a track (▷ page 165)
- ⑪ Confirming a passcode (▷ page 171)
 - Accepting a call (▷ page 179)
 - Initiating a call (▷ page 177)
 - Redial (▷ page 178)
- ⑫ Rejecting a call (▷ page 179)
 - Ending an active call (▷ page 179)
- ⑬ Opening system settings menu (▷ page 147)
- ⑭ Switching sound on/off (▷ page 145)
 - Switching hands-free microphone on/off (▷ page 179)

- ⑮ Switching to telephone mode (▷ page 167)
- ⑯ Sound settings (▷ page 145)

Audio display

The audio display has a protective cover.

! Do not place any objects on the cover of the audio display. This may obstruct the movement when the cover is being opened/closed. The cover could be damaged. Do not place any objects in front of the audio display and/or secure any objects to the audio display itself. The audio display could be damaged.

Avoid touching the audio display at all times. The display has a very sensitive high-gloss surface, there is a risk of it being scratched. Do not press directly in the display face. Otherwise, the audio display will be damaged.

i For information about cleaning and care of the audio display, see “Audio or COMAND display” (▷ page 265).

Audio display cover

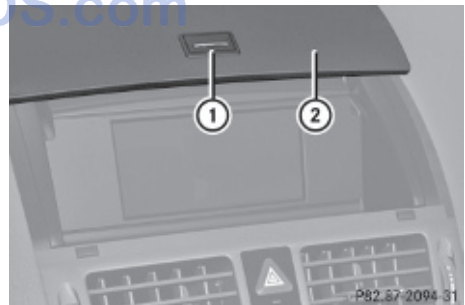

P82.57-2094-31

- ▶ **Opening:** Press opening button ①. Audio display cover ② opens, the audio display is visible, and the audio system switched on.
- ▶ **Closing:** Press audio display cover ② down until it engages. If the audio system is still switched on, you can continue to listen to the radio or a CD and operate the device via the buttons on the audio control panel as well as the buttons on the multifunction steering wheel.

i You cannot operate the audio system via the audio controller when audio display cover ② is closed.

Display

The currently selected mode and the associated menus are shown on the audio display. The audio display is divided into several areas.



Example illustration: Radio selected

Status line ③ displays the time and the current settings for radio and telephone mode.



You can request the required function using menu bar ①.

The selection is made using the audio controller.

Mobile phone readiness is indicated by additional information being shown in the status line:

- In the telephone main menu: Name of the Bluetooth® device (calls made and

received via the Bluetooth® interface) (▷ page 172).

- Mobile phone network signal strength . This information will only be shown with suitable mobile phones.
- The receiver symbol indicates whether a call is active or not.
 -  No active call
 -  Active call

In this example, the audio main function is set to the FM radio mode and main area ② is active.

i The layout of the menus may vary depending on your vehicle's equipment. This manual shows the menus for a fully equipped vehicle.

Instrument cluster multifunction display

Please refer to the “Control system” section of this manual (▷ page 118) for function descriptions and operation of the instrument cluster multifunction display and multifunction steering wheel buttons as they relate to audio functions described in this section.

Audio controller

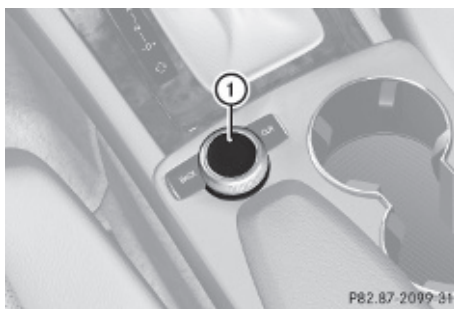

The menu functions are selected on the audio display using audio controller ①. For this purpose, a selected item is highlighted.

In this way, you can open menus or lists, move within menus or lists, and quit menus or lists.

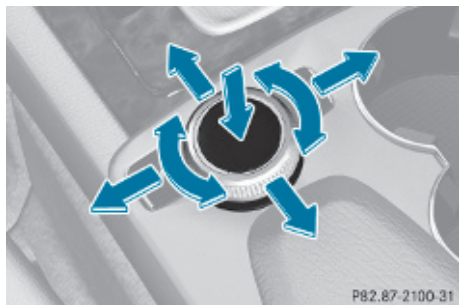

P82.87.2100.31

Operating audio controller

Audio controller ① features the following options:

- press briefly or press and hold
- rotate to the left or right
- slide to the left or right
- slide up or down

i You cannot operate the audio system via audio controller ① when the display cover is closed.

Symbol	How to use the audio controller
	<ul style="list-style-type: none"> ▶ Press briefly <ul style="list-style-type: none"> • to confirm the selection of a menu item or list entry ▶ Press and hold until the selected action has been carried out <ul style="list-style-type: none"> • to save a station
	<ul style="list-style-type: none"> ▶ Rotate <ul style="list-style-type: none"> • to move through vertical or horizontal menus or through lists • to select program settings
	<ul style="list-style-type: none"> ▶ Slide <ul style="list-style-type: none"> • to move through vertical menus or lists • to exit horizontal menus

Symbol	How to use the audio controller
	<ul style="list-style-type: none"> ▶ Slide <ul style="list-style-type: none"> • to move through horizontal menus • to exit vertical menus ▶ Slide and hold <ul style="list-style-type: none"> • for fast forward or reverse for audio CD playback

Back button



P82.87.2097.31

▶ Switching to the next highest menu:

Press button **BACK** briefly.

The audio system switches to the next highest menu level within the currently active mode.

i You can also exit a menu or list by sliding the audio controller or .

▶ Switching to the main menu: Press and hold button **BACK**.

The audio system switches to the basic menu of the currently active mode.

Clear button



- ▶ **Deleting an individual digit:** Briefly press button **CLR**.
- ▶ **Deleting an entire entry:** Press and hold button **CLR** until the entry is deleted.

Menu

The table below shows the structure of the modes and their menus. Each mode has a basic menu. Each menu item in turn has several submenu items.

Button	Mode/Menu
RADIO	Radio mode
	Radio (FM/AM) (▷ page 148)
	Weather Band (▷ page 149)
	Satellite radio (▷ page 152)
	Presets (▷ page 151)
	Sound (▷ page 145)
DISC	Disc mode
	CD/MP3 (▷ page 158)
	Track list/folder list (▷ page 165)
	CD Changer (▷ page 162)
	Sound (▷ page 145)
TEL	Telephone mode

Button	Mode/Menu
	Telephone (▷ page 167)
	Name (▷ page 174)
	Call lists (▷ page 176)
sys	System settings menu
	System (▷ page 147)
	Language (▷ page 148)

Calling up an operating mode

- ▶ Press the respective button (**RADIO**, **DISC**, **TEL**, or **sys**) on the audio control unit. The basic menu of the selected mode appears in the audio display. The main area is active. The active area is highlighted.

i The following screens show the audio display's day design. The appearance of the highlighted items in the menu will vary depending on the display design.



Illustration: Radio function basic menu

- ▶ **Moving to the menu bar:** Slide **⊙** ↓.

Horizontal menus

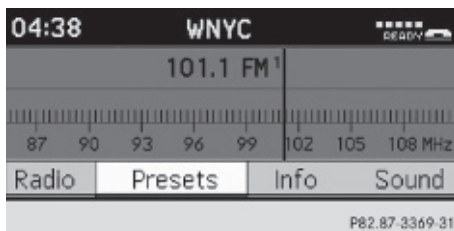

- ▶ **Moving through the menu bar:** Slide ←○→ or rotate ⌚.
 - The currently selected item is highlighted.
 - ▶ **Confirming the selected menu item:** Press ⏻.
 - ▶ **Exiting the menu bar without confirming a selection:** Slide ⬆️⬆️ in the opposite direction of the list orientation.
- or
- ▶ Press button **BACK**.

Vertical submenus

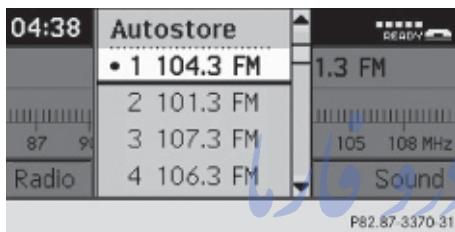

- ▶ **Moving through the submenu:** Slide ⬆️⬆️ or rotate ⌚.
 - The currently selected item is highlighted.
 - ▶ **Confirming the selected submenu item:** Press ⏻.
 - ▶ **Exiting the submenu without confirming a selection:** Slide ←○→ in the opposite direction of the list orientation.
- or
- ▶ Press button **BACK**.

Example of how to use the audio system

Example: direct frequency input, FM 104.5 MHz.

RADIO → Radio → Enter Frequency

The individual steps for the above-mentioned example are described below.

- ▶ Press button **RADIO** on audio control unit repeatedly until desired wave band FM has been selected.
- ▶ **Switching to the menu bar:** Slide ⬆️.

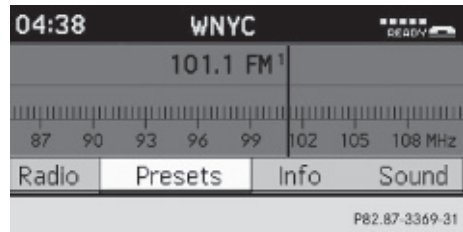

- ▶ **Selecting Radio in the menu bar:** Slide ←○→ or rotate ⌚.

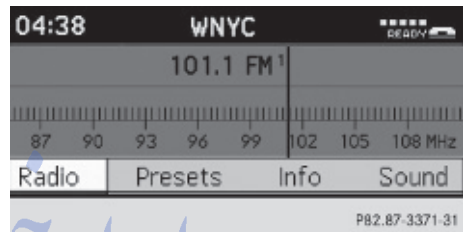

- ▶ **Confirming selection:** Press ⏻.
- The Radio menu is selected and a list of submenus appears.

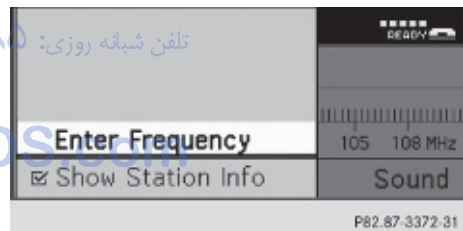

- ▶ Enter Frequency is selected.
- ▶ **Confirming selection:** Press ⏻.
- The Enter Frequency submenu appears.









- ▶ **Information:** It is not possible to enter a frequency in the respective wave band which is outside

the frequency range. Frequencies within the current frequency range, but outside the current frequency step width are rounded to the next lower allowed frequency.

- ▶ Enter 1045 with the keypad on the audio control unit.
The audio system tunes in to the frequency entered.

Operation

In the following description, an operation step is described as in the example below.

- ▶ **RADIO** → Radio → Enter Frequency is the short for
- ▶ Press button **RADIO** on audio control unit repeatedly until desired wave band has been selected.
- ▶ Slide .
- ▶ Slide  or rotate  the audio controller to select Radio.
- ▶ Press the audio controller .
The Radio menu is selected and a list of submenus appears.
- ▶ Slide  or rotate  the audio controller to select Enter Frequency.
- ▶ Press the audio controller .
The Enter Frequency submenu appears in the audio display.

Switching audio system on or off



- ▶ **Switching on:** Press push button .

or

- ▶ Open the audio display cover.

or

- ▶ If the audio system was on as you switched off the ignition, turn the SmartKey in the starter switch to position **1**.

The audio system will come back on with the last selected function.

- i** If the audio system is switched on without the SmartKey in the starter switch, it will automatically switch off again after approximately 30 minutes.

- ▶ **Switching off:** Press push button .

or

- ▶ Turn the SmartKey in the starter switch to position **0** and remove SmartKey from starter switch.

- i** Should excessively high temperatures occur while the audio system is being operated, Temperature Too High - Device switching off now. will appear in the audio display, after which the audio system will be switched off for a cooling-down period.

- i** When you switch off the audio system, you also switch off the currently playing audio source. Also, telephone operation via the audio control unit is not possible.

Adjusting volume



- ▶ **Adjusting:** Turn rotary control ①.
The volume will increase or decrease depending on the direction turned.

Adjusting volume for telephone calls

In hands-free mode, you can adjust the volume of a telephone call while the call is currently active.

During a telephone call:

- ▶ Turn rotary control ①.
The volume will increase or decrease depending on the direction turned.
- ▶ The volume of the audio system or a telephone call can also be adjusted by pressing the button **+** or **-** on the multifunction steering wheel (▶ page 118).

Sound

- ▶ **Switching on/off:** Press button **⏸** on the audio control unit (▶ page 138).
The sound of the current audio source is switched on or off.
- ▶ When the sound is switched off, the symbol **⏸** appears in the status line.
If you change the audio source, or alter the volume, the sound is automatically switched on again.

Selecting sound settings

You can select different bass and treble settings for each individual audio source. The particular Sound menu can be opened from the basic menu for the desired operating mode, or by pressing the button **TONE** on the audio control unit.

Example:

RADIO → Sound → Bass

Adjusting bass or treble

- ▶ Press button **TONE** and select Bass or Treble.
- or
- ▶ Select Sound → Bass or Treble.
A longer and brighter bar indicates the previously stored setting. The red pointer indicates the currently selected setting.

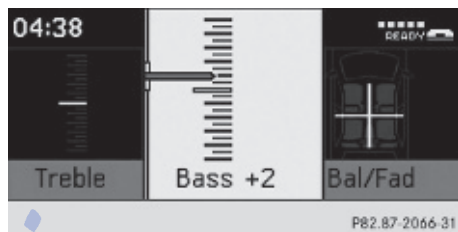

Example for adjusting bass

- ▶ **Changing setting:** Slide **⬇** or **⬆** or rotate **⌚** until desired treble or bass setting is reached.
- ▶ **Exiting menu:** Press button **BACK** or slide **⬅** or **➡**.
The setting is stored.

Adjusting balance or fader

Balance is used to determine whether the sound focus should be shifted toward the driver's side or the passenger side.

Fader is used to determine whether the sound focus should be shifted toward the front or rear of the vehicle.

- ▶ Press button **TONE** repeatedly until Bal/Fad appears in the audio display.
- or
- ▶ Select Sound → Bal/Fad.
The current setting is indicated by a red cross hair symbol.

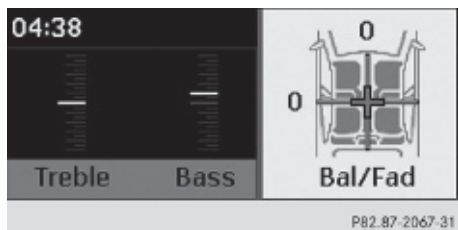

Adjusting balance and fader

- ▶ **Changing setting:** Slide $\downarrow \uparrow$ or $\leftarrow \rightarrow$ until desired balance/fader setting is achieved.
- ▶ **Exiting menu:** Press \odot or button **BACK**. The balance/fader setting is stored for all audio sources.

Surround sound

If your vehicle is equipped with the harman/kardon Logic7® Surround Sound system, you can choose between Logic7® On and Logic7® Off for surround sound.

harman/kardon Logic7® Surround Sound is available for the following operating modes:

- Radio (FM only)
- Satellite radio
- CD audio
- MP3
- AUX

i By selecting Logic7® Off, all compatible formats are played back as they are present on the medium.

Adjusting surround sound

With surround sound, you can choose between Logic7® On and Logic7® Off.

- ▶ Press button **TONE** repeatedly until Sound appears in the audio display.
- or
- ▶ Select Sound → Sound.



A dot • indicates the current setting.

- ▶ **Selecting setting:** Slide $\downarrow \uparrow$ or rotate $\left\{ \odot \right\}$.
- ▶ **Saving setting:** Press \odot . The setting is stored and the menu is exited.
- ▶ **Exiting menu without saving:** Press button **BACK** or slide $\leftarrow \rightarrow$.

i Balance and fader will be set to the default value (0/0) automatically by activating or deactivating Logic7®.

i Please note the following:

- For an optimal sound experience from all seats, the balance and fader should be adjusted to the center of the passenger compartment with Logic7® switched on.
- The best sound results are achieved when playing high-quality audio CDs.
- For MP3 tracks, the bit rate should be at least 128 kbit/s.
- Surround playback cannot be activated in mono-signal sources as AM or Weatherband. It will not function for mono-signal sources as, e.g. mono audio tracks on some specific audio CDs.
- In the case of poor radio reception quality, e.g. during long tunnel passages, Logic7® should be switched off, as otherwise a dynamic switchover from stereo to mono and thus temporary sound characteristic shifts can occur.
- With certain stereo recordings, the resulting sound characteristic may

deviate from conventional stereo playback.

SYS menu

System settings menu overview

Menu
System
Display (▷ page 147)
Brightness
Day Mode
Night Mode
Automatic
Activate Bluetooth® (▷ page 147)
Reset (▷ page 147)
Language (▷ page 148)

Display settings

You can adapt the brightness of the audio display to the prevailing light conditions.

Setting the display design

- ▶ **sys** → System → Display.
- ▶ Select Brightness, Day Mode, Night Mode or Automatic.

i When you select Brightness, a scale appears on which you can set the brightness manually.

In the Automatic setting, the audio system analyzes the automatic vehicle light sensor and switches between the display designs automatically.

Bluetooth® settings

General information about Bluetooth®

Bluetooth® technology is the standard for short-range wireless technologies, suitable for transmitting voice and data. It is possible to connect Bluetooth® devices wirelessly.

Bluetooth® can be used to exchange vCards or to make calls using a hands-free device.

Bluetooth® technology uses the freely available ISM (Industrial Scientific Medical) wave band that works at 2.45 GHz.

Bluetooth® works within a range of up to 33 ft (10 m).

Activate or deactivate Bluetooth®

- ▶ **sys** → System → Activate Bluetooth.



You have activated or deactivated Bluetooth®. A checkmark appears when Bluetooth® is activated.

Reset

i You can reset the audio system back to its factory settings. In this case, all personal data (e.g. address book entries, call lists, paired mobile phones, and presets) are deleted. We recommend that you reset the values before selling your vehicle.

- ▶ **[sys]** → System → Reset.
A prompt appears asking whether you really want to reset.
- ▶ Select Yes or No.
If you select Yes another prompt will appear asking whether you really want to reset.
- ▶ Select Yes or No.
If you select Yes, the audio system will be reset and restarted.

Setting the system language

- ▶ **[sys]** → Language.



The language list appears. A dot • in front of an entry indicates the current setting.

- ▶ **Changing setting:** Slide $\downarrow\odot\uparrow$ or rotate $\left(\odot\right)$ and select desired language.
- ▶ **Saving setting:** Press \odot .
The setting is stored and the menu is exited.
- ▶ **Exiting menu without saving:** Press button **[BACK]** or slide $\leftarrow\odot\rightarrow$.

- ▶ **i** The language selected in the Audio system is also used for the displays and messages in the multifunction display.

Radio operation

Warning!

Please devote your attention first and foremost to the traffic situation you are in. Before your journey, please familiarize yourself with the radio functions.

Only use the audio system when road and traffic conditions permit you to do so. Otherwise you could be involved in an accident in which you or others could be injured.

- ▶ **i** Do not attach metallic window tinting film to the inside or outside of windows which are fitted with an aerial. Obstructing the metallic aerial structure on the window will interfere with radio reception. Cutting the film on the window can permanently damage the aerial wires.

- ▶ **i** The radio mode is interrupted by an incoming call on the mobile phone (▷ page 167).

Menu overview

- ▶ **i** The components and operating principles of the audio system can be found on (▷ page 137) and (▷ page 143). Information about sound settings can be found on (▷ page 145).

Menu	Function
Radio (except Weather Band/satellite radio)	Enter frequency Station information (in FM wave band only)
Presets (except Weather Band)	Autostore (except satellite radio) List of stored stations
Info	Information menu (if available)
Channel (only Weather Band)	List of channels
Sound	Treble Bass

Menu	Function
	Balance/Fader
	Surround Sound

Switching to radio mode

- ▶ Press button **RADIO** on audio control unit. The radio basic menu appears in the audio display. The radio switches to the last station you have listened to. Weather Band will automatically tune to the strongest station in the area.

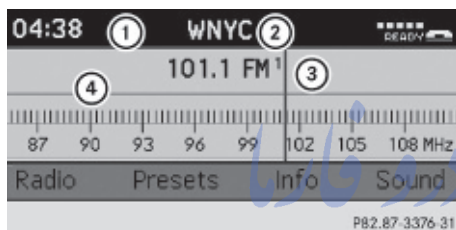

Illustration: Radio mode in FM wave band

- ① Status line
- ② Station name or other information from the station
- ③ Station frequency and stored position
- ④ Main area with wave band

- i** Station name or other information ②, available for the FM wave band, can only be seen when the station transmits the name or other information and the function Show Station Info in the Radio menu is activated.

▶ **RADIO** → Radio → Show Station Info



In the WB wave band, the audio system displays the channel number, e.g. Channel 6, instead of the station names and/or frequency.

Information displayed in the status line (example)

The following information is displayed in the status line:

- Time (04:38)
- Station name (WNYC)

Mobile phone readiness is indicated by additional information being shown:

- Mobile phone network signal strength 
- Receiver symbol  

Calling up wave bands

You can select FM, AM, and WB wave bands as well as the Sat mode (▶ page 152). When you have selected the Sat mode, pressing button **RADIO** will switch back to FM radio mode.

Wave band	Frequency
FM	87.7.....107.9 MHz
AM	530.....1710 KHz
WB (Weather Band)	Weather channels
Satellite radio	Satellite radio channels

- ▶ Press button **RADIO** on audio control unit repeatedly until the desired wave band has been selected. The FM, AM, and WB wave bands and the satellite radio mode are called up one after another.

The wave band currently selected appears in the main area of the audio display. The last selected station in the selected wave band is heard.

Selecting a station/channel

The following functions are available:

- Station search function
- Channel list (Weather Band/satellite radio)
- Station memory (except Weather Band)
- Manual frequency entry (except Weather Band/satellite radio)

For using satellite radio see (▷ page 152).

The station search proceeds in the following frequency increments:

- 200 kHz in FM range
- 10 kHz in AM range

Tuning to a station/channel via station/channel search function

i The search function searches for the next receivable station in the FM or AM wave band. In Weather Band (WB) the search function switches to the next channel in the channel list. For tuning to a station/channel you can also use the buttons on the multifunction steering wheel, see Audio menu (▷ page 126).

- ▶ Press button **RADIO** on audio control unit repeatedly until the FM/AM/WB wave band is selected.
- ▶ Slide **←** or rotate **↻** when the main area in the basic menu is active. Depending on the direction in which the controller is being slid or rotated, the system searches upward or downward and stops at the next station/channel.

or

- ▶ Press button **◀◀** or **▶▶** on audio control unit. Depending on the pressed button, the system searches downward or upward and stops at the next station/channel.

Selecting a station using station memory

i This function is not available for Weather Band.

- ▶ Press button **RADIO** on audio control unit repeatedly until desired wave band has been selected.

- ▶ Select Presets.

or

- ▶ Press **⌂** when the main area is selected. The memory menu appears. The dot • in front of a memory position indicates that the currently selected station is saved there.

- ▶ Select a station in the memory menu by rotating **↻** or sliding **↑** **⌂** **↓** and press **⌂**.

or

- ▶ Press desired station button **1** to **0**, with the keypad in audio control unit briefly.

Tuning to a station by entering the frequency manually

i This function is not available for Weather Band/satellite radio.

- ▶ **RADIO** → Radio → Enter Frequency
The menu for manual frequency entry appears.

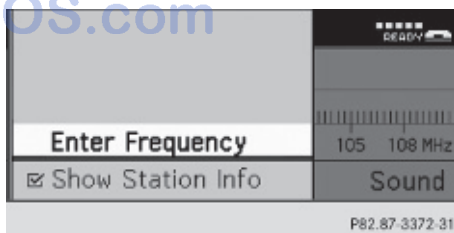

or

- ▶ Press button ***+** on the keypad in audio control unit briefly. The Enter Frequency submenu appears.



- ▶ **Entering frequency with keypad:** Enter desired frequency with buttons to on the keypad in audio control unit. The audio system tunes in to the frequency entered.

i It is not possible to enter a frequency in the respective wave band which is outside the frequency range.

- ▶ **Exiting menu without making an entry:** Press button in the center console (▶ page 141).

Storing stations

You can store ten AM and ten FM stations in the memory.

i If you select a memory preset which is already in use, it will be overwritten by the new station.

Storing stations manually with keypad

- ▶ Tune in desired station.
The basic menu appears in the audio display.
- ▶ Press and hold desired station button to until a brief signal tone sounds.
The station is stored.

Storing stations manually with station memory menu

- ▶ Tune in desired station.
The basic menu appears in the audio display.
- ▶ Press when the main area is active.
or
- ▶ Select Presets.
The station memory display appears in the audio display.

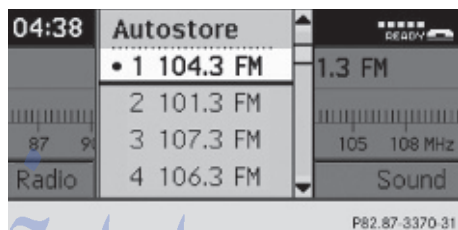







The dot • in front of a memory position indicates that the currently tuned station is stored there.

- ▶ **Selecting a memory position:** Slide or rotate .
- ▶ **Storing a station to a selected memory position:** Press and hold until a brief signal tone sounds.
or
- ▶ Press and hold desired station button to on keypad, until a brief signal tone sounds.
The station is stored.





Autostore – automatic station memory

i This function is not available for Weather Band/satellite radio. The autostore function automatically assigns receivable stations to the memory. The stations are sorted according to reception quality at the moment of performing the autostore. The stations which were stored in the station memory manually are overwritten in this process. If less than ten stations are found, the remaining entries are left empty.

- ▶ Press button **RADIO** on audio control unit repeatedly until desired wave band has been selected.
The basic menu appears in the audio display.
- ▶ Press  when the main area is active.
or
- ▶ Select Presets.
The station memory display appears in the audio display.
- ▶ Slide    or rotate  to select Autostore.
- ▶ Press .
The audio system searches for receivable stations. A corresponding message is displayed. The available stations are automatically stored in the station memory. The first received station will be automatically played.
- ▶ **Canceling storage procedure:** Select Cancel and press  while the message Rewriting Memory... is being displayed.

Displaying information

You can display program information or other additional information when provided by the radio station you are listening to.

- ▶ **RADIO** → Info (if available).
The available information appears. The content and scope of the information depends on the radio station.
- ▶ **Closing screen:** Slide   , rotate , press  or press button **BACK**.

Satellite radio

Warning!

Please devote your attention first and foremost to the traffic situation you are in. Before your journey, please familiarize yourself with the radio functions.

Only use the audio system when road and traffic conditions permit you to do so. Otherwise you could be involved in an accident in which you or others could be injured.

Submenu overview

- i** The components and operating principles of the audio system can be found on (▷ page 137) and (▷ page 143).

Menu	Submenu
Sat	Channel List
	Enter Channel
	Service
Presets	Station presets
Info	Information menu (if available)
Category (Cat.)	All channels
	Select category
	Treble
	Bass
Sound	Balance/Fader
	Surround Sound

Satellite radio

- i** Additional satellite radio equipment and a subscription to SIRIUS XM Satellite Radio service provider are required for the satellite radio operation described in this chapter.

Contact an authorized Mercedes-Benz Center for details and availability for your vehicle.

SIRIUS XM Satellite Radio provides over 130 channels of digital-quality radio, including 100% commercial-free music, sports, news and entertainment. SIRIUS XM Satellite Radio uses a fleet of high-power

satellites to broadcast 24 hours per day, coast to coast, in the contiguous U. S. and Canada.

This diverse, satellite-delivered programming is available for a monthly subscription fee.

For more information and service availability call the SIRIUS XM Service Center at 1-888-539-7474 (▷ page 157), or visit **www.sirius.com** (USA) or **www.siriuscanada.ca** (Canada).

i Note that categories and channels shown in illustrations are dependent on programming content delivered by the service provider. Programming content is subject to change. Therefore, channels and categories shown in illustrations and descriptions contained in this manual may differ from the channels and categories delivered by the service provider.

i Satellite radio service may be unavailable or interrupted from time to time for a variety of reasons, such as environmental or topographic conditions and other things we cannot control. Service might also not be available in certain places (e.g. in tunnels, parking garages, under leafy trees, or within or next to buildings) or near other obstructions. In such situations, the satellite radio's main menu shows the No Service screen. At this point, the radio's functions are restricted.

Subscribing to satellite radio

▶ Press button **RADIO** on audio control unit repeatedly until Sat is selected.

The following conditions are possible:

- Satellite radio service is not activated (only the preview channel is displayed).
- Satellite radio service is activated.

i If a satellite receiver is not installed or not properly installed: The message **Device Unavailable** will appear.

If the satellite radio service is not activated, the "SIRIUS Preview" display appears.

Satellite radio service is not activated

The telephone number of the SIRIUS XM Service Center and the twelve-digit electronic serial number (SIRIUS-ID) of the particular receiver are required when calling the SIRIUS XM Service Center for an activation request.

▶ **RADIO** (repeatedly, if necessary) → Sat → Service.

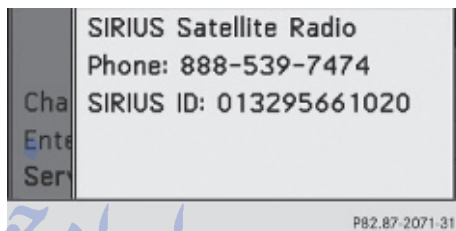

▶ **Closing screen:** Press or button **BACK** or slide .

▶ **Activating satellite radio service:** Contact satellite radio service provider at the telephone number displayed in the service display.

After the connection is made:

▶ Follow the instructions given by the operator.

The activation process may take up to 10 minutes. If it is successful, you will see the display with the message **Updating Channels...** followed by the satellite radio basic menu.

i Activating the satellite radio service might not be available in certain places (e.g. in tunnels, parking garages, under leafy trees, or within or next to buildings). If a subscription is not included with system purchase, credit card information is required to activate your account.

The activation process takes approximately 5 to 10 minutes after calling the SIRIUS XM Service Center.

If a satellite receiver is not installed or not properly installed: The message Device Unavailable will appear.

- i** It is also possible to activate the satellite radio service online. To do so please visit SIRIUS XM Satellite Radio's website at www.sirius.com (USA) or www.siriuscanada.ca (Canada).

Preview Channel

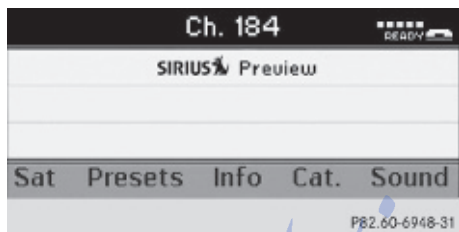

- i** If the satellite radio service has not been subscribed to, only the preview channel is available. You cannot tune in another channel. If you try to do this, the message Call SIRIUS to activate: appears.

Satellite radio service is activated

The basic satellite radio menu appears. You will hear the last tuned channel, provided that it can be received.

Switching on Sat mode

For important subscription information see "Subscribing to satellite radio" (▷ page 153).

- ▶ Press button **RADIO** on audio control unit repeatedly until Sat is selected. The message No Service will appear when the signal is not available. After the audio system acquires the signal, the satellite radio basic menu will appear. The last tuned station will begin to play.

Main satellite radio menu

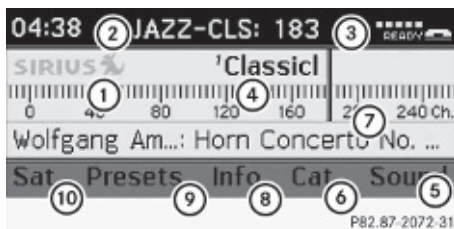

- ① Main area with channel display
- ② Selected program category
- ③ Number of selected channel
- ④ Selected channel
- ⑤ Sound settings
- ⑥ Selecting program category
- ⑦ Current artist and title
- ⑧ Channel information
- ⑨ Preset options
- ⑩ Satellite radio options

- i** Main area ① displays only channels that you have subscribed to. Which channels are shown depends on the selected program category ②. Only the currently selected channel ④ is displayed.

Note that categories and channels shown in illustrations are dependent on programming content delivered by the service provider. Programming content is subject to change.

Therefore, channel and categories shown in illustrations and descriptions contained in this manual may differ from the channels and categories delivered by the service provider.

Selecting program category

- i** The channels are categorized. Categories allow you to tune to stations broadcasting a certain type of program.

Satellite radio channels are split up into categories such as News, Sports, Rock, or Country, if available. The category list is sorted alphabetically.

- ▶ **Calling up category list:** (repeatedly, if necessary) → Cat.

or

- ▶ In Sat mode, slide or rotate until Cat. is highlighted and press . The category list appears.

- ▶ **Selecting a category:** Slide or rotate .

- ▶ **Setting the selected category:** Press . The selected program category (alphabetical order) will appear in the audio display. The last tuned channel in the new category will begin to play.

When searching, tuning in, or selecting from the channel list, the All Channels option accesses all of your subscribed channels.

- ▶ **i** When you select the category All Channels, you have access to all the channels you subscribed to, regardless of category.

Tuning in channels

You have the following selection options:

- the channel search function
- the manual channel number entry
- the channel list
- the channel presets

Tuning in channels using channel search function

- ▶ Slide or rotate when the main area in the basic menu is active. Depending on the direction in which the controller is being slid or rotated, the system searches upward or downward and stops at the next subscribed channel.

or

- ▶ Press button or on audio control unit. Depending on the pressed button, the system searches upward or downward and stops at the next subscribed channel.

- ▶ **i** Which channels are available depends on which channels you have subscribed to and the program category you have selected (▷ page 154). For tuning in channels you can also use the buttons on the multifunction steering wheel, see “Audio menu” (▷ page 126).

Tuning in channels using manual channel number entry

- ▶ (repeatedly, if necessary) → Sat → Enter Channel.

The menu for manual channel number entry appears.

or

- ▶ In Sat mode, press button on the keypad in audio control unit briefly.

▶ Channel number entry with keypad:

Enter desired channel number with buttons to with the keypad in audio control unit briefly.

Further operation depends on whether the selected channel number is valid or if the channel is included in your subscription.

▶ Exiting menu without making an entry:

Press button in the center console (▷ page 141).

Channel number is valid and channel is included in subscription: The audio system tunes in the channel entered.

Channel number is invalid: The message Invalid Channel appears in the audio display.

- ▶ The message disappears automatically or press to close the message.

Channel number is valid, but channel is not included in subscription: The message Call SIRIUS to activate: appears (▷ page 153).

- ▶ Press to close the message in the audio display.

Tuning in channels using the satellite radio channel list

- ▶ **RADIO** (repeatedly, if necessary) → Sat → Channel List.
The channel list appears. The dot • in front of a list entry indicates the currently selected channel.
- ▶ Select channel by rotating **⏪** or sliding **↑** **⏩**.
- ▶ Press **⏵** to confirm.

i The contents of the channel list depends on which channels are included in your subscription and which program category you have selected (▶ page 154). The channel list contains only the preview channel if the satellite radio service has not been subscribed to.

Tuning in channels using satellite radio channel presets

- ▶ **RADIO** (repeatedly, if necessary) → Presets.
- or
- ▶ Press **⏵** when the main area is selected in Sat mode.
The preset menu appears. The dot • in front of a preset position indicates that this is the channel currently selected and being listened to.



- ▶ Select station in memory by rotating **⏪** or sliding **↑** **⏩**.
 - ▶ Press **⏵** to confirm.
- or
- ▶ Press desired station button **1** to **0**, with the keypad in audio control unit briefly.

The audio system tunes in the corresponding channel as long as it is included in your subscription and is still available.

If the channel is not included in your subscription, the message Call SIRIUS to activate: appears.

If the channel is no longer available, the message Invalid Channel appears.

- ▶ **Closing message:** Press **⏵**.

Storing channels

- i** There are ten preset positions available.
 - ▶ Press **⏵** when the main area is selected.
- or
- ▶ **RADIO** (repeatedly, if necessary) → Presets.

In both cases, the preset menu will appear in the audio display. The dot • in front of a preset position indicates that the channel currently selected is stored there.

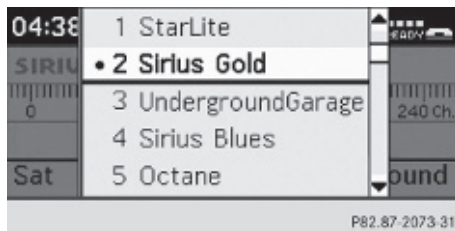

► **Selecting a preset position:** Slide $\uparrow \odot \downarrow$ or rotate $\left\{ \odot \right\}$.

► **Storing a preset position:** Press and hold \odot until you hear a signal. The channel is stored.

or

► Press and hold desired channel button $\boxed{1}$ to $\boxed{0}$ on keypad, until a brief signal tone sounds. The channel is stored.

Displaying information

► $\boxed{\text{RADIO}}$ (repeatedly, if necessary) \rightarrow Info (if available).

i If the program provider does not offer any information, the Info menu item cannot be selected.

You will see a screen that may contain the following information:

- the selected program category
- the selected channel
- the artist of the track currently being played
- the name of the current track

i SIRIUS XM determines what information is displayed on the screen. If the information is too long, the audio system shortens it.

With the telephone keypad button $\boxed{\#}$ you can call up a popup screen, if provided by SIRIUS XM, that shows the artist and title of the current track being played on the selected channel.

The popup screen disappears automatically.

► **Closing screen manually:** Slide $\leftarrow \odot \rightarrow$, rotate $\left\{ \odot \right\}$, press \odot or press button $\boxed{\text{BACK}}$.

Calling SIRIUS XM Service Center

i It may be necessary to call the SIRIUS XM Service Center if, for example:

- You want to cancel the subscription or re-subscribe at a later date.
- You have questions regarding billing.
- You sell the car.

► $\boxed{\text{RADIO}}$ (repeatedly, if necessary) \rightarrow Sat \rightarrow Service.

The telephone number of the SIRIUS XM Service Center and the twelve-digit electronic serial number (SIRIUS-ID) of the particular receiver are displayed.

► **Closing screen:** Slide $\leftarrow \odot \rightarrow$, press \odot or press button $\boxed{\text{BACK}}$.

Channel update

The service provider may conduct a channel update.

During the update, the message Updating Channels... will appear on the audio display.

The last tuned channel will be muted until the update is completed. You cannot operate the satellite radio during the update.

After completion of the update, the satellite radio basic menu will appear. The last tuned station will begin to play. If not available, the next subscribed channel starts beginning with channel 1.

Sound settings

For sound adjustment see:

- Volume (\triangleright page 144)
- Balance control and fader (\triangleright page 145)
- Bass and treble control (\triangleright page 145)
- Surround sound (\triangleright page 146)

CD and MP3 mode

Submenu overview

Menu	Submenu
CD or MP3	Normal Track Sequence
	Random Tracks
	Random Folders (MP3 mode only)
	AUX
Track list (Audio CD) or Folder (MP3)	Select track (CD mode only)
	Select folder and/or tracks (MP3 mode only)
Changer (with CD-changer only)	Select medium
	Eject all
	Fill empty slots
Sound	Treble
	Bass
	Balance/Fader
	Surround sound

- i** The components and operating principles of the audio system can be found on (▷ page 137) and (▷ page 143).

The audio system is fitted with either a single CD drive or a CD changer.

The single CD player and the CD changer can play audio CDs as well as CDs with MP3 or WMA files.

The available menu options will vary depending on the equipment and the type of CD.

Safety precautions

⚠ Warning!

The single CD player and the CD changer are classified as a Class 1 laser product. You must not open the casing. There is a risk of exposure to invisible laser radiation if you open the casing, or if the casing is faulty or damaged.

The single CD player and the CD changer do not contain any parts that you are able to maintain yourself. For safety reasons, all maintenance work must be carried out by qualified technicians.

⚠ Warning!

In order to avoid distraction which could lead to an accident, the driver should insert or eject CDs with the vehicle at a standstill and operate the audio system only if permitted by road, weather and traffic conditions.

Bear in mind that at a speed of just 30 mph (approximately 50 km/h), your vehicle is covering a distance of 44 feet (approximately 14 m) every second.

General notes

- i** Audio CDs with copy protection are not compatible with the CD audio standard and therefore may not be able to be played by the single CD player and/or the CD changer. There may be playback problems when playing copied discs.

There is a large variety of discs, disc-writing software and writers available. This variety means that there is no guarantee that the system will be able to play discs that you have written/copied yourself.

There may be playback problems if you use CD-R or CD-RW type discs you have compiled yourself with a storage capacity of more than 700 MB. These CDs are not compatible with currently applicable standards.

! Do not affix stickers or labels to the CDs, they can become warped due to the heat that develops in the CD drive or CD changer.

In certain situations, the CDs can then no longer be ejected and cause damage to the drive. Such damage is not covered by the Mercedes-Benz Limited Warranty.

! Your CD drive or CD changer has been designed to play CDs which correspond to the IEC 60908 standard. You can therefore only use CDs with a maximum thickness of 1.3 mm.

If you insert thicker discs, e.g. ones that have data on both sides (one side with DVD data, the other side with audio data), they cannot be ejected and will damage the drive.

Do not use CDs with a diameter of 8 cm. Attempting to play CDs with a diameter of 8 cm or playing such CDs with an adapter may cause damage to the CD drive. Such damage is not covered by the Mercedes-Benz Limited Warranty.

Only use round discs with a diameter of 12 cm.

Should excessively high or low temperatures occur while in CD changer mode, a message will appear in the display, and the CD will be muted until the temperature has reached an acceptable level for the system to continue operation.

Tips on handling CDs

- Only touch the CDs at the edges.
- Handle CDs carefully to prevent interference during playback.
- Avoid scratches, fingerprints and dust on the CDs.
- The CDs must only be labeled using pens specially designed for this purpose.
- Clean CDs from time to time with a commercially available cleaning cloth. Never wipe the CD in a circular motion;

instead, wipe it in a straight line starting in the center and moving outward. Do not use solvents, anti-static sprays, etc. for cleaning.

- Replace the CD in its case after use.
- Protect CDs from heat and direct sunlight.

Notes about MP3 mode

The single CD player and the CD changer can play audio CDs as well as CDs with MP3/WMA files.

i Due to the branched data structure, playback of the first track may be delayed slightly.

Permissible media for MP3/WMA files

- CD-R
- CD-RW

Permissible file systems

- ISO9660/Joliet for CDs

Multisession CDs

For multisession CDs, the first session type of the CD determines how the audio system will process the CD.

For example, if the first session type is according to the audio CD standard and the second session type is according to the data CD standard containing MP3/WMA tracks, the audio system will treat the CD as a conventional audio CD. This means that it is only possible to access the audio CD tracks. Access to the MP3/WMA tracks is not possible.

Similarly, if the first session type is according to the data CD standard containing MP3/WMA tracks and the second session type is according to the audio CD standard, the audio system will treat the CD as a data CD. This means that it is only possible to access the MP3/WMA tracks. Access to the audio CD tracks is not possible.

File structure on a disc

When you create an MP3/WMA disc, the MP3/WMA tracks can be organized in folders.

A folder can also contain other folders.

A disc can contain a maximum of 255 folders.

A folder can contain a maximum of 255 tracks and 255 subfolders.

A data medium may contain a maximum of 500 tracks.

The directory depth may not exceed a maximum of 8 levels. The system will ignore files in lower levels.

Track and folder names

When you create an MP3/WMA disc, you can assign names to the MP3/WMA tracks and folders.

The audio system uses these names for the corresponding display in MP3 mode. Empty folders or folders which contain data other than MP3/WMA tracks are not displayed by the audio system.

If MP3/WMA files are saved in the root directory itself (uppermost directory on storage medium), the root directory will also be treated as a folder. The audio system will then show the name of the root directory as the folder name.

You must observe the following when assigning track names:

- Track names must have at least one character.
- Track names must have the extension “mp3” or “wma”.
- There must be a period between the track name and the extension.

Example of a correct track name:

Track1.mp3

The audio system is unable to recognize an MP3/WMA track if

- there is no period between the track title and the extension
- there is no extension

- **i** The audio system does not support ID3 tags.

Supported file formats

Supported file formats are:

- MP3
- WMA

- **i** If music files of file formats other than MP3 are stored together with MP3 files on one disc, the loading process may take longer.

Permissible MP3 formats

The audio system supports the MPEG 1 Audio Layer 3 format.

- **i** This format is generally known as “MP3”.

Permissible bit and sampling rates are:

- fixed and variable bit rates up to 320 kbit/s
- Sampling rates of 24 kHz – 48 kHz

- **i** Only use MP3 tracks with a bit rate of at least 128 kbit/s or higher and a sampling rate of at least 44.1 kHz or higher. Smaller rates can cause a noticeable deterioration in sound quality. This is especially the case if you have the surround sound function activated.

WMA (Windows Media® Audio)

Windows Media® Audio (WMA) is an audio data compression technology developed by Microsoft®.

The audio system supports the following types of audio files:

- fixed bit rates of 5 kbit/s up to 384 kbit/s
- Sampling rates from 8 kHz to 48 kHz

The audio system does not support the following WMA files:

- DRM (Digital Rights Management) coded files
- variable bit rates

- WMA Pro
- 5.1 Surround

Notes on copyright

The music tracks that you create and play back in the MP3 and WMA format are generally subject to copyright protection in accordance with the applicable international and national regulations.

In many countries, reproductions are not permitted without the prior consent of the copyright holder, not even for private use.

Make sure you know the applicable copyright regulations and that you comply with these.

If you own these rights yourself, e.g. for your own compositions and recordings, or the copyright holder has granted you permission, these restrictions do not apply.

Operating the CD player

The single CD drive and the CD changer have the same controls.

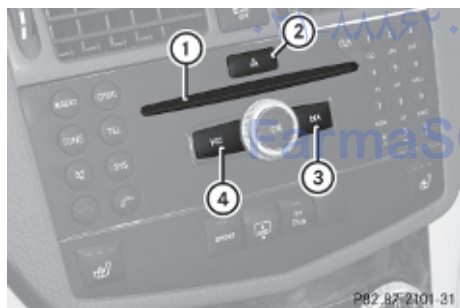

- ① CD slot
- ② Load/eject button
- ③ Forward
- ④ Rewind

Single CD player

- **Switching to CD mode:** Press button **[Disc]** on the audio control unit.

The CD display appears when you switch to CD mode. CDs start to play automatically when they are inserted. The following message will appear if no CD is inserted.

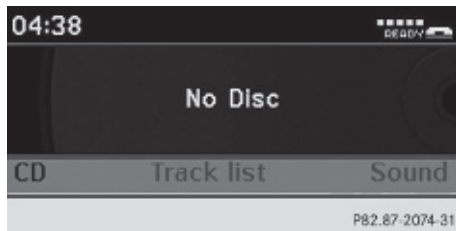

⚠ Warning!

In order to avoid distraction which could lead to an accident, the driver should insert or eject CDs with the vehicle at a standstill and operate the audio system only if permitted by road, weather and traffic conditions.

Bear in mind that at a speed of just 30 mph (approximately 50 km/h), your vehicle is covering a distance of 44 feet (approximately 14 m) every second.

- ❗ If a CD is already loaded, it must be ejected before inserting a new CD. Inserting a second CD in the slot with another CD still loaded will cause damage to the CD drive which is not covered by the Mercedes-Benz Limited Warranty.

- **Ejecting a CD:** Press load/eject button ②.

The system ejects the CD.

The message Please Remove Disc appears in the display.

- Remove CD from CD slot ①.

The message NO Disc appears in the display.

- ❗ If you do not take the CD out of the CD slot ① within approximately 15 seconds, the system automatically pulls the CD back in and plays it.

If you change modes (e.g. Radio) when the CD is being ejected, the CD will be reinserted automatically as well.

If a CD is pulled back in, press load/eject button ② again; the CD will then be ejected.

i If the audio CD is printed on one side, this side must face upwards when loaded. If neither side is printed, the side to be played must face downwards.

If a CD has been inserted incorrectly or cannot be read, Disc Unreadable appears in the display.

► **Loading a CD:** Insert CD into CD slot ①.

The system automatically pulls the CD into the CD slot ① and starts to play the audio CD if it has been inserted correctly and is permissible.

CD changer

The CD changer can hold up to a total of six audio CDs.

► **Switching to CD mode:** Press button **DISC** on the audio control unit.

The CD changer display appears when you switch to CD changer mode. If there is a CD in one of the magazine trays, it will start to play automatically. The following message will appear if no CDs are inserted.

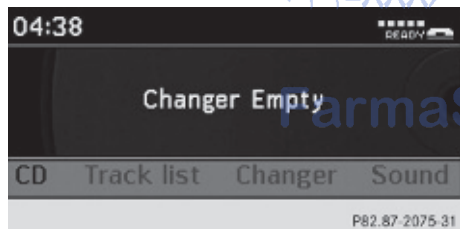

⚠ Warning!

In order to avoid distraction which could lead to an accident, the driver should insert or eject CDs with the vehicle at a standstill and operate the audio system only if permitted by road, weather and traffic conditions.

Bear in mind that at a speed of just 30 mph (approximately 50 km/h), your vehicle is covering a distance of 44 feet (approximately 14 m) every second.

i If the audio CD is printed on one side, this side must face upwards when loaded. If

neither side is printed, the side to be played must face downwards.

If a CD has been inserted incorrectly or cannot be read, Disc Unreadable appears in the display.

► **Loading an individual magazine compartment:** Press load/eject button ②.

A menu indicates which magazine compartments are currently loaded. The first available magazine compartment is indicated by a red number.

► Press desired button **1** to **6 MNO** in the keypad to select a magazine compartment. or

► Slide **←→** or rotate **⦿** to select a magazine compartment.

► Press **⏻** to confirm.

The CD changer will switch to the selected magazine compartment. The message Please Wait... appears in the display.

i Only insert a CD after the audio system has prompted you to do so with the message Please Insert Disc <X>. Only insert one CD per magazine compartment.

► Insert CD into CD slot ① (► page 161).

The CD changer automatically pulls the CD into CD slot ① and places it in the selected magazine compartment. The message Loading Disc <X> appears in the display.

i The loading process may take a while, depending on the type of disc. If you do not insert a disc, the display will switch back to the CD changer menu after approximately 20 seconds.

- ▶ Press button **DISC**, or load/eject button ② (▷ page 161) on the audio control unit to finish the loading process. The CD changer plays the disc if it has been inserted correctly and is permissible.
- ▶ **Interrupting loading procedure:** Press load/eject button ② again.

or

- ▶ Press button **BACK** in the center console (▷ page 141).

- ▶ **Filling an empty magazine compartment:** Press load/eject button ②.

A menu indicates which magazine compartments are currently loaded. The first available magazine compartment is indicated by a red number.

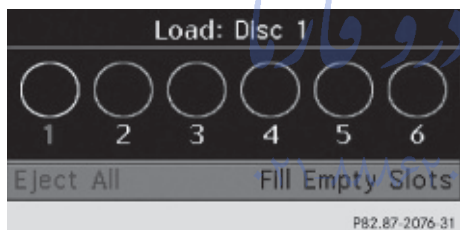

- ▶ Slide $\odot \downarrow$ to select the menu bar.
- ▶ Slide $\leftarrow \odot \rightarrow$ or rotate \odot the audio controller to select **Fill Empty Slots**.
- ▶ Press the audio controller \odot . The message **Please Insert Disc <X>** appears in the display.
- ▶ **i** Only insert a CD after the audio system has prompted you to do so with the message **Please Insert Disc <X>**. Only insert one CD per magazine compartment.
- ▶ Insert CD into CD slot ①. The CD changer automatically pulls the CD into CD slot ① and places it in an empty magazine compartment. The message **Please Wait...** appears in the display. If the CD is loaded, the CD changer will switch to the next empty magazine

compartment. The message **Please Insert Disc <X>** appears in the display.

- ▶ Repeat the steps until all compartments have been loaded.
- ▶ Press load/eject button ② on the audio control unit to finish the loading process. The CD changer plays the last loaded disc if it has been inserted correctly and is permissible.
- ▶ **Interrupting loading procedure:** Press load/eject button ② again.

or

- ▶ Press button **BACK** in the center console (▷ page 141).

The loading process has not been completed, the audio system will play the last inserted CD.

Ejecting CDs from CD changer

Warning!

In order to avoid distraction which could lead to an accident, the driver should insert or eject CDs with the vehicle at a standstill and operate the audio system only if permitted by road, weather and traffic conditions.

Bear in mind that at a speed of just 30 mph (approximately 50 km/h), your vehicle is covering a distance of 44 feet (approximately 14 m) every second.

- ▶ **i** If you eject a CD while another is being played, the audio system interrupts playback.
- ▶ **Ejecting one CD:** Press load/eject button ②. The magazine menu with active main area appears in the audio display. The magazine compartment with the current CD is highlighted.

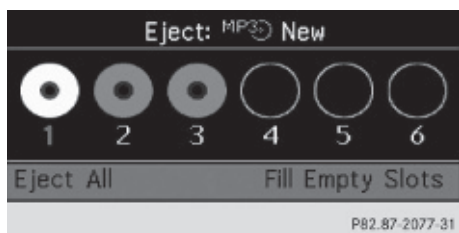

- ▶ Press desired button **1** to **6** in the keypad to select a magazine compartment.

or

- ▶ Slide **←** or rotate **⌂** the audio controller to select the desired CD.
- ▶ Press **⏻** to confirm.
The CD is ejected.

- ▶ Remove the CD from CD slot **①**.
If you do not remove the CD from the CD slot, the CD changer will automatically pull the CD back in after a short while.

- i** If audio source is changed during eject procedure (e.g. pressing button **RADIO**) the eject procedure will be aborted and any CDs being ejected will be drawn back into the unit.

- ▶ **Ejecting all CDs:** Press load/eject button **②**.
The magazine menu with active main area appears in the audio display. The magazine compartment with the current CD is highlighted.

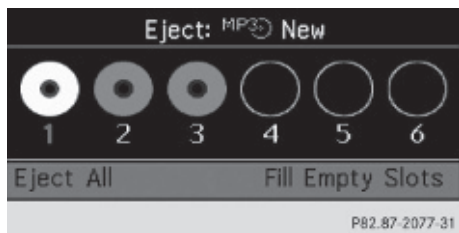

- ▶ Slide **⏻** to select the menu bar.
- ▶ Slide **←** or rotate **⌂** the audio controller to select **Eject All**.
- ▶ Press **⏻** to confirm.
The CDs are ejected one after the other.

- ▶ Remove the CD from CD slot **①**.
The CD changer switches to the next occupied magazine compartment and ejects the CD.

If you do not remove the CD from CD slot **①**, the CD changer will automatically pull the CD back in after a short while.

- i** If audio source is changed during eject procedure (e.g. pressing button **RADIO**) the eject procedure will be aborted and any CDs being ejected will be drawn back into the unit.
- ▶ Repeat the last step until the magazine is empty.

Selecting a CD

- ▶ **DISC** → Changer
The list with the magazine compartments appears in the audio display. The magazine compartment with the current CD is highlighted.
- ▶ Slide **↑** or rotate **⌂** the audio controller to select the desired CD.
- ▶ Press **⏻** to confirm.

Playing CDs

- i** The following section is valid for the single CD player and the CD changer. The illustrations show the audio display of the CD changer.

Additional button functions

In CD mode, you can use two additional buttons on the telephone keypad:

- #** displays information about the track, if it has been saved with the track on the CD.
- *** enables you to enter the track number directly.

Example display in audio CD mode

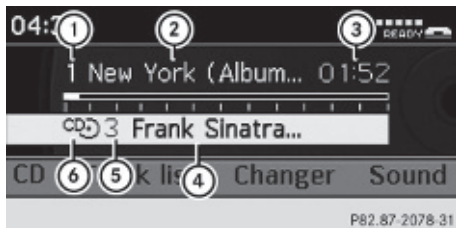

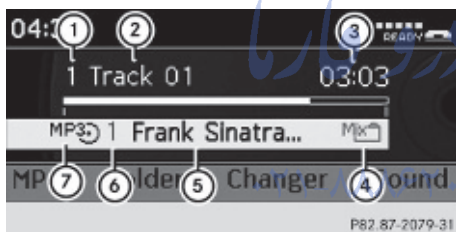

- ① Track number
- ② Track name (only if saved on the disc)
- ③ Elapsed track time
- ④ Disc name (only if saved on the disc)
- ⑤ Disc number (CD changer only)
- ⑥ Disc type

Example display in MP3 mode





- ① Track number
- ② File name
- ③ Elapsed track time
- ④ Current playback option (visible if activated)
- ⑤ Folder name (only if saved on the disc)
- ⑥ Disc number (CD changer only)
- ⑦ Disc type

Pause function

- ▶ **Pausing playback:** Press button  briefly.
- ▶ **Continuing playback:** Press button  again briefly.

Selecting a track

- ▶ **Skipping forwards or backwards to a track:** Rotate  or slide .



or



- ▶ Briefly press button  or  on audio control unit.

- ❗ **Skipping forwards through the tracks** skips to the next track. **Skipping backwards through the tracks** skips to the beginning of the current track if the track has been playing for more than 8 seconds. If the track has been playing for less than 8 seconds, it skips to the previous track. If you have switched on the Random Tracks playback option, the order of the tracks is random.

- ▶ **Selecting from the track list:**  → Track List.

or

- ▶ Press  when the main area is selected. The track list appears. In MP3 mode, the track list of the current folder appears. The dot  indicates the current track.

- ▶ Select a track by rotating  or sliding .



- ▶ Press  to confirm.

- ❗ In MP3 mode, the list shows all the tracks in alphabetical order.

Fast forward/rewind

- ▶ Select main area.
- ▶ Slide and hold  until desired position is reached.

or

- ▶ Press and hold button  or  on audio control unit.

Selecting a folder

- ❗ This function is only available in audio MP3 mode.



▶ **DISC** → Folder.

or

▶ Press  when the main area is selected. The track list of the current folder appears.

▶ **Move to the superordinate folder:** Select the  symbol.



The display now shows the next higher folder level.

▶ **Selecting a folder:** Slide   or rotate  the audio controller, to select the desired folder.

▶ Press  to confirm.

You will see the tracks in the folder.

i Due to the large amount of information on an MP3 disc it may take a while before all folder and track information becomes available. During this time the folder list may be unavailable or slow.

▶ Select a track by sliding   or rotating  the audio controller.

▶ Press  to confirm.

The track is played and the corresponding folder is now the active folder.

Playback options

The following options are available:

- Normal Track Sequence
Tracks playback in the order on the disc (e.g. track 1, 2, 3, etc.).

- Random Tracks
Tracks playback in a random order (e.g. track 3, 8, 5, etc.).

- Random Folder (in MP3 mode only)
Tracks in the active folder and any subfolders playback in random order.

▶ **Selecting an option:** **DISC** → CD/MP3. The option list appears. A dot ● indicates which option is switched on.

▶ Select an option and press .

The option is switched on. For all options except Normal Track Sequence, you will see a corresponding indicator in the main area.

i The Normal Track Sequence option is automatically activated when you select a different medium. If an option is activated, it remains activated after the audio system is switched on/off.

Audio AUX mode

An external audio source can be connected to the AUX socket of the audio system. Please contact an authorized Mercedes-Benz Center for more information.

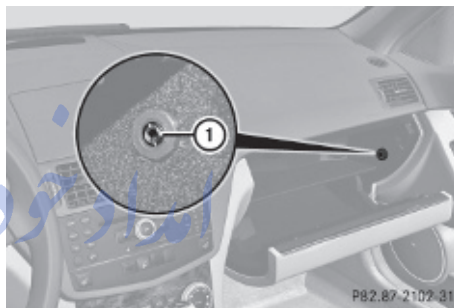

AUX socket **1** is designed for a 3.5 mm stereo jack (3-pin), for devices with dedicated analog audio output or connection via headphone port, e.g. MP3 or tape player.

Warning!

Operating an external audio source while the vehicle is in motion will distract you. You may not notice changing road and/or traffic conditions which may cause an accident.

Bear in mind that at a speed of just 30 mph (approximately 50 km/h), your vehicle is covering a distance of 44 feet (approximately 14 m) every second.

For your safety and the safety of others, pull over to a safe location and stop before operating an external audio source.

Calling up AUX mode

Warning!

Due to the different volumes of the external audio sources, system messages of the

vehicle may be much louder. You may need to disable these system messages or adjust the volume of these messages manually.

▶ Selecting audio AUX mode:

Press button **Disc** repeatedly until the main menu for AUX operation appears.

or

▶ In CD mode: Select CD/MP3 → Aux.

The audio AUX menu appears. The medium in the external audio source is heard, provided it is connected and switched to playback.

- ① Please refer to the relevant operating guide for operation of the external audio source.

The following settings can be made in the audio AUX mode:

- Volume (▷ page 144)
- Balance control and fader (▷ page 145)
- Bass and treble control (▷ page 145)
- Surround sound (▷ page 146)

- ① The volume of external audio sources is extremely variable. It is possible that a device connected as an external audio source will sound quieter or louder in the vehicle or that the usual maximum volume cannot be achieved. On certain devices the volume can be set separately. In this case, start at a moderate volume and increase it slowly. In this way, you can determine whether the system is capable of playback without distortion, even at high volume.

Volume adjustment for the audio device

You can increase the volume for the AUX socket in case the internal volume of the connected audio device is too low. Use the setting **Boost** for such devices.

You should set the system back to **Standard** before connecting a different audio device to the AUX socket.

- ▶ Select **Volume** in AUX mode. The selection list appears. The dot • indicates the currently selected setting.

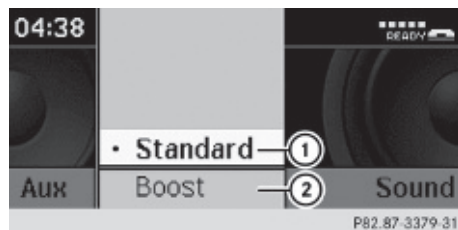

- ① Default setting
- ② Volume boost

Switch back to CD mode

- ▶ Press button **Disc**.

or

- ▶ Select **Back To Disc** in the audio AUX menu.

Telephone

Safety precautions

⚠ Warning!

Please do not forget that your primary responsibility is to drive the vehicle. A driver's attention to the road must always be his/her primary focus when driving. For your safety and the safety of others, we recommend that you pull over to a safe location and stop before placing or taking a telephone call.



If you choose to use the mobile phone¹⁷ while driving, please use the hands-free device and only use the mobile phone when road, weather and traffic conditions permit. Some jurisdictions prohibit the driver from using a mobile phone while driving a vehicle.

Bear in mind that at a speed of just 30 mph (approximately 50 km/h), your vehicle is covering a distance of 44 feet (approximately 14 m) every second.

¹⁷ Observe all legal requirements.

i The functions and services available to you while using the mobile phone depend on your service provider and the type of mobile phone you are using. Also see separate operating manual of your mobile phone for instructions on how to use your mobile phone.

When the mobile phone is connected via the Bluetooth® interface to the audio system, you can operate the mobile phone using the following devices:

- Audio system (▷ page 177)
 - Audio controller
 - Audio control unit
- Buttons  and  on the multifunction steering wheel (▷ page 118)
- Mobile phone keypad or similar input device

Please note that these functions are only available with Mercedes-Benz approved mobile phones.

TEL Menu

Menu	Function
Telephone	Bluetooth® Phones
	Receive Business Card(s) (vCards)
	Delete external data
Name	Phone book
Call lists Microphone off/ on	Call Lists or Mic On/ Mic Off
	Delete Call Lists

General notes

Making calls via Bluetooth® interface

The audio system telephone function via the Bluetooth® interface is available in conjunction with a Bluetooth® enabled mobile phone.

With a suitable mobile phone, you can use the hands-free device and receive electronic business cards (vCards) via the Bluetooth® interface.

Calls disconnected while the vehicle is in motion



Interruptions to the connection may occur if

- there is insufficient mobile network coverage
- you move from one mobile network transmitter/receiver area (mobile network cell) into another and no channels are free or the cell is full
- you are using a SIM card that is not compatible with the available network
- when using a mobile phone with “Twincard”, the mobile phone is simultaneously logged into the network with the second SIM card

Operating options

i The components and operating principles of the audio system can be found on (▷ page 137) and (▷ page 143).

When the mobile phone is connected via the Bluetooth® interface to the audio system, you can operate the mobile phone using the following devices:

- Buttons  and  and keypad on audio control unit (▷ page 138)
- Audio controller in center console (▷ page 140)
- Multifunction steering wheel (▷ page 118)

Please note that these functions are only available with Mercedes-Benz approved mobile phones. Please contact an authorized Mercedes-Benz Center for information on features available for your mobile phone of choice.

i In order for the functions described in this section to work correctly, the Bluetooth® telephone must be linked to the audio

system. Please make sure any other Bluetooth® device linked with the mobile phone is switched off before you use the telephone functions with the audio system.

Changes or modifications not expressly approved by the party responsible for compliance could void the user's authority to operate the equipment.

The head unit internal Bluetooth® transmitter must not be co-located or operated in conjunction with any other antenna or transmitter.

This equipment complies with FCC/IC radiation exposure limits set forth for uncontrolled equipment and meets the FCC radio frequency (RF) Exposure Guidelines in Supplement C to OET65 and RSS-102 of the IC radio frequency (RF) Exposure rules. This equipment has very low levels of RF energy that it is deemed to comply without testing of specific absorption ratio (SAR).

Unless otherwise indicated, the descriptions and illustrations in this section refer to the audio system.

Caller ID

The audio system can display the telephone number and the name of the caller, e.g. for an incoming call and also in other menus or displays.

For the telephone number to be displayed, the caller must transmit their telephone number. Otherwise Unknown will be shown on the audio display.

This is also the case for name displays. For this, the telephone number and the name of the caller must also be saved in the telephone book.

Functional restrictions

You will not be able to use the mobile phone, or you may have to wait a while, in the following situations:

- If the mobile phone is switched off.
- If the mobile phone is not connected via the Bluetooth® interface to the audio system.
- If the mobile phone is locked.
- If the mobile phone has not yet acquired a network signal.

The mobile phone automatically tries to log into a network. If no network is available, you will also not be able to make a "911" emergency call. If you attempt to make an outgoing call, the No Service message will appear for a short while.
- If you switch off the audio system in the middle of a call, e.g. by switching off the ignition, that call will be cut off. You can prevent this from happening as follows:
 - Switch the mobile phone to "private mode" before switching the audio system off (see mobile phone operating instructions).

Activating the mobile phone

Prerequisites for the mobile phone

For making calls using the audio system via the Bluetooth® interface, you will need a Bluetooth® enabled mobile phone.

Your mobile phone must support the Bluetooth® hands-free profile 1.0 or higher to make or receive calls (see mobile phone operating instructions).

- i For further information on suitable mobile phones and connecting Bluetooth®-enabled mobile phones to the audio system
 - visit **www.mbusa-mobile.com**
 - call the Mercedes-Benz Customer Assistance Center at 1-800-FOR-MERCEdes (1-800-367-6372) (in the USA)
 - call Customer Service at 1-800-387-0100 (in Canada)

Activating Bluetooth®

- ▶ Switch on the mobile phone (see mobile phone operating instructions).
- ▶ Enter the PIN (not necessary with some mobile phones or network).

- ▶ Activate Bluetooth® connection on the mobile phone (see mobile phone operating instructions).
- ▶ Press button **[TEL]** on the audio control unit to call up the telephone mode.

i On certain mobile phones, not only you will have to activate the Bluetooth® function but in addition, your own device must be made "visible" for other devices. Each Bluetooth® device has a Bluetooth® device name. It is recommended to give your mobile phone a personal name, by which you can clearly recognize your mobile phone.

i If the Bluetooth® function on the audio system is disabled, the message Bluetooth not activated in system settings appears.

- ▶ Activate Bluetooth® connection on the audio system (▷ page 147).
- ▶ **[sys]** → System → Activate Bluetooth.
You have activated or deactivated Bluetooth®. A checkmark appears when Bluetooth® is activated.

Registering a mobile phone (authorizing)

When you use your mobile phone in conjunction with the audio system for the first time, you must register (authorize) it.

It is possible to register up to 15 mobile phones. The connection is always established to the last activated mobile phones in signal range. When you authorize a new mobile phone, it is activated automatically. You can switch between the authorized mobile phones.

Searching for a mobile phone

- ▶ **[TEL]** → Te1 → Bluetooth Phones → Update.

The audio system searches for up to 10 suitable Bluetooth® telephones within range and enters them into the telephone list.

Authorized Bluetooth® telephones will be identified by a telephone-symbol ☎, in front of the list entry once the telephone list has been updated. The symbol will be grayed out if the authorized mobile phone is not located within the Bluetooth® range.

i The duration of the search procedure depends on the number and type of Bluetooth® telephones. The search may take a few minutes.

i If the telephone list is already full (15 entries), you must de-authorize one of the authorized devices (▷ page 172), and start the search again. Otherwise a new device you are looking for will not appear in the list. تلفن شیانہ

If the audio system does not find your mobile phone, external authorization may be necessary (▷ page 171).

Authorizing a Bluetooth® device

- ▶ Select the desired unauthorized device from the telephone list by pushing the audio controller.

or

- ▶ Select Options → Authorize.

The input menu for the passcode appears.

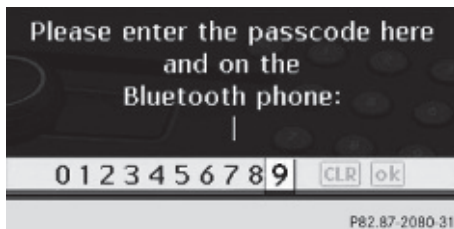

- i** The passcode is any one- to sixteen-digit number, which you can set yourself. For the quality of coding of the connection it is recommend to use a passcode of at least four digits. You must enter the same passcode into the audio system and the device to be authorized. Also refer to the operating instructions of the mobile phone.

On the audio system, you can enter the passcode via the digits in the on-screen menu bar or via the telephone keypad in the audio control unit.

With the audio controller:

- ▶ **Entering passcode:** Select the digits in the menu bar one by one, by sliding or rotating the audio controller.
- ▶ Press to confirm each digit.
- ▶ **Confirming passcode:** Select in the menu bar and press to confirm.
- ▶ **Deleting digits:** Select in the menu bar and briefly press to delete one digit, or press and hold to delete all entered digits.
- ▶ **Canceling entry:** Press button in the center console (▷ page 141).

With keypad on audio control unit:

- ▶ **Entering passcode:** Press the desired numbers on the keypad.
- ▶ **Confirming passcode:** Press button or button in the audio control unit to confirm.
- ▶ **Deleting digits:** Briefly press button in the audio control unit to delete one number, or press and hold button to delete all entered numbers.
- ▶ **Canceling entry:** Press button in the center console (▷ page 141).

Entering passcode into the mobile phone

If a Bluetooth® connection is established successfully, you will be prompted to enter a code into the mobile phone (see mobile phone operating instructions).

- ▶ Enter the same passcode on the mobile phone as you did on the audio system.

- i** You may need to confirm the authorizing on the mobile phone. Check your mobile phone display.

If the message **Authorization Procedure Unsuccessful** appears on the audio system display, you may have exceeded the preset period for authorization. Repeat the process.

The device is authorized. You can now make calls via the audio system hands-free device using the authorized mobile phone.

External authorization

If the audio system cannot find your mobile phone, this may be due to special security settings on your mobile phone. In this case, you can check whether, conversely, your mobile phone can find the audio system. The audio system's Bluetooth® device name is "MB Bluetooth".



▶ → Te1 → Bluetooth Phones → Update → Options → External Authorization.

The message **Ready for External Authorization** appears.

- ▶ Start Bluetooth® search procedure on the mobile phone (see mobile phone operating instructions).
- ▶ Select the audio system ("MB Bluetooth") at your mobile phone.
- ▶ When prompted to do so, enter the passcode on the mobile phone and then on the audio system.

Displaying details on a mobile phone

- ▶ → Te1 → Bluetooth Phones.
- ▶ Select the mobile phone from the list.

- ▶ Select Options → Details.
The details screen for the device is shown in the audio display.
- ▶ **Closing details screen:** Slide ←⊙→, rotate  or press , or press button **BACK**.

De-authorizing a Bluetooth® device

- ▶ **TEL** → Te1 → Bluetooth Phones.
 - ▶ Select authorized device.
 - ▶ Select Options → De-Authorize.
A prompt appears asking whether you really want to de-authorize this device.
 - ▶ Select Yes or No.
If you select Yes, the device will be de-authorized.
- i** If you de-authorize a device which has been authorized in the past and which is not detected in the search, this device will no longer be displayed in the device list.
Devices which have been authorized in the past but which are not detected in the search are either not switched on or not in the vehicle.

Activating another mobile phone

If you have several authorized mobile phones, you can switch between the individual mobile phones.

- i** You cannot switch to another authorized mobile phone during a call.

When you authorize a new mobile phone, it is automatically activated. Only one mobile phone can be active at a time.

- ▶ **TEL** → Te1 → Bluetooth Phones.
- ▶ Select an authorized mobile phone from the list.
- ▶ Press  to confirm.
The selected mobile phone will be searched for and connected if it is located in the Bluetooth® range and Bluetooth® is activated on the corresponding device.
The selected mobile phone is activated.

A dot • in front of the entry, indicates the current active mobile phone in the phone list.

Receiving business cards

You can import business cards (vCards) into the address book from external Bluetooth® devices (> page 174).





TEL-Basic display

- ▶ Press button **TEL** on the audio control unit to call up the telephone mode.

When the connected mobile phone is ready for operation, the display will look similar like this:



The following information is displayed in the status bar:

- Actual time: 04:38
- Bluetooth® device name of the connected mobile phone, in this case: blue_mobile.
- Mobile phone network signal strength . This information will only be shown with suitable mobile phones.
The bars indicate the current signal strength of the mobile phone network for reception. Optimum reception is indicated by all bars full. All bars empty indicates very poor or no reception.
- Receiver symbol  or . The receiver symbol indicates whether a call is being connected or is in progress:
 - not active

- **READY** indicates that a call is possible.
- **NO SERVICE** indicates that the mobile network is not available.

Setting transmit and receive volume

- i** These settings should normally not be changed as the factory settings are matched to most mobile phones. Find out about the optimum settings for your mobile phone at an authorized Mercedes-Benz Center.
 - i** Changes may result in significant impairments to the transmission quality. These settings may not be changed during an active phone call.
- ▶ **TEL** → Tel → Bluetooth Phones.
 - ▶ Select a mobile phone from the list.
 - ▶ Select **Options** → **Reception Volume** or **Transmission Volume**.
 - ▶ **Setting the volume:** Slide or rotate the audio controller. The volume bar moves up or down.
 - ▶ **Exiting menu:** Press or slide the audio controller or press button **BACK**.

Emergency calls "911"

- i** The "911" emergency call system is a public service. Using it without due cause is a criminal offense.
- i** This function places a call to the local "911" provider. It does not initiate a Tele Aid call.

The following describes how to dial a "911" emergency call using the audio system head unit when a Mercedes-Benz specified mobile phone is connected via the Bluetooth® interface to the audio system. Unless otherwise specified, the descriptions refer to the audio system head unit.

Consult the separate mobile phone operating instructions that came with your mobile phone for information on how to place a "911" emergency call on the mobile phone.

The following conditions must be met for a "911" emergency call via the audio system:

- Mobile phone must be switched on.
- The corresponding mobile communications network must be available.
- i** Emergency calls may not be possible with all telephone networks or if certain network services and/or telephone functions are active. Check with your local service providers and mobile phone instructions.

If you cannot make an emergency call, you will have to initiate rescue measures yourself.

Placing a "911" emergency call using audio control unit with the mobile phone unlocked

- ▶ Press button **TEL** to switch to telephone mode.
 - ▶ Enter 911 using the number keypad on the audio control unit.
 - ▶ Press button .
- or
- ▶ Press for dialing to begin. Connecting... appears in the audio display while the mobile phone establishes the connection.
 - ▶ Wait until the emergency call center answers, then describe the emergency.

- i** Depending on the phone type, if no SIM card is inserted in a GSM mobile phone or if there is no service on a CDMA mobile phone, **NO SERVICE** may appear in the audio display. In that case, you only can make an emergency call on the mobile phone itself, without the use of the audio control unit.

Placing a “911” emergency call with the mobile phone locked

- i** If the mobile phone is locked, you only can make an emergency call on the mobile phone itself, without the use of the audio control unit.

Phone book

You can save telephone numbers in the audio system’s phone book.

- i** These entries are retained even if you use the audio system with another mobile phone. You should delete these entries before handing over or selling your vehicle.

Receiving business cards (vCards)

You can import business cards (vCards) from external Bluetooth® phones into your audio system’s phone book. To do this:

- Bluetooth® must be activated on the audio system and on the external Bluetooth® phone (see the operating instructions of the mobile phone).
- The external Bluetooth® phone must be able to send vCards via Bluetooth® (see the operating instructions of the mobile phone).
- The external Bluetooth® phone in the vehicle must be switched on and authorized.

- i** If you switch to a different mode while vCards are being received (e.g., press button **[RADIO]**), reception of vCards will be aborted.

- ▶ **[TEL]** → Tel → Receive Business Card(s).
- ▶ Press **[OK]** to confirm.
- ▶ Wait until the message Ready to Receive - Received: 0 appears.
- ▶ **Importing:** Start the data transfer on the external Bluetooth® phone (“Export

business cards (vCards)”, see the operating instructions of the mobile phone).

The audio system imports the data for the business cards and displays the number of business cards received.

- i** Select **Back** or switch to a different mode to abort reception.

- ▶ **Ending reception:** Press **[OK]**.

or

- ▶ Press button **[BACK]** in the center console (▷ page 141).

Deleting external Data

- ▶ **[TEL]** → Tel → Delete External Data.

A prompt appears asking whether the data should be deleted.

- ▶ Select **Yes** or **No**.

If you select **Yes** all personal data are then deleted from the phone book.

Opening the phone book

- ▶ **[TEL]** → Name.

Entries in the phone book are displayed in alphabetical order. The search speller is active when more multiple entries are available. The search speller appears on the lower edge of the display.

You can use the search speller to reduce the number of entries you need to make.

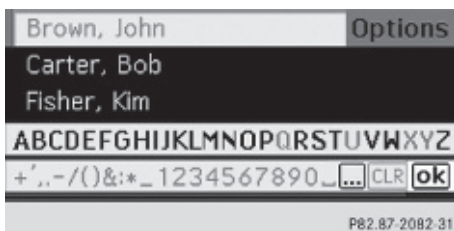

Symbol **[]** indicates that an entry contains more than one phone number. You can select these subentries (▷ page 176).

- ▶ **Switching from the search speller to the list:** Slide $\uparrow \odot$ repeatedly.

or

- ▶ Select $\boxed{\text{ok}}$.
- ▶ **Switching from the list to the search speller:** Press button $\boxed{\text{BACK}}$.

Selecting an entry

Selecting via search speller

- ▶ If necessary, switch from the list to the search speller.
- ▶ **Switching search speller character set:** Select $\bullet \bullet \bullet$.
Depending on the previous setting, this switches the search speller to letters with special characters or numbers with special characters.
- ▶ **Entering characters:** Slide $\leftarrow \odot \rightarrow$ or rotate $\left\{ \odot \right\}$ the audio controller to select the characters for the required entry. The first letters you enter determine the first letters of the name you are looking for.
- ▶ Press \odot to confirm.
The first entry containing the selected initial letters is highlighted in the list. If there are a number of similar entries, the next different character is displayed.

Example:

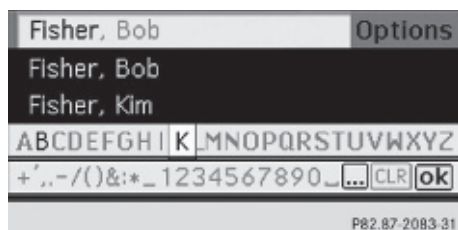

In the example, the first letters of the names Fisher, Bob and Fisher, Kim are the same. The first possible distinct letter is the B or the K.

Therefore, B and K are offered as possibilities.

- ▶ Select the characters for the required entry one after another.

As soon as the selection has been narrowed down to a single entry, the audio system will switch to the list automatically.

- ▶ **Deleting an individual character:** Select $\boxed{\text{CLR}}$ and briefly press \odot .

or

- ▶ Press button $\boxed{\text{CLR}}$ next to the audio controller.
After entering each character or after each deletion of a character, the closest matching entry is given at the top of the list.
- ▶ **Deleting an entire entry:** Select $\boxed{\text{CLR}}$ and press and hold \odot until the entire entry has been deleted.

or

- ▶ Press and hold button $\boxed{\text{CLR}}$ until the entire entry has been deleted.

- ▶ **Ending search:** Switch from the search speller to the list.
The top list entry is highlighted automatically.

Selecting via list

- ▶ If necessary, switch from the search speller to the list.

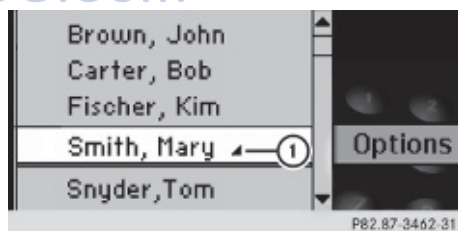





Phone book list

Entries with symbol $\textcircled{1}$ \square have additional options available, e.g. more phone numbers.



- ▶ Slide $\uparrow \odot \downarrow$ or rotate $\left\{ \odot \right\}$ the audio controller until the desired entry is highlighted.
- ▶ Press \odot to confirm and a call will be initiated.

Selecting subentries

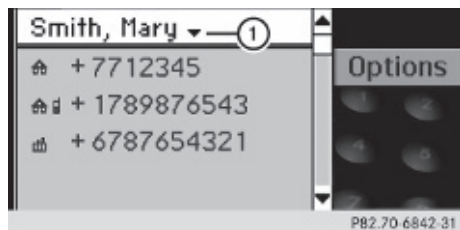

- ▶ Select an entry with the symbol  from the list and press .
- Symbol  changes to  and the subentries appear.







① Phone book entry with subentries

- ▶ Slide  or rotate  the audio controller until the desired subentry is highlighted.
- ▶ Press  to confirm and a call will be initiated.









Depending on the mobile phone and the entries in the mobile phone book, the phone numbers are assigned to categories. The categories are indicated by category symbols.

Number category	Display
Not classified	
Home	
Work	



Phone category	Display
Not classified	
Mobile	
Car	
Pager	

Displaying details on an entry

The audio system can also fully display an abbreviated entry.

- ▶ Select entry.
- ▶ Slide  to select Options.
- ▶ Press  to confirm.
- ▶ Select Details.
A popup screen with the details of the selected entry appears.
- ▶ **Closing popup screen:** Slide , , rotate , press , or press button  or .

Deleting entry

- ▶ Select entry.
- ▶ Slide  to select Options.
- ▶ Press  to confirm.
- ▶ Select Delete.
You will be prompted to confirm that you really want to delete the entry.
- ▶ Select Yes or No.
If you select Yes the actual entry is deleted from the phone book.

Call lists

The audio system displays the calls received (including missed calls) or made during phone mode in their own lists.

- i** The particular menu item can only be selected if calls have already been received or made from audio system.

Displaying missed calls in the audio system display is not possible with all mobile phones.

The control system displays the list of dialed numbers in the multifunction display.

- i** The audio system's call lists are not synchronized with the call lists on your mobile phone. If you make a call from your

mobile phone and only use the audio system's hands-free device, these calls will not be listed.

Calling up the list

- ▶ **[TEL]** → Call Lists.
- ▶ Select Calls Received or Calls Dialed.
The appropriate list appears.



- i** If there is a symbol with a telephone receiver in front of the phone number or the name, then you have missed this call (e.g. in the highlighted line of the following figure).



- ▶ Slide **↑** **⊙** **↓** or rotate **⌚** the audio controller until the desired entry is highlighted.
- ▶ **Initiating call:** Press button **☎** or **☎**.
- ▶ **To close the lists:** Press button **[BACK]**.

Deleting call lists

- i** The saved call lists are retained in the audio system, even if you use the audio system with another mobile phone. For this reason you should delete any call lists before handing over or selling the vehicle.

- ▶ In the phone main menu select Call Lists.
- ▶ Select Delete Call Lists.
You will be prompted to confirm that you really want to delete the entry. The question Do you want to delete the call lists appears in the display.
- ▶ Select Yes or No.
- ▶ Press **☎** to confirm.
If you select Yes both lists are deleted.

Making calls

- ▶ Press button **[TEL]** on the audio control unit to call up the telephone mode.
When the mobile phone is ready for operation, the display will look similar like this:

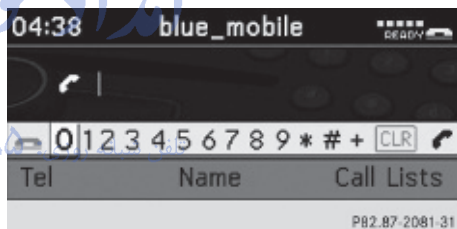

Initiating an outgoing call

Entering phone number via the audio control unit

You can enter numbers and special characters via the telephone keypad.

- ▶ **Entering:** Use **[0]** to **[9 wxyz]**, **[#]** and **[*]** to enter characters.
You can enter the * character by pressing button **[*]** once. You can enter the + character by pressing button **[*]** once and then again within approx. 1.5 seconds.
- ▶ **Initiating a call:** Press button **☎**.
- ▶ **Deleting individual digits:** Briefly press button **[CLR]** in the audio control unit.

- ▶ **Deleting an entire entry:** Press and hold button **CLR** until the entire entry has been deleted.

or





- ▶ Press button .

Entering phone number via the audio controller

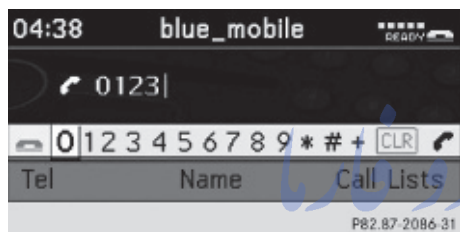

In addition to the actual menu bar, the telephone main menu features a second bar containing numbers, the number menu.

When the bar is active (highlighted), you can select elements.



- ▶ **Entering digits:** Slide $\leftarrow \odot \rightarrow$ or rotate  the audio controller to select the required digit.
- ▶ Press  to confirm.
- ▶ Repeat the procedure, until you have selected all digits for the necessary phone number.
- ▶ **Deleting individual digits:** Slide $\leftarrow \odot \rightarrow$ or rotate  to select **CLR** and briefly press .





or

- ▶ Press button **CLR** next to the audio controller.
- ▶ **Deleting entire phone number:** Slide $\leftarrow \odot \rightarrow$ or rotate  to select **CLR**, press and hold  until the phone number has been deleted.

or

- ▶ Press and hold button **CLR** until the entire entry has been deleted.



or

- ▶ Press button .
- ▶ **Initiating a call:** Slide $\leftarrow \odot \rightarrow$ or rotate  the audio controller to select .
- ▶ Press  to confirm.



or

- ▶ Press button .

Initiating a call to a phone book entry

- ▶ **TEL** → Name.
- ▶ Select entry (▷ page 175).
- ▶ Press button  or .

Initiating a call to a call list entry

- ▶ **TEL** → Call Lists.
- ▶ Select Calls Received or Calls Dialed.
- ▶ The appropriate list appears.
- ▶ Select entry (▷ page 176).
- ▶ Press button  or .



Redialing



- ▶ **i** In order to use the redial function, no numbers may have been entered.

- ▶ Press button .

or

- ▶ Select  and press .
- ▶ The dialed calls list appears. The call dialed last will be at the top of the list.

- ▶ **Selecting a call:** Slide $\leftarrow \odot \rightarrow$ or rotate  the audio controller until the desired entry is highlighted.

- ▶ **Initiating call:** Press button  or .

Aborting dial or ending a call

▶ **TEL** →  and press .

or

▶ Press button  on the audio control unit or on the multifunction steering wheel.

Rejecting or accepting calls

You will be notified of an incoming call by the ringing tone and a message on the display.

i Depending on the mobile phone you are using, the audio system's ringing tone may differ from the one you have set on your mobile phone. You may hear

- the ringing tone set on the mobile phone
- the audio system's preset ringing tone
- the audio system's preset ringing tone and the ringing tone set on the mobile phone

If the caller's name and number are among the entries in the audio system's phone book and the caller has not withheld this information, it will appear on the display. If the caller withholds this information, you will see:

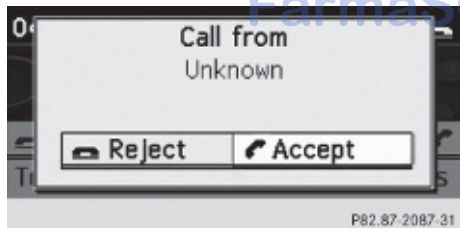



▶ **Accepting:** Press button  on audio control unit or on the multifunction steering wheel.

or

▶ Press .

▶ **Rejecting:** Press button  on audio control unit.

or

▶ Slide  or rotate  the audio controller to select **Reject**, and press  to confirm.

The call is rejected.

If you have accepted the call using the audio control unit, audio controller, or the multifunction steering wheel, the call will be conducted via the hands-free system. The volume of the call can be adjusted (▷ page 144).

Further operating functions can be found in the "Functions during a single-call" section (▷ page 179).

You can also accept a call if the audio display is showing a screen other than the telephone mode screen. After accepting the call, the display switches to the phone display. Once the call is over, the display for the previous mode will appear again.

Functions during a single call

Switching hands-free microphone on or off

The menu bar changes when you make or receive a call. Instead of the **Call Lists** menu item, **Mic Off** or **Mic On** will appear.

▶ **Switching off:** Select **Mic Off**.

The following message will flash up on the display: The microphone is off.

When the microphone is switched off the symbol  appears in the main area.

▶ **Switching on:** Select **Mic On**.

The following message will flash up on the display: The microphone is on.

The microphone is switched on and the symbol  disappears in the main area.

i You can also switch the microphone on or off by pressing button .

Sending DTMF tones

i This function is not possible with all mobile phones.

Answering machines or other devices can be controlled via DTMF tones, e.g. for remote query functions.

▶ **Transmitting individual characters:**

During a call select the required characters.

or

▶ Press the corresponding button on the audio control unit.

Every selected character is transmitted immediately.

▶ **Transmitting a phone number of a phone book entry as a sequence of characters:** Select Name.

▶ Select the desired phone book entry. The entry is transmitted immediately as a sequence of characters.

▶ **Switching back to call display:** Select Back.

Driving systems

Introduction

This section describes the following driving systems of your vehicle:

- Cruise control
- Hill-start assist system
- All-wheel drive (4MATIC)
- Dynamic handling package with sport driving mode
- Parktronic system, Canada only
- Rear view camera

The driving safety systems ABS, Adaptive Brake, BAS, EBP and ESP® are described in the “Safety and security” section (▷ page 60).

Cruise control

The cruise control maintains the speed you set for your vehicle automatically.

The use of the cruise control is recommended for driving at a constant speed for extended periods of time.



The currently set speed or last set speed (“Resume” function) appears in the multifunction display for approximately 5 seconds. The corresponding cruise control speed segments ① from the selected speed to the vehicle maximum speed in the multifunction display are illuminated.

⚠ Warning!

The cruise control is a convenience system designed to assist the driver during vehicle operation. The driver is and must always remain responsible for the vehicle’s speed and for safe brake operation.

Only use the cruise control if the road, traffic, and weather conditions make it advisable to travel at a constant speed.

- The use of the cruise control can be dangerous on winding roads or in heavy traffic because conditions do not allow safe driving at a constant speed.
- The use of the cruise control can be dangerous on slippery roads. Rapid changes in tire traction can result in wheel spin and loss of control.
- Deactivate the cruise control when driving in fog.

The “Resume” function should only be operated if the driver is fully aware of the previously set speed and wishes to resume this particular preset speed.

Warning!

The cruise control brakes automatically so that the set speed is not exceeded.

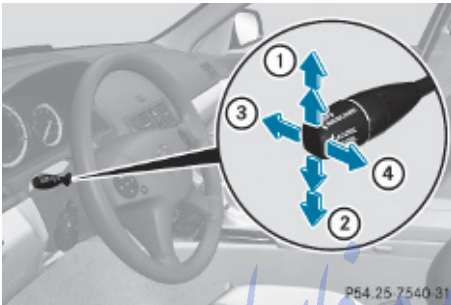

- ① Setting current or higher speed
- ② Setting current or lower speed
- ③ Canceling the cruise control
- ④ Activating the cruise control or resuming to last set speed

Activating cruise control

You can activate the cruise control at a vehicle speed above 20 mph (30 km/h).

You cannot activate the cruise control

- when you brake
- when you have engaged the parking brake
- when the automatic transmission is in park position **P**, reverse gear **R**, or neutral position **N**
- the ESP® is switched off or has switched off due to a malfunction

The vehicle speed displayed in the speedometer can briefly vary from the speed setting for the cruise control system.

Setting current speed

- ▶ Accelerate or decelerate to the desired speed.
- ▶ Briefly lift the cruise control lever in direction of arrow ① or press in direction of arrow ②.
- ▶ Remove your foot from the accelerator pedal.

i On uphill grades, the cruise control may not be able to maintain the set speed. Once the grade eases, the set speed will be resumed.

On downhill grades, the cruise control maintains the set speed by braking with the vehicle's brake system.

Vehicles with automatic transmission: In addition, on longer downhill grades the automatic transmission will downshift automatically.

i Vehicles with manual transmission: If you depress the clutch pedal when shifting into another gear, the engine speed may increase.

- Always drive with sufficient, but not excessive, engine speed.
- Shift the gear in a timely manner.
- Avoid shifting down more than one gear if at all possible.

Canceling cruise control

- ▶ Depress the brake pedal.
- or
- ▶ Briefly push the cruise control lever in direction of arrow ③.

The last set speed is stored for later use.

The last stored speed is deleted from memory when the engine is turned off.

The cruise control switches off automatically when you depress the brake pedal or you engage the parking brake. In this case, the cruise control speed segments in the multifunction display will go out.

The cruise control also switches off automatically when

- the vehicle speed falls below 20 mph (30 km/h)
- the ESP® is in operation
- the ESP® is switched off with the ESP® switch
- the ESP® has switched off due to a malfunction
- Vehicles with manual transmission: you engage neutral or depress the clutch pedal for more than 6 seconds during shifting into another gear
- Vehicles with manual transmission: you engage a gear too high for the current speed and thus the engine speed is too low
- Vehicles with automatic transmission: you shift the automatic transmission into neutral position **N** while driving

The cruise control speed segments in the multifunction display goes out and an acoustic warning will sound. Observe additional messages in the multifunction display that may appear.

Depressing the accelerator pedal does not deactivate the cruise control. After a brief acceleration (e.g. for passing), the cruise control will resume the last set speed.

Changing the set speed

Warning!

Keep in mind that it may take a brief moment until the vehicle has made the necessary adjustments.

Increase or decrease the set vehicle speed to a value that the prevailing road conditions and legal speed limits permit. Otherwise, sudden and unexpected acceleration or deceleration of the vehicle could cause an accident and/or serious injury to you and others.

You can increase or decrease the set speed in 1 mph (Canada: 1 km/h) increments or in 5 mph (Canada: 10 km/h) increments.

When you use the cruise control lever to decelerate, the brake system will brake the vehicle automatically if the engine's braking power does not brake the vehicle sufficiently.

Adjustment in 1 mph (Canada: 1 km/h) increments

i The set speed value is increased or decreased in 1 mph (Canada: 1 km/h) increments each time you lift or press the cruise control lever up or down to the resistance point.

► **Increasing:** Briefly lift the cruise control lever up to the resistance point in direction of arrow ①.

► **Decreasing:** Briefly press the cruise control lever down to the resistance point in direction of arrow ②.

► Release the cruise control lever. The new speed is set and the vehicle will accelerate or decelerate.

Adjustment in 5 mph (Canada: 10 km/h) increments

i The set speed value is increased or decreased in 5 mph (Canada: 10 km/h) increments each time you lift or press the cruise control lever up or down past the resistance point.

► **Increasing:** Briefly lift the cruise control lever up past the resistance point in direction of arrow ①.

► **Decreasing:** Briefly press the cruise control lever down past the resistance point in direction of arrow ②.

► Release the cruise control lever. The new speed is set and the vehicle will accelerate or decelerate. Keep in mind that it may take a brief moment until the vehicle has reached the set speed.

Setting stored speed (Resume function)

Warning!

The set speed stored in memory should only be set again if prevailing road conditions and legal speed limits permit. Possible acceleration or deceleration differences arising from returning to the preset speed could cause an accident and/or serious injury to you and others.

- ▶ Briefly pull the cruise control lever in direction of arrow ④.
If no speed is stored, the current speed is set and stored.
- ▶ Remove your foot from the accelerator pedal.

The last stored speed is deleted from memory when the engine is turned off.

Hill-start assist system

On uphill grades, the hill-start assist system maintains the pressure in the brake system for approximately 1 second after you have released the brake pedal. Therefore, you can start off smoothly without the vehicle moving immediately after releasing the brake pedal.

Warning!

The hill-start assist system is not designed to function as a parking brake. It does not prevent the vehicle from moving when parked on an incline.

Always engage the parking brake in addition to shifting the automatic transmission into park position **P** (manual transmission: shift into **1st** gear or reverse gear **R**).

- ▶ Depress the brake pedal.
- ▶ **Manual transmission:** Shift into **1st** gear or reverse gear **R**.
- ▶ Slowly release the clutch pedal, removing your foot from the brake pedal at the same

time, and carefully depress the accelerator pedal.

- ▶ **Automatic transmission:** Shift into drive position **D** or reverse position **R**.
 - ▶ Release the brake pedal.
 - ▶ Carefully depress the accelerator pedal.
- The hill-start assist system is inactive
- when starting off on a level road or downhill grades
 - with the automatic transmission in neutral position **N**
 - with the parking brake engaged
 - if the ESP[®] has switched off due to a malfunction

All-wheel drive (4MATIC)

In vehicles with all-wheel drive (4MATIC), both axles are powered at all times when the vehicle is being operated. The 4MATIC improves traction in conjunction with the ESP[®] (▷ page 62) and the Electronic Traction System (ETS/4-ETS) (▷ page 63).

Warning!

If a drive wheel is spinning due to insufficient traction:

- While driving off, apply as little throttle as possible.
- While driving, ease up on the accelerator pedal.
- Adapt your speed and driving style to the prevailing road conditions.

Failure to observe these guidelines could cause the vehicle to skid.

The 4MATIC cannot prevent accidents resulting from excessive speed.

- ❗ Do not tow with one axle raised. Doing so could damage the transfer case, which is not covered by the Mercedes-Benz Limited Warranty. All wheels must be on or off the

ground. Observe instructions for towing the vehicle with all wheels on the ground.

! Only conduct operational or performance tests on a two-axle dynamometer. If such tests are necessary, contact an authorized Mercedes-Benz Center. You could otherwise seriously damage the brake system and/or the transfer case which is not covered by the Mercedes-Benz Limited Warranty.

i In winter operation, the maximum effectiveness of the 4MATIC is only achieved with winter tires (▷ page 252) or snow chains as required.

Dynamic handling package with sport driving mode

The most important part of the dynamic handling package with sport driving mode is the variable damping system. It adjusts the damping to the respective driving condition automatically.

The damping adjustment depends on

- your driving style
- the road condition
- your individual selection, see the following description

Vehicles with automatic transmission: The sport driving mode button selects the automatic shift programs **C/S**. For information on the automatic shift programs, see “Automatic shift programs” (▷ page 111). The automatic transmission with dynamic handling package with sport driving mode contains additional steering wheel gearshift controls, see “One-touch gearshifting” (▷ page 112).

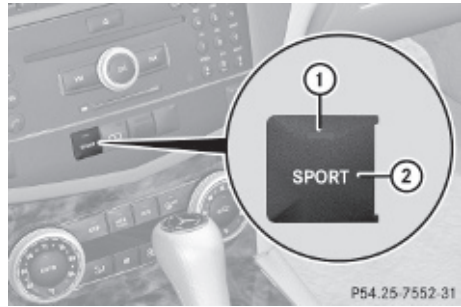

- ▶ Start the engine.

Sport driving mode

The firmer suspension tuning in sport driving mode provides enhanced road contact. Select this mode for example, on winding highways.

The setting remains stored until you turn off the engine.

- ▶ Press button ②.
Indicator lamp ① comes on. The sport driving mode is selected. Depending on engine version, the accelerator pedal may respond more immediate. In vehicles with automatic transmission, automatic program mode **S** is selected and will be displayed in the multifunction display (▷ page 112).

Comfort driving mode

Vehicle handling in comfort driving mode is softer. Select this mode when you prefer a more comfortable driving style on straight freeways.

- ▶ Press button ②.
Indicator lamp ① goes out. The comfort driving mode is selected. In vehicles with automatic transmission, automatic program mode **C** is selected and will be displayed in the multifunction display (▷ page 112).

Parktronic system (Parking assist)

This feature is only available in Canada vehicles.

The Parktronic system is an electronic parking aid with ultrasonic sensors designed to assist the driver during parking maneuvers. The Parktronic system indicates the relative distance between the vehicle and an obstacle visually and audibly.

The Parktronic system is activated automatically when

- you switch on the ignition and
- you release the parking brake and
- vehicles with automatic transmission: the automatic transmission is in drive position **D**, reverse gear **R**, or neutral position **N**

The Parktronic system deactivates at speeds above approximately 11 mph (18 km/h). At lower speeds, the Parktronic system activates again.

The Parktronic system also deactivates when you shift the automatic transmission into park position **P** or engage the parking brake. The Parktronic system monitors the surroundings of your vehicle with six sensors in the front bumper and four sensors in the rear bumper.

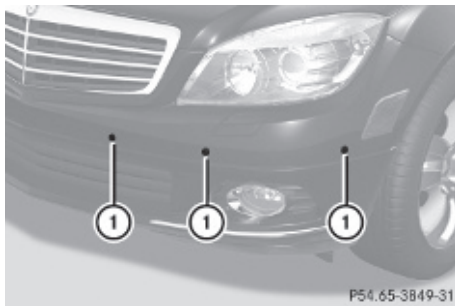

P54.65-3849-31

Example illustration, sensors in the front bumper
To function properly, sensors ① must be free of dirt, ice, snow and slush. Clean sensors ① regularly. Be careful not to

scratch or damage sensors ①, see “Cleaning the driving systems sensors” (▷ page 263).

Warning!

The Parktronic is a supplemental system. It is not intended to, nor does it replace, the need for extreme care. The responsibility during parking and other critical maneuvers always remains with the driver.

Warning!

Make sure no persons or animals are in or near the area in which you are parking/maneuvering. Otherwise, they could be injured.

- ❗ Special attention must be paid to objects with smooth surfaces or low silhouettes (e.g. trailer couplings, painted posts, elevated crossbars or road curbs). Such objects may not be detected by the system and can damage the vehicle.

During parking maneuvers, pay special attention to objects located above or below the height of the sensors (e.g. street curbs, painted posts, or trailer hitches etc.). The Parktronic system will not detect such objects at close range and damage to your vehicle or the object may result.

- ❗ Ultrasonic signals from outside sources (e.g. truck air brakes, car wash, or jackhammers) may impair the operation of the Parktronic system.

Range of the sensors

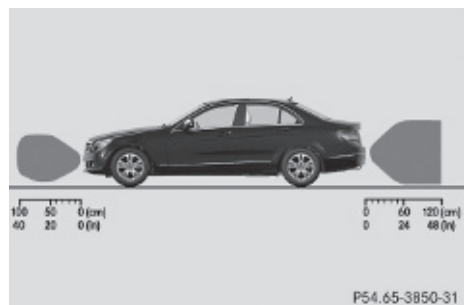

P54.65-3850-31

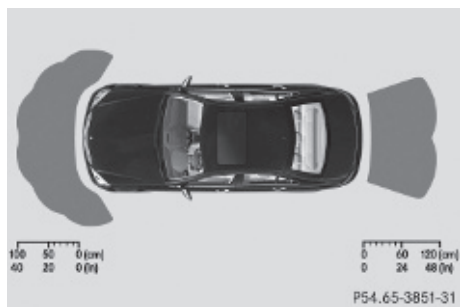

Front sensors

Center	approx. 40 in (100 cm)
Corners	approx. 24 in (60 cm)

Rear sensors

Center	approx. 48 in (120 cm)
Corners	approx. 32 in (80 cm)

Minimum distance

Center	approx. 8 in (20 cm)
Corners	approx. 6 in (15 cm)

If the Parktronic system detects an obstacle in this range, all the distance warning segments illuminate and you hear a warning signal. If the obstacle is closer than the minimum distance, the actual distance may no longer be indicated by the Parktronic system.

Warning indicators

Visual signals indicate the relative distance between the sensors and an obstacle.

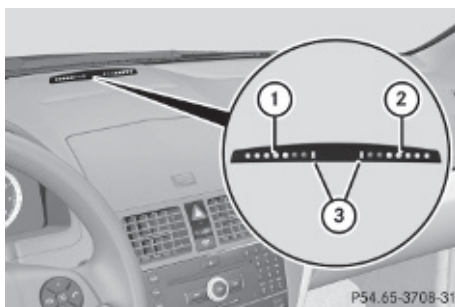

Front area warning indicators

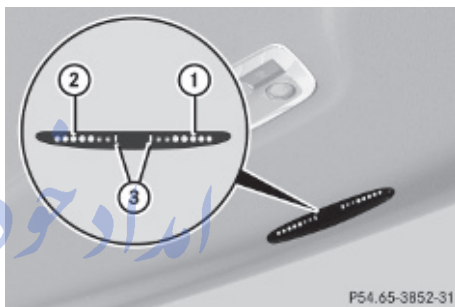

Rear area warning indicators

Each warning indicator is divided into five yellow and two red distance segments for left side ① and right side ② of the vehicle. The Parktronic system is ready to measure when the yellow readiness indicators ③ are illuminated.

The current transmission position determines which warning indicator will be activated.

Manual transmission:

Current transmission position	Warning indicator
Forward gear or neutral position	Front area activated
Reverse gear	Front and rear area activated

Automatic transmission:

Current transmission position	Warning indicator
D	Front area activated
R or N	Front and rear area activated

As your vehicle approaches an object, one or more distance segments will illuminate, depending on the distance. When the seventh distance segment illuminates, you have reached the minimum distance.

- Front area:** An intermittent acoustic warning will sound as the first red distance segment illuminates and a constant acoustic warning lasting a maximum of 2 seconds will sound for the second red distance segment. Vehicles with automatic transmission: The signal is canceled when the automatic transmission is shifted into park position **P** or the parking brake is engaged. Vehicles with manual transmission: The signal is canceled when the parking brake is engaged.
- Rear area:** An intermittent acoustic warning will sound as the first red distance segment illuminates and a constant acoustic warning lasting a maximum of 2 seconds will sound for the second red distance segment. Vehicles with automatic transmission: The signal is canceled when the automatic transmission is shifted into drive position **D**, or park position **P**, or the parking brake is engaged. Vehicles with manual transmission: The signal is canceled when the manual transmission is shifted into neutral position, or in a forward gear, or the parking brake is engaged.

Switching the Parktronic system on/off

The Parktronic system switches on automatically when the ignition is switched on.

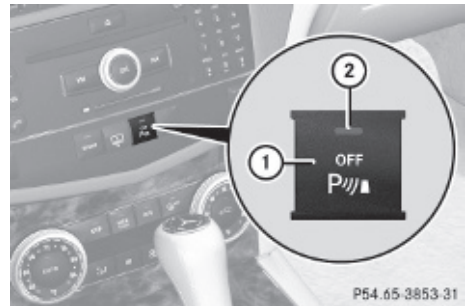

- Switching off:** Press Parktronic switch ①. Indicator lamp ② comes on.
- Switching on:** Press Parktronic switch ① again.

Parktronic system malfunction

There is a malfunction in the Parktronic system, if only the red distance segments illuminate and an acoustic warning sounds. The Parktronic system will switch off automatically after 20 seconds and indicator lamp ② in Parktronic switch ① comes on.

- Have the Parktronic system checked at an authorized Mercedes-Benz Center as soon as possible.

If only the red distance segments illuminate and no acoustic warning sounds, the Parktronic system sensors are dirty (e.g. dirt, ice, snow and slush). Another cause could be interference from other radio or ultrasonic signals (e.g. truck air brakes, car wash, or jackhammers). The Parktronic system will switch off automatically after 20 seconds and indicator lamp ② in Parktronic switch ① comes on.

- ▶ Switch off the ignition.
- ▶ Clean the Parktronic system sensors (▷ page 263).
- ▶ Switch on the ignition.
 - or
- ▶ Check the Parktronic system operation at another location to rule out interference from outside radio or ultrasonic signals.

Rear view camera

The rear view camera is an optical parking aid. The area behind the vehicle appears in the COMAND system display as a mirror image, like in the rear view mirror.

Warning!

Make sure no persons or animals are in or near the area in which you are parking/maneuvering. Otherwise, they could be injured.

Warning!

The rear view camera is only an aid and may display obstacles

- from a distorted perspective
- inaccurately
- may not display obstacles at all

The rear view camera does not relieve you of the responsibility to be cautious. Take care and pay careful attention. The rear view camera may not show objects which are

- very close to the rear bumper
- under the rear bumper
- above the trunk handle

You are responsible for safety at all times and must continue to pay attention to the immediate surroundings when parking and maneuvering. This includes the area behind, in front of, and beside the vehicle. Otherwise you could endanger yourself and/or others.

Warning!

The rear view camera either will not function or will not function to its full capability if

- the trunk lid is open
- it is raining very hard, snowing or foggy
- it is night or you are parking/maneuvering your vehicle in an area where it is very dark
- the camera is exposed to a very bright white light
- the immediate surroundings are illuminated with fluorescent light (the COMAND system display can flicker)
- there is a sudden change in temperature, e.g. if you drive into a heated garage from the cold (lens condensation)
- the camera lens is dirty or covered
- the rear of your vehicle is damaged

In this case, have the position and setting of the camera checked by a qualified specialist workshop. Mercedes-Benz recommends that you contact a Mercedes-Benz Center for this purpose.

Do not use the rear view camera in these situations. Otherwise you could injure yourself or others and/or damage property including your vehicle while parking/maneuvering.

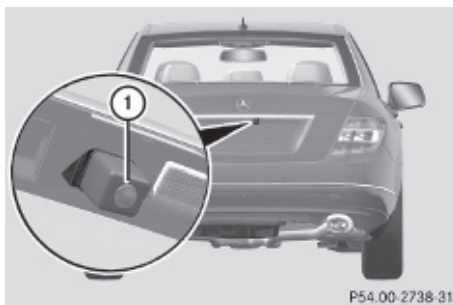

Camera lens ① must be free of dirt, ice, snow, and slush to function properly. Clean the camera lens regularly. Being careful not to scratch or damage the camera lens, see

P54.00-2738-31

“Cleaning the rear view camera lens”
(▷ page 263).

Switching on or off

- ▶ **Switching on:** Switch on the ignition.
- ▶ Make sure the rear view camera is switched on in the COMAND system. For more information refer to separate COMAND operating instructions.
- ▶ Switch on the COMAND system.
- ▶ Shift the automatic transmission to reverse gear **R**.
The area behind the vehicle appears in the COMAND system display.

i The image from the rear view camera will no longer be displayed if you select another function on the COMAND system while reverse gear **R** is engaged. To display the image again, disengage and reengage reverse gear **R**.

- ▶ **Switching off:** Shift the automatic transmission into park position **P**, neutral position **N**, or drive position **D**.

Climate control system





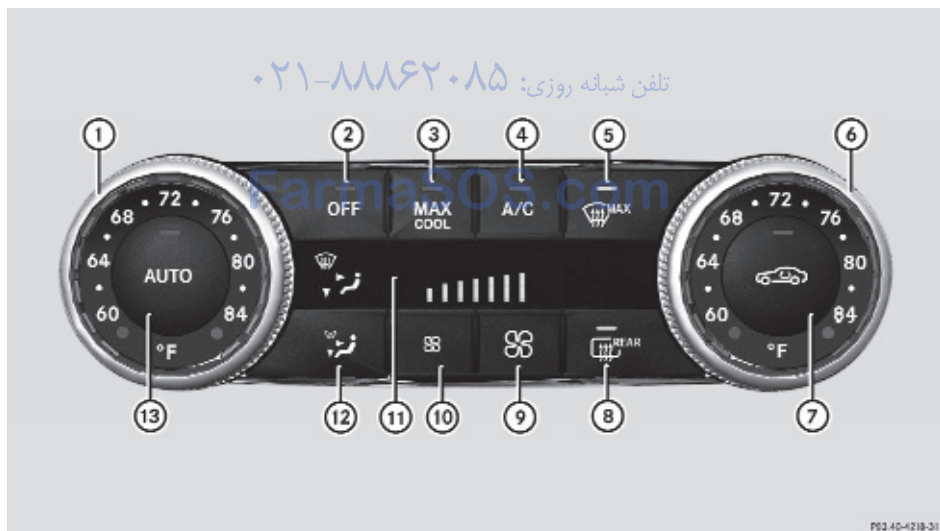



Control panel

Dual-zone automatic climate control



P03-4C-4218-31

Function	Recommendation/Notes	
① Temperature control, driver's side	i Set the temperature to 72°F (22°C).	(▷ page 192)
② Climate control on/off	i Switch on/off the climate control system.	(▷ page 191)

Function	Recommendation/Notes	
③  on/off (USA only)		(▷ page 195)
 Adopting driver's side settings for all zones (Canada only)		(▷ page 196)
④ AC cooling on/off	 Switch on/off the air conditioning.	(▷ page 191)
⑤ Front defroster	 Keep this setting selected only until the windshield or the side windows are clear again.	(▷ page 194)
⑥ Temperature control, passenger side	 Set the temperature to 72°F (22°C).	(▷ page 192)
⑦ Air recirculation	 Only use this function for a short time, e.g. in a tunnel. Otherwise, the windows can fog up due to lack of fresh air.	(▷ page 195)
⑧ Rear window defroster		(▷ page 196)
⑨ Increasing air volume		(▷ page 194)
⑩ Decreasing air volume		(▷ page 194)
⑪ Display		
⑫ Air distribution		(▷ page 194)
⑬ Air distribution and air volume (automatic mode)	 Switch on the automatic mode. The indicator lamp in button  comes on.	(▷ page 192)

Notes on climate control system

The climate control system is operational whenever the engine is running. You can operate the climate control system in either the automatic or manual mode. The system cools or heats the interior depending on the selected interior temperature.

It can only function optimally when you are driving with the windows, the tilt/sliding sunroof or tilt/sliding panel closed.

Nearly all dust particles, pollutants and odors are filtered out before outside air enters the passenger compartment through the air distribution system.

⚠ Warning!

Severe conditions (e.g. strong air pollution) may require replacement of the filter before its scheduled replacement interval. A clogged filter will reduce the air volume to the interior and the windows could fog up, impairing visibility and endangering you and others. Have a clogged filter replaced as soon as possible at an authorized Mercedes-Benz Center.

The air conditioning will not engage (no cooling) if the **A/C** mode (▷ page 191) is deactivated.

⚠ Warning!

Follow the recommended settings for heating and cooling given on the following pages. Otherwise the windows could fog up, impairing visibility and endangering you and others.

- ▶ Keep the air intake grille in front of the windshield free of snow and debris.

Do not obstruct air flow by placing objects on the air flow-through exhaust slots below the rear window.

- i** If the vehicle interior is hot, ventilate the interior before driving off, see “Summer opening feature” (▷ page 99). The climate control will then adjust the interior temperature to the set value much faster.

Deactivating the climate control system**⚠ Warning!**

When the climate control system is deactivated, the outside air supply and circulation are also deactivated. Only choose this setting for a short time. Otherwise the windows could fog up, impairing visibility and endangering you and others.

- ▶ **Deactivating:** Press button **[OFF]**.
The indicator lamp in the button comes on.
- ▶ **Reactivating:** Press button **[OFF]**.
The indicator lamp in the button goes out. The previous settings are once again in effect.

or

- ▶ Press button **[AUTO]**.
The indicator lamp in the button comes on. Air volume and air distribution are adjusted automatically.

Air conditioning

The air conditioning is operational while the engine is running and cools the interior air to the temperature set by the operator. In addition, the air conditioning dehumidifies the interior air and helps prevent window fogging.

⚠ Warning!

If you deactivate the air conditioning, the vehicle will not be cooled when weather conditions are warm. The windows can fog up more quickly. Window fogging may impair visibility and endanger you and others.

- i** Condensated water may drip out from underneath the vehicle. This is normal and not an indication of a malfunction.

The air conditioning uses the refrigerant R134a. This refrigerant is free of CFCs which are harmful to the ozone layer.

Deactivating

It is possible to deactivate the air conditioning. The interior air will then no longer be cooled or dehumidified.

- ▶ Press button **[A/C]**.
The indicator lamp in the button goes out. The cooling function switches off after a short delay.

Activating

Moist air can fog up the windows. You can dehumidify the interior air with the air conditioning.

- ▶ Press button .

The indicator lamp in the button comes on.

- ❗ The evaporator will be vented when the air conditioning has been in use. Approximately 1 hour after locking the vehicle, the blower switches on automatically. The blower will run for 30 minutes at its lowest level. The blower noise is normal and not an indication of a malfunction. When you unlock the vehicle in the meantime, venting will be interrupted. If the vehicle battery is low, automatic evaporator venting will not occur in order to preserve the battery.

Automatic mode



When operating the climate control system in automatic mode, the interior air temperature, air volume and air distribution are adjusted automatically.

In automatic mode, cooling with dehumidification is switched on. This function can be switched off if necessary.

Warning!

If you deactivate the air conditioning, the vehicle will not be cooled when weather conditions are warm. The windows can fog up more quickly. Window fogging may impair visibility and endanger you and others.

- ▶ Set the desired temperature (> page 192).
- ▶ **Activating:** Press button . The indicator lamp in the button comes on. The air volume and air distribution are adjusted automatically.

- ▶ **Deactivating:** Press button ,  or .

The indicator lamp in button  goes out. The automatic operation of air volume and air distribution switches off. The symbols of air distribution or air volume appear in display ⑪ (> page 189).

- ▶ Adjust air distribution (> page 194).
- ▶ Adjust air volume (> page 194).

Setting temperature

You can adjust the air temperature on each side of the passenger compartment. You should raise or lower the temperature setting in small increments, preferably starting at 72°F (22°C).

You can adjust the air temperature on each side of the passenger compartment. You should raise or lower the temperature setting in small increments, preferably starting at 72°F (22°C).

- ▶ **Increasing/decreasing:** Turn temperature controls ① and ⑥ (> page 189) slightly clockwise or counterclockwise.

Adjusting air vents

Warning!

When operating the climate control, the air that enters the passenger compartment through the air vents can be very hot or very cold (depending on the set temperature). This may cause burns or frostbite to unprotected skin in the immediate area of the air vents.

Always keep sufficient distance between unprotected parts of the body and the air vents. If necessary, use the air distribution adjustment to direct the air to air vents in the vehicle interior that are not in the immediate area of unprotected skin.

For best possible performance of the climate control:

- ▶ Keep the air intake grille in front of the windshield free of snow, leaves, sticks, and any other debris.
- ▶ Always keep all air vents and grilles in the passenger compartment free from obstruction.

- ① For draft-free ventilation, move the adjustable center and side air vents to the middle position.

Center air vents

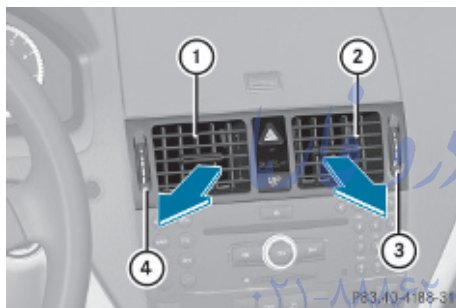

- ① Left center air vent, adjustable
 - ② Right center air vent, adjustable
 - ③ Thumbwheel for air volume control for adjustable right center air vent
 - ④ Thumbwheel for air volume control for adjustable left center air vent
- ▶ **Opening/closing:** Turn thumbwheels ③ and ④ upward or downward.

Side air vents

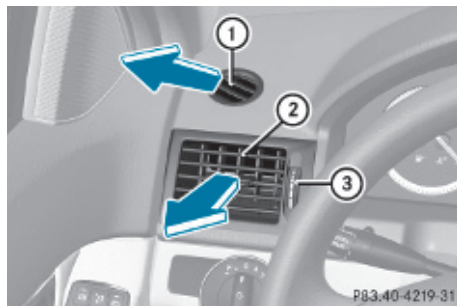

Example illustration driver's side

- ① Left side defroster air vent, fixed
- ② Left side air vent, adjustable
- ③ Thumbwheel for air volume control for adjustable left side air vent

- ▶ **Opening/closing:** Turn thumbwheel ③ upward or downward.

Ventilated glove box

The glove box can be ventilated, for instance to cool its contents, when the climate control system is activated. The level of airflow to the glove box depends on the airflow and air distribution settings. The temperature of the air is approximately the same as that of the air flowing from the center air vents.

- ❗ Close the glove box air vent when heating the vehicle interior. Activate the air conditioning (cooling function) when the outside temperature is high. Otherwise, temperature-sensitive items stored in the glove box could be damaged.

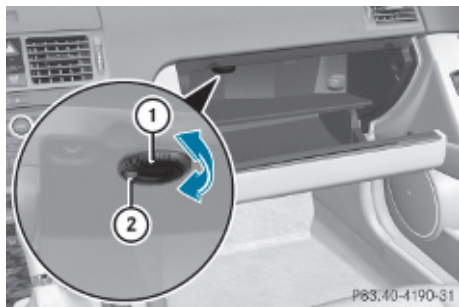

- ① Thumbwheel
- ② Air vent

► **Opening/closing:** Turn thumbwheel ① clockwise or counterclockwise.

Rear center console air vents

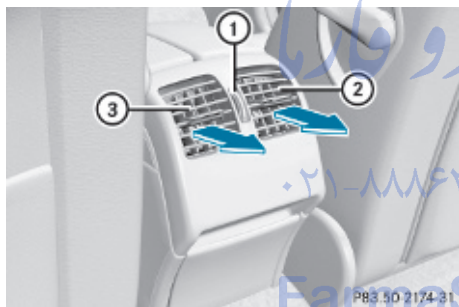

- ① Thumbwheel for air volume control for rear center air vents
- ② Right rear center air vent, adjustable
- ③ Left rear center air vent, adjustable

► **Opening/closing:** Turn thumbwheel ① upward or downward.

Adjusting air distribution

The symbols shown in display ⑪ (► page 189) on the climate control panel represent the following functions:

Symbol Function

	Directs air through the defroster air vents to the windshield and front door windows
	Directs air through the center and side air vents
	Directs air to the footwells
	Directs air through the center and side air vents and to the footwells
	Directs air into the entire vehicle interior (Canada only)
	Directs air through the center, side and defroster air vents to the windshield and front door windows (Canada only)
	Directs air through the defroster air vents to the windshield and front door windows and to the footwells

► Press button repeatedly until you have select the desired setting and the corresponding symbol is shown in display ⑪.

Adjusting air volume

► **Decreasing/increasing:** Press button or .

Front defroster

You can use this setting to defrost the windshield, for example if it is iced up.

You can also defog the windshield and the front door windows.

i Keep this setting selected only until the windshield or the front door windows are clear again.

► **Activating:** Press button .

The indicator lamp in the button comes on.

The climate control switches to the following functions automatically:

- cooling on to dehumidify
- most efficient blower speed and heating power, depending on outside temperature
- air flows onto the windshield and the front door windows
- the air recirculation mode is switched off

i You can adjust the air volume when the front defroster is switched on.

► **Deactivating:** Press button  again.

The indicator lamp in the button goes out.

The previous settings are once again in effect. The cooling remains switched on.

The air recirculation remains switched off.

or

► Press button .

The indicator lamp in button  goes out.

Air volume and air distribution are adjusted automatically.

i To deactivate defrosting, you can also press button  or turn temperature controls.

Windshield fogged on the outside

► Switch the windshield wipers on (▷ page 96).

If the automatic mode of the climate control is switched off:

► Press button  repeatedly until one of the following symbols appears in display  (▷ page 189)  or .

Maximum cooling MAX COOL

MAX COOL is only available in U.S. vehicles.

MAX COOL is only operational when the engine is running.

You can use this setting to provide the fastest possible cooling of the vehicle interior (when windows and tilt/sliding sunroof or tilt/sliding panel are closed).

► **Activating:** Press button .

The indicator lamp in the button comes on.



The climate control switches automatically to the following functions:

- maximum cooling
- maximum blowing power
- the air recirculation mode is switched on

► **Deactivating:** Press button  again.

The indicator lamp in the button goes out.

The previous settings are once again in effect.

i To switch the maximum cooling function off, you can also press button ,  or .

Air recirculation mode

Switch to air recirculation mode to prevent unpleasant odors from entering the vehicle from the outside (e.g. before driving through a tunnel). This setting cuts off the intake of outside air and recirculates the air in the passenger compartment.

Warning!

Fogged windows impair visibility, endangering you and others. If the windows begin to fog on the inside, switching off the air recirculation mode immediately should clear interior window fogging. If interior window fogging persists, make sure the air conditioning is activated, or press button



► **Activating:** Press button .

The indicator lamp in the button comes on.

i The air recirculation mode is activated automatically at high outside temperatures.

The indicator lamp in button  is not lit when the air recirculation mode is switched on automatically.

A quantity of outside air is added after approximately 30 minutes.

► **Deactivating:** Press button  again. The indicator lamp in the button goes out.

i The manually selected air recirculation mode is deactivated automatically:

- after 5 minutes if the outside temperature is below approximately 41°F (5°C)
- after 5 minutes if the air conditioning is turned off
- after 30 minutes if the outside temperature is above approximately 41°F (5°C)

Using driver-side settings for passenger side

This feature is only available in Canada vehicles.

You can use the settings of the driver's side, such as temperature, air volume and air distribution, for the passenger side.

► **Activating:** Adjust the air temperature, air volume and air distribution.

► Press button .

The indicator lamp in the button comes on.

The driver-side settings are used for the passenger side.

► **Deactivating:** Press button  again. The indicator lamp in the button goes out.

Rear window defroster

Warning!

Any accumulation of snow and ice should be removed from the rear window before driving. Visibility could otherwise be impaired, endangering you and others.

The rear window defroster uses a large amount of power. To keep the battery drain to a minimum, switch off the defroster as soon as the rear window is clear. The defroster is switched off automatically after some time of operation depending on the outside temperature.

► Switch on the ignition.

► **Switching on:** Press button  on the respective climate control panel. The indicator lamp in the button comes on.

► **Switching off:** Press button  again.

The rear window defroster switches off when the battery voltage is too low. Too many electrical consumers may be operating simultaneously. تلفن ۰۲۱-۸۸۶۲۰۱۸

► Switch off consumers that are currently not needed if required.

Power tilt/sliding sunroof

Opening and closing

 **Observe Safety notes, see page 54.**

Warning!

When opening or closing the tilt/sliding sunroof, make sure there is no danger of anyone being harmed by the opening/closing procedure.

The tilt/sliding sunroof is equipped with the express operation and automatic reversal function. If the movement of the tilt/sliding sunroof is blocked during the closing procedure, the tilt/sliding sunroof will stop and open slightly.

The tilt/sliding sunroof operates differently when the sunroof switch is pressed and held. See the “Closing when the tilt/sliding sunroof is blocked” section for details.

The opening/closing procedure of the tilt/sliding sunroof can be immediately halted by releasing the sunroof switch or, if the sunroof switch was moved past the resistance point and released, by moving the sunroof switch in any direction.

Warning!

The tilt/sliding sunroof is made out of glass. In the event of an accident, the glass may shatter. This may result in an opening in the roof.

In a vehicle rollover, occupants not wearing their seat belts or not wearing them properly may be thrown out of the opening. Such an opening also presents a potential for injury for occupants wearing their seat belts properly as entire body parts or portions of them may protrude from the passenger compartment.

- !** To avoid damaging the seals, do not transport any objects with sharp edges which can stick out of the tilt/sliding sunroof.

Do not open the tilt/sliding sunroof if there is snow or ice on the roof, as this could result in malfunctions.

If you cannot open or close the tilt/sliding sunroof due to a malfunction contact Roadside Assistance or an authorized Mercedes-Benz Center.

- !** Please keep in mind that weather conditions can sometimes change rapidly. Make sure to close the tilt/sliding sunroof when leaving the vehicle. If water enters the vehicle interior, vehicle electronics could be damaged which is not covered by the Mercedes-Benz Limited Warranty.

- i** You can also open or close the tilt/sliding sunroof using the SmartKey or the KEYLESS-GO function, see “Summer

opening feature” (▷ page 99) and “Convenience closing feature” (▷ page 100).

- i** After switching off the ignition or removing the SmartKey from the starter switch, you can operate the tilt/sliding sunroof until you open the driver’s or front passenger door. If no door was opened you can operate the tilt/sliding sunroof for up to 5 minutes.

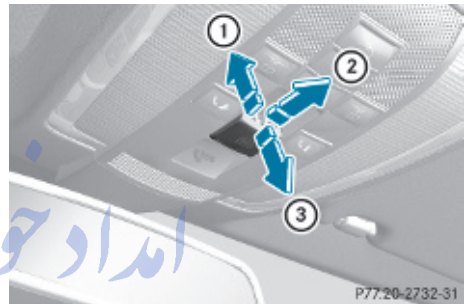

Sunroof switch

- ① Raising
- ② Opening
- ③ Closing



Sunroof screen

- Switch on the ignition.

Opening

- ▶ **Opening manually:** Press and hold the sunroof switch to the resistance point in direction of arrow ②.
- ▶ Release the sunroof switch when the desired position is reached.
- ▶ **Express operation:** To open the tilt/sliding sunroof completely, press the sunroof switch past the resistance point in direction of arrow ② and release.
- ▶ **Stopping during express operation:** Move the sunroof switch in any direction.

i Express opening is not available when the tilt/sliding sunroof is raised. The tilt/sliding sunroof must be closed first.

i When the tilt/sliding sunroof is open, resonance noises may result in addition to the usual wind noises. They are caused by minimal pressure changes in the passenger compartment. To reduce or eliminate these noises, change the position of the tilt/sliding sunroof or open a window slightly.

Raising

- ▶ **Raising manually:** Press and hold the sunroof switch to the resistance point in direction of arrow ①.
- ▶ Release the sunroof switch when the desired position is reached.
- ▶ **Express operation:** To raise the tilt/sliding sunroof completely, press the sunroof switch past the resistance point in direction of arrow ① and release.
- ▶ **Stopping during express operation:** Move the sunroof switch in any direction.

i Express raising is not available when the tilt/sliding sunroof is open. The tilt/sliding sunroof must be closed first.

Closing

- ▶ **Closing manually:** Pull and hold the sunroof switch to the resistance point in direction of arrow ③.
- ▶ Release the sunroof switch when the desired position is reached.
- ▶ **Express operation:** To close the tilt/sliding sunroof completely, pull the sunroof switch past the resistance point in direction of arrow ③ and release.
- ▶ **Stopping during express operation:** Move the sunroof switch in any direction.

Closing when the tilt/sliding sunroof is blocked

Warning!

Make sure that nobody can become trapped and be seriously or even fatally injured when closing the tilt/sliding sunroof with greater force or without automatic reversal function.

If the movement of the tilt/sliding sunroof is blocked during the closing procedure (e.g. by ice or pollution), the tilt/sliding sunroof will stop and open slightly.

- ▶ Immediately after the tilt/sliding sunroof has stopped and opened because it was blocked, pull and hold the sunroof switch in direction of arrow ③ until the tilt/sliding sunroof is fully closed. The tilt/sliding sunroof closes with greater force.

If the tilt/sliding sunroof is blocked again and opens slightly:

- ▶ Immediately after the tilt/sliding sunroof was blocked and has opened, pull and hold the sunroof switch in direction of arrow ③ until the tilt/sliding sunroof is fully closed. The tilt/sliding sunroof closes without automatic reversal function.

Warning!

Pulling and holding the sunroof switch to close the tilt/sliding sunroof immediately

after it had been blocked two times will cause the tilt/sliding sunroof to close without any reversal function for as long as you hold the sunroof switch.

Synchronizing

The tilt/sliding sunroof must be synchronized after a malfunction or if it does not open smoothly.

! If the tilt/sliding sunroof cannot be closed or synchronized, contact an authorized Mercedes-Benz Center or call Roadside Assistance.

- ▶ Switch on the ignition.
- ▶ Press and hold the sunroof switch in direction of arrow ① (▷ page 197) until the tilt/sliding sunroof is fully raised at the rear.
- ▶ Keep holding the sunroof switch in direction of arrow ① for approximately 1 second.
- ▶ Check the express operation feature (▷ page 198).
If the tilt/sliding sunroof opens and closes completely, the roof is synchronized. Otherwise repeat the above steps.

Panorama roof with power tilt/sliding panel

Extending and retracting the roller sunblinds

The roller sunblinds only operate with the tilt/sliding panel closed. The front and rear roller sunblind cannot be operated individually.

Warning!

When extending the roller sunblinds, make sure no one is in danger of being injured by the extending procedure.

The roller sunblinds are equipped with the express operation and automatic reversal

function. If the movement of the roller sunblinds is blocked during the extending procedure, the roller sunblinds will stop and retract slightly.

The extending of the roller sunblinds can be immediately halted by releasing the roof panel switch or, if the roof panel switch was moved past the resistance point and released, by moving the roof panel switch in any direction.

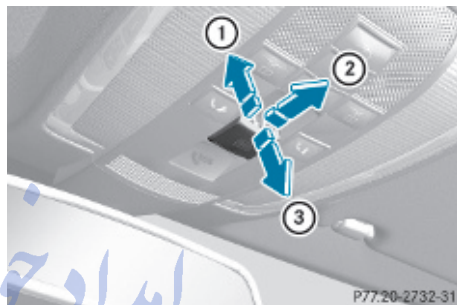

Roof panel switch

- ① Retracting
- ② Retracting
- ③ Extending

- ▶ Switch on the ignition.
- ▶ **Retracting/Extending:** Move the roof panel switch to the resistance point in the required direction of arrow ①, ② or ③ until the roller sunblinds have reached their desired position.
- ▶ **Express operation:** Move the roof panel switch past the resistance point in direction of arrow ①, ② or ③ and release. The roller sunblinds retract/extend completely.
- ▶ **Stopping during express operation:** Move the roof panel switch in any direction.

Opening and closing the panorama roof with power tilt/sliding panel

⚠ Observe Safety notes, see page 54.

⚠ Warning!

When opening or closing the tilt/sliding panel, make sure there is no danger of anyone being harmed by the opening/closing procedure.

The tilt/sliding panel is equipped with the express operation and automatic reversal function. If the movement of the tilt/sliding panel is blocked during the closing procedure, the tilt/sliding panel will stop and open slightly.

The tilt/sliding panel operates differently when the roof panel switch is pressed and held. See the “Closing when the tilt/sliding panel is blocked” section in this chapter for details.

The opening/closing procedure of the tilt/sliding panel can be immediately halted by releasing the roof panel switch or, if the roof panel switch was moved past the resistance point and released, by moving the roof panel switch in any direction.

⚠ Warning!

The panorama roof with tilt/sliding panel is made out of glass. In the event of an accident, the glass may shatter. This may result in an opening in the roof.

In a vehicle rollover, occupants not wearing their seat belts or not wearing them properly may be thrown out of the opening. Such an opening also presents a potential for injury for occupants wearing their seat belts properly as entire body parts or portions of them may protrude from the passenger compartment.

! To avoid damaging the seals, do not transport any objects with sharp edges which can stick out of the tilt/sliding panel. Do not open the tilt/sliding panel if there is snow or ice on the roof, as this could result in malfunctions.

! Please keep in mind that weather conditions can sometimes change rapidly. Make sure to close the tilt/sliding panel when leaving the vehicle. If water enters the vehicle interior, vehicle electronics could be damaged which is not covered by the Mercedes-Benz Limited Warranty.

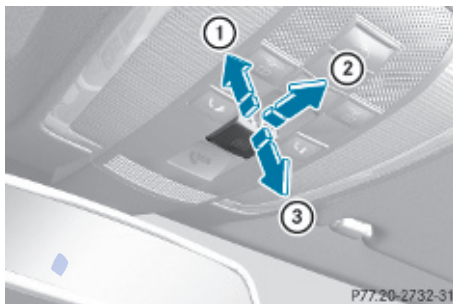

Roof panel switch

- ① Raising
- ② Opening
- ③ Closing

The tilt/sliding panel only operates with the roller sunblinds retracted.

i You can also open or close the tilt/sliding panel using the SmartKey, see “Summer opening feature” (▷ page 99) or see “Convenience closing feature” (▷ page 100).

► Switch on the ignition.

Opening

- **Opening manually:** Press and hold the roof panel switch to the resistance point in direction of arrow ②.
- Release the roof panel switch when the desired position is reached.
- **Express operation:** To open the tilt/sliding panel completely, press the roof panel switch past the resistance point in direction of arrow ② and release.
- **Stopping during express operation:** Move the roof panel switch in any direction.

- i** When the tilt/sliding panel is open, resonance noises may result in addition to the usual wind noises. They are caused by minimal pressure changes in the passenger compartment. To reduce or eliminate these noises, change the position of the tilt/sliding panel or open a window slightly.

Raising

- ▶ **Raising manually:** Press and hold the roof panel switch to the resistance point in direction of arrow ①.
- ▶ Release the roof panel switch when the desired position is reached.
- ▶ **Express operation:** To raise the tilt/sliding panel completely, press the roof panel switch past the resistance point in direction of arrow ① and release.
- ▶ **Stopping during express operation:** Move the roof panel switch in any direction.

- i** Express raising is not available when the tilt/sliding panel is open. The tilt/sliding panel must be closed first.

Closing

- ▶ **Closing manually:** Pull and hold the roof panel switch to the resistance point in direction of arrow ③.
- ▶ Release the roof panel switch when the desired position is reached.
- ▶ **Express operation:** To close the tilt/sliding panel completely, pull the roof panel switch past the resistance point in direction of arrow ③ and release.
- ▶ **Stopping during express operation:** Move the roof panel switch in any direction.

Closing when the tilt/sliding panel is blocked

Warning!

Make sure that nobody can become trapped and be seriously or even fatally injured when

closing the tilt/sliding panel without automatic reversal function.

If the movement of the tilt/sliding panel is blocked during the closing procedure (e.g. by ice or pollution), the tilt/sliding panel will stop and open slightly.

- ▶ Immediately after the tilt/sliding panel has stopped and opened because it was blocked, pull and hold the roof panel switch in direction of arrow ③ until the tilt/sliding panel is fully closed.

If the tilt/sliding panel is blocked again and opens slightly:

- ▶ Immediately after the tilt/sliding panel was blocked and has opened, pull and hold the roof panel switch in direction of arrow ③ until the tilt/sliding panel is fully closed. The tilt sliding panel closes without automatic reversal function.

Warning!

Pulling and holding the roof panel switch to close the tilt/sliding panel immediately after it had been blocked two times will cause the tilt/sliding panel to close without any reversal function for as long as you hold the roof panel switch.

Synchronizing

The tilt/sliding panel and front roller sunblinds must be synchronized after a malfunction or if the tilt/sliding panel does not open smoothly.

- !** Do not attempt to open the tilt/sliding panel before the tilt/sliding panel is properly synchronized. The tilt/sliding panel could otherwise lock-up in the open position.

If the tilt/sliding panel cannot be closed or synchronized, contact an authorized Mercedes-Benz Center or call Roadside Assistance.

- ▶ Switch on the ignition.
- ▶ Push and hold the roof panel switch in direction of arrow ② (▷ page 199) until the roller sunblinds are fully retracted.
- ▶ Push and hold the roof panel switch in direction of arrow ② until the tilt/sliding panel is opened approximately 4 inch (10 cm).
- ▶ Pull and hold the roof panel switch in direction of arrow ③ until the tilt/sliding panel is fully closed.
- ▶ Keep holding the roof panel switch in direction of arrow ③ for approximately 1 second.
- ▶ Pull and hold the roof panel switch in direction of arrow ③ (▷ page 199) until the roller sunblinds are fully extended.
- ▶ Keep holding the roof panel switch in direction of arrow ③ for approximately 1 second.
- ▶ Check the express operation feature of the tilt/sliding panel (▷ page 200). If the tilt/sliding panel opens completely, the roof is synchronized. Otherwise repeat the above steps.

Loading and storing

Loading instructions

Warning!

Always fasten items being carried as securely as possible using fastening materials appropriate for the weight and size of the load.

In an accident, during hard braking or sudden maneuvers, loose items will be thrown around inside the vehicle. This can cause injury to vehicle occupants unless the items are securely fastened in the vehicle.

To help avoid personal injury during a collision or sudden maneuver, exercise care when transporting cargo. Do not pile luggage or cargo higher than the seat backrests.

The trunk is the preferred place to carry objects. Do not place anything on the rear-window shelf.

Never drive a vehicle with the trunk open. Deadly carbon monoxide (CO) gases may enter vehicle interior resulting in unconsciousness and death.

Load distribution

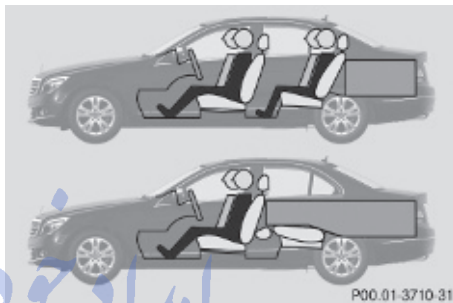

The total load weight including vehicle occupants and luggage/cargo should not exceed the total load limit indicated on the corresponding Tire and Loading Information placard located on the driver's door B-pillar (▷ page 238).

The handling characteristics of a fully loaded vehicle depend greatly on the load distribution. It is therefore recommended to load the vehicle according to the illustration shown. The heaviest items are to be placed towards the front of the vehicle.

- i** The enlarged cargo area should only be used for items which do not fit in the trunk alone.

Please pay attention to and comply with the following instructions when loading the vehicle and transporting cargo:

- Always place items being carried against front or rear seat backrests, and fasten them as securely as possible.
- The heaviest portion of the cargo should always be kept as low as possible against front or rear seat backrests.

Roof rack

For information about further roof rack equipment, contact an authorized Mercedes-Benz Center.

Warning!

Only use roof racks approved by Mercedes-Benz for your vehicle model to avoid damage to the vehicle.

Follow the manufacturer's installation instructions. Otherwise, an improperly attached roof rack system or its load could become detached from the vehicle.

Do not exceed the maximum roof load of 220 lb (100 kg).

Take into consideration that when the roof rack is loaded, the handling characteristics are different from those when operating the vehicle without the roof rack loaded.

Make sure

- you can raise the power tilt/sliding sunroof or the panorama roof with tilt/sliding panel completely
- you can open the trunk completely

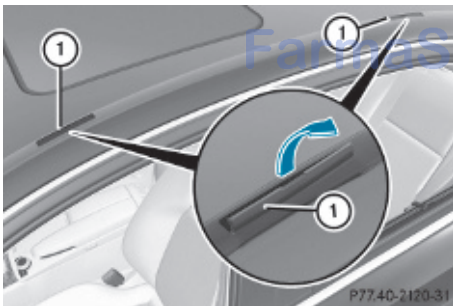

- ▶ Flip trim covers ① open.
- ▶ Only attach the roof rack to the anchorage points under trim covers ①.
- ▶ Observe manufacturer's instructions for installation.

Parcel nets

Warning!

Parcel nets are intended for storing light-weight items only, such as road maps, mail, etc.

Heavy objects, objects with sharp edges, or fragile objects may not be transported in the parcel nets. In an accident, during hard braking, or sudden maneuvers, they could be thrown around inside the vehicle and cause injury to vehicle occupants.

Parcel nets cannot protect transported goods in the event of an accident.

Parcel nets are located in the front passenger footwell and on the left trunk side wall.

Cargo tie-down rings

Vehicles with split rear seat bench are equipped with four cargo tie-down rings.

Always follow loading instructions (▷ page 202).



Hooks

Two retaining hooks can be used to attach cargo items such as bags.

 Do not use the retaining hooks to tie down cargo.

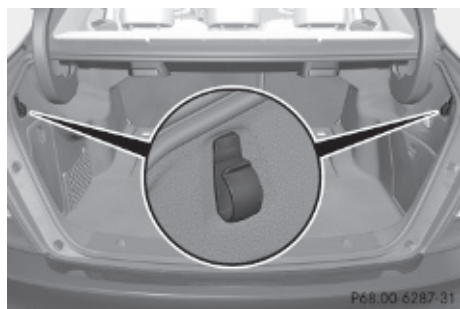

Use retaining hooks to secure light-weight items only. The maximum permissible weight per retaining hook is 6,6 lbs (3 kg).

Split rear seat bench

To expand the cargo volume, you can fold down the left and right rear seat backrests. The two sections can be folded down separately.

Warning!

When expanding the cargo volume, always fold the seat cushions fully forward.

Unless you are transporting cargo, the seat backrests must remain properly locked in the upright position.

In an accident, during hard braking or sudden maneuvers, loose items will be thrown around inside the vehicle. This can cause injury to vehicle occupants unless the items are securely fastened in the vehicle.

Folding seat backrest forward

- ▶ Open the trunk.

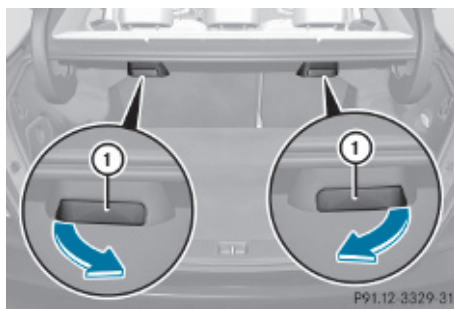

- ▶ Pull on left and/or right release handle ①.
- ▶ Fully retract the head restraints (▷ page 83).
- ▶ If necessary, pull the driver's and/or front passenger seat forward (▷ page 80).

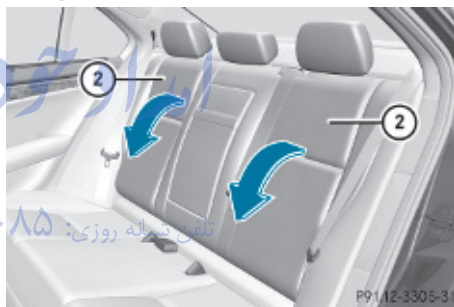

- ▶ Fold seat backrests ② forward.
- ▶ Adjust front seats to desired position (▷ page 80).

Setting up seat backrest

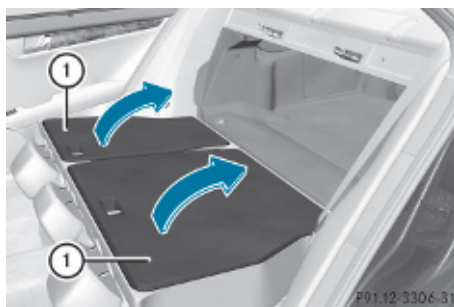

- ▶ Fold seat backrest ① rearward until it engages.

- ❗ Make sure that the seat belt is not pinched.
- ▶ Check for secure locking by pushing and pulling on the seat backrest.
- ▶ Adjust head restraints, if necessary (▷ page 83).
- ▶ Adjust front seats to desired position (▷ page 80).

⚠ Warning!

Always lock the seat backrest in its upright position when the rear seat bench is occupied, or the extended cargo volume is not in use.

Check for secure locking by pushing and pulling on the seat backrest.

In an accident, during hard braking or sudden maneuvers, loose items will be thrown around inside the vehicle. This can cause injury to vehicle occupants unless the items are securely fastened in the vehicle.

To help avoid personal injury during a collision or sudden maneuver, exercise care when transporting cargo.

- ⓘ To prevent unauthorized persons from access to the trunk, always lock the seat backrests in its upright position.

Front storage compartments

⚠ Warning!

To help avoid personal injury during a collision or sudden maneuver, exercise care when storing objects in the vehicle. Put luggage or cargo in the trunk if possible.

Do not pile luggage or cargo higher than the seat backrests.

Keep compartment lids closed. This will help to prevent stored objects from being thrown about and injuring vehicle occupants during

- braking
- vehicle maneuvers
- an accident

Glove box

Depending on vehicle equipment, an AUX socket or a media interface is located in the glove box. For information on Audio AUX mode, see (▷ page 166) or on media interface, see separate COMAND system operating instructions.

The glove box can be ventilated (▷ page 193).



- ▶ **Opening:** Pull glove box lid release ①.
- ▶ **Closing:** Push glove box lid ② upwards until it engages.

You can lock the glove box, e.g. when the vehicle is in the shop for service.

The glove box can only be locked or unlocked with the mechanical key.

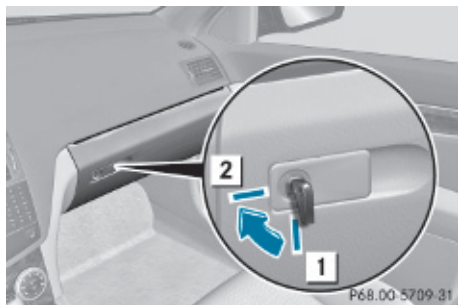

- ① Glove box unlocked
- ② Glove box locked

Front armrest storage compartments

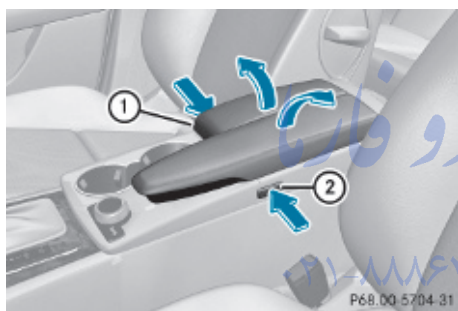

i There is a small and a large storage compartment located underneath the armrest. The small storage compartment can be removed for the purpose of emptying.

- ▶ **Opening storage compartments:** Press button ① or ②. The armrest opens to the left and the right side automatically.
- ▶ **Closing storage compartments:** Swing the left and/or right armrest backward until it engages.

Rear storage compartments

⚠ Warning!

To help avoid personal injury during a collision or sudden maneuver, exercise care when storing objects in the vehicle. Put luggage or cargo in the trunk if possible.

Do not pile luggage or cargo higher than the seat backrests.

Keep compartment lids closed. This will help to prevent stored objects from being thrown about and injuring vehicle occupants during

- braking
- vehicle maneuvers
- an accident

Rear armrest storage compartment

- !** Do not sit on or lean your body weight against the armrest when it is folded down, as you could otherwise damage it.
- !** Before storing the armrest in the seat backrest, close the storage compartment cover.

- ▶ Fold the rear armrest down.



- ▶ **Opening:** Pull release catch ① and swing the storage compartment cover upward in direction of arrow.

Storage bags

Warning!

Storage bags are intended for storing light-weight items only.

Heavy objects, objects with sharp edges or fragile objects may not be transported in the storage bag. In an accident, during hard braking, or sudden maneuvers, they could be thrown around inside the vehicle and cause injury to vehicle occupants.

Storage bags cannot protect transported goods in the event of an accident.

Storage bags are located on the back of the front seats.

Useful features

Cup holders

Warning!

In order to help prevent spilling liquids on vehicle occupants and/or vehicle equipment, only use containers that fit into the cup holder. Use lids on open containers and do not fill containers to a height where the contents, especially hot liquids, could spill during braking, vehicle maneuvers, or in an accident. Liquids spilled on vehicle occupants may cause serious personal injury. Liquids spilled on vehicle equipment may cause damage not covered by the Mercedes-Benz Limited Warranty.

When not in use, keep the cup holder closed. An open cup holder may cause injury to you or others when contacted during braking, vehicle maneuvers, or in an accident.

Keep in mind that objects placed in the cup holder may come loose during braking, vehicle maneuvers, or in an accident and be thrown around in the vehicle interior. Objects thrown around in the vehicle interior may cause an accident and/or serious personal injury.

Cup holder in front center console

A cup holder ① is located in the front center console.

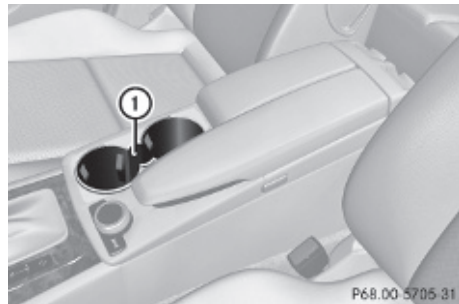

Cup holder in rear armrest

► **Opening:** Open rear armrest storage compartment (> page 206).

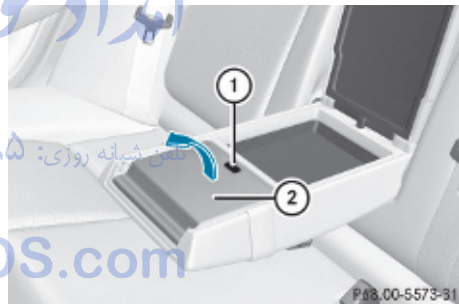

- Press release button ①. Cup holder ② swings out and opens automatically.
- Close rear armrest storage compartment.
- **Closing:** Open rear armrest storage compartment (> page 206).
- Swing cup holder ② backward until it engages.
- Close rear armrest storage compartment.

❗ Do not sit on or lean your body weight against the armrest when it is folded down, as you could otherwise damage it.

- !** Close the cup holder before folding the armrest upwards. Otherwise you could damage the cup holder.

Sun visors

Warning!

Do not use the vanity mirror while driving. Keep the vanity mirrors in the sun visors closed while vehicle is in motion. Reflected glare can endanger you and others.

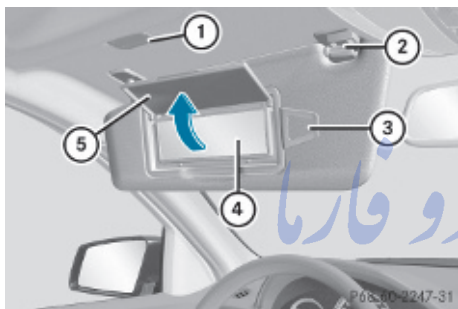

- ① Vanity mirror lamp
- ② Mounting
- ③ Holder, e.g. for gas cards
- ④ Vanity mirror
- ⑤ Vanity mirror cover

Glare through the windshield

- ▶ Flip sun visor down when you experience glare.

Glare through a door window

- ▶ Close vanity mirror cover ⑤ if opened.
- ▶ Disengage sun visor from mounting ②.
- ▶ Pivot sun visor to the side.

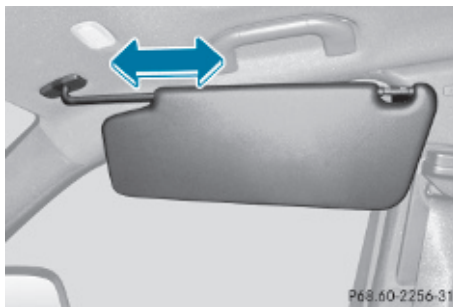

- ▶ Adjust sun visor by pushing or pulling.

Vanity mirror

The vanity mirror lamp only functions when the sun visor is engaged in mounting ②.

- ▶ Lift up vanity mirror cover ⑤. Vanity mirror lamp ① comes on.

Rear window sunshade

Warning!

When operating the rear window sunshade make sure there is no danger of anyone being harmed by the extending or retracting procedure.

The extending or retracting procedure can be immediately halted by briefly pressing rear window sunshade switch. To reverse direction of movement, press rear window sunshade switch again.

Observe Safety notes, see page 54.

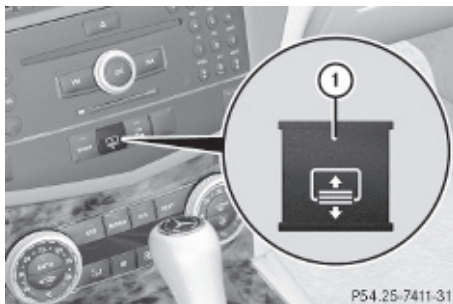

P54.25-7411-31

- ▶ Switch on the ignition.
- ▶ **Extending/Retracting:** Press rear window sunshade switch ① briefly.

Ashtrays

Center console ashtray

i A storage compartment is located under the ashtray insert.

! The storage compartment is not heat-proof. When smoking always make sure the ashtray insert is present and properly inserted.

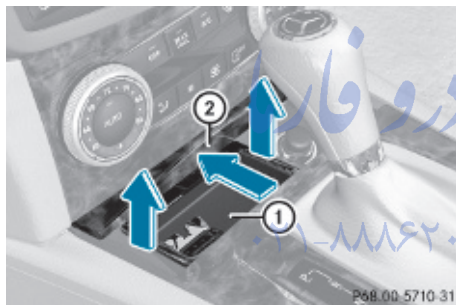

- ▶ **Opening:** Press cover ② forward until it engages.
- ▶ **Removing ashtray insert:** Grab ashtray insert ① on the grooved side and pull it up and out in the direction indicated by arrows.
- ▶ **Reinstalling ashtray insert:** Push ashtray insert ① back into the frame until it engages.
- ▶ **Closing:** Tap the front of cover ②.

Rear center console ashtray



- ▶ **Opening:** Pull at top of cover ②.
- ▶ **Removing ashtray insert:** Push button ③ to disengage ashtray insert ① and remove it.
- ▶ **Reinstalling ashtray insert:** Push ashtray insert ① down into the retainer until it engages.
- ▶ **Closing:** Push at top of cover ②.

Cigarette lighter

⚠ Observe Safety notes, see page 54.

⚠ Warning!

Never touch the heating element or sides of the lighter; they are extremely hot. Hold the knob only.

Make sure any children traveling with you do not injure themselves or start a fire with the hot cigarette lighter.

If the engine is off and the cigarette lighter is being used extensively, the vehicle battery may become discharged.

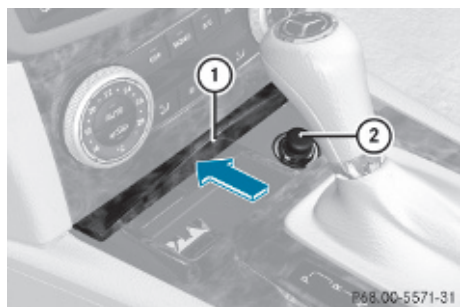

- ▶ Switch on the ignition.
- ▶ Open cover ① (▷ page 209).
- ▶ Push in cigarette lighter ②. Cigarette lighter ② will pop out automatically when hot.
- ▶ Take out cigarette lighter ②.
- ▶ Reinsert cigarette lighter ② in its socket after use.

Power outlets

The power outlets can be used to accommodate 12V DC electrical accessories (e.g. auxiliary lamps, mobile phone chargers) up to a maximum of 15 A (180 W).

If the engine is off and the power outlets are being used extensively, the vehicle battery may become discharged.

- ▶ Switch on the ignition.

Power outlet in glove box

- ▶ Open glove box (▷ page 205).



Power outlet in rear passenger compartment



- ▶ Pull at top of cover ①.

Compass



- ① In order to receive an accurate reading in the interior rear view mirror ①, the compass must be calibrated and the magnetic field zone set.

- ▶ **Calling up the compass:** Press button ③ briefly.

The compass displays the direction into which the vehicle is currently traveling: N, NE, E, SE, S, SW, W, or NW.

- ▶ **Compass adjustment:** Determine your location on the basis of the following zone maps.

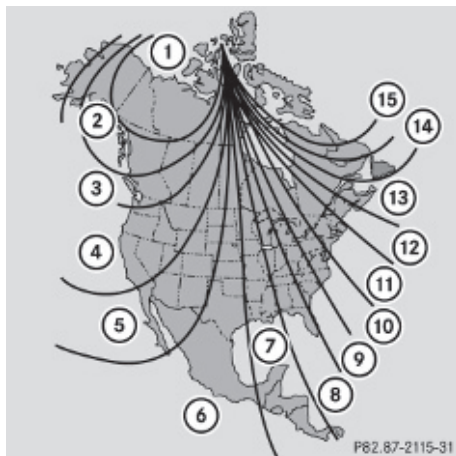

Zone map North America

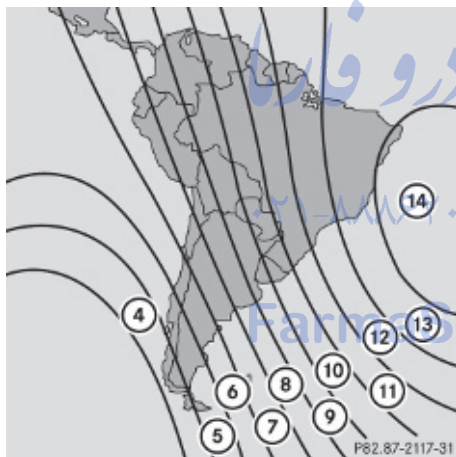

Zone map South America

- ▶ Press button ③ approximately 3 seconds. The currently selected zone appears in compass display ②.
- ▶ **Selecting zone:** Press button ③ until the desired zone is selected. Do not press the button again until the direction is indicated.
- ▶ **Compass calibration:** Make sure you are in an area where you can drive a full circle with your vehicle without disturbing traffic in order to calibrate the compass.

In order to calibrate the compass properly, mind the following:

- Calibrate the compass in open terrain. Nearby buildings, bridges, power lines and large antenna masts, for example, could impair compass calibration.
- Switch off electrical consumers (e.g. climate control, windshield wipers, or rear window defroster).
- Close all doors and the trunk.
- ▶ Start the engine.
- ▶ Press button ③ approximately 6 seconds until symbol C appears in compass display ②.
- ▶ Drive a full circle at a vehicle speed of between 3 mph (5 km/h) and 6 mph (10 km/h). When calibration was successful, the current direction appears in compass display ②.

Tele Aid تلفن شماره ۸۸۸-۱۸۸

❗ In order to activate the Tele Aid system, a subscriber agreement must be completed. To ensure your system is activated and operational, please press Information button  to perform the acquaintance call. Failure to complete either of these steps may result in a system that is not activated.

If you have any questions regarding activation, please call the Customer Assistance Center at 1-800-FOR-MERCEdes (1-800-367-6372) (USA only) or 1-888-923-8367 (Canada only).

Shortly after the completion of your Tele Aid acquaintance call, you will receive a user ID and password in the mail. You may use this password to access the Tele Aid section in "Owner's Online" at www.mbusa.com (USA only). The "My Tele Aid" section will give you

access to account information, remote door unlock and more.

The Tele Aid system is available if

- it has been activated and is operational. Activation requires a subscription for monitoring services, connection and cellular air time
 - vehicle battery power is available
 - the relevant cellular phone network and GPS signals are available and pass the information on to the Customer Assistance Center
- i** Location of the vehicle on a map is only possible if the vehicle is able to receive signals from the GPS satellite network and pass the information on to the Customer Assistance Center.

The Tele Aid system

(Telematic Alarm Identification on Demand)

The Tele Aid system consists of three types of response:

- Automatic and manual emergency
- Roadside Assistance
- Information

To adjust the speaker volume during a Tele Aid call do the following:

- ▶ Press button  or  on the multifunction steering wheel.

or

- ▶ Use the rotary control on the audio system (> page 144).





Be sure to check “Owner’s Online” at **www.mbusa.com** (USA only) for more information and a description of all available features.

System self-test

The system performs a self-test after you have switched on the ignition.

Warning!

A malfunction in the system has been detected if any or all of the following conditions occur:

- The indicator lamp in the SOS button does not come on during the system self-test.
- The indicator lamp in the Roadside Assistance button  does not come on during the system self-test.
- The indicator lamp in the Information button  does not come on during the system self-test.
- The indicator lamp in the SOS button, Roadside Assistance button , or Information button  remains illuminated constantly in red after the system self-test.
- The message Tele Aid Inoperative or Tele Aid Not Activated appears in the multifunction display after the system self-test

If a malfunction is indicated as outlined above, the system may not operate as expected. In case of an emergency, help will have to be summoned by other means.

Have the system checked at the nearest Mercedes-Benz Center or contact the Customer Assistance Center at 1-800-FOR-MERCEdes (1-800-367-6372) (USA only) or 1-888-923-8367 (Canada only) as soon as possible.

Emergency calls

- i** In order to activate the Tele Aid system, a subscriber agreement must be completed. To ensure your system is activated and operational, please press Information button  to perform the acquaintance call. Failure to complete either of these steps may result in a system that is not activated.

If you have any questions regarding activation, please call the Customer Assistance Center at

1-800-FOR-MERcedes (1-800-367-6372) (USA only) or 1-888-923-8367 (Canada only).

An emergency call is initiated automatically following an accident in which the Emergency Tensioning Devices (ETDs) or air bags have deployed.

- ❗ An automatically initiated Tele Aid emergency call cannot be canceled.

An emergency call can also be initiated manually (▷ page 213).

Once the emergency call is in progress, the indicator lamp in the SOS button will begin to flash. The message **Connecting Call** appears in the multifunction display and the COMAND system is muted. When the connection is established, the message **Call Connected** appears in the multifunction display.

All information relevant to the emergency, such as the location of the vehicle (determined by the GPS satellite location system), vehicle model, identification number and color are generated.

A voice connection between the Customer Assistance Center and the occupants of the vehicle will be established automatically soon after the emergency call has been initiated. The Customer Assistance Center will attempt to determine the nature of the emergency more precisely, provided they can speak to an occupant of the vehicle.

- ❗ If no vehicle occupant responds, an ambulance will be sent to the vehicle immediately.

⚠ Warning!

If the indicator lamp in the SOS button is flashing continuously and there was no voice connection to the Customer Assistance Center established, then the Tele Aid system could not initiate an emergency call (e.g. the relevant cellular phone network is not available).

The message **Call Failed** appears in the multifunction display for approximately 10 seconds.

Should this occur, assistance must be summoned by other means.

- ❗ The “911” emergency call system is a public service. Using it without due cause is a criminal offense.

Initiating an emergency call manually

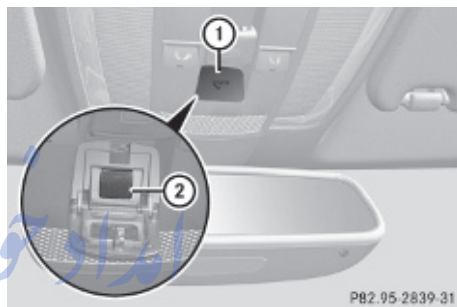

- ▶ Briefly press on cover ① to open.
- ▶ Press SOS button ② briefly. The indicator lamp in SOS button ② will flash until the emergency call is concluded.
- ▶ Wait for a voice connection to the Customer Assistance Center.
- ▶ Close cover ① after the emergency call is concluded.

⚠ Warning!

If you feel at any way in jeopardy when in the vehicle (e.g. smoke or fire in the vehicle, vehicle in a dangerous road location), please do not wait for voice contact after you have pressed the emergency button. Carefully leave the vehicle and move to a safe location. The Customer Assistance Center will automatically contact local emergency officials with the vehicle's approximate location if they receive an automatic SOS signal and cannot make voice contact with the vehicle occupants.

- ▶ **Terminating calls:** Press button  on the multifunction steering wheel.
- or
- ▶ Press the respective button for ending a telephone call on the audio system or the COMAND system.

Roadside Assistance button



- ▶ Press and hold Roadside Assistance button ① for longer than 2 seconds. A call to a Mercedes-Benz Roadside Assistance dispatcher will be initiated. The indicator lamp in Roadside Assistance button ① will flash while the call is in progress. The message **Connecting Call** will appear in the multifunction display and the audio system or the COMAND system is muted.

When the connection is established, the message **Call Connected** appears in the multifunction display. The Tele Aid system will transmit data generating the vehicle identification number, model, color and location (subject to availability of cellular and GPS signals).

- ① The audio system or COMAND system display indicates that a Tele Aid call is in progress. While the call is connected you can change to the navigation menu by pressing the NAVI button on the COMAND system. Spoken commands are not available.

A voice connection between the Roadside Assistance dispatcher and the occupants of the vehicle will be established.

- ▶ Describe the nature of the need for assistance.

The Mercedes-Benz Roadside Assistance dispatcher will either dispatch a qualified Mercedes-Benz technician or arrange to tow your vehicle to the nearest authorized Mercedes-Benz Center. For services such as labor and/or towing, charges may apply. Refer to the Roadside Assistance manual for more information.

Sign and Drive services (USA only):

Services such as a jump start, a few gallons of fuel or the replacement of a flat tire with the vehicle spare wheel are obtainable at no charge.

- ① If the indicator lamp in Roadside Assistance button ① is flashing continuously and there was no voice connection to the Customer Assistance Center established, then the Tele Aid system could not initiate a Roadside Assistance call (e.g. the relevant cellular phone network is not available). The message **Call Failed** appears in the multifunction display.

- ▶ **Terminating calls:** Press button  on the multifunction steering wheel.

or

- ▶ Press the respective button for ending a telephone call on the audio system or the COMAND system.

Information button



- ▶ Press and hold Information button ① for longer than 2 seconds.

A call to the Customer Assistance Center will be initiated. The indicator lamp in Information button ① will flash while the call is in progress. The message Connecting Call will appear in the multifunction display and the COMAND system is muted.

- ① The audio system or COMAND system display indicates that a Tele Aid call is in progress. While the call is connected you can change to the navigation menu by pressing the NAVI button on the COMAND system. Spoken commands are not available.

A voice connection between the Customer Assistance Center representative and the occupants of the vehicle will be established. Information regarding the operation of your vehicle, the nearest authorized Mercedes-Benz Center or Mercedes-Benz USA products and services is available to you.

For more details concerning the Tele Aid system, please visit www.mbusa.com (USA only), log in to "Owner's Online" and visit the "My Tele Aid" section to learn more.

- ① If the indicator lamp in Information button ① is flashing continuously and there was no voice connection to the Customer Assistance Center established, then the Tele Aid system could not initiate an Information call (e.g. the relevant

cellular phone network is not available). The message Call Failed appears in the multifunction display.

- ▶ **Terminating calls:** Press button  on the multifunction steering wheel.

or

- ▶ Press the respective button for ending a telephone call on the audio system or the COMAND system.

Call priority

If other service calls such as a Roadside Assistance call or Information call are active, an emergency call is still possible. In this case, the emergency call will take priority and override all other active calls.

The indicator lamp in the respective button flashes until the call is concluded. Automatic initiated emergency calls can only be terminated by a Customer Assistance Center representative. All other calls can be terminated by pressing button  on the multifunction steering wheel or the respective button for ending a telephone call on the audio system or the COMAND system.

- ① When a Tele Aid call has been initiated, the audio system or the COMAND system is muted. The mobile phone is no longer connected to the COMAND system. If you must use this phone, we recommend that you use it only with the vehicle at a standstill in a safe location.

Search & Send

"Search & Send" is a navigation destination address entry service. For more information on "Search & Send", refer to separate COMAND system operating instructions.

Remote door unlock

In case you have locked your vehicle unintentionally (e.g. SmartKey inside vehicle), and the reserve SmartKey is not available:

- ▶ Contact the Customer Assistance Center at 1-800-FOR-MERcedes (1-800-367-6372) (USA only) or 1-888-923-8367 (Canada only). You will be asked to provide your password.
- ▶ Then return to your vehicle at the time arranged with the Customer Assistance Center and pull the trunk lid handle for a minimum of 20 seconds until the indicator lamp in the SOS button is flashing. The message **Connecting Call** appears in the multifunction display.

As an alternative, you may unlock the vehicle via Internet in the “My Tele Aid” section of “Owner’s Online”, using your ID and password (USA only).

- i** The remote door unlock feature is available if the relevant cellular phone network is available. The SOS button will flash and the message **Connecting Call** will appear in the multifunction display to indicate receipt of the door unlock command. If the trunk lid handle was pulled for more than 20 seconds before door unlock authorization was received, you must wait 15 minutes before pulling the trunk lid handle again.

Remote door lock

If you have forgotten to lock your vehicle and are no longer near it, you can have it locked remotely through the Customer Assistance Center.

The vehicle can be remotely locked within four days after the ignition has been switched off.

- ▶ Contact the Customer Assistance Center at 1-800-FOR-MERcedes (1-800-367-6372) (USA only) or 1-888-923-8367 (Canada only). You will be asked to provide your password.

When you are inside your vehicle the next time and switch on the ignition, the message **Tele Aid Doors locked by remote**

control will appear on the multifunction display.

- i** The remote door lock feature is available if the relevant cellular phone network is available and data connection is possible.

Stolen Vehicle Recovery Services

In the event your vehicle was stolen:

- ▶ Report the incident to the police. The police will issue a numbered incident report.
- ▶ Pass this number on to the Customer Assistance Center along with your password. The Customer Assistance Center will then attempt to covertly contact the vehicle’s Tele Aid system. Once the vehicle is located, the Customer Assistance Center will contact the local law enforcement and you. The vehicle’s location will only be provided to law enforcement.
- i** If the anti-theft alarm stays on for more than 30 seconds, the Tele Aid system will notify the Customer Assistance Center automatically.

Garage door opener

The integrated remote control can operate up to three separately controlled devices compatible with HomeLink® or some other systems.

⚠ Warning!

Before programming the integrated remote control to a garage door opener or gate operator, make sure people and objects are out of the way of the device to prevent potential harm or damage. When programming a garage door opener, the door moves up or down. When programming a gate operator, the gate opens or closes.

Do not use the integrated remote control with any garage door opener that lacks safety stop

and reverse features as required by U.S. federal safety standards (this includes any garage door opener model manufactured before April 1, 1982). A garage door that cannot detect an object - signaling the door to stop and reverse - does not meet current U.S. federal safety standards.

When programming a garage door opener, park vehicle outside the garage.

Do not run the engine while programming the integrated remote control. Inhalation of exhaust gas is hazardous to your health. All exhaust gas contains carbon monoxide (CO), and inhaling it can cause unconsciousness and possible death.

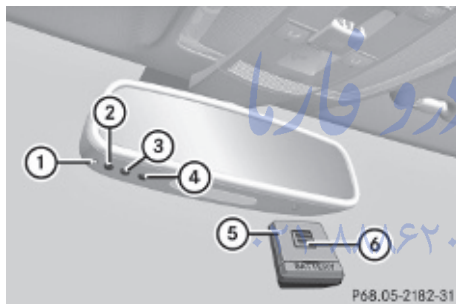

Interior rear view mirror with integrated remote control

Hand-held remote control ⑤ is not part of the vehicle equipment.

Programming the integrated remote control

- ▶ **Step 1:** Switch on the ignition.
 - ▶ **Step 2:** If you have previously programmed a signal transmitter button and wish to retain its programming, proceed to step 3.
- or
- ▶ If you are programming the integrated remote control for the first time, press and hold the two outer signal transmitter buttons ② and ④ and release them when indicator lamp ① begins to flash after approximately 20 seconds.

Do not hold the buttons for longer than 30 seconds.

This procedure erases any previous settings for all three channels and initializes the memory. If you later wish to program a second and/or third hand-held transmitter to the remaining two signal transmitter buttons, do not repeat this step and begin directly with step 3.

- ▶ **Step 3:** Hold the end of hand-held remote control ⑤ of the device you wish to train approximately 2 to 12 in (5 to 30 cm) away from the signal transmitter button (②, ③ or ④) to be programmed, while keeping indicator lamp ① in view.
- ▶ **Step 4:** Using both hands, simultaneously press hand-held remote control button ⑥ and the desired signal transmitter button (②, ③ or ④). Do not release the buttons until step 5 is completed. Indicator lamp ① will flash, first slowly and then rapidly.

- ▶ **Step 5:** Indicator lamp ① flashes immediately the first time the signal transmitter button is programmed. If this button has already been programmed, the indicator lamp will start flashing after 20 seconds.
- ▶ **Step 6:** After indicator lamp ① changes from a slow to a rapidly flashing light, release the hand-held remote control button and the signal transmitter button.
- ▶ **Step 7:** Press and hold the just-trained signal transmitter button (②, ③ or ④) and observe indicator lamp ①. If indicator lamp ① stays on constantly, programming is complete and your device should activate when the respective signal transmitter button (②, ③ or ④) is pressed and released.

- ▶ **Step 8:** If indicator lamp ① flashes rapidly for approximately 2 seconds and then turns to a constant light, continue with programming steps 8 through 12 as your

garage door opener may be equipped with the “rolling code” feature.

- ▶ **Step 7:** To program the remaining two signal transmitter buttons, repeat the steps above starting with step 3.

Rolling code programming

To train a garage door opener (or other rolling code devices) with the rolling code feature, follow these instructions after completing the “Programming” portion (steps 1 through 6) of this text. For your convenience and to complete the procedure faster, you might want to have someone assist you.

- ▶ **Step 8:** Locate the “training” button on the garage door opener motor head unit.

i Exact location and color of the button may vary by garage door opener brand. Depending on manufacturer, the “training” button may also be referred to as “learn” or “smart” button. If there is difficulty locating the transmitting button, refer to the garage door opener Operator’s Manual.

- ▶ **Step 9:** Press the “training” button on the garage door opener motor head unit. The “training light” is activated.

You have 30 seconds to initiate the following two steps.

- ▶ **Step 10:** Return to the vehicle and firmly press, hold for 2 seconds and release the programmed signal transmitter button (②, ③ or ④).

- ▶ **Step 11:** Press, hold for 2 seconds and release same signal transmitter button a second time to complete the training process.

i Some garage door openers (or other rolling code equipped devices) may require you to press, hold for 2 seconds and release the same signal transmitter button a third time to complete the training process.

- ▶ **Step 12:** Confirm the garage door operation by pressing the programmed signal transmitter button (②, ③ or ④).

- ▶ **Step 13:** To program the remaining two signal transmitter buttons, repeat the steps above starting with step 3.

Gate operator/Canadian programming

Canadian radio-frequency laws require transmitter signals to “time-out” (or quit) after several seconds of transmission which may not be long enough for the integrated signal transmitter to pick up the signal during programming. Similar to this Canadian law, some U.S. gate operators are designed to “time-out” in the same manner.

If you live in Canada or if you are having difficulties programming a gate operator (regardless of where you live) by using the programming procedures, replace step 4 with the following:

- ▶ **Step 4:** Press and hold the signal transmitter button (②, ③ or ④). Do not release this button until it has been successfully trained.

- ▶ While still holding down the signal transmitter button (②, ③ or ④), “cycle” your hand-held remote control button ⑥ as follows: Press and hold button ⑥ for 2 seconds, then release it for 2 seconds, and again press and hold it for 2 seconds. Repeat this sequence on the hand-held remote control until the frequency signal has been learned.

Upon successful training, indicator lamp ① will flash slowly and then rapidly after several seconds.

- ▶ Proceed with programming step 5 and step 6 to complete.

i Upon completion of programming the integrated remote control, make sure you retain the hand-held remote control that came with the garage door opener, gate operator or other device. You may need it for use in other vehicles, for future programming of an integrated remote

control, or simply for continued use as a hand-held remote control to operate the respective device in other situations.

Reprogramming a single signal transmitter button

To program a device using a signal transmitter button previously trained, follow these steps:

- ▶ Switch on the ignition.
- ▶ Press and hold the desired signal transmitter button (②, ③ or ④). Do not release the button. Indicator lamp ① will begin to flash after 20 seconds.
- ▶ Without releasing the signal transmitter button, proceed with programming starting with step 3.

Operation of integrated remote control

- ▶ Switch on the ignition.
- ▶ Select and press the appropriate integrated signal transmitter button (②, ③ or ④) to activate the remote controlled device. The integrated remote control transmitter continues to send the signal as long as the button is pressed – up to 20 seconds.

Erasing the integrated remote control memory

- ① If you sell your vehicle, erase the codes of all three channels.
- ▶ Switch on the ignition.
- ▶ Simultaneously press and hold outer signal transmitter buttons ② and ④, for approximately 20 seconds, until indicator lamp ① flashes rapidly. Do not hold for longer than 30 seconds. The codes of all three channels are erased.

Programming tips

If you are having difficulty programming the integrated remote control, here are some helpful tips:

- Check the frequency of hand-held remote control ⑤ (typically located on the reverse side of the remote). The integrated remote control is compatible with radio-frequency devices operating between 280-390 MHz.
 - Put a new battery in hand-held remote control ⑤. This will increase the likelihood of the hand-held remote control sending a stronger and more accurate signal to the integrated remote control.
 - While performing step 3, hold hand-held remote control ⑤ at different lengths and angles from the signal transmitter button (②, ③ or ④) you are programming. Attempt varying angles at the distance of 2 to 12 inches (5 to 30 cm) away or the same angle at varying distances.
 - If another hand-held remote control is available for the same device, try the programming steps again using that other hand-held remote control. Make sure new batteries are in the hand-held remote control before beginning the procedure.
 - Straighten the antenna wire from the garage door opener assembly. This may help improve transmitting and/or receiving signals.
- ① Certain types of garage door openers are incompatible with the integrated remote control. If you should experience further difficulties with programming the integrated remote control, contact an authorized Mercedes-Benz Center, or call the Mercedes-Benz Customer Assistance Center (USA only) at 1-800-FOR-MERcedes (1-800-367-6372), or the HomeLink® Hotline (USA only) at 1-800-355-3515, or the Customer Service (Canada only) at 1-800-387-0100.

i USA only:

This device complies with Part 15 of the FCC Rules. Operation is subject to the following two conditions:

1. This device may not cause harmful interference, and
2. this device must accept any interference received, including interference that may cause undesired operation.

Any unauthorized modification to this device could void the user's authority to operate the equipment.

i Canada only:

This device complies with RSS-210 of Industry Canada. Operation is subject to the following two conditions:

1. This device may not cause interference, and
2. this device must accept any interference received, including interference that may cause undesired operation of the device.

Any unauthorized modification to this device could void the user's authority to operate the equipment.

- Move the driver's seat as far to the rear as possible.

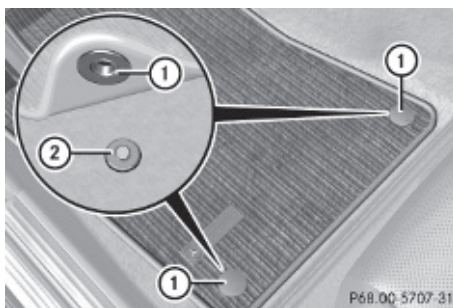

- **Removing:** Pull floormat off of retainer pins ②.
- **Installing:** Press floormat eyelets ① onto retainer pins ②.

Floormats**⚠ Warning!**

Whenever you are using a floormat, make sure there is enough clearance and that the floormat is securely fastened.

The floormat should always be securely fastened using the fastening equipment.

Before driving off, check that the floormat is securely in place and adjust it if necessary. A loose floormat could slip and hinder proper functioning of the pedals.

Do not place several floormats on top of each other as this may impair pedal movement.

Vehicle equipment	222
The first 1000 miles (1500 km)	222
At the gas station	222
Engine compartment	224
Tires and wheels	229
Winter driving	252
Driving instructions	254
Maintenance	258
Vehicle care	260

امداد خودرو فارما

تلفن شبانه روزی: ۰۲۱-۸۸۸۶۲۰۸۵

FarmaSOS.com



Vehicle equipment

- i** This Operator's Manual describes all features, standard or optional, potentially available for your vehicle at the time of purchase. Please be aware that your vehicle might not be equipped with all features described in this manual.

The first 1000 miles (1500 km)

The more cautiously you treat your vehicle during the break-in period, the more satisfied you will be with its performance later on.

- Drive your vehicle during the first 1000 miles (1500 km) at varying but moderate vehicle and engine speeds.
- During this period, avoid heavy loads (full throttle driving) and excessive engine speeds (no more than $\frac{2}{3}$ of maximum rpm in each gear).
- Vehicles with automatic transmission:
 - Select **C** as the preferred shift program (▷ page 111) for the first 1000 miles (1500 km).
 - Do not attempt to slow the vehicle down by shifting to a lower gear using the gear selector lever.
 - Select gear ranges **3, 2** or **1** (▷ page 111) only when driving at moderate speeds (for hill driving).
 - Avoid accelerating by kickdown.
- Vehicles with manual transmission:
 - Shift gears in a timely manner.

After 1000 miles (1500 km) you may gradually increase vehicle and engine speeds to the permissible maximum.

i Additional instructions for AMG vehicles:

- During the first 1000 miles (1500 km), do not exceed a speed of 85 mph (140 km/h).
- During this period, avoid engine speeds above 4500 rpm in each gear.
- Shift gears in a timely manner.

All of the above instructions, as may apply to your vehicle type, also apply when driving the first 1000 miles (1500 km) after the engine or the rear differential has been replaced.

- i** Always obey applicable speed limits.

At the gas station

Refueling

Warning!

Gasoline is highly flammable and poisonous. It burns violently and can cause serious personal injury.

Never allow sparks, flames or smoking materials near gasoline!

Turn off the engine before refueling.

Whenever you are around gasoline, avoid inhaling fumes and any skin or clothing contact. Extinguish all smoking materials.

Direct skin contact with fuels and the inhalation of fuel vapors are damaging your health.

Warning!

Overfilling of the fuel tank may create pressure in the system which could cause a gas discharge. This could cause the gas to spray back out when removing the fuel pump nozzle, which could cause personal injury.

Warning!

C 300 and C 300 Sport with automatic transmission:

Flexible Fuel Vehicles (identified by a label reading **Premium gasoline or E85 only!** on the fuel filler flap):

Ethanol fuel (E85) and its fumes are highly flammable, poisonous and burn easily. Ethanol fuel can cause serious injuries if ignited or if you come into contact with it or inhale fumes of it. Avoid inhalation of ethanol fumes and skin contact with ethanol. Extinguish all open flames before refueling. Never smoke or create sparks close to ethanol.

! Never refuel vehicles with gasoline engine with diesel fuel. Even small amounts of diesel fuel will damage the fuel system and engine. Damage resulting from the use of non-approved fuels or fuel additives or resulting from mixing gasoline with diesel fuel is not covered by the Mercedes-Benz Limited Warranty.

! If you have accidentally filled the tank with incorrect or non-approved fuel, do not switch on the ignition. Otherwise the incorrect or non-approved fuel will get into the fuel lines. The fuel system must be drained completely. Contact an authorized Mercedes-Benz Center to have the fuel system drained completely.

! To prevent damage to the catalytic converters, only use premium unleaded gasoline in this vehicle.

Flexible Fuel Vehicles (identified by a label reading **Premium gasoline or E85 only!** on the fuel filler flap) may be fueled with E85. For additional information, see “Flexible Fuel Vehicles”.

Any noticeable irregularities in engine operation should be repaired promptly.

Otherwise, excessive unburned fuel may reach the catalytic converter, causing it to overheat and potentially start a fire.

i Only use premium unleaded gasoline with a minimum Posted Octane Rating of 91 (average of 96 RON/86 MON). Information on gasoline quality can normally be found on the fuel pump. Please contact gas station personnel in case labels on the pump cannot be found.

C 300 and C 300 Sport with automatic transmission:

Flexible Fuel Vehicles are identified by a label reading **Premium gasoline or E85 only!** on the fuel filler flap.

For more information on gasoline or E85, see “Premium unleaded gasoline” (▷ page 354), see “Flexible Fuel Vehicles” (▷ page 355), see “Fuel requirements” (▷ page 354), or contact an authorized Mercedes-Benz Center, or visit www.mbusa.com (USA only).

Locking/unlocking the vehicle with the SmartKey or KEYLESS-GO automatically locks/unlocks the fuel filler flap.

i In case the central locking system does not release the fuel filler flap, see “Fuel filler flap” (▷ page 310).

The fuel filler flap is located on the right-hand side of the vehicle towards the rear.

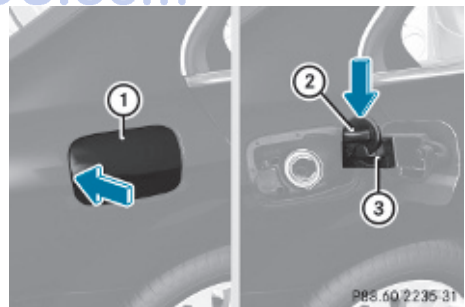

► Turn off the engine.

i Leaving the engine running and the fuel filler cap open can cause the yellow engine malfunction indicator lamp  to illuminate.

For more information, see also “Practical hints” (▷ page 305).

- ▶ Remove the SmartKey from the starter switch.
KEYLESS-GO: Open the driver’s door. This puts the starter switch in position **0**, same as with the SmartKey removed from the starter switch. The driver’s door then can be closed again.

- ▶ **Opening:** Press fuel filler flap ① at the point indicated by the arrow.
- ▶ Turn fuel filler cap ② counterclockwise.
- ▶ Take off fuel filler cap ②.

! The fuel filler cap is tethered to the fuel filler neck. Do not drop the cap. It could damage the vehicle paint finish.

- ▶ Place fuel filler cap ② in direction of arrow into holder ③.
- ▶ Fully insert filler nozzle unit and refuel.
- ▶ Only fill your tank until the filler nozzle unit cuts out – **do not top off or overfill.**
- ▶ **Closing:** Turn fuel filler cap ② clockwise until it audibly engages.

i Close the fuel filler flap before locking the vehicle. Otherwise the flap locking pin will prevent closing the fuel filler flap.

- ▶ Close fuel filler flap ①.

Check regularly and before a long trip

For information on quantities and requirements of operating agents, see “Fuels, coolants, lubricants, etc.” (▷ page 349).

Check the following:

- Engine oil level (▷ page 225)
- Tire inflation pressure (▷ page 232)
- Coolant level (▷ page 227)
- Vehicle lighting (▷ page 313)

- Washer system and headlamp cleaning system (▷ page 228)
- Brake fluid (▷ page 228)

Engine compartment

Hood

⚠ Warning!

Do not pull the release lever while the vehicle is in motion. Otherwise the hood could be forced open by passing air flow.

This could cause the hood to come loose and injure you and/or others.

Opening

⚠ Warning!

Do not open the hood when the engine is overheated. You could be seriously injured. Observe the coolant temperature gauge to determine whether the engine may be overheated. If you see flames or smoke coming from the engine compartment, move away from the vehicle. Wait until the engine has cooled. If necessary, call the fire department.

⚠ Warning!

You could be injured when the hood is open – even when the engine is turned off.

Parts of the engine can become very hot. To prevent burns, let the engine cool completely before touching any components on the vehicle. Comply with all relevant safety precautions.

⚠ Warning!

To help prevent personal injury, stay clear of moving parts when the hood is open and the engine is running.

The radiator fan may continue to run for approximately 30 seconds or may even restart after the engine has been turned off. Stay clear of fan blades.

Warning!

The engine is equipped with a transistorized ignition system. Because of the high voltage it is dangerous to touch any components (ignition coils, spark plug sockets, diagnostic socket) of the ignition system

- with the engine running
- while starting the engine
- when the ignition is switched on and the engine is turned manually



- ▶ Pull hood lock release lever ①. The hood is unlocked.

! Never open the hood if the wiper arms are folded forward away from the windshield. Otherwise the windshield wipers or the hood could be damaged.



- ▶ Push handle ② under the hood upwards.
- ▶ Pull up on the hood and then release it. The hood will be held open at shoulder height by gas-filled struts automatically.

Closing

Warning!

When closing the hood, use extreme caution not to catch hands or fingers. Be careful that you do not close the hood on anyone.

Make sure the hood is securely engaged before driving off. Do not continue driving if the hood can no longer engage after an accident, for example. The hood could otherwise come loose while the vehicle is in motion and injure you and/or others.

- ▶ Let the hood drop from a height of approximately 8 in (20 cm).
- ▶ Check to make sure the hood is fully closed.

If you can raise the hood at a point above the headlamps, then it is not properly closed. Open it again and let it drop with somewhat greater force.

Engine oil

The amount of oil your engine consumes will depend on a number of factors, including driving style. Increased oil consumption can occur when the vehicle is new or the vehicle is driven frequently at higher engine speeds. Engine oil consumption checks should only be made after the vehicle break-in period.

! Do not use any special lubricant additives, as these may damage the drive assemblies. Using special additives not approved by Mercedes-Benz may cause damage not covered by the Mercedes-Benz Limited Warranty.

For further information contact an authorized Mercedes-Benz Center.

Notes on checking engine oil level

When checking the oil level

- the vehicle must be parked on level ground
- with the engine at operating temperature, the vehicle must have been stationary for

at least 5 minutes with the engine turned off

- with the engine not at operating temperature, the vehicle must have been stationary for at least 30 minutes with the engine turned off

Checking engine oil level

- ▶ Open the hood (▷ page 224).

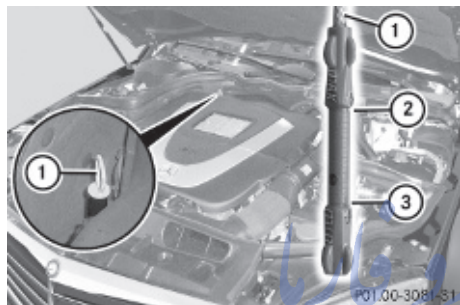

- ▶ Pull out oil dipstick ①.
- ▶ Wipe oil dipstick ① clean.
- ▶ Slowly insert oil dipstick ① fully into the dipstick guide tube.
- ▶ Pull out oil dipstick ① again after approximately 3 seconds to obtain accurate reading. The oil level is correct when it is between lower (min) mark ③ and upper (max) mark ② of oil dipstick ①.

i All models (except C 63 AMG):
The filling quantity between the upper and lower marks on the oil dipstick is approximately 2.1 US qt. (2.0 l).

C 63 AMG:

The filling quantity between the upper and lower marks on the oil dipstick is approximately 1.6 US qt. (1.5 l).

- ▶ If necessary, add engine oil.

For more information on engine oil, see “Fuels, coolants, lubricants etc.”

(▷ page 349).

For information on messages in the multifunction display concerning engine oil, see the “Practical hints” section (▷ page 291).

Adding engine oil

! Only use approved engine oils and oil filters required for vehicles with Maintenance System. For a listing of approved engine oils and oil filters, contact an authorized Mercedes-Benz Center or visit www.mbusa.com (USA only).

The following will result in engine or emission control system damage not covered by the Mercedes-Benz Limited Warranty:

- Using engine oils and oil filters of specification other than those expressly required for the Maintenance System.
- Changing of oil and oil filter at change intervals longer than those called for by the Maintenance System.
- Using any oil additives.



All models (except C 63 AMG)

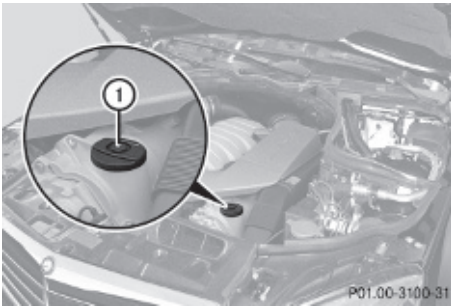

C 63 AMG

- ▶ Unscrew filler cap ① from filler neck.
- ▶ Add engine oil as required. Be careful not to overfill with oil.

Be careful not to spill any oil when adding. Avoid environmental damage caused by oil entering the ground or water.

! Excess oil must be siphoned or drained off. It could cause damage to the engine and emission control system not covered by the Mercedes-Benz Limited Warranty.

- ▶ Screw filler cap ① back on filler neck.

For more information on engine oil, see the “Technical data” section (▷ page 349) and (▷ page 353).

Transmission fluid level

Vehicles with automatic transmission:
The transmission fluid level does not need to be checked. If you notice transmission fluid loss or gearshifting malfunctions, have an authorized Mercedes-Benz Center check the transmission.

Coolant level

The engine coolant is a mixture of water and anticorrosion/antifreeze.

When checking the coolant level, the vehicle must be parked on level ground, and the coolant temperature must be below 158°F (70°C).

Warning!

In order to avoid any potentially serious burns:

- Use extreme caution when opening the hood if there are any signs of steam or coolant leaking from the cooling system, or if the coolant temperature gauge indicates that the coolant is overheated.
- Do not remove the cap on the coolant expansion tank if the coolant temperature is above 158°F (70°C). Allow the engine to cool down before removing the cap. The coolant expansion tank contains hot fluid and is under pressure.
- Using a rag, slowly open the cap approximately $1/2$ turn counterclockwise to relieve excess pressure. If opened immediately, scalding hot fluid and steam will be blown out under pressure.
- Do not spill antifreeze on hot engine parts. Antifreeze contains ethylene glycol which may burn if it comes into contact with hot engine parts.

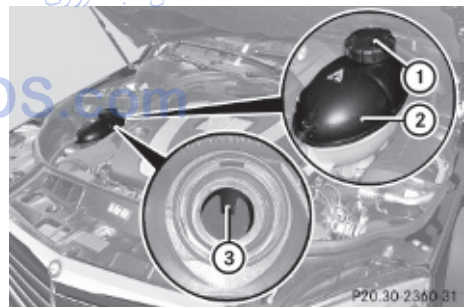

- ▶ Using a rag, slowly open cap ① approximately $1/2$ turn counterclockwise to relieve excess pressure.
- ▶ Continue turning cap ① counterclockwise and remove it.

The coolant level is correct if the level

- for cold coolant: reaches marking bar ③ in coolant expansion tank ②
- for warm coolant: is approximately 0.6 in (1.5 cm) higher

- ▶ Add coolant as required.
- ▶ Screw cap ① back on and tighten it.

For more information on coolant, see the “Technical data” section (▷ page 351) and (▷ page 356).

Washer system and headlamp cleaning system

Warning!

Washer solvent/antifreeze is highly flammable. Do not spill washer solvent/antifreeze on hot engine parts, because it may ignite and burn. You could be seriously burned.

! Always use washer solvent/antifreeze where temperatures may fall below freezing point. Failure to do so could result in damage to the washer system/fluid reservoir.

! Only use washer fluid which is suitable for plastic lenses. Improper washer fluid can damage the plastic lenses of the headlamps.

! Do not use distilled or deionized water in the washer fluid reservoir. Otherwise, the washer fluid level sensor could be damaged.

Fluid for the washer system and the headlamp cleaning system is supplied from the washer fluid reservoir.

During all seasons, use MB Windshield Washer Concentrate “MB SummerFit”. Mix it with water or premixed washer solvent/antifreeze depending on the ambient temperature (▷ page 358).

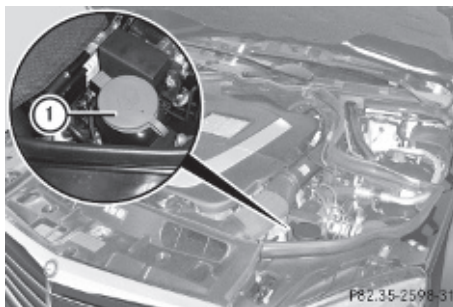

▶ **Opening washer fluid reservoir:** Pull tab of cap ① upwards.

▶ Refill the washer fluid reservoir.

▶ **Closing washer fluid reservoir:** Press cap ① onto filler hole until it engages.

For more information, see “Washer system and headlamp cleaning system” (▷ page 352).

Brake fluid level

! If you find that the brake fluid in the brake fluid reservoir has fallen to the minimum mark or below, have the brake system checked for brake pad thickness and leaks immediately. Contact an authorized Mercedes-Benz Center immediately. Do not add brake fluid as this will not solve the problem. For more information, see “Practical hints”.

When checking the brake fluid level, the vehicle must be parked on level ground.

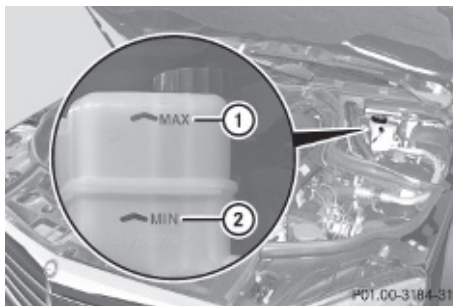

The brake fluid level is correct when it is between lower mark (MIN) ② and upper mark (MAX) ① of the brake fluid reservoir.

Tires and wheels

Safety notes

Contact an authorized Mercedes-Benz Center for information on tested and recommended rims and tires for summer and winter operation. They can also offer advice concerning tire service and purchase.

Warning!

Replace rims or tires with the same designation, manufacturer and type as shown on the original part. For further information contact an authorized Mercedes-Benz Center. If incorrectly sized rims and tires are mounted, the wheel brakes or suspension components can be damaged. Also, the operating clearance of the wheels and the tires may no longer be correct.

Warning!

Worn, old tires can cause accidents. If the tire tread is worn to minimum tread depth, or if the tires have sustained damage, replace them.

When replacing rims, only use genuine Mercedes-Benz wheel bolts specified for the particular rim type. Failure to do so can result in the bolts loosening and possibly an accident.

Retreaded tires are not tested or recommended by Mercedes-Benz, since previous damage cannot always be recognized on retreads. The operating safety of the vehicle cannot be assured when such tires are used.

Warning!

If you feel a sudden significant vibration or ride disturbance, or you suspect that possible damage to your vehicle has occurred, you

should turn on the hazard warning flashers, carefully slow down, and drive with caution to an area which is a safe distance from the road. Inspect the tires and the vehicle underbody for possible damage. If the vehicle or tires appear unsafe, have the vehicle towed to the nearest authorized Mercedes-Benz Center or tire dealer for repairs.

Warning!

Do not drive with a flat tire. A flat tire affects the ability to steer or brake the vehicle. You could lose control of the vehicle. Continued driving with a flat tire or driving at high speed with a flat tire will cause excessive heat build-up and possibly a fire.

Important guidelines

- Only use sets of tires and rims of the same type and make.
- Tires must be of the correct size for the rim.
- Break in new tires for approximately 60 miles (100 km) at moderate speeds.
- Regularly check the tires and rims for damage. Dented or bent rims can cause tire inflation pressure loss and damage to the tire beads.
- If the vehicle is heavily loaded, check tire inflation pressure and correct as required.
- Do not allow your tires to wear down too far. Adhesion properties on wet roads are sharply reduced at tread depths of less than $\frac{1}{8}$ in (3 mm).
- When replacing individual tires, you should mount new tires on the front wheels first (on vehicles with same-sized wheels all around).

Recommended tire inflation pressure

Warning!

Follow recommended tire inflation pressures. Do not underinflate tires. Underinflated tires wear excessively and/or unevenly, adversely affect handling and fuel economy, and are more likely to fail from being overheated.

Do not overinflate tires. Overinflated tires can adversely affect handling and ride comfort, wear unevenly, increase stopping distance, and result in sudden deflation (blowout) because they are more likely to become punctured or damaged by road debris, potholes etc.

Do not overload the tires by exceeding the specified load limit as indicated on the Tire and Loading Information placard on the driver's door B-pillar. Overloading the tires can overheat them, possibly causing a blowout. Overloading the tires can also result in handling or steering problems, or brake failure.

Your vehicle is equipped with the Tire and Loading Information placard located on the driver's door B-pillar (> page 238).

The tire inflation pressure should be checked regularly. Only adjust the tire inflation pressure on cold tires. The tires can be considered cold if the vehicle has been parked for at least 3 hours or driven less than 1 mile (1.6 km). Depending on the ambient temperature, the driving speed and the tire load, the tire temperature changes. When the tire temperature changes by 18°F (10°C), the tire inflation pressure will change by approximately 1.5 psi (0.1 bar). Keep this in mind when checking tire inflation pressure on warm tires and adjust the tire pressure only if the tire inflation pressure is too low for the current operating conditions. If you check the tire inflation pressure when the tires are warm, the reading will be higher than the cold reading. This is normal. Do not let air out to match the specified cold tire inflation

pressure. Otherwise, the tire will be underinflated.

Follow recommended cold tire inflation pressures listed on Tire and Loading Information placard on the driver's door B-pillar.

Keeping the tires properly inflated provides the best handling, tread life and riding comfort.

In addition to the Tire and Loading Information placard on the driver's door B-pillar, also consult the tire inflation pressure label on the inside of the filler flap for any additional information pertaining to special driving situations. For more information, see "Important notes on tire inflation pressure" (> page 231).

 Data shown on Tire and Loading Information placard example are for illustration purposes only. Tire data are specific to each vehicle and may vary from data shown in the following illustration. Refer to Tire and Loading Information placard on vehicle for actual data specific to your vehicle.



The placard contains the following information:

TIRES / PNEUS		LOADING INFORMATION / CHARGEMENT	
SEATING CAPACITY / NOMBRE DE SIÈGES	TOTAL	FRONT / AVANT	REAR / ARRIÈRE
5	500 kg	2	2
The combined weight of occupants and cargo should never exceed XXXX kg or XXXX lbs. * See an authorized dealer for proper loading technique. * Le poids total des occupants et de la cargaison ne doit jamais dépasser XXXX kg ou XXXX lbs. *			
TIRE / PNEU	SIZE / TAILLE	COLD TIRE PRESSURE / PRESSION DES PNEUS À FROID	SEE OWNERS MANUAL FOR ADDITIONAL INFORMATION
FRONT / AVANT	235/40 ZR18 91Y XL	300 KPA, 25 PSI	
REAR / ARRIÈRE	235/40 ZR18 91Y XL	300 KPA, 25 PSI	
SPARE / DE RECHANGE	175/70R16 85P	420 KPA, 30 PSI	

P40.00.2133-31

The Tire and Loading Information placard lists the recommended cold tire inflation pressures  for maximum loaded vehicle weight. The tire inflation pressures listed apply to the tires installed as original equipment.

Important notes on tire inflation pressure

Warning!

If the tire inflation pressure drops repeatedly, check the tires for punctures from foreign objects and/or whether air is leaking from the valves or from around the rim.

Tire temperature and tire inflation pressure are also increased while driving, depending on the driving speed and the tire load.

If you will be driving your vehicle at high speeds of 100 mph (160 km/h) or higher, where it is legal and conditions allow, consult the tire inflation pressure label on the inside of the fuel filler flap on how to adjust the cold tire inflation pressure. If you do not adjust the tire inflation pressure, excessive heat can build up and result in sudden tire failure.

If you are not sure about the proper tire inflation pressure, contact an authorized Mercedes-Benz Center.

- Driving comfort may be reduced when the tire inflation pressure is adjusted to the value for speeds above 100 mph (160 km/h) as specified on the tire inflation pressure label located on the inside of the fuel filler flap.

Make sure to readjust the tire inflation pressure for normal driving speeds.

Supplemental tire inflation pressure information for different loading conditions of the vehicle can be found on the tire inflation pressure label. The tire inflation pressure label is located on the inside of the fuel filler flap.

For the tire inflation pressure for spare wheels such as Minispare wheels or spare wheels with collapsible tire refer to

- the yellow label on the spare wheel rim
- the “Technical data” section of this Operator’s Manual (▷ page 349)
- the Tire and Loading Information placard on the driver’s door B-pillar

Unless specified otherwise, the tire inflation pressures on the tire inflation pressure label are valid for all approved, factory-equipped tires.

- Data shown on tire inflation pressure label examples are for illustration purposes only. Tire inflation pressure data are specific to each vehicle and may vary from data shown in the following illustrations. Refer to the tire inflation pressure label on vehicle for actual data specific to your vehicle.

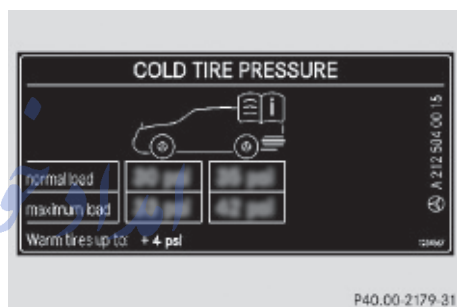

Example illustration: Tire inflation pressures for all approved, factory equipped tires

When a tire size is specified, the tire inflation pressure that follows applies to that particular tire size only.

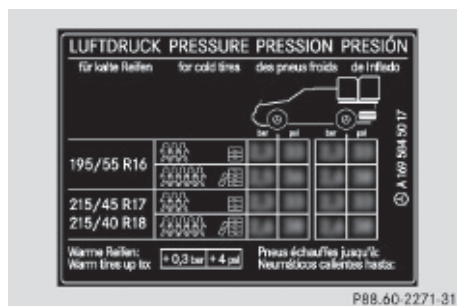

Example illustration: Tire inflation pressures for particular tire sizes

Some tire inflation pressure labels may only show the rim diameter instead of the entire tire size, e.g. **R 18** or **18"**.

The rim diameter is part of the tire size as specified on the tire sidewall (▷ page 246).

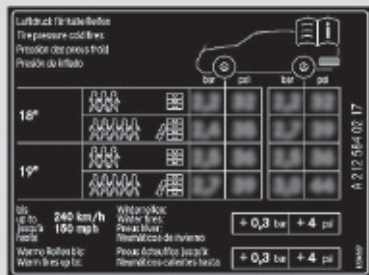

P40.00-2178-31

Example illustration: Tire inflation pressures specific to rim diameter

Potential problems associated with underinflated and overinflated tires

Underinflated tires

Warning!

Follow recommended tire inflation pressures. Do not underinflate tires. Underinflated tires wear excessively and/or unevenly, adversely affect handling and fuel economy, and are more likely to fail from being overheated.

Underinflated tires can

- cause excessive and uneven tire wear
- adversely affect fuel economy
- lead to tire failure from being overheated
- adversely affect handling characteristics

Overinflated tires

Warning!

Follow recommended tire inflation pressures. Do not overinflate tires. Overinflated tires can adversely affect handling and ride comfort, wear unevenly, increase stopping distance, and result in sudden deflation (blowout) because they are more likely to become punctured or damaged by road debris, potholes etc.

Overinflated tires can

- adversely affect handling characteristics
- cause uneven tire wear

- be more prone to damage from road hazards
- adversely affect ride comfort
- increase stopping distance

Checking tire inflation pressure

Safety notes

Warning!

Follow recommended tire inflation pressures.

Do not underinflate tires. Underinflated tires wear excessively and/or unevenly, adversely affect handling and fuel economy, and are more likely to fail from being overheated.

Do not overinflate tires. Overinflated tires can adversely affect handling and ride comfort, wear unevenly, increase stopping distance, and result in sudden deflation (blowout) because they are more likely to become punctured or damaged by road debris, potholes etc.

Do not overload the tires by exceeding the specified load limit as indicated on the Tire and Loading Information placard on the driver's door B-pillar. Overloading the tires can overheat them, possibly causing a blowout. Overloading the tires can also result in handling or steering problems, or brake failure.

Check the tire inflation pressure at least once a month.

Check and adjust the tire inflation pressure when the tires are cold (> page 230).

Checking tire inflation pressure manually

Follow the steps below to achieve correct tire inflation pressure:

- ▶ Remove the cap from the valve on one tire.
- ▶ Firmly press a tire gauge onto the valve.
- ▶ Read the tire inflation pressure on the tire gauge and check against the recommended tire inflation pressure on the

Tire and Loading Information placard on the driver's door B-pillar (▷ page 238). If necessary, add air to achieve the recommended tire inflation pressure.

- ▶ If you have overfilled the tire, release tire inflation pressure by pushing the metal stem of the valve with e.g. a tip of a pen. Then recheck the tire inflation pressure with the tire gauge.
- ▶ Install the valve cap.
- ▶ Repeat this procedure for each tire.

Tire pressure loss warning system (Canada only)

While the vehicle is being driven, the tire pressure loss warning system monitors the set tire inflation pressures by evaluating each wheel's rotational speed. This allows the system to detect a significant loss of pressure in a tire. If a wheel's rotational speed changes due to falling tire inflation pressure, you will see a corresponding warning message in the multifunction display.

The tire pressure loss warning system may function in a restricted manner or with a delay

- when snow chains are mounted to the vehicle
- in the presence of ice and snow
- when you are driving on a loose surface (e.g. sand or gravel)
- when you are driving in a very sporty manner (involving rapid acceleration or high speeds in curves)
- when you are driving with a loaded roof rack or heavily laden vehicle

Warning!

When the multifunction display shows the message Check Tire Pressure Soon, one or more of your tires are significantly underinflated. You should stop and check your tires as soon as possible, and inflate them to the proper tire inflation pressure as

indicated on the vehicle's Tire and Loading Information placard or, if available, on the tire inflation pressure label.

Driving on a significantly underinflated tire causes the tire to overheat and can lead to tire failure. Underinflation also reduces fuel efficiency and tire tread life, and may affect the vehicle's handling and stopping ability. Each tire, including the spare, should be checked at least once a month when cold. Inflate the tires to the recommended tire inflation pressure as specified on

- the Tire and Loading Information placard on the driver's door B-pillar
- or
- the tire inflation pressure label located on the inside of the fuel filler flap

 The recommended tire inflation pressures for your vehicle can be found on

- the Tire and Loading Information placard located on the driver's door B-pillar (▷ page 238)
- the tire inflation pressure label on the inside of the fuel filler flap

The tire inflation pressures are not listed in the Operator's Manual.

Warning!

The tire pressure loss warning system does not provide a warning for wrongly selected tire inflation pressures. Always adjust tire inflation pressure according to the Tire and Loading Information placard on the driver's door B-pillar or on the tire inflation pressure label located on the inside of the fuel filler flap.

The tire pressure loss warning system does not replace regular checks of the tire inflation pressures since a gradual pressure loss in more than one tire cannot be detected by the tire pressure loss warning system.

The tire pressure loss warning system is not able to issue a warning due to a sudden dramatic loss of tire inflation pressure (e.g.

tire blowout caused by a foreign object). In this case bring the vehicle to a halt by carefully applying the brakes and avoiding abrupt steering maneuvers.

Restarting the tire pressure loss warning system





The tire pressure loss warning system must be restarted in the following situations:

- after you have changed the tire inflation pressure
 - after you have replaced the wheels or tires
 - after you have installed new wheels or tires
- ▶ Using the Tire and Loading Information placard on the driver's door B-pillar or, if available, the tire inflation pressure label on the inside of the fuel filler flap, make sure the tire inflation pressure of all four tires is correct.



Warning!

The tire pressure loss warning system can only warn you in a reliable manner if you have set the correct tire inflation pressures for each tire.

If an incorrect tire inflation pressure was set, the system will monitor the pressure according to the incorrect value.



- ▶ Switch on the ignition.
- ▶ Press button  or  on the multifunction steering wheel to select the Service menu (> page 129).
- ▶ Press button  or  on the multifunction steering wheel to select Tire Pressure.
- ▶ Press button  on the multifunction steering wheel to confirm. The following message appears in the multifunction display:
Run Flat Indicator
Active
Press 'OK' to Restart

- ▶ Press button .
The following message will appear in the multifunction display:
Tire Pressure
Now OK?
Cancel
Yes

- ▶ **If you wish to confirm:** Press button  or  to select Yes.

- ▶ Press button .
The following message will appear in the multifunction display:
Run Flat
Indicator
Restarted

After a certain "learning phase", the tire pressure loss warning system checks the set pressure values for all four tires.

- ▶ **If you wish to cancel:** Press button  or  to select Cancel].
- ▶ Press button  to confirm.
The previous settings remain unchanged.

Advanced Tire Pressure Monitoring System (Advanced TPMS), (USA only)

Your vehicle is equipped with the Advanced Tire Pressure Monitoring System (Advanced TPMS). It measures the tire inflation pressure in the vehicle's tires and issues warnings in case of pressure loss in one or more of the tires.

The TPMS is equipped with a combination low tire pressure/TPMS malfunction telltale in the instrument cluster. Depending on how the telltale illuminates, it indicates a low tire pressure condition or a malfunction in the TPMS system itself:

- If the telltale illuminates continuously, one or more of your tires is significantly underinflated. There is no malfunction in the TPMS.
- If the telltale flashes for 60 seconds and then stays illuminated, the TPMS system itself is not operating properly.

The TPMS only functions on wheels that are equipped with the proper electronic sensors.

Warning!

The TPMS does not indicate a warning for wrongly selected inflation pressures. Always adjust tire inflation pressure according to the Tire and Loading Information placard or the supplemental tire inflation pressure information on the inside of the fuel filler flap.

The TPMS is not able to issue a warning due to a sudden dramatic loss of pressure (e.g. tire blowout caused by a foreign object). In this case bring the vehicle to a halt by carefully applying the brakes and avoiding abrupt steering maneuvers.

Warning!

Each tire, including the spare (if provided), should be checked at least once a month when cold and inflated to the inflation pressure recommended by the vehicle manufacturer on the Tire and Loading Information placard on the driver's door B-pillar or the tire inflation pressure label on the inside of the fuel filler flap. If your vehicle has tires of a different size than the size indicated on the Tire and Loading Information placard or the tire inflation pressure label, you should determine the proper tire inflation pressure for those tires.

As an added safety feature, your vehicle has been equipped with a tire pressure monitoring system (TPMS) that illuminates a low tire pressure telltale when one or more of your tires are significantly underinflated.

Accordingly, when the low tire pressure telltale illuminates, you should stop and check your tires as soon as possible, and inflate them to the proper pressure. Driving on a significantly underinflated tire causes the tire to overheat and can lead to tire failure.

Underinflation also reduces fuel efficiency and tire tread life, and may affect the vehicle's handling and stopping ability. Please note that the TPMS is not a substitute for proper tire

maintenance, and it is the driver's responsibility to maintain correct tire pressure, even if underinflation has not reached the level to trigger illumination of the TPMS low tire pressure telltale.

Your vehicle has also been equipped with a TPMS malfunction indicator to indicate when the system is not operating properly. The TPMS malfunction indicator is combined with the low tire pressure telltale. When the system detects a malfunction, the telltale will flash for approximately 1 minute and then remain continuously illuminated. This sequence will continue upon subsequent vehicle start-ups as long as the malfunction exists. When the malfunction indicator is illuminated, the system may not be able to detect or signal low tire pressure as intended.





TPMS malfunctions may occur for a variety of reasons, including the installation of incompatible replacement or alternate tires or wheels on the vehicle that prevent the TPMS from functioning properly. Always check the TPMS malfunction telltale after replacing one or more tires or wheels on your vehicle to ensure that the replacement or alternate tires and wheels allow the TPMS to continue to function properly.

-  If a condition causing the TPMS to malfunction develops, it may take up to 10 minutes for the system to signal a malfunction using the TPMS telltale flashing and illumination sequence. The telltale extinguishes after a few minutes driving if the malfunction has been corrected.

Tire pressure inquiries are made using the multifunction display. The current tire inflation pressure for each tire appears in the multifunction display after a few minutes of driving.

-  Possible differences between the readings of a tire pressure gauge of an air hose, e.g. gas station equipment, and the vehicle's control system can occur. The tire

pressure displayed by the control system apply to sea level. In high-altitude locations, the reading on a tire pressure gauge will be higher than the reading issued by the vehicle's control system. Do not reduce the tire inflation pressure under such circumstances.

- ▶ Switch on the ignition.
- ▶ Press button  or  on the multifunction steering wheel to select the Service menu (▷ page 129).
- ▶ Press button  or  to select Tire Pressure.
- ▶ Press button .

The current inflation pressure for each tire appears in the multifunction display.



Example illustration

When the vehicle has been parked for longer than 20 minutes, the message Tire pressures will be displayed after driving a few minutes appears in the multifunction display.

The TPMS recognizes new wheels or sensors automatically after the learn-in phase. As long as the tire inflation pressure values cannot be allocated to the individual wheels, the message Tire Pressure Monitor Active appears. Despite this message, the tire inflation pressure values are monitored already.

- ❗ With a spare wheel mounted, the system may still indicate the tire inflation pressure of the removed road wheel for some minutes. If this happens, keep in mind that the indicated value where the spare wheel is mounted does not reflect the actual spare tire inflation pressure.

- ❗ Operating radio transmission equipment (e.g. wireless headsets, two-way radios) in or near the vehicle could cause the TPMS to malfunction.

- ❗ This device complies with Part 15 of the FCC Rules. Operation is subject to the following two conditions:
 1. This device may not cause harmful interference, and
 2. this device must accept any interference received, including interference that may cause undesired.

Any unauthorized modification to this device could void the user's authority to operate the equipment.

Tire inflation pressure warnings

If the system detects a significant loss of tire inflation pressure in one or more than one tire, a message appears in the multifunction display. In addition, an acoustic warning sounds and the low tire pressure telltale in the instrument cluster comes on.

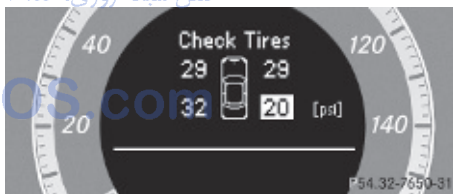

Example illustration

The respective tire is indicated by a red rectangle.

Restarting Advanced TPMS

⚠ Warning!

It is the driver's responsibility to set the tire inflation pressure to the recommended cold tire inflation pressure. Underinflated tires affect the ability to steer or brake the vehicle. You might lose control over the vehicle.



When you restart the TPMS, the system sets new reference values for each tire.



The TPMS must be restarted when you have adjusted the tire inflation pressure to a new level (e.g. because of different load or driving conditions). The TPMS is then recalibrated to the current tire inflation pressures.

Restart the TPMS after adjusting the tire inflation pressure to the inflation pressure recommended for the vehicle operating condition. Tire inflation pressure should only be adjusted on cold tires. Observe the recommended tire inflation pressure on the Tire and Loading Information placard on the driver's door B-pillar. Some vehicles may have supplemental tire inflation pressure information for driving at high speeds or for vehicle loads less than the maximum loaded vehicle condition. If such information is provided, it can be found on the inside of the fuel filler flap.

▶ Using the Tire and Loading Information placard on the driver's door B-pillar (▷ page 238) or the supplemental tire inflation pressure information on the inside of the fuel filler flap, make sure the tire inflation pressure of all four tires is correct.

▶ Switch on the ignition.

▶ Press button  or  on the multifunction steering wheel to select the Service menu.

▶ Press button  or  on the multifunction steering wheel to select Tire Pressure.

▶ Press button .

The current inflation pressure for each tire appears in the multifunction display or the following message appears in the multifunction display:

Tire pressures
will be displayed
after driving
a few minutes

▶ Press button .

The following message appears in the multifunction display:

Use Current
Pressures As New

Reference Values

Press 'OK' to Confirm

▶ Press button .

The following message appears in the multifunction display:

Tire Press. Monitor
Restarted

After driving a few minutes the system verifies that the current tire inflation pressures are within the system's specified range. Afterwards the current tire inflation pressures are accepted as reference values and then monitored.

▶ **If you wish to cancel:** Press button .

or

▶ Press button  to exit the menu screen.

i When the wheel positions have been changed, the inflation pressure of a tire may be displayed for the wrong position temporarily. After driving for a few minutes, the inflation pressure will be shown for the correct position.

Maximum tire inflation pressure

Warning!

Never exceed the maximum tire inflation pressure. Follow recommended tire inflation pressures.

Do not underinflate tires. Underinflated tires wear excessively and/or unevenly, adversely affect handling and fuel economy, and are more likely to fail from being overheated.

Do not overinflate tires. Overinflated tires can adversely affect handling and ride comfort, wear unevenly, increase stopping distance, and result in sudden deflation (blowout) because they are more likely to become punctured or damaged by road debris, potholes etc.

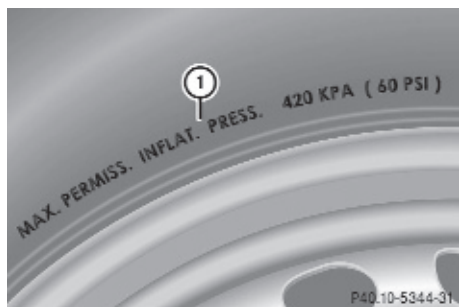

- i** For illustration purposes only. Actual data on tires are specific to each vehicle and may vary from data shown in above illustration.

This is the maximum permissible tire inflation pressure ① for the tire.

Always follow the recommended tire inflation pressure (▷ page 230) for proper tire inflation.

Loading the vehicle

Two labels on your vehicle show how much weight it may properly carry.

- (1) The Tire and Loading Information placard can be found on the driver's door B-pillar. This placard tells you important information about the number of people that can be in the vehicle and the total weight that can be carried in the vehicle. It also contains information on the proper size and recommended tire inflation pressures for the original equipment tires on your vehicle.
- (2) The certification label, also found on the driver's door B-pillar. It tells you about the gross weight capacity of your vehicle, called the Gross Vehicle Weight Rating (GVWR). The GVWR includes the weight of the vehicle, all occupants, fuel and cargo. The certification label also tells you about the front and rear axle weight capacity, called the Gross Axle Weight Rating (GAWR).

The GAWR is the total allowable weight that can be carried by a single axle (front or rear). Never exceed the GVWR or GAWR for either the front axle or rear axle.

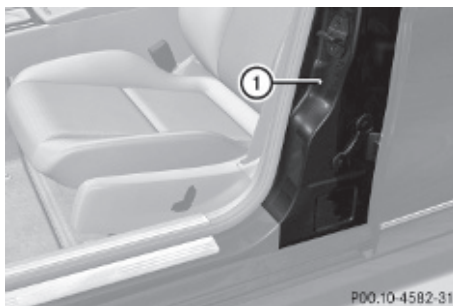

- ① Driver's door B-pillar

Following is a discussion on how to work with the information contained on the Tire and Loading Information placard with regards to loading your vehicle.

Tire and Loading Information

Warning! تلفن

Do not overload the tires by exceeding the specified load limit as indicated on the Tire and Loading Information placard on the driver's door B-pillar. Overloading the tires can overheat them, possibly causing a blowout. Overloading the tires can also result in handling or steering problems, or brake failure.

Tire and Loading Information placard

- i** Data shown on Tire and Loading Information placard example are for illustration purposes only. Load limit data are specific to each vehicle and may vary from data shown in the following illustration. Refer to Tire and Loading Information placard on vehicle for actual data specific to your vehicle.

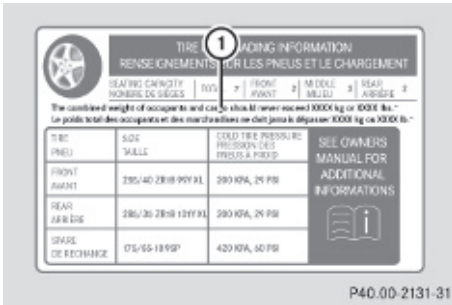

The Tire and Loading Information placard showing load limit information ① is located on the driver’s door B-pillar (▷ page 238).

- ▶ Locate the statement “The combined weight of occupants and cargo should never exceed XXX kilograms or XXX lbs.” on the Tire and Loading Information placard.

The combined weight of all occupants, cargo/luggage and trailer tongue load (if applicable) should never exceed the weight referenced in that statement.

Seating capacity

① Data shown on Tire and Loading Information placard example are for illustration purposes only. Seating capacity data are specific to each vehicle and may vary from data shown in the following illustration. Refer to Tire and Loading Information placard on vehicle for actual data specific to your vehicle.

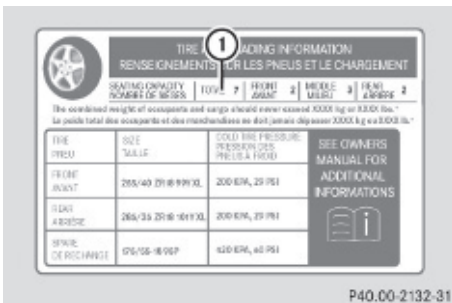

The seating capacity gives you important information on the number of occupants that

can be in the vehicle. Observe front and rear seating capacity. The Tire and Loading Information placard showing seating capacity ① is located on the driver’s door B-pillar (▷ page 238).

Steps for determining correct load limit

The following steps have been developed as required of all manufacturers under Title 49, Code of U.S. Federal Regulations, Part 575 pursuant to the “National Traffic and Motor Vehicle Safety Act of 1966”.

- ▶ **Step 1:** Locate the statement “The combined weight of occupants and cargo should never exceed XXX kg or XXX lbs.” on your vehicle’s Tire and Loading Information placard.
- ▶ **Step 2:** Determine the combined weight of the driver and passengers that will be riding in your vehicle.
- ▶ **Step 3:** Subtract the combined weight of the driver and passengers from XXX kilograms or XXX lbs.
- ▶ **Step 4:** The resulting figure equals the available amount of cargo and luggage load capacity. For example, if the “XXX” amount equals 1400 lbs and there will be five 150 lbs passengers in your vehicle, the amount of available cargo and luggage load capacity is 650 lbs (1400 - 750 (5 x 150) = 650 lbs).
- ▶ **Step 5:** Determine the combined weight of luggage and cargo being loaded on the vehicle. That weight may not safely exceed the available cargo and luggage load capacity calculated in step 4.
- ▶ **Step 6 (if applicable):** If your vehicle will be towing a trailer, load from your trailer will be transferred to your vehicle. Consult this manual to determine how this reduces the available cargo and luggage load capacity of your vehicle (▷ page 242).

The following table shows examples on how to calculate total and cargo load capacities with varying seating configurations and

number and size of occupants. The following examples use a load limit of 1 500 lbs. **This is for illustration purposes only.** Make sure you are using the actual load limit for your vehicle stated on the vehicle's Tire and Loading Information placard (▷ page 239).

امداد خودرو فارما

تلفن شبانه روزی: ۰۲۱-۸۸۸۶۲۰۸۵

FarmaSOS.com

		Example 1	Example 2	Example 3
Step 1	Combined weight limit of occupants and cargo from Tire and Loading Information placard	1 500 lbs	1 500 lbs	1 500 lbs

		Example 1	Example 2	Example 3
Step 2	Number of occupants (driver and passengers)	5	3	1
	Seating configuration	front: 2 rear: 3	front: 1 rear: 2	front: 1
	Occupants weight	Occupant 1: 150 lbs Occupant 2: 180 lbs Occupant 3: 160 lbs Occupant 4: 140 lbs Occupant 5: 120 lbs	Occupant 1: 200 lbs Occupant 2: 190 lbs Occupant 3: 150 lbs	Occupant 1: 150 lbs
	Combined weight of all occupants	750 lbs	540 lbs	150 lbs

		Example 1	Example 2	Example 3
Step 3	Available cargo/ luggage and trailer tongue weight (total load limit from Tire and Loading Information placard minus combined weight of all occupants)	1 500 lbs - 750 lbs = 750 lbs	1 500 lbs - 540 lbs = 960 lbs	1 500 lbs - 150 lbs = 1 350 lbs

The higher the weight of all occupants, the less cargo and luggage load capacity is available.

For more information, see “Trailer tongue load” (> page 242).

Certification label

Even after careful determination of the combined weight of all occupants, cargo and the trailer tongue load (if applicable) (> page 242) as to not exceed the permissible load limit, you must make sure your vehicle never exceeds the Gross Vehicle

Weight Rating (GVWR) and the Gross Axle Weight Rating (GAWR) for either the front or rear axle. You can obtain the GVWR and GAWR from the certification label. The certification label can be found on the driver's door B-pillar, see the "Technical data" section (▷ page 332).

Gross Vehicle Weight Rating (GVWR): The total weight of the vehicle, all occupants, all cargo, and the trailer tongue load (if applicable) must never exceed the GVWR.

Gross Axle Weight Rating (GAWR): The total allowable weight that can be carried by a single axle (front or rear).

To assure that your vehicle does not exceed the maximum permissible weight limits (GVWR and GAWR for front and rear axle), have the loaded vehicle (including driver, passengers and all cargo and, if applicable, trailer fully loaded) weighed on a suitable commercial scale.

Trailer tongue load

The tongue load of any trailer is an important weight to measure because it affects the load you can carry in your vehicle. If a trailer is towed, the tongue load must be added to the weight of all occupants riding and any cargo you are carrying in the vehicle. The tongue load typically is 10% of the trailer weight and everything loaded in it.

Your Mercedes-Benz has been designed primarily to carry passengers and their cargo. Mercedes-Benz does not recommend trailer towing with your vehicle.

Maximum tire load

Warning!

Do not overload the tires by exceeding the specified load limit as indicated on the Tire and Loading Information placard on the driver's door B-pillar. Overloading the tires can overheat them, possibly causing a blowout. Overloading the tires can also result

in handling or steering problems, or brake failure.



i For illustration purposes only. Actual data on tires are specific to each vehicle and may vary from data shown in above illustration.

The maximum tire load rating ① is the maximum weight the tires are designed to support.

For more information on tire load rating, see (▷ page 247).

For information on calculating total and cargo load capacities, see (▷ page 239).

Direction of rotation

Unidirectional tires offer added advantages, such as better hydroplaning performance. To benefit, however, you must make sure the tires rotate in the direction specified.

An arrow on the sidewall indicates the intended direction of rotation of the tire.

Spare wheels may be mounted against the direction of rotation (spinning) even with a unidirectional tire for temporary use only until the regular drive wheel has been repaired or replaced. Always observe and follow applicable temporary use restrictions and speed limitations indicated on the spare wheel.

Tire care and maintenance

Warning!

Regularly check the tires for damage. Damaged tires can cause tire inflation pressure loss. As a result, you could lose control of your vehicle.

Worn, old tires can cause accidents. If the tire tread is worn to minimum tread depth, or if the tires have sustained damage, replace them.

Check the tire inflation pressure at least once a month. For more information on checking tire inflation pressure, see “Recommended tire inflation pressure” (▷ page 230).

Tire inspection

Every time you check the tire inflation pressure, you should also inspect your tires for the following:

- excessive treadwear (▷ page 243)
- cord or fabric showing through the tire’s rubber
- bumps, bulges, cuts, cracks or splits in the tread or side of the tire

Replace the tire if you find any of the above conditions.

Make sure you also inspect the spare tire periodically for condition and inflation. Spare tires will age and become worn over time even if never used, and thus should be inspected and replaced when necessary.

Life of tire

Warning!

Tires and spare tire should be replaced after 6 years, regardless of the remaining tread.

The service life of a tire is dependent upon varying factors including but not limited to:

- Driving style
- Tire inflation pressure
- Distance driven

Tread depth

Warning!

Although the applicable federal motor vehicle safety laws consider a tire to be worn when the treadwear indicators (TWI) become visible at approximately $\frac{1}{16}$ in (1.6 mm), we recommend that you do not allow your tires to wear down to that level. As tread depth approaches $\frac{1}{8}$ in (3 mm), the adhesion properties on a wet road are sharply reduced. Depending upon the weather and/or road surface (conditions), the tire traction varies widely.

Do not allow your tires to wear down too far. Adhesion properties on wet roads are sharply reduced at tread depths of less than $\frac{1}{8}$ in (3 mm).

Treadwear indicators (TWI) are required by law. These indicators are located in six places on the tread circumference and become visible at a tread depth of approximately $\frac{1}{16}$ in (1.6 mm), at which point the tire is considered worn and should be replaced.

The recommended minimum tire tread depth for summer tires is $\frac{1}{8}$ in (3 mm). The recommended minimum tire tread depth for winter tires is $\frac{1}{6}$ in (4 mm).

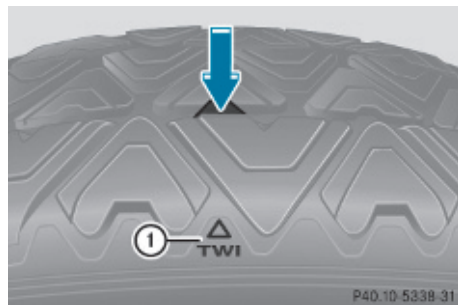

Treadwear indicator ① appears as a solid band across the tread.

Storing tires

I Keep unmounted tires in a cool, dry place with as little exposure to light as possible. Protect tires from contact with oil, grease and fuels.

Cleaning tires

I Never use a round nozzle to power wash tires. The intense jet of water can result in damage to the tire.

Always replace a damaged tire.

Uniform Tire Quality Grading Standards

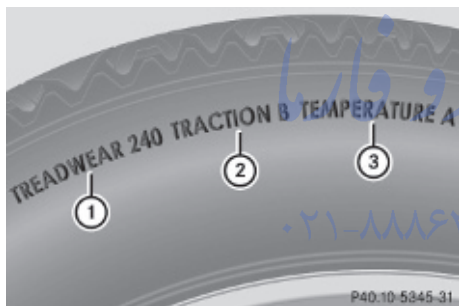

The Uniform Tire Quality Grading is a U.S. Government requirement designed to give drivers consistent and reliable information regarding tire performance. Tire manufacturers are required to grade tires based on three performance factors: treadwear ①, traction ②, and temperature resistance ③. Although not a Government of Canada requirement, all tires made for sale in North America have these grades branded on the sidewall.

i For illustration purposes only. Actual data on tires are specific to each vehicle and may vary from data shown in above illustration.

Quality grades can be found, where applicable, on the tire sidewall between tread shoulder and maximum section width. For example:

Treadwear	Traction	Temperature
200	AA	A

All passenger car tires must conform to federal safety requirements in addition to these grades.

Treadwear

The treadwear grade is a comparative rating based on the wear rate of the tire when tested under controlled conditions on a specified U.S. Government test course. For example, a tire graded 150 would wear one and one-half ($1\frac{1}{2}$) times as well on the government course as a tire graded 100.

The relative performance of tires depends upon the actual conditions of their use, however, and may depart significantly from the norm due to variations in driving habits, service practices and differences in road characteristics and climate.

Traction تلفن شبانه ۰۲۱-۸۸۶۲۰۸۸

Warning!

The traction grade assigned to this tire is based on straight-ahead braking traction tests, and does not include acceleration, cornering, hydroplaning, or peak traction characteristics.

The traction grades, from highest to lowest, are AA, A, B, and C. Those grades represent the tire's ability to stop on wet pavement as measured under controlled conditions on specified government test surfaces of asphalt and concrete. A tire marked C may have poor traction performance.

Warning!

If ice has formed on the road, tire traction will be substantially reduced. Under such weather conditions, drive, steer and brake with extreme caution.

The safe speed on a wet, snow covered or icy road is always lower than on a dry road.

You should pay particular attention to the condition of the road whenever the outside temperature is close to the freezing point.

Mercedes-Benz recommends winter tires (▷ page 252) with a minimum tread depth of approximately $\frac{1}{6}$ in (4 mm) on all four wheels for the winter season to ensure normal balanced handling characteristics. On packed snow, they can reduce your stopping distance compared to summer tires.

Stopping distance, however, is still considerably greater than when the road is not covered with snow or ice. Exercise appropriate caution.

! Avoid spinning of a drive wheel. This may cause serious damage to the drivetrain which is not covered by the Mercedes-Benz Limited Warranty.

Temperature

Warning!

The temperature grade for this tire is established for a tire that is properly inflated and not overloaded. Excessive speed, underinflation, or excessive loading, either separately or in combination, can cause excessive heat build-up and possible tire failure.

The temperature grades are A (the highest), B, and C, representing the tire's resistance to the generation of heat and its ability to dissipate heat when tested under controlled conditions on a specified indoor laboratory test wheel. Sustained high temperature can cause the material of the tire to degenerate and reduce tire life, and excessive temperature can lead to sudden tire failure. The grade C corresponds to a level of performance which all passenger car tires must meet under the Federal Motor Vehicle Safety Standard No. 109. Grades B and A represent higher levels of performance on the

laboratory test wheel than the minimum required by law.

Rotating tires

Warning!

Rotate front and rear wheels only if the tires are of the same dimension.

If your vehicle is equipped with mixed-size tires (different tire dimensions front vs. rear), tire rotation is not possible.

Warning!

Have the tightening torque checked after changing a wheel. Wheels could become loose if not tightened with a torque of 96 lb-ft (130 Nm).

Only use genuine Mercedes-Benz wheel bolts specified for your vehicle's rims.

Tire rotation can be performed on vehicles with tires of the same dimension all around. If your vehicle is equipped with tires of the same dimension all around, tires can be rotated, observing a front-to-rear rotation pattern that will maintain the intended rotation (spinning) direction of the tire (▷ page 242).

In some cases, such as when your vehicle is equipped with mixed-size tires (different tire dimension front vs. rear), tire rotation is not possible.

If applicable to your vehicle's tire configuration, tires can be rotated according to the tire manufacturer's recommended intervals in the tire manufacturer's warranty pamphlet located in your vehicle literature portfolio. If none is available, tires should be rotated every 3 000 to 6 000 miles (5 000 to 10 000 km), or sooner if necessary, according to the degree of tire wear. The same rotation (spinning) direction must be maintained.

Rotate tires before the characteristic tire wear pattern becomes visible (shoulder wear on front tires and tread center wear on rear tires).

Thoroughly clean the mounting face of wheels and brake disks, i.e. the inner side of the wheels/tires, during each rotation. Check for and ensure proper tire inflation pressure.

For information on wheel change, see “Flat tire” (▷ page 317).

Tire labeling

Besides tire name (sales designation) and manufacturer name, a number of markings can be found on a tire.

Following are some explanations for the markings on your vehicle's tires:

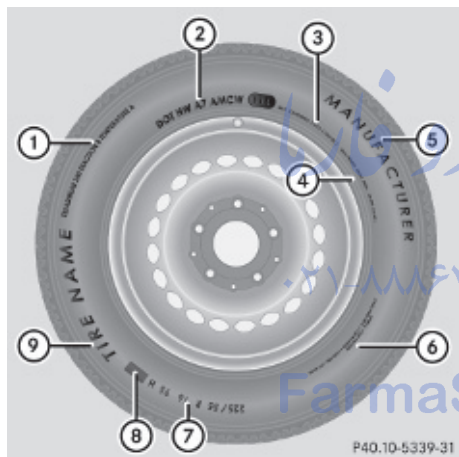

- ① Uniform Tire Quality Grading Standards (▷ page 244)
- ② DOT, Tire Identification Number (▷ page 249)
- ③ Maximum tire load (▷ page 242)
- ④ Maximum tire inflation pressure (▷ page 237)
- ⑤ Manufacturer
- ⑥ Tire ply material (▷ page 250)
- ⑦ Tire size designation, load and speed rating (▷ page 246)
- ⑧ Load identification (▷ page 249)
- ⑨ Tire name

i For illustration purposes only. Actual data on tires are specific to each vehicle and may vary from data shown in above illustration.

For more information, see “Rims and tires” (▷ page 344).

Tire size designation, load and speed rating

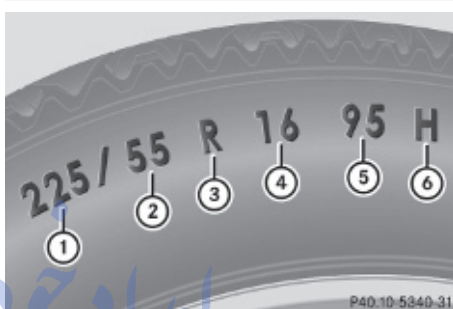

- ① Tire width
- ② Aspect ratio in %
- ③ Radial tire code
- ④ Rim diameter
- ⑤ Load index
- ⑥ Speed symbol

i For illustration purposes only. Actual data on tires are specific to each vehicle and may vary from data shown in above illustration.

General: Depending on the design standards used, the tire size molded into the sidewall may have no letter or a letter preceding the tire size designation.

No letter preceding the size designation (as illustrated above): Passenger car tire based on European design standards.

Letter “P” preceding the size designation: Passenger car tire based on U.S. design standards.

Letter “LT” preceding the size designation: Light Truck tire based on U.S. design standards.

Letter “T” preceding the size designation: Temporary spare tires which are high pressure compact spares designed for temporary emergency use only.

Tire width

Tire width ① indicates the nominal tire width in millimeters.

Aspect ratio

Aspect ratio ② is the dimensional relationship between tire section height and section width and is expressed in percentage. The aspect ratio is arrived at by dividing section height by section width.

Tire code

Tire code ③ indicates the tire construction type. The “R” stands for radial tire type. Letter “D” means diagonal or bias ply construction; letter “B” means belted-bias ply construction.

At the tire manufacturer’s option, any tire with a speed capability above 149 mph (240 km/h) can include a “ZR” in the size designation (for example: 245/40 ZR 18). For additional information, see “Tire speed rating” (▷ page 247).

Rim diameter

Rim diameter ④ is the diameter of the bead seat, not the diameter of the rim edge. The rim diameter is indicated in inches (in).

Load index

Warning!

The tire load rating must always be at least half of the GAWR of your vehicle. Otherwise, tire failure may be the result which may cause an accident and/or serious injury to you or others.

Always replace rims and tires with the same designation, manufacturer and type as shown on the original part.

Warning!

Do not overload the tires by exceeding the specified load limit as indicated on the Tire

and Loading Information placard on the driver’s door B-pillar. Overloading the tires can overheat them, possibly causing a blowout. Overloading the tires can also result in handling or steering problems, or brake failure.

Load index ⑤ is a numerical code associated with the maximum load a tire can support.

For example, a load rating of 91 corresponds to a maximum load of 1356 lb (615 kg) the tire is designed to support. See also “Maximum tire load” (▷ page 242) where the maximum load associated with the load index is indicated in kilograms and lbs.

For additional information on the load index, see “Load identification” (▷ page 249).

Speed symbol

Warning!

Even when permitted by law, never operate a vehicle at speeds greater than the maximum speed rating of the tires.

Exceeding the maximum speed for which tires are rated can lead to sudden tire failure, causing loss of vehicle control and possibly resulting in an accident and/or serious personal injury and possible death, for you and for others.

Regardless of the tire speed rating, local speed limits should be obeyed. Use prudent driving speeds appropriate to prevailing conditions.

Speed symbol ⑥ indicates the approved maximum speed (tire speed rating) for the tire.

Summer tires

Index	Speed rating
Q	up to 100 mph (160 km/h)
R	up to 106 mph (170 km/h)
S	up to 112 mph (180 km/h)
T	up to 118 mph (190 km/h)

Index	Speed rating
H	up to 130 mph (210 km/h)
V	up to 149 mph (240 km/h)
W	up to 168 mph (270 km/h)
Y	up to 186 mph (300 km/h)
ZR...Y	up to 186 mph (300 km/h)
ZR...(Y)	above 186 mph (300 km/h)
ZR	above 149 mph (240 km/h)

- At the tire manufacturer's option, any tire with a speed capability above 149 mph (240 km/h) can include a "ZR" in the size designation (for example: 245/40 ZR18). To determine the maximum speed capability of the tire, the service description for the tire must be referred to. The service description is comprised of load index (5) and speed symbol (6).

If your tire includes "ZR" in the size designation and no service description is given, the tire manufacturer must be consulted for the maximum speed capability.

If a service description is given, the speed capability is limited by the speed symbol in the service description. Example: 245/40 ZR18 97Y. In this example, "97Y" is the service description. The letter "Y" designates the speed rating and the speed capability of the tire is limited to 186 mph (300 km/h).

- Any tire with a speed capability above 186 mph (300 km/h) must include a "ZR" in the size designation AND the service description must be placed in parenthesis. Example: 275/40 ZR 18 (99Y). The "(Y)" speed symbol in parenthesis designates the maximum speed capability of the tire as being above 186 mph (300 km/h).

Consult the tire manufacturer for the actual maximum permissible speed of the tire.

All-season and winter tires

Index	Speed rating
Q M+S ¹⁸	up to 100 mph (160 km/h)
T M+S ¹⁸	up to 118 mph (190 km/h)
H M+S ¹⁸	up to 130 mph (210 km/h)
V M+S ¹⁸	up to 149 mph (240 km/h)

- i** Not all M+S rated tires provide special winter performance. Make sure the tires you use show M+S and the mountain/snowflake  marking on the tire sidewall. These tires meet specific snow traction performance requirements of the Rubber Manufacturers Association (RMA) and the Rubber Association of Canada (RAC) and have been designed specifically for use in snow conditions.

An electronic speed limiter prevents your vehicle from exceeding a speed of:

- All models except C 63 AMG: 130 mph (210 km/h)
- C 63 AMG: 155 mph (250 km/h)
- C 63 AMG with increased top speed: 174 mph (280 km/h)

The factory equipped tires on your vehicle may have a tire speed rating above the maximum speed permitted by the electronic speed limiter.

Make sure your tires have the required tire speed rating as specified for your vehicle in the "Technical data" section (▷ page 344), for example when purchasing new tires.

If you are uncertain about the correct reading of the information given on a tire's sidewall, any authorized Mercedes-Benz Center will be glad to assist you.

Load identification



i For illustration purposes only. Actual data on tires are specific to each vehicle and may vary from data shown in above illustration.

In addition to the load index, special load identification ① may be molded into the tire sidewall following the letter designating the speed symbol ⑥ (▷ page 246).

- No specification given: absence of any text (like in above example) indicates a standard load (SL) tire.
- XL or Extra Load: designates an extra load (or reinforced) tire.
- Light Load: designates a light load tire.
- C, D, E: designates load range associated with the maximum load a tire can carry at a specified pressure.

DOT, Tire Identification Number (TIN)

U.S. tire regulations require each new tire manufacturer or tire retreader to mold a TIN into or onto a sidewall of each tire produced.

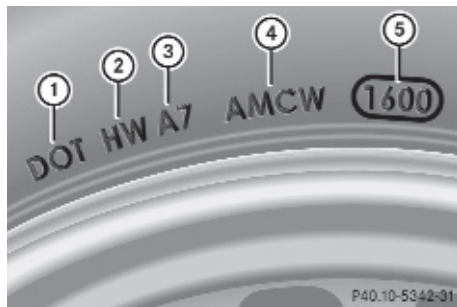

The TIN is a unique identifier. The TIN facilitates efforts by tire manufactures to notify purchasers in recall situations or other safety matters concerning tires. It gives purchasers the means to easily identify such tires.

The TIN is comprised of “Manufacturer’s identification mark” ②, “Tire size” ③, “Tire type code” ④ and “Date of manufacture” ⑤.

i For illustration purposes only. Actual data on tires are specific to each vehicle and may vary from data shown in above illustration.

DOT (Department of Transportation)

Tire branding symbol ① denotes that the tire meets requirements of the U.S. Department of Transportation.

Manufacturer’s identification mark

Manufacturer’s identification mark ② denotes the tire manufacturer.

New tires have a mark with two symbols.

Retreaded tires have a mark with four symbols. For more information on retreaded tires, see (▷ page 229).

Tire size

Code ③ indicates the tire size.

P40.10-5341-31

P40.10-5342-31

Tire type code

Tire type code ④ may, at the option of the manufacturer, be used as a descriptive code for identifying significant characteristics of the tire.

Date of manufacture

The date of manufacture ⑤ identifies the week and year of manufacture.

The first two figures identify the week, starting with "01" to represent the first full week of the calendar year. The second two figures represent the year.

For example, "3208" represents the 32nd week of 2008.

Tire ply material



i For illustration purposes only. Actual data on tires are specific to each vehicle and may vary from data shown in above illustration.

This marking tells you about the type of cord and number of plies in the sidewall ① and under the tread ②.

Tire and loading terminology

Accessory weight

The combined weight (in excess of those standard items which may be replaced) of automatic transmission, power steering, power brakes, power windows, power seats,

radio, and heater, to the extent that these items are available as factory-installed equipment (whether installed or not).

Air pressure

The amount of air inside the tire pressing outward on each square inch of the tire. Air pressure is expressed in pounds per square inch (psi), kilopascal (kPa), or bar.

Aspect ratio

Dimensional relationship between tire section height and section width expressed in percentage.

Bar

Metric unit for air pressure. There are 14.5038 pounds per square inch (psi) to 1 bar; there are 100 kilopascals (kPa) to 1 bar.

Bead

The tire bead contains steel wires wrapped by steel cords that hold the tire onto the rim.

Cold tire inflation pressure

Tire inflation pressure when your vehicle has been sitting for at least 3 hours or driven no more than 1 mile (1.6 km).

Curb weight

The weight of a motor vehicle with standard equipment including the maximum capacity of fuel, oil, and coolant, and, if so equipped, air conditioning and additional optional equipment, but without passengers and cargo.

DOT (Department of Transportation)

A tire branding symbol which denotes the tire meets requirements of the U.S. Department of Transportation.

GAWR (Gross Axle Weight Rating)

The GAWR is the maximum permissible axle weight. The gross vehicle weight on each axle must never exceed the GAWR for the front and rear axle indicated on the certification label located on the driver's door B-pillar.

GVW (Gross Vehicle Weight)

The GVW comprises the weight of the vehicle including fuel, tools, spare wheel, installed accessories, passengers and cargo and, if applicable, trailer tongue load. The GVW must never exceed the GVWR indicated on the certification label located on the driver's door B-pillar.

GVWR (Gross Vehicle Weight Rating)

This is the maximum permissible vehicle weight of the fully loaded vehicle (weight of the vehicle including all options, passengers, fuel, and cargo and, if applicable, trailer tongue load). It is indicated on the certification label located on the driver's door B-pillar.

Kilopascal (kPa)

Metric unit for air pressure. There are 6.9 kPa to 1 psi; another metric unit for air pressure is bar. There are 100 kilopascals (kPa) to 1 bar.

Load index

Numerical code associated with the maximum load a tire can support.

Maximum load rating

The maximum load in kilograms and pounds that can be carried by the tire.

Maximum loaded vehicle weight

The sum of curb weight, accessory weight, total load limit, and production options weight.

Maximum permissible tire inflation pressure

This number is the greatest amount of air pressure that should ever be put in the tire.

Normal occupant weight

The number of occupants the vehicle is designed to seat, multiplied by 68 kilograms (150 lb).

Occupant distribution

The distribution of occupants in a vehicle at their designated seating positions.

Production options weight

The combined weight of those installed regular production options weighing over 5 lbs (2.3 kilograms) in excess of those standard items which they replace, not previously considered in curb weight or accessory weight, including heavy duty brakes, ride levelers, roof rack, heavy duty battery, and special trim.

PSI (Pounds per square inch)

A standard unit of measure for air pressure.

Recommended tire inflation pressure

The recommended tire inflation pressure for normal driving conditions is listed on the Tire and Loading Information placard located on the driver's door B-pillar. It provides best handling, tread life and riding comfort. Supplemental information pertaining to special driving situations can be found on the tire inflation pressure label on the inside of the fuel filler flap.

Rim

A metal support for a tire or a tire and tube assembly upon which the tire beads are seated.

Sidewall

The portion of a tire between the tread and the bead.

TIN (Tire Identification Number)

Unique identifier which facilitates efforts by tire manufacturers to notify purchasers in recall situations or other safety matters concerning tires and gives purchasers the means to easily identify such tires. The TIN is comprised of “Manufacturer’s identification mark”, “Tire size”, “Tire type code” and “Date of manufacture”.

Tire ply composition and material used

This indicates the number of plies or the number of layers of rubber-coated fabric in the tire tread and sidewall. Tire manufacturers also must indicate the ply materials in the tire and sidewall, which include steel, nylon, polyester, and others.

Tire speed rating

Part of tire designation (speed symbol); indicates the speed range for which a tire is approved.

Total load limit

Rated cargo and luggage load plus 68 kilograms (150 lb) times the vehicle’s designated seating capacity.

Traction

The adhesive friction of a tire on a surface on which it moves. The amount of grip provided.

Tread

The portion of a tire that comes into contact with the road.

Treadwear indicators

Narrow bands, sometimes called “wear bars” that show across the tread of a tire when only $\frac{1}{16}$ in (1.6 mm) of tread remains.

Uniform Tire Quality Grading Standards

A tire information system that provides consumers with ratings for a tire’s traction, temperature and treadwear. Ratings are determined by tire manufacturers using U.S. government testing procedures. The ratings are molded into the sidewall of the tire.

Vehicle maximum load on the tire

Load on an individual tire that is determined by distributing to each axle its share of the maximum loaded vehicle weight and dividing it by two.

Winter driving

General information

Have your vehicle winterized at an authorized Mercedes-Benz Center.

Winter tires

Warning!

Winter tires with a tread depth of less than $\frac{1}{6}$ in (4 mm) must be replaced. They are no longer suitable for winter operation.

Warning!

If you use your spare wheel when winter tires are fitted on the other wheels, be aware that the difference in tire characteristics may very well impair turning stability and that overall driving stability may be reduced. Adapt your driving style accordingly.

Have the spare wheel replaced by a regular road wheel with a winter tire at the nearest authorized Mercedes-Benz Center.

Always use winter tires at temperatures below 45°F (7°C) and whenever wintry road conditions prevail. Not all M+S rated tires provide special winter performance. Make sure the tires you use show the mountain/snowflake  marking on the tire sidewall. These tires meet specific snow traction performance requirements of the Rubber Manufacturers Association (RMA) and the Rubber Association of Canada (RAC) and have been designed specifically for use in snow conditions. Use of winter tires is the only way to achieve the maximum effectiveness of your vehicle's driving safety systems such as the ABS and the ESP® in winter operation.

For safe handling, make sure all mounted winter tires are of the same make and have the same tread design.

For information on winter tires for your vehicle model, see the "Technical data" section (▷ page 344).

Always observe the speed rating of the winter tires installed on your vehicle.

After installing winter tires:

- ▶ Check the tire inflation pressure and adjust it if necessary (▷ page 232).
- ▶ Restart the tire pressure loss warning system (▷ page 233) or the Advanced Tire Pressure Monitoring System (▷ page 234).

Snow chains

! Some tire sizes do not leave adequate clearance for snow chains. To help avoid serious damage to your vehicle or tires, make sure the use of snow chains is permissible as specified in the "Technical data" section of this Operator's Manual.

Snow chains should only be driven on snow-covered roads at speeds not to exceed 30 mph (50 km/h). Remove chains as soon as possible when driving on roads without snow.

Observe the following guidelines when using snow chains:

- Use of snow chains is not permissible with all wheel/tire combinations (▷ page 344).
- Use snow chains in pairs and on rear wheels only. Follow the manufacturer's mounting instructions.

! If snow chains are mounted to the front wheels, they may scrape against the body or axle components. The tires or the vehicle could be damaged as a result.

- Only use snow chains that are approved by Mercedes-Benz. Any authorized Mercedes-Benz Center will be glad to advise you on this subject.
- Use of snow chains may be prohibited depending on location. Always check local and state laws before installing snow chains.
- Do not use snow chains on the spare wheel.

i When driving with snow chains, you may wish to switch off the ESP® (▷ page 62) before setting the vehicle in motion. This will improve the vehicle's traction.

Winter driving instructions

Warning!

If the vehicle becomes stuck in snow, make sure snow is kept clear of the exhaust pipe and from around the vehicle with the engine running. Otherwise, deadly carbon monoxide (CO) gases may enter vehicle interior resulting in unconsciousness and death.

To assure sufficient fresh air ventilation, open a window slightly on the side of the vehicle not facing the wind.

Warning!

The outside temperature indicator is not designed to serve as an ice-warning device and is therefore unsuitable for that purpose.

Indicated temperatures just above the freezing point do not guarantee that the road surface is free of ice. The road may still be icy, especially in wooded areas or on bridges.

Warning!

On slippery road surfaces, never downshift in order to obtain braking action. This could result in drive wheel slip and reduced vehicle control. Your vehicle's ABS will not prevent this type of loss of control.

The most important rule for slippery or icy roads is to drive sensibly and to avoid abrupt acceleration, braking and steering maneuvers. Do not use the cruise control system under such conditions.

When the vehicle is in danger of skidding, shift the automatic transmission to neutral position **N** or declutch in case of manual transmission. Try to keep the vehicle under control by corrective steering action.

i For information on driving with snow chains, see "Snow chains" (> page 253).

Road salts and chemicals can adversely affect braking efficiency. Increased pedal force may become necessary to produce the normal brake effect.

Depressing the brake pedal periodically when traveling at length on salt-strewn roads can bring road-salt-impaired braking efficiency back to normal.

If the vehicle is parked after being driven on salt-treated roads, the braking efficiency should be tested as soon as possible after driving is resumed.

Warning!

Make sure not to endanger any other road users when carrying out these braking maneuvers.

Driving instructions

Drive sensibly – save fuel

To save fuel you should:

- Keep tires at the recommended inflation pressures.
- Remove unnecessary loads.
- Remove roof rack when not in use.
- Allow engine to warm up under low load use.
- Avoid frequent acceleration and deceleration.
- Have all maintenance work performed at the intervals specified in the Maintenance Booklet and as required by the Maintenance system. Contact an authorized Mercedes-Benz Center.

Fuel consumption is also increased by driving in cold weather, in stop-and-go traffic, on short trips and in mountainous areas.

Drinking and driving

Warning!

Drinking and driving and/or taking drugs and driving are very dangerous combinations. Even a small amount of alcohol or drugs can affect your reflexes, perceptions and judgment.

The possibility of a serious or even fatal accident are greatly increased when you drink or take drugs and drive.

Do not drink or take drugs and drive or allow anyone to drive who has been drinking or taking drugs.

Pedals

Warning!

Make sure absolutely no objects are obstructing the pedals' range of movement. Keep the driver's footwell clear of all

obstacles. If there are any floor mats or carpets in the footwell, make sure that the pedals still have sufficient clearance. During sudden driving or braking maneuvers, the objects could get caught between the pedals. You could then no longer brake or accelerate. This could lead to accidents and injury.

Power assistance

Warning!

There is no power assistance for the steering and the brake when the engine is not running. Steering and braking requires significantly more effort and you could lose control of the vehicle and cause an accident as a result. Do not turn off the engine while the vehicle is in motion.

Brakes

Downhill grades

! When driving down long and steep grades, relieve the load on the brakes by shifting into a lower gear to use the engine's braking power. This helps prevent overheating of the brakes and reduces wear.

When using the engine's braking power, a drive wheel may not spin for an extended period of time, e.g. on slippery road surfaces. This may cause serious damage to the drivetrain which is not covered by the Mercedes-Benz Limited Warranty.

Continuous or hard braking

Warning!

Resting your foot on the brake pedal will cause excessive and premature wear of the brake pads.

It can also result in the brakes overheating, thereby significantly reducing their effectiveness. It may not be possible to stop the vehicle in sufficient time to avoid an accident.

After hard braking, it is advisable to drive on for some time, rather than immediately park, so that the air stream will cool down the brakes faster.

Wet roads

Warning!

After driving in heavy rain for some time without applying the brakes or through water deep enough to wet brake components, the first braking action may be somewhat reduced and increased pedal pressure may be necessary to obtain expected brake effect. Maintain a safe distance from vehicles in front.

To help prevent brake disk corrosion after driving on wet or salt-covered roads, it is advisable to brake the vehicle with considerable force prior to parking. The heat generated serves to dry the brakes.

Salt-covered roads

Warning!

A layer of salt on the brake discs and the brake linings may cause a delay in the braking effect, resulting in a significantly increased braking distance, which could lead to an accident.

To avoid this danger, you should:

- occasionally brake carefully when you are driving on salt-covered roads, so that any layer of salt that may have built up on the brake discs and the brake linings is

removed without putting other road users at risk

- maintain a greater distance to the vehicle ahead and drive with particular care
- carefully apply the brakes at the end of a trip and immediately after commencing a new trip, so that salt residues are removed from the brake disc

Brake service

! The brake fluid level in the reservoir may be too low if the red brake warning lamp in the instrument cluster comes on while the engine is running and an acoustic warning sounds. Observe additional messages in the multifunction display that may appear. Brake pad wear or a leak in the system may be the reason for low brake fluid in the reservoir.

Have the brake system inspected immediately. Contact an authorized Mercedes-Benz Center.

All checks and service work on the brake system should be carried out by qualified technicians only. Contact an authorized Mercedes-Benz Center.

Only install brake pads and use brake fluid recommended by Mercedes-Benz.

Warning!

If other than recommended brake pads are installed, or other than recommended brake fluid is used, the braking properties of the vehicle can be degraded to an extent that safe braking is substantially impaired. This could result in an accident.

! Vehicles with 4MATIC:

Only conduct operational or performance tests on a two-axle dynamometer. If such tests are necessary, contact an authorized Mercedes-Benz Center. You could otherwise seriously damage the brake system or the transfer case which is not

covered by the Mercedes-Benz Limited Warranty.

! Vehicles with 4MATIC:

Because the ESP® operates automatically, the engine and ignition must be shut off (SmartKey in starter switch position **0** or **1** or KEYLESS-GO start/stop button in position **0** or **1**) when the parking brake is being tested on a brake test dynamometer. Active braking action through the ESP® may otherwise seriously damage the brake system which is not covered by the Mercedes-Benz Limited Warranty.

! Vehicles without 4MATIC:

Because the ESP® operates automatically, the engine and ignition must be shut off (SmartKey in starter switch position **0** or **1** or KEYLESS-GO start/stop button in position **0** or **1**) when the parking brake is being tested on a brake test dynamometer or the vehicle is being towed with the front axle raised.

Active braking action through the ESP® may otherwise seriously damage the brake system which is not covered by the Mercedes-Benz Limited Warranty.

If your brake system is only subjected to moderate loads, you should occasionally test the effectiveness of the brakes by applying above-normal braking pressure at higher speeds. This will also enhance the grip of the brake pads.

Warning!

Make sure not to endanger any other road users when carrying out these braking maneuvers.

Refer to the description of the Brake Assist System (BAS) (▷ page 61).

High-performance brake system

The high-performance brake system is only available on C 63 AMG.

Warning!

New vehicle brake pads and discs, and replacement brake pads and discs may take several hundred miles of driving until they provide optimum braking efficiency. Until that time, you may need to use increased brake pedal pressure while braking. Please be aware of this and adjust your driving and braking accordingly during this break-in period.

Excessive high-demand braking will cause correspondingly high brake wear. Please be attentive to the brake warning lamp in the instrument cluster and brake condition messages in the multifunction display. Especially for high performance driving, it is important to maintain and have the brake system checked regularly.

The high-performance brake system is designed to operate under the extremely high operating demands required to accommodate the performance capabilities of the vehicle.

The brakes may produce a squeaking-type noise depending on the

- vehicle speed
- brake force applied
- ambient conditions, e.g. temperature and humidity

As with any brake system, the wear of individual brake system components such as brake pads or disks strongly depends on your driving style and the conditions under which you operate the vehicle. Thus, a driving style calling for high-demand braking will cause your vehicle's brakes to wear more quickly.

Driving off

Warm up the engine smoothly. Do not place full load on the engine until the operating temperature has been reached.

- !** When driving off on a slippery surface, do not allow a drive wheel to spin for an

extended period with the ESP® switched off. Doing so may cause serious damage to the drivetrain which is not covered by the Mercedes-Benz Limited Warranty.

- !** Simultaneously depressing the accelerator pedal and applying the brakes reduces engine performance and causes premature brake and drivetrain wear which is not covered by the Mercedes-Benz Limited Warranty.

Hydroplaning

Depending on the depth of the water layer on the road, hydroplaning may occur, even at low speeds and with new tires. In heavy rain or when conditions indicate possible hydroplaning:

- ▶ Reduce vehicle speed.
- ▶ Avoid track grooves in the road.
- ▶ Apply brakes cautiously.

Standing water

- !** Do not drive through flooded areas. Before driving through water, determine its depth.

If you must drive through standing water, drive slowly to prevent water from entering the passenger compartment or the engine compartment. Water in these areas could cause damage to electrical components or wiring of the engine or transmission, or could result in water being ingested by the engine through the air intake causing severe internal engine damage. Any such damage is not covered by the Mercedes-Benz Limited Warranty.

Driving abroad

If you plan to drive the vehicle outside the U.S. or Canada, you should request dealer

network information for your destination from any authorized Mercedes-Benz Center.

Control and operation of radio transmitter

Safety notes

Warning!

Please do not forget that your primary responsibility is to drive the vehicle. A driver's attention to the road must always be his/her primary focus when driving. For your safety and the safety of others, we recommend that you pull over to a safe location and stop before placing or taking a telephone call.

If you choose to use the telephone¹⁹ while driving, please use the hands-free device and only use the telephone when road, weather and traffic conditions permit. Some jurisdictions prohibit the driver from using a mobile telephone while driving a vehicle.

Only operate the audio system or COMAND¹⁹ (Cockpit Management and Data System) if road, weather and traffic conditions permit. Otherwise, you may not be able to observe traffic conditions and could endanger yourself and others.

Bear in mind that at a speed of just 30 mph (approximately 50 km/h), your vehicle is covering a distance of 44 feet (approximately 14 m) every second.

Emission control

Certain systems of the engine serve to keep the toxic components of the exhaust gases within permissible limits required by law. These systems will function properly only when maintained strictly according to factory specifications. Any adjustments on the engine should, therefore, be carried out only by qualified Mercedes-Benz Center authorized technicians.

Engine adjustments should not be altered in any way. Moreover, the specified service procedures must be carried out regularly according to Mercedes-Benz servicing requirements. For details refer to the Maintenance Booklet.

Warning!

Inhalation of exhaust gas is hazardous to your health. All exhaust gas contains carbon monoxide (CO), and inhaling it can cause unconsciousness and possible death.

Do not run the engine in confined areas (such as a garage) which are not properly ventilated. If you think that exhaust gas fumes are entering the vehicle while driving, have the cause determined and corrected immediately. If you must drive under these conditions, drive only with at least one window fully open at all times.

Maintenance

Notes

The Maintenance System in your vehicle tracks the distance driven and the time elapsed since the last maintenance service. It calculates other maintenance service work required, and calls for the next maintenance service accordingly.

We strongly recommend that you have your vehicle serviced at an authorized Mercedes-Benz Center. Have it serviced in accordance with the Maintenance Booklet at the times called for by the maintenance service indicator.

i Failure to have the vehicle maintained in accordance with the Maintenance Booklet and maintenance service indicator at the designated times/mileage will result in vehicle damage not covered by the Mercedes-Benz Limited Warranty.

¹⁹ Observe all legal requirements.

Maintenance service indicator message

Information on maintenance work and maintenance intervals are specified in the Maintenance Booklet. Contact an authorized Mercedes-Benz Center, or visit

www.mbusa.com (USA only) for additional information.

The maintenance service indicator message will notify you when the next maintenance service is required.

Starting approximately 1 month before the next maintenance service is required, one of the following messages will appear in the multifunction display. The messages will appear while you are driving or when you switch on the ignition (example service A):

Next Service A in XXXX miles (km)

Next Service A in XX days

Service A Due

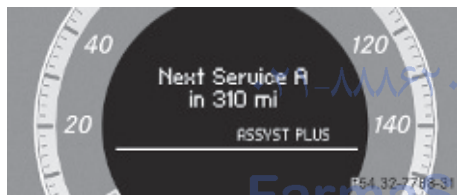



An additional number or a further letter in combination with the maintenance type can be indicated. This indicates that further auxiliary maintenance work is required. Contact an authorized Mercedes-Benz Center for more information.

Clearing the maintenance service indicator message

The maintenance service indicator message is cleared automatically

- after approximately 10 seconds when you switch on the ignition
- after approximately 10 seconds when reaching the service threshold while driving
- after approximately 30 seconds, once the suggested maintenance service term has passed

► **Clearing the maintenance service indicator message manually:** Press button  or button  on the multifunction steering wheel. The standard display appears in the multifunction display.

Maintenance service term exceeded

If you have exceeded the suggested maintenance service term, you will see the following message in the multifunction display:

Service A Exceeded by XXXXX miles (km)

Service A Exceeded by XXX days





In addition, a signal sounds when the message appears.

Any authorized Mercedes-Benz Center will reset the maintenance service indicator following a completed maintenance service.

Calling up the maintenance service indicator display

- ❗ The menu overview can be found on (▷ page 121).

You can call up the maintenance service indicator display at any time to check when the next maintenance service is required.

- ▶ Switch on the ignition.
The standard display of the control system appears (▷ page 121).
- ▶ Press button  or  on the multifunction steering wheel to select the Service menu.
- ▶ Press button  or  to select ASSYST PLUS.
- ▶ Press button  on the multifunction steering wheel to confirm.
The maintenance service indicator display with the maintenance service deadline appears in the multifunction display.

- i** If the battery was disconnected, the days of disconnection will not be included in the count shown by the maintenance service indicator. To arrive at the true maintenance service deadline, you will need to subtract these days from the days shown in the maintenance service indicator message or maintenance service indicator display.

Resetting the maintenance service indicator

In the event that the maintenance service on your vehicle is not carried out at an authorized Mercedes-Benz Center, you can have the maintenance service indicator reset.

The automotive maintenance facility carrying out the maintenance service will find the information for resetting the maintenance service indicator in the maintenance-relevant literature for your vehicle.

Such literature is available at any authorized Mercedes-Benz Center or directly from Mercedes-Benz.

- !** If the maintenance service indicator was reset inadvertently, have an authorized Mercedes-Benz Center correct it.

Only reset the maintenance service indicator if the proper maintenance service has been performed. Not following the proper maintenance service as described in the Maintenance Booklet will result in

engine damage and/or other vehicle damage not covered by the Mercedes-Benz Limited Warranty.

Vehicle care

Cleaning and care of the vehicle

Notes

Regular and proper care will help to maintain the value of your vehicle.

Warning!

Many cleaning products can be hazardous. Some are poisonous, others are flammable. Always follow the instructions on the particular container. Always open your vehicle's doors or windows when cleaning the inside.

Never use fluids or solvents that are not designed for cleaning your vehicle.

Always lock away cleaning products and keep them out of reach of children.

- !** When cleaning the vehicle, do not use scouring agents. Never apply strong force and only use a soft, wet cloth or sponge. Otherwise you may scratch or damage the surface to be cleaned.

While in operation, even while parked, your vehicle is subjected to varying external influences which, if gone unchecked, can attack the paintwork as well as the vehicle underbody and cause lasting damage.

Such damage is caused not only by extreme and varying climatic conditions, but also by:

- Air pollution
- Road salt
- Tar
- Gravel and stone chipping

To avoid paint damage, you should immediately remove:

- Grease and oil
- Fuel
- Coolant
- Brake fluid
- Bird droppings
- Insects
- Tree resins etc.

Frequent washing reduces and/or eliminates the aggressiveness and potency of the above adverse influences.

More frequent washings are necessary to deal with unfavorable conditions:

- near the ocean
- in industrial areas (smoke, exhaust emissions)
- during winter operation

You should check your vehicle from time to time for stone chipping or other damage. Any damage should be repaired as soon as possible to prevent corrosion.

In doing so, do not neglect the underbody of the vehicle. A prerequisite for a thorough check is a washing of the underbody followed by a thorough inspection. Damaged areas need to be re-undercoated.

Your vehicle has been treated at the factory with a wax-base rustproofing in the body cavities which will last for the lifetime of the vehicle. Post-production treatment is neither necessary nor recommended by Mercedes-Benz because of the possibility of incompatibility between materials used in the production process and others applied later. We have selected vehicle-care products and compiled recommendations which are specially matched to our vehicles and which always reflect the latest technology. You can obtain Mercedes-Benz approved vehicle-care products at an authorized Mercedes-Benz Center.

Scratches, corrosive deposits, corrosion or damage due to negligent or incorrect care cannot always be removed or repaired with the vehicle-care products recommended here. In such cases it is best to seek aid at an authorized Mercedes-Benz Center.

The following topics deal with the cleaning and care of your vehicle and give important “how-to” information as well as references to Mercedes-Benz approved vehicle-care products.

Power washer

! Follow the instructions provided by the power washer manufacturer on maintaining a distance between the vehicle and the nozzle of the power washer.

Never use a round nozzle to power-wash tires. The intense jet of water can result in damage to the tire.

Always replace a damaged tire.

Always keep the jet of water moving across the surface. Do not aim directly at electrical parts, electrical connectors, seals, or other rubber parts.

i Vehicles with KEYLESS-GO: If a door handle is hit by a strong jet of water, and a SmartKey is within approximately 3 ft (1 m) of the vehicle, it could be inadvertently locked or unlocked.

Tar stains

Quickly remove tar stains before they dry and become more difficult to remove. A tar remover is recommended.

Paintwork, painted body components

! Affixing stickers, magnets, adhesive tape or similar materials to painted body components may damage the paintwork.

Mercedes-Benz approved Paint Care should be applied when water drops on the paint surface do not “bead up”. This should

normally be done every 3 to 5 months, depending on the climate and washing detergent used.

Mercedes-Benz approved Paint Cleaner should be applied if the paint surface shows signs of embedded dirt (i.e. loss of gloss).

Do not apply any of these products or wax if your vehicle is parked in the sun or if the hood is still hot.

- ▶ Use the appropriate MB-Touch-Up Stick for quick and provisional repairs of minor paint damage (i.e. chips from stones, vehicle doors, etc.).

Engine cleaning

Prior to cleaning the engine compartment, make sure to protect electrical components and connectors from contact with water and cleaning agents.

Corrosion protection, such as MB Anticorrosion Wax should be applied to the engine compartment after every engine cleaning. Before applying, all control linkage bushings and joints should be lubricated. The poly-V-belt and all pulleys should be protected from any wax.

Vehicle washing

In the winter, thoroughly remove all traces of road salt as soon as possible.

When washing the vehicle underbody, do not forget to clean the inner sides of the wheels.

i Vehicles with KEYLESS-GO:

If a door handle is hit by a strong jet of water, and a SmartKey is within approximately 3 ft (1 m) of the vehicle, it could be inadvertently locked or unlocked.

Hand-wash

- ▶ Do not use hot water or wash your vehicle in direct sunlight.
- ▶ Only use a soft, wet cloth or sponge to clean the vehicle.

- ▶ Only use a mild vehicle wash detergent, such as Mercedes-Benz approved Car Shampoo.
 - ▶ Thoroughly spray the vehicle with a diffused jet of water.
 - ▶ Do not spray directly towards the ventilation intake.
 - ▶ Use plenty of water and rinse the sponge and chamois frequently.
 - ▶ Rinse with clean water and dry with a chamois thoroughly.
- Do not allow cleaning agents to dry on the finish.

Automatic car wash

You can have your vehicle washed in an automatic car wash from the start. Brushless car washes are preferable.

- ▶ To protect the filter system, activate the air recirculation mode using button  on the climate control panel.

! Do not clean your vehicle in an automatic touchless car wash which uses caustic spray. Caustic spray will damage the paint or ornamental moldings.

If the vehicle is very dirty, prewash it before running it through the automatic car wash.

! Make sure the combination switch is set to wiper setting . Otherwise, the rain sensor could activate and cause the wipers to move unintentionally. This may lead to vehicle damage.

Due to the width of the vehicle, fold in exterior rear view mirrors prior to running the vehicle through an automatic car wash to prevent damage to the mirrors.

Vehicles with automatic transmission:

- ▶ **When taking the vehicle through an automatic conveyor-type car wash:** Make sure the automatic transmission remains in neutral position **N**.

When leaving the automatic car wash, make sure the mirrors are folded out.

After running the vehicle through an automatic car wash, wipe any wax off of the windshield and the wiper blade inserts. This will prevent smears and reduce wiping noise which can be caused by residual wax on the windshield.

Ornamental moldings

- For regular cleaning and care of ornamental moldings, use a damp cloth.

! Do not use chrome cleaner on ornamental moldings. Although ornamental moldings may have chrome appearance, they could be made of anodized aluminum that will be damaged when cleaned with chrome cleaner. Instead, use a damp cloth to clean those ornamental moldings.

For very dirty ornamental moldings of which you are sure are chrome-plated, use a chrome cleaner. If in doubt whether an ornamental molding is chrome-plated, contact an authorized Mercedes-Benz Center.

Headlamps, brake lamps, tail lamps, side markers, turn signal lenses

- Use a mild vehicle wash detergent, such as Mercedes-Benz approved Car Shampoo, with plenty of water.

! Only use window cleaning solutions that are suitable for plastic lamp lenses. Window cleaning solutions which are not suitable may damage the plastic lamp lenses of the headlamps. Therefore, do not use abrasives, solvents or cleaners that contain solvents.

Cleaning the driving system sensors

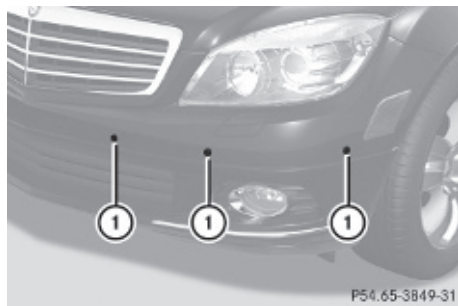

The Parktronic system sensors ① are located in the front and rear bumper.

To clean the bumper area near driving system sensors ① observe the following:

- Use a mild vehicle wash detergent, such as Mercedes-Benz approved Car Shampoo, with plenty of water.
- Use a soft, non-scratching cloth.

! If you use a power washer to clean the sensor covers, observe the following:

- Follow the instructions provided by the power washer manufacturer.
- Maintain a distance between the sensor covers and the nozzle of the power washer.

Cleaning the rear view camera lens

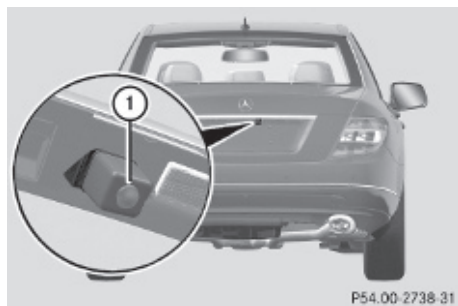

- Only use clean water and a soft, non-scratching cloth to clean rear view camera lens ①.

Be careful not to apply wax to rear view camera lens ① when waxing the vehicle. If necessary, remove the wax using the Mercedes-Benz approved Car Shampoo with plenty of water.

! Do not clean the camera and the area around the camera

- with a high-pressure cleaner
- with a dry cloth and strong pressure
- with aggressive cleaning agents

You could otherwise damage the camera.

Cleaning the windows and the wiper blades

! The windshield wipers must be in a vertical position before folding them away from the windshield. They could otherwise damage the hood.

Never open the hood when the wiper arms are folded forward.

- ▶ Make sure the hood is fully closed.
- ▶ Switch on the ignition.
- ▶ Turn combination switch to wiper setting  (▷ page 96).
- ▶ With wiper arms in vertical position, switch off the ignition.

Warning!

For safety reasons, switch off wipers and remove SmartKey from starter switch before cleaning the windshield and/or the wiper blades. Vehicles with KEYLESS-GO: Make sure the vehicle's on-board electronics have status **0**. Otherwise, the wiper motor could suddenly turn on and cause injury.

! Do not pull on the wiper blade inserts. They could tear.

▶ Fold the wiper arms forward until they snap into place.

▶ Clean the windshield and the wiper blade inserts with a clean cloth and mild detergent solution.

▶ Use a soft, clean cloth and a mild window cleaning solution on all outside and inside glass surfaces.

An automotive glass cleaner is recommended.

! Fold the windshield wiper arms back onto the windshield before turning the SmartKey in the starter switch or pressing the KEYLESS-GO start/stop button.

Hold on to the wiper when folding the wiper arm back. If released, the force of the impact from the tensioning spring could crack the windshield.

! To clean the window interior, do not use a dry cloth, abrasives, solvents or cleaners containing solvents. Do not touch the inside of the windows with hard objects such as an ice scraper or ring. Doing so may damage the windows.

Cleaning the panorama roof with power tilt/sliding panel

The rear part of the tilt/sliding panel has a protective layer on the inside.

▶ Use a soft, clean cloth and a mild window cleaning solution.

An automotive glass cleaner is recommended.

! Do not use a dry cloth, abrasives, solvents or cleaners containing solvents. Do not touch the protective layer with hard objects such as an ice scraper or ring. Never apply strong force and only use a soft, non-scratching cloth when cleaning the rear part of the tilt/sliding panel.

Otherwise you may scratch or damage the protective layer.

Light alloy wheels

If possible, clean wheels once a week.

- ▶ Use Mercedes-Benz approved Wheel Care, a soft bristle brush and a strong spray of water for cleaning the light alloy wheels.

! Only use acid-free cleaning materials. Acid may cause corrosion or damage the clear coat.

! The vehicle should not be parked for an extended period of time immediately after it has been cleaned. This applies especially after the wheel rims have been cleaned with wheel rim cleaner. Wheel rim cleaners can lead to increased corrosion of the brake disks and brake pads. Non-approved wheel cleaners may also damage the wheel paint if the vehicle is not driven after cleaning.

Therefore, the vehicle's brake system should always be warmed-up before it is parked after cleaning. Drive your vehicle for several minutes to allow the brakes to dry. When applying Mercedes-Benz approved Tire Care and Mercedes-Benz approved Wheel Care products, take care not to spray them on the brake disks.

Plastic and rubber parts

- ▶ Use a gentle dishwashing detergent or mild detergent for delicate fabrics as a washing solution.
- ▶ Wipe with a cloth moistened in a lukewarm solution.
The surface may temporarily change color. If this is the case, wait for it to dry.

Warning!

Do not use cleaners or cockpit care sprays containing solvents to clean the cockpit or the steering wheel. Cleaners containing solvents will make the surface porous and vehicle occupants could suffer serious injuries from plastic parts coming loose in the event of air bag deployment.

! Do not use oil, wax or scouring agents. Otherwise you may scratch or damage the surface.

Hard plastic trim items

- ▶ Use Mercedes-Benz approved Interior Care on a soft, lint-free cloth and apply with light pressure.

Audio or COMAND display

! You must switch off the audio or COMAND display and allow it to cool prior to cleaning.

! Do not use any liquids or cleaning agents. These can damage or even destroy the audio or COMAND display screen.

- ▶ Use a standard microfiber cloth and apply with light pressure.

Steering wheel and gear selector lever

- ▶ Wipe with a damp cloth and dry thoroughly or clean with Mercedes-Benz approved Leather Care.

Carpets

- ▶ Use Mercedes-Benz approved Carpet and Fabric Care for cleaning the carpets.

Headliner and shelf below rear window

- ▶ Use a soft bristle brush or a dry-shampoo cleaner in case of excessive dirt.

Seat belts

- ▶ Only use clear, lukewarm water and soap.

! The seat belts must not be treated with chemical cleaning agents. Do not dry the seat belts at temperatures above 176°F (80°C) or in direct sunlight.

⚠ Warning!

Do not bleach or dye seat belts as this may severely weaken them. In a crash they may not be able to provide adequate protection.

Upholstery

Using aftermarket seat covers or wearing clothing that have the tendency to give off coloring (e.g. when wet, etc.) may cause the upholstery to become permanently discolored. By lining the seats with a proper intermediate cover, contact-discoloration will be prevented.

⚠ Warning!

Only use seat or head restraint covers which have been tested and approved by Mercedes-Benz for your vehicle model.

Using other seat or head restraint covers may interfere with or prevent

- deployment of the front side impact air bags
- deployment of the rear side impact air bags
- deployment of the pelvis air bags
- activation of the NECK-PRO active front head restraints

Contact an authorized Mercedes-Benz Center for availability.

Leather upholstery

Please note that leather upholstery is a natural product and is therefore subject to a natural aging process. Leather upholstery may also react to certain ambient influences such as high humidity or high temperature by showing wrinkles for example.

- ▶ Wipe leather upholstery with a damp cloth and dry thoroughly or clean with Mercedes-Benz approved Leather Care.

! To avoid damage to leather upholstery:

- Wipe with light pressure only.
- Do not clean with abrasive cleaning agents such as scouring milk or powder.

- Do not soak the leather upholstery. As leather is a natural product, it could otherwise harden or become porous.
- Exercise particular care when cleaning perforated leather as its underside should not become wet.

Wood trims

- ▶ Only use water and a damp cloth to clean wood trims in your vehicle.

! Do not use solvents like tar remover or wheel cleaner nor polishes or waxes as these may be abrasive.

Chrome-plated exhaust tip

Regular cleaning and care of chrome-plated exhaust tips will help to maintain their shine and the classy appearance.

- ▶ Use Mercedes-Benz approved Chrome Polishing Paste each time the vehicle has been washed, especially during the winter.

! Do not use alkaline cleaners such as wheel cleaners as they could cause corrosion.

Vehicle equipment	268
Where will I find ...?	268
Vehicle status messages in the multifunction display	270
What to do if	297
Unlocking/locking manually	309
Resetting activated NECK-PRO active front head restraints	311
Replacing SmartKey batteries	312
Replacing bulbs	313
Replacing wiper blades	316
Flat tire	317
Battery	321
Jump starting	323
Towing the vehicle	325
Fuses	328

امداد خودرو فارما

تلفن شبانه روزی: ۰۲۱-۸۸۸۶۲۰۸۵

FarmaSOS.com



Vehicle equipment

- i** This Operator's Manual describes all features, standard or optional, potentially available for your vehicle at the time of purchase. Please be aware that your vehicle might not be equipped with all features described in this manual.

Where will I find ...?

First aid kit

- i** Check expiration dates and contents for completeness at least once a year and replace missing/expired items.

Depending on the equipment configuration, the first-aid kit will be located either in the open storage department in the trunk or behind the cover panel on the left-hand side of the trunk.

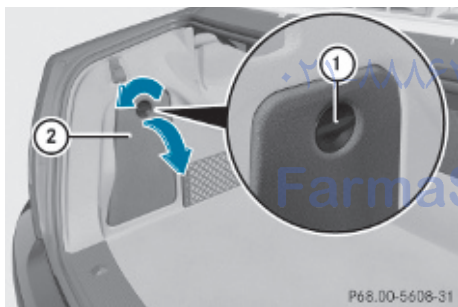

- ▶ Turn lock ① counterclockwise.
 - ▶ Fold down cover ②.
- The first aid kit can be removed.

Vehicle tool kit

The vehicle tool kit is located in the space underneath the trunk floor.

- i** Vehicles without spare wheel are not factory-equipped with the tools required for a wheel change such as a jack or a wheel

wrench. Some tools required for a wheel change are specific to your vehicle. Contact an authorized Mercedes-Benz Center to obtain the tools approved for your vehicle.

The vehicle tool kit includes:

- Collapsible wheel chock²⁰
 - Fuse chart
 - Jack²⁰
 - Pair of gloves²⁰
 - Towing eye bolt
 - Wheel wrench²⁰
- ▶ Open the trunk (▷ page 75).
 - ▶ Lift the trunk floor using the floor handle.
 - ▶ Engage the floor handle on the upper trunk lip.

- !** To prevent damage, always disengage the floor handle from the upper trunk lip and lower the trunk floor before closing the trunk.

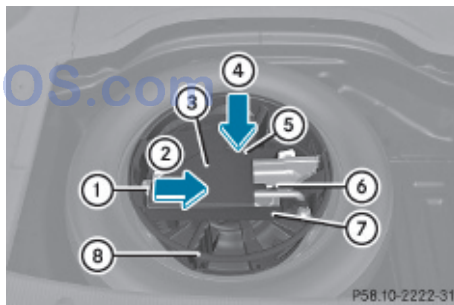

- ① Tab
- ② Removing vehicle tool kit box
- ③ Vehicle tool kit box cover
- ④ Opening vehicle tool kit box cover
- ⑤ Tab
- ⑥ Vehicle tool kit
- ⑦ Vehicle tool kit box
- ⑧ Luggage bowl

²⁰ Vehicles with spare wheel only.

- ▶ **Removing vehicle tool kit box:** Pull tab ① in direction of arrow ② and lift vehicle tool kit box ⑦.
- ▶ Remove vehicle tool kit box ⑦ from luggage bowl ⑧.
- ▶ **Opening vehicle tool kit box cover:** Pull tab ⑤ in direction of arrow ④ and open vehicle tool kit box cover ③.
- ▶ **Installing vehicle tool kit box:** Slide vehicle tool kit box ⑦ into the recess of luggage bowl ⑧.
- ▶ Push vehicle tool kit box ⑦ downward until it engages into luggage bowl ⑧.

Collapsible wheel chock

The collapsible wheel chock serves to secure the vehicle, e.g. while changing a wheel.

- ▶ Take the collapsible wheel chock from the vehicle tool kit (▷ page 268).

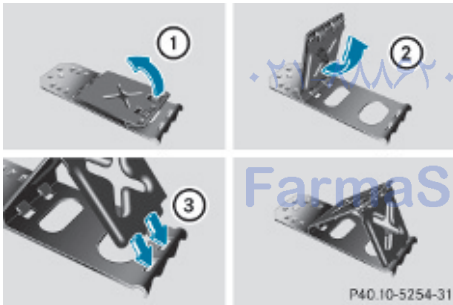

- ▶ **Setting up:** Tilt both plates upward ①.
- ▶ Fold the lower plate outward ②.
- ▶ Guide the tabs of the lower plate all the way into the openings of base plate ③.

For information on where to place wheel chocks when changing a wheel, see “Lifting the vehicle” (▷ page 318).

Jack

⚠ Warning!

Only use the jack supplied with your vehicle to lift the vehicle briefly for wheel changes. If

you use the jack for any other purpose, you or others could be injured, as the jack is designed only for the purpose of changing a wheel.

When using the jack, observe the safety notes in the “Mounting the spare wheel” section and the notes on the jack.

- ▶ Take the jack from the vehicle tool kit (▷ page 268).

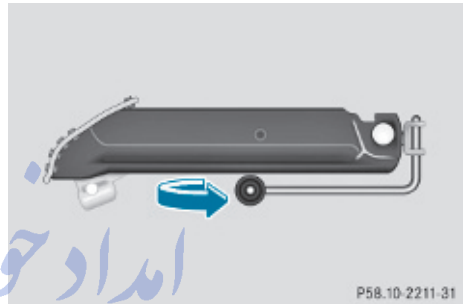

Storage position

- ▶ Turn the crank handle in the direction of arrow as far as it will go.

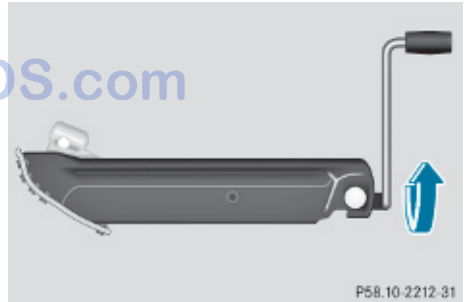

Operational position

- ▶ Turn the crank handle clockwise.

Before placing the jack back into the vehicle tool kit:

- ▶ Fully collapse the jack.
- ▶ Fold in the crank handle (storage position).

Spare wheel

⚠ Observe Safety notes, see page 317.

The spare wheel is located in the space underneath the trunk floor.

- ▶ **Removing:** Open the trunk (▷ page 75).
- ▶ Lift the trunk floor using the floor handle.
- ▶ Engage the trunk floor handle on the upper trunk lip.

! To prevent damage, always disengage the floor handle from the upper trunk lip and lower the trunk floor before closing the trunk.

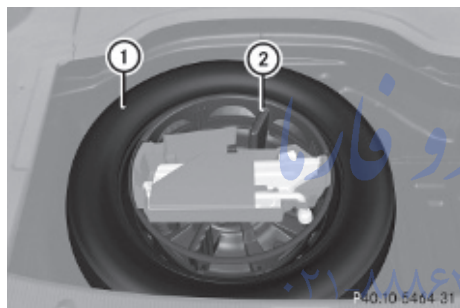

- ▶ Remove luggage bowl ② by turning it counterclockwise.
- ▶ Remove spare wheel ①.

Storing the spare wheel after use

- ▶ Place spare wheel ① into the spare wheel well.
- ▶ Secure spare wheel ① by turning luggage bowl ② clockwise.

Vehicle status messages in the multifunction display

Notes

Warning and malfunction messages appear in the multifunction display located in the instrument cluster.

Certain warning and malfunction messages are accompanied by an audible signal.

Address these messages accordingly and follow the additional instructions given in this Operator's Manual.

High-priority messages appear in the multifunction display in red color.

Certain messages of high priority cannot be cleared from the multifunction display using **OK** or **↔** on the multifunction steering wheel (▷ page 118).

Other messages of high priority and messages of less immediate priority can be cleared from the multifunction display using **OK** or **↔**. They are then stored in the vehicle status message memory (▷ page 129). Remember that clearing a message will only make the message disappear. Clearing a message will not correct the condition that caused the message to appear.

⚠ Warning!

All categories of messages contain important information which should be taken note of and, where a malfunction is indicated, addressed as soon as possible at an authorized Mercedes-Benz Center. Failure to repair the condition noted may cause damage not covered by the Mercedes-Benz Limited Warranty, or result in property damage or personal injury.

⚠ Warning!

No messages will be displayed if either the instrument cluster or the multifunction display is inoperative.

As a result, you will not be able to see information about your driving conditions, such as

- speed
- outside temperature
- warning/indicator lamps

- malfunction/warning messages
- failure of any systems

Driving characteristics may be impaired.

If you must continue to drive, do so with added caution. Contact an authorized Mercedes-Benz Center as soon as possible.

On the pages that follow, you will find a compilation of the most important warning and malfunction messages that may appear. For your convenience the messages are divided into text messages (▷ page 272) and symbol messages (▷ page 279).



امداد خودرو فارما



تلفن شبانه روزی: ۰۲۱-۸۸۸۶۲۰۸۵

FarmaSOS.com



Text messages

Safety systems

Display messages	Possible causes/consequences and ► Solutions
Front Passenger Airbag Enabled See Operator's Manual	<p>USA only:</p> <p>The front passenger front air bag is activated while driving even though a child, small individual, or object below the system's weight threshold is on the front passenger seat, or the front passenger seat is empty. Objects on the seat or forces acting on the seat may make the system sense supplemental weight.</p> <ul style="list-style-type: none"> ► Stop the vehicle in a safe location as soon as possible. ► Engage the parking brake. ► Switch off the ignition. ► Open the front passenger door. ► Remove child and child restraint from front passenger seat and properly secure the child in rear seat employing the child restraint if necessary. ► Make sure no objects which apply supplemental weight to the seat are present. The system may recognize such supplemental weight and sense that an occupant on the front passenger seat is of a greater weight than actually present. ► Keep the seat unoccupied, close the front passenger door and switch on the ignition. <p>Monitor the  indicator lamp in the center console (► page 45) and the multifunction display in the instrument cluster (► page 28) for the following:</p> <p>With the seat unoccupied and the ignition switched on,</p> <ul style="list-style-type: none"> • the  indicator lamp in the center console should illuminate and remain illuminated, indicating that the OCS (► page 42) has deactivated the front passenger front air bag. • the message Front Passenger Airbag Enabled See Operator's Manual or the message Front Passenger Airbag Disabled See Operator's Manual should not appear in the multifunction display at any time the seat is unoccupied. Wait at least 60 seconds for the system to complete the necessary check cycles and to make sure neither message appears in the multifunction display. <p>If above conditions are met, you can occupy the front passenger seat again. Depending on the front passenger</p>

Display messages	Possible causes/consequences and ► Solutions
	<p>classification sensed by the OCS, the   indicator lamp will remain illuminated or go out.</p> <p>If above conditions are not met, the system is not working properly. Have the system checked at an authorized Mercedes-Benz Center as soon as possible.</p>







Warning!

If the   indicator lamp remains out even after performing the above corrective steps, do not have any children 12 years old and under and other small individuals use the passenger seat until the system has been repaired.

امداد خودرو فارما

تلفن شبانه روزی: ۰۲۱-۸۸۸۶۲۰۸۵

FarmaSOS.com

Display messages	Possible causes/consequences and ► Solutions
Front Passenger Airbag Disabled See Operator's Manual	<p>USA only:</p> <p>The front passenger front air bag is deactivated while driving even though an adult or someone larger than a small individual is occupying the front passenger seat. Forces acting on the seat may make the system sense a decrease in weight.</p> <ul style="list-style-type: none"> ▶ Stop the vehicle in a safe location as soon as possible. ▶ Engage the parking brake. ▶ Switch off the ignition. ▶ Have the front passenger vacate the seat and exit the vehicle. ▶ Keep the seat unoccupied, close the front passenger door and switch on the ignition. <p>Monitor the   indicator lamp in the center console (▷ page 45) and the multifunction display in the instrument cluster (▷ page 28) for the following:</p> <p>With the seat unoccupied and the ignition switched on,</p> <ul style="list-style-type: none"> • the   indicator lamp in the center console should illuminate and remain illuminated, indicating that the OCS (▷ page 42) has deactivated the front passenger front air bag. • the message Front Passenger Airbag Enabled See Operator's Manual or the message Front Passenger Airbag Disabled See Operator's Manual should not appear in the multifunction display at any time the seat is unoccupied. Wait at least 60 seconds for the system to complete the necessary check cycles and to make sure neither message appears in the multifunction display. <p>If above conditions are met, you can occupy the front passenger seat again. Depending on the front passenger classification sensed by the OCS, the   indicator lamp will remain illuminated or go out.</p> <p>If above conditions are not met, the system is not working properly. Have the system checked at an authorized Mercedes-Benz Center as soon as possible.</p>

Display messages		Possible causes/consequences and ► Solutions
Check Child Seat Position	See Operator's Manual	Vehicles with BabySmart™ (Canada only): The BabySmart™ child seat is not positioned correctly. Risk of injury! ► Install the BabySmart™ child seat in correct position.
		Vehicles with BabySmart™ (Canada only): The sensor for child seat recognition is malfunctioning. Risk of injury! ► Contact an authorized Mercedes-Benz Center.

Warning!
 If the  indicator lamp remains illuminated with an adult occupant on the front passenger seat even after performing the above corrective steps, do not have any passenger use the front passenger seat until the system has been repaired.

Driving systems

Display messages		Possible causes/consequences and ► Solutions
Cruise Control	Inoperative	The cruise control is malfunctioning. In addition an acoustic warning sounds. ► Have the cruise control checked at an authorized Mercedes-Benz Center.
Cruise Control	- - - mph	One of the activation conditions for cruise control has not been fulfilled. You may have attempted to set a speed below 20 mph (30 km/h). ► Drive faster than 20 mph (30 km/h) if the situation allows and set the speed. ► Check the activation conditions for cruise control (► page 181).

Vehicle

Display messages		Possible causes/consequences and ► Solutions
P	Shift to 'P'	<p>You have turned off the engine with the KEYLESS-GO start/stop button with the automatic transmission in neutral position N and opened the driver's door.</p> <p>or</p> <p>You have attempted to switch off the engine with the KEYLESS-GO start/stop button with the automatic transmission in reverse gear R or drive position D.</p> <p>► Shift the automatic transmission to park position P.</p>
Shift to 'P' or 'N'	to Start Engine	<p>You have attempted to start the engine while the automatic transmission was in reverse gear R or drive position D.</p> <p>► Shift the automatic transmission into park position P or neutral position N. Make sure the brake pedal is depressed.</p>

Tires

Display messages		Possible causes/consequences and ► Solutions
Check Tire Pressure	Then Restart Run Flat Indicator	<p>There has been a warning message about a loss in the tire inflation pressure and the tire pressure loss warning system was not restarted yet. <i>تلفن شبانه روزی: ۰۲۰ ۶۶۰۳۰۳۰۳</i></p> <p>► Make sure the correct tire inflation pressure is set for each tire.</p> <p>► Then restart the tire pressure loss warning system (► page 233).</p>
Run Flat Indicator	Inoperative	<p>The tire pressure loss warning system is malfunctioning.</p> <p>► Have the tire pressure loss warning system checked at an authorized Mercedes-Benz Center.</p>
Check	Tire Pressure Soon	<p>The tire pressure loss warning system indicates that the tire inflation pressure is too low in at least one tire.</p> <p>► Carefully bring the vehicle to a halt, avoiding abrupt steering and braking maneuvers. Observe the traffic situation around you.</p> <p>► Check the tires and, if necessary, change the wheel (► page 317).</p> <p>► Check and adjust tire inflation pressure as required (► page 232).</p> <p>► Restart the tire pressure loss warning system after adjusting the tire inflation pressure values (► page 233).</p>

Display messages		Possible causes/consequences and ► Solutions
Tire pressures will be displayed	after driving a few minutes	The tire inflation pressure is being checked by the Advanced TPMS. ► Drive the vehicle for a few minutes.
Tire Press. Monitor	Inoperative	The Advanced TPMS is malfunctioning. ► Have the Advanced TPMS checked at an authorized Mercedes-Benz Center.
Tire Pressure Monitor	Inoperative No Wheel Sensors	There are wheels without appropriate wheel sensors mounted (e.g. winter tires). ► Have the Advanced TPMS checked at an authorized Mercedes-Benz Center. ► Have the appropriate wheel sensors installed at an authorized Mercedes-Benz Center.
TirePress.	Sensor(s) Missing	At least one sensor is defect (e.g. battery is empty). The respective tire is indicated by - - instead of the tire inflation pressure in the multifunction display. ► Have the Advanced TPMS checked at an authorized Mercedes-Benz Center. ► Have the wheel sensors installed at an authorized Mercedes-Benz Center.
		At least one wheel without appropriate wheel sensors is mounted (e.g. spare wheel). The respective tire is indicated by - - instead of the tire inflation pressure in the multifunction display. ► Have the Advanced TPMS checked at an authorized Mercedes-Benz Center. ► Have the wheel sensors installed at an authorized Mercedes-Benz Center.
Tire Press. Monitor	Currently Unavailable	The Advanced TPMS cannot monitor the tire inflation pressure due to a nearby radio interference source or insufficient power supply. As soon as the causes of the malfunction have been rectified, the Advanced TPMS becomes active again automatically after a few minutes of driving.

Display messages	Possible causes/consequences and ► Solutions
Correct Tire Pressure	<p>The tire inflation pressure is too low in at least one tire. or The tire inflation pressures of the individual tires differ from each other significantly. The tire inflation pressure values are shown in the multifunction display.</p> <ul style="list-style-type: none"> ► Check and correct tire inflation pressure as required (► page 232). ► Restart the Advanced TPMS (► page 236).
Caution Tire Defect	<p>At least one tire is deflating. The respective tire is indicated in the multifunction display.</p> <ul style="list-style-type: none"> ► Carefully bring the vehicle to a halt, avoiding abrupt steering and braking maneuvers. ► If necessary, change the wheel (► page 317).
Check Tires	<p>The tire inflation pressure in at least one tire is significantly below the reference value. The respective tire is indicated in the multifunction display.</p> <ul style="list-style-type: none"> ► Carefully bring the vehicle to a halt, avoiding abrupt steering and braking maneuvers. ► Check and adjust tire inflation pressure as required. ► If necessary, change the wheel (► page 317).

 **Warning!**

Do not drive with a flat tire. A flat tire affects the ability to steer or brake the vehicle. You may lose control of the vehicle. Continued driving with a flat tire will cause excessive heat build-up and possibly a fire.

 **Warning!**

Follow recommended tire inflation pressures.

Do not underinflate tires. Underinflated tires wear excessively and/or unevenly, adversely affect handling and fuel economy, and are more likely to fail from being overheated.

Do not overinflate tires. Overinflated tires can adversely affect handling and ride comfort, wear unevenly, increase stopping distance, and result in sudden deflation (blowout) because they are more likely to become punctured or damaged by road debris, potholes etc.

Symbol messages

Brake







Display messages	Possible causes/consequences and ► Solutions
 <p data-bbox="266 276 381 360">Check Brake Pad Wear</p>	<p data-bbox="418 276 885 300">The brake pads have reached their wear limit.</p> <p data-bbox="418 312 1009 365">► Have the brake pads replaced as soon as possible at an authorized Mercedes-Benz Center.</p>







! Brake pad thickness must be visually inspected by a qualified technician at the intervals specified in the Maintenance Booklet.



امداد خودرو فارما

تلفن شبانه روزی: ۰۲۱-۸۸۸۶۲۰۸۵

FarmaSOS.com

Display messages	Possible causes/consequences and	Solutions
<p>BRAKE (USA only)</p>  <p>(Canada only)</p>	<p>ABS and ESC Inoperative. See Operator's Manual</p>	<p>In addition, the yellow ESP[®] warning lamp  and the yellow ABS indicator lamp  come on.</p> <p>The brake system is still functioning normally but due to a malfunction, the ABS, the BAS, the ESP[®], and the hill-start assist system are unavailable.</p> <ul style="list-style-type: none"> ▶ Continue driving with added caution. Wheels may lock during hard braking, reducing steering capability. ▶ Adjust driving to be consistent with reduced braking responsiveness. ▶ Have the system checked at an authorized Mercedes-Benz Center as soon as possible. <p>Failure to follow these instructions increases the risk of an accident.</p>
<p>BRAKE (USA only)</p>  <p>(Canada only)</p>	<p>ABS and ESC Currently Unavailable. See Operator's Manual</p>	<p>In addition, the yellow ESP[®] warning lamp  and the yellow ABS indicator lamp  come on.</p> <p>The brake system is still functioning normally but due to a malfunction, the ABS, the BAS, the ESP[®], and the hill-start assist system are unavailable.</p> <p>The self-diagnosis may not be completed yet.</p> <ul style="list-style-type: none"> ▶ Drive a short distance with added caution at a vehicle speed of above 12 mph (20 km/h). When the message disappears, the ESP[®] is available again. <p>If the message does not disappear:</p> <ul style="list-style-type: none"> ▶ Continue driving with added caution. Wheels may lock during hard braking, reducing steering capability. ▶ Adjust driving to be consistent with reduced braking responsiveness. ▶ Have the system checked at an authorized Mercedes-Benz Center as soon as possible. <p>Failure to follow these instructions increases the risk of an accident.</p>

Display messages	Possible causes/consequences and ► Solutions
<p>BRAKE (USA only)</p>  <p>(Canada only)</p> <p>ABS and ESC Currently Unavailable See Operator's Manual</p>	<p>In addition, the yellow ESP® warning lamp  and the yellow ABS indicator lamp  come on.</p> <p>The brake system still functions normally but due to insufficient power supply, the ABS, the BAS, the ESP®, and the hill-start assist system are unavailable.</p> <ul style="list-style-type: none"> ► Continue driving with added caution. Wheels may lock during hard braking, reducing steering capability. ► Adjust driving to be consistent with reduced braking responsiveness. <p>When the voltage is above the required value again, the ABS, the BAS, the ESP®, and the hill-start assist system are operational again and the message should disappear.</p> <p>If the message does not disappear:</p> <ul style="list-style-type: none"> ► Have the alternator and the battery checked. <p>Failure to follow these instructions increases the risk of an accident.</p>
<p>BRAKE (USA only)</p>  <p>(Canada only)</p> <p>EBD, ABS, and ESC Inoperative See Operator's Manual</p>	<p>In addition, the yellow ESP® warning lamp  and the yellow ABS indicator lamp  come on.</p> <p>The brake system is still functioning normally but due to a malfunction, the ABS, the BAS, the EBP, and the ESP® are unavailable.</p> <ul style="list-style-type: none"> ► Continue driving with added caution. Wheels may lock during hard braking, reducing steering capability. ► Adjust driving to be consistent with reduced braking responsiveness. ► Have the system checked at an authorized Mercedes-Benz Center as soon as possible. <p>Failure to follow these instructions increases the risk of an accident.</p>
<p>BRAKE (USA only)</p>  <p>(Canada only)</p> <p>Release Parking Brake</p>	<p>You are driving with the parking brake engaged. In addition an acoustic warning sounds.</p> <ul style="list-style-type: none"> ► Release the parking brake.

Display messages	Possible causes/consequences and ► Solutions	
 (USA only)  (Canada only)	Check Brake Fluid Level	<p>There is insufficient brake fluid in the reservoir. Risk of accident!</p> <ul style="list-style-type: none"> ► Stop the vehicle in a safe location or as soon as it is safe to do so. ► Engage the parking brake. ► Do not drive any further. ► Contact an authorized Mercedes-Benz Center or call Roadside Assistance. <p>Do not add brake fluid! This will not solve the problem.</p>

Warning!

Driving with the message Check Brake Fluid Level displayed can result in an accident. Have your brake system checked immediately.





Do not add brake fluid before checking the brake system. Overfilling the brake fluid reservoir can result in spilling brake fluid on hot engine parts and the brake fluid catching fire. You can be seriously burned.









- !** If you find that the brake fluid in the brake fluid reservoir has fallen to the minimum mark or below, have the brake system checked for brake pad thickness and leaks.







تلفن شبانه روزی: ۰۲۱-۸۸۸۶۲۰۸۵

FarmaSOS.com

Safety systems

Display messages		Possible causes/consequences and ► Solutions
	<p>ESC Inoperative See Operator's Manual</p>	<p>In addition, the yellow ESP® warning lamp  comes on. The brake system is still functioning normally but due to a malfunction, the BAS, the ESP®, and the hill-start assist system are unavailable.</p> <ul style="list-style-type: none"> ► Continue driving with added caution. Wheels may lock during hard braking, reducing steering capability. ► Adjust driving to be consistent with reduced braking responsiveness. ► Have the system checked at an authorized Mercedes-Benz Center as soon as possible. <p>Failure to follow these instructions increases the risk of an accident.</p>
	<p>ESC Currently Unavailable See Operator's Manual</p>	<p>In addition, the yellow ESP® warning lamp  comes on. The brake system still functions normally but due to insufficient power supply the BAS, the ESP®, and the hill-start assist system are not available.</p> <ul style="list-style-type: none"> ► Continue driving with added caution. Wheels may lock during hard braking, reducing steering capability. ► Adjust driving to be consistent with reduced braking responsiveness. <p>When the voltage is above the required value again, the ESP® is operational again and the message in the multifunction display should disappear.</p> <p>If the message in the multifunction display does not disappear:</p> <ul style="list-style-type: none"> ► Have the alternator and the battery checked. <p>Failure to follow these instructions increases the risk of an accident.</p>

Display messages		Possible causes/consequences and ► Solutions
	<p>ESC Currently Unavailable See Operator's Manual</p>	<p>In addition, the yellow ESP[®] warning lamp  comes on. The self-diagnosis may not be completed yet. The brake system is still functioning normally but without the BAS, the ESP[®], and the hill-start assist system available.</p> <ul style="list-style-type: none"> ► Drive a short distance with added caution at a vehicle speed of above 12 mph (20 km/h). When the message disappears, the ESP[®] is available again. <p>If the message does not disappear:</p> <ul style="list-style-type: none"> ► Continue driving with added caution. Wheels may lock during hard braking, reducing steering capability. ► Adjust driving to be consistent with reduced braking responsiveness. ► Have the system checked at an authorized Mercedes-Benz Center as soon as possible. <p>Failure to follow these instructions increases the risk of an accident.</p>
	<p>ESC Currently Unavailable See Operator's Manual</p>	<p>If the yellow ESP[®] warning lamp  flashes while driving and this message appears, the Electronic Traction System (ETS/4-ETS) has switched off to prevent overheating of the drive wheel brakes. As soon as the brakes have cooled off, the Electronic Traction System (ETS/4-ETS) switches on again. The message in the multifunction display disappears and the ESP[®] warning lamp  goes out.</p>
	<p>Tele Aid Inoperative</p>	<p>One or more main functions of the Tele Aid system are malfunctioning.</p> <ul style="list-style-type: none"> ► Have the Tele Aid system checked at an authorized Mercedes-Benz Center.
	<p>SRS Malfunction Service Required</p>	<p>There is a malfunction in the Supplemental Restraint System (SRS). The air bags or Emergency Tensioning Devices (ETDs) could deploy unexpectedly or fail to activate in an accident.</p> <ul style="list-style-type: none"> ► Drive with added caution to the nearest authorized Mercedes-Benz Center.
	<p>Front Left SRS Malfunction Service Required</p>	<p>Components of the driver's supplemental restraint system may not work properly.</p> <ul style="list-style-type: none"> ► Drive with added caution to the nearest authorized Mercedes-Benz Center.

Display messages	Possible causes/consequences and ► Solutions
 <p>Front Right SRS Malfunction Service Required</p>	<p>Components of the front passenger's supplemental restraint system may not work properly.</p> <p>► Drive with added caution to the nearest authorized Mercedes-Benz Center.</p>
 <p>Rear Left SRS Malfunction Service Required</p>	<p>Components of the left rear passenger's supplemental restraint system may not work properly.</p> <p>► Drive with added caution to the nearest authorized Mercedes-Benz Center.</p>
 <p>Rear Center SRS Malfunction Service Required</p>	<p>Components of the center rear passenger's supplemental restraint system may not work properly.</p> <p>► Drive with added caution to the nearest authorized Mercedes-Benz Center.</p>
 <p>Rear Right SRS Malfunction Service Required</p>	<p>Components of the right rear passenger's supplemental restraint system may not work properly.</p> <p>► Drive with added caution to the nearest authorized Mercedes-Benz Center.</p>
 <p>Left Side Curtain Airbag Malfunction Service Required</p>	<p>The left window curtain air bag may not work properly.</p> <p>► Drive with added caution to the nearest authorized Mercedes-Benz Center.</p>
 <p>Right Side Curtain Airbag Malfunction Service Required</p>	<p>The right window curtain air bag may not work properly.</p> <p>► Drive with added caution to the nearest authorized Mercedes-Benz Center.</p>









⚠ Warning!







In the event a malfunction of the SRS is indicated as outlined above, the SRS may not be operational.



For your safety, we strongly recommend that you contact an authorized Mercedes-Benz

Center immediately to have the system checked. Otherwise the SRS may not be activated when needed in an accident, which could result in serious or fatal injury, or it might deploy unexpectedly and unnecessarily which could also result in injury.

Vehicle

Display messages		Possible causes/consequences and ► Solutions
		The trunk is open. ► Close the trunk (► page 76).
		You are driving with the hood open. ► Stop the vehicle in a safe location as soon as it is safe to do so. ► Close the hood (► page 225). There is otherwise danger of an accident.
		You are driving with at least one door open. The display symbol shows you which doors are open. ► Close all doors.
	Rear Left Backrest Not Latched or Rear Right Backrest Not Latched	The left or right rear seat backrest is not engaged. ► Adjust the rear seat backrest until it is fully engaged in position.
	Key Detected In Vehicle	A SmartKey with KEYLESS-GO left in the vehicle was recognized while trying to lock the vehicle from the outside. ► Take the SmartKey out of the vehicle.
	Don't Forget Your Key	This message appears for a maximum of 60 seconds if the driver's door is opened with the engine turned off and no SmartKey in the starter switch. This message is only a reminder. ► Take the SmartKey with you when leaving the vehicle.
	Take Your Key From Ignition	You have forgotten to remove the SmartKey. ► Remove the SmartKey from the starter switch.
	Obtain A New Key	The SmartKey is malfunctioning. ► Contact an authorized Mercedes-Benz Center.

Display messages		Possible causes/consequences and ► Solutions
	<p>Close Doors To Lock Vehicle</p>	<p>You tried to lock the vehicle but not all doors were closed. ► Close doors and lock the vehicle again.</p>
	<p>Key Does Not Belong to Vehicle</p>	<p>The SmartKey in the starter switch does not belong to the vehicle. ► Remove the SmartKey from the starter switch.</p>
	<p>Replace Key Battery</p>	<p>The batteries in the SmartKey with KEYLESS-GO are discharged. ► Replace the batteries (▷ page 312).</p>
	<p>Key Not Detected (message appears in red)</p>	<p>The SmartKey with KEYLESS-GO is not detected while the engine is running because the SmartKey is not in the vehicle. ► Stop the vehicle as soon as it is safe to do so. ► Engage the parking brake. ► Search for the SmartKey. The vehicle cannot be locked centrally nor can the engine be started again after the engine is stopped.</p>
	<p>Key Not Detected (message appears in red)</p>	<p>The SmartKey with KEYLESS-GO is not detected while the engine is running because there is strong radio-frequency interference. ► Stop the vehicle as soon as it is safe to do so. ► Engage the parking brake. ► Remove the KEYLESS-GO button from the starter switch (▷ page 78). ► Operate the vehicle with the SmartKey in the starter switch.</p>
	<p>Key Not Detected (message appears in white)</p>	<p>The SmartKey with KEYLESS-GO is momentarily not detected. ► Change the position of the SmartKey in the vehicle. ► If necessary, remove the KEYLESS-GO button from the starter switch (▷ page 78). ► Operate the vehicle with the SmartKey in the starter switch.</p>
	<p>Remove 'Start' Button and Insert Key</p>	<p>The KEYLESS-GO system is malfunctioning. ► Remove the KEYLESS-GO button from the starter switch (▷ page 78). ► Operate the vehicle with the SmartKey in the starter switch.</p>

Display messages	Possible causes/consequences and ► Solutions
 <p>Check Washer Fluid</p>	<p>The water level has dropped to approximately 1.1 US qts (1.0 l).</p> <p>► Add washer fluid (► page 228).</p>
 <p>Power Steering Malfunction See Operator's Manual</p>	<p>Power assistance for the steering system is not available. A considerably higher degree of effort is necessary to steer the vehicle.</p> <p>► Check whether you are capable to apply the higher degree of effort necessary to safely steer the vehicle.</p> <p>If you are able to steer the vehicle safely:</p> <p>► Continue driving with added caution.</p> <p>► Have the system checked at an authorized Mercedes-Benz Center.</p> <p>If, in any way, you feel that you are not able to steer the vehicle safely:</p> <p>► Stop the vehicle in a safe location as soon as it is safe to do so.</p> <p>► Apply the parking brake.</p> <p>► Do not continue to drive.</p> <p>► Contact an authorized Mercedes-Benz Center.</p>

Engine

Display messages	Possible causes/consequences and ► Solutions
 <p>Check Coolant Level See Operator's Manual</p>	<p>The coolant level is too low.</p> <p>► Add coolant (► page 227).</p> <p>► If you have to add coolant frequently, have the cooling system checked at an authorized Mercedes-Benz Center.</p>

Warning!

Do not spill antifreeze on hot engine parts. Antifreeze contains ethylene glycol which may burn if it comes into contact with hot engine parts. You could be seriously burned.

! Do not ignore the low engine coolant level warning. Extended driving with the message and symbol displayed may cause serious engine damage not covered by the Mercedes-Benz Limited Warranty.

Do not drive without sufficient amount of coolant in the cooling system. The engine will overheat causing major engine damage.

Display messages	Possible causes/consequences and ► Solutions
 <p>Coolant Low Stop Vehicle! Turn Engine Off</p>	<p>The coolant is too hot.</p> <ul style="list-style-type: none"> ► Stop the vehicle immediately as soon as it is safe to do so. ► Turn off the engine immediately. ► Engage the parking brake. ► Only start the engine again after the message disappears. You could otherwise damage the engine. ► Observe the coolant temperature gauge in the instrument cluster. ► If the temperature rises again: Contact an authorized Mercedes-Benz Center immediately. <p>During severe operation conditions and stop-and-go city traffic, the coolant temperature may rise close to 248°F (120°C).</p>



 **Warning!**

Driving when your engine is overheated can cause some fluids which may have leaked into the engine compartment to catch fire. You could be seriously burned.

Steam from an overheated engine can cause serious burns which can occur just by opening the engine hood. Stay away from the engine if you see or hear steam coming from it.

Stop the vehicle in a safe location away from other traffic. Turn off the engine, get out of the vehicle and do not stand near the vehicle until the engine has cooled down.

- !** The engine should not be operated with the coolant temperature above 248°F (120°C). Doing so may cause serious damage which is not covered by the Mercedes-Benz Limited Warranty.

Display messages		Possible causes/consequences and ► Solutions
	Coolant Low Stop Vehicle! Turn Engine Off	<p>The poly-V-belt could be broken.</p> <ul style="list-style-type: none"> ► Stop the vehicle immediately as soon as it is safe to do so. ► Turn off the engine immediately. ► Check the poly-V-belt. ► If it is broken: Do not continue to drive. Otherwise the engine will overheat due to an inoperative water pump which may result in damage to the engine. Contact an authorized Mercedes-Benz Center. ► If it is intact: Do not continue to drive the vehicle with this message displayed. Doing so could result in serious engine damage that is not covered by the Mercedes-Benz Limited Warranty. ► Observe the coolant temperature gauge in the instrument cluster. ► Drive to the nearest authorized Mercedes-Benz Center immediately.
		<p>The radiator cooling fan is malfunctioning.</p> <ul style="list-style-type: none"> ► Observe the coolant temperature gauge in the instrument cluster. ► If the coolant temperature is below 248°F (120°C), you may continue driving to an authorized Mercedes-Benz Center. ► Avoid placing heavy loads on the engine (e.g. by driving uphill) as well as stop-and-go traffic. ► Have the fan replaced as soon as possible.
		<p>The battery is no longer charging.</p> <p>Possible causes:</p> <ul style="list-style-type: none"> • alternator malfunctioning • broken poly-V-belt • a malfunction in the electronic system <ul style="list-style-type: none"> ► Stop immediately in a safe location or as soon as it is safe to do so and check the poly-V-belt. ► If it is broken: Do not continue to drive. Otherwise the engine will overheat due to an inoperative water pump which may result in damage to the engine. Contact an authorized Mercedes-Benz Center. ► If it is intact: Drive to the nearest authorized Mercedes-Benz Center immediately. Adjust driving to be consistent with reduced braking responsiveness.

Display messages		Possible causes/consequences and ► Solutions
	Check Engine Oil At Next Refueling	The engine oil has dropped to a critical level. <ul style="list-style-type: none"> ► Check the engine oil level (▷ page 225) and add engine oil as required (▷ page 226). ► If you must add engine oil frequently, have the engine checked for possible leaks.



If the message Check Engine Oil At Next Refueling appears while the engine is running and at operating temperature, the engine oil level has dropped to approximately the minimum level.

The message will be stored in the vehicle status message memory after you have cleared it from the multifunction display.





Visually check for oil leaks. If there are no obvious oil leaks, drive to the nearest service station to refill your engine oil to the required level.

For information on approved engine oils contact an authorized Mercedes-Benz Center or visit www.mbusa.com (USA only).





! Engine oil level warnings should not be ignored. Extended driving with the symbol displayed could result in serious engine damage that is not covered by the Mercedes-Benz Limited Warranty.





Display messages		Possible causes/consequences and ► Solutions
	Fuel Level Low	The fuel level has dropped below the reserve mark. <ul style="list-style-type: none"> ► Refuel at the next gas station.
	Gas Cap Loose	A loss of pressure has been detected in the fuel system. The fuel cap may not be closed properly or the fuel system may be leaking. <ul style="list-style-type: none"> ► Check the fuel cap (▷ page 222). ► If it is not closed properly: Close the fuel cap. ► If it is closed properly: Have the fuel system checked at an authorized Mercedes-Benz Center.

Lamps



Display messages	Possible causes/consequences and ► Solutions
 <p>Active Headlamps Inoperative</p>	<p>The active Bi-Xenon headlamp system is malfunctioning.</p> <p>► Contact an authorized Mercedes-Benz Center as soon as possible.</p>
 <p>Check Left Reverse Lamp or Check Right Reverse Lamp</p>	<p>The left or right backup lamp is malfunctioning.</p> <p>► Replace the bulb as soon as possible (► page 313).</p>
 <p>Check Left Brake Lamp or Check Right Brake Lamp</p>	<p>The left or right brake lamp is malfunctioning.</p> <p>► Replace the bulb as soon as possible (► page 313).</p>
 <p>Check Center Brake Lamp</p>	<p>The high-mounted brake lamp is malfunctioning. This message will only appear if all LEDs have stopped working.</p> <p>► Contact an authorized Mercedes-Benz Center as soon as possible.</p>
 <p>Check Left Fog Lamp or Check Right Fog Lamp</p>	<p>The left or right front fog lamp is malfunctioning.</p> <p>► Contact an authorized Mercedes-Benz Center as soon as possible.</p>

Display messages	Possible causes/consequences and ► Solutions
 <p>Check Front Left Sidemarker Lamp or Check Front Right Sidemarker Lamp</p>	<p>The front left side or right side marker lamp is malfunctioning.</p> <ul style="list-style-type: none"> ► Contact an authorized Mercedes-Benz Center as soon as possible.
 <p>Check Rear Left Sidemarker Lamp or Check Rear Right Sidemarker Lamp</p>	<p>The rear left side or right side marker lamp is malfunctioning.</p> <ul style="list-style-type: none"> ► Replace the bulb as soon as possible (► page 313).
 <p>Check Front Left Parking Lamp or Check Front Right Parking Lamp</p>	<p>The left or right front parking lamp is malfunctioning.</p> <ul style="list-style-type: none"> ► Contact an authorized Mercedes-Benz Center as soon as possible.
 <p>Check Left High Beam or Check Right High Beam</p>	<p>The left or right high-beam lamp is malfunctioning.</p> <ul style="list-style-type: none"> ► Contact an authorized Mercedes-Benz Center as soon as possible.

Display messages		Possible causes/consequences and ► Solutions
	Check Left License Plate Lamp or Check Right License Plate Lamp	The left or right license plate lamp is malfunctioning. ► Contact an authorized Mercedes-Benz Center as soon as possible.
	Auto Lamp Function Inoperative	The light sensor is malfunctioning. The headlamps come on automatically. ► Contact an authorized Mercedes-Benz Center as soon as possible. To switch off the headlamps (U.S. vehicles only): ► Switch off the daytime running lamp mode in the control system (► page 133). ► Switch off the headlamps using the exterior lamp switch (► page 90).
	Check Left Low Beam or Check Right Low Beam	The left or right low-beam lamp is malfunctioning. ► Halogen headlamp: Replace the bulb as soon as possible (► page 313). ► Bi-Xenon headlamp: Contact an authorized Mercedes-Benz Center as soon as possible.
	Check Rear Left Fog Lamp	The rear fog lamp is malfunctioning. ► Replace the bulb as soon as possible (► page 313).
	Switch Off Lights	You have removed the SmartKey from the starter switch, opened the driver's door and left the headlamps on or removed the SmartKey with KEYLESS-GO from the vehicle and left the headlamps on. ► Turn the exterior lamp switch to 0 or A (► page 90). or ► With the rear fog lamp switched on: Push in the exterior lamp switch to its stop.



Display messages	Possible causes/consequences and ► Solutions
 <p>Check Left Tail Lamp or Check Right Tail Lamp</p>	<p>The left or right tail lamp is malfunctioning. ► Replace the bulb as soon as possible (▷ page 313).</p>
 <p>Check Left Tail and Brake Lamps or Check Right Tail and Brake Lamps</p>	<p>The left or right tail lamp/brake lamp is malfunctioning. ► Replace the bulb as soon as possible (▷ page 313).</p>
 <p>Check Left Cornering Light or Check Right Cornering Light</p>	<p>The left or right corner-illuminating front fog lamp is malfunctioning. ► Contact an authorized Mercedes-Benz Center as soon as possible.</p>
 <p>Check Rear Left Turn Signal or Check Rear Right Turn Signal</p>	<p>The left or right rear turn signal lamp is malfunctioning. ► Replace the bulb as soon as possible (▷ page 313).</p>

ایراد خودرو فارما
تلفن شبانه روزی: ۰۲۱-۸۸۸۶۲۰۸۵
PharmaSOS.com

Display messages	Possible causes/consequences and ► Solutions
 <p>Check Front Left Turn Signal or Check Front Right Turn Signal</p>	<p>The left or right front turn signal lamp is malfunctioning.</p> <ul style="list-style-type: none"> ► Replace the bulb as soon as possible (► page 313).
 <p>Check Left Mirror Turn Signal or Check Right Mirror Turn Signal</p>	<p>The turn signal in the left or right exterior rear view mirror is malfunctioning. This message will only appear if all LEDs have stopped working.</p> <ul style="list-style-type: none"> ► Contact an authorized Mercedes-Benz Center as soon as possible.

تلفن شبانه روزی: ۰۲۱-۸۸۸۶۲۰۸۵

Tires

Display messages	Possible causes/consequences and ► Solutions
 <p>Tire Press. Warning Caution Tire Malfunction</p>	<p>At least one tire is deflating.</p> <ul style="list-style-type: none"> ► Carefully bring the vehicle to a halt, avoiding abrupt steering and braking maneuvers. ► If necessary, change the wheel (► page 317).
 <p>Check Tire Pressure</p>	<p>The tire inflation pressure in at least one tire is significantly below the reference value.</p> <ul style="list-style-type: none"> ► Carefully bring the vehicle to a halt, avoiding abrupt steering and braking maneuvers. ► Check and adjust tire inflation pressure as required. ► If necessary, change the wheel (► page 317).

⚠ Warning!

Do not drive with a flat tire. A flat tire affects the ability to steer or brake the vehicle. You may lose control of the vehicle. Continued driving with a flat tire will cause excessive heat build-up and possibly a fire.

⚠ Warning!

Follow recommended tire inflation pressures.

Do not underinflate tires. Underinflated tires wear excessively and/or unevenly, adversely affect handling and fuel economy, and are more likely to fail from being overheated.

Do not overinflate tires. Overinflated tires can adversely affect handling and ride comfort, wear unevenly, increase stopping distance, and result in sudden deflation (blowout) because they are more likely to become punctured or damaged by road debris, potholes etc.

What to do if ...**Lamps in instrument cluster****Notes**



If any of the following lamps in the instrument cluster fails to come on during the bulb self-check when switching on the ignition, have the respective bulb checked and replaced if necessary.



When you switch on the ignition, all lamps in the instrument cluster come on. The low-beam headlamp indicator lamp, high-beam headlamp indicator lamp, turn signal indicator lamps, and the indicator lamps for the fog lamps will only come on if activated. If a lamp in the instrument cluster fails to come on when the ignition is switched on, have it checked and replaced if necessary.







تلفن شبانه روزی: ۰۲۱-۸۸۶۲۰۸۵

FarmaSOS.com

Brake

Problem	Possible causes/consequences and ► Solutions
 The yellow ABS indicator lamp comes on while the engine is running.	<p>The ABS has detected a malfunction and switched off. The BAS, the ESP®, and the EBP are also switched off. The brake system is still functioning normally but without the systems specified above available. If the ABS control unit is malfunctioning, other systems such as the navigation system or the automatic transmission may also be malfunctioning.</p> <ul style="list-style-type: none"> ► Continue driving with added caution. Wheels may lock during hard braking, reducing steering capability. ► Adjust driving to be consistent with reduced braking responsiveness. ► Read and observe messages that may appear in the multifunction display (► page 270). ► Have the system checked at an authorized Mercedes-Benz Center as soon as possible. <p>Failure to follow these instructions increases the risk of an accident.</p>
 The yellow ABS indicator lamp comes on while the engine is running.	<p>The ABS has switched off due to insufficient power supply. The battery might not be charged sufficiently. When the voltage is above the required value again, the ABS is operational again. The ABS indicator lamp should go out.</p> <ul style="list-style-type: none"> ► Continue driving with added caution. Wheels may lock during hard braking, reducing steering capability. ► Adjust driving to be consistent with reduced braking responsiveness. ► Read and observe messages that may appear in the multifunction display (► page 270). ► If the ABS indicator lamp does not go out: Have the alternator and the battery checked.

Problem	Possible causes/consequences and ► Solutions
 The yellow ABS indicator lamp comes on while the engine is running.	<p>The ABS is temporarily not available. The ESP[®], the BAS, and the EBP are also unavailable.</p> <p>The self-diagnosis has not been completed yet.</p> <p>The brake system is still functioning normally but without the systems specified above.</p> <p>The indicator lamp will go out after driving a short distance at a vehicle speed of above 12 mph (20 km/h).</p> <p>If the ABS indicator lamp does not go out:</p> <ul style="list-style-type: none"> ► Continue driving with added caution. Wheels may lock during hard braking, reducing steering capability. ► Adjust driving to be consistent with reduced braking responsiveness. ► Read and observe messages that may appear in the multifunction display (► page 270). ► Have the system checked at an authorized Mercedes-Benz Center as soon as possible. <p>Failure to follow these instructions increases the risk of an accident.</p>
  The yellow ABS indicator lamp and the yellow ESP [®] warning lamp come on while the engine is running and an acoustic warning sounds.	<p>The brake system is still functioning normally but due to a malfunction, the ABS, the BAS, the EBP, and the ESP[®] are unavailable.</p> <ul style="list-style-type: none"> ► Continue driving with added caution. Wheels may lock during hard braking, reducing steering capability. ► Read and observe messages that may appear in the multifunction display (► page 270). ► Have the system checked at an authorized Mercedes-Benz Center as soon as possible. <p>Failure to follow these instructions increases the risk of an accident.</p>

Problem	Possible causes/consequences and ► Solutions
  <p>The red brake warning lamp comes on while driving. In addition, the yellow ABS indicator lamp, and the yellow ESP® warning lamp come on and an acoustic warning sounds.</p>	<p>The Electronic Brake Proportioning (EBP) switched off due to a malfunction.</p> <p>The ABS, the BAS, and the ESP® are also switched off.</p> <p>The brake system is still functioning normally but without the systems specified above available.</p> <ul style="list-style-type: none"> ► Continue driving with added caution. Wheels may lock during hard braking, reducing steering capability. ► Adjust driving to be consistent with reduced braking responsiveness. ► Read and observe messages that may appear in the multifunction display (▷ page 270). ► Have the system checked at an authorized Mercedes-Benz Center as soon as possible. <p>Failure to follow these instructions increases the risk of an accident.</p>
 (USA only)  (Canada only) <p>The red brake warning lamp comes on while driving and an acoustic warning sounds.</p>	<p>You are driving with the parking brake engaged.</p> <ul style="list-style-type: none"> ► Release the parking brake.
 (USA only)  (Canada only) <p>The red brake warning lamp comes on while the engine is running.</p>	<p>There is insufficient brake fluid in the reservoir.</p> <p>Risk of accident!</p> <ul style="list-style-type: none"> ► Do not drive any further. Stop the vehicle in a safe location as soon as it is safe to do so. ► Engage the parking brake. ► Read and observe messages that may appear in the multifunction display (▷ page 270). ► Contact an authorized Mercedes-Benz Center. <p>Do not add brake fluid! This will not solve the problem.</p>





Warning!

Driving with the brake warning lamp illuminated can result in an accident. Have your brake system checked immediately if the brake warning lamp stays on. Do not add brake fluid before checking the brake system. Overfilling the brake fluid reservoir can result in spilling brake fluid on hot engine parts and

the brake fluid catching fire. You can be seriously burned.

- ❗ If you find that the brake fluid in the brake fluid reservoir has fallen to the minimum mark or below, have the brake system checked for brake pad thickness and leaks.

Safety systems

Problem	Possible causes/consequences and ► Solutions
 The red seat belt telltale comes on for a maximum of 6 seconds after starting the engine.	<p>The seat belt telltale reminds you and your passengers to fasten your seat belts before driving off.</p> <p>► Fasten your seat belts.</p> <p>Regardless of whether the seat belts are fastened or not, the seat belt telltale always comes on and remains lit for 6 seconds after starting the engine.</p>
 The red seat belt telltale comes on. In addition you hear a warning chime for a maximum of 6 seconds after starting the engine.	<p>You have forgotten to fasten your seat belt.</p> <p>► Fasten your seat belt. The warning chime stops sounding.</p>
 The red seat belt telltale comes on while the vehicle is standing still and the engine is running or while driving.	<p>You and/or your front passenger have forgotten to fasten your seat belts.</p> <p>► Fasten your seat belts. The seat belt telltale goes out. <small>تلفن شب</small></p> <p>There are items placed on the front passenger seat and therefore the system senses the front passenger seat as being occupied.</p> <p>► Remove the items from the front passenger seat and put them in a safe place. The seat belt telltale goes out.</p>
 The red seat belt telltale flashes while driving. In addition, an intermittent warning chime sounds with increasing intensity.	<p>The vehicle's speed once exceeded 15 mph (25 km/h) and you and/or your front passenger have forgotten to fasten your seat belts.</p> <p>► Fasten your seat belts. The seat belt telltale goes out and the warning chime stops sounding.</p> <p>There are items placed on the front passenger seat and therefore the system senses the front passenger seat as being occupied.</p> <p>► Remove the items from the front passenger seat and put them in a safe place. The seat belt telltale goes out and the warning chime stops sounding.</p>

- i** After 60 seconds with an unfastened seat belt the warning chime stops sounding and the seat belt telltale illuminates continuously. The seat belt telltale will only go out if both, the driver and front passenger's seat belt are fastened, or the vehicle is standing still and a front door is opened.



Problem	Possible causes/consequences and ► Solutions
 The red SRS indicator lamp comes on while driving.	<p>There is a malfunction in the restraint systems. The air bags or Emergency Tensioning Devices (ETDs) could deploy unexpectedly or fail to activate in an accident.</p> <p>► Drive with added caution to the nearest authorized Mercedes-Benz Center.</p>





Warning!



In the event a malfunction of the SRS is indicated as outlined above, the SRS may not be operational.

For your safety, we strongly recommend that you contact an authorized Mercedes-Benz

Center immediately to have the system checked. Otherwise the SRS may not be activated when needed in an accident, which could result in serious or fatal injury, or it might deploy unexpectedly and unnecessarily which could also result in injury.

Problem	Possible causes/consequences and ► Solutions
 All models, except C 63 AMG: The yellow ESP® warning lamp comes on while the engine is running.	<p>The ESP® has been switched off.</p> <p>Risk of accident!</p> <p>When the ESP® is switched off it will not stabilize the vehicle if the system recognizes that the vehicle starts to skid or that a wheel is spinning.</p> <p>► Switch the ESP® back on.</p> <p>Exceptions: (► page 63).</p> <p>► If leaving the ESP® switched off, adapt your speed and driving to the prevailing road and weather conditions.</p> <p>► If the ESP® cannot be switched back on: Have the system checked at an authorized Mercedes-Benz Center as soon as possible.</p>
 C 63 AMG only: The yellow ESP® warning lamp comes on while the engine is running.	<p>ESP® SPORT is activated.</p> <p>Risk of accident!</p> <p>When ESP® SPORT is activated it will only stabilize the vehicle to a limited extent if the system recognizes that the vehicle starts to skid or that a wheel is spinning.</p> <p>► Switch the ESP® SPORT off (► page 64).</p> <p>The message ESP On appears in the multifunction display.</p>

Problem	Possible causes/consequences and ► Solutions
 C 63 AMG only:  The yellow ESP® warning lamp and the yellow ESP OFF warning lamp come on while the engine is running.	<p>The ESP® has been switched off. Risk of accident!</p> <p>When the ESP® is switched off it will not stabilize the vehicle if the system recognizes that the vehicle starts to skid or that a wheel is spinning.</p> <ul style="list-style-type: none"> ► Switch the ESP® back on. Exceptions: (▷ page 64). ► If leaving the ESP® switched off, adapt your speed and driving to the prevailing road and weather conditions. ► If the ESP® cannot be switched back on: Have the system checked at an authorized Mercedes-Benz Center as soon as possible.
 All models, except C 63 AMG: The yellow ESP® warning lamp comes on while the engine is running.	<p>The ESP® is not operational due to a malfunction. Risk of accident!</p> <ul style="list-style-type: none"> ► Read and observe additional messages that may appear in the multifunction display. ► Continue driving with added caution. Wheels may lock during hard braking, reducing steering capability. ► Adapt your speed and driving to the prevailing road and weather conditions. ► Have the system checked at an authorized Mercedes-Benz Center as soon as possible.
 C 63 AMG only:  The yellow ESP® warning lamp and the yellow ESP OFF warning lamp come on while the engine is running.	<p>The ESP® is not operational due to a malfunction. Risk of accident!</p> <ul style="list-style-type: none"> ► Read and observe additional messages that may appear in the multifunction display. ► Continue driving with added caution. Wheels may lock during hard braking, reducing steering capability. ► Adapt your speed and driving to the prevailing road and weather conditions. ► Have the system checked at an authorized Mercedes-Benz Center as soon as possible.



Problem	Possible causes/consequences and ► Solutions
 The yellow ESP® warning lamp flashes while driving.	<p>The ESP® or the ETS/4-ETS has come into operation because of detected traction loss in at least one tire.</p> <ul style="list-style-type: none"> ► When driving off, apply as little throttle as possible. ► While driving, ease up on the accelerator pedal. ► Adapt your speed and driving to the prevailing road and weather conditions. ► Do not deactivate the ESP®. <p>Exceptions: (► page 63).</p> <p>Failure to follow these instructions increases the risk of an accident.</p> <p>At least one wheel is spinning and the Electronic Traction System (ETS/4-ETS) has switched off to prevent overheating of the drive wheel brakes.</p> <ul style="list-style-type: none"> ► Read and observe additional messages that may appear in the multifunction display. <p>As soon as the brakes have cooled off, the Electronic Traction System (ETS/4-ETS) switches on again.</p> <p>The message in the multifunction display disappears and the ESP® warning lamp  goes out.</p>

تلفن شبانه روزی: ۰۲۱-۸۸۸۶۲۰۸۵

Vehicle

Problem	Possible causes/consequences and ► Solutions
 The yellow fuel tank reserve warning lamp comes on when the engine is running.	<p>The fuel level has gone below the reserve mark.</p> <ul style="list-style-type: none"> ► Refuel at the next gas station.

Engine

Problem	Possible causes/consequences and ► Solutions
 <p>The yellow engine malfunction indicator lamp comes on when the engine is running.</p>	<p>There may be a malfunction in</p> <ul style="list-style-type: none"> • the fuel management system • the ignition system • the emission control system • systems which affect emissions <p>Such malfunctions may result in excessive emissions values and may switch the engine to limp-home (emergency operation) mode.</p> <p>► Have the vehicle checked as soon as possible at an authorized Mercedes-Benz Center.</p> <p>i Some states may by law require you to visit a workshop as soon as the engine malfunction indicator lamp comes on. Check local requirements.</p>
 <p>The yellow engine malfunction indicator lamp comes on when the engine is running.</p>	<p>A loss of pressure has been detected in the fuel system. The fuel cap may not be closed properly or the fuel system may be leaky.</p> <ul style="list-style-type: none"> ► Check the fuel cap (► page 222). ► If it is not closed properly: Close the fuel cap. ► If it is closed properly: Have the fuel system checked by an authorized Mercedes-Benz Center.
 <p>The red coolant temperature warning lamp comes on when the engine is running.</p>	<p>There is insufficient coolant in the reservoir.</p> <p>If this warning lamp comes on frequently, there is a leak in the cooling system.</p> <p>If the coolant level is correct, the electric radiator fan may be broken.</p> <ul style="list-style-type: none"> ► Immediately add coolant to prevent engine from overheating (► page 227). ► Have the cooling system checked. ► If the coolant temperature is below 248°F (120°C), you can continue driving to the nearest authorized Mercedes-Benz Center. ► Avoid high engine loads (e.g. driving uphill) and stop-and-go driving.

Problem	Possible causes/consequences and ► Solutions
 The red coolant temperature warning lamp comes on when the engine is running and an acoustic warning sounds.	<p>The coolant temperature has exceeded 248°F (120°C).</p> <ul style="list-style-type: none"> ► Stop in a safe location as soon as possible and allow the engine and coolant to cool down.

Warning!



Driving when your engine is overheated can cause some fluids which may have leaked into the engine compartment to catch fire. You could be seriously burned.

Steam from an overheated engine can cause serious burns which can occur just by opening the engine hood. Stay away from the engine if you see or hear steam coming from it.

Stop the vehicle in a safe location away from other traffic. Turn off the engine, get out of the vehicle and do not stand near the vehicle until the engine has cooled down.

! The engine should not be operated with the coolant temperature above 248°F (120°C). Doing so may cause serious damage which is not covered by the Mercedes-Benz Limited Warranty.

Tires

Problem	Possible causes/consequences and ► Solutions
 Combination low tire pressure telltale/TPMS malfunction telltale for the Advanced TPMS illuminates continuously.	<p>The Advanced TPMS detects a loss of pressure in at least one tire.</p> <ul style="list-style-type: none"> ► Carefully bring the vehicle to a halt, avoiding abrupt steering and braking maneuvers. Observe the traffic situation around you. ► Read and observe messages in the multifunction display (> page 270). <p>If the tire inflation pressure in the respective tire(s) has (have) been corrected, the combination low tire pressure/TPMS malfunction telltale goes out after a few minutes of driving.</p>
 Combination low tire pressure telltale/TPMS malfunction telltale for the Advanced TPMS flashes 60 seconds and then stays illuminated.	<p>There is a malfunction in the Advanced TPMS.</p> <ul style="list-style-type: none"> ► Read and observe messages in the multifunction display (> page 270). ► Have the Advanced TPMS checked at an authorized Mercedes-Benz Center. <p>After the malfunction has been remedied, the combination low tire pressure/TPMS malfunction telltale goes out after a few minutes of driving.</p>

 **Warning!**

Each tire, including the spare (if provided), should be checked at least once a month when cold and inflated to the inflation pressure recommended by the vehicle manufacturer on the Tire and Loading Information placard on the driver's door B-pillar or the tire inflation pressure label on the inside of the fuel filler flap. If your vehicle has tires of a different size than the size indicated on the Tire and Loading Information placard or the tire inflation pressure label, you should determine the proper tire inflation pressure for those tires.

As an added safety feature, your vehicle has been equipped with a tire pressure monitoring system (TPMS) that illuminates a low tire pressure telltale when one or more of your tires are significantly underinflated.

Accordingly, when the low tire pressure telltale illuminates, you should stop and check your tires as soon as possible, and inflate them to the proper pressure. Driving on a significantly underinflated tire causes the tire to overheat and can lead to tire failure.

Underinflation also reduces fuel efficiency and tire tread life, and may affect the vehicle's handling and stopping ability. Please note that the TPMS is not a substitute for proper tire



maintenance, and it is the driver's responsibility to maintain correct tire pressure, even if underinflation has not reached the level to trigger illumination of the TPMS low tire pressure telltale.

Your vehicle has also been equipped with a TPMS malfunction indicator to indicate when the system is not operating properly. The TPMS malfunction indicator is combined with the low tire pressure telltale. When the system detects a malfunction, the telltale will flash for approximately 1 minute and then remain continuously illuminated. This sequence will continue upon subsequent vehicle start-ups as long as the malfunction exists. When the malfunction indicator is illuminated, the system may not be able to detect or signal low tire pressure as intended.

TPMS malfunctions may occur for a variety of reasons, including the installation of incompatible replacement or alternate tires or wheels on the vehicle that prevent the TPMS from functioning properly. Always check the TPMS malfunction telltale after replacing one or more tires or wheels on your vehicle to ensure that the replacement or alternate tires and wheels allow the TPMS to continue to function properly.

Lamp in center console

Problem	Possible causes/consequences and ► Solutions
<p>Canada only:</p>  <p>The front passenger front air bag off indicator lamp illuminates and remains illuminated (► page 47).</p>	<p>A BabySmart™ child seat is installed on the front passenger seat. Therefore the front passenger front air bag is switched off.</p> <p>The system is malfunctioning when there is no BabySmart™ child seat installed on the front passenger seat.</p> <p>► Have the system checked as soon as possible at an authorized Mercedes-Benz Center.</p>

Problem	Possible causes/consequences and ► Solutions
<p>Canada only:</p>  <p>The front passenger front air bag off indicator lamp does not illuminate or does not remain illuminated with a BabySmart™ child seat properly installed on the passenger seat.</p>	<p>The system is malfunctioning.</p> <ul style="list-style-type: none"> ► Make sure there is nothing between seat cushion and child seat. ► Check installation of the child seat (► page 57). <p>If the front passenger front air bag off indicator lamp remains out:</p> <ul style="list-style-type: none"> ► Have the system checked as soon as possible at an authorized Mercedes-Benz Center. <p>Do not use the BabySmart™ restraint to transport children on the front passenger seat until the system has been repaired.</p>
<p>USA only:</p>  <p>The front passenger front air bag off indicator lamp illuminates and remains illuminated with the weight of a typical adult or someone larger than a small individual on the front passenger seat.</p>	<p>The system is malfunctioning.</p> <ul style="list-style-type: none"> ► Have the system checked as soon as possible at an authorized Mercedes-Benz Center. ► Read and observe messages in the multifunction display and follow corrective steps (► page 270). <p>امداد خودرو فارما</p> <p>تلفن شبانه روزی: ۰۲۱-۸۸۸۶۲۰۸۵</p>

Warning!

If the  indicator lamp illuminates and remains illuminated with the weight of a typical adult or someone larger than a small

individual on the front passenger seat, do not have any passenger use the front passenger seat until the system has been repaired.

Problem	Possible causes/consequences and ► Solutions
<p>USA only:</p>  <p>The front passenger front air bag off indicator lamp does not illuminate and/or does not remain illuminated with the weight of a typical 12-month-old child in a standard child restraint or less on the front passenger seat.</p>	<p>The system is malfunctioning.</p> <ul style="list-style-type: none"> ► Make sure there is nothing between seat cushion and child seat and check installation of the child seat. ► Make sure no objects applying supplemental weight onto the seat are present. ► If the front passenger front air bag off indicator lamp remains out, have the system checked as soon as possible at an authorized Mercedes-Benz Center. Do not transport a child on the front passenger seat until the system has been repaired. ► Read and observe messages in the multifunction display and follow corrective steps (► page 270).

Warning!

If the  indicator lamp does not illuminate or remains out with the weight of a typical 12-month-old child in a standard child restraint or less on the front passenger seat, do not transport a child on the front passenger seat until the system has been repaired.

Unlocking/locking manually**Unlocking the vehicle**

If you cannot unlock the vehicle with the SmartKey or with KEYLESS-GO, unlock the driver's door and the trunk using the mechanical key.

The anti-theft alarm system will trigger when you

- unlock the driver's door or the trunk with the mechanical key and
- open the driver's door or the trunk

To cancel the alarm, insert the SmartKey into the starter switch.

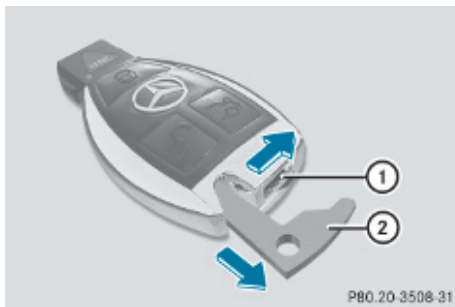
Removing the mechanical key

- ▶ Move locking tab ① in the direction of arrow.
- ▶ Slide mechanical key ② out of the housing.

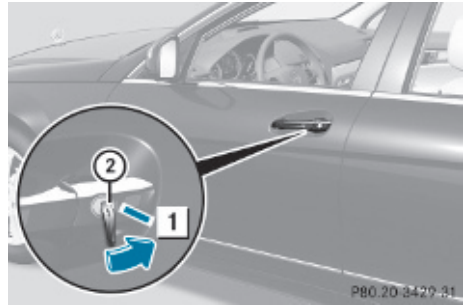
Unlocking the driver's door

- ▶ Insert mechanical key ② into the driver's door lock.
- ▶ Turn mechanical key ② counterclockwise to position ①.
- ▶ Pull the door handle to open the driver's door.
- ▶ Turn mechanical key ② back and remove it from the driver's door lock.

Unlocking the trunk

A minimum height clearance of 5.9 ft (1.8 m) is required to open the trunk lid.

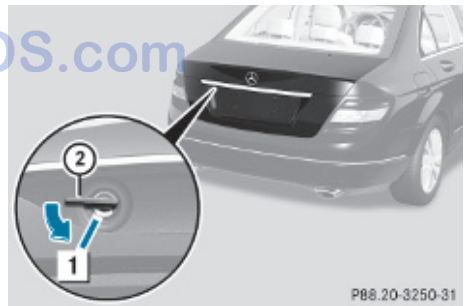

- ▶ Insert mechanical key ② into the trunk lid lock.
- ▶ Turn mechanical key ② counterclockwise to position ①.

! When you open the trunk, the trunk lid swings open upwards. Always make sure there is sufficient overhead clearance.

- ▶ Turn mechanical key ② back and remove it from the trunk lid lock.

Locking the vehicle

If you cannot lock the vehicle with the SmartKey or with KEYLESS-GO, lock it as follows:

- ▶ Open the driver's door.
- ▶ Close the front passenger door, the rear doors, and the trunk.
- ▶ Press the central locking switch (▷ page 75).
The locking knobs of the front passenger door and the rear doors move down.
- ▶ **If the vehicle battery is disconnected or drained:** Press down the locking knobs on the front passenger door and the rear doors.
- ▶ Exit the vehicle.
- ▶ Close the driver's door.

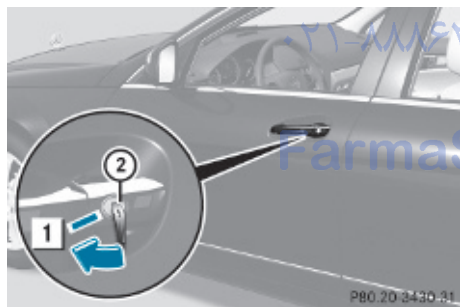

- ▶ Remove mechanical key ② from the SmartKey (▷ page 309).
- ▶ Insert mechanical key ② into the driver's door lock.
- ▶ Turn mechanical key ② clockwise to position ①.
The vehicle is locked.
- ▶ Turn mechanical key ② back and remove it from the driver's door lock.

- ▶ Check whether the doors and the trunk are locked.
- ▶ If necessary, lock the trunk with the mechanical key (▷ page 77).

i This procedure does not arm the anti-theft alarm system, nor does it lock the fuel filler flap.

Fuel filler flap

Warning!

Avoid contact with the vehicle walls as they may contain sharp edges. Otherwise, you could injure yourself while releasing the fuel filler flap.

In case the central locking system does not release the fuel filler flap, you can open it manually.

The fuel filler flap release is located on the passenger side in the trunk behind the cover.

- ▶ Open the trunk (▷ page 75).
- ▶ Open the fuse box cover in the trunk (▷ page 329).

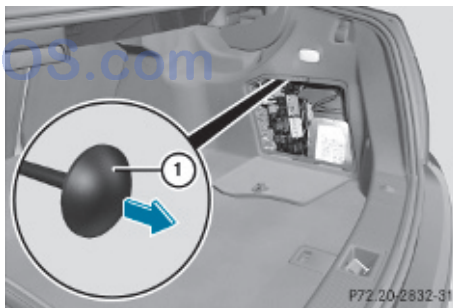

- ▶ Pull fuel filler flap release ① in direction of arrow.
The fuel filler flap is unlocked.
- ▶ Open the fuel filler flap (▷ page 222).
- ▶ Close the cover.
- ▶ Close the trunk.

Manually unlocking the gear selector lever

If the vehicle's electrical system is malfunctioning, the gear selector lever could remain locked in park position **P**. In this case the gear selector lever can be unlocked manually, e.g. to tow the vehicle.

- ▶ Engage the parking brake.

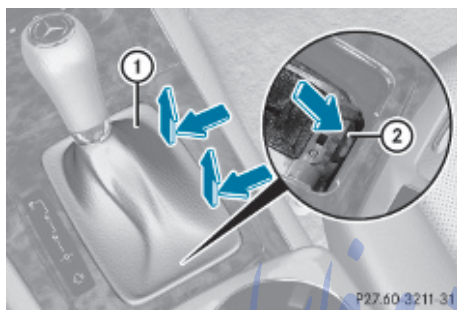

! Do not use sharp objects to loosen the gear selector lever cover in the center console, as this could damage the gear selector lever cover or the center console.

- ▶ Insert a flat, blunt object into the right edge of gear selector lever cover ① at the positions indicated by the arrows.
- ▶ Loosen gear selector lever cover ① using this object.
- ▶ Pull gear selector lever cover ① out and remove.
- ▶ Simultaneously push down release ② and move the gear selector lever out of park position **P**.
The gear selector lever is unlocked.

i The gear selector lever is locked again as soon as you move it back to park position **P**.

Resetting activated NECK-PRO active front head restraints

If the NECK-PRO active front head restraints have been triggered in a rear-end collision, they must be reset.

You can tell that the NECK-PRO active front head restraints have been triggered when they have been moved forward and cannot be adjusted.

⚠ Warning!

For safety reasons, have the NECK-PRO active front head restraints checked at an authorized Mercedes-Benz Center after a rear-end collision.

⚠ Warning!

When pushing back the head restraint cushion, make sure your fingers do not become caught between the head restraint cushion and the cover. Failing to do so may lead to injury.

- i** Pressing the head restraint cushion back requires high force. If you encounter difficulties when pushing the head restraint back, please have the procedure performed at an authorized Mercedes-Benz Center.

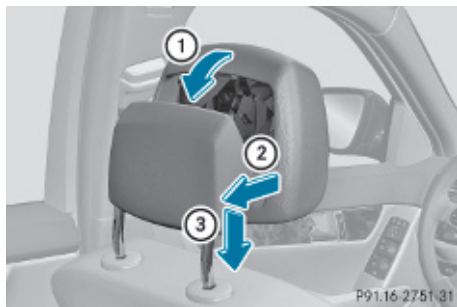

- ▶ Push the head restraint cushion at the bottom, back as far as possible ②.
- ▶ Push the head restraint cushion down into the guide ③.

- ▶ Fold the head restraint cushion by the top, back firmly until it engages ①.
- ▶ Repeat this procedure on the NECK-PRO active front head restraint for the second front seat.

For information on NECK-PRO active front head restraints, see “NECK-PRO active front head restraints” (▷ page 52).

For information on head restraint adjustment, see “Seats” (▷ page 79).

- ▶ **i** The required replacement batteries are available at any authorized Mercedes-Benz Center.

Replacement batteries: Lithium, type CR 2025 or equivalent.

- ▶ Remove the mechanical key from the SmartKey (▷ page 309).

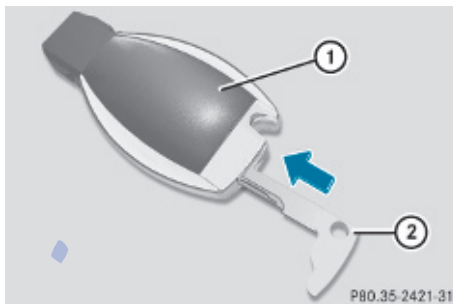

- ▶ Press mechanical key ② into the SmartKey opening until battery compartment cover ① opens. Do not keep the cover shut.



- ▶ Remove the battery compartment cover.
- ▶ Pat the SmartKey against the palm of your hand until battery ③ falls out.
- ▶ Insert the new battery with the positive terminal (+) facing up. Use a lint-free cloth.
- ▶ Insert the tabs of the battery compartment cover into the housing and press the cover closed.
- ▶ Check the operation of the SmartKey as well as the KEYLESS-GO function.

Replacing SmartKey batteries

If the batteries in the SmartKey are discharged, the vehicle can no longer be locked or unlocked. It is recommended to have the batteries replaced at an authorized Mercedes-Benz Center.

⚠ Warning!

Batteries contain poisonous and corrosive substances. Therefore, keep the batteries out of reach of children.

If a battery is swallowed, seek medical help immediately.

⚠ Warning!

SmartKey batteries contain perchlorate material, which may require special handling and regard for the environment. Check with your local government's disposal guidelines. California residents, see www.dtsc.ca.gov/HazardousWaste/Perchlorate/index.cfm.

Batteries contain materials that can harm the environment if disposed of improperly. Recycling of batteries is the preferred method of disposal. Many states (USA only) or provinces (Canada only) require sellers of batteries to accept old batteries for recycling. When inserting the batteries, make sure they are clean and free of lint.

When replacing batteries, always replace both batteries.

Replacing bulbs

Safety notes

Safe vehicle operation depends on proper exterior lighting and signaling to a large degree.

Correct headlamp adjustment is extremely important. Have headlamps checked and readjusted at regular intervals and when a bulb has been replaced. Contact an authorized Mercedes-Benz Center for headlamp adjustment.

Warning!

Bulbs and bulb sockets can be very hot. Allow the lamp to cool down before changing a bulb.

Keep bulbs out of reach of children.

Halogen lamps contain pressurized gas. A bulb can explode if you

- touch or move it when hot
- drop the bulb
- scratch the bulb

Wear eye and hand protection.

Because of high voltage in Xenon lamps, it is dangerous to replace the bulb or repair the lamp and its components. We recommend that you have such work done by a qualified technician.

- i** Since replacing bulbs is a technically highly demanding process, we recommend to have them replaced at an authorized Mercedes-Benz Center.
- i** If the headlamps or front fog lamps are fogged up on the inside as a result of high humidity, driving the vehicle a distance with the lights on should clear up the fogging.

تلفن شبانه روزی: +۲۱-۸۸۸۶۲۰۸۵

FarmaSOS.com

Bulbs

You can replace the following bulbs yourself:

Halogen headlamps

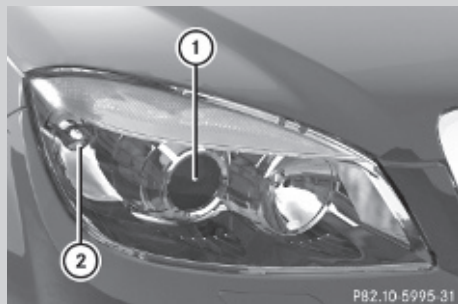

Type

- ① Low-beam lamp: H7 55 W
- ② Turn signal lamp: 3457A

Bi-Xenon headlamps



Type

- ① Turn signal lamp: Turn signal lamp: 3457A

Rear lamps

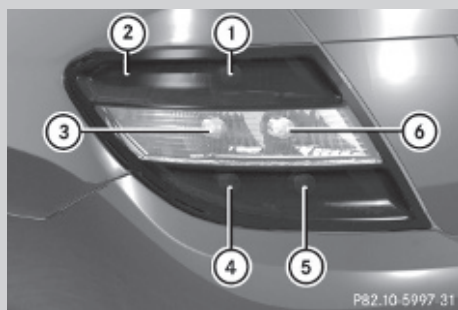

Type

- ① Passenger side: Tail lamp P 21 W
Driver's side: Tail lamp and rear fog lamp P 21 W
- ② Side marker lamp: W 5 W
- ③ Turn signal lamp: PY 21 W
- ④ Tail lamp, brake lamp: P 21 W
- ⑤ Tail lamp, brake lamp: P 21 W
- ⑥ Backup lamp: P 21 W

Notes on bulb replacement

- ❗ Do not replace LEDs or bulbs not described in this section. You could otherwise damage the LEDs, the bulbs or parts of the vehicle. Only have the LEDs and

bulbs replaced at an authorized Mercedes-Benz Center.

امداد خود و فاریا

تلفن شبانه روزی: ۰۸۵ ۸۸۱۶۲۰۸۵

FarmaSOS.com

⚠ Observe Safety notes, see page 313.

- Only use 12-volt bulbs of the same type and with the specified watt rating.
- Switch the lights off before changing a bulb to prevent short circuits.
- Always use a clean lint-free cloth when handling bulbs.
- Your hands should be dry and free of oil and grease.
- If the newly installed bulb does not come on, contact an authorized Mercedes-Benz Center.

i Mercedes-Benz recommends using Longlife (LL) bulbs.

Replacing bulbs for front lamps

- ▶ Switch off the ignition.
- ▶ Turn the exterior lamp switch to position **0**.
- ▶ Open the hood (▶ page 224).

⚠ Warning!

Do not remove the cover for the Bi-Xenon headlamp. Because of high voltage in Xenon lamps, it is dangerous to replace the bulb or repair the lamp and its components. It is recommended to have such work done by a qualified technician.

Low-beam bulb (halogen headlamps only)

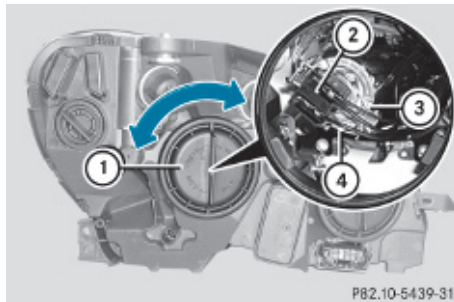

- ▶ Turn housing cover **1** counterclockwise and remove it.
- ▶ Pull electric plug **2** off the bulb **4**.
- ▶ Remove wire clip **3** from bulb holder by pushing down and release from arrestor hook.
- ▶ Pull bulb **4** at its socket out of bulb holder.
- ▶ Insert the new bulb so that its socket locates in the recess of bulb holder and is level to it.
- ▶ Fold wire clip **3** back and press it down on bulb holder to engage it in the arrestor hook.
- ▶ Connect electric plug **2** on bulb **4**.
- ▶ Align housing cover and turn it clockwise.

Front turn signal lamp bulb

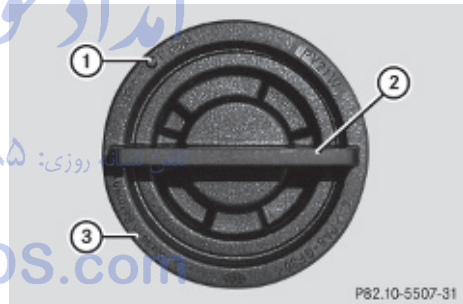

- ▶ Turn bulb socket **3** with handle **2** counterclockwise and remove it.
- ▶ Pull bulb out of bulb socket **3**.
- ▶ Gently press the new bulb into bulb socket **3** until the bulb engages.
- ▶ Place bulb socket **3** back into the housing. Handle **2** must be in a horizontal line and mark **1** must be on the upper part (driver's side headlamp) or lower part (passenger-side headlamp).
- ▶ Turn bulb socket **3** clockwise until it engages.

Replacing bulbs for rear lamps

Before you start to replace a bulb for a rear lamp, do the following:

- ▶ Switch off the ignition.
- ▶ Turn the exterior lamp switch to position **0**.
- ▶ Open the trunk.

Tail lamp unit

- ▶ Driver's side: Lift up the bottom and pull out the trim panel covering the driver side rear light.
- ▶ Passenger side: Open the fuse box in the trunk (▷ page 329).

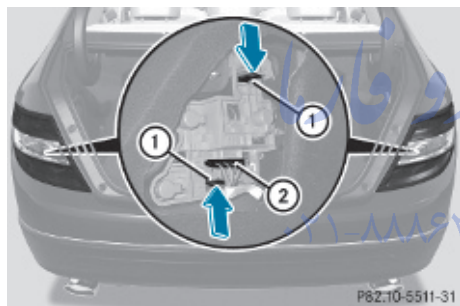

- ▶ Disconnect electrical connector **2**.
- ▶ Pull tabs **1** in direction of arrows.
- ▶ Remove the bulb carrier.

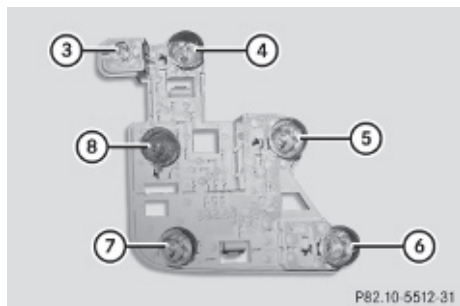

Bulb carrier

- ③ Side marker lamp
- ④ Rear fog lamp (driver's side only), side marker lamp

- ⑤ Backup lamp
- ⑥ Tail lamp, brake lamp
- ⑦ Tail lamp, brake lamp, parking and standing lamp
- ⑧ Turn signal lamp

Side marker lamp

- ▶ Turn the bulb socket on backside of tail lamp unit counterclockwise and remove side marker lamp **3** with bulb socket.
- ▶ Turn the new bulb with socket on backside of tail lamp unit clockwise until it engages.

Other lamps

- ▶ Depending on which bulb needs to be replaced, press gently onto the respective bulb and turn it counterclockwise out of its bulb socket.
- ▶ Gently press the new bulb into its bulb socket and turn it clockwise until it engages.

Reinstall bulb carrier

- ▶ Reinstall the bulb carrier and let tabs **1** (▷ page 316) engage.
- ▶ Connect the electrical connector **2** (▷ page 316) until it engages.
- ▶ Reinstall trim panel.

Replacing wiper blades

Safety notes

⚠ Warning!

For safety reasons, switch off the wipers and remove the SmartKey from the starter switch (vehicles with KEYLESS-GO: Make sure the vehicle's on-board electronics have status **0**) before replacing a wiper blade. Otherwise, the wiper motor could suddenly turn on and cause injury.

Warning!

Wiper blades are components that are subject to wear and tear. Replace the wiper blades twice a year, preferably in the spring and fall. Otherwise the windshield will not be wiped properly. As a result, you may not be able to observe surrounding traffic conditions and could cause an accident.

- ❗ Never open the hood when a wiper arm is folded forward.

Hold on to the wiper when folding a wiper arm back. If released, the force of the impact from the tensioning spring could crack the windshield.

Do not allow a wiper arm to contact the windshield glass without a wiper blade inserted.

Mercedes-Benz recommends that you have this work carried out at an authorized Mercedes-Benz Center.

- ▶ Remove the SmartKey from the starter switch.

Vehicles with KEYLESS-GO:

- ▶ Make sure the vehicle's on-board electronics have status 0 (▶ page 78).

Removing wiper blades

- ❗ Do not pull on the wiper blade inserts. They could tear.
- ▶ Fold the wiper arm forward until it snaps into place.

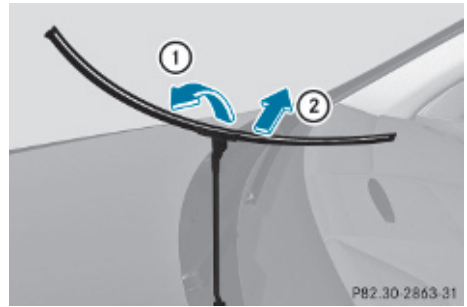

- ▶ Turn the wiper blade in direction of arrow ①.
- ▶ Slide the wiper blade sideways out of the retainer in the direction of arrow ②.

Installing wiper blades

- ▶ Slide the wiper blade onto the wiper arm until it locks in place.
- ▶ Rotate the wiper blade into a position parallel to the wiper arm.
- ▶ Fold the wiper arm backward to rest on the windshield. تلفن: ۰۲۱-۸۸۶۲۰۸۵

Make sure you hold on to the wiper when folding the wiper arm back.

- ❗ Make sure the wiper blades are installed properly. Improperly installed wiper blades may cause windshield damage.

Flat tire**Safety notes****Warning!**

The dimensions of the spare wheel are different from those of the road wheels. As a result, the vehicle handling characteristics change when driving with a spare wheel mounted. Adapt your driving style accordingly.

The spare wheel is for temporary use only. When driving with a spare wheel mounted, ensure proper tire inflation pressure and do

not exceed a vehicle speed of 50 mph (80 km/h).

Contact the nearest authorized Mercedes-Benz Center as soon as possible to have the spare wheel replaced with a regular road wheel.

Never operate the vehicle with more than one spare wheel mounted.

Do not switch off the ESP® when a spare wheel is mounted.

Preparing the vehicle

- ▶ Whenever possible, park the vehicle in a safe distance from moving traffic on a hard, flat surface.
- ▶ Turn on the hazard warning flasher.
- ▶ Turn the steering wheel so that the front wheels are in a straight-ahead position.
- ▶ Engage the parking brake.
- ▶ Shift the automatic transmission into park position **P** (manual transmission to **1st** or reverse gear **R**).
- ▶ Turn off the engine.
- ▶ Remove the SmartKey from the starter switch.

or

- ▶ Vehicles with KEYLESS-GO: Open the driver's door (this puts the starter switch in position **O**, same as with the SmartKey removed from the starter switch). The driver's door can then be closed again. Open doors only when conditions are safe to do so.
- ▶ Vehicles with KEYLESS-GO: Remove the KEYLESS-GO start/stop button from the starter switch.
- ▶ Have any passenger exit the vehicle at a safe distance from the roadway. Open doors only when conditions are safe to do so.

Mounting the spare wheel

Introduction

- ▶ Prepare the vehicle as described (▷ page 318).
- ▶ Take the following out of the vehicle:
 - spare wheel
 - jack
 - vehicle tool kit box

For information on where to find the respective items, see “Where will I find ...?” (▷ page 268) and (▷ page 270).

- i** Vehicles without spare wheel are not factory-equipped with the tools required for a wheel change such as a jack or a wheel wrench. Some tools required for a wheel change are specific to your vehicle. Contact an authorized Mercedes-Benz Center to obtain the tools approved for your vehicle. This section describes the wheel change using the tools approved and recommended for your vehicle.

Lifting the vehicle

Warning!

When jacking up the vehicle, only use the jack which has been specifically approved by Mercedes-Benz for your vehicle.

The jack is designed exclusively for jacking up the vehicle at the jack take-up brackets built into both sides of the vehicle. Make sure the jack arm is fully seated in the jack take-up bracket. The jack must always be vertical when in use, especially on inclines or declines.

The jack is intended only for lifting the vehicle briefly for wheel changes. It is not suited for performing maintenance work under the vehicle. To help avoid personal injury, use the jack only to lift the vehicle during a wheel change.

Never get beneath the vehicle while it is supported by the jack. Keep hands and feet

away from the area under the lifted vehicle. Always lower the vehicle onto sufficient capacity jackstands before working under the vehicle.

Always engage the parking brake firmly and block the wheels with wheel chocks or other sizeable objects before raising the vehicle with the jack. Do not disengage the parking brake while the vehicle is raised.

Make sure that the ground on which the vehicle is standing and where you place the jack is solid, level and not slippery. If necessary, use a large underlay. On slippery surfaces, such as tiled floors, you should use a non-slip underlay, for example a rubber mat.

Do not use wooden blocks or similar objects to support the jack. Otherwise the jack may not be able to achieve its load-bearing capacity if it is not at its full height.

Never start the engine when the vehicle is raised.

Also observe the notes on the jack.

- ▶ Prevent the vehicle from rolling away by blocking wheels with wheel chocks or other sizeable objects.

When your vehicle is equipped with a wheel chock, it is included with the vehicle tool kit (▷ page 268). For information on setting up the collapsible wheel chock, see (▷ page 269).

When changing a wheel on a level surface:

- ▶ Place a wheel chock or other sizeable object in front of and another wheel chock or other sizeable object behind the wheel that is diagonally opposite to the wheel being changed.

Always try lifting the vehicle using the jack on a level surface. However, should circumstances require you to do so on a hill:

- ▶ Place wheel chocks or other sizeable objects on the downhill side in front of both wheels on the side opposite to the side on which the wheel is to be changed.

Warning!

Only jack up the vehicle on level ground or on slight inclines/declines. Otherwise, the vehicle could fall off the jack and injure you or others.

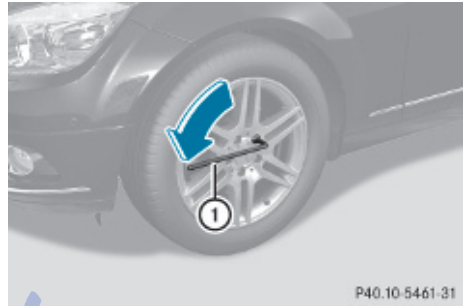

- ▶ On the wheel to be changed, loosen but do not yet remove the wheel bolts (approximately one full turn with wheel wrench ①).

The jack take-up brackets are located directly behind the front wheel housings and in front of the rear wheel housings.

Warning!

The jack is designed exclusively for jacking up the vehicle at the jack take-up brackets. Make sure the jack arm is fully seated in the jack take-up bracket.

If you do not position the jack correctly in the jack take-up bracket, the vehicle can fall off the jack and seriously or fatally injure you or others.

- ❗ Do not position the jack on the body of the vehicle, as this may cause damage to the vehicle.

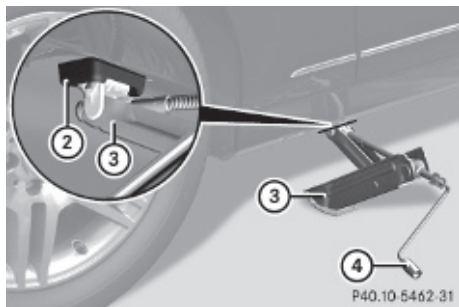

- ▶ Place jack ③ on firm ground.
- ▶ Position jack ③ under take-up bracket ② so that it is always vertical as seen from the side, even if the vehicle is parked on an incline.

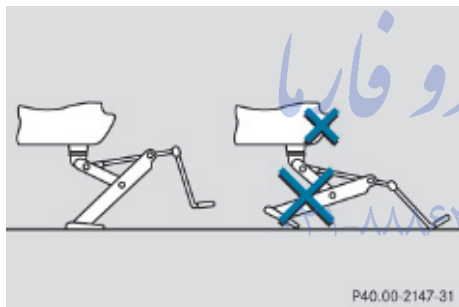

- ▶ Turn crank ④ clockwise until jack ③ is fully seated in take-up bracket ② and the jack base evenly meets the ground.
- ▶ Jack up the vehicle until the wheel is a maximum of 1.2 in (3 cm) from the ground.

Removing the wheel

- ▶ Unscrew and remove the wheel bolts.
- ❗ Do not place wheel bolts in sand or dirt. This could result in damage to the wheel bolts and wheel hub threads.
- ▶ Remove the wheel.

Attaching the spare wheel

⚠ Warning!

Always replace wheel bolts that are damaged or rusted.

Never apply oil or grease to wheel bolts.

Damaged wheel hub threads should be repaired immediately. Do not continue to drive under these circumstances! Contact an authorized Mercedes-Benz Center or call Roadside Assistance.

Incorrect wheel bolts or improperly tightened wheel bolts can cause the wheel to come off. This could cause an accident. Make sure to use the correct wheel bolts.

⚠ Warning!

Only use genuine Mercedes-Benz wheel bolts. Other wheel bolts may come loose.

Do not tighten the wheel bolts when the vehicle is raised. Otherwise the vehicle could fall off the jack.

- ▶ Clean contact surfaces of wheel and wheel hub. *تلفن شماره روزی: ۸۸۳۲۰۸۸*

- ❗ To avoid paint damage, place wheel flat against hub and hold it there while installing first wheel bolt.

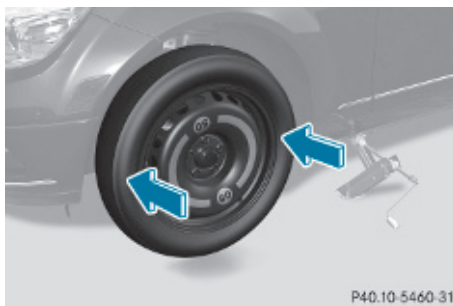

- ▶ Guide the spare wheel onto the wheel hub and push it on.
- ▶ Insert the wheel bolts and tighten them slightly.

Lowering the vehicle

- ▶ Lower the vehicle by turning the crank counterclockwise until the vehicle is resting fully on its own weight.
- ▶ Remove the jack.

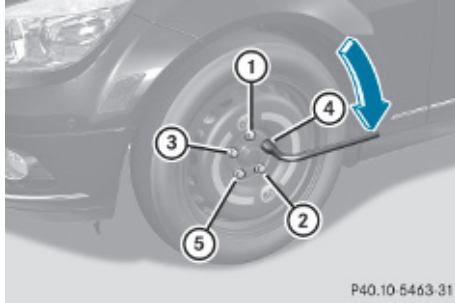

- ▶ Tighten the five wheel bolts evenly, following the diagonal sequence illustrated (① to ⑤), until all bolts are tight. Observe a tightening torque of 96 lb-ft (130 Nm).

Warning!

Have the tightening torque checked after changing a wheel. The wheels could come loose if they are not tightened to a torque of 96 lb-ft (130 Nm).

- ▶ Fully collapse the jack, with handle folded in (storage position), see (▷ page 269).
- ▶ Store the jack and the other vehicle tools in the designated storage space.

For information on storing the spare wheel after it has been replaced by a regular road wheel, see (▷ page 270).

- i** Vehicles with TPMS: Do not restart the tire inflation pressure monitor until a full size wheel/tire with functioning sensor has been placed back into service on the vehicle.

Battery

Safety notes

A battery should always be sufficiently charged in order to achieve its rated service life. Refer to Maintenance Booklet for battery maintenance intervals.

If you use your vehicle mostly for short-distance trips, you will need to have the battery charge checked more frequently.

When replacing a battery, always use a battery approved by Mercedes-Benz.

If you do not intend to operate your vehicle for an extended period of time, contact an authorized Mercedes-Benz Center about steps you need to observe.

Warning!

Observe all safety instructions and precautions when handling automotive batteries.



Risk of explosion.



Fire, open flames and smoking are prohibited when handling batteries. Avoid creating sparks.



Battery acid is caustic. Do not allow it to come into contact with skin, eyes or clothing.



Wear suitable protective clothing, especially gloves, apron and faceguard.

Wear eye protection.

Rinse any acid spills immediately with clear water. Contact a physician if necessary.



Keep children away.



Follow the instructions in this Operator's Manual.

A battery contains materials that can harm the environment if disposed of improperly. A large 12 V storage battery contains lead. Recycling of the battery is the preferred method of disposal. Many states (USA only) or provinces (Canada only) require sellers of batteries to accept the old battery for recycling.

Warning!

Failure to follow these instructions can result in severe injury or death.

Never lean over batteries while connecting. You might get injured.

Battery fluid contains sulfuric acid. Do not allow this fluid to come in contact with eyes, skin or clothing. In case it does, immediately flush affected area with water and seek medical help if necessary.

A battery will also produce hydrogen gas, which is flammable and explosive. Keep flames or sparks away from battery, avoid improper connection of jumper cables, smoking etc.

Warning!

Do not place metal objects on the battery as this could result in a short circuit.

Use leak-proof batteries only to avoid the risk of acid burns in the event of an accident.

Take care that you do not become statically charged, e.g. by wearing synthetic clothing or rubbing against textiles. For this reason, you also should not pull or push the battery over carpets or other synthetic materials.

Never touch the battery first. First touch the outside body of the vehicle in order to release any possible electrostatic charges.

Do not rub the battery with rags or cloths. The battery could explode if touched due to electrostatic charge or due to spark formation.

! As any other battery, the battery may discharge if you do not operate the vehicle for an extended period of time. Have the battery disconnected at a qualified workshop or an authorized Mercedes-Benz Center in such a case. You may also connect an accessory battery charge unit expressly approved by Mercedes-Benz for your vehicle model to maintain the battery charge. Contact an authorized Mercedes-Benz Center for further information.

The battery, the battery ventilation hose and the lateral plug must always be securely installed when the vehicle is in operation.

! Never loosen or detach battery terminal clamps while the engine is running or the SmartKey is in the starter switch or KEYLESS-GO button is in position **1**. Otherwise the alternator and other electronic components could be severely damaged.

Have the battery checked regularly at an authorized Mercedes-Benz Center.

Refer to Maintenance Booklet for maintenance intervals or contact an authorized Mercedes-Benz Center for further information.

i After battery power was interrupted, do the following:

- Reset the automatic exterior mirror fold in function (▷ page 88).
- Set the clock (▷ page 132). Vehicles with COMAND: see separate COMAND operating instructions.

Charging the battery

Warning!

Never charge a battery while still installed in the vehicle unless the accessory battery charge unit approved by Mercedes-Benz is being used. Gases may escape during charging and could cause an explosion that may result in personal injury, paint damage or corrosion.

An accessory battery charge unit specially adapted for Mercedes-Benz vehicles and tested and approved by Mercedes-Benz is available. It permits the charging of the battery in its installed position. Contact an authorized Mercedes-Benz Center for information and availability.

Charge battery in accordance with the separate instructions for the accessory battery charger.

Have the battery charged at an authorized Mercedes-Benz Center. If you charge the battery yourself, follow the operating instructions for your charging device.

Only use a battery charge unit with a maximum charging voltage of 14.8 V.

- ▶ Charge battery in accordance with the instructions of the battery charger manufacturer.

Jump starting

Warning!

Failure to follow these directions will cause damage to the electronic components, and can lead to a battery explosion and severe injury or death.

Never lean over batteries while connecting or jump starting. You might get injured.

Battery fluid contains sulfuric acid. Do not allow this fluid to come in contact with eyes, skin or clothing. In case it does, immediately

flush affected area with water, and seek medical help if necessary.

A battery will also produce hydrogen gas, which is flammable and explosive. Keep flames or sparks away from battery, avoid improper connection of jumper cables, smoking, etc.

Attempting to jump start a frozen battery can result in it exploding, causing personal injury.

Read all instructions before proceeding.

- ❗ Vehicles with automatic transmission and/or 4MATIC:

Do not tow-start the vehicle. You could otherwise seriously damage the automatic transmission which is not covered by the Mercedes-Benz Limited Warranty.

- ❗ Jump starting should only be performed using the jump-start terminals located in the engine compartment.

Avoid repeated and lengthy starting attempts.

Do not attempt to start the engine using a battery quick-charge unit.

If the engine does not run after several unsuccessful starting attempts, have it checked at the nearest authorized Mercedes-Benz Center.

Excessive unburned fuel generated by repeated failed starting attempts may damage the catalytic converter and may present a fire risk.

Make sure the jumper cables do not have loose or missing insulation.

Make sure the cable clamps do not touch any other metal part while the other end is still attached to a battery.

If the battery is discharged, the engine can be started with jumper cables and the fully charged battery of another vehicle or an equivalent starter pack. Observe the following:

- Access to the battery is not possible on all vehicles. If you cannot access the battery

of the other vehicle, provide jump start power by an external battery or starter pack.

- Jump starting should only be performed when the engine and catalytic converter are cold.
- Do not jump start the engine or charge the battery if the battery is frozen. Let the battery thaw out first.
- Only jump start from batteries with the same voltage rating (12 V). Jump starting with a more powerful battery could damage the vehicle's electrical system. Such damage will not be covered by the Mercedes-Benz Limited Warranty.
- Only use jumper cables with sufficient cross-section and insulated terminal clamps.

- Always make sure the jumper cables are not on or near pulleys, fans or other parts that move when an engine is started or running.
- Should the battery be drained completely, let the donating power source charge the vehicle for several minutes before reattempting the starting process.

The jump-start contacts are located in the engine compartment on the passenger side.

- ▶ Make sure the two vehicles do not touch.
- ▶ Switch off all electrical consumers.
- ▶ Engage the parking brake.
- ▶ Make sure the automatic transmission is in park position **P** (manual transmission to Neutral).
- ▶ Open the hood (▶ page 224).

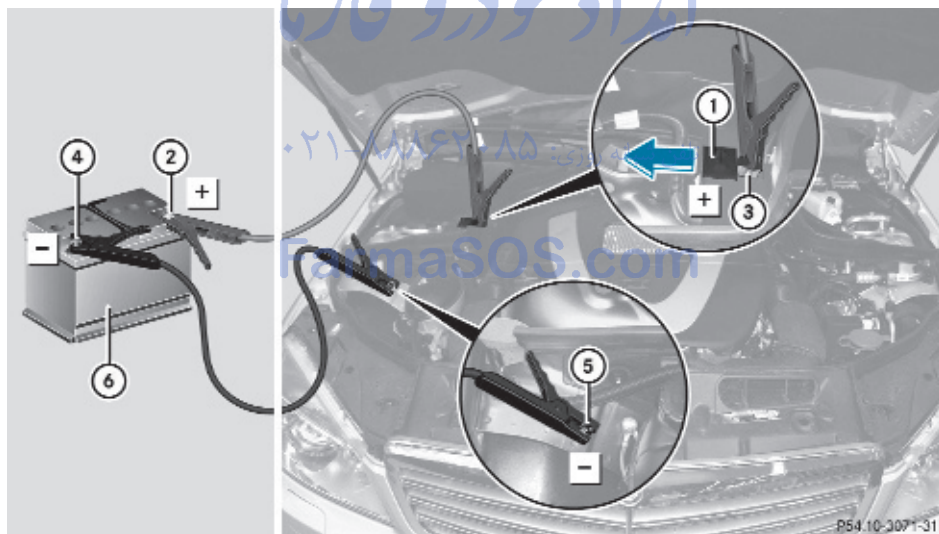

Position ⑥ represents the charged battery of another vehicle or an equivalent starter pack.

- ▶ Slide cover ① from positive terminal ③ in direction of arrow.

! Never invert the terminal connections!

- ▶ Connect positive terminal ② of charged battery ⑥ with positive terminal ③ with a jumper cable. Clamp the cable to positive terminal ② of charged battery ⑥ first.
- ▶ Start engine of the vehicle with charged battery ⑥ and run at idle speed.

- ▶ Connect negative terminal ④ of charged battery ⑥ with negative terminal ⑤ with a jumper cable. Clamp the cable to negative terminal ④ of charged battery ⑥ first.
- ▶ Start engine of the vehicle with the discharged battery and run at idle speed. You can now turn on the electrical consumers. Do not switch on the headlamps under any circumstances.
- ▶ Remove the jumper cables from negative terminals ④ and ⑤ first.
- ▶ Remove the jumper cables from positive terminals ② and ③.
You can now switch on the headlamps.
- ▶ Slide cover ① from positive terminal ③ back.
- ▶ Have the battery checked at the nearest authorized Mercedes-Benz Center.

vehicle. You could otherwise seriously damage the automatic transmission which is not covered by the Mercedes-Benz Limited Warranty.

- Do not tow with sling-type equipment. Towing with sling-type equipment over bumpy roads will damage radiator and supports.
- Towing of the vehicle should only be done using the properly installed towing eye bolt. Never attach a tow cable, tow rope or tow rod to the vehicle chassis, frame or suspension parts.

Warning!

With the engine not running, there is no power assistance for the brake and steering systems. In this case, it is important to keep in mind that a considerably higher degree of effort is necessary to brake and steer the vehicle. Adapt your driving accordingly.

Towing the vehicle

Safety notes

Mercedes-Benz recommends that the vehicle be transported with all wheels off the ground using flatbed or appropriate wheel lift/dolly equipment. This method is preferable to other types of towing.

- !** To prevent damage during transport, do not tie down vehicle by its chassis or suspension parts.

If circumstances do not permit the recommended towing methods, the vehicle may be towed with all wheels on the ground or front axle raised (except vehicles with 4MATIC) only so far as necessary to have the vehicle moved to a safe location where the recommended towing methods can be employed.

- !** Before towing the vehicle observe the following instructions:

- Vehicles with automatic transmission and/or 4MATIC: Do not tow-start the

- !** Avoid pulling the vehicle abruptly or diagonally, since it could result in damage to the chassis alignment.

- !** Do not use the towing eye bolt for recovery, as this could damage the vehicle. If in doubt, recover the vehicle with a crane.

- i** If the battery is disconnected or discharged
 - the SmartKey will not turn in the starter switch
 - Vehicles with automatic transmission: the automatic transmission will remain in park position **P**

For more information see “Battery” (▷ page 321) or “Jump starting” (▷ page 323).

Vehicles with automatic transmission: For information on manually unlocking the gear selector lever, see (▷ page 311).

Installing towing eye bolt

Depending on whether you are towing a vehicle or you are being towed, the towing eye bolt can be screwed into threaded holes which are located behind covers on each bumper.

The towing eye bolt is supplied with the vehicle tool kit, located underneath the trunk floor (▷ page 268).

- ▶ Take the vehicle tool kit out of the trunk.

Removing cover in front bumper



- ▶ Press mark on cover ① as indicated by the arrow.
- ▶ Lift cover ① off to reveal the threaded hole for the towing eye bolt.

Removing cover in rear bumper

Warning!

In order to avoid possible serious burns or injury, use extreme caution when removing the rear cover, because the rear exhaust pipe is extremely hot.

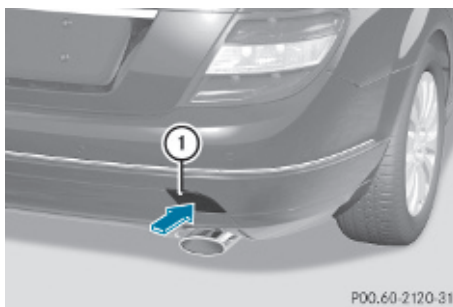

- ▶ Press mark on cover ① as indicated by the arrow.
- ▶ Lift cover ① off to reveal the threaded hole for the towing eye bolt.

Fixing towing eye bolt



Example illustration front bumper

- ▶ Take the towing eye bolt and, if so equipped, the wheel wrench from the vehicle tool kit (▷ page 268).
- ▶ Screw towing eye bolt ② clockwise into threaded hole to its stop.
- ▶ Insert wheel wrench into towing eye and tighten towing eye bolt ② by turning it clockwise.

or

- ▶ If your vehicle is not equipped with a wheel wrench, use a suitable object to turn the towing eye bolt.

Removing towing eye bolt

- ▶ Loosen towing eye bolt ② by turning it counterclockwise.
- ▶ Unscrew towing eye bolt ②.
- ▶ Store the towing eye bolt ② and wheel wrench back into the vehicle tool kit.

Towing with all wheels on the ground

Warning!

If circumstances require towing the vehicle with all wheels on the ground, always tow with a tow bar if:

- the engine will not run
- there is a malfunction in the brake system
- there is a malfunction in the power supply or in the vehicle's electrical system

This is necessary to adequately control the towed vehicle.

Prior to towing the vehicle with all wheels on the ground, make sure the SmartKey is in starter switch position **2**.

If the SmartKey is left in the starter switch position **0** for an extended period of time, it can no longer be turned in the switch. In this case, the steering is locked. To unlock, remove SmartKey from starter switch and reinsert.

Warning!

With the engine not running, there is no power assistance for the brake and steering systems. In this case, it is important to keep in mind that a considerably higher degree of effort is necessary to brake and steer the vehicle. Adapt your driving accordingly.

- ▶ Make sure the ignition is switched on.
- ▶ With the vehicle at a standstill, depress the brake pedal and keep it pressed.

- ▶ Vehicles with manual transmission: Shift the manual transmission into the neutral position (no gear selected).

or

- ▶ Vehicles with automatic transmission: Shift the automatic transmission into neutral position **N**.
- ▶ Release the brake pedal.
- ▶ If engaged, release the parking brake.
- ▶ Switch on the hazard warning flasher (▷ page 93).

- ! The vehicle may be towed only for distances up to 30 miles (50 km) and at a speed not to exceed 30 mph (50 km/h).

- i While being towed with the hazard warning flasher in use, use the combination switch in the usual manner to signal turns. Only the selected turn signal will operate. Upon canceling the turn signal, the hazard warning flasher will operate again.

Towing with front axle raised

- ! The vehicle may be towed only for distances up to 30 miles (50 km) and at a speed not to exceed 30 mph (50 km/h).

- ! Vehicles with 4MATIC: Do not tow with one axle raised. Doing so could damage the transfer case, which is not covered by the Mercedes-Benz Limited Warranty.

All wheels must be on or off the ground. Observe instructions for towing the vehicle with all wheels on the ground.

- ▶ Make sure the ignition is switched on.
- ▶ With the vehicle at a standstill, depress the brake pedal and keep it pressed.

- ▶ Vehicles with manual transmission: Shift the manual transmission into the neutral position (no gear selected).

or

- ▶ Vehicles with automatic transmission: Shift the automatic transmission into neutral position **N**.
- ▶ Release the brake pedal.
- ▶ If engaged, release the parking brake.
- ▶ Switch off the automatic central locking (▷ page 135).
- ▶ Switch off the ignition and leave the SmartKey in the starter switch.
- ▶ Switch on the hazard warning flasher (▷ page 93).

! Vehicles without 4MATIC:

Because the ESP® operates automatically, the engine and ignition must be shut off (SmartKey in starter switch position **0** or **1** or KEYLESS-GO start/stop button in position **0** or **1**) when the vehicle is being towed with the front axle raised.

Active braking action through the ESP® may otherwise seriously damage the brake system which is not covered by the Mercedes-Benz Limited Warranty.

Fuses

Introduction

The electrical fuses in your vehicle serve to switch off malfunctioning power circuits. If a fuse is blown, the components and systems secured by that fuse will stop operating.

Warning!

Only use fuses approved by Mercedes-Benz with the specified amperage for the system in question and do not attempt to repair or bridge a blown fuse. Using other than approved fuses or using repaired or bridged fuses may cause an overload leading to a fire, and/or cause damage to electrical

components and/or systems. Have the cause determined and remedied by an authorized Mercedes-Benz Center.

A blown fuse must be replaced by an appropriate spare fuse (recognizable by its color or the fuse rating given on the fuse) of the amperage recommended in the fuse chart. Any Mercedes-Benz Center will be glad to advise you on this subject.

- i** In case of a blown fuse contact Roadside Assistance or an authorized Mercedes-Benz Center.

If a newly inserted fuse blows again, have the cause determined and rectified by an authorized Mercedes-Benz Center.

The fuse chart is located in the trunk with the vehicle tool kit (▷ page 268). The fuse chart explains the fuse allocation and fuse amperages.

Before replacing fuses

- ▶ Engage the parking brake.
- ▶ Make sure the automatic transmission is in park position **P** (manual transmission to Neutral).
- ▶ Switch off all electrical consumers.
- ▶ Turn off the engine.
- ▶ Remove the SmartKey from the starter switch.
- ▶ Vehicles with KEYLESS-GO: Open the driver's door (this puts the starter switch in position **0**, same as with the SmartKey removed from the starter switch). The driver's door then can be closed again.

Fuse box in passenger compartment

- !** Do not use sharp objects such as a screwdriver to open the fuse box cover in the dashboard. You could damage the fuse box cover or the dashboard.

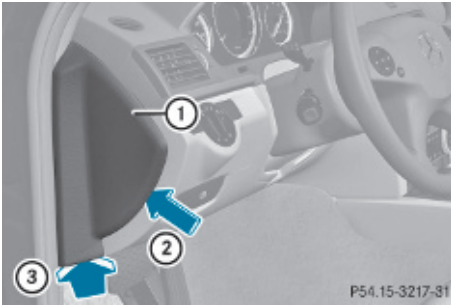

P54.15-3217-31

- ▶ Open the driver's door.
- ▶ **Opening:** Using your hands, pull fuse box cover ① in direction of arrow ③ and remove in direction of arrow ②.
- ▶ **Closing:** Hook fuse box cover ① into the opening at the front.
- ▶ Press fuse box cover ① back on until it engages.

! The fuse box cover must be properly positioned as described. Otherwise, moisture or dirt could enter the fuse box and possibly impair fuse operation.

Fuse box in trunk

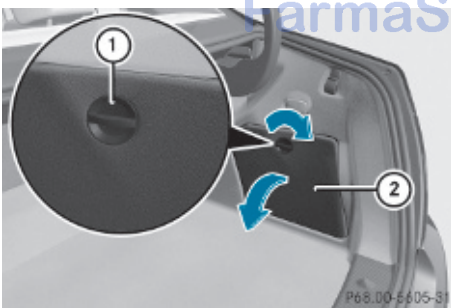

P68.00-6405-31

- ▶ Open the trunk.
- ▶ **Opening:** Turn lock ① clockwise.
- ▶ Pull cover ② downward in direction of arrow.
- ▶ **Closing:** Press cover ② backward.
- ▶ Turn lock ① counterclockwise.

Fuse box in engine compartment

- ▶ Open the hood.

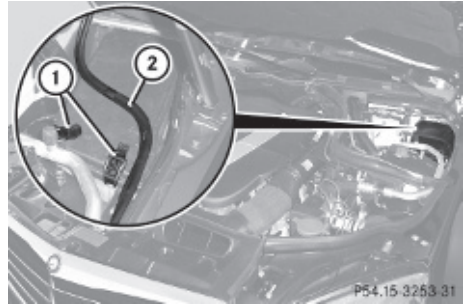

P54.15.3253.31

- ▶ With a dry cloth, remove any moisture from fuse box cover.
- ▶ **Opening:** Release wire ② from fuse box cover.
- ▶ Release clamps ①.
- ▶ Remove fuse box cover.
- ▶ **Closing:** Make sure the sealing rubber is positioned properly.
- ▶ Press fuse box cover down and secure with clamps ①.
- ▶ Fasten wire ② on fuse box cover.

- !** The fuse box cover must be properly positioned as described. Otherwise, moisture or dirt could enter the fuse box and possibly impair fuse operation.
- ▶ Close the hood after checking or replacing fuses.

امداد خودرو فارما

تلفن شبانه روزی: ۰۲۱-۸۸۸۶۲۰۸۵

FarmaSOS.com

Vehicle equipment	332
Parts service	332
Warranty coverage	332
Identification labels	332
Vehicle specification C 250 (204.052)	334
Vehicle specification C 250 Sport (204.052)	334
Vehicle specification C 250 4MATIC (204.085)	335
Vehicle specification C 250 4MATIC Sport (204.085)	336
Vehicle specification C 300 (204.054)	337
Vehicle specification C 300 Sport (204.054)	338
Vehicle specification C 300 4MATIC (204.081)	339
Vehicle specification C 300 4MATIC Sport (204.081)	340
Vehicle specification C 350 (204.056)	341
Vehicle specification C 350 Sport (204.056)	342
Vehicle specification C 350 4MATIC (204.087)	343
Vehicle specification C 63 AMG (204.077)	343
Rims and tires	344
Fuels, coolants, lubricants, etc.	349



فارس خودرو فارما

تلفن: ۰۲۱-۸۸۸۶۲۰۸۸

FarmaSOS.com

Vehicle equipment

i This Operator's Manual describes all features, standard or optional, potentially available for your vehicle at the time of purchase. Please be aware that your vehicle might not be equipped with all features described in this manual.

Parts service

All authorized Mercedes-Benz Centers maintain a stock of Genuine Mercedes-Benz Parts required for maintenance and repair work. In addition, strategically located parts distribution centers provide quick and reliable parts service.

More than 300 000 different parts for Mercedes-Benz models are available.

Genuine Mercedes-Benz Parts are subjected to stringent quality inspections. Each part has been specifically developed, manufactured or selected for and adapted to Mercedes-Benz vehicles.

Therefore, Genuine Mercedes-Benz Parts should be installed.

! Do not use non-genuine Mercedes-Benz parts and accessories not authorized by Mercedes-Benz. Doing so could damage the vehicle, which is not covered by the Mercedes-Benz Limited Warranty. Also, it could compromise the vehicle's durability or safety.

Warranty coverage

Your vehicle is covered under the terms of the warranties printed in the Service and Warranty Information booklet.

Your authorized Mercedes-Benz Center will exchange or repair any defective parts originally installed in the vehicle in accordance with the terms of the following warranties:

- New Vehicle Limited Warranty
- Emission System Warranty
- Emission Performance Warranty
- California, Connecticut, Maine, Massachusetts, New York, Pennsylvania, Rhode Island, and Vermont Emission Control Systems Warranty
- State Warranty Enforcement Laws (Lemon Laws)

Replacement parts and accessories are covered by the Mercedes-Benz Parts and Accessories warranties, copies of which are available at any authorized Mercedes-Benz Center.

Loss of Service and Warranty Information booklet

Should you lose your Service and Warranty Information booklet, have an authorized Mercedes-Benz Center arrange for a replacement. It will be mailed to you.

Identification labels



P00.10-4580-31

The Vehicle Identification Number (VIN) can be found

- on certification label ① on the driver's door B-pillar
- embossed underneath the carpet in the front passenger footwell (▷ page 333)
- on the lower edge of the windshield (▷ page 333)

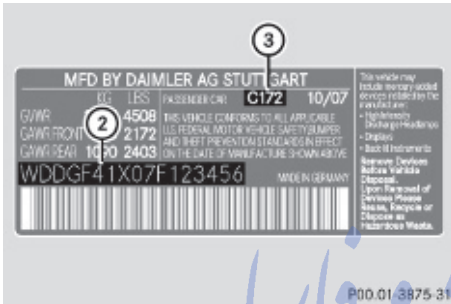

Example certification label (U.S. vehicles)

- ② VIN
- ③ Paintwork code



Example certification label (Canada vehicles)

- ② VIN
- ③ Paintwork code

① Data shown on certification label are for illustration purposes only. These data are

specific to each vehicle and may vary from data shown in the illustration. Refer to certification label on vehicle for actual data specific to your vehicle.

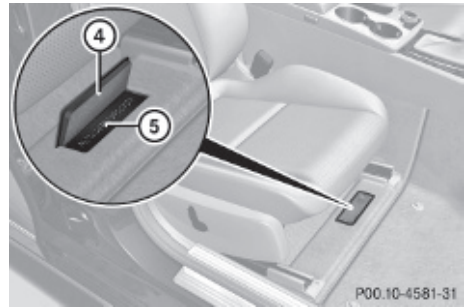

- ▶ Move the front passenger seat backward as far as possible (▷ page 80).
- ▶ Fold carpet ④ backward. VIN ⑤ is now visible.



- ⑥ Emission control information label, includes both federal and California certification exhaust emission standards
- ⑦ VIN (on lower edge of windshield)
- ⑧ Engine number (engraved on engine)

① When ordering parts, please specify vehicle identification and engine number.

Vehicle specification C 250 (204.052)

The quoted data apply only to the standard vehicle. Contact an authorized Mercedes-Benz Center for the corresponding data of all special bodies and special equipment.

i The C 250 is available in Canada only.

Engine C 250

Engine, type	272
Mode of operation	4-stroke engine, gasoline injection
No. of cylinders	6
Bore	3.46 in (88.00 mm)
Stroke	2.69 in (68.40 mm)
Total piston displacement	152.3 cu in (2 496 cm ³)
Compression ratio	11.4:1
Output acc. to SAE J 1349 ²¹	201 hp/6 100 rpm (150 kW/6 100 rpm)
Maximum torque acc. to SAE J 1349	181 lb-ft/2 900 - 5 500 rpm (245 Nm/2 900 - 5 500 rpm)
Maximum engine speed	6 500 rpm
Firing order	1-4-3-6-2-5
Poly-V-belt	2 401 mm

Electrical system C 250

Alternator	14 V/150 A
Starter motor	12 V/1.4 kW
Battery	12 V/74 Ah

Electrical system C 250

Spark plugs, type	Bosch Y 7 MPP33
Spark plugs, electrode gap	0.031 in (0.8 mm)
Spark plugs, tightening torque	15 - 18 lb-ft (20 - 25 Nm)

Main dimensions C 250

Overall vehicle length	182.3 in (4 630 mm)
Overall vehicle width ²²	79.5 in (2 020 mm)
Overall vehicle height	56.9 in (1 444 mm)
Wheelbase	108.7 in (2 760 mm)
Track, front	60.7 in (1 541 mm)
Track, rear	60.8 in (1 544 mm)
Turning circle	35.4 ft (10.8 m)

Weights C 250

Roof load	max. 220 lb (100 kg)
Trunk load	max. 220 lb (100 kg)

Vehicle specification C 250 Sport (204.052)

The quoted data apply only to the standard vehicle. Contact an authorized Mercedes-Benz Center for the corresponding data of all special bodies and special equipment.

i The C 250 Sport is available in Canada only.

²¹ Premium fuel required. Performance may vary with fuel octane rating.

²² Exterior rear view mirrors folded out.

Engine C 250 Sport	
Engine, type	272
Mode of operation	4-stroke engine, gasoline injection
No. of cylinders	6
Bore	3.46 in (88.00 mm)
Stroke	2.69 in (68.40 mm)
Total piston displacement	152.3 cu in (2 496 cm ³)
Compression ratio	11.4:1
Output acc. to SAE J 1349 ²³	201 hp/6 100 rpm (150 kW/6 100 rpm)
Maximum torque acc. to SAE J 1349	181 lb-ft/2 900 - 5 500 rpm (245 Nm/2 900 - 5 500 rpm)
Maximum engine speed	6 500 rpm
Firing order	1-4-3-6-2-5
Poly-V-belt	2 401 mm

Electrical system C 250 Sport	
Alternator	14 V/150 A
Starter motor	12 V/1.4 kW
Battery	12 V/74 Ah
Spark plugs, type	Bosch Y 7 MPP33
Spark plugs, electrode gap	0.031 in (0.8 mm)
Spark plugs, tightening torque	15 - 18 lb-ft (20 - 25 Nm)

Main dimensions C 250 Sport	
Overall vehicle length	182.8 in (4 630 mm)
Overall vehicle width ²⁴	79.5 in (2 020 mm)
Overall vehicle height	57.0 in (1 449 mm)
Wheelbase	108.7 in (2 760 mm)
Track, front	60.4 in (1 533 mm)
Track, rear	59.6 in (1 514 mm)
Turning circle	35.4 ft (10.8 m)

Weights C 250 Sport	
Roof load	max. 220 lb (100 kg)
Trunk load	max. 220 lb (100 kg)

Vehicle specification C 250 4MATIC (204.085)

The quoted data apply only to the standard vehicle. Contact an authorized Mercedes-Benz Center for the corresponding data of all special bodies and special equipment.

i The C 250 4MATIC is available in Canada only.

Engine C 250 4MATIC	
Engine, type	272
Mode of operation	4-stroke engine, gasoline injection
No. of cylinders	6
Bore	3.46 in (88.00 mm)
Stroke	2.69 in (68.40 mm)

²³ Premium fuel required. Performance may vary with fuel octane rating.

²⁴ Exterior rear view mirrors folded out.

Engine C 250 4MATIC

Total piston displacement	152.3 cu in (2 496 cm ³)
Compression ratio	11.4:1
Output acc. to SAE J 1349²⁵	201 hp/6 100 rpm (150 kW/6 100 rpm)
Maximum torque acc. to SAE J 1349	181 lb-ft/ 2 900 - 5 500 rpm (245 Nm/ 2 900 - 5 500 rpm)
Maximum engine speed	6 500 rpm
Firing order	1-4-3-6-2-5
Poly-V-belt	2 401 mm

Electrical system C 250 4MATIC

Alternator	14 V/150 A
Starter motor	12 V/1.4 kW
Battery	12 V/74 Ah
Spark plugs, type	Bosch Y 7 MPP33
Spark plugs, electrode gap	0.031 in (0.8 mm)
Spark plugs, tightening torque	15 - 18 lb-ft (20 - 25 Nm)

Main dimensions C 250 4MATIC

Overall vehicle length	182.8 in (4 630 mm)
Overall vehicle width²⁶	79.5 in (2 020 mm)
Overall vehicle height	56.9 in (1 445 mm)

Main dimensions C 250 4MATIC

Wheelbase	108.7 in (2 760 mm)
Track, front	60.7 in (1 541 mm)
Track, rear	60.8 in (1 544 mm)
Turning circle	35.4 ft (10.8 m)

Weights C 250 4MATIC

Roof load	max. 220 lb (100 kg)
Trunk load	max. 220 lb (100 kg)

Vehicle specification C 250 4MATIC Sport (204.085)

The quoted data apply only to the standard vehicle. Contact an authorized Mercedes-Benz Center for the corresponding data of all special bodies and special equipment.

i The C 250 4MATIC Sport is available in Canada only. تلفن ۰۳۰۸۶۲۰۸۰۰

Engine C 250 4MATIC Sport

Engine, type	272
Mode of operation	4-stroke engine, gasoline injection
No. of cylinders	6
Bore	3.46 in (88.00 mm)
Stroke	2.69 in (68.40 mm)
Total piston displacement	152.3 cu in (2 496 cm ³)
Compression ratio	11.4:1
Output acc. to SAE J 1349²⁷	201 hp/6 100 rpm (150 kW/6 100 rpm)

²⁵ Premium fuel required. Performance may vary with fuel octane rating.

²⁶ Exterior rear view mirrors folded out.

²⁷ Premium fuel required. Performance may vary with fuel octane rating.

Engine C 250 4MATIC Sport	
Maximum torque acc. to SAE J 1349	181 lb-ft/ 2 900 - 5 500 rpm (245 Nm/ 2 900 - 5 500 rpm)
Maximum engine speed	6 500 rpm
Firing order	1-4-3-6-2-5
Poly-V-belt	2 401 mm

Electrical system C 250 4MATIC Sport	
Alternator	14 V/150 A
Starter motor	12 V/1.4 kW
Battery	12 V/74 Ah
Spark plugs, type	Bosch Y 7 MPP33
Spark plugs, electrode gap	0.031 in (0.8 mm)
Spark plugs, tightening torque	15 - 18 lb-ft (20 - 25 Nm)

Main dimensions C 250 4MATIC Sport	
Overall vehicle length	182.8 in (4 630 mm)
Overall vehicle width ²⁸	79.5 in (2 020 mm)
Overall vehicle height	57.0 in (1 449 mm)
Wheelbase	108.7 in (2 760 mm)
Track, front	60.4 in (1 533 mm)
Track, rear	59.6 in (1 514 mm)
Turning circle	35.4 ft (10.8 m)

Weights C 250 4MATIC Sport	
Roof load	max. 220 lb (100 kg)
Trunk load	max. 220 lb (100 kg)

Vehicle specification C 300 (204.054)

The quoted data apply only to the standard vehicle. Contact an authorized Mercedes-Benz Center for the corresponding data of all special bodies and special equipment.

Engine C 300	
Engine, type	272
Mode of operation	4-stroke engine, gasoline injection
No. of cylinders	6
Bore	3.46 in (88.00 mm)
Stroke	3.23 in (82.10 mm)
Total piston displacement	182.8 cu in (2 996 cm ³)
Compression ratio	11.3:1
Output acc. to SAE J 1349 ²⁹	228 hp/6 000 rpm (170 kW/6 000 rpm)
Maximum torque acc. to SAE J 1349	221 lb-ft/ 2 500 - 5 000 rpm (300 Nm/ 2 500 - 5 000 rpm)
Maximum engine speed	6 500 rpm
Firing order	1-4-3-6-2-5
Poly-V-belt	2 401 mm

²⁸ Exterior rear view mirrors folded out.

²⁹ Premium fuel required. Performance may vary with fuel octane rating.

Electrical system C 300

Alternator	14 V/150 A
Starter motor	12 V/1.4 kW
Battery	12 V/74 Ah
Spark plugs, type	Bosch Y 7 MPP33
Spark plugs, electrode gap	0.031 in (0.8 mm)
Spark plugs, tightening torque	15 - 18 lb-ft (20 - 25 Nm)

Main dimensions C 300

Overall vehicle length	182.8 in (4 630 mm)
Overall vehicle width ³⁰	79.2 in (2 012 mm)
Overall vehicle height	57.0 in (1 449 mm) ³¹
	56.9 in (1 444 mm) ³²
Wheelbase	108.7 in (2 760 mm)
Track, front	60.4 in (1 533 mm) ³¹
	60.7 in (1 541 mm) ³²
Track, rear	59.6 in (1 514 mm) ³¹
	60.8 in (1 544 mm) ³²
Turning circle	35.4 ft (10.8 m)

Weights C 300

Roof load	max. 220 lb (100 kg)
Trunk load	max. 220 lb (100 kg)

Vehicle specification C 300 Sport (204.054)

The quoted data apply only to the standard vehicle. Contact an authorized Mercedes-Benz Center for the corresponding data of all special bodies and special equipment.

i The C 300 Sport is available in the USA only.

Engine C 300 Sport

Engine, type	272
Mode of operation	4-stroke engine, gasoline injection
No. of cylinders	6
Bore	3.46 in (88.00 mm)
Stroke	3.23 in (82.10 mm)
Total piston displacement	182.8 cu in (2 996 cm ³)
Compression ratio	11.3:1
Output acc. to SAE J 1349 ³³	228 hp/6 000 rpm (170 kW/6 000 rpm)
Maximum torque acc. to SAE J 1349	221 lb-ft/ 2 500 - 5 000 rpm (300 Nm/ 2 500 - 5 000 rpm)
Maximum engine speed	6 500 rpm
Firing order	1-4-3-6-2-5
Poly-V-belt	2 401 mm

³⁰ Exterior rear view mirrors folded out.

³¹ Canada only.

³² USA only.

³³ Premium fuel required. Performance may vary with fuel octane rating.

Electrical system C 300 Sport	
Alternator	14 V/150 A
Starter motor	12 V/1.4 kW
Battery	12 V/74 Ah
Spark plugs, type	Bosch Y 7 MPP33
Spark plugs, electrode gap	0.031 in (0.8 mm)
Spark plugs, tightening torque	15 - 18 lb-ft (20 - 25 Nm)

Main dimensions C 300 Sport	
Overall vehicle length	182.8 in (4 630 mm)
Overall vehicle width ³⁴	79.2 in (2 012 mm)
Overall vehicle height	57.0 in (1 449 mm)
Wheelbase	108.7 in (2 760 mm)
Track, front	60.4 in (1 533 mm)
Track, rear	60.5 in (1 536 mm)
Turning circle	35.4 ft (10.8 m)

Weights C 300 Sport	
Roof load	max. 220 lb (100 kg)
Trunk load	max. 220 lb (100 kg)

Vehicle specification C 300 4MATIC (204.081)

The quoted data apply only to the standard vehicle. Contact an authorized Mercedes-Benz Center for the corresponding data of all special bodies and special equipment.

³⁴ Exterior rear view mirrors folded out.

³⁵ Premium fuel required. Performance may vary with fuel octane rating.

Engine C 300 4MATIC	
Engine, type	272
Mode of operation	4-stroke engine, gasoline injection
No. of cylinders	6
Bore	3.46 in (88.00 mm)
Stroke	3.23 in (82.10 mm)
Total piston displacement	182.8 cu in (2 996 cm ³)
Compression ratio	11.3:1
Output acc. to SAE J 1349 ³⁵	228 hp/6 000 rpm (170 kW/6 000 rpm)
Maximum torque acc. to SAE J 1349	221 lb-ft/ 2 500 - 5 000 rpm (300 Nm/ 2 500 - 5 000 rpm)
Maximum engine speed	6 500 rpm
Firing order	1-4-3-6-2-5
Poly-V-belt	2 401 mm

Electrical system C 300 4MATIC	
Alternator	14 V/150 A
Starter motor	12 V/1.4 kW
Battery	12 V/74 Ah
Spark plugs, type	Bosch Y 7 MPP33
Spark plugs, electrode gap	0.031 in (0.8 mm)
Spark plugs, tightening torque	15 - 18 lb-ft (20 - 25 Nm)

Main dimensions C 300 4MATIC

Overall vehicle length	182.3 in (4 630 mm)
Overall vehicle width ³⁶	79.2 in (2 012 mm)
Overall vehicle height	57.0 in (1 449 mm) ³⁷
	56.9 in (1 445 mm) ³⁸
Wheelbase	108.7 in (2 760 mm)
Track, front	60.4 in (1 533 mm) ³⁷
	60.7 in (1 541 mm) ³⁸
Track, rear	60.5 in (1 536 mm) ³⁷
	60.8 in (1 544 mm) ³⁸
Turning circle	35.4 ft (10.8 m)

Weights C 300 4MATIC

Roof load	max. 220 lb (100 kg)
Trunk load	max. 220 lb (100 kg)

Vehicle specification C 300 4MATIC Sport (204.081)

The quoted data apply only to the standard vehicle. Contact an authorized Mercedes-Benz Center for the corresponding data of all special bodies and special equipment.

- i** The C 300 4MATIC Sport is available in the USA only.

Engine C 300 4MATIC Sport

Engine, type	272
Mode of operation	4-stroke engine, gasoline injection

Engine C 300 4MATIC Sport

No. of cylinders	6
Bore	3.46 in (88.00 mm)
Stroke	3.23 in (82.10 mm)
Total piston displacement	182.8 cu in (2 996 cm ³)
Compression ratio	11.3:1
Output acc. to SAE J 1349 ³⁹	228 hp/6 000 rpm (170 kW/6 000 rpm)
Maximum torque acc. to SAE J 1349	221 lb-ft/ 2 500 - 5 000 rpm (300 Nm/ 2 500 - 5 000 rpm)
Maximum engine speed	6 500 rpm
Firing order	1-4-3-6-2-5
Poly-V-belt	2 401 mm

Electrical system C 300 4MATIC Sport

Alternator	14 V/150 A
Starter motor	12 V/1.4 kW
Battery	12 V/74 Ah
Spark plugs, type	Bosch Y 7 MPP33
Spark plugs, electrode gap	0.031 in (0.8 mm)
Spark plugs, tightening torque	15 - 18 lb-ft (20 - 25 Nm)

³⁶ Exterior rear view mirrors folded out.

³⁷ Canada only.

³⁸ USA only.

³⁹ Premium fuel required. Performance may vary with fuel octane rating.

Main dimensions C 300 4MATIC Sport	
Overall vehicle length	182.3 in (4 630 mm)
Overall vehicle width ⁴⁰	79.2 in (2 012 mm)
Overall vehicle height	57.0 in (1 449 mm)
Wheelbase	108.7 in (2 760 mm)
Track, front	60.4 in (1 533 mm)
Track, rear	60.5 in (1 536 mm)
Turning circle	35.4 ft (10.8 m)

Weights C 300 4MATIC Sport	
Roof load	max. 220 lb (100 kg)
Trunk load	max. 220 lb (100 kg)

Vehicle specification C 350 (204.056)

The quoted data apply only to the standard vehicle. Contact an authorized Mercedes-Benz Center for the corresponding data of all special bodies and special equipment.

i The C 350 is available in Canada only.

Engine C 350	
Engine, type	272
Mode of operation	4-stroke engine, gasoline injection
No. of cylinders	6
Bore	3.66 in (92.90 mm)
Stroke	3.39 in (86.00 mm)
Total piston displacement	213.5 cu in (3 498 cm ³)

Engine C 350	
Compression ratio	10.7:1
Output acc. to SAE J 1349 ⁴¹	268 hp/6 000 rpm (200 kW/6 000 rpm)
Maximum torque acc. to SAE J 1349	258 lb-ft/ 2 400 - 5 000 rpm (350 Nm/ 2 400 - 5 000 rpm)
Maximum engine speed	6 500 rpm
Firing order	1-4-3-6-2-5
Poly-V-belt	2 401 mm

Electrical system C 350	
Alternator	14 V/150 A
Starter motor	12 V/1.4 kW
Battery	12 V/74 Ah
Spark plugs, type	Bosch Y 7 MPP33
Spark plugs, electrode gap	0.031 in (0.8 mm)
Spark plugs, tightening torque	15 - 18 lb-ft (20 - 25 Nm)

Main dimensions C 350	
Overall vehicle length	182.3 in (4 630 mm)
Overall vehicle width ⁴²	79.2 in (2 012 mm)
Overall vehicle height	57.0 in (1 449 mm)
Wheelbase	108.7 in (2 760 mm)

⁴⁰ Exterior rear view mirrors folded out.

⁴¹ Premium fuel required. Performance may vary with fuel octane rating.

⁴² Exterior rear view mirrors folded out.

Main dimensions C 350

Track, front	60.4 in (1 533 mm)
Track, rear	60.5 in (1 536 mm)
Turning circle	35.4 ft (10.8 m)

Weights C 350

Roof load	max. 220 lb (100 kg)
Trunk load	max. 220 lb (100 kg)

Engine C 350 Sport

Maximum torque acc. to SAE J 1349	258 lb-ft/ 2 400 - 5 000 rpm (350 Nm/ 2 400 - 5 000 rpm)
Maximum engine speed	6 500 rpm
Firing order	1-4-3-6-2-5
Poly-V-belt	2 401 mm

Electrical system C 350 Sport

Alternator	14 V/150 A
Starter motor	12 V/1.4 kW
Battery	12 V/74 Ah
Spark plugs, type	Bosch Y 7 MPP33
Spark plugs, electrode gap	0.031 in (0.8 mm)
Spark plugs, tightening torque	15 - 18 lb-ft (20 - 25 Nm)

Vehicle specification C 350 Sport (204.056)

The quoted data apply only to the standard vehicle. Contact an authorized Mercedes-Benz Center for the corresponding data of all special bodies and special equipment.

- i** The C 350 Sport is available in the USA only.

Engine C 350 Sport

Engine, type	272
Mode of operation	4-stroke engine, gasoline injection
No. of cylinders	6
Bore	3.66 in (92.90 mm)
Stroke	3.39 in (86.00 mm)
Total piston displacement	213.5 cu in (3 498 cm ³)
Compression ratio	10.7:1
Output acc. to SAE J 1349 ⁴³	268 hp/6 000 rpm (200 kW/6 000 rpm)

Main dimensions C 350 Sport

Overall vehicle length	182.8 in (4 630 mm)
Overall vehicle width ⁴⁴	79.2 in (2 012 mm)
Overall vehicle height	57.0 in (1 449 mm)
Wheelbase	108.7 in (2 760 mm)
Track, front	60.4 in (1 533 mm)
Track, rear	60.5 in (1 536 mm)
Turning circle	35.4 ft (10.8 m)

⁴³ Premium fuel required. Performance may vary with fuel octane rating.

⁴⁴ Exterior rear view mirrors folded out.

Weights C 350 Sport

Roof load	max. 220 lb (100 kg)
Trunk load	max. 220 lb (100 kg)

Vehicle specification C 350 4MATIC (204.087)

The quoted data apply only to the standard vehicle. Contact an authorized Mercedes-Benz Center for the corresponding data of all special bodies and special equipment.

- i** The C 350 4MATIC is available in Canada only.

Engine C 350 4MATIC

Engine, type	272
Mode of operation	4-stroke engine, gasoline injection
No. of cylinders	6
Bore	3.66 in (92.90 mm)
Stroke	3.39 in (86.00 mm)
Total piston displacement	213.5 cu in (3498 cm ³)
Compression ratio	10.7:1
Output acc. to SAE J 1349⁴⁵	268 hp/6 000 rpm (200 kW/6 000 rpm)
Maximum torque acc. to SAE J 1349	258 lb-ft/2 400 - 5 000 rpm (350 Nm/2 400 - 5 000 rpm)
Maximum engine speed	6 500 rpm
Firing order	1-4-3-6-2-5
Poly-V-belt	2401 mm

⁴⁵ Premium fuel required. Performance may vary with fuel octane rating.

⁴⁶ Exterior rear view mirrors folded out.

Electrical system C 350 4MATIC

Alternator	14 V/150 A
Starter motor	12 V/1.4 kW
Battery	12 V/74 Ah
Spark plugs, type	Bosch Y 7 MPP33
Spark plugs, electrode gap	0.031 in (0.8 mm)
Spark plugs, tightening torque	15 - 18 lb-ft (20 - 25 Nm)

Main dimensions C 350 4MATIC

Overall vehicle length	182.3 in (4 630 mm)
Overall vehicle width⁴⁶	79.2 in (2 012 mm)
Overall vehicle height	57.0 in (1 449 mm)
Wheelbase	108.7 in (2 760 mm)
Track, front	60.4 in (1 533 mm)
Track, rear	60.5 in (1 536 mm)
Turning circle	35.4 ft (10.8 m)

Weights C 350 4MATIC

Roof load	max. 220 lb (100 kg)
Trunk load	max. 220 lb (100 kg)

Vehicle specification C 63 AMG (204.077)

The quoted data apply only to the standard vehicle. Contact an authorized Mercedes-Benz Center for the corresponding data of all special bodies and special equipment.

Engine C 63 AMG	
Engine, type	156
Mode of operation	4-stroke engine, gasoline injection
No. of cylinders	8
Bore	4.02 in (102.20 mm)
Stroke	3.72 in (94.60 mm)
Total piston displacement	378.8 cu in (6 208 cm ³)
Compression ratio	11.3:1
Output acc. to SAE J 1349 ⁴⁷	450 hp/6 800 rpm (336 kW/6 800 rpm)
Maximum torque acc. to SAE J 1349	443 lb-ft/5 000 rpm (600 Nm/5 000 rpm)
Maximum engine speed	7 200 rpm
Firing order	1-5-4-2-6-3-7-8
Poly-V-belt	2 360 mm

Electrical system C 63 AMG	
Alternator	14 V/180 A
Starter motor	12 V/1.7 kW
Battery	12 V/95 Ah
Spark plugs, type	NGK ILZKAR 7A10
Spark plugs, electrode gap	0.039 in (1.0 mm)
Spark plugs, tightening torque	15 - 18 lb-ft (20 - 25 Nm)

Main dimensions C 63 AMG	
Overall vehicle length	186.1 in (4 726 mm)
Overall vehicle width ⁴⁸	79.2 in (2 012 mm)
Overall vehicle height	56.6 in (1 438 mm)
Wheelbase	108.9 in (2 765 mm)
Track, front	61.8 in (1 569 mm)
Track, rear	60.0 in (1 525 mm)

Weights C 63 AMG	
Roof load	max. 220 lb (100 kg)
Trunk load	max. 220 lb (100 kg)

Rims and tires

Notes

❗ Only use tires which have been tested and approved by Mercedes-Benz. Tires approved by Mercedes-Benz are developed to provide best possible performance in conjunction with the driving safety systems on your vehicle such as the ABS or the ESP®. Tires specially developed for your vehicle and tested and approved by Mercedes-Benz can be identified by finding the following on the tire's sidewall:

- MO = Mercedes-Benz Original equipment tires

Using tires other than those approved by Mercedes-Benz may result in damage that is not covered by the Mercedes-Benz Limited Warranty.

⁴⁷ Premium fuel required. Performance may vary with fuel octane rating.

⁴⁸ Exterior rear view mirrors folded out.

! Using tires other than those approved by Mercedes-Benz can have detrimental effects, such as

- poor handling characteristics
- increased noise
- increased fuel consumption

Moreover, tires and rims not approved by Mercedes-Benz may, under load, exhibit dimensional variations and different tire deformation characteristics that could cause them to come into contact with the vehicle body or axle parts. Damage to the tires or the vehicle may be the result.

i Further information on tires and rims is available at any authorized Mercedes-Benz Center. The Tire and Loading Information placard with the recommended tire inflation pressures for cold tires is located on the driver's door B-pillar. Supplemental tire inflation pressure information for driving at high speeds or for vehicle loads less than the maximum loaded vehicle condition can be found on the tire inflation pressure label. The tire inflation pressure label is located on the inside of the fuel filler flap. The tire inflation pressure should be checked regularly and should only be adjusted on cold tires. Follow tire manufacturer's maintenance recommendation included with the vehicle.

For information on recommended tire inflation pressure and supplemental tire inflation pressure information for special driving situations, see (▷ page 230).

i Please keep in mind that the vehicle must be equipped

- with wheels of identical dimensions on each axle (left and right)
- with tires of identical characteristics all around, i.e. summer tires, winter tires, or all-season tires etc.

i The following pages also list the approved rim and tire sizes for equipping your vehicle

with winter tires. Winter tires are not available as standard or optional factory equipment, but can be purchased from an authorized Mercedes-Benz Center.

Equipping your vehicle with winter tires approved for your vehicle model may require the purchase of rims of the recommended size for use with these winter tires. This depends on vehicle model and the standard or optional factory-equipped wheel rim/tire configuration on your vehicle. For more information contact an authorized Mercedes-Benz Center.



امداد خودرو پارسی

تلفن شبانه روزی: ۸۵

ParmaSOS.com

Same size tires

	Model	C 250 ⁴⁹ C 250 4MATIC ⁴⁹
16" wheels	Rims (light alloy)	7 J x 16 H2
	Wheel offset	1.69 in (43 mm)
	All-season tires ⁵⁰	205/55 R16 91H M+S
	Winter tires ^{50,51}	205/55 R16 91H M+S 

	Model	C 300 ⁵² C 300 4MATIC ⁵²	C 350 ⁴⁹ C 350 4MATIC ⁴⁹
17" wheels	Rims (light alloy)	7.5 J x 17 H2	7.5 J x 17 H2
	Wheel offset	1.85 in (47 mm)	1.85 in (47 mm)
	All-season tires ⁵⁰	225/45 R17 91H M+S	—
	Winter tires ^{50,51}	225/45 R17 91H M+S 	225/45 R17 91H M+S 

	Model	C 63 AMG
18" wheels	AMG rims (light alloy)	8 J x 18 H2
	Wheel offset	1.77 in (45 mm)
	Winter tires ^{50,51}	225/40 R18 92H XL (Extra Load) M+S 

⁴⁹ Canada only.

⁵⁰ Radial-ply tires.

⁵¹ Not available as factory equipment.

⁵² USA only.

Mixed size tires			
		Model	C 250 Sport ⁵³ C 250 4MATIC Sport ⁵³ C 300 ⁵³ C 300 Sport ⁵⁴ C 300 4MATIC ⁵³
17" wheels	Front axle	Rims (light alloy)	7.5 J x 17 H2
		Wheel offset	1.85 in (47 mm)
		All-season tires ⁵⁵	225/45 R17 91H M+S
	Rear axle	Rims (light alloy)	8.5 J x 17 H2
Wheel offset		2.28 in (58 mm)	
	All-season tires ^{55,56}	245/40 R17 91H M+S	
		Model	C 300 ⁵³ C 300 4MATIC ⁵³ C 350 Sport ⁵⁴ C 350 4MATIC ⁵³
17" wheels	Front axle	AMG rims (light alloy)	7.5 J x 17 H2
		Wheel offset	1.85 in (47 mm)
		All-season tires ⁵⁵	225/45 R17 91H M+S
	Rear axle	AMG rims (light alloy)	8.5 J x 17 H2
Wheel offset		2.28 in (58 mm)	
	All-season tires ^{55,56}	245/40 R17 91H M+S	

⁵³ Canada only.⁵⁴ USA only.⁵⁵ Radial-ply tires.⁵⁶ Must not be used with snow chains.

		Model	C 300 Sport ⁵⁷ C 300 4MATIC Sport ⁵⁷ C 350 ⁵⁸ C 350 Sport ⁵⁷ C 350 4MATIC ⁵⁸
18" wheels	Front axle	AMG rims (light alloy)	8 J x 18 H2
		Wheel offset	1.97 in (50 mm)
	Rear axle	All-season tires ⁵⁹	225/40 R18 92H XL (Extra Load) M+S
		AMG rims (light alloy)	8.5 J x 18 H2
	Wheel offset	2.13 in (54 mm)	
		All-season tires ^{59,60}	255/35 R18 94H XL (Extra Load) M+S

		Model	C 63 AMG
18" wheels	Front axle	AMG rims (light alloy)	8 J x 18 H2
		Wheel offset	1.77 in (45 mm)
	Rear axle	Summer tires ⁵⁹	235/40 ZR18 95Y XL (Extra Load)
		AMG rims (light alloy)	9 J x 18 H2
	Wheel offset	2.13 in (54 mm)	
		Summer tires ^{59,60}	255/35 ZR18 94Y XL (Extra Load)

⁵⁷ USA only.⁵⁸ Canada only.⁵⁹ Radial-ply tires.⁶⁰ Must not be used with snow chains.

Spare wheel

! Compare the recommended tire inflation pressure for your vehicle with the tire inflation pressure on the yellow label located on the spare wheel rim.

If the tire inflation pressure on the yellow label on the spare wheel rim differs from the values given in this Operator's Manual, inflate the tire to the recommended tire inflation pressure given on the yellow label on the spare wheel rim.

i Please note that the tire inflation pressure of the spare wheel differs from the tire inflation pressure of the road tires.

Model	C 250 (all models) ⁶¹ C 300 ⁶² C 300 4MATIC ⁶²	C 300 ⁶¹ C 300 4MATIC ⁶¹ C 300 Sport ⁶² C 300 4MATIC Sport ⁶² C 350 (all models)	C 63 AMG
Rim (steel)	3.5 B x 16 H2	3.5 B x 17 H2	3.5 B x 18
Wheel offset	0.79 in (20 mm)	0.79 in (20 mm)	0.79 in (20 mm)
Minispare tire ⁶³	T 125/90 R16 98M	T 125/80 R17 99M	T 125/70 R18 99M
Recommended tire inflation pressure	61 psi (4.2 bar)	61 psi (4.2 bar)	61 psi (4.2 bar)

Fuels, coolants, lubricants, etc.

Capacities

Vehicle components and their respective lubricants must match. Therefore only use products tested and approved by Mercedes-Benz.

For information on tested and approved products, contact an authorized Mercedes-Benz Center or visit **www.mbusa.com** (USA only).

Warning!

Comply with all valid regulations with respect to handling, storing, and disposing of service

fluids. Otherwise you could endanger persons or the environment.

Keep service fluids out of the reach of children.

For health reasons, you should prevent service fluids from coming into direct contact with your skin or clothing.

If a service fluid is swallowed, contact a physician immediately.

⁶¹ Canada only.

⁶² USA only.

⁶³ Must not be used with snow chains.

	Model	Capacity	Fuels, coolants, lubricants, etc.
Engine with oil filter	C 250 ⁶⁴ C 250 Sport ⁶⁴ C 300 C 300 Sport ⁶⁵ C 350	8.5 US qt (8.0 l)	Approved engine oils
	C 250 4MATIC ⁶⁴ C 250 4MATIC Sport ⁶⁴ C 300 4MATIC C 300 4MATIC Sport ⁶⁵ C 350 4MATIC ⁶⁴	7.4 US qt (7.0 l)	
	C 63 AMG ⁶⁶	9.0 US qt (8.5 l)	
Manual transmission	C 250 ⁶⁴ C 250 Sport ⁶⁴	1.3 US qt (1.2 l)	MB Manual Transmission Oil
	C 300 C 300 Sport ⁶⁵	1.6 US qt (1.5 l)	
Automatic transmission	C 250 ⁶⁴ C 250 Sport ⁶⁴	9.0 US qt (8.5 l)	MB Automatic Transmission Fluid
	C 250 4MATIC ⁶⁴ C 250 4MATIC Sport ⁶⁴	10.3 US qt (9.7 l)	
	C 300 C 300 Sport ⁶⁵ C 350 ⁶⁴ C 350 Sport ⁶⁵	9.5 US qt (9.0 l)	
	C 300 4MATIC C 300 4MATIC Sport ⁶⁵ C 350 4MATIC ⁶⁴	10.5 US qt (9.9 l)	
	C 63 AMG ⁶⁷	9.6 US qt (9.1 l)	

⁶⁴ Canada only.⁶⁵ USA only.⁶⁶ Engine with oil cooler.⁶⁷ Automatic transmission with oil cooler.

	Model	Capacity	Fuels, coolants, lubricants, etc.
Front axle	C 250 4MATIC ⁶⁴ C 250 4MATIC Sport ⁶⁴	0.63 US qt (0.6 l)	Hypoid gear oil (SAE 85W-90)
	C 300 4MATIC C 300 4MATIC Sport ⁶⁵ C 350 4MATIC ⁶⁴	1.2 US qt (1.1 l)	
Rear axle	C 250 ⁶⁴ C 250 Sport ⁶⁴	1.1 US qt (1.0 l)	Hypoid gear oil (SAE 85W-90)
	C 250 4MATIC ⁶⁴ C 250 4MATIC Sport ⁶⁴ C 300 C 300 Sport ⁶⁵ C 300 4MATIC C 300 4MATIC Sport ⁶⁵ C 350 ⁶⁴ C 350 Sport ⁶⁵ C 350 4MATIC ⁶⁴	1.2 US qt (1.1 l)	
	C 63 AMG	1.3 US qt (1.2 l)	Fuchs Titan EG 5010 D
Power steering	All models	approx. 0.9 US qt (0.8 l)	MB Power Steering Fluid (Chevron Texaco PSF 9109)
Brake system	All models	0.53 US qt (0.5 l)	MB Brake Fluid (DOT 4+)
Cooling system	All models, except C 63 AMG	approx. 5.1 US qt (4.8 l)	MB 325.0 Anticorrosion/ Antifreeze
	C 63 AMG	approx. 12.4 US qt (11.7 l)	

⁶⁴ Canada only.⁶⁵ USA only.

	Model	Capacity	Fuels, coolants, lubricants, etc.
Fuel tank	All models	17.4 US gal (66.0 l)	Premium unleaded gasoline (Minimum Posted Octane 91 [Avg. of 96 RON/86 MON]) C 300, all models (with automatic transmission): Flexible Fuel Vehicles (identified by a label reading Premium gasoline or E85 only! on the fuel filler flap). Alternative fuel: Ethanol fuel (E85)
Fuel tank reserve	All models, except C 63 AMG C 63 AMG	approx. 2.1 US gal (8.0 l) approx. 3.7 US gal (14.0 l)	
Air conditioning system	All models	–	R134a refrigerant and special PAG lubricant oil (never R 12)
Washer system	C 250 ⁶⁴ C 250 Sport ⁶⁴ C 250 4MATIC ⁶⁴ C 250 4MATIC Sport ⁶⁴	4.2 US qt (4.0 l)	MB Windshield Washer Concentrate ⁶⁸ (▷ page 358) Washer fluid mixing ratio (▷ page 358)
	C 300 C 300 Sport ⁶⁵ C 350 C 350 Sport ⁶⁵	3.7 US qt (3.5 l)	
Washer system and headlamp cleaning system	C 300 4MATIC C 300 4MATIC Sport ⁶⁵ C 350 4MATIC ⁶⁴ C 63 AMG	6.3 US qt (6.0 l)	

⁶⁴ Canada only.

⁶⁸ Mixed with water or commercially available premixed washer solvent/antifreeze.

⁶⁵ USA only.

Approved engine oils

Engine oils are specifically tested for their suitability in our engines and durability for our service intervals. Therefore, only use approved engine oils and oil filters required for vehicles with the Maintenance System.

For a listing of approved engine oils and oil filters, contact an authorized Mercedes-Benz Center or visit www.mbusa.com (USA only).

! Using engine oils and oil filters of a specification other than those expressly required for the Maintenance System, or changing of oil and oil filter at change intervals longer than those called for by the Maintenance System will result in engine or emission control system damage not covered by the Mercedes-Benz Limited Warranty.

Please follow Maintenance System recommendations for scheduled oil changes. Failure to do so will result in engine or emission control system damage not covered by the Mercedes-Benz Limited Warranty.

Mercedes-Benz recommends MOBIL OIL.

Use the table below to determine the MB sheet number.

Model	Engine, type	MB sheet number
C 250 ⁶⁹	272	229.5
C 250 Sport ⁶⁹	272	229.5
C 250 4MATIC ⁶⁹	272	229.5
C 250 4MATIC Sport ⁶⁹	272	229.5
C 300	272	229.5
C 300 Sport ⁷⁰	272	229.5
C 300 4MATIC	272	229.5

⁶⁹ Canada only.

⁷⁰ USA only.

⁷¹ Restriction: Only SAE 0W-40/SAE 5W-40 engine oils may be used.

Model	Engine, type	MB sheet number
C 300 4MATIC Sport ⁷⁰	272	229.5
C 350 ⁶⁹	272	229.5
C 350 Sport ⁷⁰	272	229.5
C 350 4MATIC ⁶⁹	272	229.5
C 63 AMG	156	229.5 ⁷¹

i MB sheet numbers are printed on the outside of oil containers.

Viscosity grades for engine oils

Using the chart below, select oil viscosity according to the lowest air temperature expected before the next oil change.

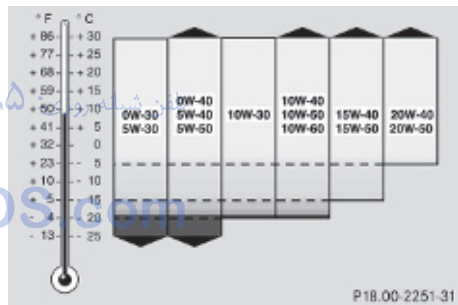

Engine oil additives

! Do not blend oil additives with engine oil. They may damage the engine. Damage or malfunctions resulting from blending oil additives are not covered by the Mercedes-Benz Limited Warranty.

Air conditioning refrigerant

R134a (HFC) refrigerant and special PAG lubricating oil are used in the air conditioning system.

! Never use R 12 (CFC) or mineral-based lubricating oil. Otherwise damage to the system will occur.

Brake fluid

Warning!

During vehicle operation, the boiling point of the brake fluid is continuously reduced through the absorption of moisture from the atmosphere.

Under extremely strenuous operating conditions, this moisture content can lead to the formation of bubbles in the system, thus reducing the system's efficiency.

Therefore, the brake fluid must be replaced regularly. Refer to your vehicle's Maintenance Booklet for replacement interval.

Only brake fluid approved by Mercedes-Benz is recommended. Any authorized Mercedes-Benz Center will provide you with additional information.

Premium unleaded gasoline

Warning!

Gasoline is highly flammable and poisonous. It burns violently and can cause serious personal injury.

Never allow sparks, flames or smoking materials near gasoline!

Turn off the engine before refueling.

Whenever you are around gasoline, avoid inhaling fumes and any skin or clothing contact. Extinguish all smoking materials.

Direct skin contact with fuels and the inhalation of fuel vapors are damaging your health.

! To maintain the engine's durability and performance, premium unleaded gasoline must be used.

If premium unleaded gasoline is not available and low octane gasoline is used, follow these precautions:

- Have the fuel tank only partially filled with unleaded regular gasoline and fill up with premium unleaded gasoline as soon as possible.
- Avoid full throttle driving and abrupt acceleration.
- Do not exceed an engine speed of 3000 rpm if the vehicle is loaded with a light load such as two persons and no luggage.
- Do not exceed $\frac{2}{3}$ of maximum accelerator pedal position if the vehicle is fully loaded or operating in mountainous terrain.

Fuel requirements

Only use premium unleaded gasoline. The octane number (posted at the pump) must be 91 min. It is an average of both the Research Octane Number (RON) and the Motor Octane Number (MON): $(RON+MON)/2$. This is also known as the ANTI-KNOCK INDEX.

Reformulated gasolines (RFG) and/or unleaded gasoline containing oxygenates such as ethanol, TAME, ETBE, IPA, IBA, and TBA can be used provided the ratio of any one of these oxygenates to gasoline does not exceed 10%; MTBE must not exceed 15%.

The ratio of methanol to gasoline must not exceed 3% plus additional cosolvents.

Using mixtures of ethanol and methanol is not allowed. Gasohol, which contains 10% ethanol and 90% unleaded gasoline, can be used.

These blends must also meet all other fuel requirements, such as resistance to spark knock, boiling range, vapor pressure, etc.

Flexible Fuel Vehicles

All models of the C 300 with automatic transmission are Flexible Fuel Vehicles.

Flexible Fuel Vehicles are identified by a label reading **Premium gasoline or E85 only!** on the fuel filler flap.

These vehicles are designed to operate on premium unleaded gasoline or ethanol fuel (E85), or on any mixture of these two. Ethanol fuel (E85) is a mixture of approximately 85% ethanol and 15% unleaded gasoline.

Warning!

Ethanol fuel (E85) and its fumes are highly flammable, poisonous and burn easily.

Ethanol fuel can cause serious injuries if ignited or if you come into contact with it or inhale fumes of it. Avoid inhalation of ethanol fumes and skin contact with ethanol.

Extinguish all open flames before refueling.

Never smoke or create sparks close to ethanol.

Switching fuels

For best performance and driveability it is recommended to use either one or the other fuel. A refueling pattern that alternates between the two different fuels should be avoided if possible.

When switching fuels, make sure:

- Fuel level is below half full.
- Fuel level is above reserve (fuel tank reserve warning lamp is not lit).
- Amount of added fuel is more than 5 gallons (20 liters).
- Ignition is off during refill.
- Immediately after refueling engine is started and operated for at least 5 minutes.

These precautions and recommendations are supposed to prevent any difficulties when starting and operating the engine which otherwise may be experienced before the engine has fully adapted to the different fuel.

If in spite of these recommendations the engine does not perform properly, adding more gasoline (at least 3 gallons [12 liters]) to the fuel may improve the engine behavior.

Fuel consumption

E85 fuel contains less energy per gallon than gasoline. To ensure that engine performance with ethanol fuel is similar to that when using gasoline, the engine must burn more ethanol fuel. As a result, it is to be expected that the fuel consumption will increase when using E85 compared to gasoline operation.

Maintenance

Please inform your authorized Mercedes-Benz Center if you use or have used E85 fuel when your vehicle is delivered for maintenance or repairs.

Cold weather performance

It is possible that starting times will significantly increase at temperatures below 32°F (0°C). At low temperatures the use of a block heater is recommended (contact an authorized Mercedes-Benz Center for further information). Rough idling may also be experienced at such temperatures before the engine is fully warmed up.

- ❗ E85 fuel is unsuitable for use when ambient temperatures fall below 14°F (-10°C).

Hot weather performance

At ambient temperatures above 95°F (35°C) start times may increase and be accompanied by a rough idle following the start.

Gasoline additives

A major concern among engine manufacturers is carbon build-up caused by gasoline. Mercedes-Benz recommends only

the use of quality gasoline containing additives that prevent the build-up of carbon deposits.

After an extended period of using fuels without such additives carbon deposits can build up, especially on the intake valves and in the combustion area, leading to engine performance problems such as:

- Warm-up hesitation
- Unstable idle
- Knocking/pinging
- Misfire
- Power loss

In areas where carbon deposits may be encountered due to lack of availability of gasoline which contains these additives, the use of Mercedes-Benz approved additives is recommended.

Contact an authorized Mercedes-Benz Center or visit www.mbusa.com (USA only) for a listing of approved products. Follow directions on the product label.

Do not blend other fuel additives with fuel. This only results in unnecessary cost and may be harmful to the engine operation.

! Damage or malfunction resulting from poor fuel quality or from blending additional fuel additives other than those tested and approved by us for use on Mercedes-Benz vehicles are not covered by the Mercedes-Benz Limited Warranty or by any pre-owned or Extended Limited Warranties.

Coolants

The engine coolant is a mixture of water and anticorrosion/antifreeze, which provides:

- Corrosion protection
- Freeze protection
- Boiling protection (by increasing the boiling point)

The cooling system was filled at the factory with a coolant providing freeze protection to approximately -35°F (-37°C) and corrosion protection.

! Add premixed coolant solution only. Adding water and MB 325.0 Anticorrosion/Antifreeze separately from each other, could cause engine damage not covered by the Mercedes-Benz Limited Warranty.

If the antifreeze mixture is effective to -35°F (-37°C), the boiling point of the coolant in the pressurized cooling system is reached at approximately 266°F (130°C).

The coolant solution must be used year round to provide the necessary corrosion protection and increase boil-over protection. Refer to the Maintenance Booklet for replacement interval.

Coolant system design and coolant used determine the replacement interval. The replacement interval published in the Maintenance Booklet is only applicable if MB 325.0 Anticorrosion/Antifreeze solution or other Mercedes-Benz approved products of equal specification are used to renew the coolant concentration or bring it back up to the proper level.

For information on other Mercedes-Benz approved products of equal specification, contact an authorized Mercedes-Benz Center or visit www.mbusa.com (USA only).

To provide important corrosion protection, the solution must be at least 50% anticorrosion/antifreeze (equivalent to freeze protection to approximately -35°F [-37°C]).

If you use a solution that is more than 55% anticorrosion/antifreeze (freeze protection to approximately -49°F [-45°C]), the engine temperature will increase due to the lower heat transfer capability of the solution.

Therefore, do not use more than this amount of anticorrosion/antifreeze.

If the coolant level is low, water and MB 325.0 Anticorrosion/Antifreeze should be used to bring it up to the proper level (have cooling

system checked for signs of leakage). Please make sure the mixture is in accordance with label instructions.

The water in the cooling system must meet minimum requirements, which are usually satisfied by normal drinking water.

If you are not sure about the water quality, contact an authorized Mercedes-Benz Center.

Anticorrosion/antifreeze

Your vehicle contains a number of aluminum parts. The use of aluminum components in motor vehicle engines necessitates that anticorrosion/antifreeze coolant used in

such engines be specifically formulated to protect the aluminum parts. Failure to use such anticorrosion/antifreeze coolant will result in a significantly shortened service life.

Therefore, the following product is strongly recommended for use in your vehicle:

MB 325.0 Anticorrosion/Antifreeze agent.

Before the start of the winter season (or once a year in hot southern regions), you should have the anticorrosion/antifreeze concentration checked.

The coolant is also regularly checked each time you bring your vehicle to an authorized Mercedes-Benz Center for service.

	Model	Approximate freeze protection	
		-35°F (-37°C)	-49°F (-45°C)
Cooling system	All models, except C 63 AMG	2.5 US qt (2.4 l)	2.8 US qt (2.6 l)
	C 63 AMG	6.2 US qt (5.85 l)	6.8 US qt (6.4 l)

تلفن شبانه روزی: ۰۲۱-۸۸۸۶۲۰۸۵

FarmaSOS.com

Washer system and headlamp cleaning system

Warning!

Washer solvent/antifreeze is highly flammable. Do not spill washer solvent/antifreeze on hot engine parts, because it may ignite and burn. You could be seriously burned.

- ▶ Use MB Windshield Washer Concentrate “MB SummerFit”.
- ▶ Mix with water for temperatures above freezing point.
- ▶ Mix with commercially available premixed washer solvent/antifreeze for temperatures below freezing point.

Washer fluid mixing ratio

For temperatures above the freezing point:

1 part “MB SummerFit” to 100 parts water
(1.34 fl oz [40 ml] “MB SummerFit” to 1 gal [4.0 l] water)

For temperatures below freezing point:

1 part “MB SummerFit” to 100 parts solvent
(1.34 fl oz [40 ml] “MB SummerFit” to 1 gal [4.0 l] solvent)

امداد خودرو فارما

تلفن شبانه روزی: ۰۸۵ ۲۰۸۷۷۷۷۷۷

FormaSOS.com

امداد خودرو فارما

تلفن شبانه روزی: ۰۲۱-۸۸۸۶۲۰۸۵

FarmaSOS.com

امداد خودرو فارما

تلفن شبانه روزی: ۰۲۱-۸۸۸۶۲۰۸۵

FarmaSOS.com

Service and Literature

Your authorized Mercedes-Benz Center has trained technicians and Genuine Mercedes-Benz Parts to service your vehicle properly. For expert advice and quality service, contact an authorized Mercedes-Benz Center.

If you are interested in obtaining service literature for your vehicle, please contact an authorized Mercedes-Benz Center.

We consider this the best way for you to obtain accurate information for your vehicle.

For further information you can find us on the Mercedes-Benz web site **www.mbusa.com** (USA only) or **www.mercedes-benz.ca** (Canada only).

Warning!

To help avoid personal injury, be extremely careful when performing any service work or repairs. Improper or incomplete service or the use of incorrect or inappropriate parts or materials may damage the vehicle or its equipment, which may in turn result in personal injury.

If you have any questions about carrying out any type of service, turn to the advice of an authorized Mercedes-Benz Center.

We reserve the right to make changes in design and equipment.

Therefore, information, illustrations and descriptions in this Operator's Manual might differ from your vehicle.

Reprinting, translation and copying, even of excerpts, is not permitted without our prior authorization in writing.

Press time July 17, 2009

GSP/OIS

Printed in U. S. A.

امداد خود را

تلفن شبانه روزی: ۰۲۱-۸۸۸۶۲۰۸۵

FarmaSOS.com

امداد خودرو فارما

تلفن شبانه روزی: ۰۲۱-۸۸۸۶۲۰۸۵

FarmaSOS.com



2045845381

Order no. 6515 0712 13 Part no. 204 584 5381 Edition B 2010