



تلفن شماره روزی: ۰۲۱-۸۸۸۶۲۰۸۵

FarmaSOS.com

Mercedes-Benz

E-Class

Sedan

Operator's Manual

Symbols

Trademarks:

- BabySmart™ is a trademark of Siemens Automotive Corp.
- Bluetooth® is a registered trademark of Bluetooth SIG Inc.
- HomeLink® is a registered trademark of Prince, a Johnson Controls Company.
- PRE-SAFE® is a registered trademark of Daimler.
- SIRIUS and related marks are trademarks of SIRIUS XM Radio Inc.

The following symbols are found in this Operator's Manual:

Warning!

Warning notices draw your attention to hazards that may endanger your health or life, or the health or life of others.

 Highlights hazards that may result in damage to your vehicle.

 Helpful hints or further information you may find useful.

- ▶ This symbol points to instructions for you to follow.
- ▶ A number of these symbols appearing in succession indicates a multiple-step procedure.
- ▷ page This symbol tells you where to look for further information on a topic.
- ▷▷ This continuation symbol marks a warning or procedure which is continued on the next page.

Display Text in displays, such as the control system, are printed in the type shown here.

تلفن شبانه روزی: ۰۲۱-۸۸۸۶۲۰۸۵

FarmaSOS.com

Our company and staff congratulate you on the purchase of your new Mercedes-Benz.

Your selection of our product is a demonstration of your trust in our company name. Furthermore, it exemplifies your desire to own an automobile that will be as easy as possible to operate and will provide years of service.

Your Mercedes-Benz represents the efforts of many skilled engineers and craftsmen. To help assure your driving pleasure, and also the safety of you and your passengers, we ask you to make a small investment of time:

- Please read this manual carefully, then return it to your vehicle where it will be handy for your reference.
- Please follow the recommendations contained in this manual. They are designed to acquaint you with the operation of your Mercedes-Benz.
- Please pay attention to the warnings and cautions contained in this manual. They are designed to help improve the safety of the vehicle operator and occupants.

We extend our best wishes for many miles of safe, pleasurable driving.

Mercedes-Benz USA, LLC

A Daimler Company

امداد خودرو فارما

تلفن شبانه روزی: ۰۲۱-۸۸۶۲۰۸۵

FarmaSOS.com



امداد خودرو فارما

تلفن شبانه روزی: ۰۲۱-۸۸۸۶۲۰۸۵

FarmaSOS.com

Index	4	At a glance	25
Introduction	20	Safety and security	35
		Controls in detail	75
		Operation	219
		Practical hints	267
		Technical data	345

امداد خودرو فارما

تلفن شبانه روزی: ۰۲۱-۸۸۸۶۲۰۸۵

FarmaSOS.com

1, 2, 3 ...

4-ETS

see ETS/4-ETS

4MATIC

see All-wheel drive (4MATIC)

A**ABS (Antilock Brake System)** 62

Indicator lamp 305

Messages in the multifunction display 288, 289

Accessory weight 249**Accidents** 112

Air bags 37

Emergency calls (Tele Aid) 208

NECK-PRO active front head restraints 54

Active Bi-Xenon headlamps

see Headlamps

Adaptive Brake 64**Adaptive Highbeam Assist** 100

Switching on or off 142

AdBlue® 333, 364

Refilling 334

Additives

Engine oil 362

Gasoline 364

Address change 21**Advanced Tire Pressure****Monitoring System (Advanced****TPMS)** 233

Messages in the multifunction display 285

Air bags 37

Emergency call upon deployment .. 208

Front, driver and passenger 40

Front passenger front air bag off indicator lamp (Canada only) 46, 313

Front passenger front air bag off indicator lamp (USA only) 43, 314

Knee bag 40

Messages in the multifunction display 276

OCS (Occupant Classification System) 43

Pelvis 42

Safety guidelines 39

Side impact 41

Window curtain 42

Air conditioning refrigerant and**lubricant** 362**Air distribution** 189**Air filter** 299**AIRMATIC**

Damping system 163

Introduction 163

Messages in the multifunction display 292

Vehicle level control 163

Air pressure

see Tire inflation pressure

Air pressure (tires) 250**Air pump (electric)** 327**Air recirculation mode** 190**Air volume** 189**Alarm system**

see Anti-theft systems

Alignment bolt (vehicle tool kit) 326**All-wheel drive (4MATIC)** 161**Alternator** تلفن شماره ۰۲۱-۸۸۸۰۰۰۰

Messages in the multifunction display 284, 297

Alternator (Technical data)

see Vehicle specification

AMG adaptive sport suspension**system (E 63 AMG)** 164**AMG menu** 131**Anticorrosion/antifreeze** 365**Antilock Brake System**

see ABS

Anti-theft systems 71

Anti-theft alarm system 72

Immobilizer 71

Aquaplaning

see Hydroplaning

Armrest, front

Storage compartment 202

Armrest, rear

Storage compartment 202

Ashtrays 206**Aspect ratio (tires)** 250**Assistance menu** 137

- ATTENTION ASSIST** 178
 Messages in the multifunction display 292
 Switching on or off 138
- Audio menu** 134
- Auto-dimming rear view mirrors** 95
- Automatic central locking** 80, 144
- Automatic climate control**
 see Climate control system
- Automatic headlamp mode** 98
- Automatic interior lighting control** .. 103
- Automatic locking when driving** 144
- Automatic shift program** 120
- Automatic transmission** 114
 Automatic shift program 120
 Gear range indicator 120
 Gear ranges 120
 Gear selector lever 115
 Hill-start assist system 160
 Kickdown 119
 Kickdown (manual shift program) .. 124
 Manual shift program 122
 One-touch gearshifting 121
 Program mode indicator 121
 Program mode selector dial 121
 (E 63 AMG) 121, 123
 Program mode selector switch (automatic shift program) 120
 Shifting procedure 118
 Steering wheel gearshift control 122
 Transmission position indicator 118
 Transmission positions 118
- AUX socket** 201
- Axle oils** 360
- B**
- BabySmart™**
 Air bag deactivation system 46
 Self-test 47
- Backrest**
 see Seats
- Backup lamps**
 Messages in the multifunction display 300
- Bar (air pressure unit)** 250
- BAS (Brake Assist System)** 63
- BAS PLUS (Brake Assist System PLUS)** 63
- Batteries, SmartKey**
 Checking condition 79
 Replacing 317
- Battery, Vehicle** 336
 Charging 337
 Jump starting 338
 Messages in the multifunction display 284, 297
- Bead (tire)** 250
- Beverage holders**
 see Cup holders
- Bleeding the fuel system (diesel engine)** 333
- Blind Spot Assist** 175
 ♦ Messages in the multifunction display 281
 Switching on or off 138
- BlueTEC**
 AdBlue® tank 333
- Brake Assist System**
 see BAS
- Brake Assist System PLUS**
 see BAS PLUS
- Brake fluid**
 Checking level 227
 Messages in the multifunction display 289
- Brake lamps**
 Cleaning lenses 262
- Brake pads**
 Messages in the multifunction display 287
- Brakes** 254
 Ceramic brake system 256
 High-performance brake system 256
 Parking brake 113
 Warning lamp 305
- Break-in period** 220
- Bug cover (Radiator)** 224
- Bulbs**
 see Replacing bulbs

- C**
- CAC (Customer Assistance Center) ...** 23
- California retail buyers and lessees, important notice for** 21
- Calls (phone)** 135
- Can holders**
see Cup holders
- Capacities and recommended fuel/lubricants** 359
- Cargo tie-down rings** 199
- Carpets, cleaning** 266
- Center console** 32
- Central locking**
Automatic 80, 144
KEYLESS-GO 77
Locking/unlocking from inside 81
SmartKey 76
- Central locking/unlocking switch** 81
- Ceramic brake system** 256
- Certification label** 346
- Children in the vehicle**
Air bags 37
BabySmart™ air bag deactivation system 46
Child safety locks (rear doors) 60
Child seat anchors – LATCH-type (ISOFIX) 59
Indicator lamp, front passenger front air bag off (Canada only) 46
Indicator lamp, front passenger front air bag off (USA only) 43
Infant and child restraint systems 56
ISOFIX (Child seat anchors – LATCH-type) 59
OCS (Occupant Classification System) 43
Override switch 60
Safety notes 56
Tether anchorage points 58
Top tether 58
- Child safety**
see Children in the vehicle
- Child seat anchors – LATCH-type (ISOFIX)**
see Children in the vehicle
- Chrome-plated exhaust tip, cleaning** 266
- Cigarette lighter** 206
- Climate control**
see Climate control system
- Climate control system** 180
Air conditioning 185
Air conditioning refrigerant 362
Air distribution 189
Air recirculation mode 190
Air volume 189
Automatic mode 186
Deactivating system 185
Front defroster 189
Maximum cooling MAX COOL 190
Residual heat and ventilation 191
Temperature 186
- Cockpit** 27
- Cold tire inflation pressure** 250
- Collapsible wheel chock** 270
- COMAND system**
see separate COMAND system operating instructions
- Combination switch** 100
- Compass** 216
- Control system** 126
Multifunction display 128
Multifunction steering wheel 126
Resetting to factory settings 139
- Control system menus** 129
AMG 131
Assistance 137
Audio 134
Navi 134
Service 138
Settings 139
Telephone 135
Trip 129
- Control system submenus**
Convenience 145
Instrument cluster 140
Lighting 141
Vehicle 144
- Convenience submenu**
Easy-entry/exit feature 145
Seat belt adjustment function 145
- Coolant**
Anticorrosion/antifreeze 365
Capacities 361
Checking level 226

- Messages in the multifunction display 295
- Temperature gauge 125
- Warning lamp 311
- Corner-illuminating lamps** 102
- Replacing bulbs 319
- Cruise control** 146
- Activating 147
- Canceling 147
- Changing the set speed 148
- Last stored speed 148
- Lever 147
- Messages in the multifunction display 279
- Resume function 148
- Setting current speed 147
- Cup holders** 203
- Curb weight** 250
- Customer Assistance Center (CAC)** ... 23
- Customer Relations Department** 23
- D**
- Damping system** 163
- Dashboard**
see Instrument cluster
- Data recording** 23
- Daytime running lamp mode** 98
- Switching on or off 141
- Deep water**
see Standing water
- Defroster**
- Front (Climate control system) 189
- Rear window 191
- Delayed shut-off**
- Exterior lamps 142
- Interior lighting 143
- Department of Transportation**
see DOT
- Diesel fuel**
see Fuel
- Difficulties**
- While driving 112
- With starting 110
- Dimensions (vehicle)**
see Vehicle specification
- Direction of rotation (tires)** 241
- Displays**
- DISTRONIC PLUS 151
- Maintenance service indicator 258
- Messages in the multifunction display 272
- Multifunction display 128
- Symbol messages 287
- Text messages 274
- Trip computer 129
- Vehicle status message memory ... 139
- Vehicle system settings 139
- DISTRONIC PLUS** 149
- Cleaning system sensors 263
- Displaying the distance graphic 152
- Displays in the multifunction display 151
- Distance warning lamp 151, 309
- Driving 154
- Driving with 157
- Lever 153
- Messages in the multifunction display 280
- Resume function 156
- Sensor cover 263
- Speed settings 155
- Stopping 155
- Door control panel** 34
- Door handles** 34
- Doors**
- Child safety locks 60
- Locking/unlocking (KEYLESS-GO) ... 77
- Locking/unlocking (SmartKey) 76
- Messages in the multifunction display 293
- Opening from inside 80
- Remote door lock (Tele Aid) 212
- Remote door unlock (Tele Aid) 211
- Unlocking (Mechanical key) 314
- DOT (Department of Transportation)** 250
- Drinking and driving** 254
- Drive-dynamic multicontour seat** 91
- Driving**
- Abroad 257
- Hydroplaning 257
- Instructions 109, 254
- In winter 253
- Problems 112

- RACE START (E 63 AMG) 159
- Safety systems 61
- Systems 146
- Through standing water 257
- With DISTRONIC PLUS 157
- Driving and parking**
- Safety notes 109
- Driving off** 111, 257
- Driving safety systems** 61
- ABS 62
- Adaptive Brake 64
- BAS 63
- BAS PLUS 63
- EBP 64
- ESC 65
- ETS/4-ETS 65
- PRE-SAFE® Brake 69
- Driving systems**
- AIRMATIC (except E 63 AMG) 163
- All-wheel drive (4MATIC) 161
- AMG adaptive sport suspension system (E 63 AMG) 164
- ATTENTION ASSIST 178
- Blind Spot Assist 175
- Cruise control 146
- DISTRONIC PLUS 149
- Hill-start assist system 160
- HOLD function 161
- Lane Keeping Assist 177
- Night View Assist Plus 172
- Parking Guidance 168
- Parktronic system 165
- RACE START (E 63 AMG) 159
- Rear view camera 171
- Driving tips, automatic transmission** 119
- E**
- Easy-entry/exit feature** 93, 145
- EBP (Electronic Brake Proportioning)** 64
- Electrical system**
- Improper work on or modifications 22
- Power outlets 207
- Electrical system (Technical data)**
- see Vehicle specification
- Electronic Stability Control**
- see ESC
- Electronic Traction System**
- see ETS/4-ETS
- Emergency, in case of**
- First aid kit 268
- Flat tire 323
- Hazard warning flasher 101
- Roadside Assistance 21, 210
- Towing the vehicle 340
- Emergency calls**
- Tele Aid 208
- Emergency operations**
- Remote door lock (Tele Aid) 212
- Remote door unlock (Tele Aid) 211
- Trunk lid, emergency release 84
- Emergency Tensioning Device**
- see ETD
- Emission control** 258
- Information label 347
- System warranties 20
- Engine**
- Break-in recommendations 220
- Cleaning 261
- Compartment 223
- Malfunction indicator lamp 310
- Messages in the multifunction display 295
- Number 347
- Starting 109
- Turning off 113
- Engine (Technical data)**
- see Vehicle specification
- Engine compartment**
- Radiator 224
- Engine coolant**
- see Coolant
- Engine oil**
- Adding 225
- Additives 362
- Checking level 224
- Consumption 224
- Messages in the multifunction display 298
- Oil dipstick 225
- Recommended engine oils and oil filter 361

- ESC (Electronic Stability Control)** 65
- ETS/4-ETS 65
 - Messages in the multifunction display 288, 289, 290
 - Warning lamp 309
- ETD (Emergency Tensioning Device)** 52
- Safety guidelines 39
- ETS/4-ETS (Electronic Traction System)** 65
- Express operation**
- Panorama roof 195
 - Power windows 105
 - Tilt/sliding sunroof 192
- Exterior lamp switch** 97
- Exterior rear view mirrors** 95
- Parking position 95
- Exterior view of vehicle** 26
- F**
- Fastening the seat belts** 50
- First aid kit** 268
- Flat tire** 323
- Lowering the vehicle 328
 - Mounting the spare wheel 323
 - Preparing the vehicle 323
 - Spare wheel 323, 358
 - TIREFIT (tire repair kit) 329
- Floor mats** 217
- Fluids**
- Automatic transmission fluid 360
 - Brake fluid 361
 - Capacities 359
 - Engine coolant 361
 - Engine oil 360
 - Power steering fluid 360
 - Washer and headlamp cleaning system 361
- Fog lamps** 99
- Messages in the multifunction display 300, 302
- Four-wheel drive**
- see All-wheel drive (4MATIC)
- Front air bags**
- see Air bags
- Front axle oil** 360
- Front lamps**
- see Headlamps
- Front passenger front air bag** 40
- Messages in the multifunction display 276
- Front passenger front air bag off indicator lamp (Canada only)** 46, 313
- Front passenger front air bag off indicator lamp (USA only)** 43, 314
- Fuel** 220
- Additives 364
 - Capacity, fuel tank 361
 - Diesel fuel 363
 - Drive sensibly-safe fuel 254
 - Fuel consumption statistics 130
 - Fuel filler flap and cap 222
 - Fuel tank reserve warning lamp 310
 - Premium unleaded gasoline 362
 - Refueling 220
 - Requirements 363
- Fuel filler flap** 222
- Opening manually 316
- Fuel gauge** 126
- Fuels, coolants, lubricants etc.** 359
- Fuel system, bleeding (diesel engine)** 333
- Fuel tank**
- Capacity 361
 - Fuel filler flap and cap 222
 - Refueling 220
- Fuses** 343
- G**
- Garage door opener** 33, 212
- Gasoline**
- see Fuel
- GAWR (Gross Axle Weight Rating)** ... 250
- Gear range** 120
- Indicator 120
 - Limiting 122
 - Shifting into optimal 122
- Gear selector lever** 115
- Cleaning 265
 - Gearshift pattern 115
 - Shifting procedure 118
 - Transmission position indicator 118
 - Transmission positions 118

- Generator**
see Alternator
- Global locking/unlocking**
see Key, SmartKey
- Glove box** 201
- Gross Axle Weight Rating**
see GAWR
- Gross Vehicle Weight**
see GVW
- Gross Vehicle Weight Rating**
see GVWR
- GVW (Gross Vehicle Weight)** 250
- GVWR (Gross Vehicle Weight Rating)** 250
- H**
- Halogen headlamps**
see Headlamps
- Hard plastic trim items, cleaning** ... 265
- Hazard warning flasher** 101
- Headlamp cleaning system** 102
- Headlamps**
Active Bi-Xenon headlamps 97
Adaptive Highbeam Assist 100
Automatic headlamp mode 98
Bi-Xenon 97, 319
Cleaning lenses 262
Cleaning system 102
Daytime running lamp mode 98
Delayed shut-off 142
Halogen 319
High-beam flasher 101
High-beam headlamps 100
Low-beam headlamps 98
Messages in the multifunction display 299
Replacing bulbs 318
Switch 97
- Headliner and shelf below rear window, cleaning and care of** 266
- Head restraints** 87
Adjustment 87, 89
Comfort head restraint 89
Folding back 89
NECK-PRO active front head restraints 54
Rear seat head restraints 89
- Heated steering wheel** 94
- Height adjustment**
Seat belt outlet 51
Seats 87
Vehicle level control 163
- High-beam flasher** 101
- High-beam headlamps** 100, 319
Adaptive Highbeam Assist 100
Indicator lamp 29
Replacing bulbs 319
- High-performance brake system** 256
- Hill-start assist system** 160
- HOLD function** 161
- Hood** 223
Messages in the multifunction display 293
- Hydroplaning** 257
- I**
- Identification labels** 346
- Identification number, vehicle (VIN)** 346
- Ignition** 85, 86, 110
- Immobilizer** 71
- Indicator lamps**
see Lamps, indicator and warning
- Infant and child restraint systems**
see Children in the vehicle
- Inflation pressure**
see Tires, Inflation pressure
- Inside door handle** 80
- Instrument cluster** 28, 125
Illumination 125
Lamps 304
Multifunction display 128
- Instrument lighting**
see Instrument cluster, Illumination
- Instrument panel**
see Instrument cluster
- Instruments and controls**
see Cockpit
- Interior lighting**
Delayed shut-off 143
Emergency lighting 103
Front 103
Front reading lamps 103

Rear	104
Rear reading lamps	104
Interior rear view mirror	94
Auto-dimming rear view mirrors	95
Interior storage spaces	
see Storage compartments	
Intermittent wiping	104
Rain sensor	104
IR emitter	
Replacing bulbs	319
ISOFIX (Child seat anchors – LATCH-type)	
see Children in the vehicle	

J

Jack	270
Jump starting	338

K

Key, Mechanical

Loss of	79
Replacing	80
Unlocking/locking manually	314
Valet locking	85

Key, SmartKey

Battery check lamp	79
Checking batteries	79
Factory setting	77, 79
Global locking (KEYLESS-GO)	79
Global locking (SmartKey)	77
Global unlocking (KEYLESS-GO)	79
Global unlocking (SmartKey)	77
Important notes on KEYLESS-GO	78
Locking/unlocking	76
Loss of	79
Messages in the multifunction display	293
Opening, trunk	82
Opening and closing the power tilt/sliding sunroof or the panorama roof	107
Opening and closing the windows	107
Remote control	76

Replacing	80
Replacing batteries	317
Restoring to factory setting	77, 79
Selective setting	77, 79
Starter switch positions	85

KEYLESS-GO

Starter switch positions	86
--------------------------------	----

Kickdown

Kickdown (manual shift program) ...	124
-------------------------------------	-----

Kilopascal (air pressure unit)

Kilopascal (air pressure unit)	250
--------------------------------------	-----

Knee bag

Knee bag	40
----------------	----

L

Labels

Certification	346
Emission control information	347
Tire and Loading Information placard	237
Tire inflation pressure	230

Lamps, exterior

Exterior lamp switch	97
Front	319
Messages in the multifunction display	299
Switching on/off	97

Lamps, indicator and warning

ABS	29, 305
Adaptive Highbeam Assist	100
Brakes	305
Coolant	311
Distance warning lamp	151, 309
Engine malfunction	310
ESC	29, 309
ESC OFF	308
Fog lamps	99
Front passenger front air bag off (Canada only)	46, 313
Front passenger front air bag off (USA only)	43, 314
Fuel tank reserve	310
High-beam headlamps	29, 100
Instrument cluster	304
Low-beam headlamps	30, 98
Low tire pressure/TPMS malfunction telltale	312
Seat belt telltale	29, 52, 307

- SRS 36, 308
 Turn signals 29
- Lane Keeping Assist** 177
 Messages in the multifunction display 283
 Switching on or off 138
- LATCH-type child seat anchors (ISOFIX)**
 see Children in the vehicle
- License plate lamps**
 Messages in the multifunction display 301
- Light alloy wheels, cleaning** 265
- Lighter**
 see Cigarette lighter
- Lighting** 97
 Daytime running lamp mode 98
 Exterior 97
 Interior 103
- Limp-home mode** 124
- Load index (tires)** 246, 250
- Loading**
 see Vehicle loading
- Locator lighting** 142
- Locking the vehicle**
 KEYLESS-GO 77
 Manually 315
 SmartKey 76
- Loss of**
 Key 79
 Service and Warranty Information booklet 346
- Low-beam headlamps** 98
 Exterior lamp switch 97
 Indicator lamp 30
 Replacing bulbs 319
 Switching on 98
- Lubricants** 359
- Lumbar support** 89
- M**
- Maintenance** 21
- Maintenance System**
 Service indicator display 259
 Service indicator message 258
 Service term exceeded 259
- Manual headlamp mode (Low-beam headlamps)** 98
- Manual shift program** 122
- Maximum engine speed**
 see Vehicle specification
- Maximum loaded vehicle weight** 250
- Maximum load rating (tires)** 250
- Maximum permissible tire inflation pressure** 251
- Mechanical key**
 see Key, Mechanical
- Media interface** 201
- Memory function** 96
- Menus**
 see Control system menus
- Minispare wheel**
 see Spare wheel
- Mirrors** 94
 Auto-dimming rear view mirrors 95
 Exterior rear view mirror parking position 95
 Exterior rear view mirrors 95
 Interior rear view mirror 94
 Memory function 96
 Vanity mirror 205
- MOExtended system** 329
- MOExtended tires** 329, 353
- MON (Motor Octane Number)** 363
- Motor Octane Number**
 see MON
- Multifunction display** 128
 Symbol messages 287
 Text messages 274
 Vehicle status messages 272
- Multifunction display messages**
 ABS 288, 289
 Active headlamps 299
 Advanced TPMS 285
 Air bags 276
 Air filter 299
 AIRMATIC 292
 Alternator 284, 297
 ATTENTION ASSIST 292
 Automatic transmission 283, 284
 Backrests 293
 Battery 284, 297
 Blind Spot Assist 281
 Brake fluid 289

Brake pads	287
Child seat	279
Coolant	295
Corner-illuminating lamps	303
Cruise control	279
DISTRONIC PLUS	280
Doors	293
EBP	289
Engine oil	298
ESC	288, 289, 290
Fog lamps	300, 302
Front passenger front air bag	276
Gas cap	298
High-beam lamps	301
Hood	293
Lane Keeping Assist	283
License plate lamps	301
Light sensor	302
Low-beam lamps	302
Parking brake	289
Parking lamps	301
Power steering	295
PRE-SAFE®	274
Radar sensors	282
Reserve fuel	298
Reverse lamp	300
Side marker lamps	300
SmartKey	293
SRS	290
Tele Aid	290
Tire inflation pressure	284, 304
Tire pressure monitor	285
Tires	284, 304
Trunk	293
Turn signals	303
Washer fluid	294

Multifunction steering wheel

Adjustment	93
Buttons	126
Cleaning	265
Easy-entry/exit feature	93, 145
Gearshift control	122
Heating	94
Memory function	96
Overview	30

N

Navigation system

see Separate operating instructions

Navi menu 134

NECK-PRO active front head

restraints 54

Resetting 316

Nets, parcel 199

Night View Assist Plus 172

Cleaning the windshield in front of
the camera 263

Normal occupant weight 251

Number, vehicle identification

(VIN) 346

O

Occupant Classification System

see OCS (Occupant Classification
System)

Occupant distribution 251

Occupant safety

Air bags 37

BabySmart™ 46

Children and air bags 37

Children in the vehicle 56

Child seat anchors – LATCH-type
(ISOFIX) 59

Fastening the seat belts 50

Front passenger front air bag off
indicator lamp (Canada
only) 46, 313

Front passenger front air bag off
indicator lamp (USA only) 43, 314

Infant and child restraint systems 56

Introduction 36

ISOFIX (Child seat anchors –
LATCH-type) 59

OCS (Occupant Classification
System) 43

PRE-SAFE® 53

Seat belts 39, 48

OCS (Occupant Classification

System) 43

Self-test 46

Odometer 129

- Oil, oil level**
 - see Engine oil
 - On-board computer**
 - see Control system
 - One-touch gearshifting** 121
 - Operating safety** 22
 - Ornamental moldings, cleaning** 262
 - Overhead control panel** 33
- P**
- Paintwork, cleaning** 261
 - Paintwork code** 347
 - Panic alarm** 61
 - Panorama roof with power tilt/
sliding panel** 195
 - Cleaning 265
 - Operation 195
 - Roller sunblinds 194
 - Synchronizing 196
 - Parcel nets** 199
 - Parking** 113
 - Parking Guidance 168, 170
 - Parktronic system 165
 - Parking and standing lamp**
 - Replacing bulbs 319
 - Parking brake** 113
 - Messages in the multifunction
display 289
 - Parking Guidance** 168
 - Canceling 171
 - Detecting a parking space 169
 - Parking 170
 - Parking position**
 - Exterior rear view mirrors 95
 - Transmission position 118
 - Parktronic system**
 - Cleaning system sensors 263
 - Malfunction 168
 - Minimum distance 167
 - Sensor range 166
 - Switching on/off 168
 - System sensors 166
 - Warning indicators 27, 167
 - Parts service** 346
 - PASS AIR BAG OFF indicator lamp
(Canada only)**
 - see Front passenger front air bag
off indicator lamp (Canada only)
 - PASS AIR BAG OFF indicator lamp
(USA only)**
 - see Front passenger front air bag
off indicator lamp (USA only)
 - Passenger safety**
 - see Occupant safety
 - Pedals** 254
 - Pelvis air bags** 42
 - Phone**
 - see Telephone
 - Plastic parts, cleaning** 265
 - Power assistance** 254
 - Power outlets** 207
 - Power seats**
 - see Seats
 - Power steering**
 - Messages in the multifunction
display 295
 - Power tilt/sliding sunroof**
 - Operation 192
 - Synchronizing 194
 - Power washer** 261
 - Power windows** 105
 - Cleaning 264
 - Operation 105
 - Rear door window, override
switch 60
 - Synchronizing 107
 - Practical hints** 268
 - Preglow indicator lamp** 110
 - PRE-SAFE®** 53
 - Messages in the multifunction
display 274
 - PRE-SAFE® Brake** 69
 - Activating/deactivating 137
 - Messages in the multifunction
display 274
 - Problems**
 - While driving 112
 - With vehicle 23
 - With wipers 105
 - Product information** 20
 - Production options weight** 251

- Program mode selector dial (E 63 AMG)**
Automatic shift program 121, 123
- Program mode selector switch**
Automatic shift program 120
- Proximity key**
see Key, SmartKey
- PSI (air pressure unit) 251**
- R**
- RACE START (E 63 AMG) 159**
- RACETIMER 132**
- Radar sensors**
Messages in the multifunction display 282
Switching on or off 144
- Radiator 224, 252**
- Radio**
Selecting stations 134
- Radio transmitters 257**
- Rain sensor**
see Intermittent wiping
- Rear axle oil 360**
- Rear center console ashtray**
see Ashtrays
- Rear center seat belt**
Unblocking 51
- Rear doors**
Child safety locks 60
- Rear door window**
Override switch 60
- Rear fog lamp**
see Fog lamps
- Rear lamps**
see Tail lamps
- Rear seat head restraints**
see Head restraints
- Rear view camera 171**
Cleaning the camera lens 263
- Rear window defroster 191**
- Recommended tire inflation pressure 229, 251**
- Refilling**
AdBlue® 334
- Refrigerant, air conditioning 362**
- Refueling 220**
- Regular checks 222**
- Reminder, Seat belt**
see Seat belts, Telltale
- Remote control**
see Key, SmartKey
- Remote door lock (Tele Aid) 212**
- Remote door unlock (Tele Aid) 211**
- Replacing**
Key 80
- Replacing bulbs 318**
- Reporting safety defects 23**
- Research Octane Number**
see RON
- Reserve fuel**
Messages in the multifunction display 298
Warning lamp 310
- Restraint systems**
see Occupant safety
- Retaining hook 199**
- Rims 251, 353**
- Roadside Assistance 21, 210**
- Roller sunblinds 194**
- RON (Research Octane Number) 363**
- Roof rack 198**
- Rubber parts, cleaning 265**
- Run-flat tires**
see MOExtended tires
- S**
- Safety**
Driving safety systems 61
Occupant safety 36
Reporting defects 23
- Safety belts**
see Seat belts
- Seat belt force limiter 52**
- Seat belts 48**
Adjustment function 51
Automatic comfort-fit feature 53
Children in the vehicle 56
Cleaning 266
Fastening 50
Height adjustment 51
Proper use of 49
Rear center seat 51
Safety guidelines 39

- Safety notes 48
- Telltale 29, 52, 307
- Seat heating** 92
- Seating capacity** 238
- Seats** 87
 - Adjustment 87
 - Drive-dynamic multicontour seat 91
 - Easy-entry/exit feature 93
 - Heating 92
 - Memory function 96
 - Messages in the multifunction display 293
 - Split rear seat bench 199
 - Ventilation 92
- Securing cargo**
 - Cargo tie-down rings 199
- Selective setting**
 - see Key, SmartKey
- Selector lever**
 - see Gear selector lever
- Self-test**
 - BabySmart™ 47
 - OCS (Occupant Classification System) 46
 - Tele Aid 208
- Service**
 - see Maintenance
- Service, parts** 346
- Service and warranty information** 20
- Service intervals**
 - see Maintenance System, Service indicator message
- Service life (tires)** 242
- Service menu** 138
- Settings**
 - Factory setting (KEYLESS-GO) 79
 - Factory setting (SmartKey) 77
 - Memory function 96
 - Menu 139
 - Selective setting (KEYLESS-GO) 79
 - Selective setting (SmartKey) 77
- Shelf below rear window, cleaning** .. 266
- Side impact air bags** 41
- Side marker lamps**
 - Cleaning lenses 262
 - Messages in the multifunction display 300
- Sidewall (tires)** 251
- SmartKey**
 - see Key, SmartKey
- SmartKey with KEYLESS-GO**
 - see Key, SmartKey
- Snow chains** 252
- Snow tires**
 - see Winter tires
- Spare wheel** 353
 - Mounting 323
 - Storage location 271
- Speedometer** 28
- Speed settings**
 - Cruise control 147
 - DISTRONIC PLUS 155
 - Resume function 148, 156
- SRS**
 - Indicator lamp 29
- SRS (Supplemental Restraint System)**
 - Indicator lamp 36, 308
 - Messages in the multifunction display 290
- Standing water, driving through** 257
- Starter switch positions**
 - KEYLESS-GO 86
 - SmartKey 85
- Starting difficulties (engine)** 110
- Starting the engine** 109
- Steering column**
 - see Multifunction steering wheel, Adjustment
- Steering wheel**
 - see Multifunction steering wheel
- Steering wheel gearshift control** 122
- Stolen Vehicle Recovery Services** ... 212
- Storage compartments** 201
- Storing tires** 243
- Sunroof**
 - see Power tilt/sliding sunroof
- Sunshade**
 - Rear window 205
- Sun visors** 204, 205
- Suspension tuning**
 - see AIRMATIC

T

- Tachometer** 28, 126
 Overspeed range 126
- Tail lamps**
 Cleaning lenses 262
- Tar stains** 261
- Technical data**
 Air conditioning refrigerant 362
 Brake fluid 362
 Capacities fuels, coolants,
 lubricants etc. 359
 Coolant 365
 Engine oil additives 362
 Engine oils 361
 Fuel requirements 363
 Gasoline additives 364
 Identification labels 346
 Premium unleaded gasoline 362
 Rims and tires 353
 Spare wheel 358
 Vehicle specification E 350 348
 Vehicle specification
 E 350 4MATIC 349
 Vehicle specification
 E 350 BlueTEC 348
 Vehicle specification E 550 350
 Vehicle specification
 E 550 4MATIC 351
 Vehicle specification E 63 AMG 352
 Washer and headlamp cleaning
 system 361, 367
- Technical data (dimensions)**
 see Vehicle specification
- Technical data (electrical system)**
 see Vehicle specification
- Technical data (engine)**
 see Vehicle specification
- Technical data (weights)**
 see Vehicle specification
- Tele Aid** 207
 Emergency calls 208
 Information button 210
 Initiating an emergency call
 manually 209
 Messages in the multifunction
 display 290
 Remote door lock 212
- Remote door unlock 211
 Roadside Assistance button 210
 Search & Send 211
 SOS button 209
 Stolen Vehicle Recovery Services .. 212
 System self-test 208
- Telephone** 30
 Answering/ending a call 136
 Hands-free microphone 33
 Menu 135
 Operation 135
 Phone book 136
 Redialing 137
- Temperature**
 Coolant 125
 Interior temperature 186
 Outside 126
- Tether anchorage points**
 see Children in the vehicle
- Through-loading feature** 198
- Tie-down rings** 199
- Tightening torque**
 Wheels 328
- TIN (Tire Identification Number)** 251
- Tire and Loading Information placard** 237
- Tire and loading terminology** 249
- TIREFIT** 329
- Tire Identification Number**
 see TIN
- Tire inflation pressure**
 Checking 231
 Important notes on 230
 Label on the inside of fuel filler
 flap 230
 Placard on driver's door B-pillar 237
- Tire labeling** 245
- Tire load rating** 250
- Tire ply composition and material used** 251
- Tire pressure loss warning system** . 232
- Tire repair kit**
 see TIREFIT
- Tires** 228, 353
 Advanced Tire Pressure
 Monitoring System (Advanced
 TPMS) 233

- Air pressure 229
 Care and maintenance 242
 Cleaning 243
 Direction of rotation, spinning 241
 Important notes on tire inflation
 pressure 230
 Inflation pressure 231
 Information placard 237
 Inspection 242
 Labeling 245
 Load index 246, 250
 Load rating 250
 Messages in the multifunction
 display 284, 304
 MOExtended 353
 Ply composition and material
 used 251
 Problems under-/overinflation 231
 Retreads 228
 Rims and tires (technical data) 353
 Rotation 244
 Service life 242
 Sizes 353
 Snow chains 252
 Speed rating 247, 251
 Storing 243
 Temperature 230, 244
 Terminology 249
 TIREFIT (tire repair kit) 329
 Tire Identification Number 251
 Tire pressure loss warning system . 232
 TPMS low tire pressure/
 malfunction telltale 312
 Traction 244, 251
 Tread 251
 Tread depth 242, 252
 Treadwear 243
 Treadwear indicators 242, 252
 Vehicle maximum load on 252
 Wear pattern 244
 Winter tires 252, 353
Tire speed rating 247, 251
Top tether
 see Children in the vehicle
Total load limit 251
Towing
 Towing eye bolt 341
 Vehicle 340
Towing eye bolt 341
Traction 244, 251
Transfer case 124
Transmission
 see Automatic transmission
Transmission fluid level 226
Transmission gear selector lever
 see Gear selector lever
Transmission positions 118
Traveling abroad 257
Tread (tires) 251
Tread depth (tires) 242, 252
Treadwear 243
Treadwear indicators (tires) 242, 252
Trip menu 129
Trunk
 Closing 82
 Fuse box 343
 Messages in the multifunction
 display 293
 Opening 82
 Opening/closing system 83
 Tie-down rings 199
 Trunk lid emergency release 84
 Unlocking manually 315
 Valet locking 85
Turning off the engine 113
Turn signals 100
 Cleaning lenses 262
 Indicator lamps 29
 Messages in the multifunction
 display 303
 Replacing bulbs 319

U

- Uniform Tire Quality Grading
 Standards** 243, 252
Units
 Selecting speedometer display
 mode 141
Unleaded gasoline, premium 362
Unlocking the vehicle
 KEYLESS-GO 77
 Manually 314
 SmartKey 76
Upholstery, cleaning 266
Useful features 203

V

Valet locking	85
Vehicle	
Battery	336
Care	260
Control system	126
Identification Number (VIN)	346
Locking/unlocking	76
Lowering (wheel change)	328
Modifications and alterations,	
Operating safety	22
Towing	340
Unlocking/locking manually	314
Vehicle dimensions	
see Vehicle specification	
Vehicle Identification Number (VIN)	346
Vehicle jack	
see Jack	
Vehicle level control	
see AIRMATIC	
Vehicle lighting	97
Vehicle loading	
Cargo tie-down rings	199
Instructions	197
Load limit	238
Roof rack	198
Split rear seat bench	199
Terminology	249
Vehicle maximum load on the tire ...	252
Vehicle specification	
E 350	348
E 350 4MATIC	349
E 350 BlueTEC	348
E 550	350
E 550 4MATIC	351
E 63 AMG	352
Vehicle status message memory	139
Vehicle tool kit	268
Vehicle washing	
see Vehicle care	
Vehicle weights	
see Vehicle specification	

W

Warning sounds	
DISTRONIC PLUS	151
Driver's or passenger's seat belt	52
Parking brake	289
Parking Guidance	170
Parktronic system	168
Seat belt telltale	307
Warranty coverage	346
Washer and headlamp cleaning system	367
Washer fluid	
Messages in the multifunction display	294
Mixing ratio	367
Refilling	227
Washing the vehicle	260
Wear pattern (tires)	244
Weights (vehicle)	
see Vehicle specification	
Wheel	
Changing	323
Removing	326
Spare	323
Tightening torque	328
Wheels, sizes	353
Wheels, Tires and	228
Window curtain air bags	42
Windows	
see Power windows	
Windows, cleaning	264
Windshield	
Cleaning wiper blades	264
Washer fluid	367
Wipers	104
Windshield wipers	
Replacing wiper blades	322
Winter cover	224, 252
Winter driving	
Instructions	253
Radiator cover	252
Snow chains	252
Tires	252
Winter tires	252, 353
Wood trims, cleaning	266

Product Information

Please observe the following in your own best interest:

We recommend using Genuine Mercedes-Benz Parts as well as conversion parts and accessories explicitly approved by us for your vehicle model.

We have tested these parts to determine their reliability, safety and special suitability for Mercedes-Benz vehicles.

We are unable to make an assessment for other products and therefore cannot be held responsible for them, even if in individual cases an official approval or authorization by governmental or other agencies should exist. Use of such parts and accessories could adversely affect the safety, performance or reliability of your vehicle. Please do not use them.

Genuine Mercedes-Benz Parts and pre-approved conversion parts and accessories are available at any authorized Mercedes-Benz Center. In addition, you will receive comprehensive information on permissible technical modifications and expert installations.

Operator's Manual

Notes

This Operator's Manual contains a great deal of useful information. We urge you to read it carefully and familiarize yourself with the vehicle before driving.

For your own safety and longer service life of the vehicle, we urge you to follow the instructions and warnings contained in this Operator's Manual. Ignoring them could result in damage to the vehicle or personal injury to you or others. Vehicle damage caused by failure to follow instructions is not covered by the Mercedes-Benz Limited Warranty.

We continuously strive to improve our product and ask for your understanding that we reserve the right to make changes in design and equipment. Therefore, information, illustrations, and descriptions in this Operator's Manual might differ from your vehicle.

Vehicle equipment

Your vehicle may have some or all of the equipment described in this manual.

Therefore, you may find explanations for optional equipment not installed in your vehicle. If you have any questions about operating particular equipment, any authorized Mercedes-Benz Center will be glad to demonstrate the proper procedures.

Optional equipment is also described in this manual, including operating instructions wherever necessary. Since they are special-order items, the descriptions and illustrations herein may vary slightly from the actual equipment of your vehicle.

If there are any equipment details that are not shown or described in this Operator's Manual, any authorized Mercedes-Benz Center will be glad to inform you of correct care and operating procedures. The Operator's Manual and Maintenance Booklet are important documents and should be kept with the vehicle.

Service and warranty information

The Service and Warranty Information booklet contains detailed information about the warranties covering your Mercedes-Benz, including:

- New Vehicle Limited Warranty
- Emission System Warranty
- Emission Performance Warranty
- California, Connecticut, Maine, Massachusetts, New York, Pennsylvania,

Rhode Island, and Vermont Emission Control System Warranty

- State Warranty Enforcement Laws (Lemon Laws)

Mercedes-Benz USA, LLC
Customer Assistance Center
One Mercedes Drive
Montvale, NJ 07645-0350

Important notice for California retail buyers and lessees of Mercedes-Benz automobiles

Under California law you may be entitled to a replacement of your vehicle or a refund of the purchase price or lease price, if after a reasonable number of repair attempts Mercedes-Benz USA, LLC and/or its authorized repair or service facilities fail to fix one or more substantial defects or malfunctions in the vehicle that are covered by its express warranty. During the period of 18 months from original delivery of the vehicle or the accumulation of 18 000 miles (approximately 29 000 km) on the odometer of the vehicle, whichever occurs first, a reasonable number of repair attempts is presumed for a retail buyer or lessee if one or more of the following occurs:

- (1) the same substantial defect or malfunction results in a condition that is likely to cause death or serious bodily injury if the vehicle is driven, that defect or malfunction has been subject to repair two or more times, and you have directly notified Mercedes-Benz USA, LLC in writing of the need for its repair,
- (2) the same substantial defect or malfunction of a less serious nature than category (1) has been subject to repair four or more times and you have directly notified us in writing of the need for its repair, or
- (3) the vehicle is out of service by reason of repair of the same or different substantial defects or malfunctions for a cumulative total of more than 30 calendar days.

Written notification should not be sent to a dealer, it should be addressed to

Maintenance

The Maintenance Booklet describes all the necessary maintenance work which should be performed at regular intervals.

Always have the Maintenance Booklet with you when you take the vehicle to an authorized Mercedes-Benz Center for service. The service advisor will record each service in the booklet for you.

Roadside Assistance

The Mercedes-Benz Roadside Assistance Program provides factory-trained technical help in the event of a breakdown. Calls to the toll-free Roadside Assistance number

1-800-FOR-MERCEdes (1-800-367-6372)
(in the USA) 1-800-387-0100 (in Canada)

will be answered by Mercedes-Benz Customer Assistance Representatives 24 hours a day, 365 days a year.

For additional information refer to the Mercedes-Benz Roadside Assistance Program brochure (in the USA) or the Roadside Assistance section of the Service and Warranty Information Booklet (in Canada) in your vehicle literature portfolio.

Change of address or ownership

If you change your address, be sure to send in the "Change of Address Notice" found in the Service and Warranty Information Booklet, or simply call the Mercedes-Benz Customer Assistance Center (in the USA) at 1-800-FOR-MERCEdes (1-800-367-6372), or Customer Service (in Canada) at 1-800-387-0100. This will assist us in

contacting you in a timely manner should the need arise.

If you sell your Mercedes, please leave all literature with the vehicle to make it available to the next operator.

If you bought this vehicle used, be sure to send in the “Notice of Purchase of Used Car” found in the Service and Warranty Information Booklet, or call the Mercedes-Benz Customer Assistance Center (in the USA) at 1-800-FOR-MERcedes (1-800-367-6372), or Customer Service (in Canada) at 1-800-387-0100.

Operating your vehicle outside the USA or Canada

If you plan to operate your vehicle in foreign countries, please be aware that:

- Service facilities or replacement parts may not be readily available.
- Unleaded gasoline for vehicles with catalytic converters may not be available; the use of leaded fuels will damage the catalysts.
- Gasoline may have a considerably lower octane rating, and improper fuel can cause engine damage.

Certain Mercedes-Benz models are available for delivery in Europe under our European Delivery Program. For details, consult an authorized Mercedes-Benz Center or write to:

In the USA:

Mercedes-Benz USA, LLC
European Delivery Department
One Mercedes Drive
Montvale, NJ 07645-0350

In Canada:

Mercedes-Benz Canada, Inc.
European Delivery Department
98 Vanderhoof Avenue
Toronto, Ontario M4G 4C9

Operating safety

Warning!

Work improperly carried out on electronic components and associated software could cause them to cease functioning. Because the vehicle's electronic components are interconnected, any modifications made may produce an undesired effect on other systems. Electronic malfunctions could seriously impair the operating safety of your vehicle.

Contact an authorized Mercedes-Benz Center for repairs or modifications to electronic components.

Other improper work or modifications on the vehicle could also have a negative impact on the operating safety of the vehicle.

Some safety systems only function while the engine is running. You should therefore never turn off the engine while driving.

Warning!

Heavy blows against the vehicle underbody or tires/wheels may cause serious damage and impair the operating safety of your vehicle.

Such blows can be caused, for example, by running over an obstacle, road debris or a pothole. If you feel a sudden significant vibration or ride disturbance, or you suspect that damage to your vehicle as occurred:

- turn on your hazard warning flashers
- slow down carefully
- drive with caution to an area which is a safe distance from the road

Inspect the vehicle underbody and tires/wheels for possible damage. If the vehicle appears unsafe, have it towed to the nearest authorized Mercedes-Benz Center or other qualified maintenance or repair facility for further inspection or repairs.

Proper use of the vehicle

Proper use of the vehicle requires that you are familiar with the following information and rules:

- the safety precautions in this manual
- the “Technical data” section in this manual
- traffic rules and regulations
- motor vehicle laws and safety standards

Warning!

Various warning labels are attached to your vehicle. These warning labels are intended to make you and others aware of various risks. Do not remove any of these warning labels unless explicitly instructed to do so by information on the label itself. Removing warning labels may cause you and others to be unaware of certain risks which may result in an accident and/or personal injury.

Problems with your vehicle

If you should experience a problem with your vehicle, particularly one that you believe may affect its safe operation, we urge you to contact an authorized Mercedes-Benz Center immediately to have the problem diagnosed and corrected if required. If the matter is not handled to your satisfaction, please discuss the problem with the Mercedes-Benz Center management or, if necessary, contact us at one of the following addresses:

In the USA:

Customer Assistance Center
Mercedes-Benz USA, LLC
One Mercedes Drive
Montvale, NJ 07645-0350

In Canada:

Customer Relations Department
Mercedes-Benz Canada, Inc.
98 Vanderhoof Avenue
Toronto, Ontario M4G 4C9

Reporting safety defects

For the USA only:

The following text is published as required of manufacturers under Title 49, Code of U.S. Federal Regulations, Part 575 pursuant to the “National Traffic and Motor Vehicle Safety Act of 1966”.

Reporting safety defects

If you believe that your vehicle has a defect which could cause a crash or could cause injury or death, you should immediately inform the National Highway Traffic Safety Administration (NHTSA) in addition to notifying Mercedes-Benz USA, LLC.

If NHTSA receives similar complaints, it may open an investigation, and if it finds that a safety defect exists in a group of vehicles, it may order a recall and remedy campaign. However, NHTSA cannot become involved in individual problems between you, your dealer, or Mercedes-Benz USA, LLC.

To contact NHTSA, you may call the Vehicle Safety Hotline toll-free at 1-888-327-4236

(TTY: 1-800-424-9153); go to www.safercar.gov; or write to: Administrator, NHTSA Headquarters, 1200 New Jersey Avenue, SE, West Building, Washington, DC 20590.

You can also obtain other information about motor vehicle safety from www.safercar.gov.

Vehicle data recording

Information regarding electronic recording devices

(Including notice pursuant to California Code § 9951)

Please note that your vehicle is equipped with devices that can record vehicle systems data and, if equipped with the Tele Aid system, may transmit some data in certain accidents.

This information helps, for example, to diagnose vehicle systems after a collision and to continuously improve vehicle safety. Daimler may access the information and share it with others

- for safety research or vehicle diagnosis purposes
- with the consent of the vehicle owner or lessee
- in response to an official request by law enforcement or other government agency
- for use in dispute resolution involving Daimler, its affiliates or sales/service organization and/or
- as otherwise required or permitted by law

Please check the Tele Aid subscription service agreement for details regarding the information that may be recorded or transmitted via that system.

تلفن شبانه روزی: ۰۲۱-۸۸۸۶۲۰۸۵

FarmaSOS.com

Exterior view	26
Cockpit	27
Instrument cluster	28
Multifunction steering wheel	30
Center console	32
Overhead control panel	33
Door control panel	34

امداد خودرو فارما

تلفن شبانه روزی: ۰۲۱-۸۸۸۶۲۰۸۵

FarmaSOS.com



Exterior view

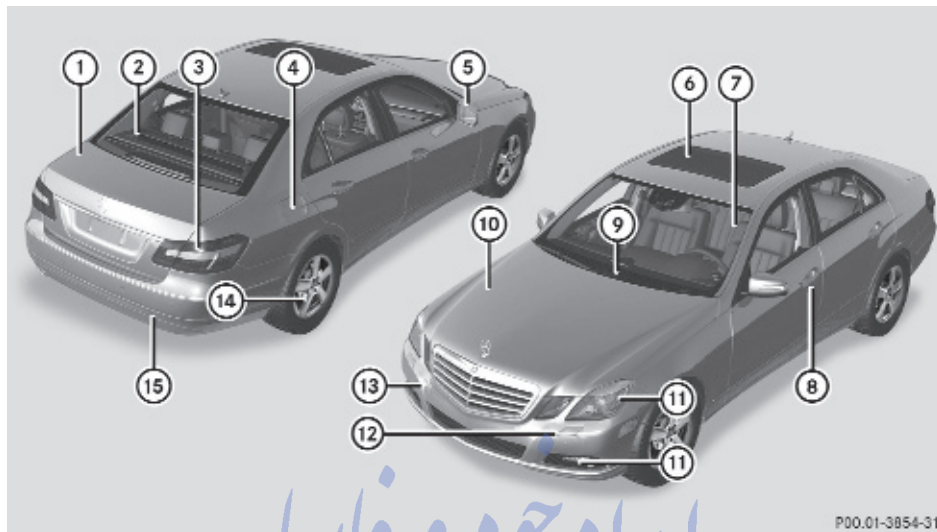

P00.01-3854-31

- i** This Operator's Manual describes all features, standard or optional, potentially available for your vehicle at the time of purchase. Please be aware that your vehicle might not be equipped with all features described in this manual.

	Function	Page	Function	Page
①	Trunk:		Cleaning	264
	Locking and unlocking	76	⑧ Doors: Locking and unlocking	76, 314
	Opening and closing	81		
	Valet locking	85		
②	Rear window defroster	191	⑨ Wipers Wiper blades, replacing Wiper blades, cleaning	104 322 264
③	Rear lamps	318		
④	Fuel filler flap	220		
⑤	Exterior rear view mirrors	95	⑩ Hood	223
	Parking position	95	⑪ Front lamps	318
⑥	Roof:		⑫ Headlamp cleaning system	102
	Power tilt/sliding sunroof	192	⑬ Front towing eye	341
	Panorama roof with power tilt/sliding panel	194		
⑦	Windshield:		⑭ Tires and wheels Rims and tires	228 353
	Wiping with washer fluid	105		
			⑮ Rear towing eye	341

Cockpit

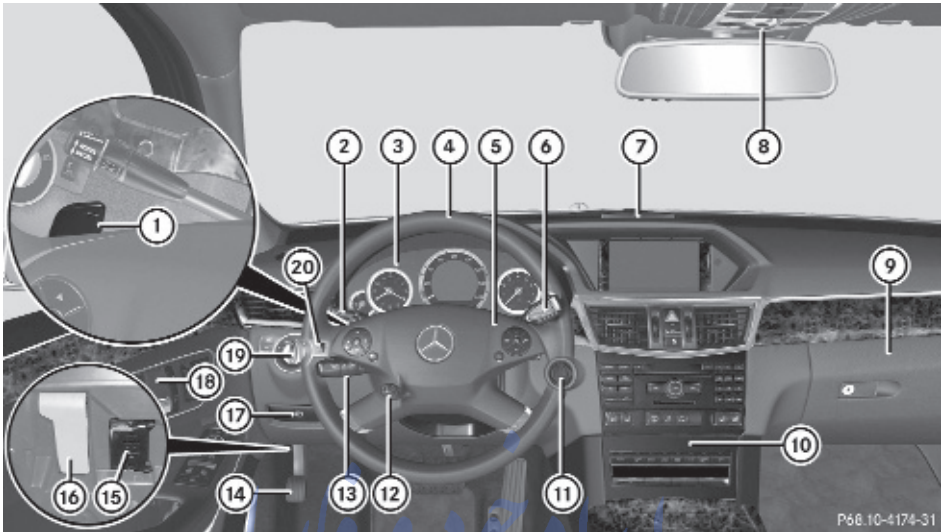

P68.10-4174-31

Function	Page	Function	Page
① Steering wheel gearshift control	121	KEYLESS-GO start/stop button	86
② Cruise control lever: Cruise control DISTRONIC PLUS	146 149	⑫ Steering wheel adjustment stalk	93
③ Instrument cluster	125	⑬ Combination switch: Turn signals Wipers High beam	100 104 100
④ Multifunction steering wheel	126	⑭ Parking brake pedal	113
⑤ Horn		⑮ On-board diagnostics (OBD) socket	
⑥ Gear selector lever	115	⑯ Hood lock release	223
⑦ Front Parktronic warning indicators	167	⑰ Parking brake release	113
⑧ Overhead control panel	33	⑱ Door control panel	34
⑨ Glove box	201	⑲ Exterior lamp switch	97
⑩ Center console	32	⑳ Night View Assist Plus	172
⑪ Starter switch	85		

Instrument cluster

At a glance



P54.32-7913-31

- i** Please refer to the overview of the indicator and warning lamps (▷ page 29).

	Function	Page
①	Fuel gauge	126
②	Speedometer	
③	Cruise control speed segments	146
	DISTRONIC PLUS segments	151
④	Multifunction display	128
⑤	Coolant temperature gauge	125
⑥	Tachometer	126
⑦	Clock	
⑧	Instrument cluster illumination	125

تلفن شبانه روزی: ۰۲۱-۸۸۶۴۲۰۸۵

FarmaSOS.com

Indicator and warning lamps

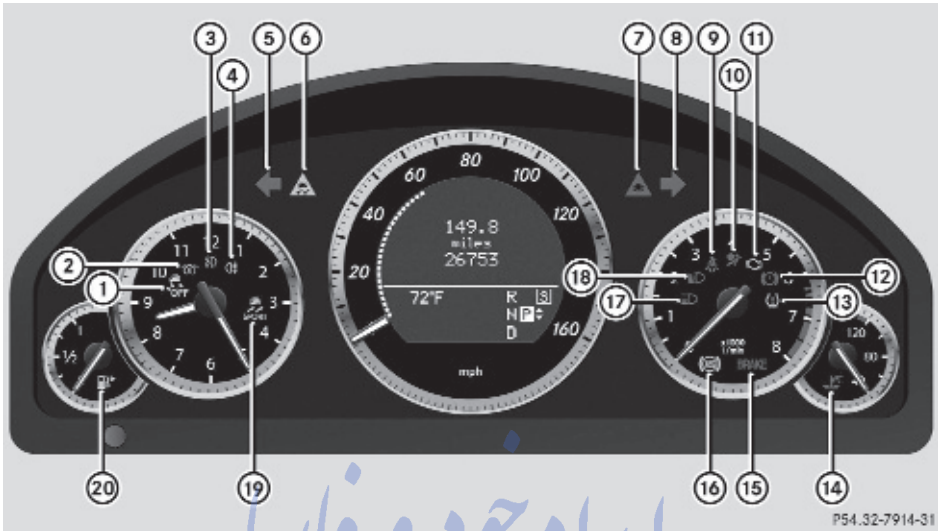

P54.32-7914-31

Function	Page	Function	Page
① ESC OFF warning lamp	308	⑪ Engine malfunction indicator lamp	310
② Preglow indicator lamp, diesel engine only	110	⑫ Brake warning lamp, Canada only	306
③ Front foglamp indicator lamp	99	⑬ Combination low tire pressure/TPMS malfunction telltale, USA only	233, 312
④ Rear foglamp indicator lamp	99	Low tire pressure telltale, Canada only	233, 312
⑤ Left turn signal indicator lamp	100	⑭ Coolant temperature warning lamp	311
⑥ ESC warning lamp	308	⑮ Brake warning lamp, USA only	306
⑦ Distance warning lamp ¹	309	⑯ Antilock Brake System (ABS) indicator lamp	305
⑧ Right turn signal indicator lamp	100	⑰ High-beam headlamp indicator lamp	100
⑨ Seat belt telltale	307		
⑩ Supplemental Restraint System (SRS) indicator lamp	308		





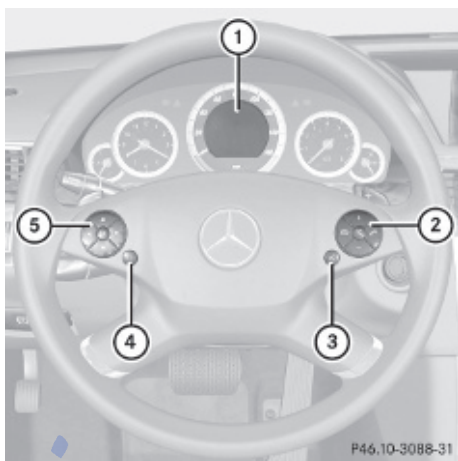

¹ Vehicles without DISTRONIC PLUS: Warning lamp without function. It illuminates when the ignition is on. It should go out when the engine is running.

	Function	Page
18	Low-beam headlamp indicator lamp	97
19	ESC SPORT warning lamp	67
20	Fuel tank reserve warning lamp	310

Multifunction steering wheel











P46.10-3088-31

	Function	Page
①	Multifunction display	128
②	Press button  or  to set the volume.	134
	Press button  :	
	to end a call	136
	to reject an incoming call	136
	Press button  :	
	to answer a call	136
	to dial ²	136
	to redial ²	137
	Press button  to mute.	
③	Press button  to activate the Voice Control System ³ .	

² Function only available in telephone menu.

³ Function only available in vehicles with Voice Control System.

Function	Page	
④ Press button  briefly:	to go to the next higher menu level	128
	to confirm display message	128
	to cancel the Voice Control System ³	
	Press and hold button  to select the standard display.	128
⑤ Press button  or  :	to call up line for menus	128
	to scroll to the left or right	
	to select menus	
	Press button  or  briefly:	128
	to select submenus	
	to scroll up or down through lists	
	to select previous or next track, scene, or stored station within Audio menu	134
	to switch to the phone book and select a name or number within Tel menu	135
	Press and hold button  or  :	128
	to select previous or next track or scene with quick search or to select previous or next station in waveband (if no station list is available) within Audio menu	134
to start the quick search in the phone book within Tel menu	135	

Function	Page
Press button  :	
to confirm selection or message	128
to switch to the phone book ²	135
to dial a selected phone number ²	136

³ Function only available in vehicles with Voice Control System.

² Function only available in telephone menu.

Center console

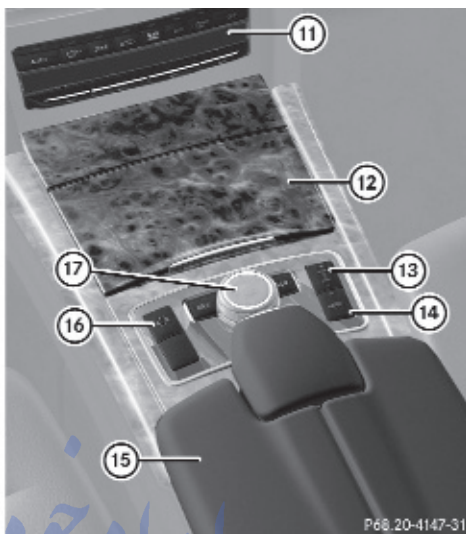
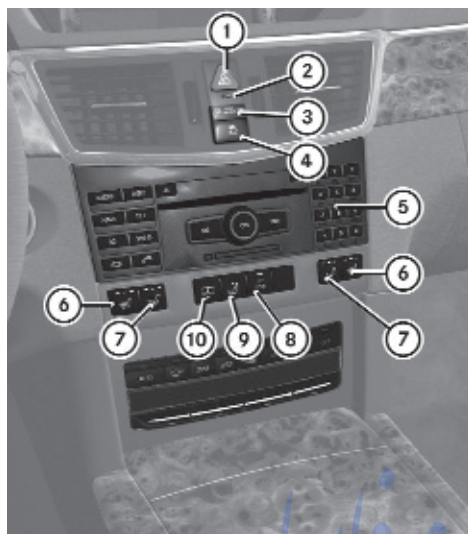

P68.20-4147-31

	Function	Page		Function	Page
①	Hazard warning flasher switch	101	⑨	Rear seat head restraints switch, folding down	89
②	Alarm system indicator lamp	72	⑩	Rear window sunshade switch	205
③	Front passenger front air bag off indicator lamp, USA only	43, 314	⑪	Dual-zone automatic climate control	181
	Front passenger front air bag off indicator lamp, Canada only	46, 314		3-zone automatic climate control, Canada only	183
④	Electronic Stability Control system (ESC) switch	65		Rear window defroster	191
⑤	COMAND system, see separate operating instructions		⑫	Storage compartment	201
⑥	Seat heating switch	92		Ashtray	206
⑦	Seat ventilation switch	92		Cup holder	203
⑧	Parktronic system deactivation switch	168	⑬	Damping system switch	163
			⑭	Vehicle level control switch	163
			⑮	Storage compartment	201
			⑯	Program mode selector switch	120
			⑰	COMAND controller, see separate operating instructions	

Overhead control panel

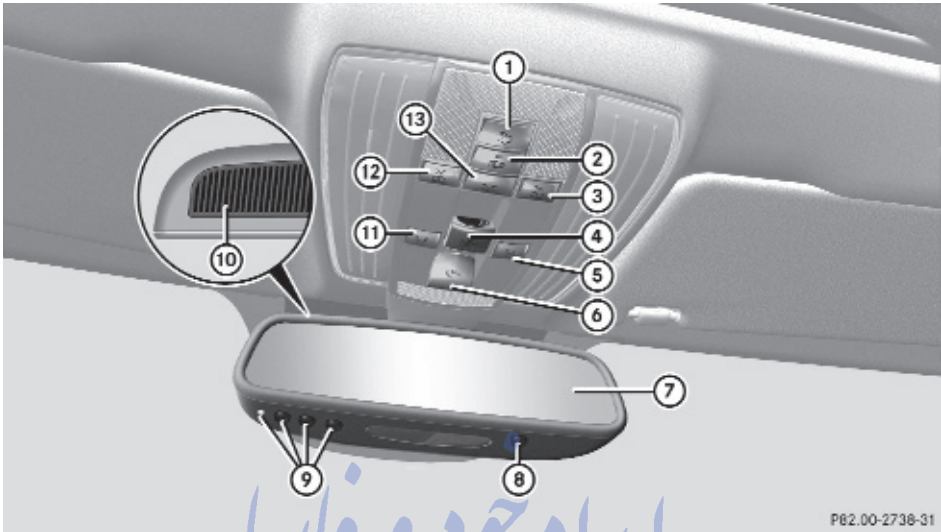

PB2.00-2738-31

Function	Page	Function	Page
① Rear interior lighting on/off	103	⑨ Garage door opener	212
② Automatic interior lighting control	103	⑩ Hands-free microphone for Tele Aid (emergency call system), telephone and Voice Control System ⁴	
③ Right reading lamp on/off	103	⑪ Roadside Assistance button (Tele Aid system)	210
④ Roof panel switch	192, 195	⑫ Left reading lamp on/off	103
⑤ Information button (Tele Aid system)	210	⑬ Front interior lighting on/off	103
⑥ SOS button (Tele Aid system)	209		
⑦ Interior rear view mirror	94		
⑧ Integrated electronic compass	216		

⁴ See separate operating instructions.

Door control panel

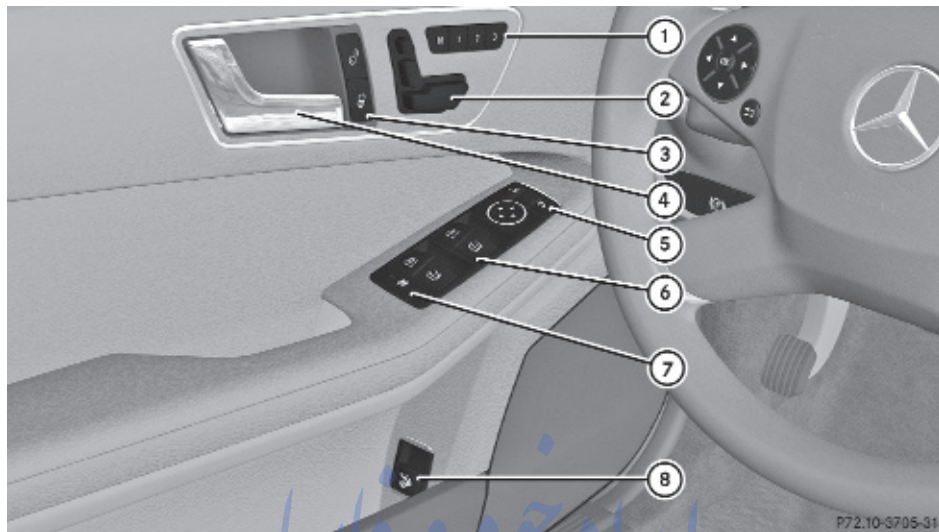

	Function	Page
①	Memory function (for storing seat, exterior mirror and steering wheel settings)	96
②	Seat adjustment switches	88
③	Central locking/unlocking switch	81
④	Inside door handle	80
⑤	Exterior rear view mirror adjustment	95
⑥	Switches for opening/closing front and rear door windows	105
⑦	Rear door window override switch	60
⑧	Trunk opening switch, trunk opening/closing system	81

Vehicle equipment	36
Occupant safety	36
Panic alarm	61
Driving safety systems	61
Anti-theft systems	71

امداد خودرو فارما

تلفن شبانه روزی: ۰۲۱-۸۸۸۶۲۰۸۵

FarmaSOS.com



Vehicle equipment

- i** This Operator's Manual describes all features, standard or optional, potentially available for your vehicle at the time of purchase. Please be aware that your vehicle might not be equipped with all features described in this manual.

Occupant safety

Introduction

In this section you will learn the most important facts about the restraint system components of the vehicle.

The restraint systems are:

- Seat belts
- Child restraints
- Lower Anchors and Tethers for Children (LATCH) also known as ISOFIX

Additional protection potential is provided by:

- Supplemental Restraint System (SRS) with
 - Air bags
 - Air bag control unit (with crash sensors)
 - Emergency Tensioning Device (ETD) for seat belts
 - Seat belt force limiter
- NECK-PRO active front head restraints
- Preventive occupant safety (PRE-SAFE®)
- Air bag system components with
 - Front passenger front air bag off indicator lamp
 - USA only: Front passenger seat with Occupant Classification System (OCS)
 - Canada only: Front passenger seat with BabySmart™ air bag deactivation system

Although the systems are independent, their protective functions work in conjunction with each other.

Warning!

Modifications to or work improperly conducted on restraint system components or their wiring, as well as tampering with interconnected electronic systems, can lead to the restraint systems no longer functioning as intended.

Air bags or Emergency Tensioning Devices (ETDs), for example, could deploy inadvertently or fail to deploy in accidents although the deceleration threshold for air bag deployment is exceeded. Therefore, never modify the restraint systems. Do not tamper with electronic components or their software.

- i** See “Children in the vehicle” (▷ page 56) for information on
- infants and children traveling with you in the vehicle
 - restraint systems for infants and children

SRS indicator lamp

The SRS system conducts a self-test when the ignition is switched on and in regular intervals while the engine is running. This facilitates detection of system malfunctions.

The SRS indicator lamp  in the instrument cluster comes on when the ignition is switched on. It goes out no later than a few seconds after the engine has been started.

The SRS components are in operational readiness when the SRS indicator lamp  is not lit while the engine is running.

⚠ Warning!

The SRS self-check has detected a malfunction when the SRS indicator lamp



- does not come on at all
- fails to go out after approximately 4 seconds after the engine was started
- comes on after the engine was started or while driving

For your safety, we strongly recommend that you contact an authorized Mercedes-Benz Center immediately to have the system checked. Otherwise the SRS may not be activated when needed in an accident, which could result in serious or fatal injury. The SRS might also deploy unexpectedly and unnecessarily which could also result in injury as well.

In addition, improper work on the SRS creates a risk of rendering the SRS inoperative or causing unintended air bag deployment. Work on the SRS must therefore only be performed by qualified technicians. Contact an authorized Mercedes-Benz Center.

If it is necessary to modify an air bag system to accommodate a person with disabilities, contact an authorized Mercedes-Benz Center. USA only: Call our Customer Assistance Center at 1-800-FOR-MERCEDES (1-800-367-6372) for details.

Air bags**⚠ Warning!**

Air bags are designed to reduce the potential of injury and fatality in certain

- frontal impacts (front air bags and driver's side knee bag)
- side impacts (side impact air bags, window curtain air bags and pelvis air bags)
- rollovers (window curtain air bags)

However, no system available today can completely eliminate injuries and fatalities.

Deployment of the air bags temporarily releases a small amount of dust from the air bags. This dust, however, is neither harmful to your health, nor does it indicate a fire in the vehicle. The dust might cause some temporary breathing difficulty for people with asthma or other breathing trouble. To avoid this, you may wish to get out of the vehicle as soon as it is safe to do so. If you have any breathing difficulty but cannot get out of the vehicle after the air bag inflates, then get fresh air by opening a window or door.

⚠ Warning!

To reduce the risk of injury when the front air bags inflate, it is very important for the driver and front passenger to always be in a properly seated position and to wear their respective seat belt.

For maximum protection in the event of a collision always be in normal seated position with your back against the seat backrest. Fasten your seat belt and make sure it is properly positioned on your body.

Since the air bag inflates with considerable speed and force, a proper seating position and correct positioning of the hands on the steering wheel will help to keep you at a safe distance from the air bag. Occupants who are not wearing their seat belt, are not seated properly or are too close to the air bag can be seriously injured or killed by an air bag as it inflates with great force instantaneously:

- Sit with the seat belt properly fastened in a position that is as upright as possible with your back against the seat backrest.
- Move the driver's seat as far back as possible, still permitting proper operation of vehicle controls. The distance from the center of the driver's chest to the center of the air bag cover on the steering wheel must be at least 10 inches (25 cm) or more. You should be able to accomplish this by

adjusting the seat and steering wheel. If you have any difficulties, please contact an authorized Mercedes-Benz Center.

- Do not lean your head or chest close to the steering wheel or dashboard.
- Keep hands on the outside of the steering wheel rim. Placing hands and arms inside the rim can increase the risk and potential severity of hand/arm injury when the driver front air bag inflates.
- Adjust the front passenger seat as far as possible rearward from the dashboard when the seat is occupied.
- Occupants, especially children, should never place their bodies or lean their heads in the area of the door where the side impact air bag inflates. This could result in serious injuries or death should the side impact air bag be deployed. Always sit as upright as possible, wear the seat belt properly and use an appropriately sized infant restraint, toddler restraint, or booster seat recommended for the size and weight of the child.
- Canada only: Children 12 years old and under must never ride in the front seat, except in a Mercedes-Benz authorized BabySmart™ compatible child seat, which operates with the BabySmart™ air bag deactivation system installed in the vehicle to deactivate the front passenger front air bag when it is installed properly. Otherwise they will be struck by the air bag when it inflates in a crash. If this happens, serious or fatal injury will result.

Failure to follow these instructions can result in severe injuries to you or other occupants. If you sell your vehicle, it is important that you make the buyer aware of this safety information. Be sure to give the buyer this Operator's Manual.

Warning!

Accident research shows that the safest place for children in an automobile is in a rear seat.

There is a possibility for a side impact air bag-related injury if occupants, especially children, are not properly seated or restrained when next to a side impact air bag which needs to deploy rapidly in a side impact in order to do its job.

To help avoid the possibility of injury, please follow these guidelines:

- (1) Always sit as upright as possible, wear the seat belt properly, and for children 12 years old and under, use an appropriately sized infant restraint, toddler restraint, or booster seat recommended for the size and weight of the child.
- (2) Always wear seat belts properly.

Air bags are designed to deploy only in certain

- frontal impacts (front air bags and driver's side knee bag)
- side impacts (side impact air bags, pelvis air bags and window curtain air bags) if the system determines the need for air bag deployment
- rollovers (window curtain air bags)

Only in the event of such a situation will they provide their supplemental protection.

The driver and passengers should always wear their seat belts. Otherwise it is not possible for the air bags to provide their supplemental protection.

In case of other types of impacts and impacts below air bag deployment thresholds, air bags will not deploy. The driver and passengers will then be protected to the extent possible by a properly fastened seat belt. A properly fastened seat belt is also needed to provide the best possible protection in a rollover.

Air bags are not a substitute for seat belts. Always wear your seat belt, regardless of

whether or not your vehicle is equipped with air bags.

It is important to your safety and that of your passengers to have deployed air bags replaced and to have any malfunctioning air bags repaired. This will help to make sure the air bags will continue to provide supplemental crash protection for occupants.

Safety guidelines for the seat belt, Emergency Tensioning Device (ETD) and air bag

Warning!

- Damaged seat belts or seat belts that have been subjected to stress in an accident must be replaced. Their anchoring points must also be checked. Only use seat belts installed or supplied by an authorized Mercedes-Benz Center.
- Air bags and pyrotechnic Emergency Tensioning Devices (ETDs) contain perchlorate material, which may require special handling and regard for the environment. Check with your local government's disposal guidelines. California residents, see www.dtsc.ca.gov/HazardousWaste/Perchlorate/index.cfm.
- Air bags and ETDs are designed to function on a one-time-only basis. An air bag or ETD that has deployed must be replaced. PRE-SAFE® has electrically operated reversible pre-tensioners in addition to the pyrotechnic ETDs.
- Do not pass seat belts over sharp edges. They could tear.
- Do not make any modification that could change the effectiveness of the seat belts.
- Do not bleach or dye seat belts as this may severely weaken them. In a crash they may not be able to provide adequate protection.
- No modifications of any kind may be made to any components or wiring of the SRS.
- Do no change or remove any component or part of the SRS.
- Do not install additional trim material, seat covers, badges, etc. over the steering wheel hub, front passenger front air bag cover, outboard sides of the seat backrests, door trim panels, or door frame trims.
- Do not install additional electrical/ electronic equipment on or near SRS components and wiring.
- Keep area between air bags and occupants free of objects (e.g. packages, purses, umbrellas, etc.).
- Do not hang items such as coat hangers from the coat hooks or handles over the door. These items may be thrown around in the vehicle and cause head and other injuries when the window curtain air bag is deployed.
- Air bag system components will be hot after an air bag has inflated. Do not touch them.
- Never place your feet on the instrument panel, dashboard, or on the seat. Always keep both feet on the floor in front of the seat.
- Improper repair work on the SRS creates a risk of rendering the SRS inoperative or causing unintended air bag deployment. Work on the SRS must therefore only be performed by qualified technicians. Contact an authorized Mercedes-Benz Center.
- For your protection and the protection of others, when scrapping the air bag unit or ETD, our safety instructions must be followed. These instructions are available from any authorized Mercedes-Benz Center.
- Given the considerable deployment speed, required inflation volume, and the material of the air bags, there is the possibility of

abrasions or other, potentially more serious injuries resulting from air bag deployment.

If you sell your vehicle, we strongly recommend that you inform the subsequent owner that the vehicle is equipped with SRS. Also refer them to the applicable section in the Operator's Manual.

Front air bags

 **Observe Safety notes, see page 37.**

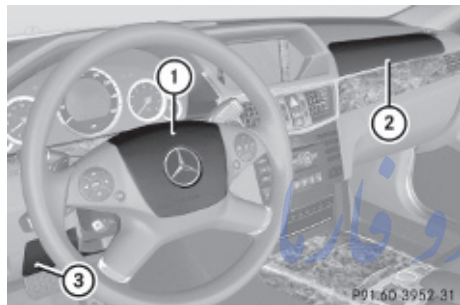

Driver's front air bag ① and front passenger front air bag ② are designed to provide increased protection for the driver and front passenger against the risk of injuries to the head and thorax.

Driver and front passenger front air bag and driver's side knee bag are deployed

- in the event of certain frontal impacts
- if the system determines that air bag deployment can offer additional protection to that provided by the seat belt
- depending on whether the respective seat belt is in use
- independently of the side impact air bags, pelvis air bags and/or the window curtain air bags

The front air bags in this vehicle have been designed to inflate in two stages. This allows the air bags to have different rates of inflation. The rate of inflation is based on the vehicle deceleration rate as assessed by the air bag control unit.

Vehicles with OCS, USA only: The front passenger front air bag deployment is additionally influenced by the passenger's weight category as identified by the Occupant Classification System (OCS) (> page 43).

Vehicles with OCS, USA only: The lighter the front passenger-side occupant, the higher the vehicle deceleration rate required for second stage inflation of the front passenger front air bag.

The air bags will not deploy in impacts which do not exceed the system's preset deployment thresholds. You will then be protected by the fastened seat belts.

The front air bags will not deploy in the event of a rollover unless the vehicle's rate of longitudinal deceleration or acceleration exceeds the preset deployment threshold for the front air bags.

The front passenger front air bag will only be deployed if

- vehicles with OCS, USA only: the system, based on OCS weight sensor readings, detects that the front passenger seat is occupied
- the  indicator lamp in the center console is not lit (USA only: (> page 43), Canada only: (> page 46))
- the impact exceeds a preset deployment threshold

! Vehicles with BabySmart™ air bag deactivation system (Canada only): Do not place objects heavier than 20 lb (9 kg) on the front passenger seat. This could cause the front or side impact air bag on the front passenger side to deploy in a crash which exceeds the system's deployment threshold.

Knee bag

Knee bag ③ is designed to provide increased protection for the driver against the risk of injuries to the knees, thighs and lower legs.

Knee bag ③ is located on the driver side lower instrument panel. It is designed to

operate together with the driver front air bag in certain frontal impacts if the system determines that air bag deployment can offer additional protection to that provided by the seat belt. Knee bag ③ operates best in conjunction with a properly positioned and fastened seat belt.

Side impact air bags

⚠ **Observe Safety notes, see page 37.**

⚠ **Warning!**

The pressure sensors for side impact air bag control are located in the doors. Do not modify any components of the doors or door trim panels including, for example, the addition of door speakers.

Improper repair work on the doors or the modification or addition of components to the doors create a risk of rendering the side impact air bags inoperative or causing unintended air bag deployment. Work on the doors must therefore only be performed by qualified technicians. Contact an authorized Mercedes-Benz Center.

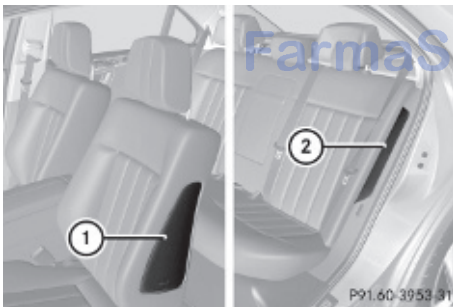

Front side impact air bags ① and rear side impact air bags ② are designed to provide increased protection for the thorax but not the head, neck and arms.

The side impact air bags are deployed

- on the impacted side of the vehicle
- in instances with a high rate of lateral vehicle deceleration or acceleration

- regardless of whether the seat belts on the impacted side of the vehicle are in use
- independently of the front air bags
- independently of the ETDs

Vehicles with OCS (USA only): The front passenger side impact air bag will not deploy if the OCS senses that the front passenger seat is empty and the front passenger seat belt is not fastened. With the front passenger seat empty and the seat belt fastened, the front passenger side impact air bag will deploy independently of the empty seat. Whether a seat belt is recognized as fastened depends on whether or not the latch plate is properly inserted into the buckle.

The side impact air bags are not deployed in side impacts which do not exceed the system's deployment threshold.

The side impact air bags will not deploy in the event of a rollover unless the vehicle's rate of lateral deceleration or acceleration exceeds the preset deployment threshold for the side impact air bags.

- ⚠ **Warning!** Vehicles with BabySmart™ air bag deactivation system (Canada only): Do not place objects heavier than 20 lb (9 kg) on the front passenger seat. This could cause the front or side impact air bag on the front passenger side to deploy in a crash which exceeds the system's deployment threshold.

⚠ **Warning!**

Only use seat covers which have been tested and approved by Mercedes-Benz for your vehicle model. Using other seat covers may interfere with or prevent the deployment of the side impact air bags and/or pelvis air bags. Contact an authorized Mercedes-Benz Center for availability.

Pelvis air bags

 **Observe Safety notes, see page 37.**

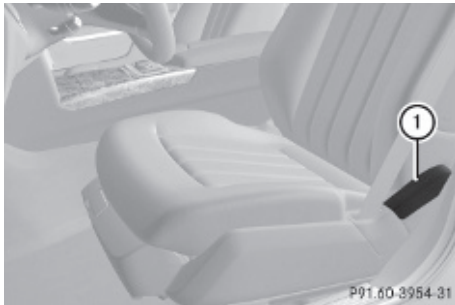

Pelvis air bags ① are designed to provide increased protection for the pelvis.

Pelvis air bags ① are deployed

- in instances with a high rate of lateral vehicle deceleration or acceleration
- on the impacted side of the vehicle
- independently of whether the seat belt is in use
- independently of the front air bags
- independently of the ETDs

Vehicles with OCS, USA only: Front passenger pelvis air bag ① will not deploy if the OCS senses that the front passenger seat is empty and the front passenger seat belt is not fastened. With the front passenger seat empty and the seat belt fastened, front passenger pelvis air bag ① will deploy independently of the empty seat. Whether a seat belt is recognized as fastened depends on whether or not the latch plate is properly inserted into the buckle.

Pelvis air bags ① are not deployed in side impacts which do not exceed the system's deployment threshold.

Pelvis air bags ① will not deploy in the event of a rollover unless the vehicle's rate of lateral deceleration or acceleration exceeds the preset deployment threshold for pelvis air bags ①.

Warning!

Only use seat covers which have been tested and approved by Mercedes-Benz for your vehicle model. Using other seat covers may interfere with or prevent the deployment of the side impact air bags and/or pelvis air bags. Contact an authorized Mercedes-Benz Center for availability.

Window curtain air bags

 **Observe Safety notes, see page 37.**

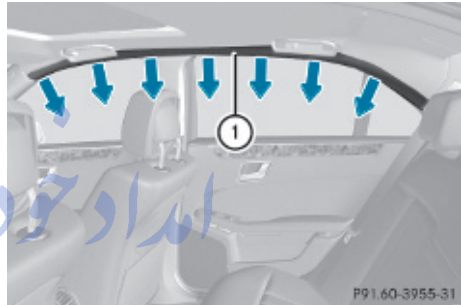

Window curtain air bags ① are designed to provide increased protection for the head but not the chest or arms.

Window curtain air bags ① are deployed

- on the impacted side of the vehicle
- in instances with a high rate of lateral vehicle deceleration or acceleration
- independently of the front air bags
- regardless of whether the front passenger seat is occupied
- regardless of whether the seat belt on the impacted side of the vehicle is in use
- in certain vehicle rollovers, if the system determines that air bag deployment can offer additional protection to that provided by the seat belt

Window curtain air bags ① are not deployed in impacts which do not exceed the system's deployment threshold.

Window curtain air bags ① deploy in the area indicated by the arrows.

Occupant Classification System

The Occupant Classification System (OCS) is standard equipment in USA.

The OCS activates or deactivates the front passenger front air bag automatically. The respective status is based on the classified occupant weight category determined by weight sensor readings from the front passenger seat.

The system does not deactivate

- the front passenger side impact air bag
- the pelvis air bag
- the window curtain air bag
- the Emergency Tensioning Devices (ETDs)

To be classified correctly, the front passenger must sit

- with the seat belt properly fastened
- in a position that is as upright as possible with the back against the seat backrest
- with the feet on the floor

If the occupant's weight is transferred to another object in the vehicle (e.g. by leaning on armrests), the OCS may not be able to properly approximate the occupant's weight category.

If your seat, including the trim cover and cushion, needs to be serviced in any way, take the vehicle to an authorized Mercedes-Benz Center.

Only seat accessories approved by Mercedes-Benz may be used.

Both the driver and the front passenger should always use the  indicator lamp as an indication of whether or not the front passenger is properly positioned.

Warning!



If the  indicator lamp illuminates when an adult or someone larger than a small individual is in the front passenger seat, have the front passenger reposition himself or

herself in the seat until the  indicator lamp goes out.

In the event of a collision, the air bag control unit will not allow front passenger front air bag deployment when the OCS has classified the front passenger seat occupant as weighting as much as or less than a typical 12-month-old child in a standard child restraint or if the front passenger seat is classified as being empty.



When the OCS senses that the front passenger seat occupant is classified as being up to or less than the weight of a typical 12-month-old child in a standard child restraint, the  indicator lamp will illuminate when the engine is started and remain illuminated, indicating that the front passenger front air bag is deactivated.



When the OCS senses that the front passenger seat is classified as being empty, the  indicator lamp will illuminate when the engine is started and remain illuminated, indicating that the front passenger front air bag is deactivated.

When the OCS senses that the front passenger seat occupant is classified as being heavier than the weight of a typical 12-month-old child seated in a standard child restraint or as being a small individual (such as a young teenager or a small adult), the  indicator lamp will illuminate for approximately 6 seconds when the engine is started and then, depending on occupant weight sensor readings from the seat, remain illuminated or go out. With the  indicator lamp illuminated, the front passenger front air bag is deactivated. With the  indicator lamp out, the front passenger front air bag is activated.

When the OCS senses that the front passenger seat occupant is classified as an adult or someone larger than a small individual, the  indicator lamp will illuminate for approximately 6 seconds when the engine is started and then goes out,

indicating that the front passenger front air bag is activated.

If the   indicator lamp is illuminated, the front passenger front air bag is deactivated and will not be deployed.

If the   indicator lamp is not illuminated, the front passenger front air bag is activated and will be deployed

- in the event of certain frontal impacts
- if impact exceeds a preset deployment threshold
- independently of the side impact air bags or pelvis air bag

If the front passenger front air bag is deployed, the rate of inflation will be influenced by

- the rate of relevant vehicle deceleration as assessed by the air bag control unit
- the front passenger's weight category as identified by the OCS

For more information on air bag display messages in the multifunction display, see (▷ page 276).

Warning!











According to accident statistics, children are safer when properly restrained in the rear seating positions than in the front seating position. Thus, we strongly recommend that children be placed in the rear seats whenever possible. Regardless of seating position, children 12 years old and under must be seated and properly secured in an appropriate infant restraint, toddler restraint, or booster seat recommended for the size and weight of the child.

The infant or child restraint must be properly secured with the vehicle's seat belt, the seat belt and top tether strap, or lower anchors and top tether strap, fully in accordance with the child seat manufacturer's instructions.

Occupants, especially children, should always sit as upright as possible, wear the seat belt

properly and use an appropriately sized infant restraint, toddler restraint, or booster seat recommended for the size and weight of the child.

Children can be killed or seriously injured by an inflating air bag. Note the following important information when circumstances require you to place a child in the front passenger seat:

- Your vehicle is equipped with air bag technology designed to deactivate the front passenger front air bag in your vehicle when the system senses the weight of a typical 12-month-old child or less along with the weight of a standard appropriate child restraint on the front passenger seat.
- A child in a rear-facing child restraint on the front passenger seat will be seriously injured or even killed if the front passenger front air bag inflates in a collision which could occur under some circumstances, even with the air bag technology installed in your vehicle. The only means to completely eliminate this risk is to never place a child in a rear-facing child restraint in the front seat. We therefore strongly recommend that you always place a child in a rear-facing child restraint in a backseat.
- If you must install a rear-facing child restraint on the front passenger seat because circumstances require you to do so, make sure the   indicator lamp is illuminated, indicating that the front passenger front air bag is deactivated. Should the   indicator lamp not illuminate or go out while the restraint is installed, please check installation. Periodically check the   indicator lamp while driving to make sure the   indicator lamp is illuminated. If the   indicator lamp goes out or remains out, do not transport a child on the front passenger seat until the system has been repaired.

A child in a rear-facing child restraint on the front passenger seat will be seriously injured or even killed if the front passenger front air bag inflates.

- If you have to place a child in a forward-facing child restraint on the front passenger seat, move the seat as far back as possible, use the proper child restraint recommended for the age, size and weight of the child, and secure child restraint with the vehicle's seat belt according to the child seat manufacturer's instructions. For children larger than the typical 12-month-old child, the front passenger front air bag may or may not be activated.

Deployment of the driver front air bag does not mean that the front passenger front air bag also should have deployed.

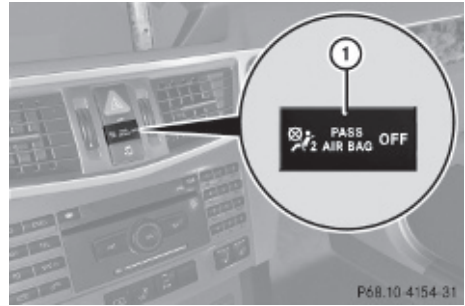

The OCS may have determined

- that the seat was empty or occupied by the weight up to or less than that of a typical 12-month-old child seated in a standard child restraint – both of which are instances where the system suppresses deployment of the front passenger front air bag even though the impact met the criteria and was of sufficient severity to deploy the driver front air bag
- that the seat was occupied by a small individual (such as a young teenager or a small adult) or a child who weighs more than the weight of a typical 12-month-old child in a standard child restraint – both of which are instances where the system may suppress deployment of the front passenger front air bag even though the impact met the criteria and was of sufficient severity to deploy the driver front air bag



 indicator lamp ① will be illuminated, except with the SmartKey removed from the starter switch or with the starter switch in position 0.







Warning!

If the red SRS indicator lamp  in the instrument cluster and the  indicator lamp are lit at the same time, there is a malfunction in the OCS. The front passenger front air bag will be deactivated in this case. Have the system checked by qualified technicians as soon as possible. Contact an authorized Mercedes-Benz Center.



Only have the seat repaired or replaced at an authorized Mercedes-Benz Center. In order to ensure proper operation of the air bag system and OCS:

- Sit with the seat belt properly fastened in a position that is as upright as possible with your back against the seat backrest.
- While seated, an occupant should not position him/herself in such a way as to cause the occupant's weight to be lifted from the seat bottom as this may result in the OCS being unable to correctly approximate the occupant's weight category.
- Read and observe all warnings in this chapter.

OCS Self-test

After turning the SmartKey in the starter switch to position **1** or **2** or pressing the KEYLESS-GO start/stop button once or twice, the   indicator lamp illuminates. If an adult occupant is properly sitting on the front passenger seat and the system classifies the occupant as an adult, the   indicator lamp will illuminate and go out after approximately 6 seconds. If the seat is not occupied and the system classifies the front passenger seat as being empty, the   indicator lamp will illuminate and not go out.

Warning!

If the   indicator lamp does not illuminate, the system is not functioning. You must contact an authorized Mercedes-Benz Center before seating any child on the front passenger seat.

For more information, see the “Practical hints” section (▷ page 314).

Warning!

Never place anything between seat cushion and child seat (e.g. pillow), since it reduces the effectiveness of the OCS. The bottom and back of the child seat must make full contact with the passenger seat cushion and backrest.

If necessary, adjust the tilt of the passenger seat backrest.

An incorrectly mounted child seat could cause injuries to the child in case of an accident, instead of increasing protection for the child.

Follow the manufacturer’s instructions for installation of child seats.

BabySmart™ air bag deactivation system

The BabySmart™ air bag deactivation system is standard equipment in Canada.

Warning!

According to accident statistics, children are safer when properly restrained in the rear seating positions than in the front seating position. Thus, we strongly recommend that children be placed in the rear seats whenever possible. Regardless of seating position, children 12 years old and under must be seated and properly secured in an appropriate infant restraint, toddler restraint, or booster seat recommended for the size and weight of the child.





The infant or child restraint must be properly secured with the vehicle’s seat belt, the seat belt and top tether strap, or lower anchors and top tether strap, fully in accordance with the child seat manufacturer’s instructions.

Occupants, especially children, should always sit as upright as possible, wear the seat belt properly and use an appropriately sized infant restraint, toddler restraint, or booster seat recommended for the size and weight of the child.

Children can be killed or seriously injured by an inflating air bag. Note the following important information when circumstances require you to place a child in the front passenger seat:

- Children 12 years old and under must never ride in the front seat, except in a Mercedes-Benz authorized BabySmart™ compatible child seat, which operates with the BabySmart™ system installed in the vehicle to deactivate the front passenger front air bag when it is installed properly. Otherwise they will be struck by the air bag when it inflates in a crash. If this happens, serious or fatal injury will result.
- A child in a rear-facing child restraint on the front passenger seat will be seriously injured or even killed if the front passenger front air bag inflates in a collision which could occur under some circumstances, even with the air bag technology installed in your vehicle. The only means to

completely eliminate this risk is to never place a child in a rear-facing child restraint in the front seat. We therefore strongly recommend that you always place a child in a rear-facing child restraint in a backseat.



- If you must install a BabySmart™ compatible rear-facing child restraint on the front passenger seat because circumstances require you to do so, make sure the  PASS AIR BAG OFF indicator lamp is illuminated, indicating that the front passenger front air bag is deactivated. Should the  PASS AIR BAG OFF indicator lamp not illuminate or go out while the restraint is installed, please check installation. Periodically check the  PASS AIR BAG OFF indicator lamp while driving to make sure the  PASS AIR BAG OFF indicator lamp is illuminated. If the  PASS AIR BAG OFF indicator lamp goes out or remains out, do not transport a child on the front passenger seat until the system has been repaired.

A child in a rear-facing child restraint on the front passenger seat will be seriously injured or even killed if the front passenger front air bag inflates.

- If you have to place a child in a forward-facing child restraint on the front passenger seat, move the seat as far back as possible, use the proper child restraint recommended for the age, size and weight of the child, and secure child restraint with the vehicle's seat belt according to the child seat manufacturer's instructions.

Warning!

When using a BabySmart™ compatible child seat on the front passenger seat, the front passenger front air bag will not deploy only if the  PASS AIR BAG OFF indicator lamp remains illuminated.

Please be sure to check the  PASS AIR BAG OFF indicator lamp every time you use a BabySmart™ compatible child seat on the front passenger seat. Should the  PASS AIR BAG OFF

indicator lamp go out while the restraint is installed, please check installation. If the  PASS AIR BAG OFF indicator lamp remains out, do not use the BabySmart™ restraint to transport a child on the front passenger seat until the system has been repaired.



Special BabySmart™ compatible child seats, designed for use with the Mercedes-Benz system, are required for use with the BabySmart™ air bag deactivation system. Please contact an authorized Mercedes-Benz Center for information on availability. With the special child seat installed properly, the front passenger front air bag will not deploy.

 PASS AIR BAG OFF indicator lamp ① will be illuminated, except with the SmartKey removed from the starter switch or with the starter switch in position **0**.

The system does not deactivate



- the side impact air bag
- the pelvis air bag
- the window curtain air bag
- the Emergency Tensioning Device (ETD)

Self-test BabySmart™ without special child seat installed

After turning the SmartKey in the starter switch to position **1** or **2** or pressing the KEYLESS-GO start/stop button once or twice, the  PASS AIR BAG OFF indicator lamp comes on for approximately 6 seconds and then goes out.

If the  WASER AIR BAG OFF indicator lamp should not come on or is continuously lit, the system is not functioning. You must see an authorized Mercedes-Benz Center before seating any child on the front passenger seat. More information can be found in the “Practical hints” section (▷ page 313).

Warning!

Do not place powered-on laptops, mobile phones, electronic tags such as those used in ski passes and like electronic devices on the front passenger seat. Signals from such devices may interfere with the BabySmart™ air bag deactivation system. Such signal interference may cause the  WASER AIR BAG OFF indicator lamp not to come on during self-test. The SRS indicator lamp  and/or the  WASER AIR BAG OFF indicator lamp could be continuously lit, indicating that the system is not functioning. The front passenger front air bag could deploy inadvertently or fail to deploy in an accident.

Warning!

The BabySmart™ air bag deactivation system will ONLY work with a special child seat designed to operate with it. It will not work with child seats which are not BabySmart™ compatible.

Never place anything between seat cushion and child seat (e.g. pillow), since it reduces the effectiveness of the BabySmart™ air bag deactivation system. The bottom of the child seat must make full contact with the front passenger seat cushion. An incorrectly mounted child seat could cause injuries to the child in case of an accident, instead of protecting the child.

Follow the manufacturer’s instructions for installation of special child seats.

Seat belts

Safety notes

The use of seat belts and infant and child restraint systems is required by law in all 50 states, the District of Columbia, the U.S. territories and all Canadian provinces.

Even where this is not the case, all vehicle occupants should have their seat belts fastened whenever the vehicle is in motion.

-  See “Children in the vehicle” (▷ page 56) for information on
 - infants and children traveling with you in the vehicle
 - restraint systems for infants and children

Warning!

Always fasten your seat belt before driving off. Always make sure all of your passengers are properly restrained. You and your passengers should always wear seat belts.

Failure to wear and properly fasten and position your seat belt greatly increases your risk of injuries and their likely severity in an accident.

If you are ever in an accident, your injuries can be considerably more severe without your seat belt properly buckled. Without your seat belt buckled, you are much more likely to hit the interior of the vehicle or be ejected from it. You can be seriously injured or killed.

In the same crash, the possibility of injury or death is lessened if you are properly wearing your seat belt. The air bags can only protect as intended if the occupants are properly wearing their seat belts.

Warning!

Never ride in a moving vehicle with the seat backrest in an excessively reclined position as this can be dangerous. You could slide under the seat belt in a collision. If you slide under it, the seat belt would apply force at the abdomen or neck. That could cause serious or even fatal injuries. The seat backrest and

seat belt provide the best restraint when the wearer is in a position that is as upright as possible and the seat belt is properly positioned on the body.

Warning!

Never let more people ride in the vehicle than there are seat belts available. Make sure everyone riding in the vehicle is correctly restrained with a separate seat belt. Never use a seat belt for more than one person at a time.

Warning!

Damaged seat belts or seat belts that have been subjected to stress in an accident must be replaced. Also, the seat belt anchoring points must be checked.

Only use seat belts which have been approved by Mercedes-Benz.

Do not make any modifications to the seat belts. This can lead to unintended activation of the ETDs or to their failure to activate when necessary.

Do not bleach or dye seat belts as this may severely weaken them. In a crash they may not be able to provide adequate protection.

Have all work carried out only by qualified technicians. Contact an authorized Mercedes-Benz Center.

Proper use of seat belts

Warning!

USE SEAT BELTS PROPERLY

- Seat belts can only protect when used properly. Never wear seat belts in any other way than as described in this section, as that could result in serious injuries in case of an accident.
- Each occupant should wear their seat belt at all times, because seat belts help reduce the likelihood of and potential severity of injuries in accidents, including rollovers. The integrated restraint system includes

SRS (driver front air bag, driver side knee bag, front passenger front air bag, side impact air bags, pelvis air bags, window curtain air bags for door windows), Emergency Tensioning Devices (ETDs), seat belt force limiters, and front seat knee bolsters.

The system is designed to enhance the protection offered to properly belted occupants in certain frontal (front air bags, driver's side knee bag, and ETDs) and side (side impact air bags, pelvis air bags, window curtain air bags, and ETDs) impacts which exceed preset deployment thresholds and in certain rollovers (window curtain air bags and ETDs).

- Never wear the shoulder belt under your arm, against your neck or off your shoulder. In a frontal crash, your body would move too far forward. That would increase the chance of head and neck injuries. The seat belt would also apply too much force to the ribs or abdomen, which could severely injure internal organs such as your liver or spleen.

Adjust the seat belt so that the shoulder section is located as close as possible to the middle of the shoulder. It should not touch the neck. Never pass the shoulder portion of the seat belt under your arm. For this purpose, you can adjust the height of the seat belt outlet.

- Position the lap belt as low as possible on your hips and not across the abdomen. If the lap belt is positioned across your abdomen, it could cause serious injuries in a crash.
- Never wear seat belts over rigid or breakable objects in or on your clothing, such as eyeglasses, pens, keys etc., as these might cause injuries.
- Make sure the seat belt is always fitted snugly. Take special care of this when wearing loose clothing.

- Never use a seat belt for more than one person at a time. Do not fasten a seat belt around a person and another person or other objects at the same time.
- Seat belts should not be worn twisted. In a crash, you would not have the full width of the seat belt to distribute impact forces. The twisted seat belt against your body could cause injuries.
- Pregnant women should also always use a lap/shoulder belt. The lap belt portion should be positioned as low as possible on the hips to avoid any possible pressure on the abdomen.
- Place the seat backrest in a position that is as upright as possible.
- Check your seat belt during travel to make sure it is properly positioned.
- Never place your feet on the instrument panel, dashboard, or on the seat. Always keep both feet on the floor in front of the seat.
- When using a seat belt to secure infant restraints, toddler restraints, or children in booster seats, always follow the child seat manufacturer's instructions.

Warning!

Do not pass seat belts over sharp edges. They could tear.

Do not allow the seat belt to get caught in the door or in the seat adjustment mechanism. This could damage the seat belt.

Never attempt to make modifications to seat belts. This could impair the effectiveness of the seat belts.

Fastening the seat belts

Warning!

According to accident statistics, children are safer when properly restrained in the rear seating positions than in the front seating position. Thus, we strongly recommend that

children be placed in the rear seats whenever possible. Regardless of seating position, children 12 years old and under must be seated and properly secured in an appropriately sized infant restraint, toddler restraint, or booster seat recommended for the size and weight of the child. For additional information, see "Children in the vehicle".

A child's risk of serious or fatal injuries is significantly increased if the child restraints are not properly secured in the vehicle and/or the child is not properly secured in the child restraint.

Warning!

Vehicles with BabySmart™ air bag deactivation system, Canada only: Children 12 years old and under must never ride in the front seat, except in a Mercedes-Benz authorized BabySmart™ compatible child seat, which operates with the BabySmart™ system installed in the vehicle to deactivate the front passenger front air bag when it is installed properly. Otherwise they will be struck by the air bag when it inflates in a crash. If this happens, serious or fatal injury will result.

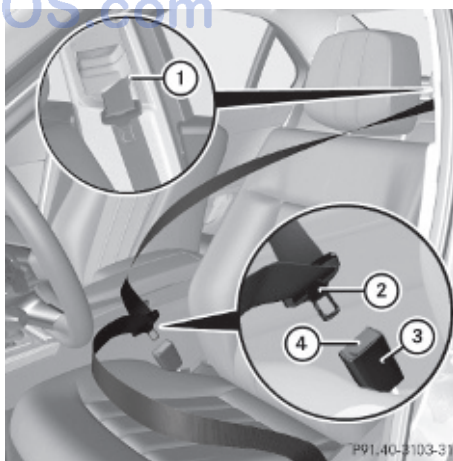

P91_40-3103-31

- ▶ With a smooth motion, pull the seat belt out of seat belt outlet ①.
- ▶ Place the shoulder portion of the seat belt across the top of your shoulder and the lap portion across your hips.
- ▶ Push latch plate ② into buckle ③ until it clicks.
Seat belt adjustment function: The seat belts on both front seats adjust to the upper body automatically as necessary (▷ page 51).
- ▶ If necessary, adjust the seat belt to the correct height (▷ page 51).
- ▶ If necessary, tighten the lap portion to a snug fit by pulling shoulder portion up.

All lap/shoulder belts except the driver's seat belt have special seat belt retractors to secure child restraints properly. For more information on special seat belt retractors, see "Infant and child restraint systems" (▷ page 56).

To release the seat belt with seat belt release button ④, see (▷ page 51).

Seat belt adjustment function

The seat belt adjustment function adjusts the seat belts on both front seats to the upper body of the respective vehicle occupant. The seat belt will be pulled slightly tighter for that purpose when

- you engage the latch plate into the buckle and then turn the SmartKey in the starter switch to position **2**
- the SmartKey in the starter switch is in position **2** and you then engage the latch plate in the buckle

The seat belt adjustment function takes place with a certain amount of retracting force when the system senses slack between the vehicle occupant and the seat belt. Do not retain the seat belt during this procedure. You can activate or deactivate the seat belt adjustment function via the control system (▷ page 145).

Releasing the seat belts

- ▶ Press seat belt release button ④ (▷ page 50).
Allow the retractor to completely rewind the seat belt by guiding latch plate ② (▷ page 50).

! Make sure the seat belt retracts completely. Otherwise the seat belt and/or latch plate could get caught or pinched in the door or in the seat mechanism. This can damage the seat belt and impair its effectiveness, and/or cause damage to the door and/or door trim panel. Such damage is not covered by the Mercedes-Benz Limited Warranty.

Damaged seat belts must be replaced. Contact an authorized Mercedes-Benz Center.

Rear center seat belt

The seat belt of the rear center seat may be blocked when the left rear seat backrest is folded forward and back (▷ page 199). The seat belt can then not be pulled out.

- ▶ **Unblocking the seat belt of the rear center seat:** Pull the center seat belt approximately 1 in (25 mm) out of the seat belt outlet in the seat backrest and release it.
The seat belt is retracted and unblocked.

Seat belt outlet height adjustment

You can adjust the height of the seat belt outlet for the driver's and front passenger seat.

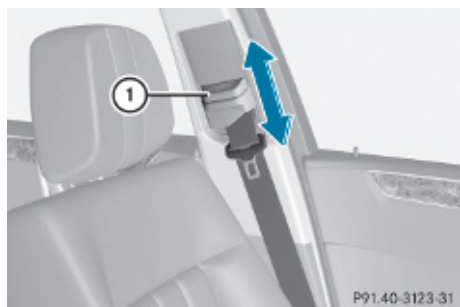



- ▶ **Raising:** Slide the seat belt outlet height adjuster upward. The seat belt outlet height adjuster engages in different positions.
- ▶ **Lowering:** Press and hold release button ①.
- ▶ Slide the seat belt outlet height adjuster downward.
- ▶ Release release button ① and make sure the seat belt outlet height adjuster engages into place.

Enhanced seat belt reminder system

When the engine is started, the seat belt telltale  will always illuminate for 6 seconds to remind you and your passengers to fasten your seat belts.

If the driver's seat belt is not fastened when the engine is started, an additional warning chime will sound. The warning chime goes out after approximately 6 seconds or once the driver's seat belt is fastened.

If after these 6 seconds the driver's or the front passenger's seat belt (with the front passenger seat occupied) is not fastened with front doors closed,

- the seat belt telltale  remains illuminated for as long as either the driver's or front passenger's seat belt is not fastened.
- and if the vehicle speed once exceeds 15 mph (25 km/h), the seat belt telltale  starts flashing and a warning chime

sounds with increasing intensity for a maximum of 60 seconds or until the driver's and front passenger's seat belt are fastened.

If you and/or your passenger release the seat belt during driving, the seat belt telltale  starts flashing and the warning chime sounds as described before.

If the driver's or the front passenger's seat belt remains unfastened after 60 seconds, the warning chime stops sounding, the seat belt telltale  stops flashing but continues to be illuminated.

After a vehicle standstill, the warning chime is reactivated and the seat belt telltale  is flashing again if the vehicle speed once exceeds 15 mph (25 km/h).

The seat belt telltale  will only go out if both the driver's and the front passenger's seat belt (with the front passenger seat occupied) are fastened, or the vehicle is standing still and a front door is opened.

For more information, see "Practical hints" (▷ page 307).
تلفن شما: ۰۲۱-۸۸۶۲۰۵۰۱

Emergency Tensioning Device (ETD), seat belt force limiter

The seat belts for the front seats and rear outer seats are equipped with ETDs and seat belt force limiters.

The ETDs are designed to activate in the following cases:

- in frontal or rear-end impacts exceeding the system's preset deployment threshold
- in side impacts exceeding the system's preset deployment threshold on the far side of the impact
- in certain vehicle rollovers
- if the restraint systems are operational and functioning correctly, see "SRS indicator lamp" (▷ page 36)

The ETDs for the front seats will only activate if the front seat belts are fastened (latch plate properly inserted into buckle).

The ETDs for the rear outer seats will activate with or without the respective seat belts fastened.

In an impact, the ETDs remove slack from the seat belts in such a way that the seat belts fit more snugly against the body. Seat belt force limiters, when activated, are employed to help reduce the peak force exerted by the seat belts on occupants during a crash.

- ❗ The ETDs do not correct an incorrect seat position or incorrectly worn seat belts. The ETDs do not pull occupants back toward the seat backrest.

Warning!

Pyrotechnic ETDs that were activated must be replaced.

For your safety, when disposing of the pyrotechnic ETDs always follow our safety instructions. These are available at any authorized Mercedes-Benz Center.

The PRE-SAFE® system has electrically operated reversible pre-tensioners that do not require replacement after activation.

The PRE-SAFE® system takes preventive measures to better protect the occupants from the possibility of personal injuries in the following hazardous situations:

- emergency braking situations, e.g. if the Brake Assist System (BAS) (▷ page 63) is activated or when vehicles with DISTRONIC PLUS: the BAS PLUS (▷ page 63) or the PRE-SAFE® Brake (▷ page 69) is strongly engaging
- when the radar sensors recognize the immediate risk of collision in certain situations (vehicles with DISTRONIC PLUS)
- critical dynamic driving situations, e.g. when the vehicle has been caused to understeer or oversteer because it has exceeded its physical limitations or in case of evasive steering maneuvers at speeds above approximately 85 mph (140 km/h)

The PRE-SAFE® system takes the following measures when it is activated:

- The front seat belts are pre-tensioned automatically.
- If the front passenger seat is in an unfavorable position, the seat will be adjusted to a position that seeks to better protect the occupant.
- The system increases the air pressure in the air pockets (on the sides of the seat cushion and backrest) of the drive-dynamic multicontour front seats.
- If the vehicle is in a critical dynamic driving situation, the door windows and the tilt/sliding sunroof or panorama roof with tilt/sliding panel also closes, except for a minimal gap that remains open.

If the closing procedure of any of these elements is blocked, it will stop and open slightly.

Once the hazardous situation no longer exists and an accident has been avoided, the PRE-SAFE® system loosens the seat belt pre-

Automatic comfort-fit feature seat belt

An automatic comfort-fit feature for the front seats reduces the retracting force of the seat belts when they are in normal use.

Preventive occupant safety (PRE-SAFE®)

Warning!

The PRE-SAFE® system is intended to reduce the effects of an accident on vehicle occupants who are wearing their seat belt properly. Despite your vehicle being equipped with the PRE-SAFE® system, the possibility of personal injuries occurring as a result of an accident cannot be eliminated. Therefore, always drive carefully and adjust your driving to the prevailing road, weather, and traffic conditions.

tension and decreases the air pressure in the air pockets of the drive-dynamic multicontour front seats. All of the PRE-SAFE® system settings can be re-adjusted following the critical driving event.

If the seat belts do not release:

- ▶ Adjust the seat backrest or seat slightly to the rear until the seat belt tension is reduced.
The locking mechanism releases.

❗ When moving the seats, make sure there are no items in the footwell or behind the seats. Otherwise, you could damage the seats and/or the items.

For information on the seat belt adjustment function as an integrated comfort feature of the PRE-SAFE® system, see (▷ page 51).

NECK-PRO active front head restraints

The NECK-PRO active front head restraints are intended to offer the driver and front passenger increased protection from whiplash-type injuries. In the event of a rear-end collision, the NECK-PRO active front head restraints are designed to move forward and up in the direction of travel. They thus provide the head with increased support earlier on in the collision sequence. The NECK-PRO active front head restraints will move forward and up whether the seats are occupied or not.

Warning!

Do not attach any objects (e.g. hangers) to the head restraint posts. Otherwise, the NECK-PRO active front head restraints may not be able to function properly or offer the intended degree of protection they were designed for in the event of a rear-end collision.

Warning!

Only use seat or head restraint covers which have been tested and approved by Mercedes-Benz for your vehicle model.

Using other seat or head restraint covers may interfere with or prevent the activation of the NECK-PRO active front head restraints and/or the deployment of the front side impact air bags or pelvis air bags.

Contact an authorized Mercedes-Benz Center for availability.

When the NECK-PRO active front head restraints have been triggered in an accident, the NECK-PRO active front head restraints must be reset. Otherwise, the NECK-PRO active front head restraints cannot offer any additional protection in the event of another rear-end collision.

For information on resetting the activated NECK-PRO active front head restraints, see “Resetting activated head restraints” (▷ page 316).

You cannot remove the NECK-PRO active front head restraints.

Warning!

For your protection, drive only with properly positioned head restraints.

Adjust the head restraint so that it is as close to the head as possible and the center of the head restraint supports the back of the head at eye level. This will reduce the potential for injury to the head and neck in the event of an accident or similar situation.

For information on head restraint adjustment, see “Head restraint height” (▷ page 89), or see “Head restraint fore and aft adjustment” (▷ page 89).

Correct driver seat adjustment

Warning!

In order to avoid possible loss of vehicle control the following must be done before the vehicle is put into motion:

- seat adjustment
- head restraint adjustment

- steering wheel adjustment
- rear view mirror adjustment
- fastening of seat belts



Steering wheel

⚠ Observe Safety notes, see page 93.

- ▶ Position steering wheel ① properly (▷ page 93).

Make sure:

- You can reach the steering wheel with your arms slightly bent at the elbows.
- You can move your legs freely.
- All displays (including malfunction and indicator lamps) on the instrument cluster are clearly visible.

Seat belt

⚠ Observe Safety notes, see page 48.

- ▶ Fasten and position your seat belt ② correctly (▷ page 50).

Make sure:

- The seat belt is always fitted snugly.
- Adjust the seat belt so that the shoulder section is located as close as possible to the middle of the shoulder.
- Place the lap portion of the seat belt as low as possible on your hips.

Seat and head restraint

⚠ Observe Safety notes, see page 87.

- ▶ Position seat ③ and head restraint properly. See (▷ page 88) for seat and head restraint adjustment.

Observe the following points:

- Always be in a properly seated position.
- The position should be as far rearward from the front air bag in the steering wheel as possible, while still permitting proper operation of vehicle controls.
- Adjust the seat to a comfortable seating position that still allows you to reach the accelerator/brake pedal safely.
- The seat must be adjusted so that you can correctly fasten and position your seat belt.
- The seat backrest must be in a position that is as nearly upright as possible.
- Adjust the seat cushion so that the front edge of the seat cushion lightly supports your legs.
- Adjust the head restraint so that it is as close to the head as possible and the center of the head restraint supports the back of the head at eye level.
- Never place hands under the seat or near any moving parts while the seat is being adjusted.

Children in the vehicle

Safety notes

If an infant or child is traveling with you in the vehicle:

- ▶ Secure the child using an infant or child restraint appropriate to the age and size of the child.
- ▶ Make sure the infant or child is properly secured at all times while the vehicle is in motion.

Warning!

When leaving the vehicle, always remove the SmartKey from the starter switch. Always take the SmartKey with you and lock the vehicle. Do not leave children unattended in the vehicle, even if they are secured in a child restraint system, or with access to an unlocked vehicle. A child's unsupervised access to a vehicle could result in an accident and/or serious personal injury. The children could

- injure themselves on parts of the vehicle
- be seriously or fatally injured through excessive exposure to extreme heat or cold
- injure themselves or cause an accident with vehicle equipment that can be operated even if the SmartKey is removed from the starter switch or removed from the vehicle, such as seat adjustment, steering wheel adjustment, or the memory function

If children open a door, they could injure other persons or get out of the vehicle and injure themselves or be injured by following traffic.

Do not expose the child restraint system to direct sunlight. The child restraint system's metal parts, for example, could become very hot, and the child could be burned by these parts.

Warning!

Do not carry heavy or hard objects in the passenger compartment or trunk unless they are firmly secured in place.

Unsecured or improperly positioned cargo increases a child's risk of injury in the event of

- strong braking maneuvers
- sudden changes of direction
- an accident

Infant and child restraint systems

Observe Safety notes, see page 56.

We recommend all infants and children be properly restrained at all times while the vehicle is in motion.

Canada only:

Only use a BabySmart™ compatible child restraint for the front passenger seat in this vehicle.

All lap/shoulder belts except the driver's seat belt have special seat belt retractors for secure fastening of child restraints.

To fasten a child restraint, follow the child restraint manufacturer's instructions for mounting.

To activate the special seat belt retractor:

- ▶ Pull the shoulder belt out completely and let it retract.
During seat belt retraction, a ratcheting sound can be heard to indicate that the special seat belt retractor is activated. The seat belt is now locked.
- ▶ Push down on child restraint to take up any slack.

To deactivate the special seat belt retractor:

- ▶ Release the seat belt buckle and let the seat belt retract completely.
The seat belt can then again be used in the usual manner.

To deactivate the special seat belt retractor for the front passenger seat, the front passenger seat must be in the most backward position.

⚠ Warning!

Never release the seat belt buckle while the vehicle is in motion, since the special seat belt retractor will be deactivated.

- i** Information on child seats with mounting fittings for tether anchorages (▷ page 58).

For information on LATCH-type (ISOFIX) child seat anchors (▷ page 59).

The use of infant or child restraints is required by law in all 50 states, the District of Columbia, the U.S. territories and all Canadian provinces.

Infants and small children should be seated in an appropriate infant or child restraint system. They must be properly secured in accordance with the manufacturer's instructions for the child restraint. All infant or child restraint systems must comply with U.S. Federal Motor Vehicle Safety Standards 213 and 225 and Canadian Motor Vehicle Safety Standards 213 and 210.2.

A statement by the child restraint manufacturer of compliance with these standards can be found on the instruction label on the restraint and in the instruction manual provided with the restraint.

When using any infant restraint, toddler restraint, or booster seat, make sure to carefully read and follow all manufacturer's instructions for installation and use.

Please read and observe warning labels affixed to the inside of the vehicle and to infant or child restraints.

⚠ Warning!

According to accident statistics, children are safer when properly restrained in the rear seating positions than in the front seating position. Thus, we strongly recommend that children be placed in the rear seats whenever possible. Regardless of seating position, children 12 years old and under must be seated and properly secured in an appropriate

infant restraint, toddler restraint, or booster seat recommended for the size and weight of the child.

The infant or child restraint must be properly secured with the vehicle's seat belt, the seat belt and top tether strap, or lower anchors and top tether strap, fully in accordance with the child seat manufacturer's instructions.

Occupants, especially children, should always sit as upright as possible, wear the seat belt properly and use an appropriately sized infant restraint, toddler restraint, or booster seat recommended for the size and weight of the child.

Children can be killed or seriously injured by an inflating air bag. Note the following important information when circumstances require you to place a child in the front passenger seat:





- USA only: Your vehicle is equipped with air bag technology designed to deactivate the front passenger front air bag in your vehicle when the system senses the weight of a typical 12-month-old child or less along with the weight of a standard appropriate child restraint on the front passenger seat.

- USA only: For children larger than the typical 12-month-old child, the front passenger front air bag may or may not be activated. Always make sure the



- indicator lamp is illuminated, indicating that the front passenger front air bag is deactivated.

- Canada only: Children 12 years old and under must never ride in the front seat, except in a Mercedes-Benz authorized BabySmart™ compatible child seat, which operates with the BabySmart™ system installed in the vehicle to deactivate the front passenger front air bag when it is installed properly. Otherwise they will be struck by the air bag when it inflates in a crash. If this happens, serious or fatal injury will result.

- A child in a rear-facing child restraint on the front passenger seat will be seriously injured or even killed if the front passenger front air bag inflates in a collision which could occur under some circumstances, even with the air bag technology installed in your vehicle. The only means to completely eliminate this risk is to never place a child in a rear-facing child restraint in the front seat. We therefore strongly recommend that you always place a child in a rear-facing child restraint in a backseat.
- If you must install a rear-facing child restraint on the front passenger seat because circumstances require you to do so, make sure the  indicator lamp is illuminated, indicating that the front passenger front air bag is deactivated. Should the  indicator lamp not illuminate or go out while the restraint is installed, please check installation. Periodically check the  indicator lamp while driving to make sure the  indicator lamp is illuminated. If the  indicator lamp goes out or remains out, do not transport a child on the front passenger seat until the system has been repaired.
A child in a rear-facing child restraint on the front passenger seat will be seriously injured or even killed if the front passenger front air bag inflates.
- If you have to place a child in a forward-facing child restraint on the front passenger seat, move the seat as far back as possible, use the proper child restraint recommended for the age, size and weight of the child, and secure child restraint with the vehicle's seat belt according to the child seat manufacturer's instructions.

Warning!

Infants and small children should never share a seat belt with another occupant. During an accident, they could be crushed between the occupant and seat belt.

A child's risk of serious or fatal injuries is significantly increased if the child restraints are not properly secured in the vehicle and/or the child is not properly secured in the child restraint.

Children too big for a toddler restraint must ride in seats using regular seat belts. Position shoulder belt across chest and shoulder, not face or neck. A booster seat may be necessary to achieve proper seat belt positioning for children over 41 lb (18 kg) until they reach a height where a lap/shoulder belt fits properly without a booster.

When the child restraint is not in use, remove it from the vehicle or secure it with the seat belt to prevent the child restraint from becoming a projectile in the event of an accident.

Installation of infant and child restraint systems

 **Observe Safety notes, see page 56.**

Warning! تلفن هشدار

Always lock the seat backrests in their upright position when the rear seats are occupied by passengers. Lock the seat backrests in their upright position before installing top tether straps or when the extended cargo compartment is not in use. Make sure that seat backrests are secured properly by pushing and pulling on the seat backrests. If a seat backrest is not locked properly, the seat backrest could fold. The child seat would no longer be supported properly or positioned to provide its intended benefit. That could cause serious or even fatal injuries.

This vehicle is equipped with tether anchorages for a top tether strap at each of the rear seating positions.

Top tether straps enable an additional connection to be made between child restraint systems secured with LATCH-type (ISOFIX) anchors and rear seats. This can further reduce the risk of injury.

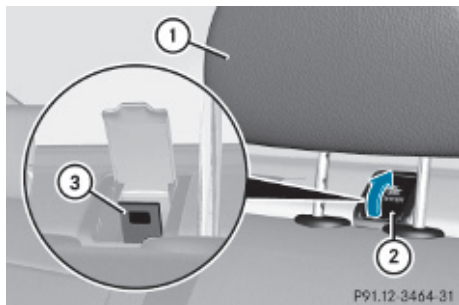

- ▶ Move the respective head restraint ① to its uppermost position (▷ page 90).
- ▶ Lift up anchorage ring cover ② from anchorage ring ③.

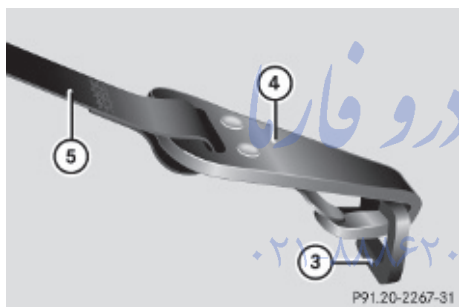

- ▶ Guide top tether strap ⑤ between head restraint ① and top of the seat backrest.
- ▶ Securely fasten hook ④, which is part of top tether strap ⑤, to anchorage ring ③.

Make sure

- hook ④ is attached to anchorage ring ③ beyond the safety catch, as illustrated
- top tether strap ⑤ is not twisted
- head restraint ① is installed (if removable) and positioned such that top tether strap ⑤ can pass freely between head restraint ① and top of the seat backrest
- ▶ Lower head restraint ① if necessary (▷ page 90).

Once hook ④ is attached, the child restraint itself can be secured.

- ▶ Install the child restraint system and tighten top tether strap ⑤ according to the child restraint manufacturer's instructions.

After removing the child restraint system and top tether strap ⑤:

- ▶ Pull down and close anchorage ring cover ② from respective anchorage ring ③.

Child seat anchors – LATCH-type (ISOFIX)

 **Observe Safety notes, see page 56.**

Warning!

Children too big for a toddler restraint must ride in seats using regular seat belts. Position shoulder belt across chest and shoulder, not face or neck.

A booster seat may be necessary to achieve proper seat belt positioning for children over 41 lb (18 kg) until they reach a height where a lap/shoulder belt fits properly without a booster.

Install child seat according to manufacturer's instructions.

The child seat must be firmly attached to both anchors.

An incorrectly mounted child seat may come loose during an accident which could result in serious injury or death to the child.

Damaged or impact damaged child seats or child seat mounting fittings must be replaced.

Each rear outer seat has two LATCH-type (ISOFIX) anchors for the installation of a LATCH-type (ISOFIX) child seat with matching mounting fittings.

Non-LATCH-type (ISOFIX) child seats may also be used and can be installed using the vehicle's seat belt system. Install child seat according to the manufacturer's instructions.

The LATCH-type (ISOFIX) anchors are blended with covers.



Information sign ① on the cover indicates the position of anchor ②.

- ▶ Install a LATCH-type (ISOFIX) child seat according to the manufacturer's instructions. The anchorage ring covers of anchors ② swings back with insert the mounting fittings of a LATCH-type (ISOFIX) child seat. A rigid connection between the child seat and the body of the vehicle is established.
- ▶ Make sure that the seat belt for the rear center seat can operate freely with a child seat installed.

Child safety

Child safety locks

⚠ Observe Safety notes, see page 56.

⚠ Warning!

Children could open a rear door from the inside. This may cause serious personal injury or an accident. Therefore, secure the rear doors with the child safety locks whenever children are riding in the back seats of the vehicle.

The child safety locks on the rear doors enable you to secure each rear door individually. You cannot open a secured rear door from the inside. You can open the rear door from the outside when the vehicle is unlocked.

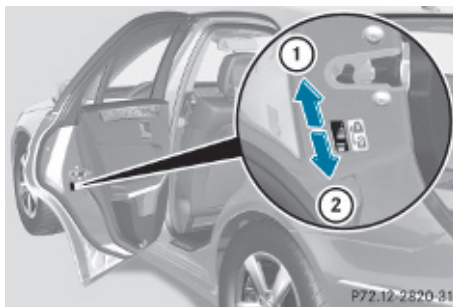

- ▶ **Securing:** Press the lever up in direction of arrow ①.
- ▶ Check to make sure the child safety locks are working properly.
- ▶ **Releasing:** Press the lever down in direction of arrow ②.

Override switch

⚠ Observe Safety notes, see page 56.

With the override switch you can disable the rear door window switches in the rear door panels. This can be useful, for instance, when you have children riding in the rear passenger compartment.

⚠ Warning!

Activate the override switch when children are riding in the back seats of the vehicle. The children may otherwise injure themselves, e.g. by becoming trapped in the rear door window opening.

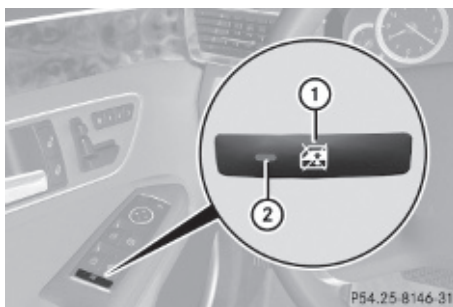

- ▶ **Activating:** Press override switch ①. Indicator lamp ② comes on.

The rear door windows can no longer be operated using the respective switch located in the rear doors.

You can still operate the rear door windows using the switches located on the door control panel of the driver's door.

- ▶ **Deactivating:** Press override switch ① again.
Indicator lamp ② goes out.

The rear door windows can be operated again using the respective switch located in the rear doors.

For more information on power windows, see the "Controls in detail" section (▷ page 105).

Panic alarm



- ▶ **Activating:** Press and hold **PANIC** button ① for at least 1 second.
An audible alarm and flashing exterior lamps will operate.
- ▶ **Deactivating:** Press **PANIC** button ① again.
or
- ▶ Insert the SmartKey into the starter switch.
or
- ▶ Press the KEYLESS-GO start/stop button.
The SmartKey with KEYLESS-GO must be inside the vehicle.

i USA only:

This device complies with Part 15 of the FCC Rules. Operation is subject to the following two conditions:

1. This device may not cause harmful interference, and
2. this device must accept any interference received, including interference that may cause undesired operation.

Any unauthorized modification to this device could void the user's authority to operate the equipment.

i Canada only:

This device complies with RSS-210 of Industry Canada. Operation is subject to the following two conditions:

1. This device may not cause interference, and
2. this device must accept any interference received, including interference that may cause undesired operation of the device.

Any unauthorized modification to this device could void the user's authority to operate the equipment.

Driving safety systems

Introduction

This section contains information about the following driving safety systems:

- ABS (Antilock Brake System)
- Adaptive Brake
- BAS (Brake Assist System)
- BAS PLUS (Brake Assist System PLUS)
- EBP (Electronic Brake Proportioning)
- ESC (Electronic Stability Control)
- PRE-SAFE® Brake (Preventive Occupant Safety System Brake)

i In winter operation, the maximum effectiveness of most of the driving systems described in this section is only achieved with winter tires, or snow chains as required.

Safety notes

Warning!

The following factors increase the risk of accidents:

- Excessive speed, especially in turns
- Wet and slippery road surfaces
- Following another vehicle too closely

The driving safety systems described in this section cannot reduce these risks or prevent the natural laws of physics from acting on the vehicle. They cannot increase braking or steering efficiency beyond that afforded by the condition of the vehicle brakes and tires or the traction afforded.

Only a safe, attentive, and skillful driver can prevent accidents.

The capabilities of a vehicle equipped with the driving safety systems described in this section must never be exploited in a reckless or dangerous manner which could jeopardize the user's safety or the safety of others.

Always adjust your driving style to the prevailing road and weather conditions and keep a safe distance to other road users and objects on the street.

If a driving system malfunctions, other driving safety systems may also switch off. Observe indicator and warning lamps that may come on as well as messages in the multifunction display that may appear.

ABS

 **Observe Safety notes, see page 62.**

Warning!

Do not pump the brake pedal. Use firm, steady brake pedal pressure instead. Pumping the brake pedal defeats the purpose of the ABS and significantly reduces braking effectiveness.

The Antilock Brake System (ABS) regulates the brake pressure so that the wheels do not lock during braking. This allows you to maintain the ability to steer your vehicle.

The ABS is functional above a speed of approximately 5 mph (8 km/h) independent of road surface conditions.

On slippery road surfaces, the ABS will respond even to light brake pressure.

The ABS indicator lamp  in the instrument cluster comes on when you switch on the ignition. It goes out when the engine is running.

Braking

At the instant one of the wheels is about to lock up, a slight pulsation can be felt in the brake pedal. The pulsation indicates that the ABS is in the regulating mode.

- ▶ Keep firm and steady pressure on the brake pedal while you feel the pulsation.

Continuous, steady brake pedal pressure yields the advantages provided by the ABS, namely braking power and the ability to steer the vehicle.

The pulsating brake pedal can be an indication of hazardous road conditions and functions as a reminder to take extra care while driving.

Emergency brake maneuver

- ▶ Keep continuous full pressure on the brake pedal.

⚠ Warning!

If the ABS malfunctions, other driving safety systems such as the BAS or the ESC are also switched off. Observe indicator and warning lamps that may come on as well as messages in the multifunction display that may appear. If the ABS malfunctions, the wheels may lock during hard braking, reducing steering capability and extending the braking distance.

BAS**⚠ Observe Safety notes, see page 62.**

The Brake Assist System (BAS) operates in emergency situations. If you apply the brakes very quickly, the BAS provides full brake boost automatically, thereby potentially reducing the braking distance.

- ▶ Apply continuous full braking pressure until the emergency braking situation is over. The ABS will prevent the wheels from locking.

When you release the brake pedal, the brakes function again as normal. The BAS is then deactivated.

⚠ Warning!

If the BAS malfunctions, the brake system still functions, but without the additional brake boost available that the BAS would normally provide in an emergency braking maneuver. Therefore, the braking distance may increase.

BAS PLUS

The Brake Assist System PLUS (BAS PLUS) operates in emergency braking situations and uses radar sensors to assess the traffic situation. BAS PLUS assists you in braking at speeds above approximately 20 mph (30 km/h).

When traveling in Canada in a vehicle not registered in Canada, you must switch off the radar sensor system (▷ page 144). Canadian law does not permit the use of the radar

sensor system for vehicles from outside of Canada.

When you switch off the radar system, the following functions are deactivated:

- BAS PLUS
- PRE-SAFE® Brake (▷ page 69)
- DISTRONIC PLUS (▷ page 149)

⚠ Warning!

BAS PLUS is a convenience system designed to assist the driver during vehicle operation. The responsibility for the vehicle speed and the distance to the vehicle ahead, including most importantly brake operation to assure safe stopping distance, always remains with the driver.

Always pay attention to traffic conditions even while BAS PLUS is switched on.

Otherwise, you may not be able to recognize dangerous situations until it is too late and could cause an accident. Personal or fatal injury to you or others may be the result.

- ⓘ This device has been approved by the FCC as a “Vehicular Radar System”. The radar sensor is intended for use in an automotive radar system only. Removal, tampering, or altering of the device will void any warranties, and is not permitted by the FCC. Do not tamper with, alter, or use in any non-approved way.

Any unauthorized modification to this device could void the user’s authority to operate the equipment.

BAS PLUS detects obstacles that are in your driving path for a sufficient period of time to permit the system to recognize these obstacles. If you approach the detected obstacle quickly, BAS PLUS calculates the level of brake power boost appropriate for the circumstance to supply when the driver applies the brakes.

When you step quickly on the brake pedal in an emergency braking situation, BAS PLUS automatically regulates the brake power

boost to a level that is suitable for the traffic situation.

If BAS PLUS requires a particularly high brake power boost, PRE-SAFE® is activated at the same time.

- ▶ Keep constant pressure on the brake pedal until the emergency braking situation is over. During this process, the ABS prevents the wheels from locking up.

The brakes will resume normal operation after

- the brake pedal is released
- no obstacles are detected in your path
- the system no longer senses a risk of a collision

BAS PLUS is then deactivated.

BAS PLUS can react to stationary obstacles such as standing or parked vehicles at road speeds of up to approximately 40 mph (70 km/h).

BAS PLUS can only assist you when the radar sensors are switched on and functional. You can check whether the sensors are active by switching on DISTRONIC PLUS (▷ page 149) or using the Radar sensors function in the instrument cluster control system.

Warning!

BAS PLUS will only respond with brake assistance if it has clearly detected an object. Detection can be impeded by

- dirty or covered sensors
- snowfall or heavy rain
- disturbance from other radar sources
- strong radar reflection such as in parking garages

BAS PLUS uses radar signals that are not reflected well by narrow objects and absorptive materials. For this reason BAS PLUS will not react to persons, animals, and approaching traffic or cross-traffic.

BAS PLUS may not detect narrow vehicles driving in front of you, such as motorcycles and vehicles driving offset from your vehicle center.

After a hard collision or damage to the front of the vehicle from an accident, have the adjustment and operation of the radar sensors checked by an authorized Mercedes-Benz Center.

If BAS PLUS is not available due to a radar sensor malfunction, the braking system will continue to function normally with full brake boost and full standard BAS function.

Adaptive Brake

Adaptive Brake provides a high level of braking safety as well as increased braking comfort. Adaptive Brake takes driver and vehicle characteristics into consideration, thus achieving an optimal braking effect.

In addition, Adaptive Brake provides the HOLD function (▷ page 161) and the hill-start assist system (▷ page 160).

For more information on the brake system, see (▷ page 254).

EBP

Observe Safety notes, see page 62.

The Electronic Brake Proportioning (EBP) enhances braking effectiveness by allowing the rear brakes to supply a greater proportion of the braking effort in straight-line braking without a loss of vehicle stability.

Warning!

If the EBP malfunctions, the brake system will still function with full brake boost. However, the rear wheels could lock up during emergency braking situations, for example. You could lose control of the vehicle and cause an accident.

Adapt your driving style to the changed driving characteristics.

ESC

Observe Safety notes, see page 62.

The Electronic Stability Control (ESC) is operational as soon as the engine is running. It monitors the vehicle's traction (force of adhesive friction between the tires and the road surface) and handling.

The ESC recognizes that the vehicle deviates from the direction of travel as intended by the driver. By applying brakes to individual wheels and by limiting the engine output, the ESC works to stabilize the vehicle. The ESC is especially useful while driving off and on wet or slippery road surfaces. The ESC also stabilizes the vehicle during braking and steering maneuvers.

The ESC warning lamp  in the instrument cluster comes on when you switch on the ignition. It goes out when the engine is running.

Warning!

Never switch off the ESC when you see the ESC warning lamp  flashing in the instrument cluster. In this case proceed as follows:

- When driving off, apply as little throttle as possible.
- While driving, ease up on the accelerator pedal.
- Adapt your speed and driving style to the prevailing road conditions.

Failure to observe these guidelines could cause the vehicle to skid. The ESC cannot prevent accidents resulting from excessive speed.

! Vehicles with 4MATIC: Because the ESC operates automatically, the engine and ignition must be shut off (SmartKey in starter switch position **0** or **1** or KEYLESS-GO start/stop button in position **0** or **1**) when the parking brake is being tested on a brake test dynamometer.

Active braking action through the ESC may otherwise seriously damage the brake system which is not covered by the Mercedes-Benz Limited Warranty.

! Vehicles without 4MATIC: Because the ESC operates automatically, the engine and ignition must be shut off (SmartKey in starter switch position **0** or **1** or KEYLESS-GO start/stop button in position **0** or **1**) when the parking brake is being tested on a brake test dynamometer or when the vehicle is being towed with one axle raised. Active braking action through the ESC may otherwise seriously damage the brake system which is not covered by the Mercedes-Benz Limited Warranty.

! The ESC will only function properly if you use wheels of the recommended tire size as specified in the "Technical data" section of this Operator's Manual.

i The DISTRONIC PLUS and cruise control switch off automatically when the ESC engages.

Electronic Traction System (ETS/4-ETS)

Observe Safety notes, see page 62.

The ETS (Electronic Traction System) and 4-ETS (four-wheel Electronic Traction System, vehicles with 4MATIC only) are components of the ESC. The ETS/4-ETS improves the vehicle's ability to utilize available traction, especially under slippery road conditions by applying the brakes to a spinning wheel. Vehicles with 4MATIC also transfer more power to the wheel(s) with traction.

When you switch off the ESC, the ETS/4-ETS is still enabled.

Switching the ESC off or on (except E 63 AMG)

Warning!

The ESC should not be switched off during normal driving other than in the circumstances described below. Disabling the system will reduce vehicle stability in driving maneuvers.

Do not switch off the ESC when a spare wheel is mounted.

To improve the vehicle's traction, switch off the ESC. This allows the drive wheels to spin and thus cut into surfaces for better grip, for example

- when driving with snow chains
- in deep snow
- in sand or gravel

Warning!

Switch on the ESC immediately if the aforementioned circumstances do not apply anymore. Otherwise the ESC will not stabilize the vehicle when it is starting to skid or a wheel is spinning.

When you switch off the ESC,

- the ESC does not stabilize the vehicle
- the engine output is not limited, which allows the drive wheels to spin and thus cut into surfaces for better grip
- the ETS/4-ETS will still apply the brakes to a spinning wheel
- the ESC continues to operate when you are braking
- the cruise control or the DISTRONIC PLUS cannot be activated
- the cruise control or the DISTRONIC PLUS switch off if activated

- i** When the ESC is switched off and one or more drive wheels are spinning, the ESC warning lamp  in the instrument

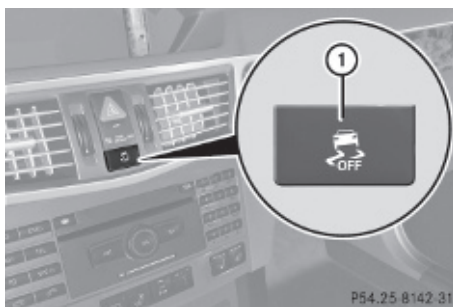

cluster flashes. However, the ESC will then not stabilize the vehicle.



- **Switching off:** With the engine running, press ESC switch **1** until the ESC OFF warning lamp  in the instrument cluster comes on. The ESC is switched off.

Warning!

When the ESC OFF warning lamp  is on, the ESC is switched off.

When the ESC warning lamp  and the ESC OFF warning lamp  are on continuously, the ESC is not operational due to a malfunction.

When the ESC is switched off or not operational, vehicle stability in standard driving maneuvers is reduced.

Adapt your speed and driving to the prevailing road conditions and to the non-operating status of the ESC.

- !** Avoid spinning of a drive wheel for an extended period with the ESC switched off. This may cause serious damage to the drivetrain which is not covered by the Mercedes-Benz Limited Warranty.
- **Switching on:** Press ESC switch **1** until the ESC OFF warning lamp  in the instrument cluster goes out. You are now again in normal driving mode with the ESC switched on.

E 63 AMG

Switching ESC SPORT on or off

⚠ Warning!

ESC SPORT should not be switched on during normal driving.

Switching ESC SPORT on will result in the following:

- no restriction to engine torque
- system-supported traction control is limited

ESC SPORT is designed for driving on closed tracks when the vehicle's natural oversteer and understeer characteristics are desired and requires a highly skilled and experienced driver able to handle these critical driving situations.

You could lose control of your vehicle and cause an accident.

Please be aware of these limits when you switch on ESC SPORT.

Do not switch on ESC SPORT when a spare wheel is mounted.

To improve the vehicle's traction, switch on ESC SPORT. This allows the drive wheels to spin and thus cut into surfaces for better grip, for example

- when driving with snow chains
- in deep snow
- in sand or gravel

⚠ Warning!

Switch off ESC SPORT and switch on the ESC immediately if the aforementioned circumstances do not apply anymore.

Otherwise ESC will only stabilize the vehicle to a limited extent when it is starting to skid or a wheel is spinning.

When you switch on ESC SPORT

- the ESC stabilizes the vehicle only to a limited extent
- the engine output is limited, but only to the extent that allows the drive wheels to spin and thus cut into surfaces for better grip
- the ETS will still apply the brakes to a spinning wheel
- the ESC continues to operate when you are braking hard
- the cruise control or the DISTRONIC PLUS cannot be activated
- the cruise control or the DISTRONIC PLUS switch off if activated

i When ESC SPORT is switched on and one or more drive wheels are spinning, the ESC warning lamp  in the instrument cluster flashes. However, the ESC will then stabilize the vehicle only to a limited extent.



► **Switching on:** With the engine running, press ESC SPORT switch ① briefly. The ESC SPORT warning lamp  in the instrument cluster comes on. The message ESC-SPORT appears in the multifunction display.

► **Switching off:** With the engine running, press ESC SPORT switch ① briefly. The ESC SPORT warning lamp  in the instrument cluster goes out. The message ESC-ON appears in the multifunction display.

ESC SPORT switches off automatically when you turn off the engine. When starting the engine, the ESC is activated automatically.

Switching the ESC off or on

Warning!

The ESC should not be switched off during normal driving.

Disabling of the system will result in the following:

- no restriction to engine torque
- loss of system-supported traction control

“ESC OFF” is designed for driving on closed tracks when the vehicle’s natural oversteer and understeer characteristics are desired and requires a highly skilled and experienced driver able to handle these critical driving situations.

You could lose control of your vehicle and cause an accident.

Please be aware of these limits when you switch off the ESC.

Do not switch off the ESC when a spare wheel is mounted.

To improve the vehicle’s traction, switch off the ESC. This allows the drive wheels to spin and thus cut into surfaces for better grip, for example



- when driving with snow chains
- in deep snow
- in sand or gravel

Warning!



Switch on the ESC immediately if the aforementioned circumstances do not apply anymore. Otherwise the ESC will not stabilize the vehicle when it is starting to skid or a wheel is spinning.

When you switch off the ESC,

- the ESC will not stabilize the vehicle
- the engine output is not limited, which allows the drive wheels to spin and thus cut into surfaces for better grip
- the ETS will still apply the brakes to a spinning wheel
- the ESC continues to operate when you are braking hard
- the PRE-SAFE® system is not available, even when you are braking hard supported by the ESC
- the PRE-SAFE® Brake is not available, even when you are braking hard supported by the ESC
- the cruise control or the DISTRONIC PLUS cannot be activated
- the cruise control or the DISTRONIC PLUS switch off if activated



 When ESC is switched off and one or more drive wheels are spinning, the ESC warning lamp  in the instrument cluster does not flash. The ESC will not stabilize the vehicle.



► **Switching off:** With the engine running, press ESC switch  until the ESC OFF warning lamp  in the instrument cluster comes on. The message ESC-OFF appears in the multifunction display.

Warning!

When the ESC OFF warning lamp  is on, the ESC is switched off.

When the ESC warning lamp  and the ESC OFF warning lamp  are on continuously, the ESC is not operational due to a malfunction.

When the ESC is switched off or not operational, vehicle stability in standard driving maneuvers is reduced.

Adapt your speed and driving to the prevailing road conditions and to the non-operating status of the ESC.

! Avoid spinning of a drive wheel for an extended period with the ESC switched off. This may cause serious damage to the drivetrain which is not covered by the Mercedes-Benz Limited Warranty.

► **Switching on:** With the engine running, press ESC switch  briefly.

The ESC OFF warning lamp  in the instrument cluster goes out. The message ESC-ON appears in the multifunction display.

PRE-SAFE® Brake

The PRE-SAFE® Brake is available in vehicles equipped with DISTRONIC PLUS. The PRE-SAFE® Brake can assist you in minimizing the risk of a rear-end collision with a vehicle in front of you. The PRE-SAFE® Brake may also reduce the severity of an accident. At speeds above approximately 20 mph (30 km/h) it will issue a warning when your vehicle is approaching the preceding vehicle very quickly. An intermittent acoustic warning sounds and the distance warning lamp  in the instrument cluster comes on.

Due to the system characteristics, warnings could be issued without cause in complex driving situations.

When the driver and front passenger have fastened their seat belts, the PRE-SAFE® Brake can also

- brake the vehicle within a speed range of up to 124 mph (200 km/h) automatically
- activate preventative occupant safety measures (PRE-SAFE®) (▷ page 53)

Warning!

An intermittent warning sounds and the distance warning lamp  in the instrument cluster is illuminated if the PRE-SAFE® Brake calculates that the distance to the vehicle ahead and your vehicle's current speed indicate that the PRE-SAFE® Brake will not be capable of slowing the vehicle sufficiently to maintain the preset following distance, which creates a danger of a collision.

Immediately brake your vehicle to increase the distance between your vehicle and the vehicle driving in front of you. The warning sound is intended as a final caution that you have not interceded with your own braking inputs to avoid a potentially dangerous situation. Do not wait for the operation of the warning signal to intercede with your own braking, as that will result in potentially dangerous emergency braking which will not always result in an impact being avoided.

Tailgating increases the risk of an accident.

Warning!

The PRE-SAFE® Brake is a convenience system designed to assist the driver during vehicle operation. The responsibility for the vehicle speed and the distance to the vehicle ahead, including most importantly brake operation to assure safe stopping distance, always remains with the driver.

Always pay attention to traffic conditions even while the PRE-SAFE® Brake is switched on. Otherwise, you may not be able to recognize dangerous situations until it is too late and could cause an accident resulting in personal or fatal injury to you or others.

i USA only:

This device has been approved by the FCC as a “Vehicular Radar System”. The radar sensor is intended for use in an automotive radar system only. Removal, tampering, or altering of the device will void any warranties, and is not permitted by the FCC. Do not tamper with, alter, or use in any non-approved way.

Any unauthorized modification to this device could void the user’s authority to operate the equipment.

i Canada only:

This device complies with RSS-210 of Industry Canada. Operation is subject to the following two conditions:

1. This device may not cause interference, and
2. this device must accept any interference received, including interference that may cause undesired operation of the device.

Removal, tampering, or altering of the device will void any warranties, and is not permitted. Do not tamper with, alter, or use in any non-approved way.

Any unauthorized modification to this device could void the user’s authority to operate the equipment.

Using the radar sensors, the PRE-SAFE® Brake detects obstacles that are in your driving path for a sufficient period of time for the system to recognize it. If you approach a vehicle and the PRE-SAFE® Brake has established that the distance to the vehicle ahead at your current speed is so close that the PRE-SAFE® Brake will not be capable of slowing the vehicle sufficiently, the system will initially warn you visually and acoustically. If you do not apply the brakes yourself or maneuver around a sensed obstacle, the vehicle will brake lightly automatically. The PRE-SAFE® system (> page 53) is activated when the distance to the vehicle ahead at

your current speed is so close that the PRE-SAFE® Brake will not be capable of slowing the vehicle sufficiently.

When the danger of a collision still persists and you do not brake or accelerate significantly, the PRE-SAFE® Brake may initiate full application of the brakes automatically.

⚠ Warning!

The PRE-SAFE® Brake will only respond with brake assistance if it has clearly detected an object. Detection can be impeded by

- dirty or covered sensors
- snowfall or heavy rain
- disturbance from other radar sources
- strong radar reflection such as in parking garages

The PRE-SAFE® Brake uses radar signals that are not reflected well by narrow objects and absorptive materials. For this reason the PRE-SAFE® Brake will not react to persons, animals, and approaching traffic or cross-traffic.

The PRE-SAFE® Brake may not detect narrow vehicles driving in front of you, such as motorcycles and vehicles driving offset from your vehicle center.

⚠ Warning!

Depending on the vehicle speed, the PRE-SAFE® Brake brakes your vehicle with a maximum of 13 ft/s² (4 m/s²) before a possible hard stop. This corresponds to about 40% of the maximum deceleration ability of your vehicle. The driver must apply the brakes additionally in order to prevent a collision. The self-acting hard stop will be initiated when the imminent danger of a collision exists, e.g. when an evasive driving maneuver cannot avoid an accident.

To maintain the proper distance to the vehicle in front of you and thus prevent a rear-end collision, you must apply the brakes yourself.

- ▶ Brake the vehicle immediately to avoid a collision.

Under no circumstances should the driver await the intermittent warning sound before braking. Observe the following warning note.

The intermittent warning sound ceases and the distance warning lamp  goes out when the necessary distance to the vehicle ahead is again established.

The PRE-SAFE® Brake can react to stationary obstacles such as standing or parked vehicles at road speeds of up to approximately 40 mph (70 km/h).

Warning!

If you do not receive visual or acoustic warning signals, the PRE-SAFE® Brake may

- not have recognized the collision risk
- have been deactivated
- be malfunctioning

Apply the brakes yourself to avoid a collision.

The PRE-SAFE® Brake does not always clearly interpret complex traffic situations. If a visual and/or acoustic warning is issued in an uncritical driving situation, or if the vehicle brakes lightly, you can interrupt the PRE-SAFE® Brake maneuver by pressing down all the way on the accelerator pedal, using kickdown, or releasing the brake pedal.



The PRE-SAFE® Brake maneuver is terminated immediately when

- you avoid the obstacle by evasive steering
- you drive less than 9 mph (15 km/h)
- an obstacle can no longer be identified ahead of you
- the system no longer senses the risk of a collision

- ❗ The PRE-SAFE® Brake will remain passive while DISTRONIC PLUS is switched on (▷ page 149).

After a hard collision or damage to the front of the vehicle from an accident, have the settings and operation of the radar sensors checked by an authorized Mercedes-Benz Center.

- ▶ **Activating and deactivating:** Activate or deactivate the PRE-SAFE® Brake using the instrument cluster control system (▷ page 137).

After the function has been activated, the PRE-SAFE® Brake indicator  appears in the instrument cluster. When the HOLD function is switched on, the PRE-SAFE® Brake indicator  will not appear.

In vehicles with Parking Guidance, the automatic transmission must be in park position **P** for the PRE-SAFE® Brake indicator  to be displayed.

The PRE-SAFE® Brake is deactivated when the radar system is switched off. When you switch off the radar system, the following functions are deactivated:

- PRE-SAFE® Brake
- BAS PLUS (▷ page 63)
- DISTRONIC PLUS (▷ page 149)
- Blind Spot Assist (▷ page 175)

Anti-theft systems

Immobilizer

The immobilizer prevents unauthorized persons from starting your vehicle.

When leaving the vehicle, always take the SmartKey with you and lock the vehicle. The engine can be started by anyone with a valid SmartKey that is left inside the vehicle.

Activating

- ▶ **With SmartKey:** Remove the SmartKey from the starter switch.
- ▶ **With KEYLESS-GO:** Turn off the engine and open the driver's door.

Deactivating

- ▶ Switch on the ignition.
- i** Starting the engine will also deactivate the immobilizer.

In the event that the engine cannot be started (yet the vehicle's battery is charged), the system is not operational. Contact an authorized Mercedes-Benz Center or call 1-800-FOR-MERCEDES (in the USA) or 1-800-387-0100 (in Canada).

Anti-theft alarm system

Once the alarm system has been armed, a visual and audible alarm is triggered when someone opens

- a door
- the trunk
- the hood

The alarm will stay on even if the activating element, a door, for example, is closed immediately.

The alarm system will also be triggered when

- the vehicle is opened with the mechanical key
- a door is opened from the inside
- the trunk is opened with the emergency release button

To cancel the alarm after it has been triggered, see "Canceling the alarm" (▷ page 73).

i If the alarm stays on for more than 30 seconds, the Tele Aid system initiates a call to the Customer Assistance Center automatically. The Tele Aid system will initiate the call provided that

- you have subscribed to the Tele Aid service
- the Tele Aid service has been activated properly
- the necessary mobile phone, power supply and GPS coverage are available

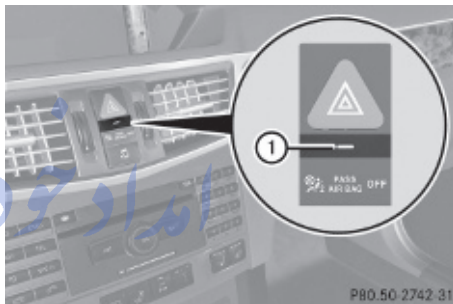

▶ **Arming:** Lock the vehicle with the SmartKey or with KEYLESS-GO. The turn signal lamps flash three times and an acoustic warning sounds three times to indicate that the vehicle is locked. Indicator lamp ① flashes to indicate that the alarm system is armed.

i If the turn signal lamps do not flash three times and the acoustic warning does not sound three times, a door or the trunk may not be properly closed.



Close the respective element.

▶ **Disarming:** Unlock the vehicle with the SmartKey or with KEYLESS-GO. The turn signal lamps flash once and an acoustic warning sounds once to indicate that the alarm system is disarmed.

- i** Unless you open a door or the trunk within approximately 40 seconds after unlocking the vehicle:
- The vehicle will be locked again.
 - The anti-theft alarm system will be rearmed.

Canceling the alarm

To cancel the alarm, do one of the following:

- ▶ Insert the SmartKey into the starter switch.
- ▶ Press button  or  on the SmartKey.

In vehicles with KEYLESS-GO:

- ▶ Grasp an outside door handle.
The SmartKey must be within 3 ft (1 m) of the vehicle.
- ▶ Press the KEYLESS-GO start/stop button.
The SmartKey must be inside the vehicle.

تلفن شبانه روزی: ۰۲۱-۸۸۸۶۲۰۸۵

FarmaSOS.com

امداد خودرو فارما

تلفن شبانه روزی: ۰۲۱-۸۸۸۶۲۰۸۵

FarmaSOS.com

Vehicle equipment	76
Locking and unlocking	76
Starter switch positions	85
Seats	87
Multifunction steering wheel	93
Mirrors	94
Memory function	96
Lighting	97
Wipers	104
Power windows	105
Driving and parking	109
Automatic transmission	114
Transfer case	124
Instrument cluster	125
Control system	126
Driving systems	146
Climate control system	180
Rear window defroster	191
Power tilt/sliding sunroof	192
Panorama roof with power tilt/ sliding panel	194
Loading and storing	197
Useful features	203



Vehicle equipment

i This Operator's Manual describes all features, standard or optional, potentially available for your vehicle at the time of purchase. Please be aware that your vehicle might not be equipped with all features described in this manual.

Locking and unlocking

Notes

⚠ Observe Safety notes, see page 56.

When unlocking or locking the vehicle with the SmartKey an acoustic signal sounds. The acoustic signal is activated at the factory. If you wish to deactivate the feature, or adjust its signal volume, contact an authorized Mercedes-Benz Center.

When unlocking the vehicle, all turn signal lamps flash once. An acoustic signal sounds once, and the locking knobs in the doors move up. The anti-theft alarm system is disarmed.

When locking the vehicle, all turn signal lamps flash three times. An acoustic signal sounds three times, and the locking knobs in the doors move down. The anti-theft alarm system is armed.

All doors and the trunk must be closed.

If you cannot lock or unlock the vehicle with the SmartKey, the batteries in the SmartKey are discharged, the SmartKey is malfunctioning, or the vehicle battery is drained.

- ▶ Check the batteries in the SmartKey (▷ page 79) and replace them if necessary.
- ▶ Use the mechanical key to unlock the driver's door and the trunk (▷ page 314).

▶ Use the mechanical key to lock the vehicle (▷ page 315).

▶ Have the vehicle battery and the vehicle battery connections checked at an authorized Mercedes-Benz Center.

If the SmartKey is malfunctioning, contact Roadside Assistance or an authorized Mercedes-Benz Center.



SmartKey

Your vehicle comes supplied with two SmartKeys, each with remote control and a removable mechanical key.

The SmartKey centrally locks and unlocks

- the doors
- the trunk lid
- the fuel filler flap



- ①  Lock button
- ②  Unlock button for trunk lid
- ③  Unlock button

i USA only:

This device complies with Part 15 of the FCC Rules. Operation is subject to the following two conditions:

1. This device may not cause harmful interference, and
2. this device must accept any interference received, including interference that may cause undesired operation.

Any unauthorized modification to this device could void the user's authority to operate the equipment.

i Canada only:

This device complies with RSS-210 of Industry Canada. Operation is subject to the following two conditions:

1. This device may not cause interference, and
2. this device must accept any interference received, including interference that may cause undesired operation of the device.

Any unauthorized modification to this device could void the user's authority to operate the equipment.

Factory setting

► **Global unlocking:** Press button .



Unless you open a door or the trunk within approximately 40 seconds after unlocking the vehicle:

- The vehicle will be locked again.
- The anti-theft alarm system will be rearmed.

► **Global locking:** Press button .

Selective setting

If you frequently travel alone, you may wish to reprogramm the SmartKey. Pressing button  will then only unlock the driver's door and the fuel filler flap.

► **Switching on/off:** Press and hold buttons  and  simultaneously for approximately 6 seconds until the battery check lamp (▷ page 79) flashes twice.

The SmartKey will then function as follows:

► **Unlocking driver's door and fuel filler flap:** Press button  once.

► **Global unlocking:** Press button  twice.

► **Global locking:** Press button .

KEYLESS-GO

Vehicles equipped with KEYLESS-GO come with two SmartKeys with KEYLESS-GO, each with remote control and a removable mechanical key.

The KEYLESS-GO function is integrated into the SmartKey. The validity of the SmartKey is checked every time you grasp an outside door handle.

When the SmartKey is valid, your vehicle unlocks

- the doors
- the trunk lid
- the fuel filler flap

i USA only: تلفن

This device complies with Part 15 of the FCC Rules. Operation is subject to the following two conditions:

1. This device may not cause harmful interference, and
2. this device must accept any interference received, including interference that may cause undesired operation.

Any unauthorized modification to this device could void the user's authority to operate the equipment.

i Canada only:

This device complies with RSS-210 of Industry Canada. Operation is subject to the following two conditions:

1. This device may not cause interference, and
2. this device must accept any interference received, including interference that may cause undesired operation of the device.

Any unauthorized modification to this device could void the user's authority to operate the equipment.

Important notes on using KEYLESS-GO

- You can also use the SmartKey with KEYLESS-GO like a normal SmartKey (> page 76).
- You can combine KEYLESS-GO functions with normal SmartKey functions (e.g. unlocking with KEYLESS-GO and locking with button ).
- Always carry the SmartKey with you.
- Never store the SmartKey together with
 - electronic items such as a mobile phone or another SmartKey
 - metallic objects such as coins or metal foil

Doing so could impair the function of the KEYLESS-GO system.
- To lock or unlock the vehicle, the SmartKey must be located outside the vehicle within approximately 3 ft (1 m) of a door or the trunk.
- When the vehicle has been parked for more than 72 hours, the KEYLESS-GO function is deactivated. Pull an outside door handle and switch on the ignition once to activate the KEYLESS-GO function.
- If the SmartKey is positioned farther away from the vehicle, the system may no longer recognize the SmartKey. The vehicle cannot be locked or the engine started via the KEYLESS-GO system.
- If the SmartKey is removed from the vehicle (e.g. if a passenger exits the vehicle with the SmartKey)
 - when pressing the KEYLESS-GO start/stop button or trying to lock the vehicle with the outside door handle the message **Key Not Detected** appears in the multifunction display
 - with the engine running, the red message **Key Not Detected** appears in the multifunction display while driving off

Find the SmartKey or change its present location immediately (e.g. place it on the front passenger seat or insert it in shirt pocket).
- If you have started the engine with the KEYLESS-GO start/stop button, you can turn it off again by
 - pressing the KEYLESS-GO start/stop button
 - inserting the SmartKey into the starter switch when the vehicle is at a standstill and the automatic transmission is in park position **P**
- The vehicle could be inadvertently unlocked if the SmartKey is within 3 ft (1 m) of the vehicle and
 - an outside door handle is splashed with water
 - or
 - you attempt to clean an outside door handle
- Remember that the engine can be started by anyone with a SmartKey that is left inside the vehicle.

Possibility 1 (One SmartKey in the vehicle, one SmartKey outside the vehicle):

If you leave the SmartKey behind when exiting and locking the vehicle, no message appears in the multifunction display.

Possibility 2 (One SmartKey in the vehicle, no SmartKey outside the vehicle):

When exiting and trying to lock the vehicle, the message **Key Detected in Vehicle** appears in the multifunction display. The vehicle will not be locked.

Factory setting

► **Global unlocking:** Grasp an outside door handle.

Unless you open a door or the trunk within approximately 40 seconds after unlocking the vehicle:

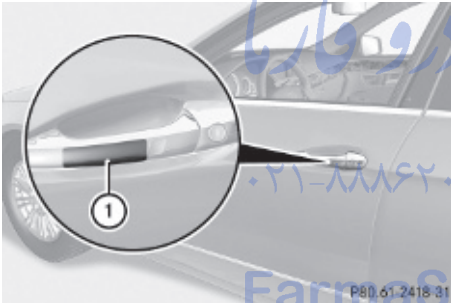

- The vehicle will be locked again.
- The anti-theft alarm system will be rearmed.



► **Global locking:** Touch outside of a door handle ①.

Selective setting

If you frequently travel alone, you may wish to reprogram the SmartKey. Grasping the driver's outside door handle will then only unlock the driver's door and the fuel filler flap.

► **Switching on/off:** Press and hold buttons  and  simultaneously for approximately 6 seconds until the battery check lamp (> page 79) flashes twice.

KEYLESS-GO will then function as follows:

- **Unlocking driver's door and fuel filler flap:** Grasp the driver's outside door handle.
- **Global unlocking:** Grasp any outside door handle other than the driver's outside door handle.
- **Global locking:** Touch outside of a door handle ①.

Checking SmartKey batteries





► Press button  or  on the SmartKey.

Battery check lamp ① comes on briefly to indicate that the SmartKey batteries are in order.

If the battery check lamp does not come on briefly during check, the SmartKey batteries are discharged.

► Replace the batteries (> page 317).

- ❗ You can obtain the required batteries at any authorized Mercedes-Benz Center.
- ❗ If the batteries are checked within signal range of the vehicle, pressing button  or  will lock or unlock the vehicle accordingly.

Loss of the SmartKey

If you lose your SmartKey or mechanical key, you should do the following:

- ▶ Have the SmartKey deactivated by an authorized Mercedes-Benz Center.
- ▶ Report the loss of the SmartKey or the mechanical key to your car insurance company immediately.
- ▶ Have the mechanical lock replaced if necessary.

Any authorized Mercedes-Benz Center will be glad to supply you with a replacement. For information on replacing the SmartKey, see “Replacing the SmartKey” (▷ page 80).

Replacing the SmartKey

Only you, or someone authorized by you can order a replacement key from any Mercedes-Benz Center. In order to do so, the Mercedes-Benz Center will require proof of identity and vehicle ownership with original documents, including the following:

If you are the current owner of the vehicle:

- the vehicle’s current state registration
- a current identity card, passport, or drivers license

If you are an authorized person:

- the vehicle’s current state registration
- a current identity card, passport, or drivers license for the authorized individual
- signed and dated authorization from the owner of the vehicle for which the key is being requested

i Duplicated or photocopied documentation will not be accepted.

Activating the key

Once you, or an authorized person, has provided the appropriate documents, the Mercedes-Benz Center will need to synchronize the key to your vehicle before it can be used. In order to do so, the Mercedes-Benz Center need access to your vehicle.

Opening the doors from the inside

You can open a door from the inside even when it is locked unless it is secured with the child safety lock (▷ page 60).

Open door only when conditions are safe to do so.

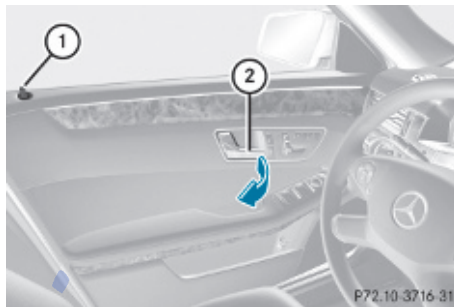

Example illustration driver’s door

If the vehicle has previously been locked with the SmartKey or with KEYLESS-GO, opening a door from the inside will trigger the anti-theft alarm system.

To cancel the alarm, see (▷ page 73).

- ▶ **Front doors:** Pull up inside door handle ② on the respective front door. If the door was locked, locking knob ① will move up.
- ▶ **Rear doors:** Pull up locking knob on the respective rear door to unlock door.

Automatic central locking

The doors and the trunk lock automatically when the vehicle is set into motion.

You can open a locked front door from the inside. Open door only when conditions are safe to do so.

The doors are designed to unlock automatically after an accident if the force of the impact exceeds a preset threshold.

The vehicle locks automatically when the ignition is switched on and the wheels are turning at a vehicle speed of above 9 mph (15 km/h). You could therefore lock yourself

out when the vehicle is pushed or towed or is on a test stand.

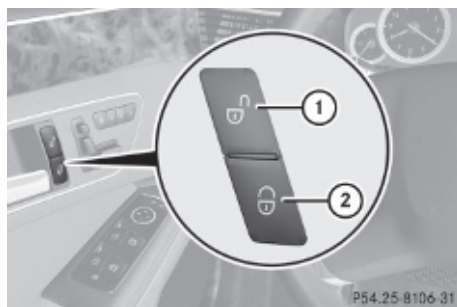

► **Switching off:** Press and hold central unlocking switch ① until an acoustic signal sounds.

► **Switching on:** Press and hold central locking switch ② until an acoustic signal sounds.

❗ If you press and hold either switch and no acoustic signal sounds, the respective setting has already been selected.

❗ You can also switch on or off the automatic central locking using the control system (► page 144).

Locking and unlocking from the inside

⚠ **Observe Safety notes, see page 56.**

You can lock or unlock the vehicle from the inside using the central locking or unlocking switch. This can be useful, for example, if you want to lock the vehicle before starting to drive.

The central locking or unlocking switch does not lock or unlock the fuel filler flap.

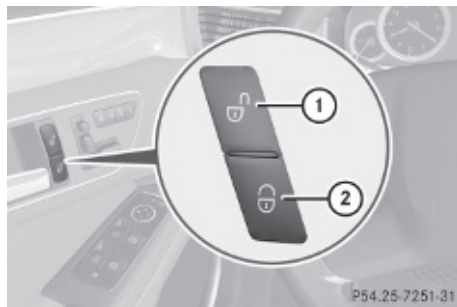

► **Locking:** Press central locking switch ②. When all doors are closed, the vehicle locks.

► **Unlocking:** Press central unlocking switch ①.

You can open a locked front door from the inside. Open door only when conditions are safe to do so.

If the vehicle was previously locked with the central locking switch

- and the SmartKey is set to factory settings, the complete vehicle is unlocked when a front door is opened from the inside
- and the SmartKey is set to selective settings, only the front door opened from the inside is unlocked

If the vehicle has been locked centrally with the SmartKey or with KEYLESS-GO, it will not unlock using the central unlocking switch.

Opening the trunk

⚠ **Warning!**

Make sure the trunk is closed when the engine is running and while driving. Among other dangers, deadly carbon monoxide (CO) gases may enter vehicle interior resulting in unconsciousness and death.

❗ When you open the trunk, the trunk lid swings open upwards. Always make sure there is sufficient overhead clearance.

You can open the trunk when the vehicle is stationary.

A minimum height clearance of 5.78 ft (1.76 m) is required to open the trunk lid.

Opening the trunk from the outside

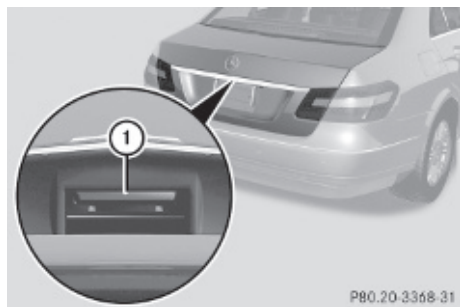

▶ Press and hold button  (▶ page 76) on the SmartKey until the trunk unlocks and begins to open.

or

▶ Pull on handle ①.

In vehicles without KEYLESS-GO: The vehicle must be unlocked.

If the trunk does not open, it is still locked separately (▶ page 85).

Opening the trunk from the inside

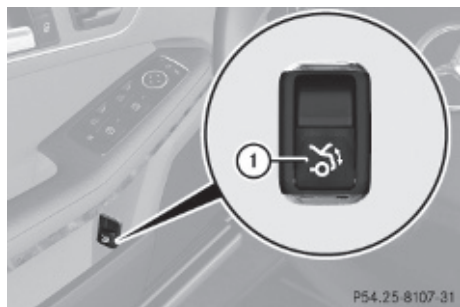

Example illustration: Vehicles with trunk opening/closing system

▶ Pull remote trunk opening switch ① until the trunk begins to open.

If the trunk does not open, it is still locked separately (▶ page 85).

Closing the trunk

Warning!

Make sure the trunk is closed when the engine is running and while driving. Among other dangers, deadly carbon monoxide (CO) gases may enter vehicle interior resulting in unconsciousness and death.

Warning!

To prevent possible personal injury, always keep hands and fingers away from the trunk opening when closing the trunk lid. Be especially careful when small children are around.

Observe Safety notes, see page 56.

Do not leave the SmartKey in the open trunk. You may lock yourself out.

If the vehicle was previously locked centrally with the SmartKey or KEYLESS-GO, the trunk lid will lock automatically when closed. All turn signal lamps flash three times and an acoustic signal sounds three times to confirm locking. تلفن شبانه روزی: ۰۲۱۸۸۸۶۲

Closing the trunk from the outside manually



▶ Lower trunk lid by pulling on handle ① or handle ② firmly.

▶ Close trunk with hands placed flat on trunk lid.

Closing the trunk from the inside automatically

Warning!

Maintain sight of the area around the rear of the vehicle while operating the trunk lid with the door mounted switch. Monitor the closing procedure carefully to make sure no one is in danger of being injured.

To interrupt the closing procedure, release the door mounted remote trunk opening/closing switch again.

Even with the SmartKey removed from the starter switch or the SmartKey with KEYLESS-GO removed from the vehicle, the remote trunk opening/closing switch can be operated. Therefore, do not leave children unattended in the vehicle, or with access to an unlocked vehicle. A child's unsupervised access to a vehicle could result in an accident and/or serious personal injury.

In vehicles with trunk opening/closing system you can close the trunk from the inside using the remote trunk opening/closing switch.

If the trunk lid comes into contact with an object while closing, the closing procedure is stopped and the trunk lid reopens slightly. This will happen only while the trunk is in its upper motion sequence. Check if luggage has been piled too high, for example.

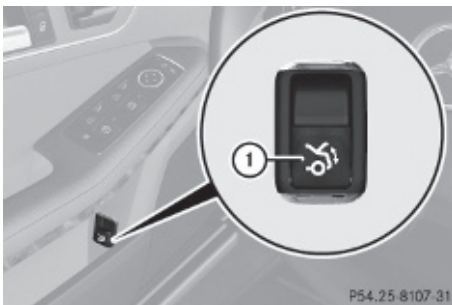

- ▶ Press and hold remote trunk opening/closing switch ① until the trunk is closed.

▶ Interrupting the closing procedure:

Release remote trunk opening/closing switch ①.

Closing the trunk from the outside automatically

Warning!

Monitor the closing procedure carefully to make sure no one is in danger of being injured. To prevent possible personal injury, always keep hands and fingers away from the trunk opening when closing the trunk lid. Be especially careful when small children are around. To stop the closing procedure, do one of the following:

- Press button  on the SmartKey.
- Press the remote trunk opening/closing switch (on the driver's door).
- Press the trunk closing switch.
- Press the KEYLESS-GO locking/closing switch.
- Pull the trunk lid handle.

Even with the SmartKey removed from the starter switch or the SmartKey with KEYLESS-GO removed from the vehicle, the remote trunk opening/closing switch can be operated. Therefore, do not leave children unattended in the vehicle, or with access to an unlocked vehicle. A child's unsupervised access to a vehicle could result in an accident and/or serious personal injury.

In vehicles with trunk opening/closing system you can close the trunk from the outside using the trunk closing switch.

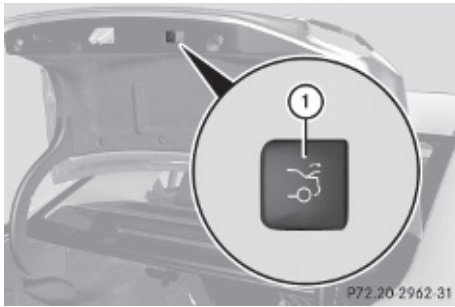

Example: Vehicles with KEYLESS-GO

- ▶ Press trunk closing switch ① briefly.

If the trunk lid comes into contact with an object while closing, the closing procedure is stopped and the trunk lid reopens slightly. This will happen only while the trunk is in its upper motion sequence. Check if luggage has been piled too high, for example.

Closing the trunk and locking vehicle from outside

This section applies to vehicles with trunk opening/closing system and KEYLESS-GO only. You can close the trunk and lock the vehicle simultaneously from the outside using the KEYLESS-GO locking/closing switch.

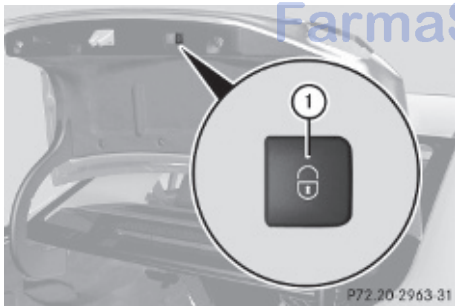

- ▶ Make sure you have the SmartKey with KEYLESS-GO with you.
- ▶ Press KEYLESS-GO locking/closing switch ① briefly.
With all doors closed:

- The locking knobs in the doors move down.
- The trunk lid starts to close automatically.
- All turn signal lamps flash three times to confirm locking once the trunk has closed completely.
- An acoustic signal sounds three times.
- The anti-theft alarm system is armed.

If the trunk lid comes into contact with an object while closing, the closing procedure is stopped and the trunk lid reopens slightly. This will happen only while the trunk is in its upper motion sequence. Check if luggage has been piled too high, for example.

Trunk lid emergency release

The trunk lid can be opened from inside the trunk with the emergency release button.



- ▶ Briefly press emergency release button ①.
The trunk lid unlocks and opens.

The emergency release button unlocks and opens the trunk while the vehicle is standing still or in motion.

Illumination of the emergency release button:

- The button flashes for 30 minutes after opening the trunk.
- The button flashes for 60 minutes after closing the trunk.

The emergency release button does not open the trunk, if the vehicle battery is discharged or disconnected.

Valet locking

You can lock the trunk separately with the mechanical key. This denies unauthorized access to the trunk, e.g. when you valet park the vehicle.

- ▶ Leave only the SmartKey less its mechanical key with the vehicle.

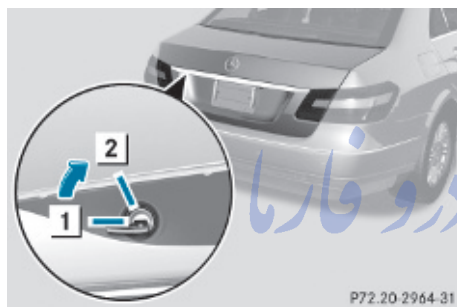

- ▶ **Valet locking:** Close the trunk.
 - ▶ Remove the mechanical key from the SmartKey (▶ page 315).
 - ▶ Insert the mechanical key in the trunk lid lock.
 - ▶ Turn the mechanical key clockwise to position **2** and remove the mechanical key in that position to lock the trunk.
- The trunk remains locked even when the vehicle is centrally unlocked. You can then only open the trunk with the mechanical key.
- ▶ **Canceling:** Insert the mechanical key in the trunk lid lock.
 - ▶ Turn the mechanical key counterclockwise to neutral position **1** and remove the mechanical key in that position to unlock the trunk.
- You can now open the trunk.

Starter switch positions

SmartKey

⚠ Observe Safety notes, see page 56.

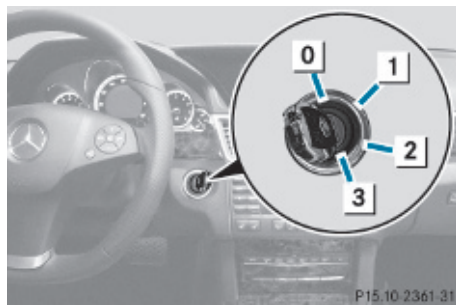

- 0** For removing SmartKey (gear selector lever must be in park position **P**)
- 1** Power supply for some electrical consumers, e.g. wipers
- 2** Ignition (power supply for all electrical consumers) and driving position
- 3** Starting position

When you switch on the ignition, all lamps in the instrument cluster come on. The low-beam headlamp indicator lamp, high-beam headlamp indicator lamp, turn signal indicator lamps, and the indicator lamps for the fog lamps will only come on if activated. If a lamp in the instrument cluster fails to come on when the ignition is switched on, have it checked and replaced if necessary. If a lamp in the instrument cluster remains on after starting the engine or comes on while driving, refer to "Lamps in instrument cluster" (▶ page 304).

If the SmartKey is left in starter switch position **0** for an extended period of time, it can no longer be turned in the starter switch. In this case, the steering is locked. To unlock, remove SmartKey from the starter switch and reinsert.

The steering is locked when the SmartKey is removed from the starter switch.

- ▶ Always remove the SmartKey from the starter switch when the engine is not in operation. This will help to prevent accelerated vehicle battery discharge or a completely discharged vehicle battery.

If the SmartKey cannot be turned in the starter switch, the vehicle battery may not be sufficiently charged.

- ▶ Check the vehicle battery and charge it if necessary (▶ page 337).

or

- ▶ Get a jump start (▶ page 338).

- i** If the SmartKey does not belong to the vehicle, the SmartKey can be turned in the starter switch. However, the ignition does not switch on and the engine does not start.

KEYLESS-GO

⚠ Observe Safety notes, see page 56.

Vehicles equipped with the KEYLESS-GO feature are supplied with a SmartKey with integrated KEYLESS-GO function and a removable KEYLESS-GO start/stop button.

The KEYLESS-GO start/stop button must be inserted in the starter switch and the SmartKey present in the vehicle.

Pressing the KEYLESS-GO start/stop button without depressing the brake pedal corresponds to the various starter switch positions (▶ page 85).

Pressing the KEYLESS-GO start/stop button with the brake pedal firmly depressed will start the engine (▶ page 109).

The KEYLESS-GO start/stop button can be pulled out of the starter switch easily. You can then insert the SmartKey into the starter switch.

- i** The KEYLESS-GO start/stop button does not need to be removed from the starter switch when you leave the vehicle. However, always take the SmartKey with you when you leave the vehicle. As long as

the SmartKey is in the vehicle, the vehicle's electrical systems can be switched on or the engine can be started using the KEYLESS-GO start/stop button.

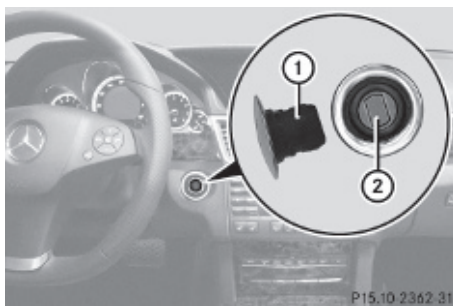

- ① KEYLESS-GO start/stop button
- ② Starter switch

- ▶ Insert the KEYLESS-GO start/stop button into the starter switch (if not inserted already).

- i** Allow for 2 seconds until the system has detected the KEYLESS-GO start/stop button.

- ▶ Make sure the automatic transmission is in park position **P**.
- ▶ Do not depress the brake pedal.



KEYLESS-GO start/stop button

- ③ USA only
- ④ Canada only

Position 0

Before you press the KEYLESS-GO start/stop button, the vehicle's on-board electronics have status **0** (as with SmartKey removed).

Position 1

- ▶ Press the KEYLESS-GO start/stop button once.
This supplies power for some electrical consumers, e.g. wipers.
- i** When you now open the driver's door, the power supply is switched off.

Ignition (or position 2)

- ▶ Press the KEYLESS-GO start/stop button twice.
This supplies power for all electrical consumers.
When you switch on the ignition, all lamps in the instrument cluster come on. The low-beam headlamp indicator lamp, high-beam headlamp indicator lamp, turn signal indicator lamps, and the indicator lamps for the fog lamps will only come on if activated. If a lamp in the instrument cluster fails to come on when the ignition is switched on, have it checked and replaced if necessary. If a lamp in the instrument cluster remains on after starting the engine or comes on while driving, refer to "Lamps in instrument cluster" (▷ page 304).
- i** When you now press the KEYLESS-GO start/stop button once and the driver's door is open, the power supply is switched off.

Seats

Safety notes

Warning!

In order to avoid possible loss of vehicle control the following must be done before the vehicle is put into motion:

- seat adjustment
- head restraint adjustment
- steering wheel adjustment
- rear view mirror adjustment
- fastening of seat belts

Warning!

Do not adjust the driver's seat while driving. Adjusting the seat while driving could cause the driver to lose control of the vehicle.

Never ride in a moving vehicle with the seat backrest in an excessively reclined position as this can be dangerous. You could slide under the seat belt in a collision. If you slide under it, the seat belt would apply force at the abdomen or neck. That could cause serious or fatal injuries. The seat backrest and seat belts provide the best restraint when the wearer is in a position that is as upright as possible and seat belts are properly positioned on the body.

Warning!

Your seat must be adjusted so that you can correctly fasten your seat belt.

Observe the following points:

- Adjust the seat backrest until your arms are slightly angled when holding the steering wheel.
- Adjust the seat to a comfortable seating position that still allows you to reach the accelerator/brake pedal safely. The position should be as far back as possible with the driver still able to operate the controls properly.

- Adjust the head restraint so that it is as close to the head as possible. The center of the head restraint must support the back of the head at eye level.
- Never place hands under the seat or near any moving parts while a seat is being adjusted.

Failure to do so could result in an accident and/or serious personal injury.

Warning!

The power seats can be operated at any time. Therefore, do not leave children unattended in the vehicle, or with access to an unlocked vehicle. A child's unsupervised access to a vehicle could result in an accident and/or serious personal injury.

Warning!

According to accident statistics, children are safer when properly restrained in the rear seating positions than in the front seating position. Thus, we strongly recommend that children be placed in the rear seats whenever possible. Regardless of seating position, children 12 years old and under must be seated and properly secured in an appropriately sized infant restraint, toddler restraint, or booster seat recommended for the size and weight of the child. For additional information, see "Children in the vehicle".

A child's risk of serious or fatal injuries is significantly increased if the child restraints are not properly secured in the vehicle and/or the child is not properly secured in the child restraint.

Warning!

For your protection, drive only with properly positioned head restraints.

Adjust the head restraint so that it is as close to the head as possible and the center of the head restraint supports the back of the head at eye level. This will reduce the potential for injury to the head and neck in the event of an accident or similar situation.

Do not drive the vehicle without the seat head restraints. Head restraints are intended to help reduce injuries during an accident.

Seat adjustment

- When moving the seats, make sure there are no items in the footwell or behind the seats. Otherwise, you could damage the seats and/or the items.

Power seats

- ① The memory function (▷ page 96) lets you store the settings for the seat position together with the settings for the steering wheel and the exterior rear view mirrors.

- ① Vehicles with split rear seat bench: If you fold down one or both sections of the rear seat backrest, the respective front seat is moved forward slightly, if necessary, to prevent contact with the rear seat backrest.

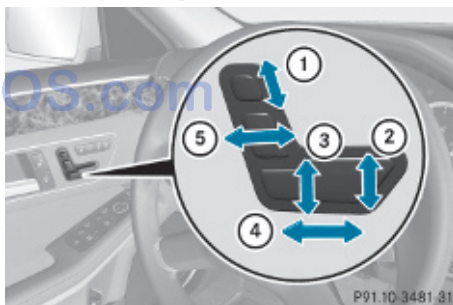

- **Seat fore and aft adjustment:** Press the switch forward or backward in direction of arrow ④.
- **Seat backrest tilt:** Press the switch forward or backward in direction of arrow ⑤.
- **Seat height:** Press the switch up or down in direction of arrow ③.

- ▶ **Seat cushion tilt:** Press the switch up or down in direction of arrow ② until your upper legs are lightly supported.
- ▶ **Head restraint height:** Press the switch up or down in direction of arrow ①.

Head restraint fore and aft adjustment

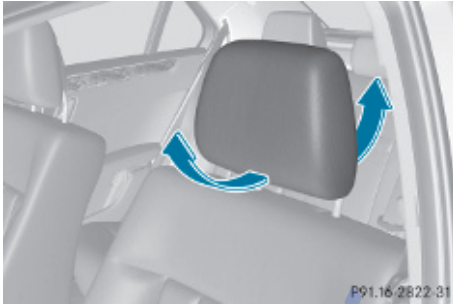

- ▶ Push or pull on the lower edge of the head restraint cushion to the desired position.

Comfort head restraint

⚠ Warning!

When folding back the side cushions, never reach between the side cushion and the mounting post. You could otherwise be trapped.

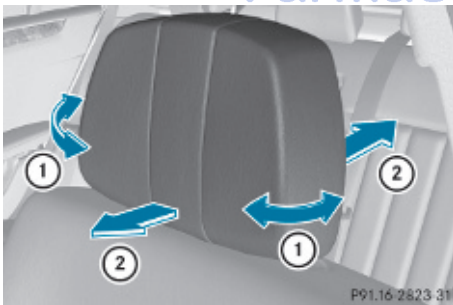

You can adjust the side cushions of the head restraints individually.

- ▶ **Adjusting side cushions:** Pull or push side cushions ① into desired position.
- ▶ **Adjusting forward or backward:** Pull or push head restraint in direction of arrow ②.

Lumbar support

You can adjust the contour of the front seat's lumbar support to help enhance support to your spine.

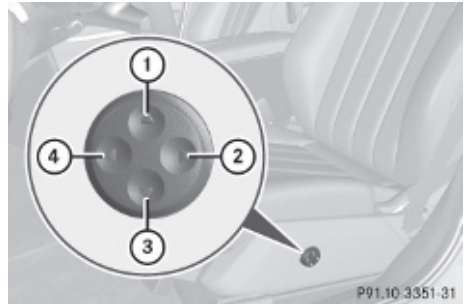

- ▶ **Curvature position:** Use button ① to move the curvature up and button ③ to move it down.
- ▶ **Degree of curvature:** Use button ② to lessen the curvature and button ④ to increase it.

Rear seat head restraints

⚠ Warning!

For safety reasons, always drive with the rear head restraints in the upright position when the rear seats are occupied.

Keep the area around head restraints clear of articles (e.g. clothing) to not obstruct the folding operation of the head restraints.

⚠ Warning!

For your protection, drive only with properly positioned head restraints.

Adjust the head restraint in such a way that it is as close to the head as possible and the center of the head restraint supports the back of the head at eye level. This will reduce the potential for injury to the head and neck in the event of an accident or similar situation.

With a rear seat occupied, make sure to move the respective head restraint up from the

lowest non-use position and have the occupant adjust the head restraint properly.

Do not drive the vehicle without the seat head restraints installed when the rear seats are occupied. Head restraints are intended to help reduce injuries during an accident.

Warning!

Make sure the rear seat head restraints engage when placing them upright manually. Otherwise their protective function cannot be ensured.

The back of the head will not be supported in the event of a collision. That could cause serious or even fatal injuries. Rear seat occupants can be seriously injured or killed.

Lowering rear seat head restraints

The rear seat head restraints can be lowered for increased visibility.

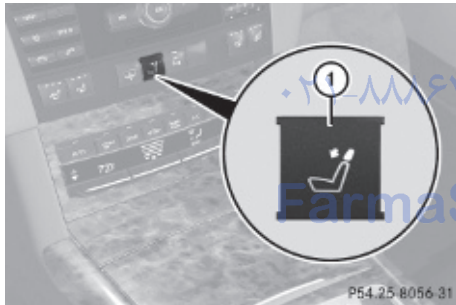

- ▶ Press button ①.
The rear seat head restraints are lowered.

Rear seat head restraint height adjustment

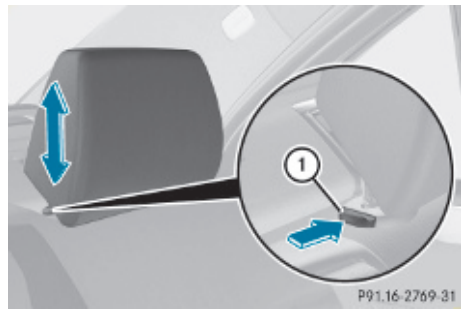

- ▶ **Raising:** Pull head restraint upward to the desired position.
- ▶ **Lowering:** Press release button ① and push down on head restraint.

Rear seat head restraint fore and aft adjustment



- ▶ Adjust the head restraint to the desired position by pushing or pulling on the upper edge of the head restraint cushion.

Rear seat head restraints, removing and installing (vehicles with split foldable rear seat backrest)

- i** The rear seat head restraints cannot be removed on vehicles which do not have the split foldable rear seat backrest.

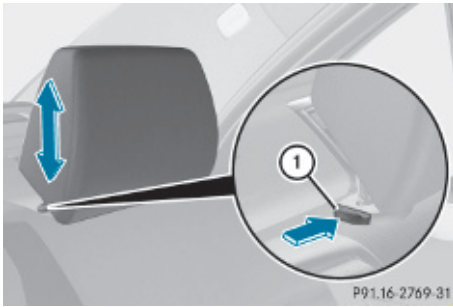

P91.16 2769.31

- ▶ **Removing:** Unlock the rear seat backrest (▷ page 199) and fold it slightly forward.
- ▶ Pull head restraint to its highest position.
- ▶ Press release button ① and pull out head restraint.
- ▶ **Installing:** Position the head restraints so that the notches on the rod are on the left when looking in the direction of travel.
- ▶ Insert head restraint and push it down until it engages.
- ▶ Fold the rear seat backrest back until it engages.

Drive-dynamic multicontour seat

The drive-dynamic multicontour seat is only available on the driver's side.

The drive-dynamic multicontour seat allows several individual support adjustments and can automatically adjust lateral support to your driving style.

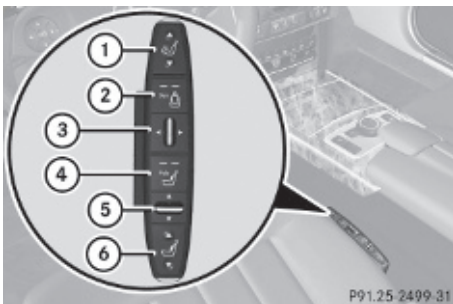

P91.25 2499.31

- ① Seat cushion length
- ② Drive-dynamic function

- ③ Seat backrest side bolsters
- ④ Massage function
- ⑤ Seat backrest contour support
- ⑥ Seat backrest contour up or down

- ▶ **Seat cushion length:** Adjust the seat cushion to the length of your upper leg using switch ①.
- ▶ **Seat backrest side bolsters:** Adjust the side bolsters so that they provide good lateral support using switch ③.
- ▶ **Seat backrest contour:** Adjust the contour of the seat backrest to the desired position using switches ⑤ and ⑥.

Drive-dynamic function

The drive-dynamic multicontour seat electronically controls the air pressure in the air chambers of the seat backrest side bolsters. This function improves driving comfort and pleasure.

You can choose between:

- Level 1 (one indicator lamp comes on): Less lateral support and slow air pressure build-up in the air chambers of the seat backrest side bolsters.
- Level 2 (two indicator lamps come on): Strong lateral support and fast air pressure build-up in the air chambers of the seat backrest side bolsters.

- ▶ **Switching on:** Press button ② repeatedly until the desired level is set. One or two indicator lamps in the button come on.
- ▶ **Switching off:** Press button ② repeatedly until all indicator lamps go out.

Massage function (PULSE)

You can reduce muscle tension during long trips by periodically using the massage function. you can choose between two levels.

- **Switching on:** Press button ④ repeatedly until the desired level is set. One or two indicator lamps in the button come on. The air cushions in the lumbar region inflate and deflate rhythmically for approximately 20 minutes.

Seat ventilation

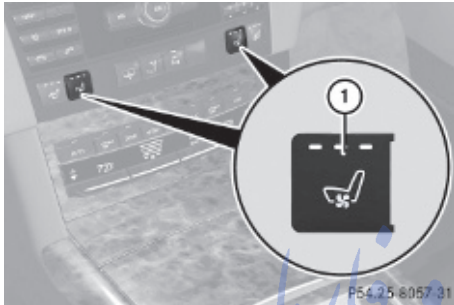

The blue indicator lamps in seat ventilation switch ① come on to show which ventilation level you have selected.

- ① The seat ventilation for the driver's seat can be activated using the summer opening feature (▷ page 107).

- Switch on the ignition.
- **Switching on:** Press seat ventilation switch ①. Three blue indicator lamps in seat ventilation switch ① come on.
- Press seat ventilation switch ① repeatedly until the desired ventilation level is set.
- **Switching off:** Press seat ventilation switch ① repeatedly until all indicator lamps go out.

If there is insufficient voltage the seat ventilating switches off automatically.

Seat heating

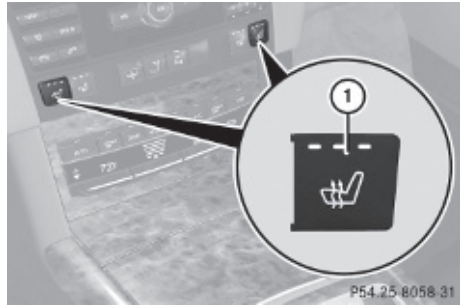

Front seat heating switches

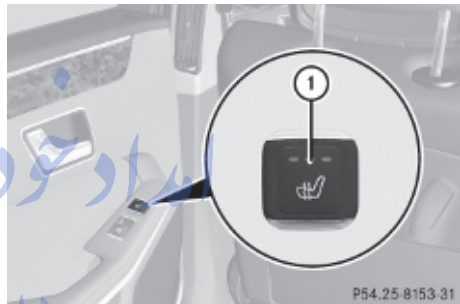

Rear seat heating switch (Canada only)

The red indicator lamps in seat heating switch ① come on to show which heating level you have selected.

The seat heating switches from level 3 (high) to level 2 after approximately 8 minutes.

The seat heating switches from level 2 to level 1 (low) after approximately 10 minutes.

After approximately 20 minutes in level 1, the seat heating switches off automatically.

- Switch on the ignition.
- **Switching on:** Press seat heating switch ①.
- **Switching off:** Press seat heating switch ① repeatedly until all indicator lamps go out.

If there is insufficient voltage the seat heating switches off automatically.

The seat heating will switch back on again automatically as soon as sufficient voltage is available.

Multifunction steering wheel

Safety notes

Warning!

Do not adjust the steering wheel while driving. Adjusting the steering wheel while driving could cause the driver to lose control of the vehicle.

The electrical steering wheel adjustment feature can be operated at any time. Therefore, do not leave children unattended in the vehicle, or with access to an unlocked vehicle. A child's unsupervised access to a vehicle could result in an accident and/or serious personal injury.

Make sure

- you can reach the steering wheel with your arms slightly bent at the elbows
- you can move your legs freely
- all displays (including malfunction and indicator lamps) on the instrument cluster are clearly visible

Steering wheel adjustment

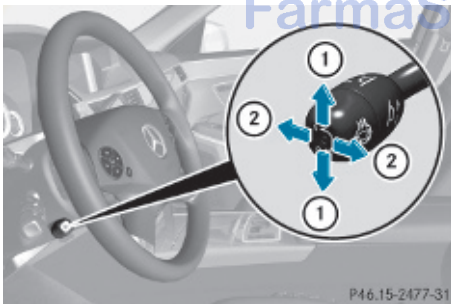

- ▶ **Adjusting steering wheel up or down:** Move stalk in direction of arrows ①.
- ▶ **Adjusting steering wheel in or out:** Move stalk in direction of arrows ②.

i The memory function (▷ page 96) lets you store the settings for the steering wheel together with the settings for the

seat position and the exterior rear view mirrors.

Easy-entry/exit feature

This feature allows the driver an easier entry into and exit from the vehicle. When entering and exiting the vehicle, the steering wheel is in its uppermost position.

The easy-entry/exit feature can be activated or deactivated in the Convenience submenu of the control system (▷ page 145).

Warning!

You must make sure no one can become trapped or injured by the moving steering wheel when the easy-entry/exit feature is activated.

To stop steering wheel movement, move steering wheel adjustment stalk or press one of the memory position buttons.

Do not leave children unattended in the vehicle, or with access to an unlocked vehicle. Children could open the driver's door and unintentionally activate the easy-entry/exit feature, which could result in an accident and/or serious personal injury.

With the easy-entry/exit feature activated, the steering wheel will return to its last set position when you close the driver's door with the ignition switched on. The steering wheel will also return to its last set position when you insert the SmartKey into the starter switch or press the KEYLESS-GO start/stop button once with the driver's door closed.

i The last set steering wheel position is stored when the ignition is switched off or the position is stored in memory (▷ page 97).

With the easy-entry/exit feature activated, the steering wheel tilts upwards when you remove the SmartKey from the starter switch. The steering wheel also tilts upwards when you open the driver's door with the SmartKey

in starter switch position **0** or **1** or the KEYLESS-GO start/stop button in position **1**.

- i** When the current position for the steering wheel is in the uppermost tilt position, the steering wheel will no longer be able to move upward when the easy-entry/exit feature is activated.

The adjustment procedure is briefly interrupted when the engine is started.

Warning!

Let the system complete the adjustment procedure before setting the vehicle in motion. All steering wheel adjustment must be completed before setting the vehicle in motion. Driving off with the steering wheel still adjusting could cause the driver to lose control of the vehicle.

Crash-responsive exit aid

When you open the driver's door after an accident has occurred, the steering column moves up. The position of the SmartKey in the starter switch is insignificant. This function facilitates exiting as well as rescue of vehicle occupants.

The crash-responsive exit aid can only be triggered when the easy-entry/exit feature is activated via the control system.

Heated steering wheel

The steering wheel heating warms up the leather area of the steering wheel.

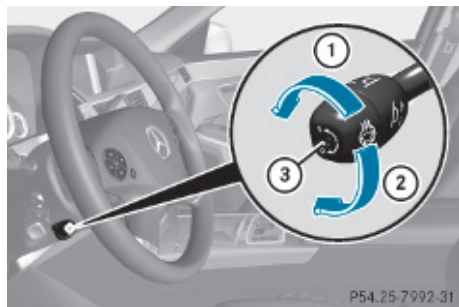

P54.25-7992-31

- ▶ Switch on the ignition.

- ▶ **Switching on:** Turn switch at the tip of the stalk in direction of arrow ①. Indicator lamp ③ comes on.

- i** The steering wheel heating may be suspended temporarily. However, indicator lamp ③ remains on. The steering wheel heating is suspended when the temperature of the vehicle interior is above 86°F (30°C). It is also suspended when the temperature of the steering wheel is above 95°F (35°C).

- ▶ **Switching off:** Turn switch at the tip of stalk in direction of arrow ②. Indicator lamp ③ goes out.

- i** Indicator lamp ③ flashes or goes out in case of power surge or undervoltage or if the steering wheel heating malfunctions.

- i** The steering wheel heating switches off automatically when you remove the SmartKey from the starter switch or, on vehicles with KEYLESS-GO, when you switch off the ignition and open the driver's door.

For more information on the steering wheel, see "Multifunction steering wheel" (> page 126).

Mirrors

Notes

Adjust the interior and exterior rear view mirrors before driving so that you have a good view of the road and traffic conditions.

Interior rear view mirror

- ▶ Adjust the interior rear view mirror manually.

Exterior rear view mirrors

Warning!

Exercise care when using the passenger-side exterior rear view mirror. The mirror surface is convex (outwardly curved surface for a wider field of view). Objects in mirror are closer than they appear. Check your interior rear view mirror and glance over your shoulder before changing lanes.



- i** You can store the settings for the exterior rear view mirror position with the memory function (▷ page 96).
- ▶ Switch on the ignition.
- ▶ Press button **①** for the driver's side exterior rear view mirror or button **②** for the passenger-side exterior rear view mirror. The indicator lamp in the respective button comes on. If you do not make adjustments to the selected exterior rear view mirror within 15 seconds, the indicator lamp goes out. You will then have to select the desired exterior rear view mirror again before adjustments can be made. Adjustments can only be made with the indicator lamp for the respective exterior rear view mirror button illuminated.
- ▶ Press adjustment button **③** up, down, left or right according to the desired setting.

! If an exterior rear view mirror was forcibly hit from the front, manually snap it back into place.

i At low ambient temperatures, the exterior rear view mirrors will be heated automatically.

Auto-dimming rear view mirrors

The exterior rear view mirror on the driver's side and the interior rear view mirror will respond automatically to glare when the ignition is switched on and incoming light from headlamps falls on the sensor in the interior rear view mirror.

The rear view mirrors will not react if the automatic transmission is set to reverse gear **R** or the interior lighting is switched on.

Warning!

The auto dimming function does not react if incoming light is not aimed directly at sensors in the interior rear view mirror.

The interior rear view mirror and the exterior rear view mirror on the driver's side do not react, for example, if the rear window sunshade is in raised position.

Light hitting the mirror(s) at certain angles (incident light) could blind you. As a result, you may not be able to observe traffic conditions and could cause an accident.

Exterior rear view mirror parking position

To assist during parking maneuvers, you can set the passenger-side exterior rear view mirror so that you can see the rear wheel and the road curb.

Setting and storing the parking position

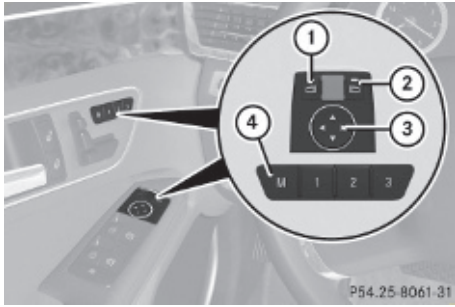

- ▶ Switch on the ignition.
- ▶ Press button ②, to select the passenger-side exterior rear view mirror.
- ▶ Shift the automatic transmission into reverse gear **R**.
The passenger-side exterior rear view mirror moves to the preset parking position.
- ▶ Adjust the passenger-side exterior rear view mirror with adjustment button ③ so that you see the rear wheel and the road curb.
The exterior rear view mirror parking position is stored.

You can also store the parking position using the memory button **M** ④:

- ▶ Switch on the ignition.
- ▶ Press button ②, to select the passenger-side exterior rear view mirror.
- ▶ Adjust the passenger-side exterior rear view mirror with adjustment button ③ so that you see the rear wheel and the road curb.
- ▶ Press memory button **M** ④ and within 3 seconds, press one of the arrows of adjustment button ③.
The parking position is stored if the exterior rear view mirror does not move.

i If the exterior rear view mirror does move, repeat the above steps. After the setting is stored, you can move the exterior rear view mirror again.

Calling up the parking position

- ▶ Switch on the ignition.
- ▶ Press button ②, to select the passenger-side exterior rear view mirror.
- ▶ Shift the automatic transmission into reverse gear **R**.
The passenger-side exterior rear view mirror moves to the stored parking position.

The passenger-side exterior rear view mirror returns to its previously stored driving position

- 10 seconds after you have put the gear selector lever out of reverse gear **R**
- immediately once your vehicle exceeds a speed of approximately 6 mph (10 km/h)
- immediately when you press button ① to select the driver's side exterior rear view mirror

Memory function

Notes

With the memory function you can store up to three different configurations per front seat.

Each memory position button on the driver's side can store all of the following settings:

- Seat position
- Drive-dynamic multicontour seat: Drive-dynamic function level
- Steering wheel position
- Exterior rear view mirrors' position

⚠ Warning!

Do not activate the memory function while driving. Activating the memory function while driving could cause the driver to lose control of the vehicle.

Each memory position button on the front passenger side can store the setting of the seat position.

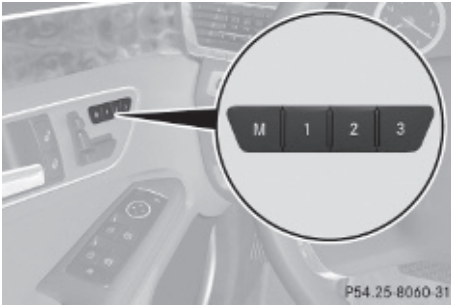

Storing positions into memory

- ▶ Adjust the seats.
- ▶ On the driver’s side, also adjust the steering wheel and exterior rear view mirrors to the desired positions.
- ▶ Press memory button **M** once and within 3 seconds press memory position button **1, 2 or 3**.

When the settings are stored to the selected position, an acknowledgement signal sounds.

Recalling positions from memory

- ▶ Press and hold desired memory position button **1, 2 or 3** until the seat has moved to the stored position completely. On the driver’s side, also wait for the steering wheel and exterior rear view mirrors to move to the stored position.
- i** Releasing the memory position button stops movement to the stored positions immediately.

Lighting

Notes

- i** If you drive in countries with left-hand driving, you must have the headlamps

modified for symmetrical low beams. Relevant information can be obtained at any authorized Mercedes-Benz Center.

- i** Vehicles equipped with active Bi-Xenon headlamps:

The active Bi-Xenon headlamps increase usable illumination over conventional headlamps because they follow the curvature of the road ahead. The beams of the active Bi-Xenon headlamps shift to either side according to the vehicle’s steering angle and speed.

Exterior lamp switch

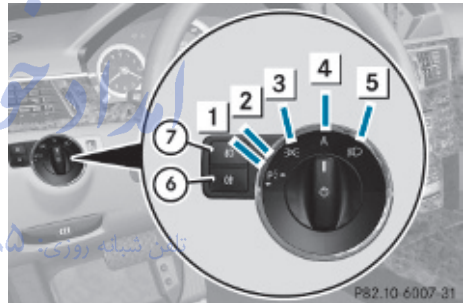

- 1** Standing lamps, left
- 2** Standing lamps, right
- 3** Parking lamps⁵
Daytime running lamp mode
- 4** Automatic headlamp mode
Daytime running lamp mode
- 5** Low-beam headlamps or high-beam headlamps
- 6** Vehicles with front fog lamps: Rear fog lamp
- 7** Vehicles with front fog lamps: Front fog lamps

- i** The exterior lamps (except standing lamps or parking lamps) go out automatically when you remove the SmartKey from the starter switch or open

⁵ When the parking lamps are on, the tail lamps, the license plate lamps, the side marker lamps, and the instrument cluster illumination are also on.

the driver's door with the ignition switched off.

When the parking lamps or the rear fog lamp are switched on and you remove the SmartKey from the starter switch and open the driver's door, an acoustic signal sounds.

In addition the message Switch Off Lights appears in the multifunction display.

Switch off the parking lamps or the rear fog lamp manually.

! Failure to switch off the parking lamps when leaving the vehicle may result in a discharged battery.

i Vehicles without front fog lamps: For better detection of the vehicle, the LED daytime running lamps are dimmed to parking lamp level when the low-beam headlamps are switched on.

Low-beam headlamps

The low-beam headlamps can be switched on and off with the exterior lamp switch.

► Switch on the ignition.

► **Switching on:** Turn the exterior lamp switch to position .

The following lamps come on:





- Low-beam headlamps
- Parking lamps⁵
- Green indicator lamp  in the instrument cluster

Automatic headlamp mode

Warning!

If the exterior lamp switch is set to , the headlamps will not automatically come on under foggy conditions.

To minimize risk to you and to others, activate headlamps by turning exterior lamp switch to  when driving or when traffic and/or ambient lighting conditions require you to do so.

In low ambient lighting conditions, only switch from position  to  with the vehicle at a standstill in a safe location. Switching from  to  will briefly switch off the headlamps. Doing so while driving in low ambient lighting conditions may result in an accident.

The automatic headlamp feature is only an aid to the driver. The driver is responsible for the operation of the vehicle's lights at all times.

► **Switching on:** Turn the exterior lamp switch to position .

When ambient light is low: When the SmartKey is in starter switch position **1** or when the KEYLESS-GO start/stop button has been pressed once, the parking lamps⁵ come on automatically.

When the engine is running, the low-beam headlamps come on additionally.

When ambient light is bright: When the SmartKey is in starter switch position **1** or when the KEYLESS-GO start/stop button has been pressed once, all lamps are off.

When the engine is running, the daytime running lamps⁶ come on automatically.

When the low-beam headlamps are switched on, the green indicator lamp  in the instrument cluster comes on.

Once the low-beam headlamps are on, the high-beam headlamps are also available.

Daytime running lamp mode

In Canada, the daytime running lamp mode is mandatory and therefore in a constant mode.

In the USA, the daytime running lamp mode is deactivated by default.

⁵ When the parking lamps are on, the tail lamps, the license plate lamps, the side marker lamps, and the instrument cluster illumination are also on.

⁶ USA only: The daytime running lamp mode must be activated via the control system.

- ▶ Activate the daytime running lamp mode using the control system, see “Switching daytime running lamp mode on or off (USA only)” (> page 141).
- ▶ Turn the exterior lamp switch to position .

When the engine is running and the ambient light is bright, the daytime running lamps come on.

In low ambient lighting conditions, the following lamps will come on additionally:



- Low-beam headlamps
- Parking lamps⁵
- green indicator lamp  in the instrument cluster

You can only switch on the high-beam headlamps when the low-beam headlamps are on.

The high-beam flasher is available at all times.

Canada only

When the engine is running, and you

- shift from a driving position to park position **P** with the vehicle at a standstill, the daytime running lamps or the low-beam headlamps will go out with a delay of 3 minutes
- turn the exterior lamp switch to position , the daytime running lamps and the parking lamps⁵ come on in bright ambient lighting conditions.
- turn the exterior lamp switch to position , the manual headlamp mode has priority over the daytime running lamp mode

The corresponding exterior lamps come on (> page 97).



USA only



When the engine is running, and you turn the exterior lamp switch to position  or

, the manual headlamp mode has priority over the daytime running lamp mode. The corresponding exterior lamps come on (> page 97).

Fog lamps

Warning!



In low ambient lighting or foggy conditions, only switch from position  to  with the vehicle at a standstill in a safe location.

Switching from  to  will briefly switch off the headlamps. Doing so while driving in low ambient lighting conditions may result in an accident.

Front fog lamps will operate with the parking lamps and/or the low-beam headlamps on.

The rear fog lamp can only be switched on with the exterior lamp switch in position

. Fog lamps should only be used in conjunction with low-beam headlamps. Consult your State or Province Motor Vehicle Regulations regarding permissible lamp operation. تلفن شما.

- ▶ Switch on the ignition.
- ▶ Turn the exterior lamp switch to position , or , or  (> page 97).

Vehicles with front fog lamps

- ▶ **Switching on front fog lamps:** Press switch  (> page 97).



The green indicator lamp  in the instrument cluster comes on.

- ▶ **Switching off front fog lamps:** Press switch  (> page 97).



The green indicator lamp  in the instrument cluster goes out.

⁵ When the parking lamps are on, the tail lamps, the license plate lamps, the side marker lamps, and the instrument cluster illumination are also on.

- ▶ **Switching on rear fog lamp:** Press switch  (▷ page 97).

The rear fog lamp, the front fog lamps, the green  and the yellow indicator lamp  in the instrument cluster come on.

- ▶ **Switching off rear fog lamp:** Press switch  (▷ page 97).

The rear fog lamp, the front fog lamps, the green  and the yellow indicator lamp  in the instrument cluster goes out.

Vehicles without front fog lamps

- ▶ **Switching on rear fog lamp:** Press switch  (▷ page 97).

The rear fog lamp and the yellow indicator lamp  in the instrument cluster come on.

- ▶ **Switching off rear fog lamp:** Press switch  (▷ page 97).

The rear fog lamp and the yellow indicator lamp  in the instrument cluster goes out.



Locator lighting

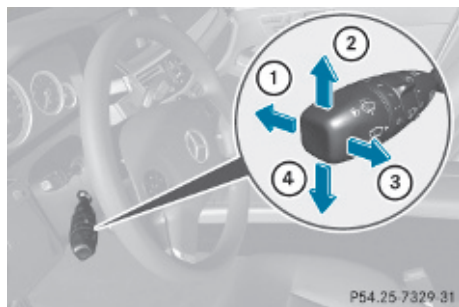

The locator lighting is described in the “Control system” section, see “Switching locator lighting on or off” (▷ page 142).

Combination switch





Turn signals

- ▶ Press the combination switch in direction of arrow  or .

The corresponding turn signal indicator lamp  or  in the instrument cluster flashes.



The combination switch resets automatically after major steering wheel movements.

To signal minor directional changes:

- ▶ Press the combination switch only to the point of resistance in direction of arrow  or  and release. The corresponding turn signal lamps will flash three times.

High beam

- ▶ Turn the exterior lamp switch to position  (▷ page 97).

- ▶ **Switching on:** Push the combination switch in direction of arrow . The high-beam headlamp indicator lamp  in the instrument cluster comes on.

- ▶ **Switching off:** Pull the combination switch in direction of arrow  to its original position.

- ▶ Also note the information on high-beam headlamps with activated automatic headlamp mode (▷ page 98) or the daytime running lamp mode (▷ page 98).

Adaptive Highbeam Assist

The Adaptive Highbeam Assist is only available in vehicles with Bi-Xenon headlamps.

Depending on the driving and traffic situation, low-beam leveling and the high-beam headlamps are controlled via an optical sensor. The sensor is located on the front of the overhead control panel. Glare for other road users is reduced and the illumination of road ahead is improved. The transitions between low-beam and high-beam headlamps take place without a sudden change of light.

Warning!

The Adaptive Highbeam Assist is only an aid intended to support you while driving. The driver is and remains responsible for proper vehicle lighting in accordance with the prevailing light, sight and traffic conditions. The system may be impaired or unavailable when

- visibility is poor, e.g. due to snow, rain, fog, or heavy spray
- the optical sensor area of the windshield is dirty, fogged up, or covered by a sticker for example

The system cannot recognize the following road users:



- Road users without a lighting system of their own, e.g. pedestrians
- Road users with dim lighting of their own, e.g. cyclists
- Road users whose lighting is obstructed, e.g. road users behind a guardrail
- In some seldom cases, even road users with a lighting system of their own may be recognized too late or not at all.

The automatic high-beam headlamps will then not be deactivated or it will be activated in spite of preceding or oncoming road users.

This could endanger you and/or others and cause an accident. Always pay close attention to the traffic situation and switch off the high beam manually if necessary.

- ▶ **Activating:** Enable the Adaptive Highbeam Assist via the control system (▷ page 142).
- ▶ Turn the exterior lamp switch to position .
- ▶ Press the combination switch in direction of arrow ①.

The Adaptive Highbeam Assist indicator  in the multifunction display comes on when switching on the low-beam headlamps.

When driving faster than approximately 34 mph (55 km/h) and no other road users are recognized, the high-beam headlamps are switched on automatically. The high-beam headlamp indicator lamp  in the instrument cluster comes on additionally. When driving slower than approximately 28 mph (45 km/h), other road users are recognized, or the road is illuminated sufficiently, the high-beam headlamps are switched off automatically. The indicator lamp  in the instrument cluster goes out. The Adaptive Highbeam Assist indicator  in the multifunction display remains on.

Adaptive control of the headlamp leveling takes place at a speed of approximately 25 mph (40 km/h).

- ▶ **Deactivating:** Pull the combination switch back to its initial position. The Adaptive Highbeam Assist indicator  in the multifunction display goes out.

High-beam flasher

- ▶ **Switching on:** Pull the combination switch briefly in direction of arrow ③.

Hazard warning flasher

The hazard warning flasher can be switched on at all times, even with the SmartKey removed from the starter switch.

The hazard warning flasher comes on automatically when an air bag deploys.



- ▶ **Switching on:** Press hazard warning flasher switch ①.
All turn signal lamps are flashing.
- ❗ With the hazard warning flasher activated and the combination switch set for either left or right turn, only the respective left or right turn signals will operate when the ignition is switched on.
- ▶ **Switching off:** Press hazard warning flasher switch ① again.
- ❗ If the hazard warning flasher has been activated automatically, press hazard warning flasher switch ① to switch it off.

Headlamp cleaning system

The headlamps will be cleaned with a high-pressure water jet automatically when the engine is running and you have

- switched on the headlamps and
- the windshield wipers have wiped the windshield with washer fluid for the first time

The headlamps are cleaned every tenth time the windshield is washed with washer fluid.

The counter resets when you switch off the ignition.

For information on filling up the washer reservoir, see “Washer system and headlamp cleaning system” (▷ page 227).



Corner-illuminating lamps

The corner-illuminating lamps improve illumination of the area in the direction into which you are turning.

The corner-illuminating lamps will only operate in low ambient lighting conditions.

If you are driving faster than 25 mph (40 km/h) the corner-illuminating function is not available.

Switching on

- ▶ Make sure the engine is running.
 - ▶ Turn the exterior lamp switch to position  or  (▷ page 97).
- or
- ▶ Activate the daytime running lamp mode (▷ page 98).
 - ▶ Switch on the left or right turn signal, depending on whether you are turning left or right.
- The respective corner-illuminating lamp comes on. If you have switched on the turn signal for one side but turn the steering wheel in the other direction, the corner-illuminating lamp comes on on the side of the turn signal.

or

- ▶ Turn steering wheel in desired direction.
Driving forward: The corner-illuminating lamp on the side of your steering direction comes on.
Driving in reverse: The corner-illuminating lamp opposite to your steering direction comes on.

The corner-illuminating lamps will come on automatically depending on the steering angle, even if you did not switch on either turn signal. If the corner-illuminating lamps came on automatically, they will also go out automatically depending on the steering angle and vehicle speed.

The corner-illuminating lamps temporarily come on on both sides of the vehicle if you turn the steering wheel in one direction and

then again in the other direction shortly thereafter.

The corner-illuminating lamp remains lit for a short time only. It then goes out automatically.

Switching off

► Switch off the left or right turn signal.

or

► Steer straight ahead.

The corner-illuminating lamp goes out.

- i** There may be a brief delay before the corner-illuminating lamps go out.

Interior lighting in the front



- ① Rear interior lighting on/off
- ② Automatic control on/off
- ③ Right front reading lamp on/off
- ④ Front interior lighting on/off
- ⑤ Left front reading lamp on/off

Automatic control

► **Activating:** Press button .

Button disengages and sits flush with the other buttons.

The interior lighting comes, when you

- unlock the vehicle
- remove the SmartKey from the starter switch (Interior Lighting Delay: must be enabled (▷ page 143))
- open a door

The interior lighting goes out after a short time.

- i** If a door remains open, the interior lamps go out automatically after approximately 5 minutes.

► **Deactivating:** Press button .

Button engages.

Manual control

! An interior lamp switched on manually does not go out automatically.

Leaving an interior lamp switched on for an extended period of time with the engine turned off could result in a discharged battery.

► **Switching front interior lighting on/off:** Press switch .

► **Switching rear interior lighting on/off:** Press switch .

► **Switching front reading lamps on/off:** Press respective button .

Ambient lighting

The brightness of the ambient lighting is adjusted via the “Control system” (▷ page 143).

Emergency lighting

When the interior lighting is set to automatic mode, the interior lighting comes on automatically if the vehicle is involved in an accident.

Switching off:

► Press hazard warning flasher switch (▷ page 101).

or



► Unlock the vehicle with the SmartKey.

Interior lighting in the rear

! An interior lamp switched on manually does not go out automatically.

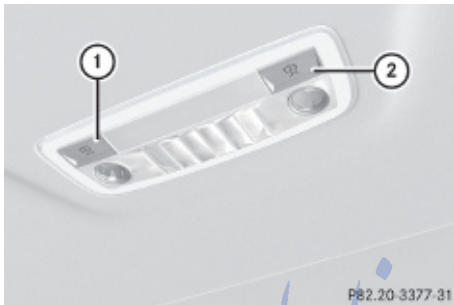
Leaving an interior lamp switched on for an extended period of time with the engine turned off could result in a discharged battery.







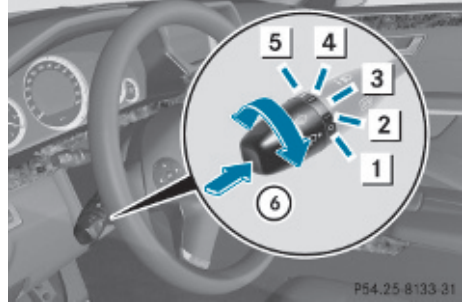

- ①  Right rear reading lamp on/off
 ②  Left rear reading lamp on/off

Switching on/off



Combination switch

- ①  Windshield wipers off
 ②  Slow intermittent wiping⁷
 ③  Fast intermittent wiping⁸
 ④  Slow continuous wiping
 ⑤  Fast continuous wiping
 ⑥  Single wipe/  Wiping with washer fluid

- ▶ Switch on the ignition.
- ▶ Turn the combination switch to the desired position, depending on the intensity of the rain.

Wipers

Notes

! Do not operate the wipers when the windshield is dry. Dust that accumulates on a windshield might scratch the glass and/or damage the wiper blades when wiping occurs on a dry windshield. If it is necessary to operate the wipers in dry weather conditions, always operate the wipers with washer fluid.

Windshield wipers

- ▶ Observe notes on page (▷ page 104).

Intermittent wiping

Only switch on intermittent wiping under wet weather conditions or in the presence of precipitation.

When you select intermittent wiping, the rain sensor is activated. The rain sensor sets a suitable wiping interval depending on the wetness of the sensor surface automatically.

! Do not leave windshield wipers on an intermittent setting when the vehicle is taken to an automatic car wash or during windshield cleaning. Windshield wipers will operate in the presence of water sprayed on the windshield, and windshield wipers may be damaged as a result.

⁷ Rain sensor operation with low sensitivity.

⁸ Rain sensor operation with high sensitivity.

! If you have set intermittent wiping, dirt on the surface of the rain sensor or optical effects may cause the windshield wipers to wipe in an undesired fashion. This could then damage the windshield wiper blades or scratch the windshield. You should therefore switch off the windshield wipers when weather conditions are dry.

▶ Turn the combination switch to position

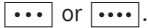

After the initial wipe, pauses between wipes are controlled by the rain sensor automatically.

Intermittent wiping is interrupted when the vehicle is at a standstill and a front door is opened. This protects persons getting into or out of the vehicle from being sprayed.

Intermittent wiping will be continued when all doors are closed and

- the automatic transmission is in drive position **D** or reverse gear **R**
- or
- the wiper setting is changed using the combination switch

Single wipe

▶ Press the combination switch briefly in direction of arrow ⑥ to the resistance point.

The windshield wipers wipe one time without washer fluid.

Wiping with washer fluid

▶ Press the combination switch in direction of arrow ⑥ past the resistance point.

The windshield wipers operate with washer fluid.

i To prevent smears on the windshield or noisy/chattering wiper blades, wipe with washer fluid every now and then even when it is raining.

For information on filling up the washer reservoir, see “Washer system and headlamp cleaning system” (▷ page 227).

For information on cleaning the headlamps with washer fluid, see “Headlamp cleaning system” (▷ page 102).

Problems with wipers

! If anything blocks the windshield wipers (leaves, snow, etc.), switch them off immediately.

For safety reasons, do the following before attempting to remove any blockage:

- Stop the vehicle in a safe location.
- Remove the SmartKey from the starter switch.
- or
- Turn off the engine by pressing the KEYLESS-GO start/stop button and open the driver's door (with the driver's door open, starter switch is in position **0**, same as with SmartKey removed from starter switch).
- Engage the parking brake.
- Remove blockage.
- Turn the windshield wipers on again.

If the windshield wipers fail to function at all with the combination switch in position

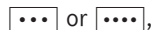

- set the combination switch to the next higher wiper speed
- have the windshield wipers checked at the nearest authorized Mercedes-Benz Center

Power windows

Opening and closing

The door windows are opened and closed electrically. The switches for all door windows are located on the driver's door control panel.

The switches for the respective door windows are located on the front passenger door and on the rear doors.

- i** Operating the rear door windows from the rear is not possible when you activate the override switch (▷ page 60).

⚠ Observe Safety notes, see page 56.

⚠ Warning!

When opening or closing the door windows, make sure there is no danger of anyone being harmed by the opening/closing procedure.

The door windows are equipped with the express operation and automatic reversal function. If in express operation mode a door window encounters an obstruction that blocks its path, the automatic reversal function will stop the door window and open it slightly.

The door windows operate differently when the switch is pulled and held. See the “Closing when a door window is blocked” section in this chapter for details.

The closing of the door windows can be immediately halted by releasing the switch or, if the switch was pulled past the resistance point and released, by either pressing or pulling the respective switch.

If a door window encounters an obstruction that blocks its path in a circumstance where you are closing the door windows by pressing and holding button  on the SmartKey or by touching and holding the sensor surface (vehicles with KEYLESS-GO) on an outside door handle, the automatic reversal function will not operate.

Activate the override switch when children are riding in the back seats of the vehicle. The children may otherwise injure themselves, e.g. by becoming trapped in the door window opening.

⚠ Warning!

Do not keep any part of your body up against the window pane when opening a window. The

downward motion of the pane may pull that part of your body down between the window pane and the door frame and trap it there. If there is a risk of entrapment, release the switch and pull it to close the window.

- i** You can also open or close the door windows using the SmartKey, see “Summer opening feature” (▷ page 107) and “Convenience closing feature” (▷ page 108).
- i** After switching off the ignition or removing the SmartKey from the starter switch, you can operate the door windows until you open the driver’s or front passenger door. If no door was opened you can operate the door windows for up to 5 minutes.



- ▶ Switch on the ignition.
- ▶ **Opening/closing:** Press or pull and hold switch ① to ④ to the resistance point. The corresponding door window moves downward or upward until you release the switch.
- ▶ **Express operation:** Press or pull switch ① to ④ past the resistance point and release. The corresponding door window opens or closes completely.
- ▶ **Stopping during express operation:** Press or pull the respective switch again.

Closing when a door window is blocked

Warning!

Make sure that nobody can become trapped and be seriously or even fatally injured when closing a door window with greater force or without automatic reversal function.

If the upward movement of a door window is blocked during the closing procedure, the door window will stop and open slightly.

- ▶ Immediately after the door window has stopped because it was blocked, pull and hold the respective switch upward until the door window is fully closed.
The door window closes with greater force.

If the door window is blocked again and opens slightly:

- ▶ Immediately after the door window was blocked, pull and hold the respective switch upward until the door window is fully closed.
The door window closes without automatic reversal function.

Warning!

Pulling and holding the switch to close the door window immediately after it had been blocked two times will cause the door window to close without any reversal function for as long as you hold the switch.

Synchronizing door windows

The door windows must be synchronized if they cannot be fully closed (express operation).

Each door window must be synchronized separately.

- ▶ Close all doors.
- ▶ Switch on the ignition.
- ▶ Pull and hold switch ①, ②, ③ or ④ (▷ page 106) until the respective door window is closed.
The door window opens again slightly.

- ▶ Pull and hold the respective switch once more immediately until the door window is closed completely.
- ▶ Hold the respective switch for approximately 1 second.
The door window is synchronized.

Summer opening feature

When the weather is warm, you can ventilate the vehicle before driving off by simultaneously

- opening the door windows
- opening the tilt/sliding sunroof
- opening the panorama roof with power tilt/sliding panel and roller sunblinds
- switching on the seat ventilation for the driver's seat



The summer opening feature can only be activated via the remote control of the SmartKey. The SmartKey must be in close proximity to the driver's outside door handle.

- ▶ Aim the transmitter eye of the SmartKey at the driver's outside door handle.
- ▶ Press button  on the SmartKey to unlock the vehicle.

Keep button  pressed until the door windows and the tilt/sliding panel of the panorama roof or the tilt/sliding sunroof have reached the desired position.

Vehicles with panorama roof with

power tilt/sliding panel: When the roller sunblinds of the panorama roof with power tilt/sliding panel are closed, the roller sunblinds will open first.

- ▶ Press button  once more until the tilt/sliding panel of the panorama roof has reached the desired position.
- ▶ Release button  on the SmartKey to interrupt the opening procedure.

Convenience closing feature

When locking the vehicle, you can simultaneously close



- the door windows
- the tilt/sliding sunroof
- the panorama roof with power tilt/sliding panel

Afterward, you can extend the roller sunblinds of the panorama roof with power tilt/sliding panel.

Warning!

When closing the door windows and the tilt/sliding sunroof or panorama roof with power tilt/sliding panel, make sure there is no danger of anyone being harmed by the closing procedure.

If potential danger exists, proceed as follows:

- Release button  to stop the closing procedure. To open, press and hold button . To continue the closing procedure after making sure that there is no danger of anyone being harmed by the closing procedure, press and hold button .

Vehicles with KEYLESS-GO:



- Release the sensor surface on the outside door handle to stop the closing procedure.
- Immediately pull on the same outside door handle and hold firmly. The door windows and the tilt/sliding sunroof or panorama roof with power tilt/sliding panel will open for as long as the door handle is held but the door not opened.

With SmartKey

The SmartKey must be in close proximity to the driver's outside door handle.

- ▶ Aim transmitter eye of the SmartKey at the driver's outside door handle.
- ▶ Press and hold button  on the SmartKey until the door windows and the tilt/sliding sunroof or panorama roof with



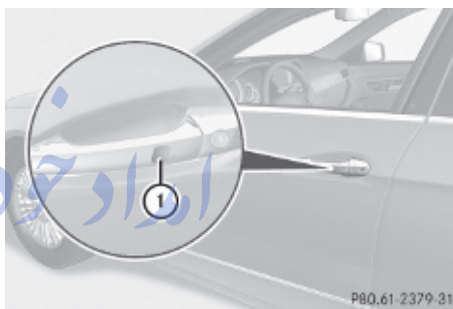

power tilt/sliding panel are closed completely.

- ▶ Release button  on the SmartKey to interrupt the closing procedure.
- ▶ **Vehicles with panorama roof with power tilt/sliding panel:** Press and hold button  on the SmartKey once more. The roller sunblinds extend.
- ▶ Release button  on the SmartKey to interrupt the extending procedure.

With KEYLESS-GO



The SmartKey with KEYLESS-GO must be located outside the vehicle within approximately 3 ft (1 m) of a door.

- ▶ Close all doors.
- ▶ Touch and hold sensor surface  on an outside door handle (▶ page 79) until the door windows and the tilt/sliding sunroof or panorama roof with power tilt/sliding panel are closed completely.
-  Make sure you are only touching sensor surface .
- ▶ Release sensor surface  on the outside door handle to interrupt the closing procedure.
- ▶ **Vehicles with panorama roof with power tilt/sliding panel:** Touch and hold

sensor surface ① on an outside door handle once more.

The roller sunblinds extend.

- ▶ Release sensor surface ① on the outside door handle to interrupt the extending procedure.

Driving and parking

Safety notes

⚠ Warning!

Make sure absolutely no objects are obstructing the pedals' range of movement. Keep the driver's footwell clear of all obstacles. If there are any floor mats or carpets in the footwell, make sure the pedals still have sufficient clearance.

During sudden driving or braking maneuvers the objects could get caught between or under the pedals. You could then no longer brake or accelerate. This could lead to accidents and injury.

⚠ Warning!

With the engine not running, there is no power assistance for the brake and steering systems. In this case, it is important to keep in mind that a considerably higher degree of effort is necessary to brake and steer the vehicle. Adapt your driving accordingly.

Starting the engine

⚠ Warning!

Inhalation of exhaust gas is hazardous to your health. All exhaust gas contains carbon monoxide (CO), and inhaling it can cause unconsciousness and possible death.

Do not run the engine in confined areas (such as a garage) which are not properly ventilated. If you think that exhaust gas fumes are entering the vehicle while driving, have the cause determined and corrected

immediately. If you must drive under these conditions, drive only with at least one window fully open at all times.

Automatic transmission

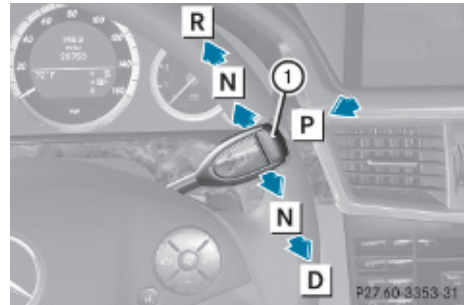

Gearshift pattern for automatic transmission

- ① Button for selecting park position P
- P Park position
- R Reverse gear
- N Neutral position
- D Drive position





Gearshift pattern for automatic transmission (E 63 AMG)

- ① Button for selecting park position P
- P Park position
- R Reverse gear
- N Neutral position
- D Drive position

For more information, see "Automatic transmission" (▷ page 114).

- ▶ Make sure the automatic transmission is in park position **P**.
The transmission position indicator in the multifunction display should be on **P** (▷ page 118).

With SmartKey

- ▶ Do not depress the accelerator pedal.
- ▶ **Gasoline engine:** Turn the SmartKey in the starter switch to position **3** (▷ page 85) and release it.
The engine starts automatically.
- ▶ **Diesel engine:** Turn the SmartKey in the starter switch to position **2** (▷ page 85).
Preglow indicator lamp  in the instrument cluster comes on.
- ▶ As soon as preglow indicator lamp  goes out, turn the SmartKey in the starter switch to position **3** and release it.
The engine starts automatically.
- i** If the engine is at operating temperature, preglow indicator lamp  may not stay on and you can start the engine without preglowing.

With KEYLESS-GO

Warning!

As long as the SmartKey is in your vehicle, the vehicle can be started. Therefore, never leave children unattended in the vehicle, as they could otherwise accidentally start the engine. When leaving the vehicle, always take the SmartKey with you and lock the vehicle. Do not leave children unattended in the vehicle, or with access to an unlocked vehicle. A child's unsupervised access to a vehicle could result in an accident and/or serious personal injury.

You can start your vehicle without the SmartKey in the starter switch using the KEYLESS-GO start/stop button.

The SmartKey must be located in the vehicle.

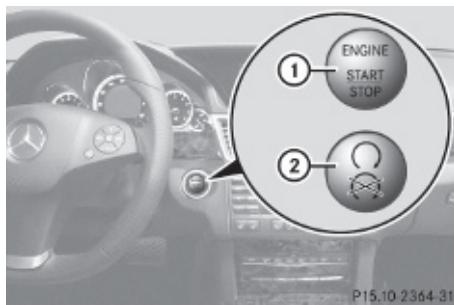

KEYLESS-GO start/stop button

- ① USA only
- ② Canada only
- ▶ Make sure the KEYLESS-GO start/stop button is inserted in the starter switch (▷ page 86).
- i** To start the engine with the SmartKey instead of the KEYLESS-GO function, remove the KEYLESS-GO start/stop button from the starter switch. Proceed as described in "With SmartKey" (▷ page 110).
- ▶ Depress the brake pedal during the starting procedure.
- ▶ Do not depress the accelerator pedal.
- ▶ **Gasoline engine:** Press the KEYLESS-GO start/stop button once.
The engine starts automatically.
- ▶ **Diesel engine:** Press the KEYLESS-GO start/stop button once.
The engine preglows and starts automatically.
- i** If the engine is at operating temperature, the time the engine needs to preglow is reduced.

Starting difficulties

- !** Remember that extended starting attempts can drain the battery.

The engine does not start. You can hear the starter.

There could be a malfunction in the engine electronics or in the fuel supply system.

Carry out the following steps:

- ▶ If you are starting the engine with the SmartKey: Turn the SmartKey in the starter switch to position **0** and repeat the starting procedure.
- ▶ If you are starting the engine with KEYLESS-GO: Close any doors that may be open to allow for better detection of the SmartKey.

or

- ▶ Remove the KEYLESS-GO start/stop button from the starter switch.
- ▶ Start the engine with the SmartKey as radio signals from another source may be interfering with the KEYLESS-GO function.
- ▶ Repeat the starting procedure.

If the engine does not start after several starting attempts:

- ▶ Contact an authorized Mercedes-Benz Center or call Roadside Assistance.

The engine does not start. You cannot hear the starter.

The battery may not be charged sufficiently.

- ▶ Get a jump start (▷ page 338).

If the engine will not start despite a jump start:

- ▶ Contact an authorized Mercedes-Benz Center or call Roadside Assistance.

The starter has been exposed to excessive temperatures.

- ▶ Let the starter cool for about 2 minutes.
- ▶ Repeat the starting procedure.

If the engine does not start after several starting attempts:

- ▶ Contact an authorized Mercedes-Benz Center or call Roadside Assistance.

Driving off

Warning!

On slippery road surfaces, never downshift in order to obtain braking action. This could result in drive wheel slip and reduced vehicle control. Your vehicle's ABS will not prevent this type of loss of control.

- ❗ Do not run a cold engine at high engine speeds. Running a cold engine at high engine speeds may shorten the service life of the engine. This is not covered by the Mercedes-Benz Limited Warranty.

E 63 AMG: At engine temperatures below 68°F (20°C), the engine's maximum speed is restricted in order to protect it from damage. Avoid driving your vehicle at full speed when the engine is cold to prevent premature engine wear and/or diminished comfort.

- ❗ If an acoustic warning sounds and the message Release Parking Brake appears in the multifunction display when driving off, you have forgotten to release the parking brake.

Release the parking brake.

- ❗ Avoid spinning of a drive wheel. This may cause serious damage to the drivetrain which is not covered by the Mercedes-Benz Limited Warranty.

- ❗ Simultaneously depressing the accelerator pedal and applying the brakes reduces engine performance and causes premature brake and drivetrain wear which is not covered by the Mercedes-Benz Limited Warranty.

- i Once the vehicle is in motion, the automatic central locking function engages and the locking knobs in the doors move down.

The automatic central locking function can be switched off (▷ page 144).

For more information on driving, see “Driving instructions” (▷ page 254).

Automatic transmission

Warning!

It is dangerous to shift the automatic transmission out of park position **P** or neutral position **N** if the engine speed is higher than idle speed. If your foot is not firmly on the brake pedal, the vehicle could accelerate quickly forward or in reverse. You could lose control of the vehicle and hit someone or something. Only shift into gear when the engine is idling normally and when your right foot is firmly on the brake pedal.

! Only shift the automatic transmission into reverse gear **R** or park position **P** when the vehicle is stopped. Otherwise the automatic transmission could be damaged.

- ▶ Depress the brake pedal.
The gear selector lever can now be used.
- ▶ Shift the automatic transmission into drive position **D** or reverse gear **R**.

i Shifting the automatic transmission out of park position **P** is only possible with the brake pedal depressed.

Without the brake pedal depressed, the gear selector lever can be moved up or down. However, the parking pawl remains engaged, not allowing shifting to occur.

- ▶ Wait for the gear selection process to complete before setting the vehicle in motion.
- ▶ If engaged, release the parking brake.
- ▶ Release the brake pedal.
- ▶ Carefully depress the accelerator pedal.

After a cold start, the automatic transmission shifts at a higher engine speed. This allows the catalytic converter (gasoline engine) or the oxidation catalyst (diesel engine) to reach its operating temperature earlier.

Problems while driving

The engine runs erratically and misfires

- **Gasoline engine:** An ignition cable may be damaged.
 - The engine electronics may not be operating properly.
 - **Gasoline engine:** Unburned gasoline may have entered the catalytic converter and damaged it.
- ▶ Give very little gas.
 - ▶ Have the problem checked at an authorized Mercedes-Benz Center as soon as possible.

The coolant temperature is above 248°F (120°C)

The coolant is too hot and is no longer cooling the engine.

- ▶ Stop the vehicle in a safe location as soon as possible.
- ▶ Turn off the engine immediately.
- ▶ Allow the engine and coolant to cool off.
- ▶ Check the coolant level and add coolant if necessary (▷ page 226).

In case of accident

If the vehicle is leaking fuel:

- ▶ Do not start the engine under any circumstances.
- ▶ Exit the vehicle at a safe distance from the roadway.
- ▶ Notify local fire and/or police authorities.

If the extent of the damage cannot be determined:

- ▶ Contact an authorized Mercedes-Benz Center or call Roadside Assistance.

If no damage on major assemblies, fuel system, and engine mount can be determined:

- Start the engine in the usual manner.

Parking

⚠ Warning!

Do not park this vehicle in areas where combustible materials such as grass, hay or leaves can come into contact with the hot exhaust system. These materials could be ignited and cause a vehicle fire.

Vehicle movement may result in serious personal injury or damage to the vehicle or vehicle drivetrain. Therefore, always do the following before turning off the engine and leaving the vehicle:

- Keep right foot on the brake pedal.
- Engage the parking brake.
- Shift the automatic transmission into park position **P**.
- Slowly release the brake pedal.
- When parked on an incline, always turn the front wheels towards the road curb.
- Turn the SmartKey in the starter switch to position **0** and remove the SmartKey from the starter switch, or press the KEYLESS-GO start/stop button.
- Take the SmartKey with you and lock the vehicle when leaving.

⚠ Warning!

When leaving the vehicle, always remove the SmartKey from the starter switch, take it with you, and lock the vehicle. Do not leave children unattended in the vehicle, or with access to an unlocked vehicle. Children could release the parking brake and/or shift the automatic transmission out of park position **P**, either of which could result in an accident and/or serious personal injury.

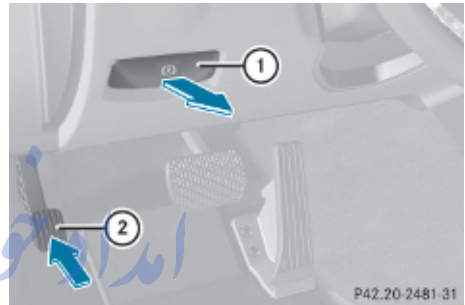

- **Releasing:** Pull on release handle ①. When the ignition is switched on or the engine is running, the brake warning lamp **BRAKE** (USA only) or **(D)** (Canada only) in the instrument cluster goes out.
- **Engaging:** Step on parking brake pedal ② firmly. When the engine is running, the brake warning lamp **BRAKE** (USA only) or **(D)** (Canada only) in the instrument cluster comes on.

Parking brake

⚠ Warning!

Engaging the parking brake while the vehicle is in motion can cause the rear wheels to lock up. You could lose control of the vehicle and cause an accident. In addition, the vehicle's brake lights do not light up when the parking brake is engaged.

Turning off the engine

⚠ Warning!

Do not turn off the engine before the vehicle has come to a complete stop. With the engine not running, there is no power assistance for the brake and steering systems. In this case, it is important to keep in mind that a considerably higher degree of effort is necessary to brake and steer the vehicle.

- ▶ Shift the automatic transmission into park position **P** (▷ page 116).
- ▶ Engage the parking brake.
- i** Always engage the parking brake in addition to shifting the automatic transmission into park position **P**.
- i** Observe instructions if you want the automatic transmission to remain in neutral position **N**, see “Remaining in neutral position **N**” (▷ page 115).

With SmartKey

- ▶ Turn the SmartKey in the starter switch to position **0**.
- ▶ Remove the SmartKey from the starter switch.

When you turn off the engine using the SmartKey, and remove the SmartKey from the starter switch or open a front door, the automatic transmission will shift into park position **P** automatically.

Warning!

Keep in mind that turning off the engine alone only will shift the automatic transmission into neutral position **N** automatically.

Always shift the automatic transmission into park position **P** before turning off the engine. Otherwise the vehicle could roll away which could result in an accident and/or serious personal injury.

With KEYLESS-GO

- ▶ Press the KEYLESS-GO start/stop button. With the driver's door closed, the starter switch is now in position **1**. With the driver's door opened, the starter switch is set to position **0**, same as the SmartKey removed from the starter switch (▷ page 85).

When you turn off the engine using the KEYLESS-GO start/stop button and open a front door, the automatic transmission will shift into park position **P** automatically.

Warning!

Keep in mind that turning off the engine alone only will shift the automatic transmission into neutral position **N** automatically.

Always shift the automatic transmission into park position **P** before turning off the engine.

Otherwise the vehicle could roll away which could result in an accident and/or serious personal injury.

- i** In an emergency you can turn off the engine while driving by pressing and holding the KEYLESS-GO start/stop button for approximately 3 seconds.

If you have started the engine with the KEYLESS-GO start/stop button and cannot turn it off as described above:

- ▶ Remove the KEYLESS-GO start/stop button from the starter switch.
- ▶ Insert the SmartKey into the starter switch. The engine turns off. The starter switch is in position **0** (▷ page 85).

Automatic transmission

Introduction

For information on driving with an automatic transmission, see “Driving and parking” (▷ page 109).

Warning!

Make sure absolutely no objects are obstructing the pedals' range of movement. Keep the driver's footwell clear of all obstacles. If there are any floor mats or carpets in the footwell, make sure the pedals still have sufficient clearance.

During sudden driving or braking maneuvers the objects could get caught between or under the pedals. You could then no longer brake or accelerate. This could lead to accidents and injury.

تلفن شماره روزی: ۰۲۱-۸۸۶۲۰۸۵

pharmasoc.com

! Allow the engine to warm up under low load use. Do not place full load on the engine until the operating temperature has been reached.

Avoid spinning of a drive wheel for an extended period when driving off on slippery road surfaces.

This may cause serious damage to the engine and the drivetrain which is not covered by the Mercedes-Benz Limited Warranty.

i During the brief warm-up, transmission upshifting is delayed. This allows the catalytic converter (gasoline engine) or oxidation catalyst (diesel engine) to heat up more quickly to operating temperature.

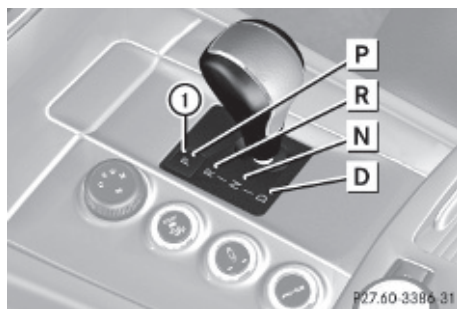

Gearshift pattern for automatic transmission (E 63 AMG)

- ① Button for selecting park position **P**
- P** Park position
- R** Reverse gear
- N** Neutral position
- D** Drive position

Gear selector lever

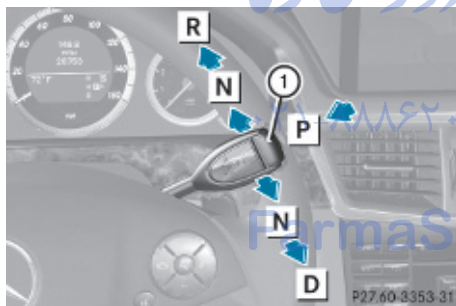

Gearshift pattern for automatic transmission

- ① Button for selecting park position **P**
- P** Park position
- R** Reverse gear
- N** Neutral position
- D** Drive position

⚠ Warning!

It is dangerous to shift the automatic transmission out of park position **P** or neutral position **N** if the engine speed is higher than idle speed. If your foot is not firmly on the brake pedal, the vehicle could accelerate quickly forward or in reverse. You could lose control of the vehicle and hit someone or something. Only shift into gear when the engine is idling normally and when your right foot is firmly on the brake pedal.

! The vehicle must be stopped when you shift the automatic transmission

- directly between drive position **D** and reverse gear **R**
- directly between reverse gear **R** and drive position **D**
- directly into park position **P**

Otherwise the automatic transmission could be damaged.

When trying to free a vehicle stuck in mud or snow, see “Rocking the vehicle”

(▷ page 120).

- Shifting the automatic transmission out of park position **P** is only possible with the brake pedal depressed.

Without the brake pedal depressed, the gear selector lever can be moved up or down, but the parking pawl remains engaged, not allowing shifting to occur.

- The gear selector lever always returns to its original position.

The current transmission position **P**, **R**, **N**, or **D** appears in the multifunction display (▷ page 118).

E 63 AMG only: There are additional indicators on the cover of the shifting gate showing the current gear selector lever position.

The indicators come on when you insert the SmartKey into the starter switch, and go out when you remove the SmartKey from the starter switch.

Warning!

Keep in mind that turning off the engine alone only will shift the automatic transmission into neutral position **N** automatically.

Always shift the automatic transmission into park position **P** before turning off the engine.

Otherwise the vehicle could roll away which could result in an accident and/or serious personal injury.

- Moving the gear selector lever up or down shifts the automatic transmission out of park position **P**.

All models except E 63 AMG: Shifting into park position P

- With the vehicle at a standstill, press button  on the gear selector lever.

SmartKey: When you turn off the engine using the SmartKey, and remove the SmartKey from the starter switch or open a front door, the automatic transmission will shift into park position **P** automatically.

KEYLESS-GO: When you turn off the engine using the KEYLESS-GO start/stop button and open a front door, the automatic transmission will shift into park position **P** automatically.

Warning!

Keep in mind that turning off the engine alone only will shift the automatic transmission into neutral position **N** automatically.

Always shift the automatic transmission into park position **P** before turning off the engine.

Otherwise the vehicle could roll away which could result in an accident and/or serious personal injury.

- Moving the gear selector lever up or down shifts the automatic transmission out of park position **P**.

HOLD function or DISTRONIC PLUS:

The automatic transmission will shift into park position **P** automatically when HOLD function or DISTRONIC PLUS brings your vehicle to standstill. In addition, at least one of the following conditions must be met:

- The engine is turned off.
- The driver's door is opened and the seat belt is not inserted in the seat belt buckle.

E 63 AMG: Shifting into park position P



- With the vehicle at a standstill, press button  on the gearshift pattern.

⚠ Warning!

Keep in mind that turning off the engine alone only will shift the automatic transmission into neutral position **N** automatically.

Always shift the automatic transmission into park position **P** before turning off the engine.

Otherwise the vehicle could roll away which could result in an accident and/or serious personal injury.

Shifting into neutral position N

- ▶ With the vehicle at a standstill, depress the brake pedal.
- ▶ Move the gear selector lever up or down to the resistance point to select neutral position **N**.

When you turn off the engine, the automatic transmission will shift into neutral position **N** automatically.

SmartKey: Removing the SmartKey from the starter switch or opening a front door after turning off the engine will shift the automatic transmission into park position **P** automatically.

KEYLESS-GO: Opening a front door after turning off the engine will shift the automatic transmission into park position **P** automatically.

Remaining in neutral position N

If you want the automatic transmission to remain in neutral position **N**, e.g. when taking the vehicle through an automatic conveyor-type car wash, observe the following instructions.

⚠ Warning!

When leaving the SmartKey in the starter switch, do not leave children unattended in the vehicle. It is possible for children to switch on the ignition which could result in unsupervised use of vehicle equipment. Unsupervised use of vehicle equipment could result in an accident and/or serious personal injury.

With SmartKey:

- ▶ Make sure the ignition is switched on.
- ▶ With the vehicle at a standstill, depress the brake pedal and keep it pressed.
- ▶ Shift the automatic transmission into neutral position **N**.
- ▶ Release the brake pedal.
- ▶ If engaged, release the parking brake.
- ▶ Switch off the ignition and leave the SmartKey in the starter switch.

With KEYLESS-GO:

- ▶ Make sure the ignition is switched on.
- ▶ With the vehicle at a standstill, depress the brake pedal and keep it pressed.
- ▶ Shift the automatic transmission into park position **P**.
- ▶ Release the brake pedal.
- ▶ Remove the KEYLESS-GO start/stop button from the starter switch.
- ▶ Insert the SmartKey into the starter switch.
- ▶ Switch on the ignition.
- ▶ Depress the brake pedal and keep it pressed.
- ▶ Shift the automatic transmission into neutral position **N**.
- ▶ Release the brake pedal.
- ▶ If engaged, release the parking brake.
- ▶ Switch off the ignition and leave the SmartKey in the starter switch.

Shifting into reverse gear R

- ▶ With the vehicle at a standstill, depress the brake pedal.
- ▶ Move the gear selector lever up past the resistance point.

Shifting into drive position D

- ▶ With the vehicle at a standstill, depress the brake pedal.
- ▶ Move the gear selector lever down past the resistance point.

Shifting procedure

The automatic transmission selects individual gears automatically, depending on

- the selected gear range (▷ page 120)
- the selected program mode:
 - C/S** (▷ page 120)
 - or
 - M** (E 63 AMG only) (▷ page 122)
- the position of the accelerator pedal
- the vehicle speed

With drive position **D** selected, you can influence transmission shifting by

- limiting the gear range
- extending the gear range
- changing the gears manually (E 63 AMG only)

E 63 AMG: Double-clutching is active when downshifting in all program modes. Double-clutching reduces load-alteration effects and supports sporty driving. The degree to which you perceive double-clutching acoustically varies depending on the selected program mode.

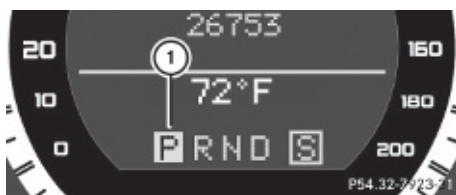

E 63 AMG

- ① Transmission position indicator

If the current transmission position does not appear in the multifunction display due to a malfunction, for example, make sure that the automatic transmission is in the desired position.

- ▶ Shift the automatic transmission into drive position **D**.
- ▶ Select automatic program mode **C**.
- ▶ Do not limit the gear range.
- ▶ Drive off carefully.

Transmission positions

The current transmission position appears in the multifunction display.



All models except E 63 AMG

- ① Transmission position indicator

Effect**P****Park position**

Shift the automatic transmission into park position **P** only when the vehicle is stopped. The park position is not intended to serve as a brake when the vehicle is parked. Rather, the driver should always engage the parking brake in addition to shifting the automatic transmission into park position **P** to secure the vehicle.

The SmartKey can only be removed from the starter switch with the gear selector lever in park position **P**. With the SmartKey removed from the starter switch, the gear selector lever is locked in park position **P**.

If the vehicle's electrical system is malfunctioning, the automatic transmission could remain locked in park position **P**.

- ▶ Have the vehicle's electrical system checked at an authorized Mercedes-Benz Center as soon as possible.

R**Reverse gear**

Shift the automatic transmission into reverse gear **R** only when the vehicle is stopped.

Effect**N****Neutral position**

No power is transmitted from the engine to the drive axle. When the brakes are released, the vehicle can be moved freely (pushed or towed).

To avoid damage to the transmission, never shift the automatic transmission into neutral position **N** while driving.

Exception: If the ESC is switched off or malfunctioning, shift the automatic transmission into neutral position **N** if the vehicle is in danger of skidding.

! Coasting the vehicle, or driving for any other reason with the automatic transmission in neutral position **N** can result in transmission damage that is not covered by the Mercedes-Benz Limited Warranty.

D**Drive position**

The automatic transmission shifts automatically. All forward gears are available.

Driving tips**Kickdown**

Use the kickdown when you want maximum acceleration.

▶ **U.S. vehicles except AMG vehicles:**

Fully depress the accelerator pedal. Depending on the engine speed the automatic transmission shifts into a lower gear.

▶ **Canada vehicles and AMG vehicles:**

Depress the accelerator pedal past the point of resistance. Depending on the engine speed the automatic transmission shifts into a lower gear.

Rocking the vehicle

Rocking the vehicle by shifting the automatic transmission directly between drive position **D** and reverse gear **R** can help free a vehicle stuck in mud or snow. The engine control system of this vehicle electronically limits directly shifting the automatic transmission between drive position **D** and reverse gear **R** to very low speeds, i.e. approximately 5 mph (9 km/h). To shift the automatic transmission directly between drive position **D** and reverse gear **R**, move the gear selector lever up or down past the resistance point.

Working on the vehicle

Warning!

When working on the vehicle, engage the parking brake and shift the automatic transmission into park position **P**. Otherwise the vehicle could roll away which could result in an accident and/or serious personal injury.

Gear ranges

With the automatic transmission in drive position **D**, you can limit or extend the gear range, see “One-touch gearshifting” (▷ page 121).

The current gear range appears in the multifunction display.



All models except E 63 AMG

① Gear range indicator

The current gear range appears in the multifunction display.



E 63 AMG

① Gear range indicator

Effect

- | | Effect |
|---|--|
| 3 | With this selection you can use the braking effect of the engine. |
| 2 | Allows the use of the engine's braking effect when driving <ul style="list-style-type: none"> • on steep downgrades • in mountainous regions • under extreme operating conditions |
| 1 | For maximum use of the engine's braking effect on very steep or lengthy downgrades. |

Automatic shift program

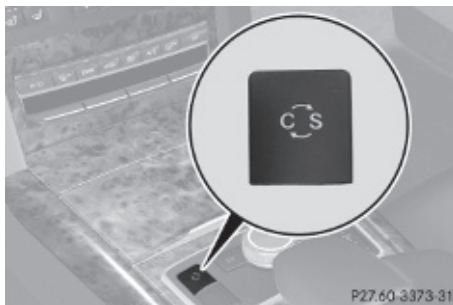

Program mode selector switch on all models except E 63 AMG

C Comfort	For comfort driving
S Sport	For sporty driving



Program mode selector dial on E 63 AMG

C Comfort	For standard driving
S Sport	For sporty driving
S+ Sport Plus	For sporty driving with shorter shift times
M Manual	For manual gearshifting (▷ page 122)
RS RACE START	For optimum acceleration from a standing start

- ❗ Program mode **RS** cannot be selected while driving. For more information, see “RACE START (E 63 AMG)” (▷ page 159).

The current program mode appears in the multifunction display.

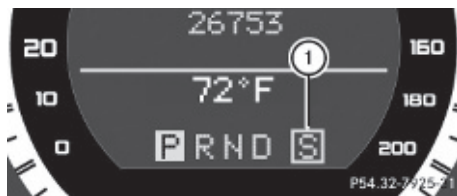

E 63 AMG

- ① Program mode indicator

- ❗ **E 63 AMG:** In addition, the currently selected program mode is indicated in red on the program mode selector dial.

You should only change the program mode when the automatic transmission is in park position **P**.

Automatic program mode **S** will not be stored. When the engine is turned off with the automatic program mode **S** selected, the automatic transmission will go to the automatic program mode **C** when the engine is restarted.

E 63 AMG: Automatic program mode **S+** will not be stored. When the engine is turned off with automatic program mode **S+** selected, the automatic transmission will go to automatic program mode **C** when the engine is restarted.

▶ **All models except E 63 AMG:** Press the program mode selector switch repeatedly until the letter of the desired program mode appears in the right multifunction display.

▶ **E 63 AMG:** Turn the program mode selector dial until the letter of the desired program mode appears in the right multifunction display.

Selecting program mode **C** means:

- The vehicle starts out more gentle, both forward and reverse, except when driving off with full throttle.
- Traction and driving stability are improved on icy roads.
- Upshifts occur earlier even when you give more gas. The engine then operates at lower revolutions and the wheels are less likely to spin.

Selecting program mode **S** means that upshifts occur later.

One-touch gearshifting

With the automatic transmission in drive position **D**, you can limit or extend the gear range using the steering wheel gearshift control.

E 63 AMG: You only can limit or extend the gear range when driving in automatic program mode **C**, **S**, or **S+**. For information on using the steering wheel gearshift control in

manual program mode **M**, see “Manual shift program” (▷ page 122).

E 63 AMG: For information on using the steering wheel gearshift control in manual program mode **M**, see “Manual shift program” (▷ page 122).

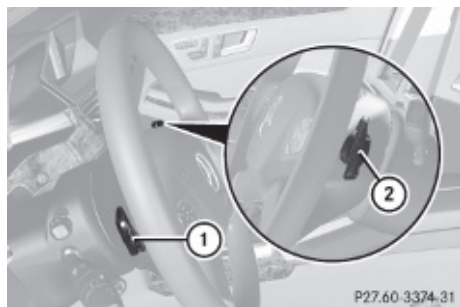

Steering wheel gearshift control (example illustration)

- i** You cannot shift with the steering wheel gearshift control when the automatic transmission is in park position **P**, neutral position **N**, or reverse gear **R**.

Limiting gear range

Warning!

On slippery road surfaces, never downshift in order to obtain braking action. This could result in drive wheel slip and reduced vehicle control. Your vehicle's ABS will not prevent this type of loss of control.

- ▶ Briefly pull left gearshift control ①. The automatic transmission will shift into the next lower gear as permitted by the shift program. This action simultaneously limits the gear range of the automatic transmission.
- i** To avoid overrevving the engine when downshifting, the automatic transmission will not shift into a lower gear if the engine's maximum speed would be exceeded.

Extending gear range

- ▶ Briefly pull right gearshift control ②. The automatic transmission will shift into the next higher gear as permitted by the shift program. This action simultaneously extends the gear range of the automatic transmission.

- i** If you press on the accelerator pedal when the engine has reached the revolution limit of the current gear range, the automatic transmission will upshift beyond any gear range limit selected.

Canceling gear range limit

- ▶ Pull and hold right gearshift control ② until the gear range indicator disappears from the multifunction display. The automatic transmission will shift from the current gear range directly into drive position **D**.

Shifting into optimal gear range

- ▶ Pull and hold left gearshift control ①. The automatic transmission will select the gear range suited for optimal acceleration and deceleration automatically. This will involve shifting down one or more gears.

Manual shift program

The manual shift program is available on E 63 AMG only.

Manual program mode **M** differs with regard to spontaneity, response time, and shifting smoothness from automatic program modes **S** or **S+**.

In manual program mode **M**, system-controlled automatic gearshifting is switched off. You need to change the gears by manually upshifting or downshifting using the steering wheel gearshift control.



Program mode selector dial on E 63 AMG

C Comfort	For standard driving
S Sport	For sporty driving
S+ Sport Plus	For sporty driving with shorter shift times
M Manual	For manual gearshifting
RS RACE START	For optimum acceleration from a standing start

i Program mode **RS** cannot be selected while driving. For more information, see “RACE START (E 63 AMG)” (▷ page 159).

The current program mode appears in the multifunction display (▷ page 121).

For information on automatic program mode (**C** or **S**), see “Automatic shift program” (▷ page 120) and “One-touch gearshifting” (▷ page 121).

Activating manual shift program

► Turn the program mode selector dial until **M** appears in the multifunction display. The automatic transmission switches to manual program mode **M**. Automatic shifting is switched off. The gear range is not limited.

You can change the gears manually with drive position **D** selected. You can upshift or downshift through the gears in succession.

i Manual program mode **M** will not be stored. When the engine is turned off with manual program mode **M** selected, the automatic transmission will go to automatic program mode **C** when the engine is restarted.

Upshifting

! In manual program mode **M**, the automatic transmission will not upshift, even if the engine has reached its overrevving range. Shift up into the next gear before the engine has reached its overrevving range. Make absolutely certain that the engine speed does not reach the red marking on the tachometer. Otherwise the engine could be damaged which is not covered by the Mercedes-Benz Limited Warranty.

► Briefly pull right gearshift control ② (▷ page 122).

The automatic transmission shifts into the next higher gear.

Upshift indicator

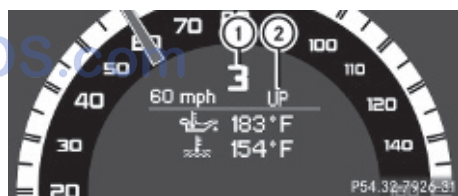

In manual program mode **M**, upshift indicator ② in the multifunction display advises you to upshift before the engine reaches the overspeed range. Thus you can drive at the maximum engine speed for each gear without overrevving the engine.

► Shift the automatic transmission from current gear ① into the next higher gear. The fuel supply will otherwise be interrupted to prevent the engine from overrevving.

Downshifting

Warning!

On slippery road surfaces, never downshift in order to obtain braking action. This could result in drive wheel slip and reduced vehicle control. Your vehicle's ABS will not prevent this type of loss of control.

- ▶ Briefly pull left gearshift control ① (▷ page 122).
The automatic transmission shifts into the next lower gear.
- i** When you brake or stop, the automatic transmission shifts down into a gear from which you can easily accelerate or take off.

Kickdown

Using the kickdown while driving in manual program mode **M** is not possible.

Deactivating manual shift program

- ▶ Turn the program mode selector dial until **C** or **S** appears in the multifunction display.

or

- ▶ Restart the engine.
The automatic transmission will go to automatic program mode **C**.

Manual program mode **M** is not stored.

Emergency operation (limp-home mode)

If vehicle acceleration becomes less responsive or sluggish or the automatic transmission no longer shifts, the automatic transmission is most likely operating in limp-home (emergency operation) mode. In this mode only second gear and reverse gear **R** can be selected.

- ▶ Stop the vehicle in a safe location.
- ▶ Shift the automatic transmission into park position **P**.
- ▶ Turn off the engine.

- ▶ Wait at least 10 seconds before restarting.
- ▶ Restart the engine.
- ▶ Shift the automatic transmission into drive position **D** (for second gear) or reverse gear **R**.
- ▶ Have the automatic transmission checked at an authorized Mercedes-Benz Center as soon as possible.

Transfer case

This section applies to vehicles equipped with all-wheel drive (4MATIC) only. Both the front and rear axles are powered at all times when the vehicle is being operated.

- !** Only conduct operational or performance tests on a two-axle dynamometer. If such tests are necessary, contact an authorized Mercedes-Benz Center. You could otherwise seriously damage the brake system or the transfer case which is not covered by the Mercedes-Benz Limited Warranty. *تلفن شیانہ*

- !** Because the ESC operates automatically, the engine and ignition must be shut off (SmartKey in starter switch position **0**, or **1**, or KEYLESS-GO start/stop button in position **0**, or **1**) when

- the parking brake is being tested on a brake test dynamometer
- towing the vehicle with the front or rear axle raised (not permissible for vehicles with 4MATIC)

Active braking action through the ESC may otherwise seriously damage the brake system which is not covered by the Mercedes-Benz Limited Warranty.

Instrument cluster

Introduction

For a full view illustration of the instrument cluster, see “Instrument cluster” (▷ page 28).

Warning!

No messages will be displayed if either the instrument cluster or the multifunction display is inoperative.

As a result, you will not be able to see information about your driving conditions, such as

- speed
- outside temperature
- warning/indicator lamps
- malfunction/warning messages
- failure of any systems

Driving characteristics may be impaired.

If you must continue to drive, do so with added caution. Contact an authorized Mercedes-Benz Center as soon as possible.

The language setting for the multifunction display can be changed via COMAND, see separate operating instructions.

Activating the instrument cluster

The instrument cluster is activated when you

- open the driver's door
- switch on the ignition
- switch on the exterior lamps

Adjusting the instrument cluster illumination

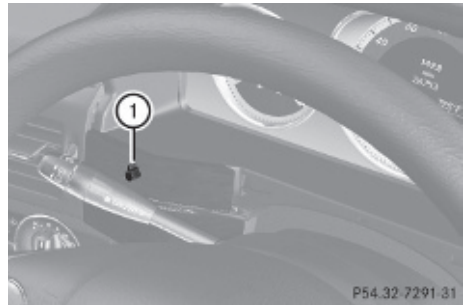

► **To brighten illumination:** Turn dimmer ① clockwise.

► **To dim illumination:** Turn dimmer ① counterclockwise.

 The instrument cluster illumination is dimmed or brightened automatically to suit ambient light conditions.

Coolant temperature gauge

The coolant temperature gauge is located on the right side in the instrument cluster (▷ page 28).

Warning!

Driving when your engine is overheated can cause some fluids which may have leaked into the engine compartment to catch fire. You could be seriously burned.

Steam from an overheated engine can cause serious burns which can occur just by opening the engine hood. Stay away from the engine if you see or hear steam coming from it.

Stop the vehicle in a safe location away from other traffic. Turn off the engine, get out of the vehicle and do not stand near the vehicle until the engine has cooled down.

During severe operating conditions, e.g. stop-and-go traffic, the coolant temperature may rise close to 248°F (120°C), i.e. close to the red zone of the temperature gauge.

! Excessive coolant temperature triggers a warning in the multifunction display.

The engine should not be operated with a coolant temperature above 248°F (120°C), i.e. in the red zone of the coolant temperature gauge. Doing so may cause serious engine damage which is not covered by the Mercedes-Benz Limited Warranty.

Tachometer

The red marking on the tachometer (▷ page 28) denotes excessive engine speed.

! Avoid driving at excessive engine speeds, as it may result in serious engine damage that is not covered by the Mercedes-Benz Limited Warranty.

To help protect the engine, the fuel supply is interrupted if the engine is operated within the red marking.

Outside temperature indicator

The outside temperature indicator is displayed in the multifunction display (▷ page 128).

! Warning!

The outside temperature indicator is not designed to serve as an ice-warning device and is therefore unsuitable for that purpose. Indicated temperatures just above the freezing point do not guarantee that the road surface is free of ice. The road may still be icy, especially in wooded areas or on bridges.

Fuel gauge

The fuel gauge is on the left-hand side of the instrument cluster (▷ page 28). Once the fuel level has fallen below the reserve mark, the yellow fuel tank reserve warning lamp  for the fuel reserve comes on.

Control system

Introduction

The control system is activated as soon as the starter switch is in position **2**.

The control system enables you to call up information about your vehicle and to change vehicle settings.

For example, you can use the control system to find out when your vehicle is next due for maintenance service, to call up statistical data on your vehicle, and much more.

! Warning!

A driver's attention to the road and traffic conditions must always be his/her primary focus when driving.

For your safety and the safety of others, selecting features through the multifunction steering wheel should only be done by the driver when traffic and road conditions permit it to be done safely.







Bear in mind that at a speed of just 30 mph (approximately 50 km/h), your vehicle is covering a distance of 44 feet (approximately 14 m) every second.

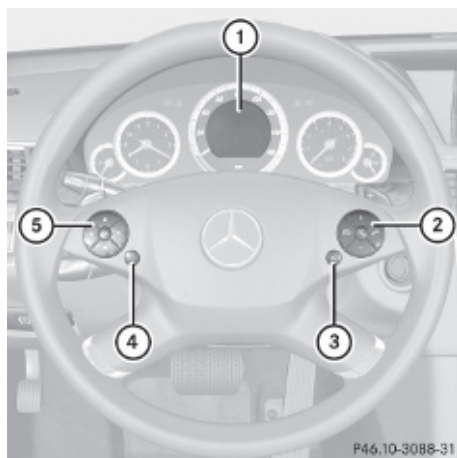







The control system relays information to the multifunction display.

Multifunction steering wheel

The displays in the multifunction display and the settings in the control system are controlled by using the buttons on the multifunction steering wheel.



①	Multifunction display
②	Press button  to end a call to reject an incoming call  to answer a call to dial ⁹ to redial ⁹  to mute
	Press button  to set the volume  to operate the RACETIMER ¹⁰
③	Press button  to activate the Voice Control System ¹¹
④	Press button briefly  to cancel the Voice Control System ¹¹ to go back to confirm messages

	Press and hold button  to select the standard display
⑤	Press button  to call up line for menus and to  select menus
	Press button briefly  to select submenu or scroll  through lists within Audio menu to select previous or next track, scene or stored station within Tel menu to switch to the phone book and select a name or number
	Press and hold button  within Audio menu to select a  track or scene with quick search or to select previous or next station in station list or wave band within Tel menu to start the quick search in the phone book
	Press button  to confirm selection or messages

Depending on the selected menu, pressing the buttons on the multifunction steering wheel will alter what appears in the multifunction display.

The information available in the multifunction display is arranged in menus and accompanying functions and submenus.

The individual functions are then found within the relevant menu (radio or CD operations under Audio, for example). These functions

⁹ Function only available in telephone menu.

¹⁰ AMG vehicles only.

¹¹ Function only available in vehicles with Voice Control System.











serve to call up relevant information or to customize the settings for your vehicle.

It is helpful to think of the menus, and the functions within each menu, as being arranged in a circular pattern.

In the **Sett.** menu, instead of functions, you will find a number of submenus, as being arranged in a circular pattern. For instructions on using these submenus, see “Settings menu” (> page 139).

The number of menus available in the system depends on which optional equipment is installed in your vehicle.

Using the control system

- ▶ **To select a menu:** Press button  or .
 - ▶ **To select a submenu:** Press button  or .
 - ▶ **To go to the next higher menu level:** Press button .
 - ▶ **To select the standard display:** Press button  repeatedly until the standard display featuring the odometer and speedometer appears.
- or
- ▶ Press and hold button  until the standard display featuring the trip odometer and the main odometer appears.
 - ▶ **To confirm selection:** Press button .
 - ▶ **To confirm display message:** Press button  or .
- The control system saves certain display messages. Calling up display messages (> page 139).

For information about warning and malfunction messages appearing in the multifunction display (> page 272).

Multifunction display

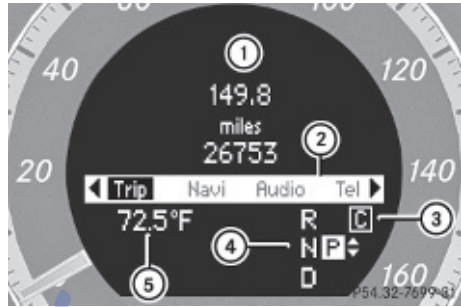

- ① Text field
- ② Line for main menu
- ③ Automatic transmission program mode indicator
- ④ Transmission position/gear range indicator
- ⑤ Outside temperature indicator/additional speedometer

Settings, functions, submenus as well as any malfunctions appear in the text field.

For more information on menus displayed in the multifunction display, see “Menus and submenus” (> page 129).

- ❗ **E 63 AMG:** The lower part of the multifunction display will vary from the the multifunction display shown. For more information, see (> page 118).

Menus and submenus

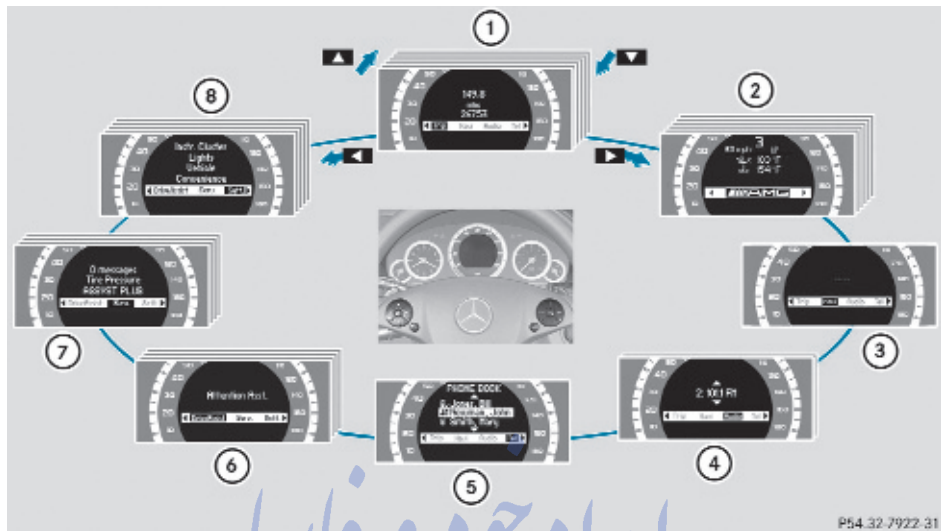

P54.32.7922.31

Function

- | | Function |
|---|---|
| ① | Trip menu (▷ page 129) |
| ② | AMG¹² menu (▷ page 131) |
| ③ | Navi menu (▷ page 134) |
| ④ | Audio menu (▷ page 134) |
| ⑤ | Tel menu (▷ page 135) |
| ⑥ | Assistance menu (▷ page 137) |
| ⑦ | Service menu (▷ page 138) |
| ⑧ | Settings menu (▷ page 139) |

The following information is available:

- Standard display (▷ page 129)
- Fuel consumption statistics since start (▷ page 130)
- Fuel consumption statistics since last reset (▷ page 130)
- Resetting values (▷ page 130)
- Remaining driving range and current fuel consumption (▷ page 131)
- Digital Speedometer (▷ page 131)

Standard display

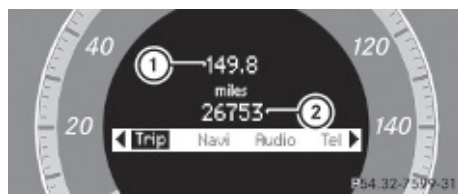

P54.32.7599.31



Trip menu

In the Trip menu, you can show an additional display for the speedometer and call up or reset your vehicle's statistical data.

In the standard display, the trip odometer ① and the main odometer ② appear in the multifunction display.

¹² AMG vehicles only.

If another display appears instead of the standard display:

► Press button  or  to select the Trip menu.

or



► Press button  repeatedly until the standard display appears.

or

► Press and hold button  until the standard display appears.

Fuel consumption statistics since start

► Press button  or  to select the Trip menu.

► Press button  or  to select From Start.

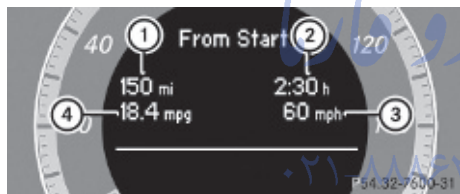



- ① Distance driven since start
- ② Time elapsed since start
- ③ Average speed since start
- ④ Average fuel consumption since start

All statistics stored since the last engine start will be reset approximately 4 hours after the SmartKey in the starter switch is turned to position 0 or removed from the starter switch. Resetting will not occur if you turn the SmartKey back to position 1 or 2 within this time period.

The fuel consumption statistics since start reset automatically to 0 after 9 999 miles or 999 hours, whichever occurs first.

Fuel consumption statistics since last reset

► Press button  or  to select the Trip menu.

► Press button  or  to select From Reset.

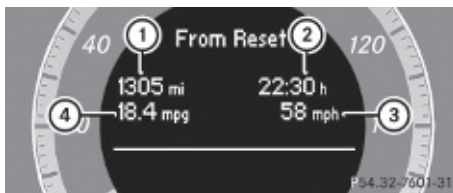



- ① Distance driven since last reset
- ② Time elapsed since last reset
- ③ Average speed since last reset
- ④ Average fuel consumption since last reset



The fuel consumption statistics since last reset reset automatically to 0 after 99 999 miles or 9 999 hours, whichever occurs first.

Resetting values

You can reset the values for the following functions:

- Trip odometer
- Fuel consumption statistics since start
- Fuel consumption statistics since last reset

► Press button  or  to select the Trip menu.

► Press button  or  to select the function you wish to reset.

► Press button .

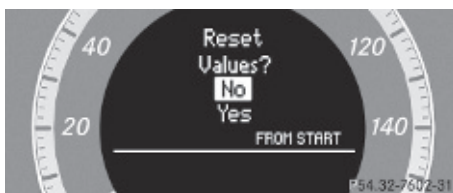

Example illustration: Reset fuel consumption statistics since start

- ▶ Press button to select Yes.
- ▶ Press button to confirm.

Remaining driving range and current fuel consumption

- ▶ Press button or to select the Trip menu.
- ▶ Press button or to select the estimated remaining driving range and current fuel consumption display. Note that the values are calculated based on the current fuel tank level and the current driving style. Make sure to refuel in time.

If only very little fuel is left in the tank, a vehicle at the fuel pump  appears instead of the estimated remaining driving range.

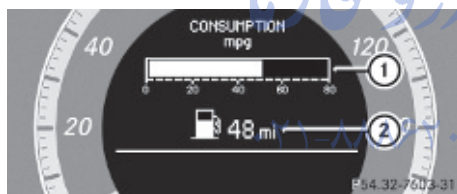

- ① Current fuel consumption¹³
- ② Estimated remaining driving range

Digital speedometer

- ▶ Press button or to select the Trip menu.
- ▶ Press button or to select the digital speedometer.

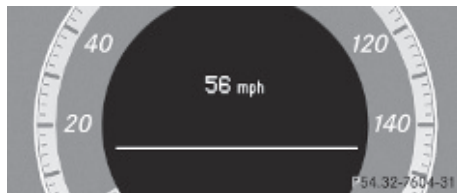

AMG menu

This function is only available in AMG vehicles.

- ▶ Press button or to select the AMG menu.

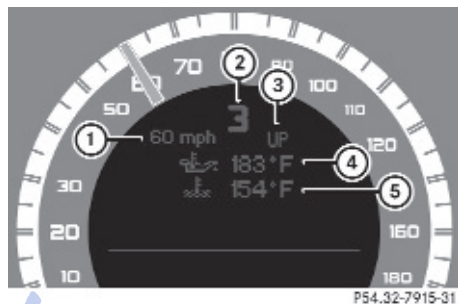

- ① Digital speedometer
- ② Gear indicator
- ③ Upshift indicator
- ④ Engine oil temperature indicator
- ⑤ Coolant temperature indicator

The engine oil temperature flashes if the engine oil temperature has not yet reached 176°F (80°C). During this time, avoid driving at full engine speed.



The upshift indicator ③ indicates that the engine has reached the overrevving range. The upshift indicator ③ blocks other messages in the multifunction display until you have shifted up.

Use buttons or to select the following functions in the AMG menu:

- SETUP (▷ page 132)
- RACETIMER (▷ page 132)
- Overall analysis (▷ page 133)
- Lap analysis (▷ page 133)

¹³ Not available on AMG vehicles.

SETUP

- ▶ Press button  or  to select the AMG menu.
 - ▶ Press button  to select SETUP.
- or
- ▶ Tap the AMG button on the center console (▷ page 165).

i You can store and call up automatic transmission program mode and suspension style settings with the AMG button on the center console. For more information, see (▷ page 165).





- ① Automatic transmission program mode indicator
- ② ESC mode indicator
- ③ Suspension style indicator

RACETIMER

Warning!

The RACETIMER feature is only for use on roads and in conditions where high speed driving is permitted. Racing on public roads is prohibited under all circumstances. The driver is and must always remain responsible for following posted speed limits.

The RACETIMER allows you to time and save driving stretches.

- ▶ Press button  or  to select the AMG menu.
- ▶ Press button  repeatedly until the RACETIMER appears in the multifunction display.





- ① RACETIMER
- ② Lap number

You can start the RACETIMER when the engine is running or the starter switch is in position **2** (▷ page 85).

While the RACETIMER is being displayed, you cannot adjust the audio volume using buttons

 or .



- ▶ **Starting:** Press button .
- ▶ **Displaying intermediate time:** Press button  while the timer is running. The intermediate time is shown for 5 seconds. تلفن شسا.

- ▶ **Stopping:** Press button .

When you stop the vehicle and turn the SmartKey to position **1** (▷ page 85) or, in vehicles with KEYLESS-GO, turn off the engine and do not open the driver's door, the RACETIMER stops timing. Timing is resumed when you press button  after switching the ignition back on or restarting the engine.

Saving lap time and starting a new lap

You can save up to 16 laps.

- ▶ Press button  while the timer is running. The intermediate time will be shown for 5 seconds.
- ▶ Press button  within 5 seconds. The intermediate time shown will be saved as a lap time. The RACETIMER begins timing the new lap. The new lap begins to be timed as soon as the intermediate time is called up.

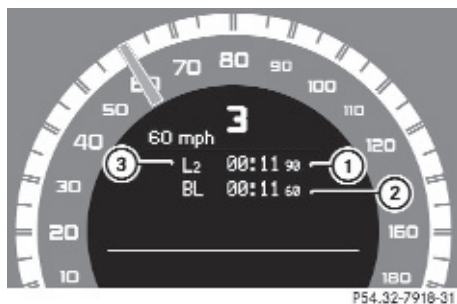

P54.32-7910-31

- ① RACETIMER
- ② Best lap time
- ③ Lap number

Resetting current lap

- ▶ Press button while the timer is running. The timer stops.
- ▶ Press button . The lap time is reset to "0".

Deleting all laps

It is not possible to delete a single saved lap.

- ▶ Press button while the timer is running. The timer stops.
- ▶ Press button . The reset menu appears in the multifunction display.

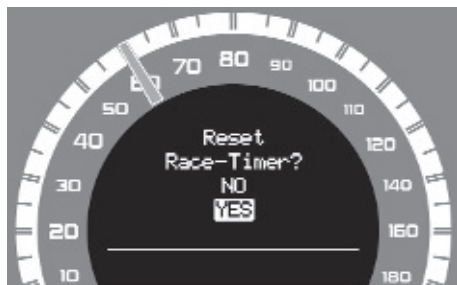

P54.32-7919-31

- ▶ Press button to select Yes and confirm with button . The saved laps are deleted.

Overall analysis

This function is only available if you have saved at least one lap and have stopped the RACETIMER.

- ▶ Press button or to select the AMG menu.
- ▶ Press button repeatedly until the overall analysis appears in the multifunction display.

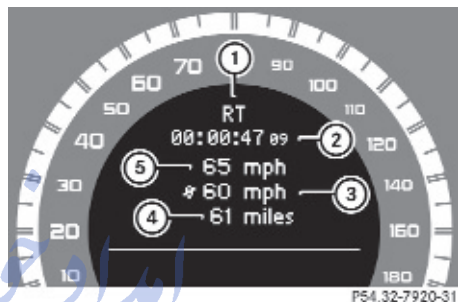

P54.32-7920-31

- ① Overall analysis of RACETIMER
- ② Overall driving time
- ③ Average speed
- ④ Overall distance driven
- ⑤ Maximum speed

Lap analysis

This function is only available if you have saved at least two laps and have stopped the RACETIMER.

- ▶ Press button or to select the AMG menu.
- ▶ Press button repeatedly until the lap analysis appears in the multifunction display.

Each lap is shown in its own submenu. The fastest lap is indicated by flashing symbol ①.



- ① Lap number
- ② Lap time
- ③ Average speed during lap
- ④ Lap length
- ⑤ Maximum speed during lap

► Press button or to see other lap analyses.

Navi menu

The Navi menu contains the functions needed to operate your navigation system.

► Press button or to select the Navi menu.

The message shown in the multifunction display depends on the status of the navigation system:

- With the COMAND system switched on or off and route guidance not activated, the direction of travel and, if applicable, the name of the street currently traveled on appear in the multifunction display.
- With the COMAND system switched on and route guidance activated, maneuver instructions appear in the multifunction display.

Please refer to separate COMAND system operating instructions for instructions on how to activate the route guidance system.

Audio menu

The functions in the Audio menu operate the audio equipment which you have currently switched on.

The following functions are available:

- Selecting radio station (► page 134)
- Operating audio devices/audio media (► page 135)
- Operating video DVD (► page 135)

If the COMAND system is currently switched off, the message **Audio Off** appears in the multifunction display.

► **To adjust the volume:** Press button or on the multifunction steering wheel.

Selecting radio station

i The SIRIUS XM Satellite Radio is treated as a radio application.

For more information on SIRIUS XM Satellite Radio, refer to separate COMAND system operating instructions.

Additional optional satellite radio equipment and a subscription to a satellite radio service provider are required for satellite radio operation. Contact an authorized Mercedes-Benz Center for details and availability for your vehicle.

- Switch on the COMAND system and select radio. Refer to separate COMAND system operating instructions.
- Press button or to select the Audio menu.
The currently tuned station appears in the multifunction display.

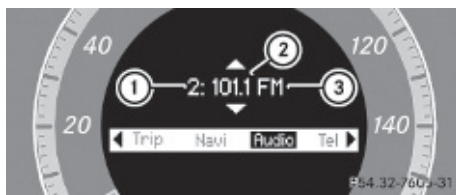

Example illustration for FM radio

- ① Stored memory position
- ② Station frequency
- ③ Wave band setting

► **Selecting next or previous stored station:** Press button or briefly to select a stored station.

► **Selecting next or previous station in wave band:** Press and hold button or to select a station.

You can only store new stations using the corresponding feature on the radio. Refer to separate COMAND system operating instructions.

You can also operate the radio in the usual manner.

Operating audio devices/audio media

- Switch on the COMAND system and select the audio device or audio media. Refer to separate COMAND system operating instructions.
- Press button or to select the Audio menu. The settings for the currently being played audio device/audio media appear in the multifunction display.



Example illustration

- ① Disc number
- ② Current track

► **Selecting next or previous track:** Press button or briefly.

► **Selecting a track from the track list (quick search):** Press and hold button or .

The current track does not appear during Audio AUX mode operation.

Operating video DVD

- Switch on the COMAND system and select DVD-Video. Refer to separate COMAND system operating instructions.
- Press button or to select the Audio menu.

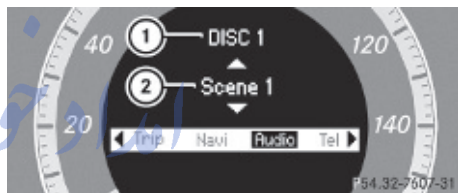

- ① Disc number
- ② Current scene

► **Selecting next or previous scene:** Press button or briefly.

► **Selecting a scene from the scene list (quick search):** Press and hold button or .

Tel menu

Warning!

A driver's attention to the road must always be his/her primary focus when driving. For your safety and the safety of others, we recommend that you pull over to a safe location and stop before placing or taking a telephone call. If you choose to use the telephone while driving, please use the hands-free device and only use the telephone when weather, road and traffic conditions permit.

Some jurisdictions prohibit the driver from using a mobile phone while driving a vehicle.

Bear in mind that at a speed of just 30 mph (approximately 50 km/h), your vehicle is covering a distance of 44 feet (approximately 14 m) every second.

You can connect your telephone to the COMAND system via Bluetooth®, see separate COMAND system operating instructions.

- ▶ Switch on the COMAND system.

Refer to separate COMAND system operating instructions.

- ▶ Press button  or  to select the Tel menu.

One of the following messages will appear in the multifunction display:

- No Service: No network is available.
- Ready for Bluetooth Telephony...
The telephone has not been connected to the COMAND system via Bluetooth® yet.
 - ▶ Connect the telephone to the COMAND system via Bluetooth®.
- Phone READY or name of the network provider (if available): The telephone has found a network and is ready for use. You can operate it using the control system.

Answering a call

When your telephone is ready to receive calls, you can answer a call at any time. In the multifunction display you will then see the following message:

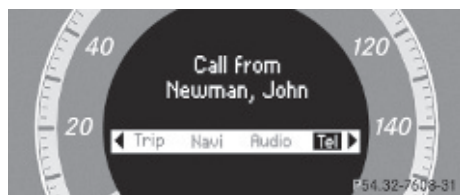

Example illustration

- ▶ Press button .

You have answered the call.

The caller's number appears only if it is transmitted.

The caller's name appears only if the number and the name are stored in the phone book.

Ending a call or rejecting an incoming call

- ▶ Press button .

Dialing a number from the phone book



When your telephone is ready to receive calls, you may select and dial a number from the phone book at any time.





- ▶ **i** To use the phone book of the COMAND system you can import business cards (vCards) from external Bluetooth® phones into your COMAND system's phone book, see separate COMAND operating instructions.

- ▶ Press button  or  to select the Tel menu.

- ▶ Press button  or  or  to switch to the phone book.

The stored names are displayed in ascending alphabetical order.

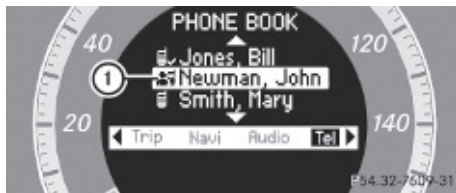

- ▶ Press button  or  to select the desired entry.

If you press and hold button  or  the system scrolls rapidly through the list of names (quick search). After holding the button  or  for a short while the scrolling speed increases. Release the button to stop the quick search. The search stops automatically at the end of the list.



Example illustration

① Selected name from the phone book

▶ If the Symbol  appears on the right-hand side of the name several entries are present for the same name: Press button  or  and select the desired entry.



▶ Press button  or .

The control system dials the selected phone number.

If the connection is successful and this feature is supported by your network provider, the name of the party (if stored in your phone book) you are calling will appear in the multifunction display.

The control system stores the dialed number in the redial memory.

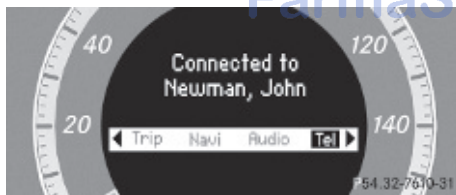

or

▶ Press button  or  if you do not want to make the call.





Redialing

The control system stores the most recently dialed phone numbers. This eliminates the need to search through your entire phone book.

▶ Press button  or  to select the Tel menu.

▶ Press button .

▶ Press button  or  to select the desired number or name.

▶ Press button  or .

The control system dials the selected phone number.



Assistance menu



In the DriveAssist menu, you can change the settings of your driving systems.

The following functions are available:

- Displaying distance graphic, DISTRONIC PLUS (▷ page 152)
- Activating/deactivating PRE-SAFE® Brake (vehicles with DISTRONIC PLUS only) (▷ page 137)
- Switching ATTENTION ASSIST on or off (▷ page 138)
- Switching Blind Spot Assist on or off (▷ page 138)
- Switching Lane Keeping Assist on or off (▷ page 138)



Activating/deactivating PRE-SAFE® Brake (vehicles with DISTRONIC PLUS only)

▶ Press button  or  to select the DriveAssist menu.

▶ Press button  or  to select the PRE-SAFE Brake function.

▶ Press button .



- ▶ Press button **[OK]** again if you would like to change the current status.
After the function has been activated, the PRE-SAFE® Brake indicator  appears in the lower part of the multifunction display. When the HOLD function is switched on, the PRE-SAFE® Brake indicator  will not appear.

For more information on PRE-SAFE® Brake, see (▶ page 69).

Switching ATTENTION ASSIST on or off

- ▶ Press button **[◀]** or **[▶]** to select the DriveAssist menu.
- ▶ Press button **[▼]** or **[▲]** to select the Attention Asst. function
- ▶ Press button **[OK]**.



- ▶ Press button **[OK]** again if you would like to change the current status.
After the function has been activated, the ATTENTION ASSIST indicator  appears on the left-hand side of the multifunction display.

For more information on ATTENTION ASSIST, see (▶ page 178).

Switching Blind Spot Assist on or off

- ▶ Press button **[◀]** or **[▶]** to select the DriveAssist menu.
- ▶ Press button **[▼]** or **[▲]** to select the Blind Spot Asst. function
- ▶ Press button **[OK]**.



- ▶ Press button **[OK]** again if you would like to change the current status.
Depending on the previous status, Blind Spot Assist: will be Enabled or Disabled.

For more information on Blind Spot Assist, see (▶ page 175).

Switching Lane Keeping Assist on or off

- ▶ Press button **[◀]** or **[▶]** to select the DriveAssist menu.
- ▶ Press button **[▼]** or **[▲]** to select the Lane Keep. Asst. function
- ▶ Press button **[OK]**.



- ▶ Press button **[OK]** again if you would like to change the current status.
After the function has been activated, the Lane Keeping Assist indicator  appears in the lower part of the multifunction display.

For more information on Lane Keeping Assistance, see (▶ page 177).

Service menu

In the Serv. menu the following functions are available:



- Vehicle status message memory (▷ page 139)
- Restarting the tire pressure loss warning system (Canada only) (▷ page 233)
- Checking tire inflation pressure electronically with the Advanced TPMS (▷ page 233)
- Calling up the maintenance service indicator display (▷ page 259)

Vehicle status message memory





Use the vehicle status message memory function to scan malfunction and warning messages that may be stored in the system. Such messages appear in the multifunction display and are based on conditions or system status the vehicle's system has recorded.

Warning!

Malfunction and warning messages are only indicated for certain systems and are intentionally not very detailed. The malfunction and warning messages are simply a reminder with respect to the operation of certain systems. They do not replace the owner's and/or driver's responsibility to maintain the vehicle's operating safety. Have all required maintenance and safety checks performed on the vehicle. Bring the vehicle to an authorized Mercedes-Benz Center to address the malfunction and warning messages.

- ▶ Press button  or  to select the Serv. menu.
If conditions have occurred causing status messages to be recorded, the number of messages appears in the multifunction display:



- ▶ Press button  or  to select the messages function.
- ▶ Press button  to confirm.
The stored messages will now be displayed in the order in which they have occurred.
For malfunction and warning messages, see "Vehicle status messages in the multifunction display" (▷ page 272).
- ▶ Use button  or  to scroll through the messages.

If you turn the SmartKey in the starter switch to position **0** and then back to position **2**, all messages will be deleted from the message memory.

Settings menu

Introduction



In the Sett. menu there are two functions: The function Factory Setting (▷ page 139), with which you can reset the settings to the original factory settings and a collection of submenus (▷ page 140) with which you can make individual settings for your vehicle.

Resetting to factory settings



You can reset most of the settings of the submenus to the factory settings.

For safety reasons, the function Daytime Running Lamps in the Lights submenu cannot be reset while driving.

- ▶ Press button  or  to select the Sett. menu.

- ▶ Press button  or  to select the Factory Setting function.
- ▶ Press button .
The function Reset All Settings? appears in the multifunction display.



- ▶ Press button  or  to select Yes or No. Select Yes if you want to reset to factory settings.
- ▶ Press button  to confirm.
The confirmation message appears in the multifunction display.



Submenus in the Settings menu

- ▶ Press button  or  to select the Sett. menu.



- ▶ Press button  or  to select a submenu.

Scroll down with button , scroll up with button .

With the selection marker on the desired submenu, use the button  to access the individual functions within that submenu. Once within the submenu, you can use button  to move to the next function or button  to move to the previous function within that submenu.

The following lists show what settings can be changed within the various menus. Detailed

instructions on making individual settings can be found on the following pages.

Instrument cluster submenu

- Selecting speedometer display mode (▷ page 141)
- Permanent display (speed display or outside temperature) (▷ page 141)

Lights submenu

- Switching daytime running lamp mode on or off (USA only) (▷ page 141)
- Switching Adaptive Highbeam Assist on or off (▷ page 142)
- Switching locator lighting on or off (▷ page 142)
- Setting ambient lighting (▷ page 143)
- Switching interior lighting delayed shut-off on or off (▷ page 143)

Vehicle submenu

- Switching automatic central locking on or off (▷ page 144)
- Switching the radar sensors on or off (▷ page 144)

Convenience submenu

- Activating easy-entry/exit feature (▷ page 145)
- Activating/deactivating seat belt adjustment function (▷ page 145)







Instrument cluster submenu

Access the Instr. Cluster submenu via the Sett. menu. Use the Instr. Cluster submenu to change the instrument cluster display settings.

The following functions are available:

- Selecting speedometer display mode (▷ page 141)
- Permanent display (speed display or outside temperature) (▷ page 141)

Selecting speedometer display mode

- ▶ Press  or  to select the Sett. menu.
- ▶ Press button  or  to select the Instr. Cluster submenu.
- ▶ Press button .
- ▶ Press button  or  to select the Display Unit Speed-/Odometer: function.
The current setting is shown.









- ▶ Press button  to change the setting. Depending on the previous setting the Display Unit Speed-/Odometer: will be set to miles or km.

The selected display unit is valid for:

- Odometer and trip odometer
- Trip computer
- Digital speedometer in the trip menu
- Cruise control
- Navigation displays

Permanent display

You can use the Permanent Display: function to choose to display either the outside temperature or the speed in kilometers (USA) or miles (Canada) permanently.

- ▶ Press button  or  to select the Sett. menu.
- ▶ Press button  or  to select the Instr. Cluster submenu.
- ▶ Press button .
- ▶ Press button  or  to select the Permanent Display: function.
The current setting is shown.



- ▶ Press button  to change the current status.
Depending on the previous status, the Permanent Display: will be switched between Outside temperature or Speedometer (km/h) (USA)/ Speedometer (miles) (Canada).







Lights submenu

Access the Lights submenu via the Sett. menu. Use the submenu to change the lamp and lighting settings on your vehicle.

The following functions are available:

- Switching daytime running lamp mode on or off (USA only) (▷ page 141)
- Switching Adaptive Highbeam Assist on or off (▷ page 142)
- Setting ambient lighting (▷ page 143)
- Switching locator lighting function on or off (▷ page 142)
- Switching interior lighting delayed shut-off on or off (▷ page 143)

Switching daytime running lamp mode on or off (USA only)

- ▶ Press button  or  to select the Sett. menu.
- ▶ Press button  or  to select the Lights submenu.
- ▶ Press button .
- ▶ Press button  or  to select the Daytime Running Lamps: function.
The current setting Enabled or Disabled is shown.



- ▶ Press button to change the current status.

Depending on the previous status, the Daytime Running Lamps: mode will be Enabled or Disabled.

With Daytime Running Lamps mode enabled and the exterior lamp switch at position or , the daytime running lamps are switched on when the engine is running.

In low ambient light conditions the following lamps will come on additionally:

- Low-beam headlamps
- Parking lamps
- Tail lamps
- License plate lamps
- Side marker lamps

For more information on the daytime running lamp mode, see (▷ page 98).

- i** Make sure the exterior lamp switch is set to or when you switch off the daytime running lamps while driving at night.

For safety reasons, resetting all the functions of all submenus to the factory settings while driving (▷ page 139) will not deactivate the daytime running lamp mode.

The following message appears in the multifunction display:

Cannot Be Completely Reset to Factory Settings while Driving..

Switching Adaptive Highbeam Assist on or off

- ▶ Press button or to select the Sett. menu.
- ▶ Press button or to select the Lights submenu.
- ▶ Press button .
- ▶ Press button or to select the Adaptive Highbeam Assist: function. The current setting Enabled or Disabled is shown.

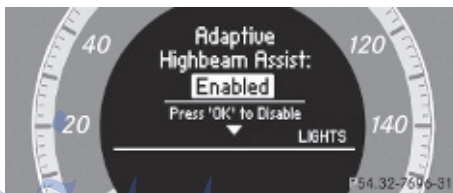

- ▶ Press button to change the current status.

Depending on the previous status, the Adaptive Highbeam Assist: function will be Enabled or Disabled.

For more information on the Adaptive Highbeam Assist, see (▷ page 100).

Switching locator lighting on or off

With the Locator Lighting: function activated and the exterior lamp switch in position

- the exterior lamps will come on during darkness when the vehicle is unlocked with the SmartKey.







The lamps will go out when the driver's door is opened.

If you do not open the driver's door after unlocking the vehicle with the SmartKey, the lamps will go out automatically after approximately 40 seconds.

- the exterior lamps will remain on for 15 seconds during darkness after exiting the vehicle and closing all doors.

If, after turning off the engine, you do not open or close a door, the lamps will automatically go out after 60 seconds.

The following lamps will come on

- Parking lamps
 - Tail lamps
 - License plate lamps
 - Side marker lamps
 - Front fog lamps
- ▶ Press button  or  to select the Sett. menu.
- ▶ Press button  or  to select the Lights submenu.
- ▶ Press button .
- ▶ Press button  or  to select the Locator Lighting: function.
The current setting Enabled or Disabled is shown.

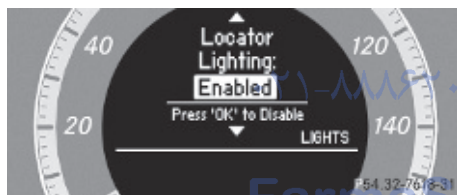







- ▶ Press button  to change the current status.
Depending on the previous status, the Locator Lighting: function will be Enabled or Disabled.

You can temporarily deactivate the headlamps delayed shut-off feature:



- ▶ Before exiting the vehicle, turn the SmartKey in the starter switch to position **0**.
- ▶ Then turn it to position **2** and back to position **0**.
The headlamps delayed shut-off feature is deactivated. It will reactivate as soon as you start the engine.

Setting ambient lighting

Use this function to adjust the brightness of the ambient lighting.







- ▶ Press button  or  to select the Sett. menu.
- ▶ Press button  or  to select the Lights submenu.
- ▶ Press button .
- ▶ Press button  or  to select the Ambient Light Brightness: function.



- ▶ Press button .
- ▶ Press button  or  to set the Ambient Light Brightness: .
The setting Level 1 represents the darkest level and setting Level 5 the brightest level. The ambient light is switched off at setting Disabled.

Switching interior lighting delayed shut-off on or off

Use this function to set whether you would like the interior lighting to remain on for 10 seconds during darkness after you have removed the SmartKey from the starter switch.

- ▶ Press button  or  to select the Sett. menu.
- ▶ Press button  or  to select the Lights submenu.
- ▶ Press button .
- ▶ Press button  or  to select the Interior Lighting Delay: function.
The current setting Enabled or Disabled is shown.



- ▶ Press button to change the current status.

Depending on the previous status, the interior lighting delayed shut-off feature will be Enabled or Disabled.

Vehicle submenu

Access the Vehicle submenu via the Sett. menu. Use the Vehicle submenu to switch the automatic central locking or the radar sensors on or off.

Switching automatic central locking on or off

Use this function to switch the automatic central locking on or off. With the automatic central locking activated, the vehicle is locked centrally at a vehicle speed of approximately 9 mph (15 km/h).

- ▶ Press button or to select the Sett. menu.
- ▶ Press button or to select the Vehicle submenu.
- ▶ Press button .
- ▶ Press button or to select the Automatic Door Lock: function. The current setting Enabled or Disabled is shown.

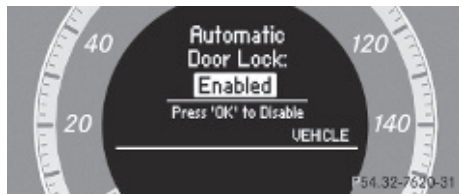

- ▶ Press button to change the current status.

Depending on the previous status, the Automatic Door Lock: feature will be Enabled or Disabled.

Switching the radar sensors on or off

If your vehicle is equipped with DISTRONIC PLUS it is equipped with a radar sensor system which you can switch on or off.

When traveling in Canada in a vehicle not registered in Canada, you must switch off the radar sensor system. Canadian law does not permit the use of the radar sensor system for vehicles from outside of Canada. When you switch off the radar sensor system, the following functions are deactivated:

- BAS PLUS (▶ page 63)
- PRE-SAFE® Brake (▶ page 69)
- DISTRONIC PLUS (▶ page 149)
- Blind Spot Assist (▶ page 175)

i USA only:

This device has been approved by the FCC as a "Vehicular Radar System". The radar sensor is intended for use in an automotive radar system only. Removal, tampering, or altering of the device will void any warranties, and is not permitted by the FCC. Do not tamper with, alter, or use in any non-approved way.

Any unauthorized modification to this device could void the user's authority to operate the equipment.







i Canada only:

This device complies with RSS-210 of Industry Canada. Operation is subject to the following two conditions:

1. This device may not cause interference, and
2. this device must accept any interference received, including interference that may cause undesired operation of the device.

Removal, tampering, or altering of the device will void any warranties, and is not permitted. Do not tamper with, alter, or use in any non-approved way.

Any unauthorized modification to this device could void the user's authority to operate the equipment.

- ▶ Press button  or  to select the **Sett.** menu.
- ▶ Press button  or  to select the **Vehicle** submenu.
- ▶ Press button .
- ▶ Press button  or  to select the **Radar Sensor** (See Oper. Manual): function.
The current setting **Enabled** or **Disabled** is shown.

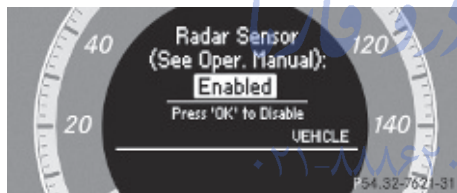

- ▶ Press button  again if you would like to change the current status.
Depending on the previous status, the radar sensors will be switched on (**Enabled**) or off (**Disabled**).

- i** The selected status of the radar sensors remains stored in memory even if the engine is turned off and restarted.

Convenience submenu

Access the Convenience submenu via the **Sett.** menu. Use the Convenience submenu to activate the easy-entry/exit feature (▷ page 145) or to activate the seat belt adjustment feature (▷ page 145).

Activating easy-entry/exit feature







Use this function to activate and deactivate the easy-entry/exit feature (▷ page 93).

Warning!

You must make sure no one can become trapped or injured by the moving steering wheel when the easy-entry/exit feature is activated.

To stop steering wheel movement, move steering wheel adjustment stalk or press one of the memory position buttons.

Do not leave children unattended in the vehicle, or with access to an unlocked vehicle. Children could open the driver's door and unintentionally activate the easy-entry/exit feature, which could result in an accident and/or serious personal injury.

- ▶ Press button  or  to select the **Sett.** menu.
- ▶ Press button  or  to select the **Convenience** submenu.
- ▶ Press button .
- ▶ Press button  or  to select the **Easy Entry/Exit**: function.
The current setting **Enabled** or **Disabled** is shown.









- ▶ Press button  to change the current status.
Depending on the previous status, the Easy Entry/Exit: feature will be **Enabled** or **Disabled**.

Activating/deactivating seat belt adjustment function

Use this function to set the seat belts to be adjusted automatically with the driver's or front passenger seat belt fastened and the starter switch in position **2**.

For more information on the seat belt adjustment function, see (▷ page 51).

- ▶ Press button  or  to select the Sett. menu.
- ▶ Press button  or  to select the Convenience submenu.
- ▶ Press .
- ▶ Press button  or  to select the Belt Adjustment: function.
The current setting Enabled or Disabled is shown.

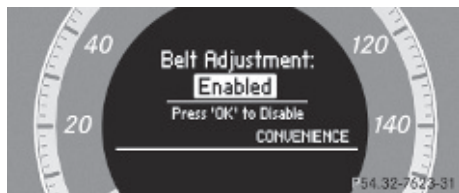

- ▶ Press button  to change the current status.
Depending on the previous status, the Belt Adjustment: function will be Enabled or Disabled.

Driving systems

Introduction

- Cruise control
- DISTRONIC PLUS
- Hill-start assist system
- HOLD function
- AIRMATIC (E 550 and E 550 4MATIC)
- All-wheel drive (4MATIC)
- Parktronic system with Parking Guidance
- Rear view camera
- Night View Assist Plus
- ATTENTION ASSIST
- Blind Spot Assist
- Lane Keeping Assist

- RACE START (E 63 AMG)
- AMG adaptive sport suspension system (E 63 AMG)

The driving safety systems ABS, Adaptive Brake, BAS, BAS PLUS, EBP, ESC and PRE-SAFE® Brake are described in the “Safety and security” section (> page 61).

Cruise control

The cruise control maintains the speed you set for your vehicle automatically.

The use of the cruise control is recommended for driving at a constant speed for extended periods of time.

The currently set speed or last set speed (“Resume” function) appears in the multifunction display for approximately 5 seconds. The corresponding cruise control speed segments from the selected speed to the vehicle maximum speed in the multifunction display are illuminated.

Warning! تلفن شماره ۰۲۱-۸۸۸۶۲۰

The cruise control is a convenience system designed to assist the driver during vehicle operation. The driver is and must always remain responsible for the vehicle's speed and for safe brake operation.

Only use the cruise control if the road, traffic, and weather conditions make it advisable to travel at a constant speed.

- The use of the cruise control can be dangerous on winding roads or in heavy traffic because conditions do not allow safe driving at a constant speed.
- The use of the cruise control can be dangerous on slippery roads. Rapid changes in tire traction can result in wheel spin and loss of control.
- Deactivate the cruise control when driving in fog.

The “Resume” function should only be operated if the driver is fully aware of the

previously set speed and wishes to resume this particular preset speed.

Warning!

The cruise control brakes automatically so that the set speed is not exceeded.

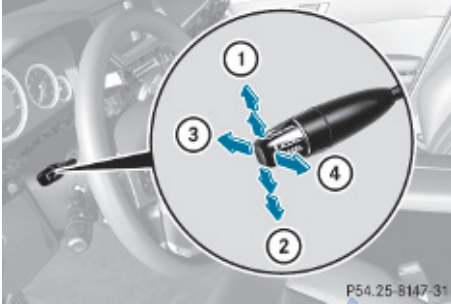

- ① Setting current or higher speed
- ② Setting current or lower speed
- ③ Canceling the cruise control
- ④ Activating the cruise control or resuming to last set speed

Activating cruise control

You can activate the cruise control at a vehicle speed above 20 mph (30 km/h).

You cannot activate the cruise control

- when you brake
- when you have engaged the parking brake
- when the automatic transmission is in park position **P**, reverse gear **R**, or neutral position **N**
- the ESC is switched off or has switched off due to a malfunction

The vehicle speed displayed in the speedometer can briefly vary from the speed setting for the cruise control system.

Setting current speed

- ▶ Accelerate or decelerate to the desired speed.
- ▶ Briefly lift the cruise control lever in direction of arrow ① or press in direction of arrow ②.
- ▶ Remove your foot from the accelerator pedal.

i On uphill grades, the cruise control may not be able to maintain the set speed. Once the grade eases, the set speed will be resumed.

On downhill grades, the cruise control maintains the set speed by braking with the vehicle's brake system. In addition, on longer downhill grades the automatic transmission will downshift automatically.

Canceling cruise control

- ▶ Depress the brake pedal.

or

- ▶ Briefly push the cruise control lever in direction of arrow ③.

The last set speed is stored for later use.

The last stored speed is deleted from memory when the engine is turned off.

The cruise control switches off automatically when you depress the brake pedal or you engage the parking brake. In this case, the cruise control speed segments in the multifunction display will go out.

The cruise control also switches off automatically when

- the vehicle speed falls below 20 mph (30 km/h)
- the ESC is in operation
- the ESC is switched off with the ESC switch
- the ESC has switched off due to a malfunction
- you shift the automatic transmission into neutral position **N** while driving

The cruise control speed segments in the multifunction display goes out and an acoustic warning will sound. Observe additional messages in the multifunction display that may appear.

Depressing the accelerator pedal does not deactivate the cruise control. After a brief acceleration (e.g. for passing), the cruise control will resume the last set speed.

Changing the set speed

Warning!

Keep in mind that it may take a brief moment until the vehicle has made the necessary adjustments.

Increase or decrease the set vehicle speed to a value that the prevailing road conditions and legal speed limits permit. Otherwise, sudden and unexpected acceleration or deceleration of the vehicle could cause an accident and/or serious injury to you and others.

You can increase or decrease the set speed in 1 mph (Canada: 1 km/h) increments or in 5 mph (Canada: 10 km/h) increments.

When you use the cruise control lever to decelerate, the brake system will brake the vehicle automatically if the engine's braking power does not brake the vehicle sufficiently.

Adjustment in 1 mph (Canada: 1 km/h) increments

 The set speed value is increased or decreased in 1 mph (Canada: 1 km/h) increments each time you lift or press the cruise control lever up or down to the resistance point.

- ▶ **Increasing:** Briefly lift the cruise control lever up to the resistance point in direction of arrow ①.
- ▶ **Decreasing:** Briefly press the cruise control lever down to the resistance point in direction of arrow ②.
- ▶ Release the cruise control lever. The new speed is set and the vehicle will accelerate or decelerate.

Adjustment in 5 mph (Canada: 10 km/h) increments

-  The set speed value is increased or decreased in 5 mph (Canada: 10 km/h) increments each time you lift or press the cruise control lever up or down past the resistance point.
- ▶ **Increasing:** Briefly lift the cruise control lever up past the resistance point in direction of arrow ①.
- ▶ **Decreasing:** Briefly press the cruise control lever down past the resistance point in direction of arrow ②.
- ▶ Release the cruise control lever. The new speed is set and the vehicle will accelerate or decelerate. Keep in mind that it may take a brief moment until the vehicle has reached the set speed.

Setting stored speed (Resume function)

Warning!

The set speed stored in memory should only be set again if prevailing road conditions and legal speed limits permit. Possible acceleration or deceleration differences arising from returning to the preset speed could cause an accident and/or serious injury to you and others.

- ▶ Briefly pull the cruise control lever in direction of arrow ④.
If no speed is stored, the current speed is set and stored.
- ▶ Remove your foot from the accelerator pedal.

The last stored speed is deleted from memory when the engine is turned off.

DISTRONIC PLUS

Safety notes

When activated, the DISTRONIC PLUS adaptive cruise control system increases the driving convenience afforded by the cruise control while traveling on expressways and other major roadways.

- If the DISTRONIC PLUS distance sensor detects a slower moving vehicle directly ahead, your vehicle speed will be reduced so that you follow that vehicle at your preset following distance.
- If there is no vehicle directly ahead of you, the DISTRONIC PLUS will function in the same way as standard cruise control (▷ page 146).

Warning!

The DISTRONIC PLUS requires familiarity with its operational characteristics. We strongly recommend that you review the following information carefully before operating the system.

Warning!

The DISTRONIC PLUS is a convenience system. Its speed adjustment reduction capability is intended to make cruise control more effective and usable when traffic speeds vary. It is not however, intended to, nor does it, replace the need for extreme care.

The responsibility for the vehicle's speed, distance to the preceding vehicle and, most importantly, brake operation to ensure a safe

stopping distance, always remains with the driver.

The DISTRONIC PLUS cannot take street and traffic conditions into account.

Complex driving situations are not always fully recognized by the DISTRONIC PLUS. This could result in wrong or missing distance warnings.

Warning!

The DISTRONIC PLUS adaptive cruise control is not a substitute for active driving involvement. It does not react to pedestrians or on stationary objects, nor does it recognize or predict the curvature and lane layout or the movement of preceding vehicles. The DISTRONIC PLUS can only apply a maximum of 40% of the vehicle's braking power.

The DISTRONIC PLUS may not detect narrow vehicles possibly driving in front of you, such as motorcycles and vehicles driving in an offset formation.

It is the driver's responsibility at all times to be attentive to the road, weather and traffic conditions. Additionally, the driver must provide the steering, braking and other driving inputs necessary to remain in control of the vehicle.

High-frequency sources such as toll stations, speed measuring systems etc. can cause the DISTRONIC PLUS system to temporarily cease functioning.

Warning!

The DISTRONIC PLUS cannot take road and traffic conditions into account. Only use the DISTRONIC PLUS if the road, weather and traffic conditions make it advisable to travel at a constant speed.

Warning!

Use of the DISTRONIC PLUS can be dangerous on slippery roads. Rapid changes in tire traction can result in wheel spin and loss of control.

The DISTRONIC PLUS does not function in adverse sight and distance conditions. Do not use the DISTRONIC PLUS during conditions of fog, heavy rain, snow or sleet.

Warning!

The DISTRONIC PLUS cannot take weather conditions into account. Switch off the DISTRONIC PLUS or do not switch it on if:

- roads are slippery or covered with snow or ice. The wheels could lose traction while braking or accelerating, and the vehicle could skid.
- the DISTRONIC PLUS system sensor covers are dirty or visibility is diminished due to snow, rain or fog, for example. The distance control system functionality could be impaired.

Always pay attention to surrounding traffic conditions even while the DISTRONIC PLUS is switched on. Otherwise, you may not be able to recognize dangerous situations until it is too late. This could cause an accident in which you and/or others could be injured.

Warning!

The “Resume” function should only be operated if the driver is fully aware of the previously set speed and wishes to resume this particular preset speed.

Warning!

Close attention to road and traffic conditions is imperative at all times, regardless of whether or not the DISTRONIC PLUS is activated.

Use of the DISTRONIC PLUS can be dangerous on winding roads or in heavy traffic because conditions do not allow safe driving at a constant speed.

The DISTRONIC PLUS will not react to stationary objects in the roadway (e.g. a stopped vehicle in a traffic jam or a disabled vehicle). The DISTRONIC PLUS will also not respond to oncoming vehicles.

Switch off the DISTRONIC PLUS:

- when changing from the left to the right lane if vehicles are moving more slowly in the left lane
- when entering a turn lane or highway off ramp
- in complex driving situations, such as in highway construction zones

In these situations, the DISTRONIC PLUS will continue to maintain the set speed unless deactivated.

The DISTRONIC PLUS is designed and intended only to maintain a set speed and keep a set distance from moving objects in front of it.

The DISTRONIC PLUS functions in a speed range of 0 to 120 mph (Canada: 0 to 200 km/h) if a preceding vehicle is detected. If no preceding vehicle is detected the DISTRONIC PLUS functions in a speed range of 20 to 120 mph (Canada: 30 to 200 km/h).

Always obey applicable speed limits.

Do not use the DISTRONIC PLUS if you are driving on a road with steep uphill or downhill slopes.

When traveling in Canada in a vehicle not registered in Canada, you must switch off the radar sensor system (▷ page 144). Canadian law does not permit the use of the radar sensor system for vehicles from outside of Canada. When you switch off the radar sensor system, the following functions are deactivated:

- DISTRONIC PLUS
- BAS PLUS (▷ page 63)
- PRE-SAFE® Brake (▷ page 69)
- Blind Spot Assist (▷ page 175)

i Due to its radar-emitting nature DISTRONIC PLUS may have an appearance similar to a radar detector to law enforcement officials. You may want to

refer to this section of your Operator's Manual when asked.

i USA only:

This device has been approved by the FCC as a "Vehicular Radar System". The radar sensor is intended for use in an automotive radar system only. Removal, tampering, or altering of the device will void any warranties, and is not permitted by the FCC. Do not tamper with, alter, or use in any non-approved way.

Any unauthorized modification to this device could void the user's authority to operate the equipment.

i Canada only:

This device complies with RSS-210 of Industry Canada. Operation is subject to the following two conditions:

1. This device may not cause interference, and
2. this device must accept any interference received, including interference that may cause undesired operation of the device.

Removal, tampering, or altering of the device will void any warranties, and is not permitted. Do not tamper with, alter, or use in any non-approved way.

Any unauthorized modification to this device could void the user's authority to operate the equipment.

DISTRONIC PLUS displays in multifunction display



Example illustration

If the DISTRONIC PLUS is activated, one or two segments ② around set speed ③ are illuminated.

The vehicle speed displayed on the speedometer can briefly vary from the speed setting on the DISTRONIC PLUS system.

If the DISTRONIC PLUS detects a vehicle directly ahead, segments ② in the multifunction display comes on between the speed of the vehicle ahead ① and the set speed ③.

If the DISTRONIC PLUS calculates that there is a danger of collision, the distance warning lamp  in the instrument cluster comes on and an intermittent warning sounds.

- Immediately apply the brake to avoid a collision.

Under no circumstances should the driver await the intermittent warning sound before braking. See the following warning note.

The intermittent warning sound ceases and the distance warning lamp  goes out when the necessary distance to the vehicle ahead is again established.

Warning!

An intermittent warning sounds and the distance warning lamp  in the instrument cluster is illuminated if the DISTRONIC PLUS system calculates that the distance to the

vehicle ahead and your vehicle's current speed indicate that the DISTRONIC PLUS will not be capable of slowing the vehicle sufficiently to maintain the preset following distance, which creates a danger of a collision.

Immediately brake the vehicle to increase your distance to the preceding vehicle. The warning sound is intended as a final caution in which you should intercede with your own braking inputs to avoid a potentially dangerous situation. Do not wait for the operation of the warning signal to intercede with your own braking. This will result in potentially dangerous emergency braking which will not always result in an impact being avoided.

Tailgating increases the risk of an accident.

Warning!

The DISTRONIC PLUS brakes your vehicle with a maximum deceleration of 13 ft/s² (4 m/s²). This corresponds to approximately 40% of the maximum deceleration of your vehicle.

You must also apply the brakes yourself to avoid a collision. The DISTRONIC PLUS brakes the vehicle in an effort to restore the preset distance or to maintain the set speed.

Warning!

If you do not receive visual or acoustic warning signals during a critical traffic situation, DISTRONIC PLUS has either not recognized the collision risk, has been deactivated or is malfunctioning.

Remember, whether or not DISTRONIC PLUS is operating, it is ultimately always the drivers responsibility to apply the brakes in order to control the vehicle and avoid a collision.





Displaying the distance graphic

In the DriveAssist menu under Distance Display you see the current settings for DISTRONIC PLUS. The Information shown in

the multifunction display depends on whether DISTRONIC PLUS is activated or deactivated.

For activating or deactivating the DISTRONIC PLUS system, see “Activating DISTRONIC PLUS” (> page 153) or “Deactivating DISTRONIC PLUS” (> page 156).

The menu overview can be found on (> page 129).

- ▶ Press  or  to select the DriveAssist menu.
- ▶ Press  or  to select the Distance Display function.
- ▶ Press .

The DISTRONIC PLUS distance graphic appears and you will see one of the following displays in the multifunction display.

DISTRONIC PLUS activated

If you switch on the DISTRONIC PLUS, you will see the set speed in the multifunction display for approximately 5 seconds. When the DISTRONIC PLUS is activated the following display appears in the multifunction display.



Example illustration

- ① DISTRONIC PLUS activated
- ② Your vehicle
- ③ Preset distance threshold to the preceding vehicle
- ④ Preceding vehicle, if detected

DISTRONIC PLUS deactivated

When the DISTRONIC PLUS is deactivated, you will see the following display in the multifunction display.



Example illustration

- ① Preceding vehicle, if detected
- ② Actual distance to the preceding vehicle
- ③ Preset distance threshold to the preceding vehicle
- ④ Your vehicle
- ⑤ PRE-SAFE® Brake activated

DISTRONIC PLUS lever

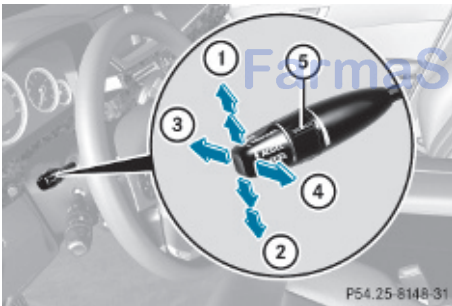

- ① Setting current or higher speed
- ② Setting current or lower speed
- ③ Deactivating the DISTRONIC PLUS
- ④ Activating the DISTRONIC PLUS or resuming to the last set speed
- ⑤ Setting following distance

Activating DISTRONIC PLUS

⚠ Warning!

When the DISTRONIC PLUS is switched on, the vehicle can be braked. You should therefore switch off the DISTRONIC PLUS if the vehicle must be towed.

You can activate the DISTRONIC PLUS when the vehicle speed is above 20 mph (30 km/h).

It is also possible to activate the DISTRONIC PLUS when the vehicle speed is below 20 mph (30 km/h) and the DISTRONIC PLUS has detected a preceding vehicle.

If the DISTRONIC PLUS is activated, one or two segments ② (▷ page 151) around set speed ③ (▷ page 151) in the multifunction display are illuminated.

The maximum vehicle speed you can set is 120 mph (Canada: 200 km/h).

If the DISTRONIC PLUS is not activated after the DISTRONIC PLUS lever is pulled in direction of arrow ④ (▷ page 153), you will see the message: DISTRONIC PLUS --- mph in the multifunction display.

In the following cases you cannot activate the DISTRONIC PLUS:

- within 2 minutes after driving off, following an engine start
- if the vehicle is secured with the parking brake
- if the ESC is switched off or has switched off due to a malfunction
- when the automatic transmission is in park position **P**, reverse gear **R**, or neutral position **N**
- if the hood is open
- if the driver's door is open and the driver has not fastened his or her seat belt
- if the front passenger or a rear passenger door is open
- if the radar sensors are switched off (▷ page 144)

فارس درویش
۰۸۸۶۲۰۸۸-۲۱
FarmaSOS.com

Switching on while driving

You can switch on the DISTRONIC PLUS when the vehicle speed is above 20 mph (30 km/h).

Below 20 mph (30 km/h), you can only switch on the DISTRONIC PLUS if the preceding vehicle has been detected and is shown in the multifunction display. If you no longer see the preceding vehicle in the multifunction display and if it is no longer detected because it has changed lanes, for example, the DISTRONIC PLUS switches off and a signal sounds.

- ▶ Pull the DISTRONIC PLUS lever briefly in direction of arrow ④ to call up the last set speed, or if no speed is stored, to set and store the current speed.

The DISTRONIC PLUS is switched on.

or

- ▶ Tap the DISTRONIC PLUS lever up ① or down ② until desired speed is set. The DISTRONIC PLUS is switched on.
- ▶ Remove your foot from the accelerator pedal. Your vehicle adapts its speed to the preceding vehicle, observing the set speed as a maximum value.

If you do not completely remove your foot from the accelerator pedal, the message DISTRONIC PLUS Override appears in the multifunction display. The distance to a slower-driving vehicle will not be set. You will drive at the speed you dictate by pressing the accelerator pedal.

Switching on when approaching a stationary vehicle

It is helpful to switch on the DISTRONIC PLUS display in the multifunction display to see that a preceding vehicle is detected (▷ page 152). You can only switch on the DISTRONIC PLUS below a speed of 20 mph (30 km/h) when a preceding vehicle is detected.

If the preceding vehicle is stationary, you can only switch on the DISTRONIC PLUS if your vehicle is also at a standstill.

- ▶ Pull the DISTRONIC PLUS lever briefly in direction of arrow ④. The DISTRONIC PLUS is switched on.
- ▶ Tap the DISTRONIC PLUS lever up ① or down ② until desired speed is set.

You can adjust the set speed using the DISTRONIC PLUS lever and the target distance using the distance setting switch on the DISTRONIC PLUS lever (▷ page 157).

- ❗ If the DISTRONIC PLUS is switched off, the PRE-SAFE® Brake (▷ page 69) will warn of an impending collision if this function has been activated with the instrument cluster control system (▷ page 137).

Starting off

When the preceding vehicle starts off:

- ▶ Remove your foot from the brake pedal.
- ▶ Pull the DISTRONIC PLUS lever briefly in direction of arrow ④.

or

- ▶ Briefly step on the accelerator pedal.

Your vehicle starts off and adapts its speed to the preceding vehicle.

Driving

If there is no preceding vehicle, the DISTRONIC PLUS functions like the cruise control (▷ page 146).

When the DISTRONIC PLUS detects that the preceding vehicle is driving more slowly, it brakes the vehicle in order to keep the distance specified by you.

When the DISTRONIC PLUS detects that the preceding vehicle is driving faster, it accelerates the vehicle up to the set speed.

Warning!

When you step on the brake pedal, you switch off the DISTRONIC PLUS except when the vehicle is at a standstill. The DISTRONIC PLUS

will no longer brake your vehicle. You are always responsible for maintaining a distance from other vehicles, observing road speeds and braking well in advance.

Stopping

Warning!

The braking effect of the DISTRONIC PLUS is canceled and the vehicle can start to roll if

- the DISTRONIC PLUS is switched off using the DISTRONIC PLUS lever
- you accelerate
- the DISTRONIC PLUS system or the power supply is malfunctioning, e.g. due to battery failure
- the electrical components in the engine compartment or the fuses have been manipulated
- the battery is disconnected

Warning!

Never get out of the vehicle while the DISTRONIC PLUS is switched on!

The DISTRONIC PLUS must never be operated or switched off by passengers or from outside the vehicle.

The DISTRONIC PLUS is not a substitute for the parking brake. It must not be used to secure the vehicle when parking.

When you get out of the vehicle or switch off the engine, deactivate the DISTRONIC PLUS and secure the vehicle from rolling away by engaging the parking brake.

When the DISTRONIC PLUS detects that the preceding vehicle is stopping, the vehicle brakes until it also stops. Once the vehicle is at a standstill, it remains stationary, without depressing the brake pedal.

Depending on the following distance set using the distance setting switch on the DISTRONIC PLUS lever (▷ page 157), the vehicle will stop adequate away from the preceding vehicle.

When the DISTRONIC PLUS is activated and the vehicle is at a standstill, the automatic transmission shifts into park position **P** automatically when

- opening the driver's door and releasing the seat belt
- turning off the engine
- opening the hood
- a system malfunction occurs
- the on-board voltage is insufficient

The DISTRONIC PLUS is deactivated.

Setting the current speed

▶ Accelerate or decelerate to the desired speed.

▶ Briefly lift the DISTRONIC PLUS lever in direction of arrow ① or depress in direction of arrow ② (▷ page 153). The current speed is set.

▶ Remove your foot from the accelerator pedal.

 If you do not take your foot off of the accelerator pedal and continue to accelerate past the set speed, the following message will appear in the multifunction display:

DISTRONIC PLUS Override

The distance to a slower moving vehicle in front of you will not be set. Your vehicle speed will then be determined only by the accelerator pedal position.

Changing the set speed

Warning!

Keep in mind that it may take a brief moment until the vehicle has made the necessary adjustments.

Increase or decrease the set vehicle speed to a value that the prevailing road conditions and legal speed limits permit. Otherwise, sudden and unexpected acceleration or deceleration

of the vehicle could cause an accident and/or serious injury to you and others.

You can increase or decrease the set speed in 1 mph (Canada: 1 km/h) increments or in 5 mph (Canada: 10 km/h) increments.

When you use the DISTRONIC PLUS lever to decelerate, the brake system will brake the vehicle automatically if the engine's braking power does not brake the vehicle sufficiently.

Adjustment in 1 mph (Canada: 1 km/h) increments

i The set speed value is increased or decreased in 1 mph (Canada: 1 km/h) increments each time you lift or press the DISTRONIC PLUS lever up or down to the resistance point.

- ▶ **Increasing:** Briefly lift the DISTRONIC PLUS lever up to the resistance point in direction of arrow ①.
- ▶ **Decreasing:** Briefly press the DISTRONIC PLUS lever down to the resistance point in direction of arrow ②.
- ▶ Release the DISTRONIC PLUS lever. The new speed is set and the vehicle will accelerate or decelerate.

Adjustment in 5 mph (Canada: 10 km/h) increments

i The set speed value is increased or decreased in 5 mph (Canada: 10 km/h) increments each time you lift or press the DISTRONIC PLUS lever up or down past the resistance point.

- ▶ **Increasing:** Briefly lift the DISTRONIC PLUS lever up past the resistance point in direction of arrow ①.
- ▶ **Decreasing:** Briefly press the DISTRONIC PLUS lever down past the resistance point in direction of arrow ②.
- ▶ Release the DISTRONIC PLUS lever. The new speed is set and the vehicle will accelerate or decelerate. Keep in mind that

it may take a brief moment until the vehicle has reached the set speed.

Setting stored speed (Resume function)

Warning!

The set speed stored in memory should only be set again if prevailing road conditions and legal speed limits permit. Possible acceleration or deceleration differences arising from returning to the preset speed could cause an accident and/or serious injury to you and others.

- ▶ Briefly pull the DISTRONIC PLUS lever in direction of arrow ④ (> page 153). The DISTRONIC PLUS is activated and resumes to the last set speed or, if no speed is stored, it will set and store the current speed.
- ▶ Remove your foot from the accelerator pedal.

Deactivating DISTRONIC PLUS

- ▶ Depress the brake pedal (only possible if the vehicle is in motion).

or

- ▶ Briefly push the DISTRONIC PLUS lever in direction of arrow ③ (> page 153). The last set speed is stored for later use.

The last stored speed is deleted from memory when the engine is turned off.

The DISTRONIC PLUS switches off automatically when

- the vehicle is secured with the parking brake
- the vehicle speed falls below 15 mph (25 km/h) and no preceding vehicle is detected
- the ESC is in operation, or switched off with the ESC switch (> page 66), or the ESC has switched off due to a malfunction

- you shift the automatic transmission into park position **P**, reverse gear **R**, or neutral position **N** while driving
- the radar sensors are switched off
- you pull the DISTRONIC PLUS lever in direction of arrow ④ (▷ page 153) for driving off and the passenger door is open

The segments indicating the set speed in the multifunction display go out, an acoustic signal sounds, and the message DISTRONIC PLUS Off appears in the multifunction display for approximately 5 seconds.

Warning!

The DISTRONIC PLUS switches off and releases the brakes when the vehicle decelerates below the minimum speed of 20 mph (30 km/h) by operation of the system unless the DISTRONIC PLUS detects a vehicle directly ahead of you. At that time the driver must apply the brakes in order to reduce vehicle speed further or bring it to a stop.

Depressing the accelerator pedal does not deactivate the DISTRONIC PLUS. After a brief acceleration (e.g. for passing), the DISTRONIC PLUS will resume the last set speed.

Setting the following distance in DISTRONIC PLUS

You can set the specified following distance for the DISTRONIC PLUS by varying the time setting between 1.0 and 2.0 seconds. Using this time setting and the current speed of your vehicle, the DISTRONIC PLUS calculates and sets the required following distance to the preceding vehicle.

The set distance will be shown in the multifunction display.

Warning!

It is up to the driver to exercise discretion to select the appropriate setting given road conditions, traffic, driver's preferred driving

style and applicable laws and driving recommendations for safe following distance.

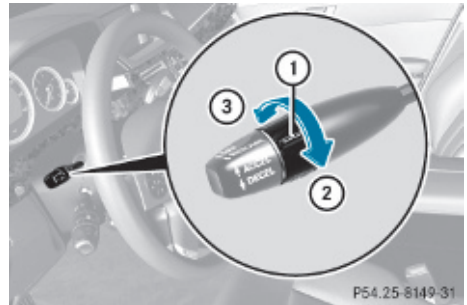

- ▶ **Increasing distance:** Turn distance setting switch ① in direction of arrow ②. Increasing the distance setting tells the DISTRONIC PLUS to maintain a greater following distance to the preceding vehicle.
- ▶ **Decreasing distance:** Turn distance setting switch ① in direction of arrow ③. Decreasing the distance setting tells the DISTRONIC PLUS to maintain a shorter following distance to the preceding vehicle.

Driving with DISTRONIC PLUS

This section describes a number of driving situations where special precaution is required on the part of the driver. Be prepared to brake in such situations. Braking will deactivate the DISTRONIC PLUS system.

Warning!

The DISTRONIC PLUS works to maintain the speed selected by the driver unless a moving obstacle proceeding directly ahead of it in the same travel direction is detected (e.g. following another vehicle ahead of you at your set distance).

This means that:

- Your vehicle can pass another vehicle after you have changed lanes.
- While in a sharp turn or if the preceding vehicle is in a sharp turn, the DISTRONIC

PLUS could lose sight of the preceding vehicle. Your vehicle could then accelerate to the previously selected speed.

The DISTRONIC PLUS regulates only the distance between your vehicle and those directly ahead of it. It may not register stationary objects in the road, e.g.:

- a stopped vehicle in a traffic jam
- a disabled vehicle
- an oncoming vehicle

The driver must always be alert, observe all traffic and intercede as required by means of steering or braking the vehicle.

Warning!

The DISTRONIC PLUS should not be used in snowy or icy road conditions.

The most likely cause for a malfunctioning system is a dirty sensor (located in the hood grille and in the bumper), especially at times of snow and ice or heavy rain.

In such a case, the DISTRONIC PLUS will switch off, and the message DISTRONIC PLUS Currently Unavailable See Operator's Manual appears in the multifunction display.

For cleaning and care of the sensors, see (▷ page 263).

- i** If the message DISTRONIC PLUS Currently Unavailable See Operator's Manual disappears during driving and the last speed stored flashes for approximately 5 seconds, the dirt (e.g. slush) has dissolved; the DISTRONIC PLUS is available again.

Another cause might be that the radar sensors have been manually switched off in the instrument cluster control system. Please verify that the radar sensors are switched on (▷ page 144).

Turns and bends

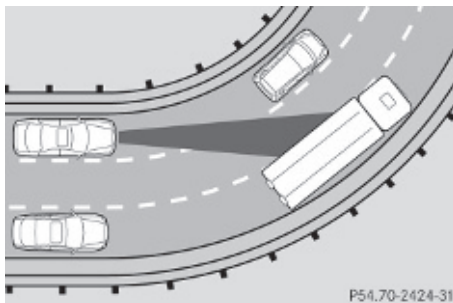

In turns or bends, the DISTRONIC PLUS may not detect a preceding vehicle, or it may detect one too soon. This may cause your vehicle to brake late or unexpectedly.

Offset driving

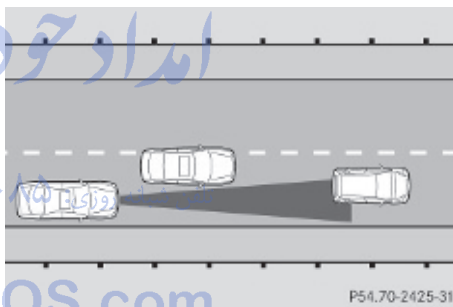

A vehicle traveling in your lane but offset from your direct line of travel may not be detected by the DISTRONIC PLUS. There will be insufficient distance to the preceding vehicle.

Lane changing

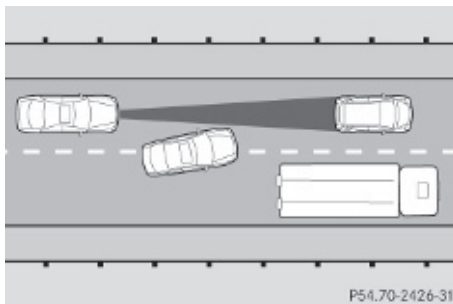

The DISTRONIC PLUS has not yet detected the vehicle changing lanes. There will be insufficient distance to the lane-changing vehicle.

Narrow vehicles

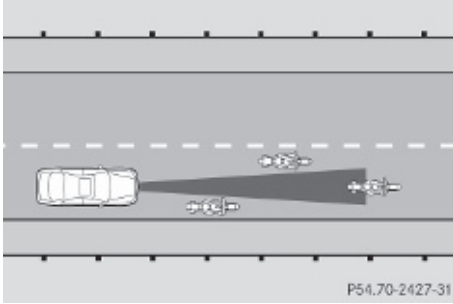

Because of their narrow profile, the vehicles traveling near the outer edges of the lane have not yet been detected by the DISTRONIC PLUS. There will be insufficient distance to the preceding vehicles.

Obstacles and stationary vehicles

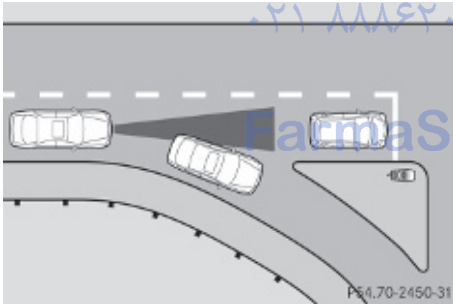

The DISTRONIC PLUS does not brake for obstacles or stationary vehicles. If, for example, the vehicle detected in front of you changes lanes to bypass an obstacle or stationary vehicle in front of it, the DISTRONIC PLUS will not brake for the obstacle or stationary vehicle.

Cross-traffic

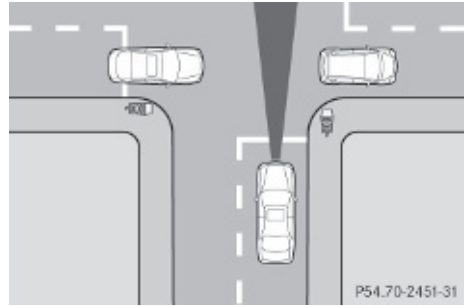

The DISTRONIC PLUS may inadvertently detect crossing vehicles. If you switch on the DISTRONIC PLUS, for example, at a traffic light with cross traffic, the vehicle may suddenly start to drive off.

RACE START (E 63 AMG)

RACE START enables optimum acceleration from a standing start with suitable high-grip road surface conditions.

Warning! تلفظ

RACE START is only available when the ESC SPORT mode is switched on. ESC SPORT stabilizes the vehicle only to a limited extent if the vehicle starts to skid or when a wheel is spinning.

RACE START should be used only on closed tracks. Always adapt your speed and driving to the prevailing road and weather conditions.

Conditions for activation

RACE START can be activated when

- the doors are closed
- the engine is running and has reached its operating temperature of approximately 80°C. This is the case when the engine oil temperature indicator in the multifunction display stops flashing.
- ESC SPORT is switched on (▷ page 67)
- the multifunction steering wheel is in the straight-ahead position

- the vehicle is standing still and the brake pedal is depressed (left foot)
- the automatic transmission is in drive position **D**

Activating RACE START

- ▶ Depress the brake pedal with your left foot and keep it depressed.
- ▶ Turn the program mode selector dial clockwise (▶ page 121) until the **RS** lamp on the dial comes on.
The message RACE START Confirm: Paddle UP Cancel: Paddle DOWN appears in the multifunction display.

i When the activation conditions are not fulfilled anymore, RACE START is canceled. The message RACE START Canceled appears in the multifunction display.

- ▶ To cancel: Pull left steering wheel gearshift control (▶ page 122).

or

- ▶ To confirm: Pull right steering wheel gearshift control (▶ page 122).
The message RACE START Available Depress gas pedal. appears in the multifunction display.

i If you do not depress the accelerator pedal within 2 seconds, RACE START is canceled. The message RACE START Not Possible See Operator's Manual appears in the multifunction display.

- ▶ Depress the accelerator pedal fully.
The engine speed rises to approximately 4000 rpm.
The message RACE START Release brake to start appears in the multifunction display.

i If you do not release the brake pedal within 7 seconds, RACE START is canceled.

The message RACE START Canceled appears in the multifunction display.

- ▶ Take your foot off the brake pedal while keeping the accelerator pedal depressed. The vehicle pulls away at maximum acceleration.

The message RACE START Active appears in the multifunction display.

RACE START deactivates at a vehicle speed of approximately 30 mph (Canada: 50 km/h). The automatic transmission switches to program mode **S+**. ESC SPORT remains switched on.

RACE START is canceled immediately if you release the accelerator pedal while RACE START is active or when the activation conditions are not fulfilled anymore. The message RACE START Not Possible See Operator's Manual appears in the multifunction display.

i If RACE START is used repeatedly in a short period of time, it is only available again after having driven the vehicle a certain distance.

Hill-start assist system

On uphill grades, the hill-start assist system maintains the pressure in the brake system for approximately 1 second after you have released the brake pedal. Therefore, you can start off smoothly without the vehicle moving immediately after releasing the brake pedal.

Warning!

The hill-start assist system is not designed to function as a parking brake. It does not prevent the vehicle from moving when parked on an incline.

Always engage the parking brake in addition to shifting the automatic transmission into park position **P**.

- ▶ Depress the brake pedal.
- ▶ Shift the automatic transmission into drive position **D** or reverse gear **R**.

- ▶ Release the brake pedal.
- ▶ Carefully depress the accelerator pedal.

The hill-start assist system is inactive

- when starting off on a level road or downhill grades
- with the automatic transmission in neutral position **N**
- with the parking brake engaged
- if the ESC has switched off due to a malfunction

All-wheel drive (4MATIC)

In vehicles with all-wheel drive (4MATIC), both axles are powered at all times when the vehicle is being operated. The 4MATIC improves traction in conjunction with the ESC (▷ page 65) and the Electronic Traction System (ETS/4-ETS) (▷ page 65).

Warning!

If a drive wheel is spinning due to insufficient traction:

- While driving off, apply as little throttle as possible.
- While driving, ease up on the accelerator pedal.
- Adapt your speed and driving style to the prevailing road conditions.

Failure to observe these guidelines could cause the vehicle to skid.

The 4MATIC cannot prevent accidents resulting from excessive speed.

- !** Do not tow with one axle raised. Doing so could damage the transfer case, which is not covered by the Mercedes-Benz Limited Warranty. All wheels must be on or off the ground. Observe instructions for towing the vehicle with all wheels on the ground.

- !** Only conduct operational or performance tests on a two-axle dynamometer. If such

tests are necessary, contact an authorized Mercedes-Benz Center. You could otherwise seriously damage the brake system and/or the transfer case which is not covered by the Mercedes-Benz Limited Warranty.

- i** In winter operation, the maximum effectiveness of the 4MATIC is only achieved with winter tires (▷ page 252) or snow chains as required.

HOLD function

The HOLD function can assist you

- when driving off, especially on steep slopes
- when maneuvering on steep slopes
- when waiting in traffic

The vehicle is kept stationary without the driver having to depress the brake pedal.

Upon depressing the accelerator pedal, the braking effect is canceled and the HOLD function is deactivated.

Activation conditions

You can activate the HOLD function when

- the vehicle is stationary
- the engine is running
- your seat belt is fastened or the driver's door is closed
- the parking brake is released
- the hood is closed
- the automatic transmission is in neutral position **N**, drive position **D**, or reverse gear **R**
- the DISTRONIC PLUS is deactivated (▷ page 156)

Activating HOLD

- ▶ Make sure the activation conditions are met.
- ▶ Depress the brake pedal.
- ▶ Continue to depress the brake pedal with increased pedal pressure until the message HOLD appears in the multifunction display. The HOLD function is activated. You can now release the brake pedal.



Example illustration, HOLD function activated

- ❗ If the HOLD function is not activated when depressing the brake pedal, wait briefly and repeat the above steps.

⚠ Warning!

The vehicle's brakes are applied when the HOLD function is activated. Therefore, deactivate the HOLD function, for example, when the vehicle is pulled through an automatic car wash or being towed.

Deactivating HOLD

The HOLD function is switched off when

- you depress the accelerator pedal with the automatic transmission in drive position **D** or reverse gear **R**
- you shift the automatic transmission into park position **P**
- you depress the brake pedal fully again until the message HOLD in the multifunction display disappears
- you activate the DISTRONIC PLUS

⚠ Warning!

The braking effect of the HOLD function is canceled and the vehicle can start to roll if

- the HOLD function is deactivated by depressing the accelerator pedal or the brake pedal
- the HOLD function or the power supply is malfunctioning, e.g. due to battery failure
- the electrical components in the engine compartment or the fuses have been manipulated
- the battery is disconnected

⚠ Warning!

Never get out of the vehicle while the HOLD function is activated!

The HOLD function must never be operated or deactivated by passengers or from outside the vehicle.

The HOLD function does not replace the parking brake. It must not be used to secure the vehicle when parking.

Deactivate the HOLD function when leaving or parking the vehicle. Use the parking brake to secure the vehicle.

When the HOLD function is activated, the automatic transmission shifts into park position **P** automatically when

- opening the driver's door and releasing the seat belt
- turning off the engine
- opening the hood
- a system malfunction occurs
- the on-board voltage is insufficient

The HOLD function is deactivated.

AIRMATIC (E 550 and E 550 4MATIC)

Introduction

The AIRMATIC lets you select the chassis and suspension setup. The chassis and

suspension setup adjusts the damping behavior and the ride height for your vehicle. The AIRMATIC consists of two components. The electronically controlled damping system (▷ page 163) and the vehicle level control (▷ page 163).

Damping system

The damping system is controlled electronically and operates continuously. It adjusts the damping characteristics to the current operating and driving conditions. The damping is adjusted individually for each wheel. Driving safety and tire comfort are increased.

The fine tuning of the damping is dependent on

- your driving style
- road surface conditions
- your personal settings

The selected setting remains stored in memory even if the SmartKey is removed from the starter switch.

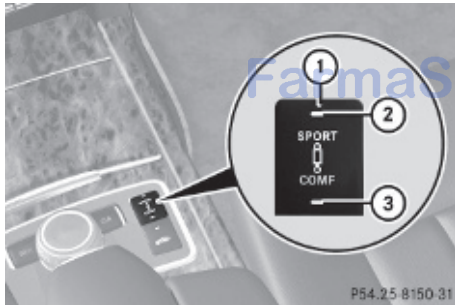

- ▶ Start the engine.

Sporty damping adjustment

The firmer suspension tuning in Sport driving mode provides enhanced road contact. Select this mode for example, on winding highways.

- ▶ Press damping system switch ①. Indicator lamp ② comes on. The Sport driving mode with a firmer suspension

tuning is selected. The message AIRMATIC SPORT appears in the multifunction display.

Comfort damping adjustment

Vehicle handling in Comfort driving mode is softer. Select this mode when you prefer a more comfortable driving style on straight freeways.

- ▶ Press damping system switch ①. Indicator lamp ③ comes on. The Comfort driving mode is selected. The message AIRMATIC COMFORT appears in the multifunction display.

Vehicle level control

Your vehicle automatically adjusts its ride height.

The all-around vehicle level control provides best possible suspension and constant ground clearance. The vehicle lowers at high speed automatically in order to increase driving safety and to reduce fuel consumption.

The following vehicle levels are available:

- normal
- raised; the vehicle is raised by approximately 1.0 in (25 mm) compared to normal level
- lowered; the vehicle is lowered by approximately 0.4 in (10 mm) compared to normal level

You can choose between normal or raised level.

The vehicle chassis ride height is reduced automatically

- at a speed exceeding approximately 93 mph (150 km/h)
- with the Sport driving mode (▷ page 163) set

With decreasing speed, the ride height is again raised to the normal level.

- i** These height adjustments are so small that you may not notice any change.

Adjusting vehicle level manually

Warning!

To help avoid personal injury, keep hands and feet away from wheel housing area, and stay away from under the vehicle when lowering the vehicle chassis.

Select the normal level for driving on normal roads. Select the raised level for driving on rough roads or with snow chains. Select the raised level only when required by current driving conditions. Otherwise, the handling may be impaired and the fuel consumption may increase.

The selected vehicle level setting remains stored in memory even if the SmartKey is removed from the starter switch.

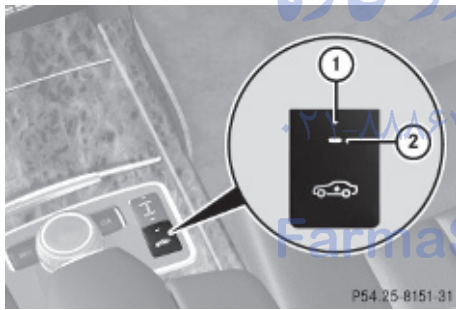

Selecting raised level

- ▶ Start the engine.

When indicator lamp ② is off:

- ▶ Briefly press vehicle level control switch ①.

Indicator lamp ② comes on. The vehicle adjusts from normal level to raised level. The message: Vehicle Rising appears in the multifunction display when adjusting from normal level to raised level. The message disappears when the vehicle is raised. Indicator lamp ② is then lit.

When the vehicle is in raised level, pressing vehicle level control switch ① will return the vehicle to normal level.

The vehicle is lowered to the normal level automatically when

- the vehicle speed is above 75 mph (120 km/h)
- the vehicle speed stays between 50 mph (80 km/h) and 75 mph (120 km/h) for approximately 3 minutes.

Indicator lamp ② in vehicle level control switch ① goes out.

If you do not drive in this speed range, the selected vehicle level setting remains stored in memory even if the SmartKey is removed from the starter switch.

Selecting normal level

- ▶ Start the engine.

When indicator lamp ② is on:

- ▶ Briefly press vehicle level control switch ①.

Indicator lamp ② goes out. The vehicle adjusts from raised level to normal level.

AMG adaptive sport suspension system (E 63 AMG)

Rear-axle level control

The rear-axle level control adjusts the vehicle level for the rear axle. The rear-axle level control is beneficial because it keeps the vehicle level at the rear axle constant, independent of the load. Your vehicle adjusts its ride height automatically to increase vehicle safety and to reduce fuel consumption.

Damping system

The damping system is controlled electronically and operates continuously. It adjusts the damping characteristics to the current operating and driving conditions. The

damping is adjusted individually for each wheel. Driving safety and tire comfort are increased.

The fine tuning of the damping is dependent on:

- your driving style
- road surface conditions
- your personal settings (Comfort, Sport, or Sport+)

When you start the engine, the Comfort driving mode is selected automatically.

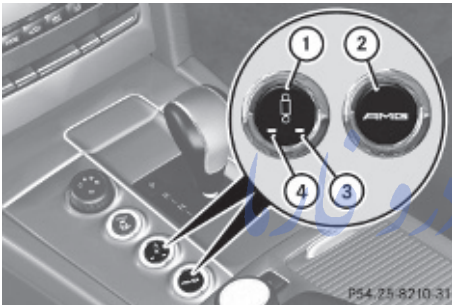

- ▶ Start the engine.

Sporty damping adjustment

The firmer suspension tuning in Sport driving mode provides enhanced road contact. Select this mode for example, on winding highways.

- ▶ Press damping system switch ①. Indicator lamp ④ comes on. The Sport driving mode with a firmer suspension tuning is selected. The message AMG Suspension System SPORT appears in the multifunction display.

Sport+ damping adjustment

The very firm chassis and suspension setup in Sport+ driving mode provides best possible road contact. Only select this setting for driving on closed circuits.

- ▶ Press damping system switch ① until indicator lamps ③ and ④ are on. The Sport+ driving mode is selected.

The message AMG Suspension System SPORT+ appears in the multifunction display.

Comfort damping adjustment

Vehicle handling in Comfort driving mode is softer. Select this mode when you prefer a more comfortable driving style on straight freeways.

- ▶ Press damping system switch ① until indicator lamps ③ and ④ are off. The Comfort driving mode is selected. The message AMG Suspension System COMFORT appears in the multifunction display.

Storing and calling up settings

When you have selected the driving mode (Comfort, Sport, or Sport+) and the program mode (▷ page 121), you can store, call up, and display the settings using AMG button ② when the engine is running. Pressing AMG button ② when the ignition is switched on, displays the current settings only.

- ▶ **Storing:** Press and hold AMG button ② until an acoustic signal sounds. The current settings are stored and appears in the multifunction display.
- ▶ **Calling up and displaying:** Press AMG button ②. The stored driving mode and program mode are in effect and the settings appear in the multifunction display.
- ▶ **Displaying:** Tap AMG button ②. The stored and/or currently active settings appear in the multifunction display.

Parktronic system

The Parktronic system with Parking Guidance is an electronic parking aid with ultrasonic sensors designed to assist the driver during parking maneuvers. The Parktronic system

indicates the relative distance between the vehicle and an obstacle visually and audibly.

The Parktronic system is activated automatically when

- you switch on the ignition and
- you release the parking brake and
- the automatic transmission is in drive position **D**, reverse gear **R**, or neutral position **N**

The Parktronic system deactivates at speeds above approximately 11 mph (18 km/h). At lower speeds, the Parktronic system activates again.

The Parktronic system also deactivates when you shift the automatic transmission into park position **P** or engage the parking brake. The Parktronic system monitors the surroundings of your vehicle with six sensors in the front bumper and four sensors in the rear bumper.

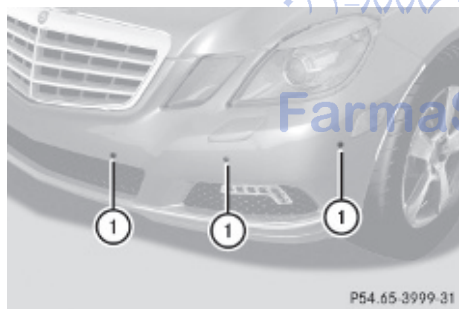

P54.65.3999.31

Example illustration, sensors in the front bumper

To function properly, sensors ① must be free of dirt, ice, snow and slush. Clean sensors ① regularly. Be careful not to scratch or damage sensors ①, see “Cleaning the driving systems sensors” (▷ page 263).

Warning!

The Parktronic is a supplemental system. It is not intended to, nor does it replace, the need for extreme care. The responsibility during

parking and other critical maneuvers always remains with the driver.

Warning!

Make sure no persons or animals are in or near the area in which you are parking/ maneuvering. Otherwise, they could be injured.

 Special attention must be paid to objects with smooth surfaces or low silhouettes (e.g. trailer couplings, painted posts, elevated crossbars or road curbs). Such objects may not be detected by the system and can damage the vehicle.

During parking maneuvers, pay special attention to objects located above or below the height of the sensors (e.g. street curbs, painted posts, or trailer hitches etc.). The Parktronic system will not detect such objects at close range and damage to your vehicle or the object may result.

 Ultrasonic signals from outside sources (e.g. truck air brakes, car wash, or jackhammers) may impair the operation of the Parktronic system.

Range of the sensors

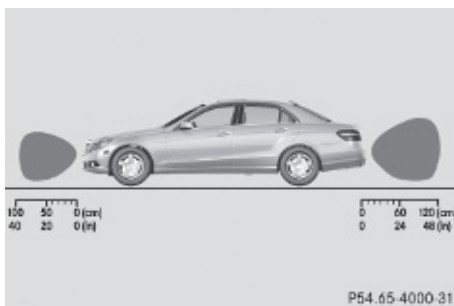

P54.65.4000.31

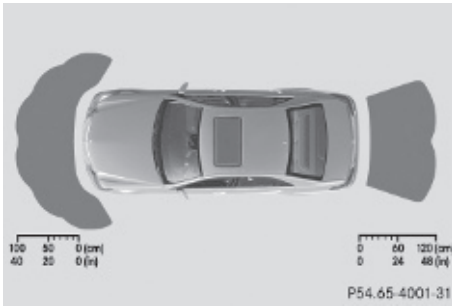

Front sensors

Center	approx. 40 in (100 cm)
Corners	approx. 24 in (60 cm)

Rear sensors

Center	approx. 48 in (120 cm)
Corners	approx. 32 in (80 cm)

Minimum distance

Center	approx. 8 in (20 cm)
Corners	approx. 6 in (15 cm)

If the Parktronic system detects an obstacle in this range, all the distance warning segments illuminate and you hear a warning signal. If the obstacle is closer than the minimum distance, the actual distance may no longer be indicated by the Parktronic system.

Warning indicators

Visual signals indicate the relative distance between the sensors and an obstacle.

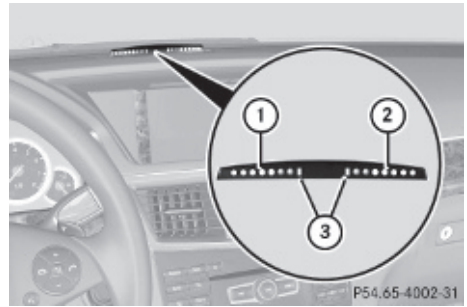

Front area warning indicators

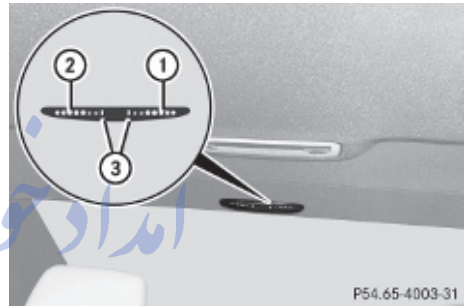

Rear area warning indicators

Each warning indicator is divided into five yellow and two red distance segments for left side ① and right side ② of the vehicle. The Parktronic system is ready to measure when the yellow readiness indicators ③ are illuminated.

The current transmission position determines which warning indicator will be activated.

Current transmission position	Warning indicator
D	Front area activated
R or N	Front and rear area activated

As your vehicle approaches an object, one or more distance segments will illuminate, depending on the distance. When the seventh distance segment illuminates, you have reached the minimum distance.

- **Front area:** An intermittent acoustic warning will sound as the first red distance segment illuminates and a constant acoustic warning lasting a maximum of 2 seconds will sound for the second red distance segment. The signal is canceled when the automatic transmission is shifted into park position **P** or the parking brake is engaged.
- **Rear area:** An intermittent acoustic warning will sound as the first red distance segment illuminates and a constant acoustic warning lasting a maximum of 2 seconds will sound for the second red distance segment. The signal is canceled when the automatic transmission is shifted into drive position **D**, or park position **P**, or the parking brake is engaged.

Switching the Parktronic system on/off

The Parktronic system switches on automatically when the ignition is switched on.

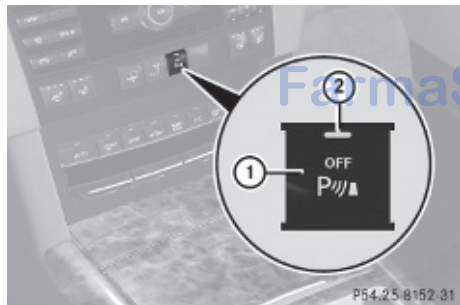

- ▶ **Switching off:** Press Parktronic switch ①. Indicator lamp ② comes on.
 - ▶ **Switching on:** Press Parktronic switch ① again.
- i** When you switch the Parktronic system on or off the Parking Guidance (▷ page 168) is also switched on or off.

Parktronic system malfunction

There is a malfunction in the Parktronic system, if only the red distance segments illuminate and an acoustic warning sounds. The Parktronic system will switch off automatically after 20 seconds and indicator lamp ② in Parktronic switch ① comes on.

- ▶ Have the Parktronic system checked at an authorized Mercedes-Benz Center as soon as possible.

If only the red distance segments illuminate and no acoustic warning sounds, the Parktronic system sensors are dirty (e.g. dirt, ice, snow and slush). Another cause could be interference from other radio or ultrasonic signals (e.g. truck air brakes, car wash, or jackhammers). The Parktronic system will switch off automatically after 20 seconds and indicator lamp ② in Parktronic switch ① comes on.

- ▶ Switch off the ignition.
- ▶ Clean the Parktronic system sensors (▷ page 263).
- ▶ Switch on the ignition.
or
- ▶ Check the Parktronic system operation at another location to rule out interference from outside radio or ultrasonic signals.

Parking Guidance

The Parking Guidance is part of the Parktronic system. With the Parktronic system switched on (▷ page 168), the Parking Guidance is also available.

The Parking Guidance is an electronic parking aid equipped with ultrasonic sensors. The ultrasonic sensors scan the area on both sides of vehicle. When a suitable parking space is found, it is indicated by a parking space symbol in the multifunction display. You will receive steering instructions for parking in that space.

⚠ Warning!

The Parking Guidance is only an aid and may display parking spaces that are not suitable for parking such as

- no-parking zones
- parking space with unsuitable road/ground surface
- driveways
- entrances/exits

The Parking Guidance scans for and measures potential parking spaces when driving past. Subsequent changes to the parking space are not taken into account. This may be the case if the position of the vehicle parked in front or behind the space changes or obstacles in the parking space are moved.

The Parking Guidance does not relieve you of the responsibility to pay attention. If you only rely on the Parking Guidance, you may cause an accident and injure yourself and others.

You are always responsible for safety and must continue to pay attention to your immediate surroundings when parking and maneuvering.

⚠ Warning!

The system cannot detect objects located above the area that the sensors scan. These objects, e.g. protruding load, overhang, or truck tail lifts, will be ignored when computing the parking procedure. The Parking Guidance might therefore provide untimely steering instructions. This could cause a collision. Thus, do not use the Parking Guidance in such situations.

⚠ Warning!

Make sure no persons or animals are in the area in which you are maneuvering. You could otherwise injure them.

- !** Special attention must be paid to objects with smooth surfaces or low silhouettes (e.g. trailer couplings, painted posts, elevated crossbars or road curbs). Such

objects may not be detected by the system and can damage the vehicle.

Use the Parking Guidance for parking spaces that are

- parallel to the direction of travel
- located on straight streets, i.e. not in curves
- on the same level as the street, i.e. not on sidewalks, for example.

Parking instructions:

- On narrow streets, drive by the parking space as close as possible.
- Parking spaces that are dirty, overgrown or located in front of trailers may not be detected correctly.
- Snowfall or heavy rain may cause imprecise measurement of the parking space.
- Also observe the Parktronic system warning indicator (> page 167) while the Parking Guidance is active.
- You may not use the Parking Guidance when transporting cargo that protrudes the vehicle.
- Do not use the Parking Guidance when driving with snow chains or when a spare wheel is mounted.
- How well your vehicle will be parked after completion of the Parking Guidance depends on the position and shape of the vehicles parked in front of and behind the parking space as well as the conditions of the immediate surroundings. In certain cases, the Parking Guidance may guide you too far into the parking space or not far enough. If this is the case, cancel the parking procedure with the Parking Guidance and correct the vehicle position yourself.

Detecting a parking space

The Parking Guidance is active when driving forward. The system operates at a vehicle

speed of up to 22 mph (35 km/h). It scans automatically for and measures potential parking spaces on both sides of the vehicle.

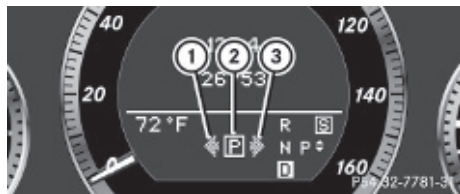

Example illustration

- ① Detected parking space on the left
- ② Parking space symbol
- ③ Detected parking space on the right

At a vehicle speed of below 19 mph (30 km/h), you see parking space symbol ② as a system display in the multifunction display.

When a parking space has been detected, an additional arrow to the right ③ or to the left ① appears.

In order to be detected by the Parking Guidance, a parking space must be

- parallel to the direction of travel
- at least 5 ft (1.5 m) wide
- at least 4.3 ft (1.3 m) longer than your vehicle is

A parking space is shown in the multifunction display when driving by until you have reached a distance of 50 ft (15 m) from the space. The Parking Guidance only shows parking spaces on the passenger side of the vehicle unless you activate the driver's side (left) turn signal. If you would like to park on the driver's side, the left turn signal must remain on until the reverse gear is engaged.

Parking

Warning!

The Parking Guidance is only an aid and may not detect all obstacles. The Parking Guidance does not relieve you of the responsibility to pay attention. You are always

responsible for safety and must continue to pay attention to your immediate surroundings when parking and maneuvering. Otherwise, you could endanger yourself and others.

- ▶ Bring the vehicle to a standstill as long as the desired parking space is displayed by the parking space symbol in the multifunction display.

- ▶ Shift the automatic transmission into reverse gear **R**.

The message **Check Vehicle Surroundings Press 'OK' to Confirm** appears in the multifunction display.

- ▶ Press **[OK]** on the multifunction steering wheel to confirm.

The display in the multifunction display changes to the Parking Guidance.

The message **Please Drive Backward** appears in the multifunction display, depending on the distance to the parking space.



Example illustration

- ▶ If applicable, drive straight backward a little.
An arrow pointing toward you indicates the backward direction.
- ▶ Drive straight backward until an acoustic signal sounds. Stop the vehicle. You have reached the stop position. The arrow is completely white.

The message **Please Steer Wheel to the Right** or **Please Steer Wheel to the Left** appears in the multifunction display.



Example illustration

- ▶ With the vehicle still standing, turn the steering wheel in the indicated direction until the arrow is completely white and an acoustic signal sounds.
- ▶ **Pulling into parking space:** Keep the steering wheel in position and drive backward carefully.
- ▶ Stop as soon as an acoustic signal sounds. The vehicle has reached the countersteering point. The message Please Steer Wheel to the Right or Please Steer Wheel to the Left appears in the multifunction display.
- ▶ **Countersteering:** With the vehicle still standing, turn the steering wheel in the indicated direction until the arrow is completely white and an acoustic signal sounds.
- ▶ **Pulling into parking space:** Keep the steering wheel in position and drive backward carefully.
- ▶ Stop as soon as an acoustic signal sounds. Stop the vehicle immediately when the Parktronic systems issues an audible, continuous warning signal. The message Parking Guidance Finished appears in the multifunction display and an acoustic signal sounds. You may be prompted to steer into a different direction and then shift the automatic transmission to a another position. The displays in the multifunction display will then guide you into the final park position.

- ▶ If necessary, adjust the end position by maneuvering as needed.
- ▶ Observe the warning indicators of the Parktronic system (▷ page 167).

Canceling the Parking Guidance

- ▶ Press the Parktronic switch (▷ page 168). The Parking Guidance is canceled immediately and the Parktronic system is deactivated.

The Parking Guidance is canceled automatically if guidance into the parking space is no longer possible or if an error occurs.

The parking space symbol disappears and the message Parking Guidance Canceled appears in the multifunction display.

Rear view camera

The rear view camera is an optical parking aid. The area behind the vehicle appears in the COMAND system display as a mirror image, like in the rear view mirror.

Warning!

Make sure no persons or animals are in or near the area in which you are parking/ maneuvering. Otherwise, they could be injured.

Warning!

The rear view camera is only an aid and may display obstacles

- from a distorted perspective
- inaccurately
- may not display obstacles at all

The rear view camera does not relieve you of the responsibility to be cautious. Take care and pay careful attention. The rear view camera may not show objects which are

- very close to the rear bumper
- under the rear bumper
- above the trunk handle

You are responsible for safety at all times and must continue to pay attention to the immediate surroundings when parking and maneuvering. This includes the area behind, in front of, and beside the vehicle. Otherwise you could endanger yourself and/or others.

Warning!

The rear view camera either will not function or will not function to its full capability if

- the trunk lid is open
- it is raining very hard, snowing or foggy
- it is night or you are parking/maneuvering your vehicle in an area where it is very dark
- the camera is exposed to a very bright white light
- the immediate surroundings are illuminated with fluorescent light (the COMAND system display can flicker)
- there is a sudden change in temperature, e.g. if you drive into a heated garage from the cold (lens condensation)
- the camera lens is dirty or covered
- the rear of your vehicle is damaged

In this case, have the position and setting of the camera checked by a qualified specialist workshop. Mercedes-Benz recommends that you contact a Mercedes-Benz Center for this purpose.

Do not use the rear view camera in these situations. Otherwise you could injure yourself or others and/or damage property including your vehicle while parking/maneuvering.

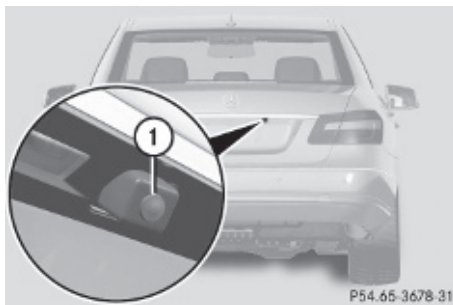

Camera lens ① must be free of dirt, ice, snow, and slush to function properly. Clean the camera lens regularly. Being careful not to scratch or damage the camera lens, see “Cleaning the rear view camera lens” (▷ page 263).

Switching on or off

- ▶ **Switching on:** Switch on the ignition.
- ▶ Make sure the rear view camera is switched on in the COMAND system. For more information refer to separate COMAND operating instructions.
- ▶ Switch on the COMAND system.
- ▶ Shift the automatic transmission to reverse gear **R**.
The area behind the vehicle appears in the COMAND system display.
- i** The image from the rear view camera will no longer be displayed if you select another function on the COMAND system while reverse gear **R** is engaged. To display the image again, disengage and reengage reverse gear **R**.
- ▶ **Switching off:** Shift the automatic transmission into park position **P**, neutral position **N**, or drive position **D**.

Night View Assist Plus

The Night View Assist Plus illuminates the road with infrared light in addition to the normal headlamps.

A camera at the top of the windshield measures the infrared light and shows a black-and-white image in the COMAND system display. The image in the COMAND system display corresponds to a road lit up by high-beam headlamps.

Warning!

The Night View Assist Plus is only an aid to support you while driving and cannot substitute your careful attention. Do not rely on the display of the Night View Assist Plus; instead, continue to look through the windshield. You are always responsible for safety and must drive in accordance with traffic conditions. Otherwise, you could endanger yourself and others.

The system may be impaired or unavailable when

- visibility is poor, e.g. due to snow, rain, fog, or heavy spray
- the camera area of the windshield is dirty, fogged up or covered by a sticker for example
- driving through curves or on inclines or declines

Warning!

The Night View Assist Plus cannot record objects immediately in front of or next to the vehicle. When maneuvering, continue to look through the windshield. Make sure no persons or animals are in the area in which you are maneuvering. You could otherwise injure them.

The Night View Assist Plus image in the COMAND system display is not impaired by the headlamps of approaching vehicles.

As a result, you can better follow the course of the road and detect obstacles earlier on.

- i** Infrared light is invisible to the human eye and thus does not blind. The Night View Assist Plus can remain switched on permanently even with oncoming traffic present.

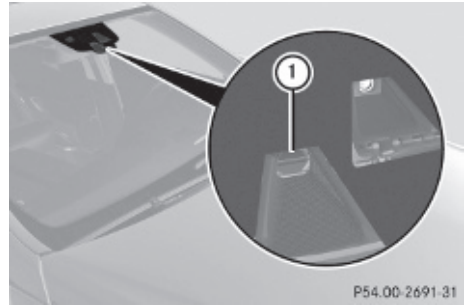

The Night View Assist Plus monitors the area in front of your vehicle via camera ①.

Switching on or off

You can only switch on the Night View Assist Plus if

- the SmartKey in the starter switch is set to position **2**
- it is dark
- the exterior lamp switch is set to **A** or 
- the automatic transmission is not in reverse gear **R**



► Switch on the COMAND system.

► Press button ①.

The Night View Assist Plus image appears in the COMAND system display.

For information on how to adjust the brightness of the COMAND system display, refer to the separate COMAND system operating instructions.

- i** The infrared headlamps only come on above a speed of approximately 6 mph (10 km/h). Therefore, when you are at a standstill, you do not have a complete view and cannot check the function of the Night View Assist Plus.

Pedestrian detection

The Night View Assist Plus detects pedestrians by means of specific characteristics, e.g. a human silhouette. Pedestrian detection is activated when

- the Night View Assist Plus is switched on
- the vehicle speed is above approximately 6 mph (10 km/h)
- driving in darkness, e.g. on highways without road lighting



- ① Night View Assist Plus image
- ② Detected pedestrian
- ③ Frame
- ④ Symbol for active pedestrian detection

When pedestrian detection is active, symbol ④ appears in the Night View Assist Plus image. Once a pedestrian is detected, that pedestrian is highlighted by frame ③. When you have been made aware of a pedestrian, assess the situation by looking through the windshield. The actual distance between your vehicle and objects or pedestrians cannot be assessed properly via a screen display.

Other objects apart from pedestrians may also be highlighted.

Warning!

The pedestrian detection may be impaired or unavailable when

- pedestrians are obstructed fully or in part by other objects such as parking vehicles
- the silhouette in the Night View Assist Plus image is displayed incomplete or interrupted, e.g. by significant light reflection
- a pedestrian's silhouette is not rich enough in contrast compared to the background
- pedestrians are not in erected position but, for example, sit, crouch down, or lie

- i** Animals cannot be detected.

Dirty or fogged-up windshield

The Night View Assist Plus image is diminished when the windshield in front of the camera is

- dirty
- fogged up on the outside
- fogged up on the inside

Warning!

Please do not forget that your primary responsibility is to drive the vehicle. A driver's attention to the road must always be his/her primary focus when driving. For your safety and the safety of others, stop before trying to remove window fogging or cleaning the windshield in front of the Night View Assist Plus camera.

Bear in mind that at a speed of just 30 mph (approximately 50 km/h), your vehicle is covering a distance of 44 feet (approximately 14 m) every second.

- ▶ **Removing condensation:** Check settings of the climate control and change them, if necessary (▷ page 181).
- ▶ Swing the camera cover downward (▷ page 263).

- ▶ **Cleaning inside of windshield:** Use a soft, non-scratching cloth (▷ page 263).

Blind Spot Assist

The Blind Spot Assist uses radar sensors to monitor the area on both sides of your vehicle. It will assist you when you change lanes driving at speeds of above 20 mph (30 km/h). A red warning lamp will come on in the exterior rear view mirror as soon as another vehicle is detected. If you then activate the corresponding turn signals to change lanes, the red warning lamp flashes and warning sounds (collision warning). The Blind Spot Assist operates using sensors in the rear bumper.

Warning!

The Blind Spot Assist is only a driving aid and may not detect all vehicles.

The Blind Spot Assist may not be able to detect narrow vehicles such as motorcycles or bicycles, or it may not detect them until it is too late.

The monitoring function may be impaired if your sensors are dirty, subject to heavy spray, or if visibility is poor due to e.g. snow, rain, or fog. This can result in vehicles not being detected or being detected too late.

The Blind Spot Assist cannot detect road, traffic and weather conditions.

It is the driver's responsibility at all times to be attentive to road, weather and traffic conditions and to provide the steering, braking and other driving inputs necessary to retain control of the vehicle. Failure to do so could result in recognizing dangers too late, possibly resulting in an accident and serious injury to yourself and others.

In order for the Blind Spot Assist to function, the radar sensors must be switched on and operational.

When traveling in Canada in a vehicle not registered in Canada, you must switch off the radar sensor system (▷ page 144). Canadian

law does not permit the use of the radar sensor system for vehicles from outside of Canada. When you switch off the radar sensor system, the following functions are deactivated:

- Blind Spot Assist
- BAS PLUS (▷ page 63)
- PRE-SAFE® Brake (▷ page 69)
- DISTRONIC PLUS (▷ page 149)

USA only:

This device has been approved by the FCC as a "Vehicular Radar System". The radar sensor is intended for use in an automotive radar system only. Removal, tampering, or altering of the device will void any warranties, and is not permitted by the FCC. Do not tamper with, alter, or use in any non-approved way.

Any unauthorized modification to this device could void the user's authority to operate the equipment.

Canada only:

This device complies with RSS-210 of Industry Canada. Operation is subject to the following two conditions:

1. This device may not cause interference, and
2. this device must accept any interference received, including interference that may cause undesired operation of the device.

Removal, tampering, or altering of the device will void any warranties, and is not permitted. Do not tamper with, alter, or use in any non-approved way.

Any unauthorized modification to this device could void the user's authority to operate the equipment.

Sensor monitoring range

The Blind Spot Assist is able to monitor a range up to 10 ft (3 m) to the rear and both sides of the vehicle.

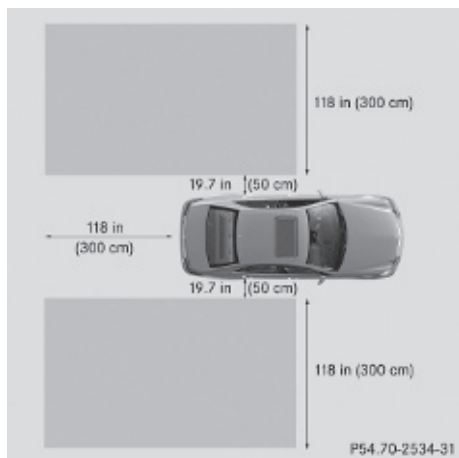

⚠ Warning!

The Blind Spot Assist monitors certain areas in the immediate vicinity of your vehicle. Vehicles approaching and passing at speeds that exceed the speed of your vehicle significantly will not be detected. There will be no warning display and no audible warning.

When driving in a very wide lane, the sensors may not be able to cover the entire width of the neighboring lane. Vehicles driving on the outside of the neighboring lane may not be detected.

It is the driver's responsibility at all times to be attentive to road, weather and traffic conditions and to provide the steering, braking and other driving inputs necessary to retain control of the vehicle. Failure to do so could result in recognizing dangers too late, possibly resulting in an accident and serious injury to yourself and others.

When driving in a very narrow lane, the sensors may detect and display vehicles in the second lane over. This will be the case if there are vehicles driving on the inside edge of their lane.

The system may issue causeless warnings in the area of guardrails or similar structural boundaries.

The two Blind Spot Assist sensors are built into the rear bumper. Make sure that the area

of the bumper around the sensors is free of dirt, ice and snow. The radar sensors must not be obstructed, for example, by bicycle carriers or overhanging luggage.

❗ In the event of a significant impact or damage affecting the bumpers, have the radar sensors checked by a qualified specialist workshop such as a Mercedes-Benz Center. Failure to do this can result in Blind Spot Assist not functioning correctly.

Indicator and warning lamps

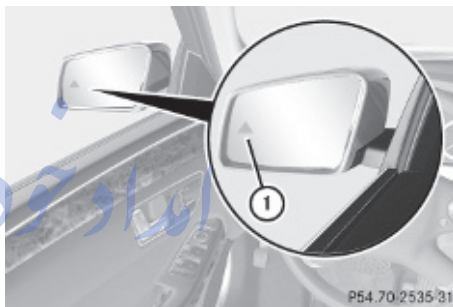

Exterior rear view mirror, driver's side

- ▶ Make sure that the radar sensors (▷ page 144) and Blind Spot Assist (▷ page 138) are switched on.
- ▶ Switch on the ignition. Red warning lamps ① in the exterior rear view mirrors come on.
- ▶ Start the engine. Yellow indicator lamps ① in the exterior rear view mirrors come on up to a speed of 20 mph (30 km/h).

Above a speed of 20 mph (30 km/h), yellow indicator lamps ① go out and the Blind Spot Assist is active. If the Blind Spot Assist detects a vehicle in its range, red warning lamp ① on the corresponding side of the vehicle comes on. The warning is issued each time a vehicle enters the area monitored by the Blind Spot Assist from behind or from the side. When you pass another vehicle, the warning is issued only when the speed differential is less than 7 mph (12 km/h).

When you shift the automatic transmission in reverse gear **R**, yellow indicator lamps ① in the exterior rear view mirrors goes out after approximately 3 seconds. The Blind Spot Assist is then not active.

The brightness of indicator lamps/warning lamps ① is controlled automatically depending on the brightness of the ambient light.

Warning!

The Blind Spot Assist is not active at speeds below approximately 20 mph (30 km/h). The yellow indicator lamps in the exterior rear view mirrors are illuminated. You will not be alerted to the presence of vehicles in the monitored area at these speeds.

It is the driver's responsibility at all times to be attentive to road, weather and traffic conditions and to provide the steering, braking and other driving inputs necessary to retain control of the vehicle. Failure to do so could result in recognizing dangers too late, possibly resulting in an accident and serious injury to yourself and others.

Collision warning

If a vehicle is detected in the Blind Spot Assist range and you activate the turn signal, a two-tone warning will sound once. Red warning lamp ① on the corresponding side of the vehicle will flash.

Warning!

Do not change lanes or make turns, while red warning lamp ① is flashing. Doing so could result in an accident and serious injury to yourself and others.

- ▶ Remain on the lane that you are currently on until traffic conditions permit to change.

If the turn signal remains on, red warning lamp ① will flash to indicate that vehicles have been detected. No further audible warnings will sound.

Lane Keeping Assist

The Lane Keeping Assist supports you at a vehicle speed of above 40 mph when you have set the display unit to miles in the Display Unit Speed-/Odometer: menu in the control system (> page 141). When you have set the display unit to km, the system supports you at a vehicle speed of above 60 km/h. When the Lane Keeping Assist detects lane markings, the system is designed to alert you in case you leave your lane unintentionally. A warning is usually issued when a front wheel is on the lane marking. An interval vibration in the steering wheel that lasts for up to 1.5 seconds will then alert you.

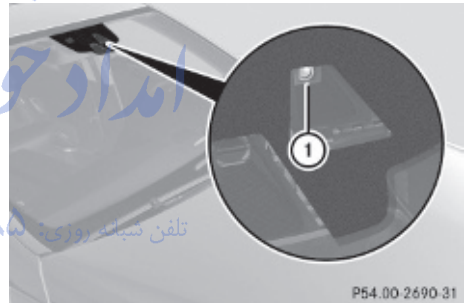

The Lane Keeping Assist monitors the area in front of your vehicle via camera ①.

The system can distinguish various conditions in order to alert you early enough and to avoid unnecessary warnings when crossing lane markings.

The warning is issued sooner when

- cutting a curve on the outside of the turn
- driving on very wide lanes such as highway lanes
- the system recognizes dividing lines because crossing them is often crucial due to soft shoulders or guardrails behind for example

The warning is issued later however when

- driving on narrow lanes
- cutting a curve on the inside of the turn

The system does not issue a warning when

- steering, braking, or accelerating in a clearly active manner, e.g. when changing lanes, passing, exiting a highway
- cutting a narrow curve
- making a very sharp turn
- a driving safety system such as the ABS, the BAS, or the ESC has been activated

When setting the turn signal in either direction, the warning will be suppressed. The system will issue a warning if a turn signal has been on for an extended period of time.

Warning!

The Lane Keeping Assist does not keep the vehicle in the lane. The Lane Keeping Assist is only an aid to the driver and may not always recognize lane markings properly or fail to recognize them at all.

The system may be impaired or unavailable when

- visibility is poor, e.g. due to snow, rain, fog, or heavy spray
- oncoming traffic, sun glare or reflection from other vehicles
- the camera area of the windshield is dirty, foggy, or otherwise obstructed
- lane markings are not present
- lane markings are worn, dark, or covered e.g. by snow or dirt
- the distance to the preceding vehicle is too short
- when lane markings are ambiguous, for example in road work sections
- lane markings change rapidly, e.g. on highway exits or turn-off lanes
- lanes are narrow and winding

The Lane Keeping Assist cannot take road and traffic conditions into account. It is the driver's responsibility at all times to be attentive to road, weather and traffic

conditions and to provide the steering, braking and other driving inputs necessary to retain control of the vehicle. Failure to do so could result in recognizing dangers too late, possibly resulting in an accident and serious injury to yourself and others.

Switching on or off



Example illustration

- Switch on or off the Lane Keeping Assist via the control system (▷ page 138). Lane Keeping Assist indicator ① appears in the multifunction display.

ATTENTION ASSIST

The ATTENTION ASSIST supports you during long, monotonous rides, e.g. on freeways and highways. The ATTENTION ASSIST is active at a vehicle speed of between 50 mph (80 km/h) and 112 mph (180 km/h). Always obey applicable speed limits. The ATTENTION ASSIST suggests to take a rest when recognizing fatigue or increasing inattentiveness of the driver.

Warning!

The ATTENTION ASSIST is only an aid to the driver. It might not recognize fatigue or increasing inattentiveness in time or fail to recognize them at all. The system cannot substitute a rested and attentive driver.

Fatigue can cause you to recognize dangers too late, to misjudge potential dangers, or to react slower. Therefore, make sure to be rested before and during your trip. Take rests early enough and regularly, especially during long trips. Failure to do so could cause you to

recognize dangers too late which could result in an accident and serious injury to you and/or others.

The ATTENTION ASSIST interprets your fatigue or increasing inattentiveness considering the following criteria:

- the individual driving style, for example the way you steer
- the driving conditions such as time of day and duration of the ride

The ATTENTION ASSIST function is restricted and warnings will be delayed or not issued at all when

- road conditions are bad, e.g. heavy bumps or potholes
- crosswinds are strong
- driving in a sporty manner with high speed in curves or rapid acceleration
- driving slower than 50 mph (80 km/h) or faster than 112 mph (180 km/h) most of the time
- operating the COMAND or making phone calls via COMAND
- changing lanes or varying the vehicle speed, i.e. you intervene actively

- ▶ Switch on the ATTENTION ASSIST via the control system (▷ page 138). ATTENTION ASSIST indicator ① appears in the multifunction display.

When the ATTENTION ASSIST is active, it will warn you after 20 minutes of driving at the earliest. An intermittent warning will then sound twice and the message Attention Assist: Time for a rest? appears in the multifunction display.

- ▶ If possible park your vehicle in a safe location and take a rest.
- ▶ Confirm the message by pressing button on the multifunction steering wheel.

If you do not take a rest and the ATTENTION ASSIST continues to recognize fatigue or increasing inattentiveness, you will be warned once more after 15 minutes at the earliest.

During long trips, take regular and duly rests that allow you to recover sufficiently.

The ATTENTION ASSIST will be reset and restarts evaluating the degree of your fatigue when *تلفن شماره روز*

- you turn off the engine
- you release the seat belt and open the driver's door, e.g. during a rest or for a driver change

Warnings and displays in the multifunction display



Example illustration

Climate control system

Overview of climate control system functions

Your vehicle is equipped with either of the following climate control systems:

Dual-zone automatic climate control



P83.25-2397-31

USA only



P83.25-2364-31

Canada only

The dual-zone automatic climate control combines an automatic heating and ventilation system with a cooling system. You can adjust the dual-zone automatic climate control separately for the driver's and passenger side.

3-zone automatic climate control



P83.25-2365-31

Canada only

The 3-zone automatic climate control combines an automatic heating and ventilation system with a cooling system. You can adjust the 3-zone automatic climate control separately for each zone in the vehicle.

Rear climate control



P83.25-2380-31

Canada only

The rear climate control allows separate climate settings for the rear compartment.

Control panels

Dual-zone automatic climate control

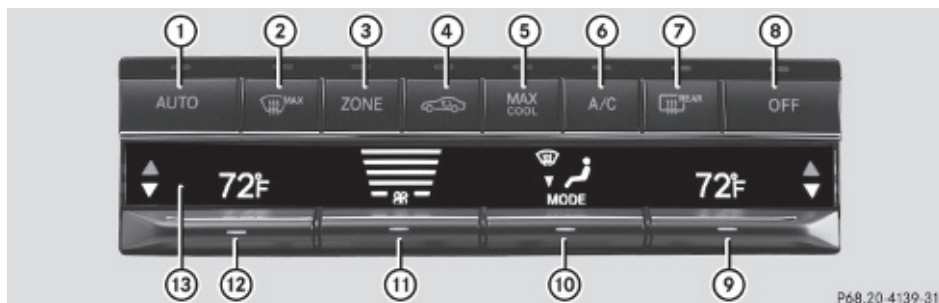

USA only

	Function	Recommendation/Notes	
①	Air distribution and air volume (automatic mode)	i Switch on the automatic mode. The indicator lamp above button AUTO comes on.	(▷ page 186)
②	Front defroster	i Keep this setting selected only until the windshield and the front door windows are clear again.	(▷ page 189)
③	ZONE-function on/off		(▷ page 191)
④	Air recirculation	i Only use this function for a short time, e.g. in a tunnel. Otherwise, the windows can fog up due to lack of fresh air.	(▷ page 190)
⑤	MAX COOL function on/off		(▷ page 190)
⑥	A/C cooling on/off	i Switch on/off the air conditioning.	(▷ page 185)
⑦	Rear window defroster		(▷ page 191)
⑧	Climate control on/off	i Switch on/off the climate control system.	(▷ page 185)
⑨	Temperature control, passenger side	i Set the temperature to 72°F (22°C).	(▷ page 186)
⑩	Air distribution		(▷ page 189)
⑪	Air volume		(▷ page 189)

Function	Recommendation/Notes	
⑫ Temperature control, driver's side	i Set the temperature to 72°F (22°C).	(▷ page 186)
⑬ Display		

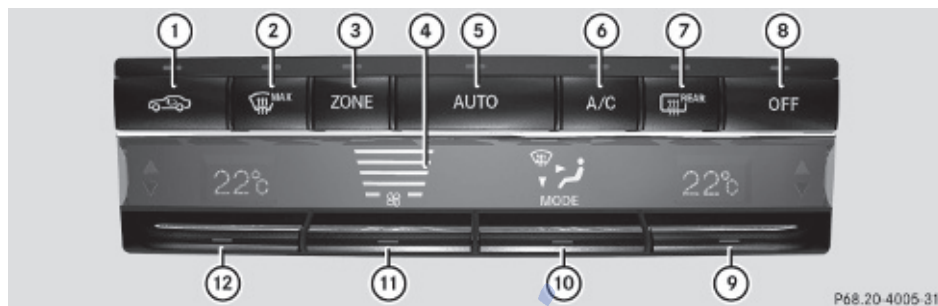

P68.20-4005-31

Canada only

Function	Recommendation/Notes	
① Air recirculation	i Only use this function for a short time, e.g. in a tunnel. Otherwise, the windows can fog up due to lack of fresh air.	(▷ page 190)
② Front defroster	i Keep this setting selected only until the windshield and the front door windows are clear again.	(▷ page 189)
③ ZONE-function on/off		(▷ page 191)
④ Display		
⑤ Air distribution and air volume (automatic mode)	i Switch on the automatic mode. The indicator lamp above button AUTO comes on.	(▷ page 186)
⑥ A/C cooling on/off	i Switch on/off the air conditioning.	(▷ page 185)
⑦ Rear window defroster		(▷ page 191)
⑧ Climate control on/off	i Switch on/off the climate control system.	(▷ page 185)
⑨ Temperature control, passenger side	i Set the temperature to 72°F (22°C).	(▷ page 186)
⑩ Air distribution		(▷ page 189)

	Function	Recommendation/Notes	
⑪	Air volume		(▷ page 189)
⑫	Temperature control, driver's side	i Set the temperature to 72°F (22°C).	(▷ page 186)

3-zone automatic climate control

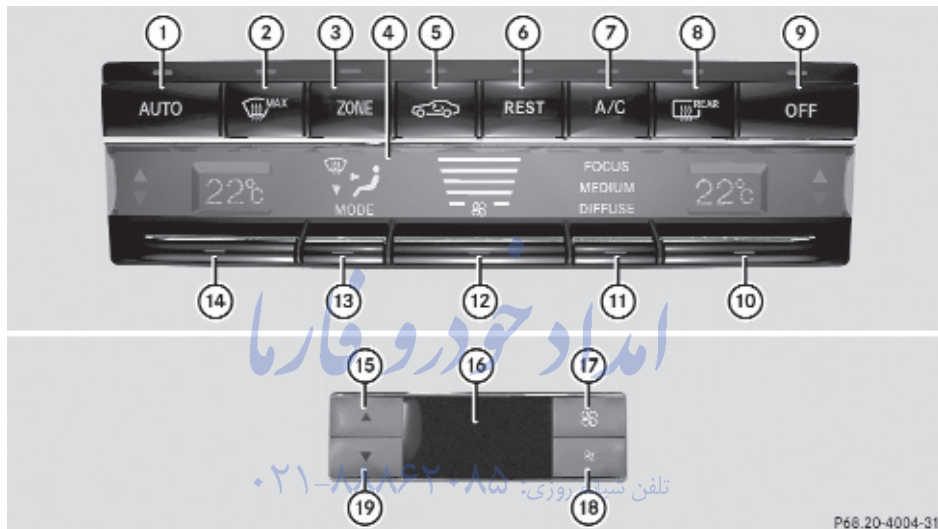

P68.20-4004-31

Canada only

	Function	Recommendation/Notes	
Front climate control panel			
①	Air distribution and air volume (automatic mode)	i Switch on the automatic mode. The indicator lamp in button AUTO comes on.	(▷ page 186)
②	Front defroster	i Keep this setting selected only until the windshield and the front side windows are clear again.	(▷ page 189)
③	ZONE-function on/off		(▷ page 191)
④	Display		
⑤	Air recirculation	i Only use this function for a short time, e.g. in a tunnel. Otherwise, the windows can fog up due to lack of fresh air.	(▷ page 190)

Function	Recommendation/Notes	
⑥ Residual heat/ventilation	i With the engine turned off, it is possible to continue to heat or ventilate the interior.	(▷ page 191)
⑦ A/C cooling on/off	i Switch on/off the air conditioning.	(▷ page 185)
⑧ Rear window defroster		(▷ page 191)
⑨ Climate control on/off	i Switch on/off the climate control system.	(▷ page 185)
⑩ Temperature control, passenger side	i Set the temperature to 72°F (22°C).	(▷ page 186)
⑪ Controls the climate control automatically (FOCUS/MEDIUM/DIFFUSE)		
⑫ Air volume		(▷ page 189)
⑬ Air distribution		(▷ page 189)
⑭ Temperature control, driver's side	i Set the temperature to 72°F (22°C).	(▷ page 186)
Rear climate control panel		
⑮ Temperature control, raising	i Set the temperature to 72°F (22°C).	(▷ page 186)
⑯ Display		
⑰ Increasing air volume		(▷ page 189)
⑱ Decreasing air volume		(▷ page 189)
⑲ Temperature control, lowering	i Set the temperature to 72°F (22°C).	(▷ page 186)

Notes on climate control system

The climate control system is operational whenever the engine is running. You can

operate the climate control system in either the automatic or manual mode. The system cools or heats the interior depending on the selected interior temperature.

It can only function optimally when you are driving with the windows, the tilt/sliding sunroof or tilt/sliding panel closed.

Nearly all dust particles, pollutants and odors are filtered out before outside air enters the passenger compartment through the air distribution system.

Warning!

Severe conditions (e.g. strong air pollution) may require replacement of the filter before its scheduled replacement interval. A clogged filter will reduce the air volume to the interior and the windows could fog up, impairing visibility and endangering you and others. Have a clogged filter replaced as soon as possible at an authorized Mercedes-Benz Center.

The air conditioning will not engage (no cooling) if the **A/C** mode ( page 185) is deactivated.

Warning!

Follow the recommended settings for heating and cooling given on the following pages. Otherwise the windows could fog up, impairing visibility and endangering you and others.

- ▶ Keep the air intake grille in front of the windshield free of snow and debris.



Do not obstruct air flow by placing objects on the air flow-through exhaust slots below the rear window.

- i** If the vehicle interior is hot, ventilate the interior before driving off, see “Summer opening feature” ( page 107). The climate control will then adjust the interior temperature to the set value much faster.

Deactivating the climate control system

Warning!

When the climate control system is deactivated, the outside air supply and circulation are also deactivated. Only choose this setting for a short time. Otherwise the windows could fog up, impairing visibility and endangering you and others.

- ▶ **Deactivating:** Press button . The indicator lamp above the button comes on.
 - ▶ **Reactivating:** Press button . The indicator lamp above the button goes out. The previous settings are once again in effect.
- or
- ▶ Press button . The indicator lamp above the button comes on. Air volume and air distribution are adjusted automatically.

Air conditioning

The air conditioning is operational while the engine is running and cools the interior air to the temperature set by the operator. In addition, the air conditioning dehumidifies the interior air and helps prevent window fogging.

Warning!

If you deactivate the air conditioning, the vehicle will not be cooled when weather conditions are warm. The windows can fog up more quickly. Window fogging may impair visibility and endanger you and others.

- i** Condensated water may drip out from underneath the vehicle. This is normal and not an indication of a malfunction.

The air conditioning uses the refrigerant R134a. This refrigerant is free of CFCs which are harmful to the ozone layer.

Deactivating

It is possible to deactivate the air conditioning. The interior air will then no longer be cooled or dehumidified.

- ▶ Press button .
 - The indicator lamp above the button goes out.
 - The cooling function switches off after a short delay.

Activating

Moist air can fog up the windows. You can dehumidify the interior air with the air conditioning.

- ▶ Press button .
 - The indicator lamp above the button comes on.

Automatic mode







When operating the climate control system in automatic mode, the interior air temperature, air volume and air distribution are adjusted automatically.

In automatic mode, cooling with dehumidification is switched on. This function can be switched off if necessary.



Warning!

If you deactivate the air conditioning, the vehicle will not be cooled when weather conditions are warm. The windows can fog up more quickly. Window fogging may impair visibility and endanger you and others.

Dual-zone automatic climate control



- ▶ Set the desired temperature (▷ page 186).
 - ▶ **Activating:** Press button .
 - The indicator lamp above the button comes on. The air volume and air distribution are adjusted automatically.
 - ▶ **Deactivating:** Press rocker switch  or  (▷ page 181).
- or
- ▶ Press button  or button  (USA only)
 - The indicator lamp above button  goes out.

3-zone automatic climate control

- ▶ Set the desired temperature (▷ page 186).
- ▶ **Activating:** Press button .
 - The indicator lamp above the button comes on. The air volume and air distribution are adjusted automatically.
- ▶ Press rocker switch  (▷ page 183) up or down and select the desired level.

The automatic air conditioning settings:

- FOCUS Air flow high/air distribution via the center and side air vents
- MEDIUM Air flow medium/air distribution via the center and side air vents
- DIFFUSE Air flow low/air distribution via the center, side and defroster air vents

- ▶ **Deactivating:** Press rocker switch  or  (▷ page 183).
 - The indicator lamp above button  goes out.

Setting temperature

Dual-zone automatic climate control

You can adjust the air temperature on each side of the passenger compartment. You should raise or lower the temperature setting

in small increments, preferably starting at 72°F (22°C).

- **Increasing/decreasing:** Press rocker switch ⑨ or ⑫ (▷ page 181) up or down.

3-zone automatic climate control

You can set the air temperature for each of the 3 zones separately. You should raise or lower the temperature setting in small increments, preferably starting at 72°F (22°C).



Front zones

- **Increasing/decreasing:** Press rocker switch ⑩ or ⑭ (▷ page 183) up or down.

Rear zones

- **Increasing/decreasing:** Press rocker switch ⑩ or ⑭ (▷ page 183) up or down.

Rear climate control

- **Increasing/decreasing:** Press button ⑮ or ⑰ (▷ page 183).

Adjusting air vents

⚠ Warning!

When operating the climate control, the air that enters the passenger compartment through the air vents can be very hot or very cold (depending on the set temperature). This may cause burns or frostbite to unprotected skin in the immediate area of the air vents.

Always keep sufficient distance between unprotected parts of the body and the air vents. If necessary, use the air distribution adjustment to direct the air to air vents in the vehicle interior that are not in the immediate area of unprotected skin.

For best possible performance of the climate control:

- Keep the air intake grille in front of the windshield free of snow, leaves, sticks, and any other debris.
- Always keep all air vents and grilles in the passenger compartment free from obstruction.
- ⓘ For draft-free ventilation, move the adjustable center and side air vents to the middle position.

Center air vents

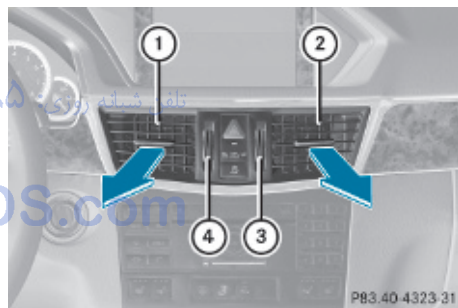

- ① Left center air vent, adjustable
- ② Right center air vent, adjustable
- ③ Thumbwheel for air volume control for adjustable right center air vent
- ④ Thumbwheel for air volume control for adjustable left center air vent

- **Opening/closing:** Turn thumbwheels ③ and ④ upward or downward.

Side air vents

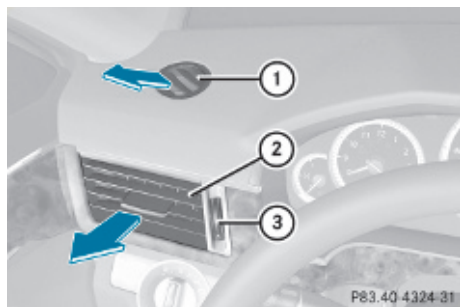

Example illustration driver's side

- ① Left side defroster air vent, fixed
- ② Left side air vent, adjustable
- ③ Thumbwheel for air volume control for adjustable left side air vent

► **Opening/closing:** Turn thumbwheel ③ upward or downward.

Ventilated glove box

The glove box can be ventilated, for instance to cool its contents, when the climate control system is activated. The level of airflow to the glove box depends on the airflow and air distribution settings. The temperature of the air is approximately the same as that of the air flowing from the center air vents.

❗ Close the glove box air vent when heating the vehicle interior. Activate the air conditioning (cooling function) when the outside temperature is high. Otherwise, temperature-sensitive items stored in the glove box could be damaged.

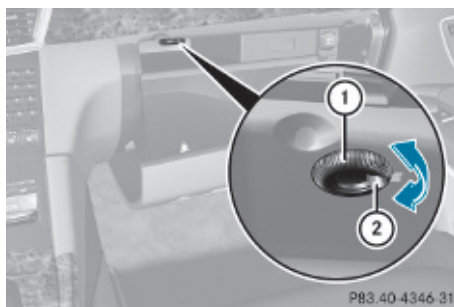

- ① Thumbwheel
- ② Air vent

► **Opening/closing:** Turn thumbwheel ① clockwise or counterclockwise.

Rear center console air vents



- ① Thumbwheel for air volume control for rear center air vents
- ② Right rear center air vent, adjustable
- ③ Rear climate control panel (3-zone automatic climate control, Canada only)
- ④ Left rear center air vent, adjustable

► **Opening/closing:** Turn thumbwheel ① upward or downward.

B-pillar air vents

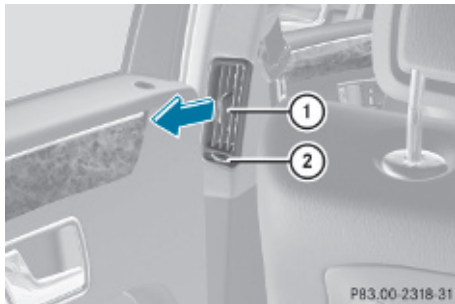

Vehicles with 3-zone automatic climate control, Canada only

① Side air vent, adjustable

② Thumbwheel for air volume control for side air vent

► **Opening/closing:** Turn thumbwheel ② to the left or to the right.

Adjusting air distribution

USA only: The symbols shown in display ⑬ (▷ page 181) on the climate control panel represent the following functions:

Canada only: The symbols shown in display ④ (▷ page 181) or ⑬ (▷ page 183) on the climate control panel represent the following functions:

Symbol	Function
	Directs air through the defroster air vents to the windshield and door windows
	Directs air through the center and side air vents
	Directs air through the center and side air vents and to the footwells, USA only
	Directs air through the center, side and defroster air vents to the windshield and door windows, Canada only

Symbol Function

	Directs air to the footwells
	Directs air through the defroster air vents to the windshield and door windows and to the footwells

► **USA only:** Press rocker switch ⑩ (▷ page 181) up or down until you have selected the desired setting and the corresponding symbol is shown in display ⑬.

► **Canada only:** Press rocker switch ⑩ (▷ page 181) or ⑬ (▷ page 183) up or down until you have selected the desired setting and the corresponding symbol is shown in display ④.

Adjusting air volume

Dual-zone automatic climate control

► **Decreasing/increasing:** Press rocker switch ⑪ (▷ page 181) up or down.

3-zone automatic climate control

► **Decreasing/increasing:** Press rocker switch ⑫ (▷ page 183) up or down.

Rear air volume control with the rear climate control panel

► **Decreasing/increasing:** Press button ⑰ or ⑱ (▷ page 183).

Front defroster

You can use this setting to defrost the windshield, for example if it is iced up.

You can also defog the windshield and the front door windows.

i Keep this setting selected only until the windshield or the front door windows are clear again.

► **Activating:** Press button .

The indicator lamp above the button comes on.

The climate control switches to the following functions automatically:

- cooling on to dehumidify
- most efficient blower speed and heating power, depending on outside temperature
- air flows onto the windshield and the front door windows
- the air recirculation mode is switched off

i You can adjust the air volume when the front defroster is switched on.

► **Deactivating:** Press button . The indicator lamp above the button goes out. The previous settings are once again in effect. The cooling remains switched on. The air recirculation remains switched off.



or



► Press button .

The indicator lamp above button  goes out. Air volume and air distribution are adjusted automatically.

or

► **Dual-zone automatic climate control:**

Press rocker switch  or  (> page 181) up or down.

3-zone automatic climate control: Press rocker switch  or  (> page 183) up or down.

Maximum cooling MAX COOL

MAX COOL is only available in U.S. vehicles. MAX COOL is only operational when the engine is running.

You can use this setting to provide the fastest possible cooling of the vehicle interior (when

windows and tilt/sliding sunroof or tilt/sliding panel are closed).

► **Activating:** Press button .

The indicator lamp above the button comes on.

The climate control switches automatically to the following functions:

- maximum cooling
- maximum blowing power
- the air recirculation mode is switched on

► **Deactivating:** Press button  again.

The indicator lamp above the button goes out. The previous settings are once again in effect.

Air recirculation mode

Switch to air recirculation mode to prevent unpleasant odors from entering the vehicle from the outside (e.g. before driving through a tunnel). This setting cuts off the intake of outside air and recirculates the air in the passenger compartment.

Warning!

Fogged windows impair visibility, endangering you and others. If the windows begin to fog on the inside, switching off the air recirculation mode immediately should clear interior window fogging. If interior window fogging persists, make sure the air conditioning is activated, or press button



► **Activating:** Press button .

The indicator lamp above the button comes on.

i The air recirculation mode is activated automatically at high outside temperatures.

The indicator lamp in button  is not lit when the air recirculation mode is switched on automatically.

A quantity of outside air is added after approximately 30 minutes.

► **Deactivating:** Press button  again. The indicator lamp above the button goes out.

- i** The manually selected air recirculation mode is deactivated automatically:
- after 5 minutes if the outside temperature is below approximately 41°F (5°C)
 - after 5 minutes if the air conditioning is turned off
 - after 30 minutes if the outside temperature is above approximately 41°F (5°C)

Residual heat and ventilation

This feature is only available in Canada vehicles with 3-zone automatic climate control.

With the engine turned off, it is possible to continue to heat or ventilate the interior for up to 30 minutes. This feature makes use of the residual heat produced by the engine.

- i** If you switch on the residual heat function when outside temperatures are high, only the ventilation will be switched on.

► **Activating:** Switch off the ignition.
 ► Press button . The indicator lamp above the button comes on.

► **Deactivating:** Press button . The indicator lamp above the button goes out.



The residual heat is deactivated automatically:

- when the ignition is switched on
- after approximately 30 minutes
- if the battery voltage drops

ZONE function

The temperature can be adjusted for each zone individually.

Dual-zone automatic climate control

► **Activating:** Press button , rocker switch  (▷ page 181) or rocker switch  (▷ page 183).

The indicator lamp above button  comes on.

The temperature can be adjusted for each zone individually.

► **Deactivating:** Press button . The indicator lamp above the button goes out.

The temperature can be adjusted for all zones via the driver's-side settings.

3-zone automatic climate control

► **Activating:** Press button . The indicator lamp above the button comes on.

The temperature can be adjusted for each zone individually.

► **Deactivating:** Press button . The indicator lamp above the button goes out.

The temperature can be adjusted for all zones via the driver's-side settings.

Rear window defroster

Warning!

Any accumulation of snow and ice should be removed from the rear window before driving. Visibility could otherwise be impaired, endangering you and others.

The rear window defroster uses a large amount of power. To keep the battery drain to a minimum, switch off the defroster as soon as the rear window is clear. The defroster is switched off automatically after

some time of operation depending on the outside temperature.

► Switch on the ignition.

► **Switching on:** Press button .

The indicator lamp above the button comes on.

► **Switching off:** Press button  again.

The rear window defroster switches off when the battery voltage is too low. Too many electrical consumers may be operating simultaneously.

► Switch off consumers that are currently not needed if required.

Power tilt/sliding sunroof

Opening and closing

 **Observe Safety notes, see page 56.**

Warning!

When opening or closing the tilt/sliding sunroof, make sure there is no danger of anyone being harmed by the opening/closing procedure.

The tilt/sliding sunroof is equipped with the express operation and automatic reversal function. If the movement of the tilt/sliding sunroof is blocked during the closing procedure, the tilt/sliding sunroof will stop and open slightly.

The tilt/sliding sunroof operates differently when the sunroof switch is pressed and held. See the “Closing when the tilt/sliding sunroof is blocked” section for details.

The opening/closing procedure of the tilt/sliding sunroof can be immediately halted by releasing the sunroof switch or, if the sunroof switch was moved past the resistance point and released, by moving the sunroof switch in any direction.

Warning!

The tilt/sliding sunroof is made out of glass. In the event of an accident, the glass may

shatter. This may result in an opening in the roof.

In a vehicle rollover, occupants not wearing their seat belts or not wearing them properly may be thrown out of the opening. Such an opening also presents a potential for injury for occupants wearing their seat belts properly as entire body parts or portions of them may protrude from the passenger compartment.

 To avoid damaging the seals, do not transport any objects with sharp edges which can stick out of the tilt/sliding sunroof.

Do not open the tilt/sliding sunroof if there is snow or ice on the roof, as this could result in malfunctions.

If you cannot open or close the tilt/sliding sunroof due to a malfunction contact Roadside Assistance or an authorized Mercedes-Benz Center.

 Please keep in mind that weather conditions can sometimes change rapidly. Make sure to close the tilt/sliding sunroof when leaving the vehicle. If water enters the vehicle interior, vehicle electronics could be damaged which is not covered by the Mercedes-Benz Limited Warranty.

 You can also open or close the tilt/sliding sunroof using the SmartKey or the KEYLESS-GO function, see “Summer opening feature” (▷ page 107) and “Convenience closing feature” (▷ page 108).

 After switching off the ignition or removing the SmartKey from the starter switch, you can operate the tilt/sliding sunroof until you open the driver’s or front passenger door. If no door was opened you can operate the tilt/sliding sunroof for up to 5 minutes.

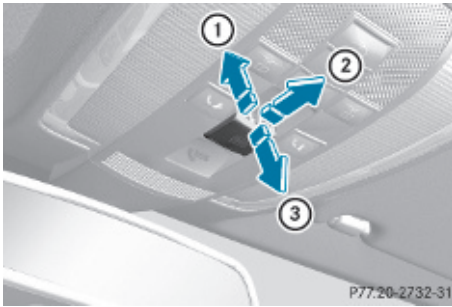

Sunroof switch

- ① Raising
- ② Opening
- ③ Closing

With the sunroof closed or raised, you can slide the sunroof screen forward and back.

- ▶ Switch on the ignition.

Opening

- ▶ **Opening manually:** Press and hold the sunroof switch to the resistance point in direction of arrow ②.
- ▶ Release the sunroof switch when the desired position is reached.
- ▶ **Express operation:** To open the tilt/sliding sunroof completely, press the sunroof switch past the resistance point in direction of arrow ② and release.
- ▶ **Stopping during express operation:** Move the sunroof switch in any direction.

i Express opening is not available when the tilt/sliding sunroof is raised. The tilt/sliding sunroof must be closed first.

i When the tilt/sliding sunroof is open, resonance noises may result in addition to the usual wind noises. They are caused by minimal pressure changes in the passenger compartment. To reduce or eliminate these noises, change the position of the tilt/sliding sunroof or open a window slightly.

Raising

- ▶ **Raising manually:** Press and hold the sunroof switch to the resistance point in direction of arrow ①.
- ▶ Release the sunroof switch when the desired position is reached.
- ▶ **Express operation:** To raise the tilt/sliding sunroof completely, press the sunroof switch past the resistance point in direction of arrow ① and release.
- ▶ **Stopping during express operation:** Move the sunroof switch in any direction.

i Express raising is not available when the tilt/sliding sunroof is open. The tilt/sliding sunroof must be closed first.

Closing

- ▶ **Closing manually:** Pull and hold the sunroof switch to the resistance point in direction of arrow ③.
- ▶ Release the sunroof switch when the desired position is reached.
- ▶ **Express operation:** To close the tilt/sliding sunroof completely, pull the sunroof switch past the resistance point in direction of arrow ③ and release.
- ▶ **Stopping during express operation:** Move the sunroof switch in any direction.

Closing when the tilt/sliding sunroof is blocked

Warning!

Make sure that nobody can become trapped and be seriously or even fatally injured when closing the tilt/sliding sunroof with greater force or without automatic reversal function.

If the movement of the tilt/sliding sunroof is blocked during the closing procedure (e.g. by ice or pollution), the tilt/sliding sunroof will stop and open slightly.

- ▶ Immediately after the tilt/sliding sunroof has stopped and opened because it was blocked, pull and hold the sunroof switch

in direction of arrow ③ until the tilt/sliding sunroof is fully closed.

The tilt/sliding sunroof closes with greater force.

If the tilt/sliding sunroof is blocked again and opens slightly:

- ▶ Immediately after the tilt/sliding sunroof was blocked and has opened, pull and hold the sunroof switch in direction of arrow ③ until the tilt/sliding sunroof is fully closed. The tilt/sliding sunroof closes without automatic reversal function.

⚠ Warning!

Pulling and holding the sunroof switch to close the tilt/sliding sunroof immediately after it had been blocked two times will cause the tilt/sliding sunroof to close without any reversal function for as long as you hold the sunroof switch.

Synchronizing

The tilt/sliding sunroof must be synchronized after a malfunction or if it does not open smoothly.

❗ If the tilt/sliding sunroof cannot be closed or synchronized, contact an authorized Mercedes-Benz Center or call Roadside Assistance.

- ▶ Switch on the ignition.
- ▶ Press and hold the sunroof switch in direction of arrow ① (▷ page 193) until the tilt/sliding sunroof is fully raised at the rear.
- ▶ Keep holding the sunroof switch in direction of arrow ① for approximately 1 second.
- ▶ Check the express operation feature (▷ page 193). If the tilt/sliding sunroof opens and closes completely, the roof is synchronized. Otherwise repeat the above steps.

Panorama roof with power tilt/sliding panel

Extending and retracting the roller sunblinds

The roller sunblinds only operate with the tilt/sliding panel closed. The front and rear roller sunblind cannot be operated individually.

⚠ Warning!

When extending the roller sunblinds, make sure no one is in danger of being injured by the extending procedure.

The roller sunblinds are equipped with the express operation and automatic reversal function. If the movement of the roller sunblinds is blocked during the extending procedure, the roller sunblinds will stop and retract slightly.

The extending of the roller sunblinds can be immediately halted by releasing the roof panel switch or, if the roof panel switch was moved past the resistance point and released, by moving the roof panel switch in any direction.



Roof panel switch

- ① Retracting
- ② Retracting
- ③ Extending

▶ Switch on the ignition.

- ▶ **Retracting/Extending:** Move the roof panel switch to the resistance point in the required direction of arrow ①, ② or ③

until the roller sunblinds have reached their desired position.

- ▶ **Express operation:** Move the roof panel switch past the resistance point in direction of arrow ①, ② or ③ and release. The roller sunblinds retract/extend completely.
- ▶ **Stopping during express operation:** Move the roof panel switch in any direction.

Opening and closing the panorama roof with power tilt/sliding panel

⚠ **Observe Safety notes, see page 56.**

⚠ **Warning!**

When opening or closing the tilt/sliding panel, make sure there is no danger of anyone being harmed by the opening/closing procedure.

The tilt/sliding panel is equipped with the express operation and automatic reversal function. If the movement of the tilt/sliding panel is blocked during the closing procedure, the tilt/sliding panel will stop and open slightly.

The tilt/sliding panel operates differently when the roof panel switch is pressed and held. See the “Closing when the tilt/sliding panel is blocked” section in this chapter for details.

The opening/closing procedure of the tilt/sliding panel can be immediately halted by releasing the roof panel switch or, if the roof panel switch was moved past the resistance point and released, by moving the roof panel switch in any direction.

⚠ **Warning!**

The panorama roof with tilt/sliding panel is made out of glass. In the event of an accident, the glass may shatter. This may result in an opening in the roof.

In a vehicle rollover, occupants not wearing their seat belts or not wearing them properly may be thrown out of the opening. Such an

opening also presents a potential for injury for occupants wearing their seat belts properly as entire body parts or portions of them may protrude from the passenger compartment.

- ⚠ To avoid damaging the seals, do not transport any objects with sharp edges which can stick out of the tilt/sliding panel. Do not open the tilt/sliding panel if there is snow or ice on the roof, as this could result in malfunctions.

- ⚠ Please keep in mind that weather conditions can sometimes change rapidly. Make sure to close the tilt/sliding panel when leaving the vehicle. If water enters the vehicle interior, vehicle electronics could be damaged which is not covered by the Mercedes-Benz Limited Warranty.

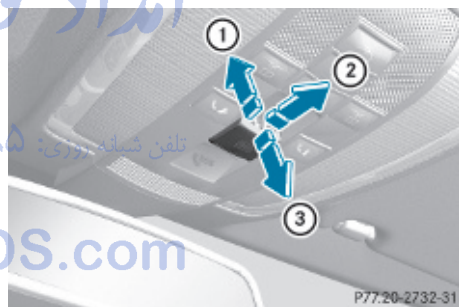

Roof panel switch

- ① Raising
- ② Opening
- ③ Closing

The tilt/sliding panel only operates with the roller sunblinds retracted.

- ⓘ You can also open or close the tilt/sliding panel using the SmartKey, see “Summer opening feature” (▷ page 107) or see “Convenience closing feature” (▷ page 108).

- ▶ Switch on the ignition.

Opening

- ▶ **Opening manually:** Press and hold the roof panel switch to the resistance point in direction of arrow ②.
- ▶ Release the roof panel switch when the desired position is reached.
- ▶ **Express operation:** To open the tilt/sliding panel completely, press the roof panel switch past the resistance point in direction of arrow ② and release.
- ▶ **Stopping during express operation:** Move the roof panel switch in any direction.

- ⓘ When the tilt/sliding panel is open, resonance noises may result in addition to the usual wind noises. They are caused by minimal pressure changes in the passenger compartment. To reduce or eliminate these noises, change the position of the tilt/sliding panel or open a window slightly.

Raising

- ▶ **Raising manually:** Press and hold the roof panel switch to the resistance point in direction of arrow ①.
- ▶ Release the roof panel switch when the desired position is reached.
- ▶ **Express operation:** To raise the tilt/sliding panel completely, press the roof panel switch past the resistance point in direction of arrow ① and release.
- ▶ **Stopping during express operation:** Move the roof panel switch in any direction.

- ⓘ Express raising is not available when the tilt/sliding panel is open. The tilt/sliding panel must be closed first.

Closing

- ▶ **Closing manually:** Pull and hold the roof panel switch to the resistance point in direction of arrow ③.
- ▶ Release the roof panel switch when the desired position is reached.

- ▶ **Express operation:** To close the tilt/sliding panel completely, pull the roof panel switch past the resistance point in direction of arrow ③ and release.
- ▶ **Stopping during express operation:** Move the roof panel switch in any direction.

Closing when the tilt/sliding panel is blocked

⚠ Warning!

Make sure that nobody can become trapped and be seriously or even fatally injured when closing the tilt/sliding panel without automatic reversal function.

If the movement of the tilt/sliding panel is blocked during the closing procedure (e.g. by ice or pollution), the tilt/sliding panel will stop and open slightly.

- ▶ Immediately after the tilt/sliding panel has stopped and opened because it was blocked, pull and hold the roof panel switch in direction of arrow ③ until the tilt/sliding panel is fully closed.

If the tilt/sliding panel is blocked again and opens slightly:

- ▶ Immediately after the tilt/sliding panel was blocked and has opened, pull and hold the roof panel switch in direction of arrow ③ until the tilt/sliding panel is fully closed. The tilt sliding panel closes without automatic reversal function.

⚠ Warning!

Pulling and holding the roof panel switch to close the tilt/sliding panel immediately after it had been blocked two times will cause the tilt/sliding panel to close without any reversal function for as long as you hold the roof panel switch.

Synchronizing

The tilt/sliding panel and roller sunblinds must be synchronized after a malfunction or

if the tilt/sliding panel does not open smoothly.

! Do not attempt to open the tilt/sliding panel before the tilt/sliding panel is properly synchronized. The tilt/sliding panel could otherwise lock-up in the open position.

If the tilt/sliding panel cannot be closed or synchronized, contact an authorized Mercedes-Benz Center or call Roadside Assistance.

- ▶ Switch on the ignition.
- ▶ Pull the roof panel switch repeatedly in direction of arrow ③ to the resistance point until the tilt/sliding panel is closed completely.
- ▶ Pull and hold the roof panel switch in direction of arrow ③ for 1 more second.
- ▶ Pull the roof panel switch repeatedly in direction of arrow ③ to the resistance point until the roller sunblinds are closed completely.
- ▶ Pull and hold the roof panel switch in direction of arrow ③ for 1 more second.
- ▶ Check whether the tilt/sliding panel and the roller sunblinds can be opened completely (▷ page 195).

Loading and storing

Loading instructions

Warning!

Always fasten items being carried as securely as possible. Use cargo tie-down rings and fastening materials appropriate for the weight and size of the load.

In an accident, during hard braking or sudden maneuvers, loose items will be thrown around inside the vehicle. This can cause injury to vehicle occupants unless the items are securely fastened in the vehicle.

To help avoid personal injury during a collision or sudden maneuver, exercise care when transporting cargo. Do not pile luggage or cargo higher than the seat backrests.

The trunk is the preferred place to carry objects.

Never drive a vehicle with the trunk open. Deadly carbon monoxide (CO) gases may enter vehicle interior resulting in unconsciousness and death.

Load distribution

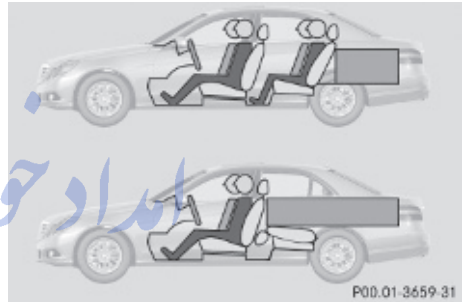

The total load weight including vehicle occupants and luggage/cargo should not exceed the total load limit indicated on the corresponding Tire and Loading Information placard located on the driver's door B-pillar (▷ page 238).

The handling characteristics of a fully loaded vehicle depend greatly on the load distribution. It is therefore recommended to load the vehicle according to the illustration shown. The heaviest items are to be placed towards the front of the vehicle.

Please pay attention to and comply with the following instructions when loading the vehicle and transporting cargo:

- Always place items being carried against front or rear seat backrests, and fasten them as securely as possible.
- The heaviest portion of the cargo should always be kept as low as possible against front or rear seat backrests.

Roof rack

For information about further roof rack equipment, contact an authorized Mercedes-Benz Center.

Warning!

Only use roof racks approved by Mercedes-Benz for your vehicle model to avoid damage to the vehicle.

Follow the manufacturer's installation instructions. Otherwise, an improperly attached roof rack system or its load could become detached from the vehicle.

Do not exceed the maximum roof load of 220 lb (100 kg).

Take into consideration that when the roof rack is loaded, the handling characteristics are different from those when operating the vehicle without the roof rack loaded.

Make sure

- you can raise the power tilt/sliding sunroof or the panorama roof with tilt/sliding panel completely
- you can open the trunk completely

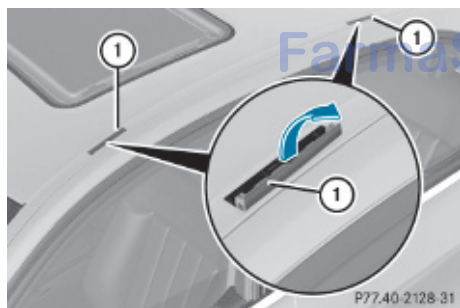

Vehicles with power tilt/sliding sunroof

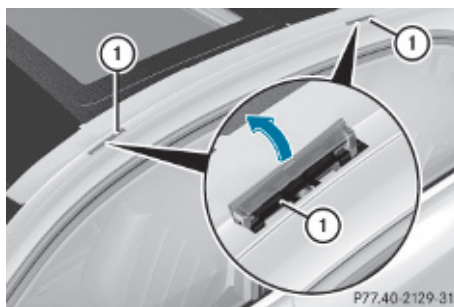

Vehicles with panorama roof with power tilt/sliding panel

- ▶ Flip trim covers ① open.
- ▶ Only attach the roof rack to the anchorage points under trim covers ①.
- ▶ Observe manufacturer's instructions for installation.

Through-loading feature

Warning!

Do not transport any unsecured items in the through-loading area.

- ▶ Fold the rear armrest down.
- ▶ **Opening through-loading area:** Open the trunk.

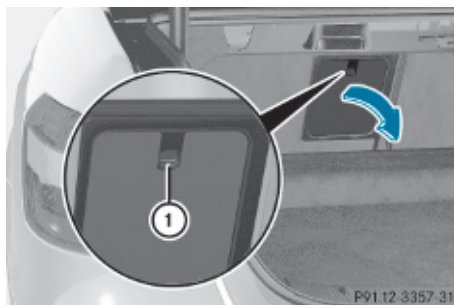

- ▶ Press release button ①.
The cover opens.
- ▶ **Closing through-loading area:** Swing cover in trunk back until it engages.

Parcel nets

⚠ Warning!

Parcel nets are intended for storing light-weight items only, such as road maps, mail, etc.

Heavy objects, objects with sharp edges, or fragile objects may not be transported in the parcel nets. In an accident, during hard braking, or sudden maneuvers, they could be thrown around inside the vehicle and cause injury to vehicle occupants.

Parcel nets cannot protect transported goods in the event of an accident.

Parcel nets are located:

- in the front passenger footwell
- behind the rear armrest
- at each side of the left and right trunk side walls

Cargo tie-down rings

Vehicles with split rear seat bench are equipped with six cargo tie-down rings.

Always follow loading instructions (▷ page 197).

Carefully secure cargo by applying even load on all the cargo tie-down rings with a rope of sufficient strength to hold down the cargo.

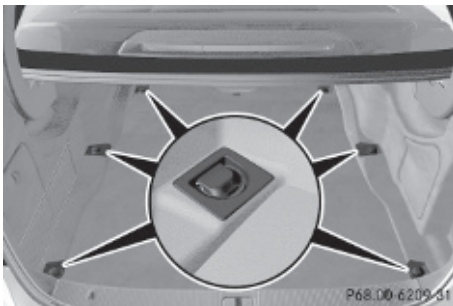

Cargo tie-down rings

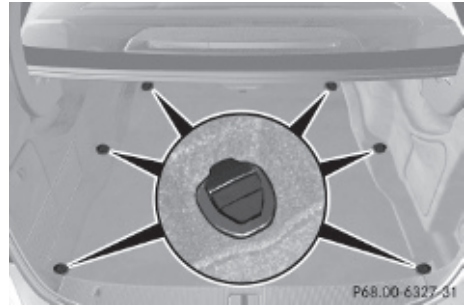

Cargo tie-down hooks

Vehicles without split rear seat bench are equipped with six cargo tie-down hooks.

Cargo tie-down hooks are intended for securing light-weight items only.

Carefully secure cargo by applying even load on all cargo tie-down hooks with a rope of sufficient strength to hold down the cargo.

Retaining hook

A retaining hook can be used to attach cargo items such as bags.

❗ Do not use the retaining hook to tie down cargo.

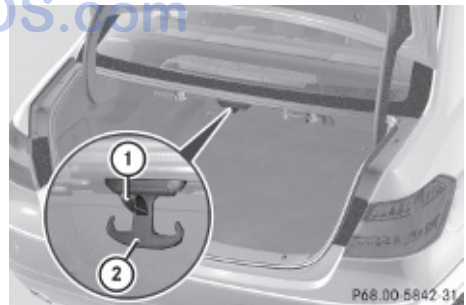

► Pull strap ① of retaining hook ② down.

Split rear seat bench

To expand the cargo volume, you can fold down the left and right rear seat backrests.

The two sections can be folded down separately.

Warning!

When expanding the cargo volume, always fold the seat backrests fully forward.

Unless you are transporting cargo, the seat backrests must remain properly locked in the upright position.

In an accident, during hard braking or sudden maneuvers, loose items will be thrown around inside the vehicle. This can cause injury to vehicle occupants unless the items are securely fastened in the vehicle.

Always use the cargo tie-down rings.

Folding seat backrest forward

- ▶ Open the trunk.

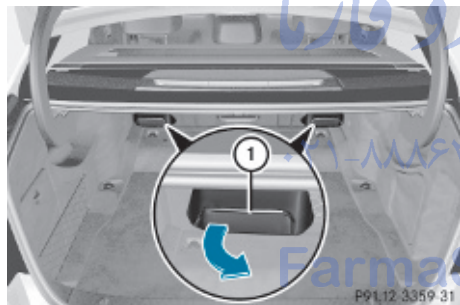

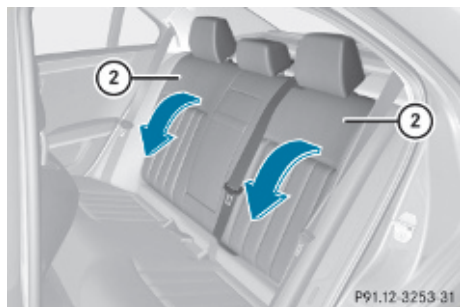

- ▶ Pull on left and/or right release handle (1). The driver's and/or front passenger seat moves forward automatically.

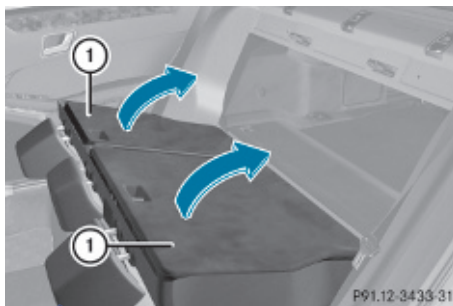

- ▶ Fold seat backrests (2) forward.
- ▶ Adjust front seats to desired position (▷ page 88).

Setting up seat backrest



- ▶ Fold seat backrest (1) rearward until it engages.
- ▶  Make sure that the seat belt is not pinched.
- ▶ Check for secure locking by pushing and pulling on the seat backrest.
- ▶ Adjust head restraints, if necessary (▷ page 90).
- ▶ Adjust front seats to desired position (▷ page 88).

Warning!

Always lock the seat backrest in its upright position when the rear seat bench is occupied, or the extended cargo volume is not in use.

Check for secure locking by pushing and pulling on the seat backrest.

In an accident, during hard braking or sudden maneuvers, loose items will be thrown around inside the vehicle. This can cause injury to vehicle occupants unless the items are securely fastened in the vehicle.

To help avoid personal injury during a collision or sudden maneuver, exercise care when transporting cargo.

- i** To prevent unauthorized persons from access to the trunk, always lock the seat backrests in its upright position.

Front storage compartments

Warning!

To help avoid personal injury during a collision or sudden maneuver, exercise care when storing objects in the vehicle. Put luggage or cargo in the trunk if possible.

Do not pile luggage or cargo higher than the seat backrests.

Keep compartment lids closed. This will help to prevent stored objects from being thrown about and injuring vehicle occupants during

- braking
- vehicle maneuvers
- an accident

Glove box

Depending on vehicle equipment, an AUX socket or a media interface is located in the glove box. For information on Audio AUX mode or on media interface, see separate COMAND system operating instructions.

The glove box can be ventilated (\triangleright page 188).

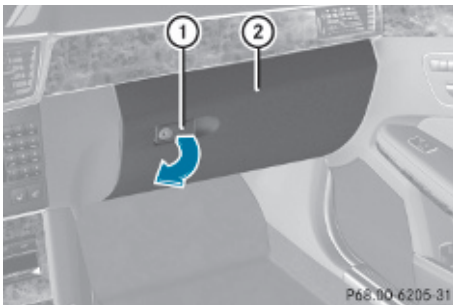

- \blacktriangleright **Opening:** Pull glove box lid release ①.
- \blacktriangleright **Closing:** Push glove box lid ② upwards until it engages.

You can lock the glove box, e.g. when the vehicle is in the shop for service.

The glove box can only be locked or unlocked with the mechanical key.

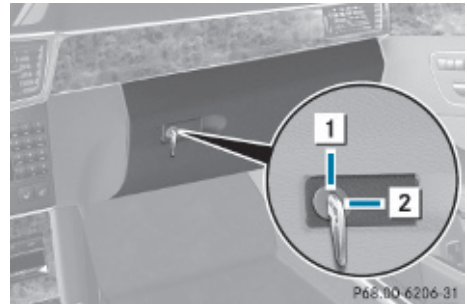

- ① Glove box unlocked
- ② Glove box locked

Storage compartment in front center console

- i** A storage compartment is located under the cup holder in the front center console.

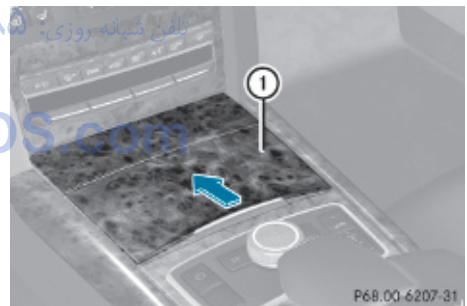

- \blacktriangleright Open cover ① (\triangleright page 203).
- \blacktriangleright Remove cup holder in the front center console (\triangleright page 203).

Front armrest storage compartment

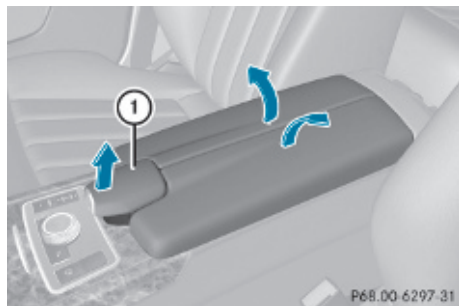

All models except E 63 AMG

- ▶ **Opening storage compartment:** Pull button ①. The armrest opens to the left and the right side automatically.
- ▶ **Closing storage compartment:** Swing the left and/or right armrest backward until it engages.

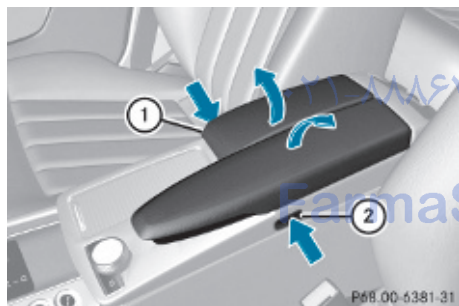

E 63 AMG

- ▶ **Opening storage compartment:** Press button ① or ②. The armrest opens to the left and the right side automatically.
- ▶ **Closing storage compartment:** Swing the left and/or right armrest backward until it engages.

Seat storage compartments

A storage compartment is located in the seat base of each front seat.

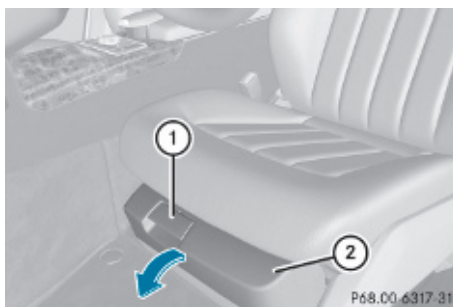

- ▶ **Opening:** Pull handle ① up.
- ▶ Fold storage compartment lid ② forward in direction of arrow.

Rear storage compartments

⚠ Warning!

To help avoid personal injury during a collision or sudden maneuver, exercise care when storing objects in the vehicle. Put luggage or cargo in the trunk if possible.

Do not pile luggage or cargo higher than the seat backrests.

Keep compartment lids closed. This will help to prevent stored objects from being thrown about and injuring vehicle occupants during

- braking
- vehicle maneuvers
- an accident

Rear armrest storage compartment

- ⚠ Do not sit on or lean your body weight against the armrest when it is folded down, as you could otherwise damage it.
- ⚠ Before storing the armrest in the seat backrest, close the storage compartment cover.
- ▶ Fold the rear armrest down.

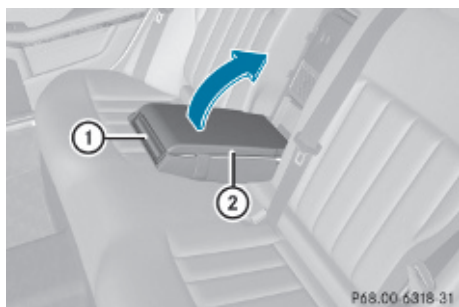

- **Opening:** Pull release catch ① and swing the storage compartment cover ② upward in direction of arrow.

Storage bags

⚠ Warning!

Storage bags are intended for storing light-weight items only.

Heavy objects, objects with sharp edges or fragile objects may not be transported in the storage bag. In an accident, during hard braking, or sudden maneuvers, they could be thrown around inside the vehicle and cause injury to vehicle occupants.

Storage bags cannot protect transported goods in the event of an accident.

Storage bags are located on the back of the front seats.

Useful features

Cup holders

⚠ Warning!

In order to help prevent spilling liquids on vehicle occupants and/or vehicle equipment, only use containers that fit into the cup holder. Use lids on open containers and do not fill containers to a height where the contents, especially hot liquids, could spill during braking, vehicle maneuvers, or in an accident. Liquids spilled on vehicle occupants

may cause serious personal injury. Liquids spilled on vehicle equipment may cause damage not covered by the Mercedes-Benz Limited Warranty.

When not in use, keep the cup holder closed. An open cup holder may cause injury to you or others when contacted during braking, vehicle maneuvers, or in an accident.

Keep in mind that objects placed in the cup holder may come loose during braking, vehicle maneuvers, or in an accident and be thrown around in the vehicle interior. Objects thrown around in the vehicle interior may cause an accident and/or serious personal injury.

Cup holder in front center console

A storage compartment is located under the cup holder in the front center console.

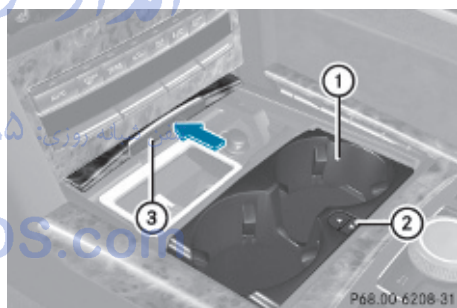

All models except E 63 AMG

- **Opening:** Push cover ③ forward until it engages.
- **Removing:** Press latch ② forward and pull cup holder ① out.
- **Inserting:** Insert cup holder ① and press latch ② back.
- **Closing:** Briefly press on cover ③. Cover ③ closes automatically.

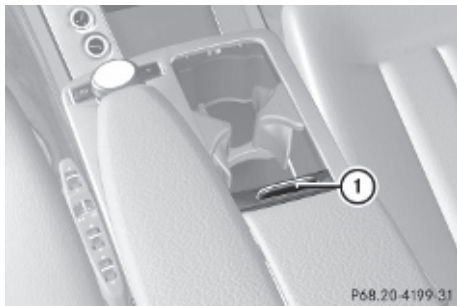

E 63 AMG

- ▶ **Opening/closing:** Slide cover ① forward or rearward.

Cup holder in rear armrest

- ▶ **Opening:** Open rear armrest storage compartment (> page 202).

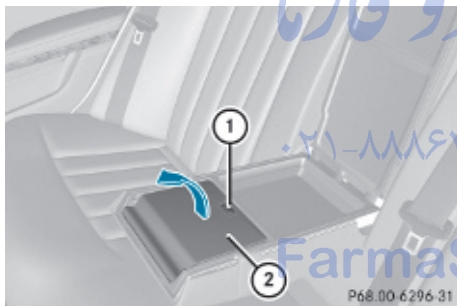

- ▶ Press release button ①.
Cup holder ② swings out and opens automatically.
- ▶ Close rear armrest storage compartment.
- ▶ **Closing:** Open rear armrest storage compartment (> page 202).
- ▶ Swing cup holder ② backward until it engages.
- ▶ Close rear armrest storage compartment.

- ▶ **!** Do not sit on or lean your body weight against the armrest when it is folded down, as you could otherwise damage it.

- ▶ **!** Close the cup holder before folding the armrest upwards. Otherwise you could damage the cup holder.

Bottle holder

Warning!

Do not transport heavy, sharp-edged, or fragile bottles in the bottle holder.

In the event of an accident, the bottle holder cannot secure a bottle sufficiently. You and/or vehicle occupants could be injured.

- ▶ **!** Make sure that the bottom of the bottle in the bottle holder touches the floor. The bottle holder could otherwise be damaged.

The bottle holder is designed to secure bottles of 25 fl.oz (0,7 l) to 54 fl.oz (1,5 l). The bottle holder does not keep a bottle in place but prevents it from tipping over.



- ▶ Press and hold adjuster ①.
- ▶ Slide it in direction of arrow to match the size of the bottle.
- ▶ Release adjuster ①.
- ▶ Insert the bottle into the bottle holder.

Sun visors

Warning!

Do not use the vanity mirror while driving. Keep the vanity mirrors in the sun visors

closed while vehicle is in motion. Reflected glare can endanger you and others.

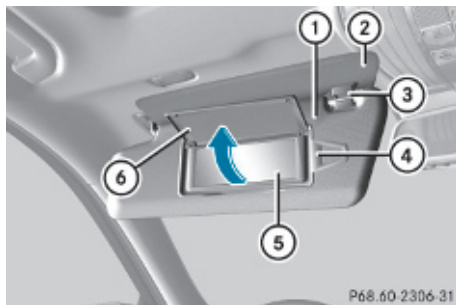

- ① Sun visor
- ② Additional sun visor
- ③ Mounting
- ④ Holder, e.g. for gas cards
- ⑤ Vanity mirror
- ⑥ Vanity mirror cover

Glare through the windshield

- ▶ Flip sun visor ① down when you experience glare.

Glare through a door window

- ▶ Close vanity mirror cover ⑥ if opened.
- ▶ Disengage sun visor ① from mounting ③.
- ▶ Pivot sun visor to the side.

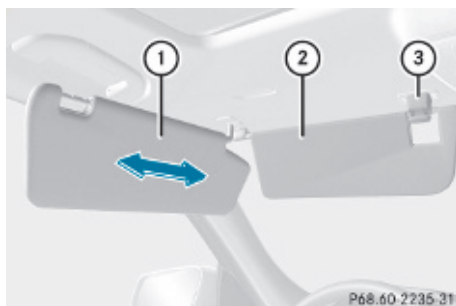

- ▶ Adjust sun visor ① by pushing or pulling in direction of arrows.
- ▶ Flip down additional sun visor ② when you experience additional glare through the windshield.

Vanity mirror

The vanity mirror lamp only functions when the sun visor ① is engaged in mounting ③.

- ▶ Flip sun visor ① down.
- ▶ Lift up vanity mirror cover ⑥. Vanity mirror lamp comes on.

Rear window sunshade

⚠ Warning!

When operating the rear window sunshade make sure there is no danger of anyone being harmed by the extending or retracting procedure.

The extending or retracting procedure can be immediately halted by briefly pressing rear window sunshade switch. To reverse direction of movement, press rear window sunshade switch again.

⚠ Observe Safety notes, see page 56.

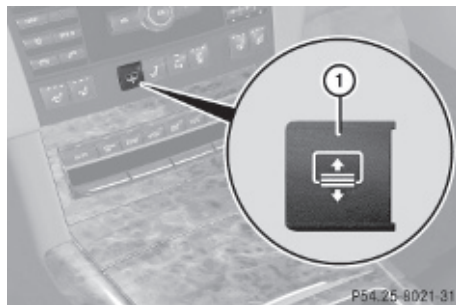

- ▶ Switch on the ignition.
- ▶ **Extending/Retracting:** Press rear window sunshade switch ① briefly.

P68.60.2306.31

فارسوس فارما

فارسوس فارما

FarmasOS.com

P54.25.6021.31

P68.60.2235.31

Ashtrays

Center console ashtray

i A storage compartment is located under the ashtray insert.

! The storage compartment is not heat-proof. When smoking always make sure the ashtray insert is present and properly inserted.

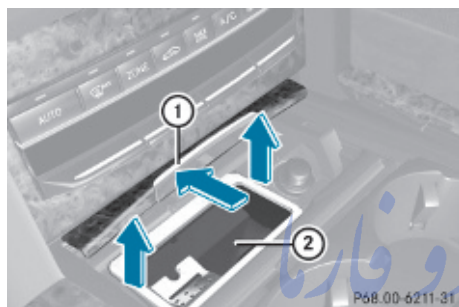

- ▶ **Opening:** Open cover ① (▷ page 203).
- ▶ **Removing ashtray insert:** Grab ashtray insert ② on the sides and pull it up and out in the direction indicated by arrows.
- ▶ **Reinstalling ashtray insert:** Push ashtray insert ② back into the frame until it engages.
- ▶ **Closing:** Tap front of cover ①.

Rear center console ashtray

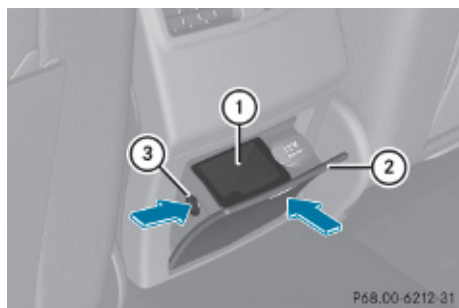

- ▶ **Opening:** Press at top of cover ② briefly. Cover ② opens automatically.

- ▶ **Removing ashtray insert:** Push button ③ to disengage ashtray insert ① and remove it.
- ▶ **Reinstalling ashtray insert:** Push ashtray insert ① down into the retainer until it engages.

Cigarette lighter

! Observe Safety notes, see page 56.

Warning!

Never touch the heating element or sides of the lighter; they are extremely hot. Hold the knob only.

Make sure any children traveling with you do not injure themselves or start a fire with the hot cigarette lighter.

If the engine is off and the cigarette lighter is being used extensively, the vehicle battery may become discharged.

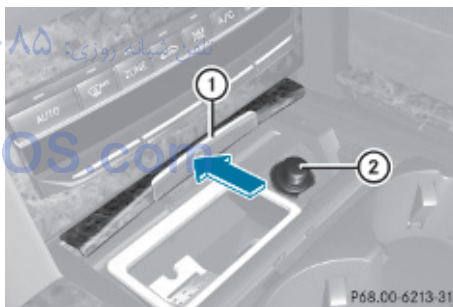

- ▶ Switch on the ignition.
- ▶ Open cover ① (▷ page 206).
- ▶ Push in cigarette lighter ②. Cigarette lighter ② will pop out automatically when hot.
- ▶ Take out cigarette lighter ②.
- ▶ Reinsert cigarette lighter ② in its socket after use.

Power outlets

The power outlets can be used to accommodate 12V DC electrical accessories (e.g. auxiliary lamps, mobile phone chargers) up to a maximum of 15 A (180 W).

If the engine is off and the power outlets are being used extensively, the vehicle battery may become discharged.

Power outlet in glove box

- ▶ Open the glove box (▶ page 201).



Power outlet in rear passenger compartment

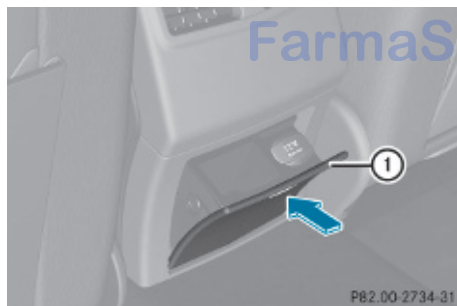

- ▶ Briefly press top of cover ①.
Cover ① opens automatically.

Power outlet in trunk



Tele Aid

- ❗ In order to activate the Tele Aid system, a subscriber agreement must be completed. To ensure your system is activated and operational, please press Information button  to perform the acquaintance call. Failure to complete either of these steps may result in a system that is not activated.

If you have any questions regarding activation, please call the Customer Assistance Center at 1-800-FOR-MERCEdes (1-800-367-6372) (USA only) or 1-888-923-8367 (Canada only).

Shortly after the completion of your Tele Aid acquaintance call, you will receive a user ID and password in the mail. You may use this password to access the Tele Aid section in "Owner's Online" at www.mbusa.com (USA only). The "My Tele Aid" section will give you access to account information, remote door unlock and more.

The Tele Aid system is available if

- it has been activated and is operational. Activation requires a subscription for monitoring services, connection and cellular air time
- vehicle battery power is available
- the relevant cellular phone network and GPS signals are available and pass the

information on to the Customer Assistance Center

- Location of the vehicle on a map is only possible if the vehicle is able to receive signals from the GPS satellite network and pass the information on to the Customer Assistance Center.

The Tele Aid system

(Telematic Alarm Identification on Demand)

The Tele Aid system consists of three types of response:

- Automatic and manual emergency
- Roadside Assistance
- Information

To adjust the speaker volume during a Tele Aid call do the following:

- ▶ Press button  or  on the multifunction steering wheel.

or

- ▶ Use the adjustment button on your COMAND system.

Be sure to check “Owner’s Online” at www.mbusa.com (USA only) for more information and a description of all available features.



System self-test

The system performs a self-test after you have switched on the ignition.

Warning!

A malfunction in the system has been detected if any or all of the following conditions occur:

- The indicator lamp in the SOS button does not come on during the system self-test.
- The indicator lamp in the Roadside Assistance button  does not come on during the system self-test.

- The indicator lamp in the Information button  does not come on during the system self-test.
- The indicator lamp in the SOS button, Roadside Assistance button , or Information button  remains illuminated constantly in red after the system self-test.
- The message Tele Aid Inoperative or Tele Aid Not Activated appears in the multifunction display after the system self-test

If a malfunction is indicated as outlined above, the system may not operate as expected. In case of an emergency, help will have to be summoned by other means.

Have the system checked at the nearest Mercedes-Benz Center or contact the Customer Assistance Center at 1-800-FOR-MERCEdes (1-800-367-6372) (USA only) or 1-888-923-8367 (Canada only) as soon as possible.

Emergency calls

- In order to activate the Tele Aid system, a subscriber agreement must be completed. To ensure your system is activated and operational, please press Information button  to perform the acquaintance call. Failure to complete either of these steps may result in a system that is not activated.

If you have any questions regarding activation, please call the Customer Assistance Center at 1-800-FOR-MERCEdes (1-800-367-6372) (USA only) or 1-888-923-8367 (Canada only).

An emergency call is initiated automatically following an accident in which the Emergency Tensioning Devices (ETDs) or air bags have deployed.

- An automatically initiated Tele Aid emergency call cannot be canceled.

An emergency call can also be initiated manually (▷ page 209).

Once the emergency call is in progress, the indicator lamp in the SOS button will begin to flash. The message **Connecting Call** appears in the multifunction display and the COMAND system is muted. When the connection is established, the message **Call Connected** appears in the multifunction display.

All information relevant to the emergency, such as the location of the vehicle (determined by the GPS satellite location system), vehicle model, identification number and color are generated.

A voice connection between the Customer Assistance Center and the occupants of the vehicle will be established automatically soon after the emergency call has been initiated. The Customer Assistance Center will attempt to determine the nature of the emergency more precisely, provided they can speak to an occupant of the vehicle.

- i** If no vehicle occupant responds, an ambulance will be sent to the vehicle immediately.

⚠ Warning!

If the indicator lamp in the SOS button is flashing continuously and there was no voice connection to the Customer Assistance Center established, then the Tele Aid system could not initiate an emergency call (e.g. the relevant cellular phone network is not available).

The message **Call Failed** appears in the multifunction display for approximately 10 seconds.

Should this occur, assistance must be summoned by other means.

- i** The “911” emergency call system is a public service. Using it without due cause is a criminal offense.

Initiating an emergency call manually

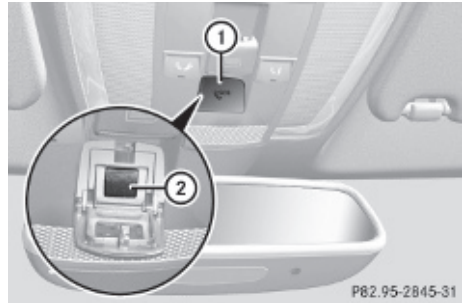

- ▶ Briefly press on cover **①** to open.
- ▶ Press SOS button **②** briefly. The indicator lamp in SOS button **②** will flash until the emergency call is concluded.
- ▶ Wait for a voice connection to the Customer Assistance Center.
- ▶ Close cover **①** after the emergency call is concluded.

⚠ Warning!

If you feel at any way in jeopardy when in the vehicle (e.g. smoke or fire in the vehicle, vehicle in a dangerous road location), please do not wait for voice contact after you have pressed the emergency button. Carefully leave the vehicle and move to a safe location. The Customer Assistance Center will automatically contact local emergency officials with the vehicle's approximate location if they receive an automatic SOS signal and cannot make voice contact with the vehicle occupants.

- ▶ **Terminating calls:** Press button  on the multifunction steering wheel.

or

- ▶ Press the respective button for ending a telephone call on the COMAND system.

Roadside Assistance button



- ▶ Press and hold Roadside Assistance button ① for longer than 2 seconds. A call to a Mercedes-Benz Roadside Assistance dispatcher will be initiated. The indicator lamp in Roadside Assistance button ① will flash while the call is in progress. The message **Connecting Call** will appear in the multifunction display and the audio system or the COMAND system is muted.

When the connection is established, the message appears in the multifunction display. The Tele Aid system will transmit data generating the vehicle identification number, model, color and location (subject to availability of cellular and GPS signals).

- ❗ The COMAND system display indicates that a Tele Aid call is in progress. While the call is connected you can change to the navigation menu by pressing the NAVI button on the COMAND system. Spoken commands are not available.

A voice connection between the Roadside Assistance dispatcher and the occupants of the vehicle will be established.

- ▶ Describe the nature of the need for assistance.

The Mercedes-Benz Roadside Assistance dispatcher will either dispatch a qualified Mercedes-Benz technician or arrange to tow your vehicle to the nearest authorized Mercedes-Benz Center. For services such as labor and/or towing, charges may apply.

Refer to the Roadside Assistance manual for more information.

Sign and Drive services (USA only): Services such as a jump start, a few gallons of fuel or the replacement of a flat tire with the vehicle spare wheel are obtainable at no charge.

- ❗ If the indicator lamp in Roadside Assistance button ① is flashing continuously and there was no voice connection to the Customer Assistance Center established, then the Tele Aid system could not initiate a Roadside Assistance call (e.g. the relevant cellular phone network is not available). The message **Call Failed** appears in the multifunction display.

- ▶ **Terminating calls:** Press button  on the multifunction steering wheel.

or

- ▶ Press the respective button for ending a telephone call on the COMAND system.

Information button



- ▶ Press and hold Information button ① for longer than 2 seconds. A call to the Customer Assistance Center will be initiated. The indicator lamp in Information button ① will flash while the call is in progress. The message **Connecting Call** will appear in the multifunction display and the COMAND system is muted.

When the connection is established, the message **Call Connected** appears in the multifunction display. The Tele Aid system will transmit data generating the vehicle identification number, model, color and location (subject to availability of cellular and GPS signals).

- i** The COMAND system display indicates that a Tele Aid call is in progress. While the call is connected you can change to the navigation menu by pressing the NAVI button on the COMAND system. Spoken commands are not available.

A voice connection between the Customer Assistance Center representative and the occupants of the vehicle will be established. Information regarding the operation of your vehicle, the nearest authorized Mercedes-Benz Center or Mercedes-Benz USA products and services is available to you.

For more details concerning the Tele Aid system, please visit **www.mbusa.com** (USA only), log in to “Owner’s Online” and visit the “My Tele Aid” section to learn more.

- i** If the indicator lamp in Information button **1** is flashing continuously and there was no voice connection to the Customer Assistance Center established, then the Tele Aid system could not initiate an Information call (e.g. the relevant cellular phone network is not available). The message **Call Failed** appears in the multifunction display.

► **Terminating calls:** Press button  on the multifunction steering wheel.

or

► Press the respective button for ending a telephone call on the COMAND system.

Call priority

If other service calls such as a Roadside Assistance call or Information call are active, an emergency call is still possible. In this

case, the emergency call will take priority and override all other active calls.

The indicator lamp in the respective button flashes until the call is concluded. Automatic initiated emergency calls can only be terminated by a Customer Assistance Center representative. All other calls can be terminated by pressing button  on the multifunction steering wheel or the respective button for ending a telephone call on the COMAND system.

- i** When a Tele Aid call has been initiated, the COMAND system audio is muted. The mobile phone is no longer connected to the COMAND system. If you must use this phone, we recommend that you use it only with the vehicle at a standstill in a safe location.

Search & Send

“Search & Send” is a navigation destination address entry service. For more information on “Search & Send”, refer to separate COMAND system operating instructions.

Remote door unlock

In case you have locked your vehicle unintentionally (e.g. SmartKey inside vehicle), and the reserve SmartKey is not available:

- Contact the Customer Assistance Center at 1-800-FOR-MERCEdes (1-800-367-6372) (USA only) or 1-888-923-8367 (Canada only). You will be asked to provide your password.
- Then return to your vehicle at the time arranged with the Customer Assistance Center and pull the trunk lid handle for a minimum of 20 seconds until the indicator lamp in the SOS button is flashing. The message **Connecting Call** appears in the multifunction display.

As an alternative, you may unlock the vehicle via Internet in the “My Tele Aid” section of “Owner’s Online”, using your ID and password (USA only).

i The remote door unlock feature is available if the relevant cellular phone network is available.

The SOS button will flash and the message **Connecting Call** will appear in the multifunction display to indicate receipt of the door unlock command.

If the trunk lid handle was pulled for more than 20 seconds before door unlock authorization was received, you must wait 15 minutes before pulling the trunk lid handle again.

Remote door lock

If you have forgotten to lock your vehicle and are no longer near it, you can have it locked remotely through the Customer Assistance Center.

The vehicle can be remotely locked within four days after the ignition has been switched off.

- ▶ Contact the Customer Assistance Center at 1-800-FOR-MERCEdes (1-800-367-6372) (USA only) or 1-888-923-8367 (Canada only).
You will be asked to provide your password.

When you are inside your vehicle the next time and switch on the ignition, the message **Tele Aid Doors locked by remote control** will appear on the multifunction display.

i The remote door lock feature is available if the relevant cellular phone network is available and data connection is possible.

Stolen Vehicle Recovery Services

In the event your vehicle was stolen:

- ▶ Report the incident to the police.
The police will issue a numbered incident report.
- ▶ Pass this number on to the Customer Assistance Center along with your password.
The Customer Assistance Center will then attempt to covertly contact the vehicle's Tele Aid system. Once the vehicle is located, the Customer Assistance Center will contact the local law enforcement and you. The vehicle's location will only be provided to law enforcement.

i If the anti-theft alarm stays on for more than 30 seconds, the Tele Aid system will notify the Customer Assistance Center automatically.

Garage door opener

The integrated remote control can operate up to three separately controlled devices compatible with HomeLink® or some other systems.

Warning!

Before programming the integrated remote control to a garage door opener or gate operator, make sure people and objects are out of the way of the device to prevent potential harm or damage. When programming a garage door opener, the door moves up or down. When programming a gate operator, the gate opens or closes.

Do not use the integrated remote control with any garage door opener that lacks safety stop and reverse features as required by U.S. federal safety standards (this includes any garage door opener model manufactured before April 1, 1982). A garage door that cannot detect an object - signaling the door to stop and reverse - does not meet current U.S. federal safety standards.

When programming a garage door opener, park vehicle outside the garage.

Do not run the engine while programming the integrated remote control. Inhalation of exhaust gas is hazardous to your health. All exhaust gas contains carbon monoxide (CO), and inhaling it can cause unconsciousness and possible death.

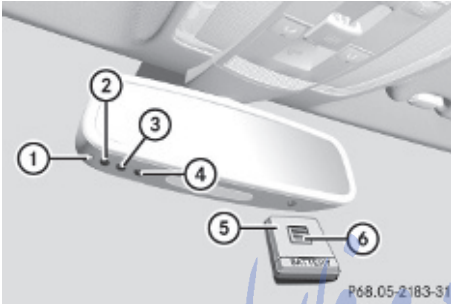

Interior rear view mirror with integrated remote control

Hand-held remote control ⑤ is not part of the vehicle equipment.

Programming the integrated remote control

- ▶ **Step 1:** Switch on the ignition.
 - ▶ **Step 2:** If you have previously programmed a signal transmitter button and wish to retain its programming, proceed to step 3.
- or
- ▶ If you are programming the integrated remote control for the first time, press and hold the two outer signal transmitter buttons ② and ④ and release them when indicator lamp ① begins to flash after approximately 20 seconds.

Do not hold the buttons for longer than 30 seconds.

This procedure erases any previous settings for all three channels and initializes the memory. If you later wish to program a second and/or third hand-held transmitter to the remaining two signal

transmitter buttons, do not repeat this step and begin directly with step 3.

- ▶ **Step 3:** Hold the end of hand-held remote control ⑤ of the device you wish to train approximately 2 to 12 in (5 to 30 cm) away from the signal transmitter button (②, ③ or ④) to be programmed, while keeping indicator lamp ① in view.
- ▶ **Step 4:** Using both hands, simultaneously press hand-held remote control button ⑥ and the desired signal transmitter button (②, ③ or ④). Do not release the buttons until step 5 is completed. Indicator lamp ① will flash, first slowly and then rapidly.

i Indicator lamp ① flashes immediately the first time the signal transmitter button is programmed. If this button has already been programmed, the indicator lamp will start flashing after 20 seconds.

- ▶ **Step 5:** After indicator lamp ① changes from a slow to a rapidly flashing light, release the hand-held remote control button and the signal transmitter button.
- ▶ **Step 6:** Press and hold the just-trained signal transmitter button (②, ③ or ④) and observe indicator lamp ①. If indicator lamp ① stays on constantly, programming is complete and your device should activate when the respective signal transmitter button (②, ③ or ④) is pressed and released.

i If indicator lamp ① flashes rapidly for approximately 2 seconds and then turns to a constant light, continue with programming steps 8 through 12 as your garage door opener may be equipped with the “rolling code” feature.

- ▶ **Step 7:** To program the remaining two signal transmitter buttons, repeat the steps above starting with step 3.

Rolling code programming

To train a garage door opener (or other rolling code devices) with the rolling code feature, follow these instructions after completing the “Programming” portion (steps 1 through 6) of this text. For your convenience and to complete the procedure faster, you might want to have someone assist you.

► **Step 8:** Locate the “training” button on the garage door opener motor head unit.

❗ Exact location and color of the button may vary by garage door opener brand. Depending on manufacturer, the “training” button may also be referred to as “learn” or “smart” button. If there is difficulty locating the transmitting button, refer to the garage door opener Operator’s Manual.

► **Step 9:** Press the “training” button on the garage door opener motor head unit. The “training light” is activated.

You have 30 seconds to initiate the following two steps.

► **Step 10:** Return to the vehicle and firmly press, hold for 2 seconds and release the programmed signal transmitter button (②, ③ or ④).

► **Step 11:** Press, hold for 2 seconds and release same signal transmitter button a second time to complete the training process.

❗ Some garage door openers (or other rolling code equipped devices) may require you to press, hold for 2 seconds and release the same signal transmitter button a third time to complete the training process.

► **Step 12:** Confirm the garage door operation by pressing the programmed signal transmitter button (②, ③ or ④).

► **Step 13:** To program the remaining two signal transmitter buttons, repeat the steps above starting with step 3.

Gate operator/Canadian programming

Canadian radio-frequency laws require transmitter signals to “time-out” (or quit) after several seconds of transmission which may not be long enough for the integrated signal transmitter to pick up the signal during programming. Similar to this Canadian law, some U.S. gate operators are designed to “time-out” in the same manner.

If you live in Canada or if you are having difficulties programming a gate operator (regardless of where you live) by using the programming procedures, replace step 4 with the following:

► **Step 4:** Press and hold the signal transmitter button (②, ③ or ④). Do not release this button until it has been successfully trained.

► While still holding down the signal transmitter button (②, ③ or ④), “cycle” your hand-held remote control button ⑥ as follows: Press and hold button ⑥ for 2 seconds, then release it for 2 seconds, and again press and hold it for 2 seconds. Repeat this sequence on the hand-held remote control until the frequency signal has been learned.

Upon successful training, indicator lamp ① will flash slowly and then rapidly after several seconds.

► Proceed with programming step 5 and step 6 to complete.

❗ Upon completion of programming the integrated remote control, make sure you retain the hand-held remote control that came with the garage door opener, gate operator or other device. You may need it for use in other vehicles, for future programming of an integrated remote control, or simply for continued use as a hand-held remote control to operate the respective device in other situations.

Reprogramming a single signal transmitter button

To program a device using a signal transmitter button previously trained, follow these steps:

- ▶ Switch on the ignition.
- ▶ Press and hold the desired signal transmitter button (②, ③ or ④). Do not release the button. Indicator lamp ① will begin to flash after 20 seconds.
- ▶ Without releasing the signal transmitter button, proceed with programming starting with step 3.

Operation of integrated remote control

- ▶ Switch on the ignition.
- ▶ Select and press the appropriate integrated signal transmitter button (②, ③ or ④) to activate the remote controlled device. The integrated remote control transmitter continues to send the signal as long as the button is pressed – up to 20 seconds.

Erasing the integrated remote control memory

- ❗ If you sell your vehicle, erase the codes of all three channels.
- ▶ Switch on the ignition.
- ▶ Simultaneously press and hold outer signal transmitter buttons ② and ④, for approximately 20 seconds, until indicator lamp ① flashes rapidly. Do not hold for longer than 30 seconds. The codes of all three channels are erased.

Programming tips

If you are having difficulty programming the integrated remote control, here are some helpful tips:

- Check the frequency of hand-held remote control ⑤ (typically located on the reverse side of the remote). The integrated remote control is compatible with radio-frequency devices operating between 280-390 MHz.
- Put a new battery in hand-held remote control ⑤. This will increase the likelihood of the hand-held remote control sending a stronger and more accurate signal to the integrated remote control.
- While performing step 3, hold hand-held remote control ⑤ at different lengths and angles from the signal transmitter button (②, ③ or ④) you are programming. Attempt varying angles at the distance of 2 to 12 inches (5 to 30 cm) away or the same angle at varying distances.
- If another hand-held remote control is available for the same device, try the programming steps again using that other hand-held remote control. Make sure new batteries are in the hand-held remote control before beginning the procedure.
- Straighten the antenna wire from the garage door opener assembly. This may help improve transmitting and/or receiving signals.
- ❗ Certain types of garage door openers are incompatible with the integrated remote control. If you should experience further difficulties with programming the integrated remote control, contact an authorized Mercedes-Benz Center, or call the Mercedes-Benz Customer Assistance Center (USA only) at 1-800-FOR-MERcedes (1-800-367-6372), or the HomeLink® Hotline (USA only) at 1-800-355-3515, or the Customer Service (Canada only) at 1-800-387-0100.

i USA only:

This device complies with Part 15 of the FCC Rules. Operation is subject to the following two conditions:

1. This device may not cause harmful interference, and
2. this device must accept any interference received, including interference that may cause undesired operation.

Any unauthorized modification to this device could void the user's authority to operate the equipment.

i Canada only:

This device complies with RSS-210 of Industry Canada. Operation is subject to the following two conditions:

1. This device may not cause interference, and
2. this device must accept any interference received, including interference that may cause undesired operation of the device.

Any unauthorized modification to this device could void the user's authority to operate the equipment.

compass must be calibrated and the magnetic field zone set.

- **Calling up the compass:** Press button ③ briefly.

The compass displays the direction into which the vehicle is currently traveling: N, NE, E, SE, S, SW, W, or NW.

- **Compass adjustment:** Determine your location on the basis of the following zone maps.

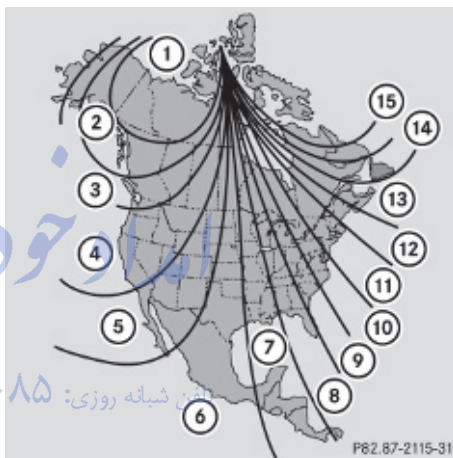

Zone map North America

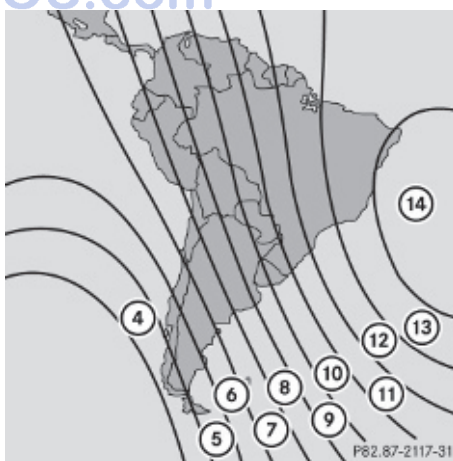

Zone map South America

Compass

- i** In order to receive an accurate reading in the interior rear view mirror ①, the

- ▶ Press button ③ approximately 3 seconds. The currently selected zone appears in compass display ②.
- ▶ **Selecting zone:** Press button ③ until the desired zone is selected. Do not press the button again until the direction is indicated.
- ▶ **Compass calibration:** Make sure you are in an area where you can drive a full circle with your vehicle without disturbing traffic in order to calibrate the compass.

In order to calibrate the compass properly, mind the following:

- Calibrate the compass in open terrain. Nearby buildings, bridges, power lines and large antenna masts, for example, could impair compass calibration.
- Switch off electrical consumers (e.g. climate control, windshield wipers, or rear window defroster).
- Close all doors and the trunk.
- ▶ Start the engine.
- ▶ Press button ③ approximately 6 seconds until symbol C appears in compass display ②.
- ▶ Drive a full circle at a vehicle speed of between 3 mph (5 km/h) and 6 mph (10 km/h). When calibration was successful, the current direction appears in compass display ②.

loose floormat could slip and hinder proper functioning of the pedals.

Do not place several floormats on top of each other as this may impair pedal movement.

- ▶ Move the driver's seat as far to the rear as possible.

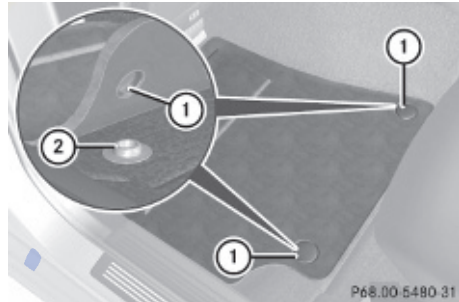

- ▶ **Removing:** Pull floormat off of retainer pins ②.

- ▶ **Installing:** Press floormat eyelets ① onto retainer pins ②.

Floormat (driver's side only)

Warning!

Whenever you are using a floormat, make sure there is enough clearance and that the floormat is securely fastened.

The floormat should always be securely fastened using the fastening equipment.

Before driving off, check that the floormat is securely in place and adjust it if necessary. A

امداد خودرو فارما

تلفن شبانه روزی: ۰۲۱-۸۸۸۶۲۰۸۵

FarmaSOS.com

Vehicle equipment	220
The first 1000 miles (1500 km)	220
At the gas station	220
Engine compartment	223
Tires and wheels	228
Winter driving	252
Driving instructions	254
Maintenance	258
Vehicle care	260

امداد خودرو فارما

تلفن شبانه روزی: ۰۲۱-۸۸۸۶۲۰۸۵

FarmaSOS.com



Vehicle equipment

- i** This Operator's Manual describes all features, standard or optional, potentially available for your vehicle at the time of purchase. Please be aware that your vehicle might not be equipped with all features described in this manual.

The first 1000 miles (1500 km)

The more cautiously you treat your vehicle during the break-in period, the more satisfied you will be with its performance later on.

- Drive your vehicle during the first 1000 miles (1500 km) at varying but moderate vehicle and engine speeds.
- During this period, avoid heavy loads (full throttle driving) and excessive engine speeds (no more than $\frac{2}{3}$ of maximum rpm in each gear).
- Avoid accelerating by kickdown.
- Select gear ranges **3**, **2** or **1** (▷ page 120) only when driving at moderate speeds (for hill driving).

After 1000 miles (1500 km) you may gradually increase vehicle and engine speeds to the permissible maximum.

! Additional instructions for AMG vehicles:

- During the first 1000 miles (1500 km), do not exceed a speed of 85 mph (140 km/h).
- During this period, avoid engine speeds above 4500 rpm in each gear.
- Shift gears in a timely manner.

All of the above instructions, as may apply to your vehicle type, also apply when driving the first 1000 miles (1500 km) after the engine or the rear differential has been replaced.

- i** Always obey applicable speed limits.

Notes on breaking-in the rear differential (AMG vehicles only)

The vehicle is equipped with a self-locking rear differential. For increased protection of the rear differential, carry out an oil change after a break-in phase of 2000 miles (3000 km). This oil change will extend the useful life of the differential. Have the oil change carried out at a qualified specialist workshop. Mercedes-Benz recommends you have this work done at a authorized Mercedes-Benz Center.

At the gas station

Refueling

⚠ Warning!

Gasoline and diesel fuels are highly flammable and poisonous. They burn violently and can cause serious injury.

Never allow sparks, flames or smoking materials near gasoline or diesel fuel!

Turn off the engine before refueling.

Whenever you are around gasoline or diesel fuel, avoid inhaling fumes and any skin or clothing contact. Extinguish all smoking materials.

Direct skin contact with fuels and the inhalation of fuel vapors are damaging your health.

⚠ Warning!

Overfilling of the fuel tank may create pressure in the system which could cause a gas discharge. This could cause the gas to spray back out when removing the fuel pump nozzle, which could cause personal injury.

⚠ Warning!

Do not fill diesel tanks with gasoline. Do not mix diesel fuel with gasoline. Otherwise the fuel system and engine could be damaged. In addition, the vehicle could catch fire.

! Never refuel vehicles with gasoline engine with diesel fuel. Never refuel vehicles with diesel engine with gasoline. Even small amounts of incorrect fuel will damage the fuel system and engine. Damage resulting from the use of non-approved fuels or fuel additives or resulting from mixing gasoline with diesel fuel or vice versa is not covered by the Mercedes-Benz Limited Warranty.

! If you have accidentally filled the tank with incorrect or non-approved fuel, do not switch on the ignition. Otherwise the incorrect or non-approved fuel will get into the fuel lines. The fuel system must be drained completely. Contact an authorized Mercedes-Benz Center to have the fuel system drained completely.

! Gasoline engine:

To prevent damage to the catalytic converters, only use premium unleaded gasoline in this vehicle.

Any noticeable irregularities in engine operation should be repaired promptly. Otherwise, excessive unburned fuel may reach the catalytic converter, causing it to overheat and potentially start a fire.

! Diesel engine:

When filling the diesel fuel tank using fuel containers, place a filling filter, a suede cloth or a clean flannel cloth as a filter. Otherwise, particles from the fuel container could clog the fuel lines and/or the diesel injection system.

! Diesel engine:

The engine is more susceptible to wear and damage if you use

- marine diesel fuel
- heating oil
- additives

The exhaust aftertreatment device will be seriously damaged if you use any other diesel fuel than ULTRA-LOW SULFUR

HIGHWAY DIESEL FUEL (ULSD, 15 ppm SULFUR MAXIMUM).

The use of such non-approved fuels and/or special additives is not covered by the Mercedes-Benz Limited Warranty.

i Gasoline engine:

Only use premium unleaded gasoline with a minimum Posted Octane Rating of 91 (average of 96 RON/86 MON).

Information on gasoline quality can normally be found on the fuel pump. Please contact gas station personnel in case labels on the pump cannot be found.

For more information on gasoline, see “Premium unleaded gasoline (gasoline engine)” (▷ page 362), see “Fuel requirements” (▷ page 363), or contact an authorized Mercedes-Benz Center, or visit www.mbusa.com (USA only).

i Diesel engine:

Only use commercially available vehicular ULTRA-LOW SULFUR HIGHWAY DIESEL FUEL (ULSD, 15 ppm SULFUR MAXIMUM). Information on diesel quality can normally be found on the fuel pump. Please contact gas station personnel in case labels on the pump cannot be found.

For more information on diesel fuels, see “Fuel requirements” (▷ page 363), or contact an authorized Mercedes-Benz Center, or visit www.mbusa.com (USA only).

i Diesel engine:

If you have driven the vehicle until the tank is empty, the fuel system needs to be bled (▷ page 333).

Locking/unlocking the vehicle with the SmartKey or KEYLESS-GO automatically locks/unlocks the fuel filler flap.

i In case the central locking system does not release the fuel filler flap, see “Fuel filler flap” (▷ page 316).

The fuel filler flap is located on the right-hand side of the vehicle towards the rear.

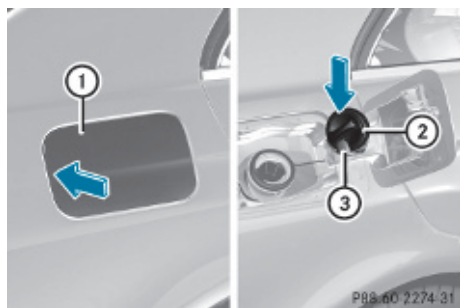

► Turn off the engine.

i Leaving the engine running and the fuel filler cap open can cause the yellow engine malfunction indicator lamp  to illuminate.

For more information, see also “Practical hints” (▷ page 310).

► Remove the SmartKey from the starter switch.

KEYLESS-GO: Open the driver's door. This puts the starter switch in position **0**, same as with the SmartKey removed from the starter switch. The driver's door then can be closed again.

► **Opening:** Press fuel filler flap **①** at the point indicated by the arrow.

► Turn fuel filler cap **②** counterclockwise.

► Take off fuel filler cap **②**.

! The fuel filler cap is tethered to the fuel filler neck. Do not drop the cap. It could damage the vehicle paint finish.

► Place fuel filler cap **②** in direction of arrow into holder **③**.

► Fully insert filler nozzle unit and refuel.

► Only fill your tank until the filler nozzle unit cuts out – **do not top off or overfill.**

► **Closing:** Turn fuel filler cap **②** clockwise until it audibly engages.

i Close the fuel filler flap before locking the vehicle. Otherwise the flap locking pin will prevent closing the fuel filler flap.

► Close fuel filler flap **①**.

Low outside temperatures (diesel engine)

! Do not fill the tank with gasoline. Do not blend diesel fuel with gasoline or kerosene. The fuel system and engine will otherwise be damaged, which is not covered by the Mercedes-Benz Limited Warranty.

To prevent malfunctions, diesel fuel with improved cold flow characteristics is offered in the winter months. Check with your fuel retailer.

Check regularly and before a long trip

For information on quantities and requirements of operating agents, see “Fuels, coolants, lubricants, etc.” (▷ page 359).

Check the following:

- Engine oil level (▷ page 224)
- Tire inflation pressure (▷ page 231)
- Coolant level (▷ page 226)
- Vehicle lighting (▷ page 318)
- Washer system and headlamp cleaning system (▷ page 227)
- Brake fluid (▷ page 227)

Engine compartment

Hood

Warning!

Do not pull the release lever while the vehicle is in motion. Otherwise the hood could be forced open by passing air flow.

This could cause the hood to come loose and injure you and/or others.

Opening

Warning!

Do not open the hood when the engine is overheated. You could be seriously injured. Observe the coolant temperature gauge to determine whether the engine may be overheated. If you see flames or smoke coming from the engine compartment, move away from the vehicle. Wait until the engine has cooled. If necessary, call the fire department.

Warning!

You could be injured when the hood is open – even when the engine is turned off.

Parts of the engine can become very hot. To prevent burns, let the engine cool completely before touching any components on the vehicle. Comply with all relevant safety precautions.

Warning!

To help prevent personal injury, stay clear of moving parts when the hood is open and the engine is running.

The radiator fan may continue to run for approximately 30 seconds or may even restart after the engine has been turned off. Stay clear of fan blades.

Warning!

Vehicles with gasoline engine:
The engine is equipped with a transistorized ignition system. Because of the high voltage it is dangerous to touch any components (ignition coils, spark plug sockets, diagnostic socket) of the ignition system

- with the engine running
- while starting the engine
- when the ignition is switched on and the engine is turned manually

Warning!

Vehicles with diesel engine:
The engine is equipped with a high-voltage electronic control unit for the injection system. Because of the high voltage it is dangerous to touch any components of the injection system (injectors, electrical wires)

- with the engine running
- while starting the engine
- when the ignition is switched on

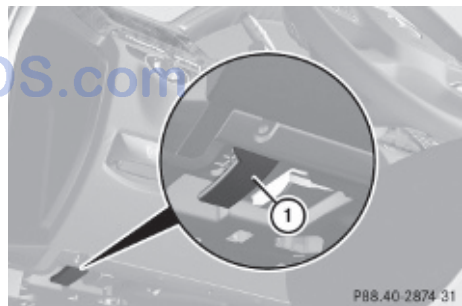

- ▶ Pull hood lock release lever ①.
The hood is unlocked.

- ❗ Never open the hood if the wiper arms are folded forward away from the windshield. Otherwise the windshield wipers or the hood could be damaged.

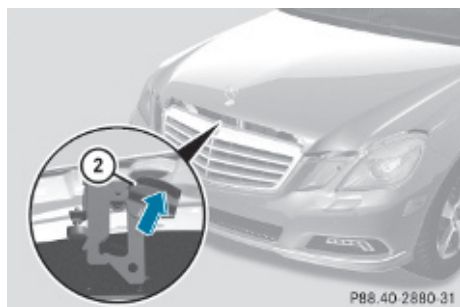

- ▶ Push handle ② under the hood upwards.
- ▶ Pull up on the hood and then release it. The hood will be held open at shoulder height by gas-filled struts automatically.

Closing

Warning!

When closing the hood, use extreme caution not to catch hands or fingers. Be careful that you do not close the hood on anyone.

Make sure the hood is securely engaged before driving off. Do not continue driving if the hood can no longer engage after an accident, for example. The hood could otherwise come loose while the vehicle is in motion and injure you and/or others.

- ▶ Let the hood drop from a height of approximately 8 in (20 cm).
- ▶ Check to make sure the hood is fully closed.

If you can raise the hood at a point above the headlamps, then it is not properly closed. Open it again and let it drop with somewhat greater force.

Radiator

- i** Vehicles with diesel engine:
Do not cover the radiator, for example with a winter front or bug cover. Otherwise the readings of the on-board diagnostic system may be inaccurate. Some of these

readings are required by law and must be accurate at all times.

Engine oil

The amount of oil your engine consumes will depend on a number of factors, including driving style. Increased oil consumption can occur when the vehicle is new or the vehicle is driven frequently at higher engine speeds. Engine oil consumption checks should only be made after the vehicle break-in period.

- !** Do not use any special lubricant additives, as these may damage the drive assemblies. Using special additives not approved by Mercedes-Benz may cause damage not covered by the Mercedes-Benz Limited Warranty.

For further information contact an authorized Mercedes-Benz Center.

Notes on checking engine oil level

When checking the oil level

- the vehicle must be parked on level ground
- with the engine at operating temperature, the vehicle must have been stationary for at least 5 minutes with the engine turned off
- with the engine not at operating temperature, the vehicle must have been stationary for at least 30 minutes with the engine turned off

Checking engine oil level

- ▶ Open the hood (▷ page 223).

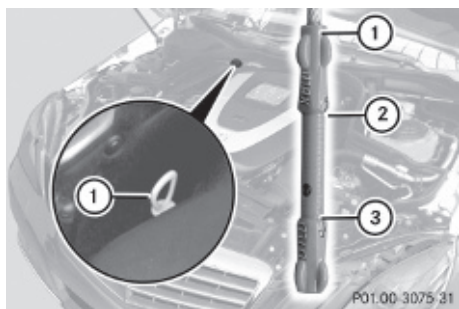

Example illustration: Gasoline engine

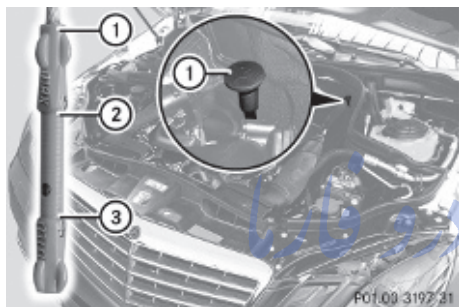

Example illustration: Diesel engine

- ▶ Pull out oil dipstick ①.
- ▶ Wipe oil dipstick ① clean.
- ▶ Slowly insert oil dipstick ① fully into the dipstick guide tube.
- ▶ Pull out oil dipstick ① again after approximately 3 seconds to obtain accurate reading.
The oil level is correct when it is between lower (min) mark ③ and upper (max) mark ② of oil dipstick ①.

i E 350:

The filling quantity between the upper and lower marks on the oil dipstick is approximately 2.1 US qt. (2.0 l).

E 550, E 63 AMG:

The filling quantity between the upper and lower marks on the oil dipstick is approximately 1.6 US qt. (1.5 l).

- ▶ If necessary, add engine oil.

For more information on engine oil, see “Fuels, coolants, lubricants etc.”

(▷ page 359).

For information on messages in the multifunction display concerning engine oil, see the “Practical hints” section

(▷ page 298).

Adding engine oil

! Only use approved engine oils and oil filters required for vehicles with Maintenance System. For a listing of approved engine oils and oil filters, contact an authorized Mercedes-Benz Center or visit www.mbusa.com (USA only).

The following will result in engine or emission control system damage not covered by the Mercedes-Benz Limited Warranty:

- Using engine oils and oil filters of specification other than those expressly required for the Maintenance System.
- Changing of oil and oil filter at change intervals longer than those called for by the Maintenance System.
- Using any oil additives.



Example illustration: E 350 (E 550 similar)

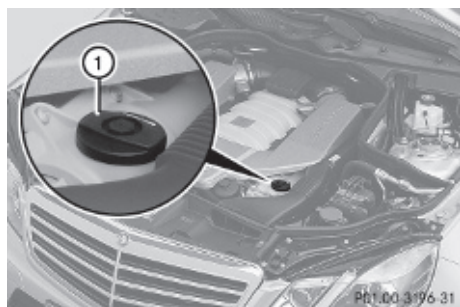

E 63 AMG

- ▶ Unscrew filler cap ① from filler neck.
- ▶ Add engine oil as required. Be careful not to overfill with oil.

Be careful not to spill any oil when adding. Avoid environmental damage caused by oil entering the ground or water.

! Excess oil must be siphoned or drained off. It could cause damage to the engine and emission control system not covered by the Mercedes-Benz Limited Warranty.

- ▶ Screw filler cap ① back on filler neck.

For more information on engine oil, see the "Technical data" section (▶ page 359) and (▶ page 361).

Transmission fluid level

The transmission fluid level does not need to be checked. If you notice transmission fluid loss or gearshifting malfunctions, have an authorized Mercedes-Benz Center check the transmission.

Coolant level

The engine coolant is a mixture of water and anticorrosion/antifreeze.

When checking the coolant level, the vehicle must be parked on level ground, and the coolant temperature must be below 158°F (70°C).

Warning!

In order to avoid any potentially serious burns:

- Use extreme caution when opening the hood if there are any signs of steam or coolant leaking from the cooling system, or if the coolant temperature gauge indicates that the coolant is overheated.
- Do not remove the cap on the coolant expansion tank if the coolant temperature is above 158°F (70°C). Allow the engine to cool down before removing the cap. The coolant expansion tank contains hot fluid and is under pressure.
- Using a rag, slowly open the cap approximately $1/2$ turn counterclockwise to relieve excess pressure. If opened immediately, scalding hot fluid and steam will be blown out under pressure.
- Do not spill antifreeze on hot engine parts. Antifreeze contains ethylene glycol which may burn if it comes into contact with hot engine parts.



- ▶ Using a rag, slowly open cap ① approximately $1/2$ turn counterclockwise to relieve excess pressure.
- ▶ Continue turning cap ① counterclockwise and remove it.

The coolant level is correct if the level

- for cold coolant: reaches marking bar ③ in coolant expansion tank ②
- for warm coolant: is approximately 0.6 in (1.5 cm) higher

- ▶ Add coolant as required.
- ▶ Screw cap ① back on and tighten it.

For more information on coolant, see the “Technical data” section (▷ page 361) and (▷ page 365).

Washer system and headlamp cleaning system

Warning!

Washer solvent/antifreeze is highly flammable. Do not spill washer solvent/antifreeze on hot engine parts, because it may ignite and burn. You could be seriously burned.

! Always use washer solvent/antifreeze where temperatures may fall below freezing point. Failure to do so could result in damage to the washer system/fluid reservoir.

! Only use washer fluid which is suitable for plastic lenses. Improper washer fluid can damage the plastic lenses of the headlamps.

! Do not use distilled or deionized water in the washer fluid reservoir. Otherwise, the washer fluid level sensor could be damaged.

Fluid for the washer system and the headlamp cleaning system is supplied from the washer fluid reservoir.

During all seasons, use MB Windshield Washer Concentrate “MB SummerFit”. Mix it with water or premixed washer solvent/antifreeze depending on the ambient temperature (▷ page 367).

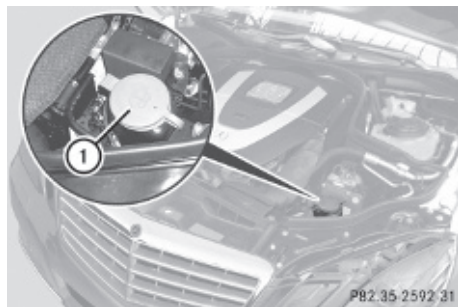

▶ **Opening washer fluid reservoir:** Pull tab of cap ① upwards.

▶ Refill the washer fluid reservoir.

▶ **Closing washer fluid reservoir:** Press cap ① onto filler hole until it engages.

For more information, see “Washer system and headlamp cleaning system” (▷ page 361).

Brake fluid level

! If you find that the brake fluid in the brake fluid reservoir has fallen to the minimum mark or below, have the brake system checked for brake pad thickness and leaks immediately. Contact an authorized Mercedes-Benz Center immediately. Do not add brake fluid as this will not solve the problem. For more information, see “Practical hints”.

When checking the brake fluid level, the vehicle must be parked on level ground.

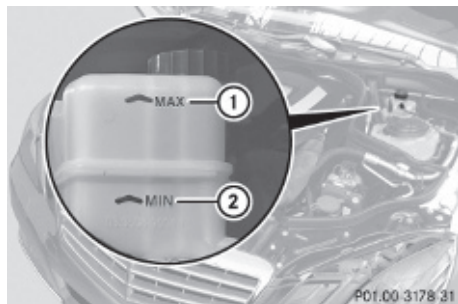

The brake fluid level is correct when it is between lower mark (MIN) ② and upper mark (MAX) ① of the brake fluid reservoir.

Tires and wheels

Safety notes

Contact an authorized Mercedes-Benz Center for information on tested and recommended rims and tires for summer and winter operation. They can also offer advice concerning tire service and purchase.

Warning!

Replace rims or tires with the same designation, manufacturer and type as shown on the original part. For further information contact an authorized Mercedes-Benz Center. If incorrectly sized rims and tires are mounted, the wheel brakes or suspension components can be damaged. Also, the operating clearance of the wheels and the tires may no longer be correct.

Warning!

Worn, old tires can cause accidents. If the tire tread is worn to minimum tread depth, or if the tires have sustained damage, replace them.

When replacing rims, only use genuine Mercedes-Benz wheel bolts specified for the particular rim type. Failure to do so can result in the bolts loosening and possibly an accident.

Retreaded tires are not tested or recommended by Mercedes-Benz, since previous damage cannot always be recognized on retreads. The operating safety of the vehicle cannot be assured when such tires are used.

Warning!

If you feel a sudden significant vibration or ride disturbance, or you suspect that possible damage to your vehicle has occurred, you

should turn on the hazard warning flashers, carefully slow down, and drive with caution to an area which is a safe distance from the road. Inspect the tires and the vehicle underbody for possible damage. If the vehicle or tires appear unsafe, have the vehicle towed to the nearest authorized Mercedes-Benz Center or tire dealer for repairs.

Warning!

Do not drive with a flat tire. A flat tire affects the ability to steer or brake the vehicle. You could lose control of the vehicle. Continued driving with a flat tire or driving at high speed with a flat tire will cause excessive heat build-up and possibly a fire.

Important guidelines

- Only use sets of tires and rims of the same type and make.
- Tires must be of the correct size for the rim.
- Break in new tires for approximately 60 miles (100 km) at moderate speeds.
- Regularly check the tires and rims for damage. Dented or bent rims can cause tire inflation pressure loss and damage to the tire beads.
- If the vehicle is heavily loaded, check tire inflation pressure and correct as required.
- Do not allow your tires to wear down too far. Adhesion properties on wet roads are sharply reduced at tread depths of less than $\frac{1}{8}$ in (3 mm).
- When replacing individual tires, you should mount new tires on the front wheels first (on vehicles with same-sized wheels all around).

Recommended tire inflation pressure

Warning!

Follow recommended tire inflation pressures. Do not underinflate tires. Underinflated tires wear excessively and/or unevenly, adversely affect handling and fuel economy, and are more likely to fail from being overheated.

Do not overinflate tires. Overinflated tires can adversely affect handling and ride comfort, wear unevenly, increase stopping distance, and result in sudden deflation (blowout) because they are more likely to become punctured or damaged by road debris, potholes etc.

Do not overload the tires by exceeding the specified load limit as indicated on the Tire and Loading Information placard on the driver's door B-pillar. Overloading the tires can overheat them, possibly causing a blowout. Overloading the tires can also result in handling or steering problems, or brake failure.

Your vehicle is equipped with the Tire and Loading Information placard located on the driver's door B-pillar (▷ page 237).

The tire inflation pressure should be checked regularly. Only adjust the tire inflation pressure on cold tires. The tires can be considered cold if the vehicle has been parked for at least 3 hours or driven less than 1 mile (1.6 km). Depending on the ambient temperature, the driving speed and the tire load, the tire temperature changes. When the tire temperature changes by 18°F (10°C), the tire inflation pressure will change by approximately 1.5 psi (0.1 bar). Keep this in mind when checking tire inflation pressure on warm tires and adjust the tire pressure only if the tire inflation pressure is too low for the current operating conditions. If you check the tire inflation pressure when the tires are warm, the reading will be higher than the cold reading. This is normal. Do not let air out to match the specified cold tire inflation

pressure. Otherwise, the tire will be underinflated.

Follow recommended cold tire inflation pressures listed on Tire and Loading Information placard on the driver's door B-pillar.

Keeping the tires properly inflated provides the best handling, tread life and riding comfort.

In addition to the Tire and Loading Information placard on the driver's door B-pillar, also consult the tire inflation pressure label on the inside of the filler flap for any additional information pertaining to special driving situations. For more information, see "Important notes on tire inflation pressure" (▷ page 230).

 Data shown on Tire and Loading Information placard example are for illustration purposes only. Tire data are specific to each vehicle and may vary from data shown in the following illustration. Refer to Tire and Loading Information placard on vehicle for actual data specific to your vehicle.



The placard contains the following information:

TIRE RECOMMANDATIONS RECOMMANDATIONS DES PNEUS		LOADING INFORMATION INFORMATION DE CHARGEMENT	
SEATING CAPACITY NOMBRE DE SIÈGES	1000	1 FRONT AXLE AXE AVANT	2 REAR AXLES AXES ARRIÈRE
*The maximum weight of passengers and cargo is shown. Do not exceed 3000 kg or 6600 lbs. * Le poids total des occupants et des marchandises ne doit pas dépasser 3000 kg ou 6600 lbs.			
TIRE PNEU	SIZE TAILLE	COLD TIRE PRESSURE PRESSION DES PNEUS À FROID	SEE OWNERS MANUAL FOR ADDITIONAL INFORMATION
FRONT AVANT	255/40 ZR18 99Y XL	200 KPA, 29 PSI	
REAR ARRIÈRE	205/55 ZR18 98Y XL	200 KPA, 29 PSI	
SPARE DE RECHANGE	175/70 R16 SP	420 KPA, 60 PSI	

P40.00-2133-31

The Tire and Loading Information placard lists the recommended cold tire inflation pressures  for maximum loaded vehicle weight. The tire inflation pressures listed apply to the tires installed as original equipment.

Important notes on tire inflation pressure

⚠ Warning!

If the tire inflation pressure drops repeatedly, check the tires for punctures from foreign objects and/or whether air is leaking from the valves or from around the rim.

Tire temperature and tire inflation pressure are also increased while driving, depending on the driving speed and the tire load.

If you will be driving your vehicle at high speeds of 100 mph (160 km/h) or higher, where it is legal and conditions allow, consult the tire inflation pressure label on the inside of the fuel filler flap on how to adjust the cold tire inflation pressure. If you do not adjust the tire inflation pressure, excessive heat can build up and result in sudden tire failure.

If you are not sure about the proper tire inflation pressure, contact an authorized Mercedes-Benz Center.

- Driving comfort may be reduced when the tire inflation pressure is adjusted to the value for speeds above 100 mph (160 km/h) as specified on the tire inflation pressure label located on the inside of the fuel filler flap.

Make sure to readjust the tire inflation pressure for normal driving speeds.

Supplemental tire inflation pressure information for different loading conditions of the vehicle can be found on the tire inflation pressure label. The tire inflation pressure label is located on the inside of the fuel filler flap.

For the tire inflation pressure for spare wheels such as Minispare wheels or spare wheels with collapsible tire refer to

- the yellow label on the spare wheel rim
- the “Technical data” section of this Operator’s Manual (▷ page 358)
- the Tire and Loading Information placard on the driver’s door B-pillar

Unless specified otherwise, the tire inflation pressures on the tire inflation pressure label are valid for all approved, factory-equipped tires.

- Data shown on tire inflation pressure label examples are for illustration purposes only. Tire inflation pressure data are specific to each vehicle and may vary from data shown in the following illustrations. Refer to the tire inflation pressure label on vehicle for actual data specific to your vehicle.

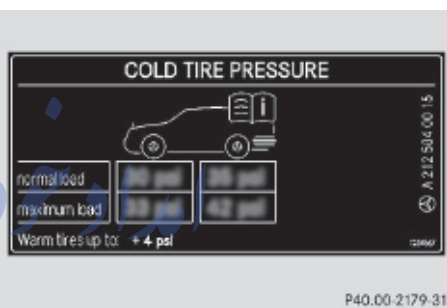

Example illustration: Tire inflation pressures for all approved, factory equipped tires

When a tire size is specified, the tire inflation pressure that follows applies to that particular tire size only.

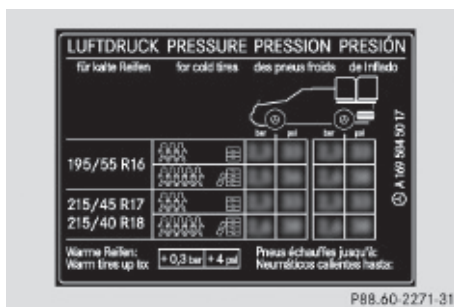

Example illustration: Tire inflation pressures for particular tire sizes

Some tire inflation pressure labels may only show the rim diameter instead of the entire tire size, e.g. **R 18** or **18"**.

The rim diameter is part of the tire size as specified on the tire sidewall (▷ page 246).

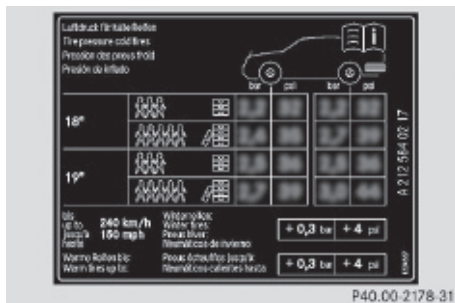

Example illustration: Tire inflation pressures specific to rim diameter

Potential problems associated with underinflated and overinflated tires

Underinflated tires

⚠ Warning!

Follow recommended tire inflation pressures. Do not underinflate tires. Underinflated tires wear excessively and/or unevenly, adversely affect handling and fuel economy, and are more likely to fail from being overheated.

Underinflated tires can

- cause excessive and uneven tire wear
- adversely affect fuel economy
- lead to tire failure from being overheated
- adversely affect handling characteristics

Overinflated tires

⚠ Warning!

Follow recommended tire inflation pressures. Do not overinflate tires. Overinflated tires can adversely affect handling and ride comfort, wear unevenly, increase stopping distance, and result in sudden deflation (blowout) because they are more likely to become punctured or damaged by road debris, potholes etc.

Overinflated tires can

- adversely affect handling characteristics
- cause uneven tire wear

- be more prone to damage from road hazards
- adversely affect ride comfort
- increase stopping distance

Checking tire inflation pressure

Safety notes

⚠ Warning!

Follow recommended tire inflation pressures.

Do not underinflate tires. Underinflated tires wear excessively and/or unevenly, adversely affect handling and fuel economy, and are more likely to fail from being overheated.

Do not overinflate tires. Overinflated tires can adversely affect handling and ride comfort, wear unevenly, increase stopping distance, and result in sudden deflation (blowout) because they are more likely to become punctured or damaged by road debris, potholes etc.

Do not overload the tires by exceeding the specified load limit as indicated on the Tire and Loading Information placard on the driver's door B-pillar. Overloading the tires can overheat them, possibly causing a blowout. Overloading the tires can also result in handling or steering problems, or brake failure.

Check the tire inflation pressure at least once a month.

Check and adjust the tire inflation pressure when the tires are cold (▷ page 229).

Checking tire inflation pressure manually

Follow the steps below to achieve correct tire inflation pressure:

- ▶ Remove the cap from the valve on one tire.
- ▶ Firmly press a tire gauge onto the valve.
- ▶ Read the tire inflation pressure on the tire gauge and check against the recommended tire inflation pressure on the

Tire and Loading Information placard on the driver's door B-pillar (▷ page 237). If necessary, add air to achieve the recommended tire inflation pressure.

- ▶ If you have overfilled the tire, release tire inflation pressure by pushing the metal stem of the valve with e.g. a tip of a pen. Then recheck the tire inflation pressure with the tire gauge.
- ▶ Install the valve cap.
- ▶ Repeat this procedure for each tire.

Tire pressure loss warning system (Canada only)

While the vehicle is being driven, the tire pressure loss warning system monitors the set tire inflation pressures by evaluating each wheel's rotational speed. This allows the system to detect a significant loss of pressure in a tire. If a wheel's rotational speed changes due to falling tire inflation pressure, you will see a corresponding warning message in the multifunction display.

The tire pressure loss warning system may function in a restricted manner or with a delay

- when snow chains are mounted to the vehicle
- in the presence of ice and snow
- when you are driving on a loose surface (e.g. sand or gravel)
- when you are driving in a very sporty manner (involving rapid acceleration or high speeds in curves)

Warning!

When the multifunction display shows the message Check Tire Pressure Soon, one or more of your tires are significantly underinflated. You should stop and check your tires as soon as possible, and inflate them to the proper tire inflation pressure as indicated on the vehicle's Tire and Loading Information placard or, if available, on the tire inflation pressure label.

Driving on a significantly underinflated tire causes the tire to overheat and can lead to tire failure. Underinflation also reduces fuel efficiency and tire tread life, and may affect the vehicle's handling and stopping ability.

Each tire, including the spare, should be checked at least once a month when cold. Inflate the tires to the recommended tire inflation pressure as specified on

- the Tire and Loading Information placard on the driver's door B-pillar
or
- the tire inflation pressure label located on the inside of the fuel filler flap

 The recommended tire inflation pressures for your vehicle can be found on

- the Tire and Loading Information placard located on the driver's door B-pillar (▷ page 237)
- the tire inflation pressure label on the inside of the fuel filler flap

The tire inflation pressures are not listed in the Operator's Manual.

Warning!

The tire pressure loss warning system does not provide a warning for wrongly selected tire inflation pressures. Always adjust tire inflation pressure according to the Tire and Loading Information placard on the driver's door B-pillar or on the tire inflation pressure label located on the inside of the fuel filler flap. The tire pressure loss warning system does not replace regular checks of the tire inflation pressures since a gradual pressure loss in more than one tire cannot be detected by the tire pressure loss warning system.

The tire pressure loss warning system is not able to issue a warning due to a sudden dramatic loss of tire inflation pressure (e.g. tire blowout caused by a foreign object). In this case bring the vehicle to a halt by carefully

applying the brakes and avoiding abrupt steering maneuvers.

Restarting the tire pressure loss warning system







The tire pressure loss warning system must be restarted in the following situations:

- after you have changed the tire inflation pressure
 - after you have replaced the wheels or tires
 - after you have installed new wheels or tires
- ▶ Using the Tire and Loading Information placard on the driver's door B-pillar or, if available, the tire inflation pressure label on the inside of the fuel filler flap, make sure the tire inflation pressure of all four tires is correct.







Warning!

The tire pressure loss warning system can only warn you in a reliable manner if you have set the correct tire inflation pressures for each tire.

If an incorrect tire inflation pressure was set, the system will monitor the pressure according to the incorrect value.

- ▶ Switch on the ignition.
- ▶ Press button  or  on the multifunction steering wheel to select the Serv. menu (▷ page 138).
- ▶ Press button  or  on the multifunction steering wheel to select Tire Pressure.
- ▶ Press button  on the multifunction steering wheel to confirm. The following message appears in the multifunction display:
Run Flat Indicator
Active
Press 'OK' to Restart
- ▶ Press button . The following message will appear in the multifunction display:
Tire Pressure

Now OK?
Cancel
Yes

- ▶ **If you wish to confirm:** Press button  or  to select Yes.
- ▶ Press button . The following message will appear in the multifunction display:
Run Flat Indicator
Restarted
After a certain "learning phase", the tire pressure loss warning system checks the set pressure values for all four tires.
- ▶ **If you wish to cancel:** Press button  or  to select Cancel.
- ▶ Press button  to confirm. The previous settings remain unchanged.

Advanced Tire Pressure Monitoring System (Advanced TPMS)

Your vehicle is equipped with the Advanced Tire Pressure Monitoring System (Advanced TPMS). It measures the tire inflation pressure in the vehicle's tires and issues warnings in case of pressure loss in one or more of the tires.

The TPMS is equipped with a combination low tire pressure/TPMS malfunction telltale (USA) or a low tire pressure telltale (Canada) in the instrument cluster. Depending on how the telltale illuminates, it indicates a low tire pressure condition or a malfunction in the TPMS system itself:

- If the telltale illuminates continuously, one or more of your tires is significantly underinflated. There is no malfunction in the TPMS.
- USA only: If the telltale flashes for 60 seconds and then stays illuminated, the TPMS system itself is not operating properly.

The TPMS only functions on wheels that are equipped with the proper electronic sensors.

Warning!

The TPMS does not indicate a warning for wrongly selected inflation pressures. Always adjust tire inflation pressure according to the Tire and Loading Information placard or the supplemental tire inflation pressure information on the inside of the fuel filler flap. The TPMS is not able to issue a warning due to a sudden dramatic loss of pressure (e.g. tire blowout caused by a foreign object). In this case bring the vehicle to a halt by carefully applying the brakes and avoiding abrupt steering maneuvers.

Warning!

Each tire, including the spare (if provided), should be checked at least once a month when cold and inflated to the inflation pressure recommended by the vehicle manufacturer on the Tire and Loading Information placard on the driver's door B-pillar or the tire inflation pressure label on the inside of the fuel filler flap. If your vehicle has tires of a different size than the size indicated on the Tire and Loading Information placard or the tire inflation pressure label, you should determine the proper tire inflation pressure for those tires.

As an added safety feature, your vehicle has been equipped with a tire pressure monitoring system (TPMS) that illuminates a low tire pressure telltale when one or more of your tires are significantly underinflated. Accordingly, when the low tire pressure telltale illuminates, you should stop and check your tires as soon as possible, and inflate them to the proper pressure. Driving on a significantly underinflated tire causes the tire to overheat and can lead to tire failure.

Underinflation also reduces fuel efficiency and tire tread life, and may affect the vehicle's handling and stopping ability. Please note that the TPMS is not a substitute for proper tire maintenance, and it is the driver's responsibility to maintain correct tire pressure, even if underinflation has not

reached the level to trigger illumination of the TPMS low tire pressure telltale.

USA only:

Your vehicle has also been equipped with a TPMS malfunction indicator to indicate when the system is not operating properly. The TPMS malfunction indicator is combined with the low tire pressure telltale. When the system detects a malfunction, the telltale will flash for approximately 1 minute and then remain continuously illuminated. This sequence will continue upon subsequent vehicle start-ups as long as the malfunction exists. When the malfunction indicator is illuminated, the system may not be able to detect or signal low tire pressure as intended. TPMS malfunctions may occur for a variety of reasons, including the installation of incompatible replacement or alternate tires or wheels on the vehicle that prevent the TPMS from functioning properly. Always check the TPMS malfunction telltale after replacing one or more tires or wheels on your vehicle to ensure that the replacement or alternate tires and wheels allow the TPMS to continue to function properly.

USA only:

If a condition causing the TPMS to malfunction develops, it may take up to 10 minutes for the system to signal a malfunction using the TPMS telltale flashing and illumination sequence.

The telltale extinguishes after a few minutes driving if the malfunction has been corrected.

Tire pressure inquiries are made using the multifunction display. The current tire inflation pressure for each tire appears in the multifunction display after a few minutes of driving.

 Possible differences between the readings of a tire pressure gauge of an air hose, e.g. gas station equipment, and the vehicle's control system can occur. The tire

pressure displayed by the control system apply to sea level. In high-altitude locations, the reading on a tire pressure gauge will be higher than the reading issued by the vehicle's control system. Do not reduce the tire inflation pressure under such circumstances.

- ▶ Switch on the ignition.
- ▶ Press button ◀ or ▶ on the multifunction steering wheel to select the Serv. menu (▶ page 138).
- ▶ Press button ▲ or ▼ to select Tire Pressure.
- ▶ Press button OK.

The current inflation pressure for each tire appears in the multifunction display.



Example illustration

When the vehicle has been parked for longer than 20 minutes, the message Tire pressures will be displayed after driving a few minutes appears in the multifunction display.

The TPMS recognizes new wheels or sensors automatically after the learn-in phase. As long as the tire inflation pressure values cannot be allocated to the individual wheels, the message Tire Pressure Monitor Active appears. Despite this message, the tire inflation pressure values are monitored already.

- ▶ **i** With a spare wheel mounted, the system may still indicate the tire inflation pressure of the removed road wheel for some minutes. If this happens, keep in mind that the indicated value where the spare wheel is mounted does not reflect the actual spare tire inflation pressure.

- ▶ **i** Operating radio transmission equipment (e.g. wireless headsets, two-way radios) in or near the vehicle could cause the TPMS to malfunction.

- ▶ **i** USA only:

This device complies with Part 15 of the FCC Rules. Operation is subject to the following two conditions:

1. This device may not cause harmful interference, and
2. this device must accept any interference received, including interference that may cause undesired.

Any unauthorized modification to this device could void the user's authority to operate the equipment.

- ▶ **i** Canada only:

This device complies with RSS-210 of Industry Canada. Operation is subject to the following two conditions:

1. This device may not cause interference, and تلفن شیان
2. this device must accept any interference received, including interference that may cause undesired operation of the device.

Any unauthorized modification to this device could void the user's authority to operate the equipment.

Tire inflation pressure warnings

If the system detects a significant loss of tire inflation pressure in one or more than one tire, a message appears in the multifunction display. In addition, an acoustic warning sounds and the low tire pressure telltale in the instrument cluster comes on.

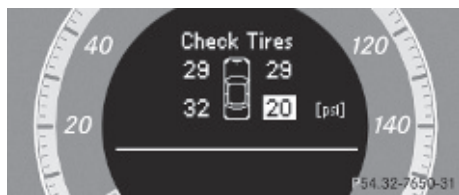

Example illustration

The respective tire is indicated by a red rectangle.

Restarting Advanced TPMS

Warning!

It is the driver's responsibility to set the tire inflation pressure to the recommended cold tire inflation pressure. Underinflated tires affect the ability to steer or brake the vehicle. You might lose control over the vehicle.

When you restart the TPMS, the system sets new reference values for each tire.

The TPMS must be restarted when you have adjusted the tire inflation pressure to a new level (e.g. because of different load or driving conditions). The TPMS is then recalibrated to the current tire inflation pressures.



Canada only:



The TPMS usually recognizes tire pressure adjustments and sets new reference values automatically. You can, however, restart the TPMS manually as described.

Restart the TPMS after adjusting the tire inflation pressure to the inflation pressure recommended for the vehicle operating condition. Tire inflation pressure should only be adjusted on cold tires. Observe the recommended tire inflation pressure on the Tire and Loading Information placard on the driver's door B-pillar. Some vehicles may have supplemental tire inflation pressure information for driving at high speeds or for vehicle loads less than the maximum loaded vehicle condition. If such information is provided, it can be found on the inside of the fuel filler flap.

► Using the Tire and Loading Information placard on the driver's door B-pillar (▷ page 237) or the supplemental tire inflation pressure information on the inside of the fuel filler flap, make sure the tire inflation pressure of all four tires is correct.

► Switch on the ignition.

► Press button  or  on the multifunction steering wheel to select the Serv. menu.

► Press button  or  on the multifunction steering wheel to select Tire Pressure.

► Press button .

The current inflation pressure for each tire appears in the multifunction display or the following message appears in the multifunction display:

Tire pressures will be displayed after driving a few minutes

► Press button .

The following message appears in the multifunction display:

Use Current
Pressures As New
Reference Values
Press 'OK' to Confirm

► Press button .

The following message appears in the multifunction display:

Tire Press. Monitor
Restarted

After driving a few minutes the system verifies that the current tire inflation pressures are within the system's specified range. Afterwards the current tire inflation pressures are accepted as reference values and then monitored.

► **If you wish to cancel:** Press button .
or

► Press button  to exit the menu screen.

 When the wheel positions have been changed, the inflation pressure of a tire

may be displayed for the wrong position temporarily. After driving for a few minutes, the inflation pressure will be shown for the correct position.

Maximum tire inflation pressure

Warning!

Never exceed the maximum tire inflation pressure. Follow recommended tire inflation pressures.

Do not underinflate tires. Underinflated tires wear excessively and/or unevenly, adversely affect handling and fuel economy, and are more likely to fail from being overheated.

Do not overinflate tires. Overinflated tires can adversely affect handling and ride comfort, wear unevenly, increase stopping distance, and result in sudden deflation (blowout) because they are more likely to become punctured or damaged by road debris, potholes etc.

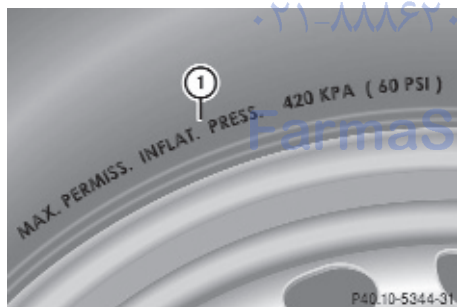

- i** For illustration purposes only. Actual data on tires are specific to each vehicle and may vary from data shown in above illustration.

This is the maximum permissible tire inflation pressure **①** for the tire.

Always follow the recommended tire inflation pressure (▷ page 229) for proper tire inflation.

Loading the vehicle

Two labels on your vehicle show how much weight it may properly carry.

- (1) The Tire and Loading Information placard can be found on the driver's door B-pillar. This placard tells you important information about the number of people that can be in the vehicle and the total weight that can be carried in the vehicle. It also contains information on the proper size and recommended tire inflation pressures for the original equipment tires on your vehicle.
- (2) The certification label, also found on the driver's door B-pillar. It tells you about the gross weight capacity of your vehicle, called the Gross Vehicle Weight Rating (GVWR). The GVWR includes the weight of the vehicle, all occupants, fuel and cargo. The certification label also tells you about the front and rear axle weight capacity, called the Gross Axle Weight Rating (GAWR).

The GAWR is the total allowable weight that can be carried by a single axle (front or rear). Never exceed the GVWR or GAWR for either the front axle or rear axle.

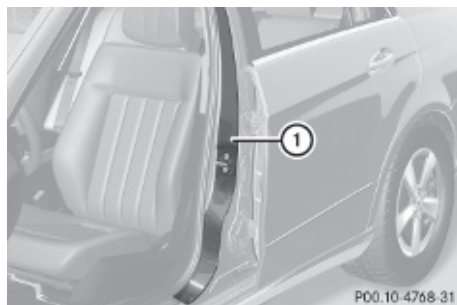

- ①** Driver's door B-pillar

Following is a discussion on how to work with the information contained on the Tire and Loading Information placard with regards to loading your vehicle.

Tire and Loading Information

⚠ Warning!

Do not overload the tires by exceeding the specified load limit as indicated on the Tire and Loading Information placard on the driver's door B-pillar. Overloading the tires can overheat them, possibly causing a blowout. Overloading the tires can also result in handling or steering problems, or brake failure.

Tire and Loading Information placard

① Data shown on Tire and Loading Information placard example are for illustration purposes only. Load limit data are specific to each vehicle and may vary from data shown in the following illustration. Refer to Tire and Loading Information placard on vehicle for actual data specific to your vehicle.

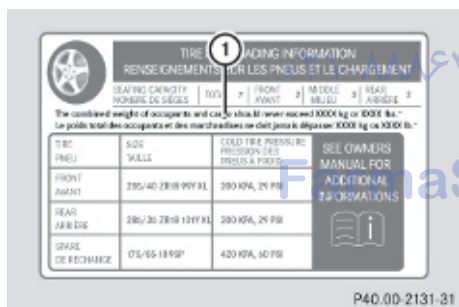

The Tire and Loading Information placard showing load limit information ① is located on the driver's door B-pillar (▷ page 237).

► Locate the statement “The combined weight of occupants and cargo should never exceed XXX kilograms or XXX lbs.” on the Tire and Loading Information placard.

The combined weight of all occupants, cargo/luggage and trailer tongue load (if applicable) should never exceed the weight referenced in that statement.

Seating capacity

① Data shown on Tire and Loading Information placard example are for illustration purposes only. Seating capacity data are specific to each vehicle and may vary from data shown in the following illustration. Refer to Tire and Loading Information placard on vehicle for actual data specific to your vehicle.

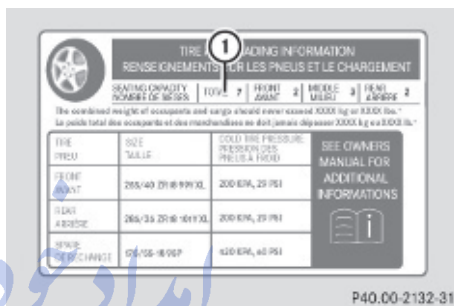

The seating capacity gives you important information on the number of occupants that can be in the vehicle. Observe front and rear seating capacity. The Tire and Loading Information placard showing seating capacity ① is located on the driver's door B-pillar (▷ page 237).

Steps for determining correct load limit

The following steps have been developed as required of all manufacturers under Title 49, Code of U.S. Federal Regulations, Part 575 pursuant to the “National Traffic and Motor Vehicle Safety Act of 1966”.

- **Step 1:** Locate the statement “The combined weight of occupants and cargo should never exceed XXX kg or XXX lbs.” on your vehicle's Tire and Loading Information placard.
- **Step 2:** Determine the combined weight of the driver and passengers that will be riding in your vehicle.
- **Step 3:** Subtract the combined weight of the driver and passengers from XXX kilograms or XXX lbs.

- ▶ **Step 4:** The resulting figure equals the available amount of cargo and luggage load capacity. For example, if the “XXX” amount equals 1 400 lbs and there will be five 150 lbs passengers in your vehicle, the amount of available cargo and luggage load capacity is 650 lbs
(1 400 - 750 (5 x 150) = 650 lbs).
- ▶ **Step 5:** Determine the combined weight of luggage and cargo being loaded on the vehicle. That weight may not safely exceed the available cargo and luggage load capacity calculated in step 4.
- ▶ **Step 6 (if applicable):** If your vehicle will be towing a trailer, load from your trailer will be transferred to your vehicle. Consult this manual to determine how this reduces the available cargo and luggage load capacity of your vehicle (▷ page 241).

The following table shows examples on how to calculate total and cargo load capacities with varying seating configurations and number and size of occupants. The following examples use a load limit of 1 500 lbs. **This is for illustration purposes only.** Make sure you are using the actual load limit for your vehicle stated on the vehicle’s Tire and Loading Information placard (▷ page 238).

FarmaSOS.com

		Example 1	Example 2	Example 3
Step 1	Combined weight limit of occupants and cargo from Tire and Loading Information placard	1 500 lbs	1 500 lbs	1 500 lbs

		Example 1	Example 2	Example 3
Step 2	Number of occupants (driver and passengers)	5	3	1
	Seating configuration	front: 2 rear: 3	front: 1 rear: 2	front: 1
	Occupants weight	Occupant 1: 150 lbs Occupant 2: 180 lbs Occupant 3: 160 lbs Occupant 4: 140 lbs Occupant 5: 120 lbs	Occupant 1: 200 lbs Occupant 2: 190 lbs Occupant 3: 150 lbs	Occupant 1: 150 lbs
	Combined weight of all occupants	750 lbs	540 lbs	150 lbs

		Example 1	Example 2	Example 3
Step 3	Available cargo/ luggage and trailer tongue weight (total load limit from Tire and Loading Information placard minus combined weight of all occupants)	1 500 lbs - 750 lbs = 750 lbs	1 500 lbs - 540 lbs = 960 lbs	1 500 lbs - 150 lbs = 1 350 lbs

The higher the weight of all occupants, the less cargo and luggage load capacity is available.

For more information, see “Trailer tongue load” (▷ page 241).

Certification label

Even after careful determination of the combined weight of all occupants, cargo and the trailer tongue load (if applicable) (▷ page 241) as to not exceed the permissible load limit, you must make sure your vehicle never exceeds the Gross Vehicle

اورا خود کارما
تلفن شبانه روزی: ۰۸۵-۰۲۱-۸۸۸۸۸۸۸۸

FarmaSOS.com

Weight Rating (GVWR) and the Gross Axle Weight Rating (GAWR) for either the front or rear axle. You can obtain the GVWR and GAWR from the certification label. The certification label can be found on the driver's door B-pillar, see the "Technical data" section (▷ page 346).

Gross Vehicle Weight Rating (GVWR): The total weight of the vehicle, all occupants, all cargo, and the trailer tongue load (if applicable) must never exceed the GVWR.

Gross Axle Weight Rating (GAWR): The total allowable weight that can be carried by a single axle (front or rear).

To assure that your vehicle does not exceed the maximum permissible weight limits (GVWR and GAWR for front and rear axle), have the loaded vehicle (including driver, passengers and all cargo and, if applicable, trailer fully loaded) weighed on a suitable commercial scale.

Trailer tongue load

The tongue load of any trailer is an important weight to measure because it affects the load you can carry in your vehicle. If a trailer is towed, the tongue load must be added to the weight of all occupants riding and any cargo you are carrying in the vehicle. The tongue load typically is 10% of the trailer weight and everything loaded in it.

Your Mercedes-Benz has been designed primarily to carry passengers and their cargo. Mercedes-Benz does not recommend trailer towing with your vehicle.

Maximum tire load

Warning!

Do not overload the tires by exceeding the specified load limit as indicated on the Tire and Loading Information placard on the driver's door B-pillar. Overloading the tires can overheat them, possibly causing a blowout. Overloading the tires can also result

in handling or steering problems, or brake failure.



i For illustration purposes only. Actual data on tires are specific to each vehicle and may vary from data shown in above illustration.

The maximum tire load rating ① is the maximum weight the tires are designed to support.

For more information on tire load rating, see (▷ page 246).

For information on calculating total and cargo load capacities, see (▷ page 238).

Direction of rotation

Unidirectional tires offer added advantages, such as better hydroplaning performance. To benefit, however, you must make sure the tires rotate in the direction specified.

An arrow on the sidewall indicates the intended direction of rotation of the tire.

Spare wheels may be mounted against the direction of rotation (spinning) even with a unidirectional tire for temporary use only until the regular drive wheel has been repaired or replaced. Always observe and follow applicable temporary use restrictions and speed limitations indicated on the spare wheel.

MOExtended system

The MOExtended system allows you to continue driving your vehicle even if there is a total loss of pressure in one or more tires.

You may only use the MOExtended system in conjunction with the tire pressure loss warning system (▷ page 232) or the Advanced TPMS (▷ page 233).

- i** Vehicles with MOExtended system are not factory-equipped with a TIREFIT kit. When retrofitting with tires that do not have run-flat characteristics, e.g. winter tires, you should also equip your vehicle with a TIREFIT kit. TIREFIT kits are available at any authorized Mercedes-Benz Center.

For information on driving in case of pressure loss in one or more tires (emergency mode), see the “Practical hints” section (▷ page 329).

Tire care and maintenance

Warning!

Regularly check the tires for damage. Damaged tires can cause tire inflation pressure loss. As a result, you could lose control of your vehicle.

Worn, old tires can cause accidents. If the tire tread is worn to minimum tread depth, or if the tires have sustained damage, replace them.

Check the tire inflation pressure at least once a month. For more information on checking tire inflation pressure, see “Recommended tire inflation pressure” (▷ page 229).

Tire inspection

Every time you check the tire inflation pressure, you should also inspect your tires for the following:

- excessive treadwear (▷ page 242)
- cord or fabric showing through the tire’s rubber
- bumps, bulges, cuts, cracks or splits in the tread or side of the tire

Replace the tire if you find any of the above conditions.

Make sure you also inspect the spare tire periodically for condition and inflation. Spare tires will age and become worn over time even if never used, and thus should be inspected and replaced when necessary.

Life of tire

Warning!

Tires and spare tire should be replaced after 6 years, regardless of the remaining tread.

The service life of a tire is dependent upon varying factors including but not limited to:

- Driving style
- Tire inflation pressure
- Distance driven

Tread depth

Warning!

Although the applicable federal motor vehicle safety laws consider a tire to be worn when the treadwear indicators (TWI) become visible at approximately $\frac{1}{16}$ in (1.6 mm), we recommend that you do not allow your tires to wear down to that level. As tread depth approaches $\frac{1}{8}$ in (3 mm), the adhesion properties on a wet road are sharply reduced. Depending upon the weather and/or road surface (conditions), the tire traction varies widely.

Do not allow your tires to wear down too far. Adhesion properties on wet roads are sharply reduced at tread depths of less than $\frac{1}{8}$ in (3 mm).

Treadwear indicators (TWI) are required by law. These indicators are located in six places on the tread circumference and become visible at a tread depth of approximately $\frac{1}{16}$ in (1.6 mm), at which point the tire is considered worn and should be replaced.

The recommended minimum tire tread depth for summer tires is $\frac{1}{8}$ in (3 mm). The recommended minimum tire tread depth for winter tires is $\frac{1}{6}$ in (4 mm).

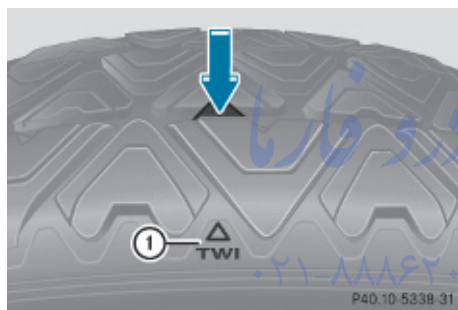

Treadwear indicator ① appears as a solid band across the tread.

Storing tires

- ❗ Keep unmounted tires in a cool, dry place with as little exposure to light as possible. Protect tires from contact with oil, grease and fuels.

Cleaning tires

- ❗ Never use a round nozzle to power wash tires. The intense jet of water can result in damage to the tire. Always replace a damaged tire.

Uniform Tire Quality Grading Standards

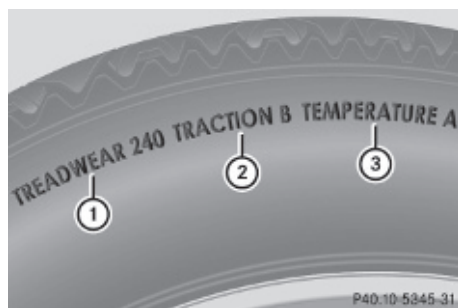

The Uniform Tire Quality Grading is a U.S. Government requirement designed to give drivers consistent and reliable information regarding tire performance. Tire manufacturers are required to grade tires based on three performance factors: treadwear ①, traction ②, and temperature resistance ③. Although not a Government of Canada requirement, all tires made for sale in North America have these grades branded on the sidewall.

- ❗ For illustration purposes only. Actual data on tires are specific to each vehicle and may vary from data shown in above illustration.

Quality grades can be found, where applicable, on the tire sidewall between tread shoulder and maximum section width. For example:

Treadwear	Traction	Temperature
200	AA	A

All passenger car tires must conform to federal safety requirements in addition to these grades.

Treadwear

The treadwear grade is a comparative rating based on the wear rate of the tire when tested under controlled conditions on a specified U.S. Government test course. For example, a

tire graded 150 would wear one and one-half ($1 \frac{1}{2}$) times as well on the government course as a tire graded 100.

The relative performance of tires depends upon the actual conditions of their use, however, and may depart significantly from the norm due to variations in driving habits, service practices and differences in road characteristics and climate.

Traction

Warning!

The traction grade assigned to this tire is based on straight-ahead braking traction tests, and does not include acceleration, cornering, hydroplaning, or peak traction characteristics.

The traction grades, from highest to lowest, are AA, A, B, and C. Those grades represent the tire's ability to stop on wet pavement as measured under controlled conditions on specified government test surfaces of asphalt and concrete. A tire marked C may have poor traction performance.

Warning!

If ice has formed on the road, tire traction will be substantially reduced. Under such weather conditions, drive, steer and brake with extreme caution.

The safe speed on a wet, snow covered or icy road is always lower than on a dry road.

You should pay particular attention to the condition of the road whenever the outside temperature is close to the freezing point.

Mercedes-Benz recommends winter tires (\triangleright page 252) with a minimum tread depth of approximately $\frac{1}{6}$ in (4 mm) on all four wheels for the winter season to ensure normal balanced handling characteristics. On packed snow, they can reduce your stopping distance compared to summer tires. Stopping distance, however, is still considerably greater than when the road is

not covered with snow or ice. Exercise appropriate caution.

-  Avoid spinning of a drive wheel. This may cause serious damage to the drivetrain which is not covered by the Mercedes-Benz Limited Warranty.

Temperature

Warning!

The temperature grade for this tire is established for a tire that is properly inflated and not overloaded. Excessive speed, underinflation, or excessive loading, either separately or in combination, can cause excessive heat build-up and possible tire failure.

The temperature grades are A (the highest), B, and C, representing the tire's resistance to the generation of heat and its ability to dissipate heat when tested under controlled conditions on a specified indoor laboratory test wheel. Sustained high temperature can cause the material of the tire to degenerate and reduce tire life, and excessive temperature can lead to sudden tire failure. The grade C corresponds to a level of performance which all passenger car tires must meet under the Federal Motor Vehicle Safety Standard No. 109. Grades B and A represent higher levels of performance on the laboratory test wheel than the minimum required by law.

Rotating tires

Warning!

Rotate front and rear wheels only if the tires are of the same dimension.

If your vehicle is equipped with mixed-size tires (different tire dimensions front vs. rear), tire rotation is not possible.

Warning!

Have the tightening torque checked after changing a wheel. Wheels could become loose if not tightened with a torque of 96 lb-ft (130 Nm).

Only use genuine Mercedes-Benz wheel bolts specified for your vehicle's rims.

Tire rotation can be performed on vehicles with tires of the same dimension all around. If your vehicle is equipped with tires of the same dimension all around, tires can be rotated, observing a front-to-rear rotation pattern that will maintain the intended rotation (spinning) direction of the tire (▷ page 241).

In some cases, such as when your vehicle is equipped with mixed-size tires (different tire dimension front vs. rear), tire rotation is not possible.

If applicable to your vehicle's tire configuration, tires can be rotated according to the tire manufacturer's recommended intervals in the tire manufacturer's warranty pamphlet located in your vehicle literature portfolio. If none is available, tires should be rotated every 3 000 to 6 000 miles (5 000 to 10 000 km), or sooner if necessary, according to the degree of tire wear. The same rotation (spinning) direction must be maintained.

Rotate tires before the characteristic tire wear pattern becomes visible (shoulder wear on front tires and tread center wear on rear tires).

Thoroughly clean the mounting face of wheels and brake disks, i.e. the inner side of the wheels/tires, during each rotation. Check for and ensure proper tire inflation pressure.

For information on wheel change, see "Flat tire" (▷ page 323).

Tire labeling

Besides tire name (sales designation) and manufacturer name, a number of markings can be found on a tire.

Following are some explanations for the markings on your vehicle's tires:

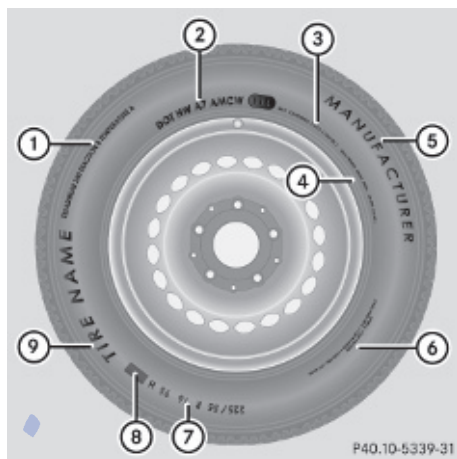

- ① Uniform Tire Quality Grading Standards (▷ page 243)
- ② DOT, Tire Identification Number (▷ page 248)
- ③ Maximum tire load (▷ page 241)
- ④ Maximum tire inflation pressure (▷ page 237)
- ⑤ Manufacturer
- ⑥ Tire ply material (▷ page 249)
- ⑦ Tire size designation, load and speed rating (▷ page 246)
- ⑧ Load identification (▷ page 248)
- ⑨ Tire name

i For illustration purposes only. Actual data on tires are specific to each vehicle and may vary from data shown in above illustration.

For more information, see "Rims and tires" (▷ page 353).

Tire size designation, load and speed rating

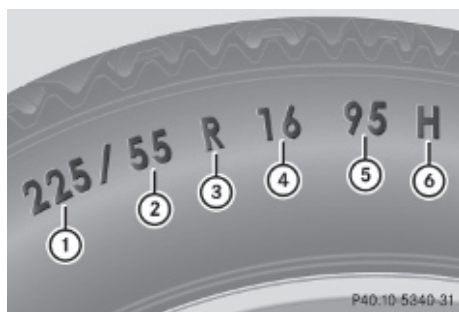

- ① Tire width
- ② Aspect ratio in %
- ③ Radial tire code
- ④ Rim diameter
- ⑤ Load index
- ⑥ Speed symbol

i For illustration purposes only. Actual data on tires are specific to each vehicle and may vary from data shown in above illustration.

General: Depending on the design standards used, the tire size molded into the sidewall may have no letter or a letter preceding the tire size designation.

No letter preceding the size designation (as illustrated above): Passenger car tire based on European design standards.

Letter “P” preceding the size designation: Passenger car tire based on U.S. design standards.

Letter “LT” preceding the size designation: Light Truck tire based on U.S. design standards.

Letter “T” preceding the size designation: Temporary spare tires which are high pressure compact spares designed for temporary emergency use only.

Tire width

Tire width ① indicates the nominal tire width in millimeters.

Aspect ratio

Aspect ratio ② is the dimensional relationship between tire section height and section width and is expressed in percentage. The aspect ratio is arrived at by dividing section height by section width.

Tire code

Tire code ③ indicates the tire construction type. The “R” stands for radial tire type. Letter “D” means diagonal or bias ply construction; letter “B” means belted-bias ply construction.

At the tire manufacturer’s option, any tire with a speed capability above 149 mph (240 km/h) can include a “ZR” in the size designation (for example: 245/40 ZR 18). For additional information, see “Tire speed rating” (▷ page 247).

Rim diameter

Rim diameter ④ is the diameter of the bead seat, not the diameter of the rim edge. The rim diameter is indicated in inches (in).

Load index

⚠ Warning!

The tire load rating must always be at least half of the GAWR of your vehicle. Otherwise, tire failure may be the result which may cause an accident and/or serious injury to you or others.

Always replace rims and tires with the same designation, manufacturer and type as shown on the original part.

⚠ Warning!

Do not overload the tires by exceeding the specified load limit as indicated on the Tire and Loading Information placard on the driver’s door B-pillar. Overloading the tires can overheat them, possibly causing a blowout. Overloading the tires can also result in handling or steering problems, or brake failure.

Load index ⑤ is a numerical code associated with the maximum load a tire can support.

For example, a load rating of 91 corresponds to a maximum load of 1356 lb (615 kg) the tire is designed to support. See also “Maximum tire load” (▷ page 241) where the maximum load associated with the load index is indicated in kilograms and lbs.

For additional information on the load index, see “Load identification” (▷ page 248).

Speed symbol

Warning!

Even when permitted by law, never operate a vehicle at speeds greater than the maximum speed rating of the tires.

Exceeding the maximum speed for which tires are rated can lead to sudden tire failure, causing loss of vehicle control and possibly resulting in an accident and/or serious personal injury and possible death, for you and for others.



Regardless of the tire speed rating, local speed limits should be obeyed. Use prudent driving speeds appropriate to prevailing conditions.

Speed symbol  indicates the approved maximum speed (tire speed rating) for the tire.

Summer tires

Index	Speed rating
Q	up to 100 mph (160 km/h)
R	up to 106 mph (170 km/h)
S	up to 112 mph (180 km/h)
T	up to 118 mph (190 km/h)
H	up to 130 mph (210 km/h)
V	up to 149 mph (240 km/h)
W	up to 168 mph (270 km/h)
Y	up to 186 mph (300 km/h)
ZR...Y	up to 186 mph (300 km/h)

Index	Speed rating
ZR...(..Y)	above 186 mph (300 km/h)
ZR	above 149 mph (240 km/h)

- At the tire manufacturer's option, any tire with a speed capability above 149 mph (240 km/h) can include a “ZR” in the size designation (for example: 245/40 ZR18). To determine the maximum speed capability of the tire, the service description for the tire must be referred to. The service description is comprised of load index  and speed symbol .

If your tire includes “ZR” in the size designation and no service description is given, the tire manufacturer must be consulted for the maximum speed capability.

If a service description is given, the speed capability is limited by the speed symbol in the service description. Example: 245/40 ZR18 97Y. In this example, “97Y” is the service description. The letter “Y” designates the speed rating and the speed capability of the tire is limited to 186 mph (300 km/h).

- Any tire with a speed capability above 186 mph (300 km/h) must include a “ZR” in the size designation AND the service description must be placed in parenthesis. Example: 275/40 ZR 18 (99Y). The “(Y)” speed symbol in parenthesis designates the maximum speed capability of the tire as being above 186 mph (300 km/h). Consult the tire manufacturer for the actual maximum permissible speed of the tire.

All-season and winter tires

Index	Speed rating
Q M+S ¹⁴	up to 100 mph (160 km/h)
T M+S ¹⁴	up to 118 mph (190 km/h)

Index	Speed rating
H M+S ¹⁴	up to 130 mph (210 km/h)
V M+S ¹⁴	up to 149 mph (240 km/h)

i Not all M+S rated tires provide special winter performance. Make sure the tires you use show M+S and the mountain/snowflake  marking on the tire sidewall. These tires meet specific snow traction performance requirements of the Rubber Manufacturers Association (RMA) and the Rubber Association of Canada (RAC) and have been designed specifically for use in snow conditions.

An electronic speed limiter prevents your vehicle from exceeding a speed of:

- All models except AMG vehicles: 130 mph (210 km/h)
- E 63 AMG: 155 mph (250 km/h)
- E 63 AMG (Performance Package): 186 mph (300 km/h)

The factory equipped tires on your vehicle may have a tire speed rating above the maximum speed permitted by the electronic speed limiter.

Make sure your tires have the required tire speed rating as specified for your vehicle in the “Technical data” section (▷ page 353), for example when purchasing new tires.

If you are uncertain about the correct reading of the information given on a tire’s sidewall, any authorized Mercedes-Benz Center will be glad to assist you.

Load identification



i For illustration purposes only. Actual data on tires are specific to each vehicle and may vary from data shown in above illustration.

In addition to the load index, special load identification **1** may be molded into the tire sidewall following the letter designating the speed symbol **Ⓢ** (▷ page 246).

- No specification given: absence of any text (like in above example) indicates a standard load (SL) tire.
- XL or Extra Load: designates an extra load (or reinforced) tire.
- Light Load: designates a light load tire.
- C, D, E: designates load range associated with the maximum load a tire can carry at a specified pressure.

DOT, Tire Identification Number (TIN)

U.S. tire regulations require each new tire manufacturer or tire retreader to mold a TIN into or onto a sidewall of each tire produced.



The TIN is a unique identifier. The TIN facilitates efforts by tire manufacturers to notify purchasers in recall situations or other safety matters concerning tires. It gives purchasers the means to easily identify such tires.

The TIN is comprised of “Manufacturer’s identification mark” ②, “Tire size” ③, “Tire type code” ④ and “Date of manufacture” ⑤.

- i** For illustration purposes only. Actual data on tires are specific to each vehicle and may vary from data shown in above illustration.

DOT (Department of Transportation)

Tire branding symbol ① denotes that the tire meets requirements of the U.S. Department of Transportation.

Manufacturer’s identification mark

Manufacturer’s identification mark ② denotes the tire manufacturer.

New tires have a mark with two symbols.

Retreaded tires have a mark with four symbols. For more information on retreaded tires, see (▷ page 228).

Tire size

Code ③ indicates the tire size.

Tire type code

Tire type code ④ may, at the option of the manufacturer, be used as a descriptive code for identifying significant characteristics of the tire.

Date of manufacture

The date of manufacture ⑤ identifies the week and year of manufacture.

The first two figures identify the week, starting with “01” to represent the first full week of the calendar year. The second two figures represent the year.

For example, “3208” represents the 32nd week of 2008.

Tire ply material

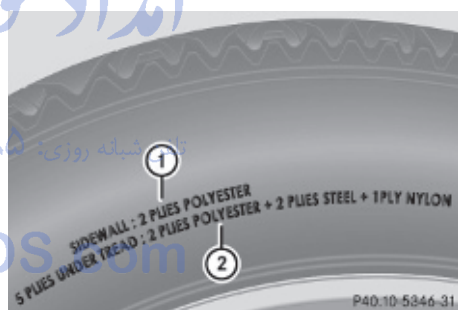

- i** For illustration purposes only. Actual data on tires are specific to each vehicle and may vary from data shown in above illustration.

This marking tells you about the type of cord and number of plies in the sidewall ① and under the tread ②.

Tire and loading terminology

Accessory weight

The combined weight (in excess of those standard items which may be replaced) of automatic transmission, power steering, power brakes, power windows, power seats,

radio, and heater, to the extent that these items are available as factory-installed equipment (whether installed or not).

Air pressure

The amount of air inside the tire pressing outward on each square inch of the tire. Air pressure is expressed in pounds per square inch (psi), kilopascal (kPa), or bar.

Aspect ratio

Dimensional relationship between tire section height and section width expressed in percentage.

Bar

Metric unit for air pressure. There are 14.5038 pounds per square inch (psi) to 1 bar; there are 100 kilopascals (kPa) to 1 bar.

Bead

The tire bead contains steel wires wrapped by steel cords that hold the tire onto the rim.

Cold tire inflation pressure

Tire inflation pressure when your vehicle has been sitting for at least 3 hours or driven no more than 1 mile (1.6 km).

Curb weight

The weight of a motor vehicle with standard equipment including the maximum capacity of fuel, oil, and coolant, and, if so equipped, air conditioning and additional optional equipment, but without passengers and cargo.

DOT (Department of Transportation)

A tire branding symbol which denotes the tire meets requirements of the U.S. Department of Transportation.

GAWR (Gross Axle Weight Rating)

The GAWR is the maximum permissible axle weight. The gross vehicle weight on each axle must never exceed the GAWR for the front and rear axle indicated on the certification label located on the driver's door B-pillar.

GVW (Gross Vehicle Weight)

The GVW comprises the weight of the vehicle including fuel, tools, spare wheel, installed accessories, passengers and cargo and, if applicable, trailer tongue load. The GVW must never exceed the GVWR indicated on the certification label located on the driver's door B-pillar.

GVWR (Gross Vehicle Weight Rating)

This is the maximum permissible vehicle weight of the fully loaded vehicle (weight of the vehicle including all options, passengers, fuel, and cargo and, if applicable, trailer tongue load). It is indicated on the certification label located on the driver's door B-pillar.

Kilopascal (kPa)

Metric unit for air pressure. There are 6.9 kPa to 1 psi; another metric unit for air pressure is bar. There are 100 kilopascals (kPa) to 1 bar.

Load index

Numerical code associated with the maximum load a tire can support.

Maximum load rating

The maximum load in kilograms and pounds that can be carried by the tire.

Maximum loaded vehicle weight

The sum of curb weight, accessory weight, total load limit, and production options weight.

Maximum permissible tire inflation pressure

This number is the greatest amount of air pressure that should ever be put in the tire.

Normal occupant weight

The number of occupants the vehicle is designed to seat, multiplied by 68 kilograms (150 lb).

Occupant distribution

The distribution of occupants in a vehicle at their designated seating positions.

Production options weight

The combined weight of those installed regular production options weighing over 5 lbs (2.3 kilograms) in excess of those standard items which they replace, not previously considered in curb weight or accessory weight, including heavy duty brakes, ride levelers, roof rack, heavy duty battery, and special trim.

PSI (Pounds per square inch)

A standard unit of measure for air pressure.

Recommended tire inflation pressure

The recommended tire inflation pressure for normal driving conditions is listed on the Tire and Loading Information placard located on the driver's door B-pillar. It provides best handling, tread life and riding comfort. Supplemental information pertaining to special driving situations can be found on the tire inflation pressure label on the inside of the fuel filler flap.

Rim

A metal support for a tire or a tire and tube assembly upon which the tire beads are seated.

Sidewall

The portion of a tire between the tread and the bead.

TIN (Tire Identification Number)

Unique identifier which facilitates efforts by tire manufacturers to notify purchasers in recall situations or other safety matters concerning tires and gives purchasers the means to easily identify such tires. The TIN is comprised of "Manufacturer's identification mark", "Tire size", "Tire type code" and "Date of manufacture".

Tire ply composition and material used

This indicates the number of plies or the number of layers of rubber-coated fabric in the tire tread and sidewall. Tire manufacturers also must indicate the ply materials in the tire and sidewall, which include steel, nylon, polyester, and others.

Tire speed rating

Part of tire designation (speed symbol); indicates the speed range for which a tire is approved.

Total load limit

Rated cargo and luggage load plus 68 kilograms (150 lb) times the vehicle's designated seating capacity.

Traction

The adhesive friction of a tire on a surface on which it moves. The amount of grip provided.

Tread

The portion of a tire that comes into contact with the road.

Treadwear indicators

Narrow bands, sometimes called “wear bars” that show across the tread of a tire when only $\frac{1}{16}$ in (1.6 mm) of tread remains.

Uniform Tire Quality Grading Standards

A tire information system that provides consumers with ratings for a tire’s traction, temperature and treadwear. Ratings are determined by tire manufacturers using U.S. government testing procedures. The ratings are molded into the sidewall of the tire.

Vehicle maximum load on the tire

Load on an individual tire that is determined by distributing to each axle its share of the maximum loaded vehicle weight and dividing it by two.

Winter driving

General information

Have your vehicle winterized at an authorized Mercedes-Benz Center.

Vehicles with diesel engine:

Do not cover the radiator, for example with a winter front. Otherwise the readings of the on-board diagnostic system may be inaccurate. Some of these readings are required by law and must be accurate at all times.

Winter tires

Warning!

Winter tires with a tread depth of less than $\frac{1}{8}$ in (4 mm) must be replaced. They are no longer suitable for winter operation.

Warning!

If you use your spare wheel when winter tires are fitted on the other wheels, be aware that

the difference in tire characteristics may very well impair turning stability and that overall driving stability may be reduced. Adapt your driving style accordingly.

Have the spare wheel replaced by a regular road wheel with a winter tire at the nearest authorized Mercedes-Benz Center.

Always use winter tires at temperatures below 45°F (7°C) and whenever wintry road conditions prevail. Not all M+S rated tires provide special winter performance. Make sure the tires you use show the mountain/snowflake  marking on the tire sidewall. These tires meet specific snow traction performance requirements of the Rubber Manufacturers Association (RMA) and the Rubber Association of Canada (RAC) and have been designed specifically for use in snow conditions. Use of winter tires is the only way to achieve the maximum effectiveness of your vehicle’s driving safety systems such as the ABS and the ESC in winter operation.

For safe handling, make sure all mounted winter tires are of the same make and have the same tread design.

For information on winter tires for your vehicle model, see the “Technical data” section (▷ page 353).

Always observe the speed rating of the winter tires installed on your vehicle.

After installing winter tires:

- ▶ Check the tire inflation pressure and adjust it if necessary (▷ page 231).
- ▶ Restart the tire pressure loss warning system (▷ page 232) or the Advanced Tire Pressure Monitoring System (▷ page 233).

Snow chains

Vehicles with AIRMAITC:

When driving with snow chains, always select the raised level of the vehicle level

control. Other settings may result in damage to your vehicle.

- ❗ Some tire sizes do not leave adequate clearance for snow chains. To help avoid serious damage to your vehicle or tires, make sure the use of snow chains is permissible as specified in the “Technical data” section of this Operator’s Manual.

Snow chains should only be driven on snow-covered roads at speeds not to exceed 30 mph (50 km/h). Remove chains as soon as possible when driving on roads without snow.

Observe the following guidelines when using snow chains:

- Use of snow chains is not permissible with all wheel/tire combinations (▷ page 353).
- Use snow chains in pairs and on rear wheels only. Follow the manufacturer’s mounting instructions.

- ❗ If snow chains are mounted to the front wheels, they may scrape against the body or axle components. The tires or the vehicle could be damaged as a result.

- Only use snow chains that are approved by Mercedes-Benz. Any authorized Mercedes-Benz Center will be glad to advise you on this subject.
- Use of snow chains may be prohibited depending on location. Always check local and state laws before installing snow chains.
- Do not use snow chains on the spare wheel.

- ❗ When driving with snow chains, you may wish to switch off the ESC (▷ page 66) before setting the vehicle in motion. This will improve the vehicle’s traction.

Winter driving instructions

⚠ Warning!

If the vehicle becomes stuck in snow, make sure snow is kept clear of the exhaust pipe and from around the vehicle with the engine running. Otherwise, deadly carbon monoxide (CO) gases may enter vehicle interior resulting in unconsciousness and death.

To assure sufficient fresh air ventilation, open a window slightly on the side of the vehicle not facing the wind.

⚠ Warning!

The outside temperature indicator is not designed to serve as an ice-warning device and is therefore unsuitable for that purpose. Indicated temperatures just above the freezing point do not guarantee that the road surface is free of ice. The road may still be icy, especially in wooded areas or on bridges.

⚠ Warning!

On slippery road surfaces, never downshift in order to obtain braking action. This could result in drive wheel slip and reduced vehicle control. Your vehicle’s ABS will not prevent this type of loss of control.

The most important rule for slippery or icy roads is to drive sensibly and to avoid abrupt acceleration, braking and steering maneuvers. Do not use the cruise control or DISTRONIC PLUS system under such conditions.

When the vehicle is in danger of skidding, shift the automatic transmission to neutral position **N**. Try to keep the vehicle under control by corrective steering action.

- ❗ For information on driving with snow chains, see “Snow chains” (▷ page 252).

Road salts and chemicals can adversely affect braking efficiency. Increased pedal force may become necessary to produce the normal brake effect.

Depressing the brake pedal periodically when traveling at length on salt-strewn roads can bring road-salt-impaired braking efficiency back to normal.

If the vehicle is parked after being driven on salt-treated roads, the braking efficiency should be tested as soon as possible after driving is resumed.

Warning!

Make sure not to endanger any other road users when carrying out these braking maneuvers.

Driving instructions

Drive sensibly – save fuel

To save fuel you should:

- Keep tires at the recommended inflation pressures.
- Remove unnecessary loads.
- Remove roof rack when not in use.
- Allow engine to warm up under low load use.
- Avoid frequent acceleration and deceleration.
- Have all maintenance work performed at the intervals specified in the Maintenance Booklet and as required by the Maintenance system. Contact an authorized Mercedes-Benz Center.

Fuel consumption is also increased by driving in cold weather, in stop-and-go traffic, on short trips and in mountainous areas.

Drinking and driving

Warning!

Drinking and driving and/or taking drugs and driving are very dangerous combinations. Even a small amount of alcohol or drugs can affect your reflexes, perceptions and judgment.

The possibility of a serious or even fatal accident are greatly increased when you drink or take drugs and drive.

Do not drink or take drugs and drive or allow anyone to drive who has been drinking or taking drugs.

Pedals

Warning!

Make sure absolutely no objects are obstructing the pedals' range of movement. Keep the driver's footwell clear of all obstacles. If there are any floor mats or carpets in the footwell, make sure that the pedals still have sufficient clearance.

During sudden driving or braking maneuvers, the objects could get caught between the pedals. You could then no longer brake or accelerate. This could lead to accidents and injury.

Power assistance

Warning!

There is no power assistance for the steering and the brake when the engine is not running. Steering and braking requires significantly more effort and you could lose control of the vehicle and cause an accident as a result. Do not turn off the engine while the vehicle is in motion.

Brakes

Downhill grades

- When driving down long and steep grades, relieve the load on the brakes by shifting into a lower gear to use the engine's braking power. This helps prevent overheating of the brakes and reduces wear.

When using the engine's braking power, a drive wheel may not spin for an extended period of time, e.g. on slippery road surfaces. This may cause serious damage to the drivetrain which is not covered by the Mercedes-Benz Limited Warranty.

Continuous or hard braking

Warning!

Resting your foot on the brake pedal will cause excessive and premature wear of the brake pads.

It can also result in the brakes overheating, thereby significantly reducing their effectiveness. It may not be possible to stop the vehicle in sufficient time to avoid an accident.

After hard braking, it is advisable to drive on for some time, rather than immediately park, so that the air stream will cool down the brakes faster.

Wet roads

Warning!

After driving in heavy rain for some time without applying the brakes or through water deep enough to wet brake components, the first braking action may be somewhat reduced and increased pedal pressure may be necessary to obtain expected brake effect. Maintain a safe distance from vehicles in front.

To help prevent brake disk corrosion after driving on wet or salt-covered roads, it is advisable to brake the vehicle with considerable force prior to parking. The heat generated serves to dry the brakes.

Salt-covered roads

Warning!

A layer of salt on the brake discs and the brake linings may cause a delay in the braking effect, resulting in a significantly increased

braking distance, which could lead to an accident.

To avoid this danger, you should:

- occasionally brake carefully when you are driving on salt-covered roads, so that any layer of salt that may have built up on the brake discs and the brake linings is removed without putting other road users at risk
- maintain a greater distance to the vehicle ahead and drive with particular care
- carefully apply the brakes at the end of a trip and immediately after commencing a new trip, so that salt residues are removed from the brake disc

Brake service

 The brake fluid level in the reservoir may be too low if the red brake warning lamp in the instrument cluster comes on while the engine is running and an acoustic warning sounds. Observe additional messages in the multifunction display that may appear.

Brake pad wear or a leak in the system may be the reason for low brake fluid in the reservoir.

Have the brake system inspected immediately. Contact an authorized Mercedes-Benz Center.

All checks and service work on the brake system should be carried out by qualified technicians only. Contact an authorized Mercedes-Benz Center.

Only install brake pads and use brake fluid recommended by Mercedes-Benz.

Warning!

If other than recommended brake pads are installed, or other than recommended brake fluid is used, the braking properties of the vehicle can be degraded to an extent that safe braking is substantially impaired. This could result in an accident.

! Vehicles with 4MATIC:

Only conduct operational or performance tests on a two-axle dynamometer. If such tests are necessary, contact an authorized Mercedes-Benz Center. You could otherwise seriously damage the brake system or the transfer case which is not covered by the Mercedes-Benz Limited Warranty.

! Vehicles with 4MATIC:

Because the ESC operates automatically, the engine and ignition must be shut off (SmartKey in starter switch position **0** or **1** or KEYLESS-GO start/stop button in position **0** or **1**) when the electronic parking brake is being tested on a brake test dynamometer.

Active braking action through the ESC may otherwise seriously damage the brake system which is not covered by the Mercedes-Benz Limited Warranty.

! Vehicles without 4MATIC:

Because the ESC operates automatically, the engine and ignition must be shut off (SmartKey in starter switch position **0** or **1** or KEYLESS-GO start/stop button in position **0** or **1**) when the electronic parking brake is being tested on a brake test dynamometer or when the vehicle is being towed with one axle raised.

Active braking action through the ESC may otherwise seriously damage the brake system which is not covered by the Mercedes-Benz Limited Warranty.

If your brake system is only subjected to moderate loads, you should occasionally test the effectiveness of the brakes by applying above-normal braking pressure at higher speeds. This will also enhance the grip of the brake pads.

⚠ Warning!

Make sure not to endanger any other road users when carrying out these braking maneuvers.

Refer to the description of the Brake Assist System (BAS) (▷ page 63) or BAS PLUS (▷ page 63).

High-performance brake system and ceramic brake system

The high-performance brake system and ceramic brake system is only available on E 63 AMG.

⚠ Warning!

New vehicle brake pads and disks, and replacement brake pads and disks may take several hundred miles of driving until they provide optimum braking efficiency. Until that time, you may need to use increased brake pedal pressure while braking. Please be aware of this and adjust your driving and braking accordingly during this break-in period.

Excessive high-demand braking will cause correspondingly high brake wear. Please be attentive to the brake warning lamp in the instrument cluster and brake condition messages in the multifunction display. Especially for high performance driving, it is important to maintain and have the brake system checked regularly.

The high-performance brake system is designed to operate under the extremely high operating demands required to accommodate the performance capabilities of the vehicle.

The brakes may produce a squeaking-type noise depending on the

- vehicle speed
- brake force applied
- ambient conditions, e.g. temperature and humidity

As with any brake system, the wear of individual brake system components such as brake pads or disks strongly depends on your driving style and the conditions under which you operate the vehicle. Thus, a driving style calling for high-demand braking will cause your vehicle's brakes to wear more quickly.

Driving off

Warm up the engine smoothly. Do not place full load on the engine until the operating temperature has been reached.

! When driving off on a slippery surface, do not allow a drive wheel to spin for an extended period with the ESC switched off. Doing so may cause serious damage to the drivetrain which is not covered by the Mercedes-Benz Limited Warranty.

! Simultaneously depressing the accelerator pedal and applying the brakes reduces engine performance and causes premature brake and drivetrain wear which is not covered by the Mercedes-Benz Limited Warranty.

Hydroplaning

Depending on the depth of the water layer on the road, hydroplaning may occur, even at low speeds and with new tires. In heavy rain or when conditions indicate possible hydroplaning:

- ▶ Reduce vehicle speed.
- ▶ Avoid track grooves in the road.
- ▶ Apply brakes cautiously.

Standing water

! Do not drive through flooded areas. Before driving through water, determine its depth.

If you must drive through standing water, drive slowly to prevent water from entering the passenger compartment or the engine compartment. Water in these areas could cause damage to electrical components or wiring of the engine or transmission, or could result in water being ingested by the engine through the air intake causing severe internal engine damage. Any such

damage is not covered by the Mercedes-Benz Limited Warranty.

Driving abroad

If you plan to drive the vehicle outside the U.S. or Canada, you should request dealer network information for your destination from any authorized Mercedes-Benz Center.

Control and operation of radio transmitters

Safety notes

Warning!

Please do not forget that your primary responsibility is to drive the vehicle. A driver's attention to the road must always be his/her primary focus when driving. For your safety and the safety of others, we recommend that you pull over to a safe location and stop before placing or taking a telephone call.

If you choose to use the telephone¹⁵ while driving, please use the hands-free device and only use the telephone when road, weather and traffic conditions permit. Some jurisdictions prohibit the driver from using a mobile telephone while driving a vehicle.

Only operate the audio system or COMAND¹⁵ (Cockpit Management and Data System) if road, weather and traffic conditions permit. Otherwise, you may not be able to observe traffic conditions and could endanger yourself and others.

Bear in mind that at a speed of just 30 mph (approximately 50 km/h), your vehicle is covering a distance of 44 feet (approximately 14 m) every second.

¹⁵ Observe all legal requirements.

Emission control

Certain systems of the engine serve to keep the toxic components of the exhaust gases within permissible limits required by law.

These systems will function properly only when maintained strictly according to factory specifications. Any adjustments on the engine should, therefore, be carried out only by qualified Mercedes-Benz Center authorized technicians.

Engine adjustments should not be altered in any way. Moreover, the specified service procedures must be carried out regularly according to Mercedes-Benz servicing requirements. For details refer to the Maintenance Booklet.

Warning!

Inhalation of exhaust gas is hazardous to your health. All exhaust gas contains carbon monoxide (CO), and inhaling it can cause unconsciousness and possible death.

Do not run the engine in confined areas (such as a garage) which are not properly ventilated. If you think that exhaust gas fumes are entering the vehicle while driving, have the cause determined and corrected immediately. If you must drive under these conditions, drive only with at least one window fully open at all times.

Maintenance

Notes

The Maintenance System in your vehicle tracks the distance driven and the time elapsed since the last maintenance service. It calculates other maintenance service work required, and calls for the next maintenance service accordingly.

We strongly recommend that you have your vehicle serviced at an authorized Mercedes-Benz Center. Have it serviced in accordance with the Maintenance Booklet at the times

called for by the maintenance service indicator.

i Failure to have the vehicle maintained in accordance with the Maintenance Booklet and maintenance service indicator at the designated times/mileage will result in vehicle damage not covered by the Mercedes-Benz Limited Warranty.

Maintenance service indicator message

Information on maintenance work and maintenance intervals are specified in the Maintenance Booklet. Contact an authorized Mercedes-Benz Center, or visit www.mbusa.com (USA only) for additional information.

The maintenance service indicator message will notify you when the next maintenance service is required.

Starting approximately 1 month before the next maintenance service is required, one of the following messages will appear in the multifunction display. The messages will appear while you are driving or when you switch on the ignition (example service A):

Next Service A in XXXX miles (km)
Next Service A in XX days
Service A Due

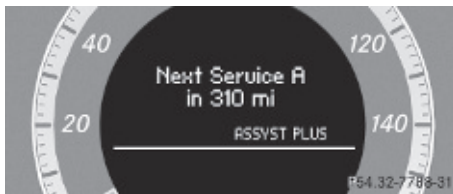



An additional number or a further letter in combination with the maintenance type can be indicated. This indicates that further auxiliary maintenance work is required. Contact an authorized Mercedes-Benz Center for more information.

Clearing the maintenance service indicator message

The maintenance service indicator message is cleared automatically

- after approximately 10 seconds when you switch on the ignition
- after approximately 10 seconds when reaching the service threshold while driving
- after approximately 30 seconds, once the suggested maintenance service term has passed

- ▶ **Clearing the maintenance service indicator message manually:** Press button  or button  on the multifunction steering wheel. The standard display appears in the multifunction display.

Maintenance service term exceeded

If you have exceeded the suggested maintenance service term, you will see the following message in the multifunction display:

Service A Exceeded by XXXXX miles (km)

Service A Exceeded by XXX days





In addition, a signal sounds when the message appears.

Any authorized Mercedes-Benz Center will reset the maintenance service indicator following a completed maintenance service.

Calling up the maintenance service indicator display

- ❗ The menu overview can be found on (▷ page 129).

You can call up the maintenance service indicator display at any time to check when the next maintenance service is required.

- ▶ Switch on the ignition. The standard display of the control system appears (▷ page 129).
- ▶ Press button  or  on the multifunction steering wheel to select the Serv. menu.
- ▶ Press button  or  to select ASSYST PLUS.
- ▶ Press button  on the multifunction steering wheel to confirm. The maintenance service indicator display with the maintenance service deadline appears in the multifunction display.

- ❗ If the battery was disconnected, the days of disconnection will not be included in the count shown by the maintenance service indicator. To arrive at the true maintenance service deadline, you will need to subtract these days from the days shown in the maintenance service indicator message or maintenance service indicator display.

Resetting the maintenance service indicator

In the event that the maintenance service on your vehicle is not carried out at an authorized Mercedes-Benz Center, you can have the maintenance service indicator reset.

The automotive maintenance facility carrying out the maintenance service will find the information for resetting the maintenance service indicator in the maintenance-relevant literature for your vehicle.

Such literature is available at any authorized Mercedes-Benz Center or directly from Mercedes-Benz.

- ❗ If the maintenance service indicator was reset inadvertently, have an authorized Mercedes-Benz Center correct it.

Only reset the maintenance service indicator if the proper maintenance service has been performed. Not following the proper maintenance service as described in the Maintenance Booklet will result in

engine damage and/or other vehicle damage not covered by the Mercedes-Benz Limited Warranty.

Vehicle care

Cleaning and care of the vehicle

Notes

Regular and proper care will help to maintain the value of your vehicle.

Warning!

Many cleaning products can be hazardous. Some are poisonous, others are flammable. Always follow the instructions on the particular container. Always open your vehicle's doors or windows when cleaning the inside.

Never use fluids or solvents that are not designed for cleaning your vehicle.

Always lock away cleaning products and keep them out of reach of children.

! When cleaning the vehicle, do not use scouring agents. Never apply strong force and only use a soft, wet cloth or sponge. Otherwise you may scratch or damage the surface to be cleaned.

While in operation, even while parked, your vehicle is subjected to varying external influences which, if gone unchecked, can attack the paintwork as well as the vehicle underbody and cause lasting damage.

Such damage is caused not only by extreme and varying climatic conditions, but also by:

- Air pollution
- Road salt
- Tar
- Gravel and stone chipping

To avoid paint damage, you should immediately remove:

- Grease and oil
- Fuel
- Coolant
- Brake fluid
- Bird droppings
- Insects
- Tree resins etc.

Frequent washing reduces and/or eliminates the aggressiveness and potency of the above adverse influences.

More frequent washings are necessary to deal with unfavorable conditions:

- near the ocean
- in industrial areas (smoke, exhaust emissions)
- during winter operation

You should check your vehicle from time to time for stone chipping or other damage. Any damage should be repaired as soon as possible to prevent corrosion.

In doing so, do not neglect the underbody of the vehicle. A prerequisite for a thorough check is a washing of the underbody followed by a thorough inspection. Damaged areas need to be re-undercoated.

Your vehicle has been treated at the factory with a wax-base rustproofing in the body cavities which will last for the lifetime of the vehicle. Post-production treatment is neither necessary nor recommended by Mercedes-Benz because of the possibility of incompatibility between materials used in the production process and others applied later.

We have selected vehicle-care products and compiled recommendations which are specially matched to our vehicles and which always reflect the latest technology. You can obtain Mercedes-Benz approved vehicle-care products at an authorized Mercedes-Benz Center.

Scratches, corrosive deposits, corrosion or damage due to negligent or incorrect care cannot always be removed or repaired with the vehicle-care products recommended here. In such cases it is best to seek aid at an authorized Mercedes-Benz Center.

The following topics deal with the cleaning and care of your vehicle and give important “how-to” information as well as references to Mercedes-Benz approved vehicle-care products.

Power washer

! Follow the instructions provided by the power washer manufacturer on maintaining a distance between the vehicle and the nozzle of the power washer.

Never use a round nozzle to power-wash tires. The intense jet of water can result in damage to the tire.

Always replace a damaged tire.

Always keep the jet of water moving across the surface. Do not aim directly at electrical parts, electrical connectors, seals, or other rubber parts.

i Vehicles with KEYLESS-GO:
If a door handle is hit by a strong jet of water, and a SmartKey is within approximately 3 ft (1 m) of the vehicle, it could be inadvertently locked or unlocked.

Tar stains

Quickly remove tar stains before they dry and become more difficult to remove. A tar remover is recommended.

Paintwork, painted body components

! Affixing stickers, magnets, adhesive tape or similar materials to painted body components may damage the paintwork.

Mercedes-Benz approved Paint Care should be applied when water drops on the paint surface do not “bead up”. This should

normally be done every 3 to 5 months, depending on the climate and washing detergent used.

Mercedes-Benz approved Paint Cleaner should be applied if the paint surface shows signs of embedded dirt (i.e. loss of gloss).

Do not apply any of these products or wax if your vehicle is parked in the sun or if the hood is still hot.

► Use the appropriate MB-Touch-Up Stick for quick and provisional repairs of minor paint damage (i.e. chips from stones, vehicle doors, etc.).

Engine cleaning

Prior to cleaning the engine compartment, make sure to protect electrical components and connectors from contact with water and cleaning agents.

Corrosion protection, such as MB Anticorrosion Wax should be applied to the engine compartment after every engine cleaning. Before applying, all control linkage bushings and joints should be lubricated. The poly-V-belt and all pulleys should be protected from any wax.

Vehicle washing

In the winter, thoroughly remove all traces of road salt as soon as possible.

When washing the vehicle underbody, do not forget to clean the inner sides of the wheels.

i Vehicles with KEYLESS-GO:
If a door handle is hit by a strong jet of water, and a SmartKey is within approximately 3 ft (1 m) of the vehicle, it could be inadvertently locked or unlocked.

Hand-wash

► Do not use hot water or wash your vehicle in direct sunlight.

► Only use a soft, wet cloth or sponge to clean the vehicle.

- ▶ Only use a mild vehicle wash detergent, such as Mercedes-Benz approved Car Shampoo.
- ▶ Thoroughly spray the vehicle with a diffused jet of water.
- ▶ Do not spray directly towards the ventilation intake.
- ▶ Use plenty of water and rinse the sponge and chamois frequently.
- ▶ Rinse with clean water and dry with a chamois thoroughly.
Do not allow cleaning agents to dry on the finish.

Automatic car wash

Warning!

The vehicle is braked when the HOLD function or DISTRONIC PLUS is activated. Therefore, deactivate the HOLD function or DISTRONIC PLUS before the vehicle is washed in an automatic car wash.

You can have your vehicle washed in an automatic car wash from the start. Brushless car washes are preferable.

- ▶ To protect the filter system, activate the air recirculation mode using button  on the climate control panel.
- ❗ Do not clean your vehicle in an automatic touchless car wash which uses caustic spray. Caustic spray will damage the paint or ornamental moldings.

If the vehicle is very dirty, prewash it before running it through the automatic car wash.

- ❗ Make sure the combination switch is set to wiper setting . Otherwise, the rain sensor could activate and cause the wipers to move unintentionally. This may lead to vehicle damage.
Due to the width of the vehicle, fold in exterior rear view mirrors prior to running the vehicle through an automatic car wash to prevent damage to the mirrors.

- ▶ **When taking the vehicle through an automatic conveyor-type car wash:** Make sure the automatic transmission remains in neutral position **N**. Observe instructions, see “Remaining in neutral position **N**” (▷ page 117).

When leaving the automatic car wash, make sure the mirrors are folded out.

After running the vehicle through an automatic car wash, wipe any wax off of the windshield and the wiper blade inserts. This will prevent smears and reduce wiping noise which can be caused by residual wax on the windshield.

Ornamental moldings

- ▶ For regular cleaning and care of ornamental moldings, use a damp cloth.

❗ Do not use chrome cleaner on ornamental moldings. Although ornamental moldings may have chrome appearance, they could be made of anodized aluminum that will be damaged when cleaned with chrome cleaner. Instead, use a damp cloth to clean those ornamental moldings.

For very dirty ornamental moldings of which you are sure are chrome-plated, use a chrome cleaner. If in doubt whether an ornamental molding is chrome-plated, contact an authorized Mercedes-Benz Center.

Headlamps, brake lamps, tail lamps, side markers, turn signal lenses

- ▶ Use a mild vehicle wash detergent, such as Mercedes-Benz approved Car Shampoo, with plenty of water.
- ❗ Only use window cleaning solutions that are suitable for plastic lamp lenses. Window cleaning solutions which are not suitable may damage the plastic lamp lenses of the headlamps. Therefore, do not use abrasives, solvents or cleaners that contain solvents.

Cleaning the driving systems sensors

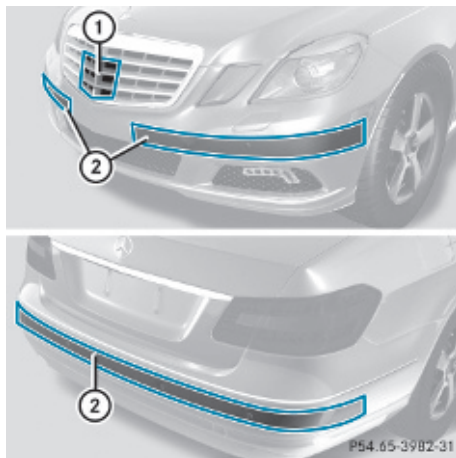

- ▶ Switch off the ignition.
- ▶ Clean DISTRONIC PLUS/PRE-SAFE® Brake system sensor cover ① by hand.

To clean DISTRONIC PLUS/PRE-SAFE® Brake system sensor cover ① and the bumper area near sensors ② observe the following:

- Use a mild vehicle wash detergent, such as Mercedes-Benz approved Car Shampoo, with plenty of water.
- Use a soft, non-scratching cloth.

! If you use a power washer to clean the sensor covers, observe the following:

- Follow the instructions provided by the power washer manufacturer.
- Maintain a distance between the sensor covers and the nozzle of the power washer.

Cleaning the rear view camera lens

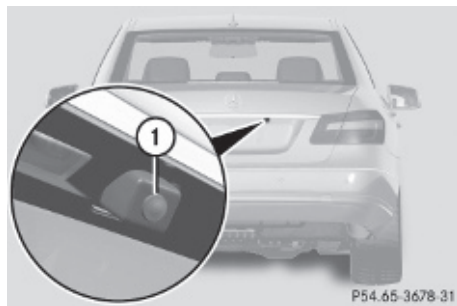

- ▶ Only use clean water and a soft, non-scratching cloth to clean rear view camera lens ①.

Be careful not to apply wax to rear view camera lens ① when waxing the vehicle. If necessary, remove the wax using the Mercedes-Benz approved Car Shampoo with plenty of water.

! Do not clean the camera and the area around the camera

- with a high-pressure cleaner
- with a dry cloth and strong pressure
- with aggressive cleaning agents

You could otherwise damage the camera.

Cleaning the windshield in front of the Night View Assist Plus camera

The Night View Assist Plus camera is located in front of the interior rear view mirror.

⚠ Warning!

Please do not forget that your primary responsibility is to drive the vehicle. A driver's attention to the road must always be his/her primary focus when driving. For your safety and the safety of others, stop before trying to remove window fogging or cleaning the window in front of the Night View Assist Plus camera.

Bear in mind that at a speed of just 30 mph (approximately 50 km/h), your vehicle is

covering a distance of 44 feet (approximately 14 m) every second.

- ❗ Do not clean the lens of the Night View Assist Plus camera. If the camera lens is dirty, please contact an authorized Mercedes-Benz Center.

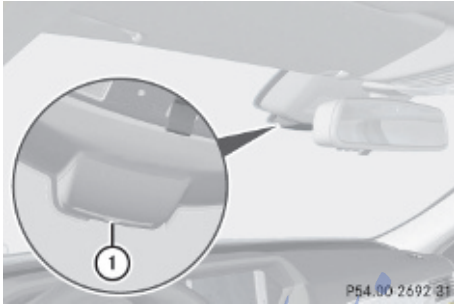

- ▶ Use recessed handle ① of camera cover to swing camera cover downward.



- ▶ Clean inside of windshield in front of camera ② with a soft, non-scratching cloth.
- ❗ If you use a windshield cleaning product, make sure that none of the cleaning product comes into contact with the lens of the Night View Assist Plus camera.
- ▶ Use recessed handle ① of camera cover to swing camera cover up.

Cleaning the windows and the wiper blades

- ❗ Never open the hood when the wiper arms are folded forward.

⚠ Warning!

For safety reasons, switch off wipers and remove SmartKey from starter switch before cleaning the windshield and/or the wiper blades. Vehicles with KEYLESS-GO: Make sure the vehicle's on-board electronics have status **0**. Otherwise, the wiper motor could suddenly turn on and cause injury.

- ❗ Do not pull on the wiper blade inserts. They could tear.
 - ▶ Fold the wiper arms forward until they snap into place.
 - ▶ Clean the windshield and the wiper blade inserts with a clean cloth and mild detergent solution.
 - ▶ Use a soft, clean cloth and a mild window cleaning solution on all outside and inside glass surfaces.
- An automotive glass cleaner is recommended.

- ❗ Fold the windshield wiper arms back onto the windshield before turning the SmartKey in the starter switch or pressing the KEYLESS-GO start/stop button.
- Hold on to the wiper when folding the wiper arm back. If released, the force of the impact from the tensioning spring could crack the windshield.

- ❗ To clean the window interior, do not use a dry cloth, abrasives, solvents or cleaners containing solvents. Do not touch the inside of the windows with hard objects such as an ice scraper or ring. Doing so may damage the windows.

Cleaning the panorama roof

The rear part of the tilt/sliding panel has a protective layer on the inside.

- ▶ Use a soft, clean cloth and a mild window cleaning solution.

An automotive glass cleaner is recommended.

- ❗ Do not use a dry cloth, abrasives, solvents or cleaners containing solvents. Do not touch the protective layer with hard objects such as an ice scraper or ring. Never apply strong force and only use a soft, non-scratching cloth when cleaning the rear part of the tilt/sliding panel.

Otherwise you may scratch or damage the protective layer.

Light alloy wheels

If possible, clean wheels once a week.

- ▶ Use Mercedes-Benz approved Wheel Care, a soft bristle brush and a strong spray of water for cleaning the light alloy wheels.

- ❗ Only use acid-free cleaning materials. Acid may cause corrosion or damage the clear coat.

- ❗ The vehicle should not be parked for an extended period of time immediately after it has been cleaned. This applies especially after the wheel rims have been cleaned with wheel rim cleaner. Wheel rim cleaners can lead to increased corrosion of the brake disks and brake pads. Non-approved wheel cleaners may also damage the wheel paint if the vehicle is not driven after cleaning.

Therefore, the vehicle's brake system should always be warmed-up before it is parked after cleaning. Drive your vehicle for several minutes to allow the brakes to dry. When applying Mercedes-Benz approved Tire Care and Mercedes-Benz approved Wheel Care products, take care not to spray them on the brake disks.

Plastic and rubber parts

- ▶ Use a gentle dishwashing detergent or mild detergent for delicate fabrics as a washing solution.
- ▶ Wipe with a cloth moistened in a lukewarm solution.
The surface may temporarily change color. If this is the case, wait for it to dry.

Warning!

Do not use cleaners or cockpit care sprays containing solvents to clean the cockpit or the steering wheel. Cleaners containing solvents will make the surface porous and vehicle occupants could suffer serious injuries from plastic parts coming loose in the event of air bag deployment.

- ❗ Do not use oil, wax or scouring agents.

Otherwise you may scratch or damage the surface.

Hard plastic trim items

- ▶ Use Mercedes-Benz approved Interior Care on a soft, lint-free cloth and apply with light pressure.

COMAND display

- ❗ You must switch off the COMAND display and allow it to cool prior to cleaning.

- ❗ Do not use any liquids or cleaning agents. These can damage or even destroy the COMAND display screen.

- ▶ Use a standard microfiber cloth and apply with light pressure.

Steering wheel and gear selector lever

- ▶ Wipe with a damp cloth and dry thoroughly or clean with Mercedes-Benz approved Leather Care.

Carpets

- ▶ Use Mercedes-Benz approved Carpet and Fabric Care for cleaning the carpets.

Headliner and shelf below rear window

- ▶ Use a soft bristle brush or a dry-shampoo cleaner in case of excessive dirt.

Seat belts

- ▶ Only use clear, lukewarm water and soap.

⚠ The seat belts must not be treated with chemical cleaning agents. Do not dry the seat belts at temperatures above 176°F (80°C) or in direct sunlight.

⚠ Warning!

Do not bleach or dye seat belts as this may severely weaken them. In a crash they may not be able to provide adequate protection.

Upholstery

Using aftermarket seat covers or wearing clothing that have the tendency to give off coloring (e.g. when wet, etc.) may cause the upholstery to become permanently discolored. By lining the seats with a proper intermediate cover, contact-discoloration will be prevented.

⚠ Warning!

Only use seat or head restraint covers which have been tested and approved by Mercedes-Benz for your vehicle model.

Using other seat or head restraint covers may interfere with or prevent

- deployment of the front side impact air bags
- deployment of the rear side impact air bags
- deployment of the pelvis air bags
- activation of the NECK-PRO active front head restraints

Contact an authorized Mercedes-Benz Center for availability.

Leather upholstery

Please note that leather upholstery is a natural product and is therefore subject to a natural aging process. Leather upholstery may also react to certain ambient influences such as high humidity or high temperature by showing wrinkles for example.

- ▶ Wipe leather upholstery with a damp cloth and dry thoroughly or clean with Mercedes-Benz approved Leather Care.

⚠ To avoid damage to leather upholstery:

- Wipe with light pressure only.
- Do not clean with abrasive cleaning agents such as scouring milk or powder.
- Do not soak the leather upholstery.
As leather is a natural product, it could otherwise harden or become porous.
- Exercise particular care when cleaning perforated leather as its underside should not become wet.

Wood trims

- ▶ Only use water and a damp cloth to clean wood trims in your vehicle.

⚠ Do not use solvents like tar remover or wheel cleaner nor polishes or waxes as these may be abrasive.

Chrome-plated exhaust tip

Regular cleaning and care of chrome-plated exhaust tips will help to maintain their shine and the classy appearance.

- ▶ Use Mercedes-Benz approved Chrome Polishing Paste each time the vehicle has been washed, especially during the winter.

⚠ Do not use alkaline cleaners such as wheel cleaners as they could cause corrosion.

Vehicle equipment	268
Where will I find ...?	268
Vehicle status messages in the multifunction display	272
What to do if	304
Unlocking/locking manually	314
Resetting activated NECK-PRO active front head restraints	316
Replacing SmartKey batteries	317
Replacing bulbs	318
Replacing wiper blades	322
Flat tire	323
Bleeding the fuel system (diesel engine only)	333
AdBlue® (diesel engine only)	333
Battery	336
Jump starting	338
Towing the vehicle	340
Fuses	343

ایراد خودرو فارما

تلفن شبانه روزی: ۰۸۵-۸۸۸۶۲۰۲۱

FarmaSOS.com



Vehicle equipment

- i** This Operator's Manual describes all features, standard or optional, potentially available for your vehicle at the time of purchase. Please be aware that your vehicle might not be equipped with all features described in this manual.

Where will I find ...?

First aid kit

- i** Check expiration dates and contents for completeness at least once a year and replace missing/expired items.

The first-aid kit is located in the trunk on the right-hand side behind the cover.

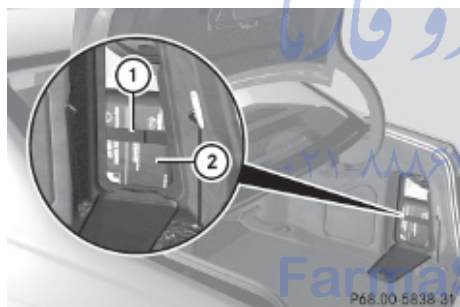

- ▶ Turn the lock clockwise and fold down the cover.
- ▶ Loosen tensioning strap ①. First aid kit ② can be removed.

Vehicle tool kit

The vehicle tool kit is located in the space underneath the trunk floor.

- i** Vehicles without spare wheel are not factory-equipped with the tools required for a wheel change such as a jack or a wheel

wrench. Some tools required for a wheel change are specific to your vehicle. Contact an authorized Mercedes-Benz Center to obtain the tools approved for your vehicle.

The vehicle tool kit includes:

- Collapsible wheel chock¹⁶
- Electric air pump^{17,18}
- Fuse chart
- Jack¹⁶
- Pair of gloves¹⁶
- Protective wrap¹⁷
- TIREFIT kit¹⁸
- Towing eye bolt
- Wheel wrench¹⁶

▶ Open the trunk (▶ page 81).

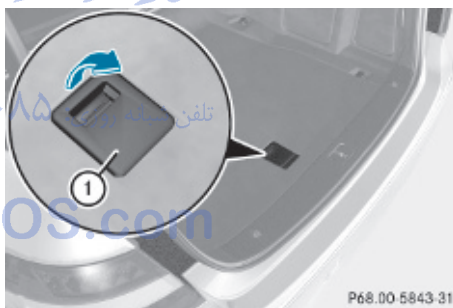

- ▶ Lift the trunk floor using floor handle ①.

¹⁶ Vehicles with spare wheel only.

¹⁷ E 63 AMG

¹⁸ E 350 BlueTEC (if so equipped)

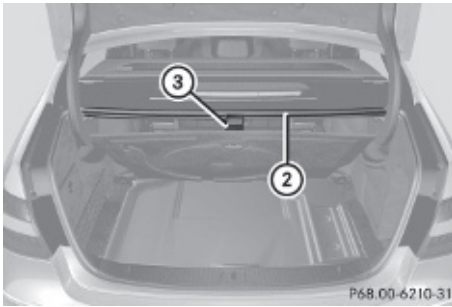

- ▶ Engage floor handle (3) on upper trunk lip (2).

Vehicles without spare wheel

i Vehicles without spare wheel are not factory-equipped with the tools required for a wheel change such as a jack or a wheel wrench. Some tools required for a wheel change are specific to your vehicle.

Contact an authorized Mercedes-Benz Center to obtain the tools approved for your vehicle. The illustration shows the vehicle retrofitted with the necessary tools for a wheel change.

i USA only: Vehicles with MOExtended system are not factory-equipped with a TIREFIT kit. When retrofitting with tires that do not have run-flat characteristics, you should also equip your vehicle with a TIREFIT kit. TIREFIT kits are available at any authorized Mercedes-Benz Center.

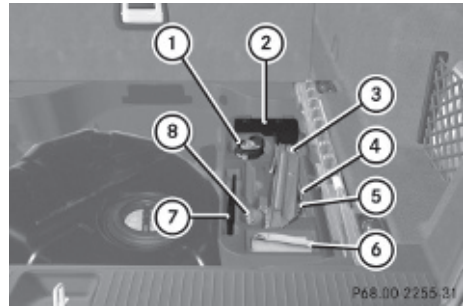

- E 350 BlueTEC
- ① TIREFIT kit
- ② Electric air pump
- ③ Jack
- ④ Towing eye bolt
- ⑤ Wheel wrench
- ⑥ Fuse chart
- ⑦ Collapsible wheel chock
- ⑧ Alignment bolt

Vehicles with spare wheel

All models except E 63 AMG

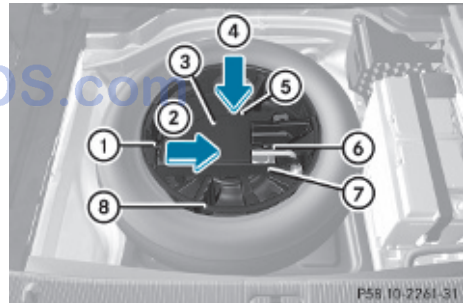

- ① Tab
- ② Removing vehicle tool kit box
- ③ Vehicle tool kit box cover
- ⑤ Opening vehicle tool kit box cover
- ⑥ Tab
- ⑦ Vehicle tool kit
- ⑧ Vehicle tool kit box
- ⑨ Luggage bowl

- ▶ **Removing vehicle tool kit box:** Pull tab ① in direction of arrow ② and lift vehicle tool kit box ⑧.
- ▶ Remove vehicle tool kit box ⑧ from luggage bowl ⑨.
- ▶ **Opening vehicle tool kit box cover:** Pull tab ⑥ in direction of arrow ⑤ and open vehicle tool kit box cover ③.
- ▶ **Closing vehicle tool kit box cover:** Push vehicle tool kit box cover ③ downward until it engages into vehicle tool kit box ⑧.
- ▶ **Installing vehicle tool kit box:** Slide vehicle tool kit box ⑧ into the recess of luggage bowl ⑨.
- ▶ Push vehicle tool kit box ⑧ downward until it engages into luggage bowl ⑨.

E 63 AMG

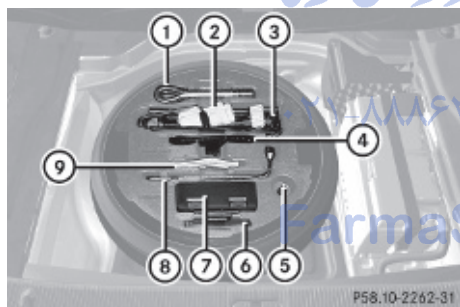

- ① Towing eye bolt
- ② Pair of gloves
- ③ Jack
- ④ Collapsible wheel chock
- ⑤ Alignment bolt
- ⑥ Protective wrap
- ⑦ Electric air pump
- ⑧ Wheel wrench
- ⑨ Fuse chart

Collapsible wheel chock

The collapsible wheel chock serves to secure the vehicle, e.g. while changing a wheel.

- ▶ Take the collapsible wheel chock from the vehicle tool kit (▷ page 268).

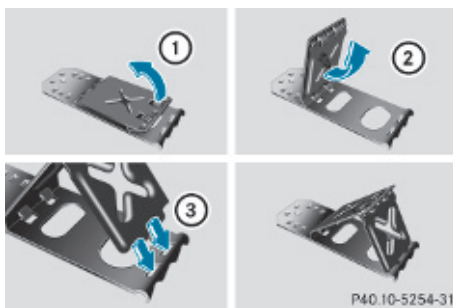

- ▶ **Setting up:** Tilt both plates upward ①.
- ▶ Fold the lower plate outward ②.
- ▶ Guide the tabs of the lower plate all the way into the openings of base plate ③.

For information on where to place wheel chocks when changing a wheel, see “Lifting the vehicle” (▷ page 324).

Jack

Warning! تلفن

Only use the jack supplied with your vehicle to lift the vehicle briefly for wheel changes. If you use the jack for any other purpose, you or others could be injured, as the jack is designed only for the purpose of changing a wheel.

When using the jack, observe the safety notes in the “Mounting the spare wheel” section and the notes on the jack.

- ▶ Take the jack from the vehicle tool kit (▷ page 268).

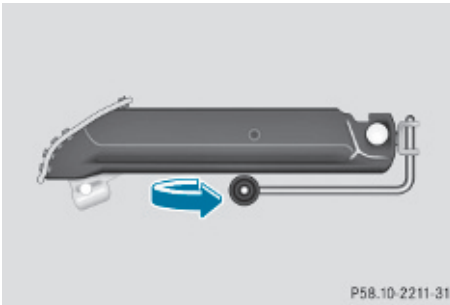

P58.10.2211-31

Storage position

- ▶ Turn the crank handle in the direction of arrow as far as it will go.

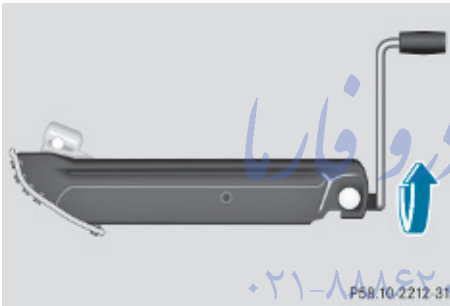

P58.10.2212-31

Operational position

- ▶ Turn the crank handle clockwise.

Before placing the jack back into the vehicle tool kit:

- ▶ Fully collapse the jack.
- ▶ Fold in the crank handle (storage position).

Spare wheel

 **Observe Safety notes, see page 323.**

- i** The E 350 BlueTEC does not have a spare wheel.

The spare wheel is located in the space underneath the trunk floor.

- ▶ **Removing:** Open the trunk (▷ page 81).
- ▶ Lift the trunk floor and secure it on the upper trunk lip (▷ page 268).

- !** To prevent damage, always disengage the floor handle from the upper trunk lip and lower the trunk floor before closing the trunk.

All models except E 63 AMG

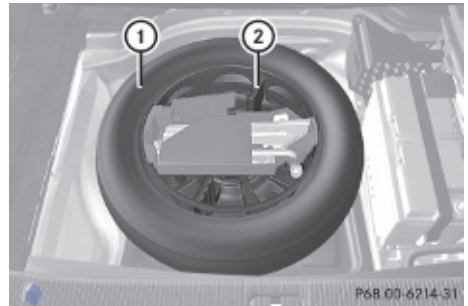

P68.07.6214-31

- ▶ **Removing:** Remove luggage bowl (2) by turning it counterclockwise.
- ▶ Remove spare wheel (1).

Storing the spare wheel after use

- ▶ Place spare wheel (1) into the spare wheel well.
- ▶ Secure spare wheel (1) by turning luggage bowl (2) clockwise.

E 63 AMG

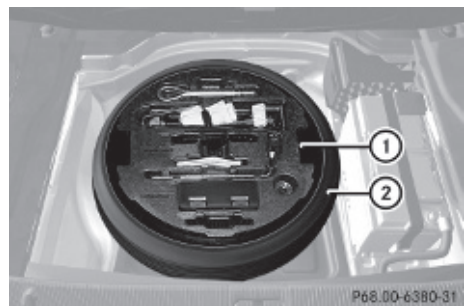

P68.00-6380-31

- ▶ **Removing:** Reach into recess (1) of storage well casing to pull it up and remove it.
- ▶ Remove spare wheel (2).

Storing the spare wheel after use

If you wish to store the spare wheel after use, carry out the following steps. Otherwise, the spare wheel may not fit into the spare wheel well.

- !** Make sure the spare wheel is dry before storing it.
- ▶ Unscrew the valve cap from the valve of the collapsible tire.
- ▶ Unscrew the valve insert from the valve using the valve extractor integrated in the valve cap.
- ▶ Allow the air to escape.
- i** It may take a few minutes for the collapsible tire to deflate completely.
- ▶ Screw the valve insert back into the valve.
- ▶ Screw the valve cap back onto the valve.
- ▶ Take the protective wrap from the vehicle tool kit (▷ page 268).
- ▶ Pull the protective wrap over the spare wheel.
- ▶ Place the spare wheel into the spare wheel well.

Vehicle status messages in the multifunction display



Notes



Warning and malfunction messages appear in the multifunction display located in the instrument cluster.

Certain warning and malfunction messages are accompanied by an audible signal.

Address these messages accordingly and follow the additional instructions given in this Operator's Manual.

High-priority messages appear in the multifunction display in red color.

Certain messages of high priority cannot be cleared from the multifunction display using  or  on the multifunction steering wheel (▷ page 126).

Other messages of high priority and messages of less immediate priority can be cleared from the multifunction display using  or . They are then stored in the vehicle status message memory (▷ page 139). Remember that clearing a message will only make the message disappear. Clearing a message will not correct the condition that caused the message to appear.

Warning!

All categories of messages contain important information which should be taken note of and, where a malfunction is indicated, addressed as soon as possible at an authorized Mercedes-Benz Center.

Failure to repair the condition noted may cause damage not covered by the Mercedes-Benz Limited Warranty, or result in property damage or personal injury.

Warning!

No messages will be displayed if either the instrument cluster or the multifunction display is inoperative.

As a result, you will not be able to see information about your driving conditions, such as

- speed
- outside temperature
- warning/indicator lamps
- malfunction/warning messages
- failure of any systems

Driving characteristics may be impaired.

If you must continue to drive, do so with added caution. Contact an authorized Mercedes-Benz Center as soon as possible.

Read and observe the notes on the HOLD function (▷ page 161) and parking (▷ page 113) when you park the vehicle.

On the pages that follow, you will find a compilation of the most important warning and malfunction messages that may appear.

For your convenience the messages are divided into text messages (▷ page 274) and symbol messages (▷ page 287).

امداد خودرو فارما

تلفن شبانه روزی: ۰۲۱-۸۸۸۶۲۰۸۵

FarmaSOS.com

Text messages

Safety systems



Display messages		Possible causes/consequences and ► Solutions
PRE-SAFE	Inoperative See Operator's Manual	<p>The PRE-SAFE® system has failed. All other occupant safety systems, such as the air bags, are still available.</p> <p>► Contact an authorized Mercedes-Benz Center as soon as possible.</p>
PRE-SAFE	Functions Currently Limited See Operator's Manual	<p>The PRE-SAFE® Brake is temporarily unavailable.</p> <p>The PRE-SAFE® Brake is deactivated because:</p> <ul style="list-style-type: none"> • the DISTRONIC PLUS cover in the radiator grille is dirty • the area around the sensors in the front or the rear bumper is dirty • its function is impaired as a result of heavy precipitation • the radar sensor system is temporarily inoperative due to electromagnetic interference near television and radio transmitter stations, toll stations, speed measuring systems, etc. • the system is out of the operating temperature range • the battery voltage is insufficient • E 63 AMG only: The ESC has been switched off. <p>The PRE-SAFE® Brake becomes operational again and the message in the multifunction display disappears when:</p> <ul style="list-style-type: none"> • dirt on the radiator grille has fallen off while driving (e.g. slush or snow) • the system recognizes full sensor availability (due to lessening rain or the road surface drying) • the system is within the operating temperature range • E 63 AMG only: The ESC is switched back on. <p>If the message in the multifunction display does not disappear:</p> <p>► Clean the DISTRONIC PLUS cover in the radiator grille (► page 263).</p> <p>► Clean the front and the rear bumper (► page 263).</p> <p>► Restart the vehicle.</p> <p>► Wait until the battery recovers.</p>

Display messages		Possible causes/consequences and ► Solutions
PRE-SAFE	Functions Limited See Operator's Manual	The PRE-SAFE® Brake is unavailable due to a malfunction. The BAS PLUS may also be unavailable. ► Contact an authorized Mercedes-Benz Center as soon as possible.

امداد خودرو فارما

تلفن شبانه روزی: ۰۲۱-۸۸۸۶۲۰۸۵

FarmaSOS.com

Display messages	Possible causes/consequences and ► Solutions
Front Passenger Airbag Enabled See Operator's Manual	<p>USA only:</p> <p>The front passenger front air bag is activated while driving even though a child, small individual, or object below the system's weight threshold is on the front passenger seat, or the front passenger seat is empty. Objects on the seat or forces acting on the seat may make the system sense supplemental weight.</p> <ul style="list-style-type: none"> ► Stop the vehicle in a safe location as soon as possible. ► Engage the parking brake. ► Switch off the ignition. ► Open the front passenger door. ► Remove child and child restraint from front passenger seat and properly secure the child in rear seat employing the child restraint if necessary. ► Make sure no objects which apply supplemental weight to the seat are present. The system may recognize such supplemental weight and sense that an occupant on the front passenger seat is of a greater weight than actually present. ► Keep the seat unoccupied, close the front passenger door and switch on the ignition. <p>Monitor the  <small>PASSE AIR BAG OFF</small> indicator lamp in the center console (► page 45) and the multifunction display in the instrument cluster (► page 28) for the following:</p> <p>With the seat unoccupied and the ignition switched on,</p> <ul style="list-style-type: none"> • the  <small>PASSE AIR BAG OFF</small> indicator lamp in the center console should illuminate and remain illuminated, indicating that the OCS (► page 43) has deactivated the front passenger front air bag. • the message Front Passenger Airbag Enabled See Operator's Manual or the message Front Passenger Airbag Disabled See Operator's Manual should not appear in the multifunction display at any time the seat is unoccupied. Wait at least 60 seconds for the system to complete the necessary check cycles and to make sure neither message appears in the multifunction display. <p>If above conditions are met, you can occupy the front passenger seat again. Depending on the front passenger classification sensed by the OCS, the  <small>PASSE AIR BAG OFF</small> indicator lamp will remain illuminated or go out.</p>

Display messages	Possible causes/consequences and ► Solutions
	If above conditions are not met, the system is not working properly. Have the system checked at an authorized Mercedes-Benz Center as soon as possible.







 **Warning!**

If the  indicator lamp remains out even after performing the above corrective steps, do not have any children 12 years old and under and other small individuals use the passenger seat until the system has been repaired.

امداد خودرو فارما

تلفن شبانه روزی: ۰۲۱-۸۸۸۶۲۰۸۵

FarmaSOS.com

Display messages	Possible causes/consequences and ► Solutions
Front Passenger Airbag Disabled See Operator's Manual	<p>USA only:</p> <p>The front passenger front air bag is deactivated while driving even though an adult or someone larger than a small individual is occupying the front passenger seat. Forces acting on the seat may make the system sense a decrease in weight.</p> <ul style="list-style-type: none"> ► Stop the vehicle in a safe location as soon as possible. ► Engage the parking brake. ► Switch off the ignition. ► Have the front passenger vacate the seat and exit the vehicle. ► Keep the seat unoccupied, close the front passenger door and switch on the ignition. <p>Monitor the   indicator lamp in the center console (► page 45) and the multifunction display in the instrument cluster (► page 28) for the following:</p> <p>With the seat unoccupied and the ignition switched on,</p> <ul style="list-style-type: none"> • the   indicator lamp in the center console should illuminate and remain illuminated, indicating that the OCS (► page 43) has deactivated the front passenger front air bag. • the message Front Passenger Airbag Enabled See Operator's Manual or the message Front Passenger Airbag Disabled See Operator's Manual should not appear in the multifunction display at any time the seat is unoccupied. Wait at least 60 seconds for the system to complete the necessary check cycles and to make sure neither message appears in the multifunction display. <p>If above conditions are met, you can occupy the front passenger seat again. Depending on the front passenger classification sensed by the OCS, the   indicator lamp will remain illuminated or go out.</p> <p>If above conditions are not met, the system is not working properly. Have the system checked at an authorized Mercedes-Benz Center as soon as possible.</p>

Display messages		Possible causes/consequences and ► Solutions
Check Child Seat Position	See Operator's Manual	Vehicles with BabySmart™ (Canada only): The BabySmart™ child seat is not positioned correctly. Risk of injury! ► Install the BabySmart™ child seat in correct position.
		Vehicles with BabySmart™ (Canada only): The sensor for child seat recognition is malfunctioning. Risk of injury! ► Contact an authorized Mercedes-Benz Center.

 **Warning!**

If the  indicator lamp remains illuminated with an adult occupant on the front passenger seat even after performing the above corrective steps, do not have any passenger use the front passenger seat until the system has been repaired.

Driving systems

Display messages		Possible causes/consequences and ► Solutions
Cruise Control	Inoperative	The cruise control is malfunctioning. In addition an acoustic warning sounds. ► Have the cruise control checked at an authorized Mercedes-Benz Center.
Cruise Control	- - - mph	One of the activation conditions for cruise control has not been fulfilled. You may have attempted to set a speed below 20 mph (30 km/h). ► Drive faster than 20 mph (30 km/h) if the situation allows and set the speed. ► Check the activation conditions for cruise control (▷ page 147).

Display messages		Possible causes/consequences and ► Solutions
DISTRONIC PLUS	Currently Unavailable See Operator's Manual	<p>The DISTRONIC PLUS is temporarily unavailable. The DISTRONIC PLUS is deactivated because:</p> <ul style="list-style-type: none"> • the DISTRONIC PLUS cover in the radiator grille is dirty • its function is impaired as a result of heavy precipitation • the radar sensor system is temporarily inoperative due to electromagnetic interference near television and radio transmitter stations, toll stations, speed measuring systems, etc. • the radar sensors do not sense any other vehicles or objects, i.e. road sign or similar to this, for a long time • the system is out of the operating temperature range • the battery voltage is insufficient <p>► If necessary, clean the DISTRONIC PLUS cover in the radiator grille (► page 263). ► Restart the vehicle. ► Try activating the DISTRONIC PLUS again later. ► Wait until the system is within the operating temperature range or the battery recovers.</p> <p>The DISTRONIC PLUS becomes operational again without the engine being restarted when:</p> <ul style="list-style-type: none"> • dirt on the radiator grille has fallen off while driving (e.g. slush or snow) • the system recognizes full sensor availability (due to lessening rain or the road surface drying) • the message in the multifunction display disappears
DISTRONIC PLUS	Inoperative	<p>The DISTRONIC PLUS is malfunctioning. The BAS PLUS and the PRE-SAFE® Brake are also not available.</p> <p>► Contact an authorized Mercedes-Benz Center as soon as possible.</p>
DISTRONIC PLUS	Override	<p>You have accelerated. The DISTRONIC PLUS has switched off.</p> <p>► Stop accelerating.</p>

Display messages		Possible causes/consequences and ► Solutions
DISTRONIC PLUS	- - - mph	<p>One of the activation conditions for the DISTRONIC PLUS has not been fulfilled. You may have attempted to set a speed below 20 mph (30 km/h).</p> <ul style="list-style-type: none"> ► Drive faster than 20 mph (30 km/h) if the situation allows and set the speed. ► Check the activation conditions for the DISTRONIC PLUS (► page 153).
HOLD	Off	<p>The HOLD function switched off because the vehicle was sliding, for example on a slippery surface.</p> <ul style="list-style-type: none"> ► Activate the HOLD function later.
Blind Spot Assist	Currently Unavailable See Operator's Manual	<p>The Blind Spot Assist is deactivated because the area around the sensors in the front or the rear bumper is dirty.</p> <ul style="list-style-type: none"> ► Clean the front and rear bumper (► page 263).
		<p>The Blind Spot Assist is deactivated because the battery voltage is insufficient.</p> <ul style="list-style-type: none"> ► Have the battery checked at an authorized Mercedes-Benz Center.
		<p>The Blind Spot Assist is switched off because the radar sensor system is temporarily inoperative due to electromagnetic interference near television and radio transmitter stations, toll stations, speed measuring systems, etc.</p> <ul style="list-style-type: none"> ► Wait until the message in the multifunction display disappears.
Blind Spot Assist	Inoperative	<p>The Blind Spot Assist is malfunctioning.</p> <ul style="list-style-type: none"> ► Contact an authorized Mercedes-Benz Center as soon as possible.
Parking Guidance	Inoperative	<p>The Parktronic system is malfunctioning.</p> <ul style="list-style-type: none"> ► Have the system checked at an authorized Mercedes-Benz Center as soon as possible.

Display messages		Possible causes/consequences and ► Solutions
Parking Guidance	Canceled	<p>The Advanced Parking Guidance has been canceled because:</p> <ul style="list-style-type: none"> • the vehicle is sliding • the bumper became dirty in the area of the sensors • there has been a malfunction <p>► Use the Advanced Parking Guidance again later.</p> <p>If the parking space symbol is not shown in the multifunction display at a speed below 10 mph (16 km/h):</p> <p>► Clean the bumpers (> page 263).</p> <p>or</p> <p>► Restart the engine.</p> <p>or</p> <p>► Contact an authorized Mercedes-Benz Center.</p>
Parking Guidance	Finished	<p>Advanced Parking Guidance: The vehicle is in the end position.</p> <p>The display message disappears automatically.</p>
Radar Sensors	Deactivated See Operator's Manual	<p>You have attempted to activate the DISTRONIC PLUS or the PRE-SAFE® Brake even though you have switched off the radar sensors on the vehicle.</p> <ul style="list-style-type: none"> ► Check if switching on the radar sensors is permitted (> page 144). ► Switch on the radar sensors using the instrument cluster control system.

Display messages		Possible causes/consequences and ► Solutions
Lane Keeping Assist	Currently Unavailable See Operator's Manual	<p>The Lane Keeping Assist is temporarily unavailable. The Lane Keeping Assist is deactivated because:</p> <ul style="list-style-type: none"> • the windshield in front of the camera is dirty • its function is impaired as a result of heavy precipitation or fog • lane markings are not present for an extended period of time • lane markings are worn, dark, or covered by dirt or snow for example <p>The Lane Keeping Assist becomes operational again and the message in the multifunction display disappears when:</p> <ul style="list-style-type: none"> • dirt on the windshield has fallen off while driving (e.g. slush or snow) • the system recognizes full camera availability <p>► If necessary, clean the windshield in front of the camera (► page 264).</p>
Lane Keeping Assist	Inoperative	<p>The Lane Keeping Assist is malfunctioning.</p> <p>► Contact an authorized Mercedes-Benz Center.</p>

Vehicle

Display messages		Possible causes/consequences and ► Solutions
Apply Brake	to Shift from 'P'	<p>You have attempted to shift the automatic transmission into drive position D, reverse gear R or neutral position N without depressing the brake pedal.</p> <p>► Depress the brake pedal.</p>
Door Open	Vehicle Not in 'P'	<p>In addition an acoustic warning sounds.</p> <p>You have opened the driver's door and the automatic transmission is still in drive position D, reverse gear R or neutral position N.</p> <p>► Before you leave the vehicle, make sure the automatic transmission is in park position P and the parking brake is engaged.</p>

Display messages		Possible causes/consequences and ► Solutions
Service Required	Do Not Shift Gears Visit Dealer	In addition an acoustic warning sounds. The automatic transmission cannot be shifted out of the current transmission position because of a malfunction. If the automatic transmission is in drive position D : ► Without shifting the automatic transmission out of drive position D , drive to an authorized Mercedes-Benz Center. If the automatic transmission is set to position neutral position N , reverse gear R or park position P : ► Do not drive. ► Contact an authorized Mercedes-Benz Center or call Roadside Assistance.
Only Shift to 'P' when Vehicle is Stationary		You have attempted to shift the automatic transmission into park position P although the vehicle was still in motion. ► Stop your vehicle as soon as it is safe to do so. ► Shift the automatic transmission to park position P .
Shift to 'P' or 'N'	to Start Engine	You have attempted to start the engine with the KEYLESS-GO start/stop button while the automatic transmission was in reverse gear R or drive position D . ► Shift the automatic transmission into park position P or neutral position N . Make sure the brake pedal is depressed.
Auxiliary Battery	Malfunction	The backup battery for the automatic transmission is no longer charging. ► Contact an authorized Mercedes-Benz Center.

Tires

Display messages		Possible causes/consequences and ► Solutions
Check Tire Pressure	Then Restart Run Flat Indicator	There has been a warning message about a loss in the tire inflation pressure and the tire pressure loss warning system was not restarted yet. ► Make sure the correct tire inflation pressure is set for each tire. ► Then restart the tire pressure loss warning system (► page 232).
Run Flat Indicator	Inoperative	The tire pressure loss warning system is malfunctioning. ► Have the tire pressure loss warning system checked at an authorized Mercedes-Benz Center.

Display messages		Possible causes/consequences and ► Solutions
Check	Tire Pressure Soon	<p>The tire pressure loss warning system indicates that the tire inflation pressure is too low in at least one tire.</p> <ul style="list-style-type: none"> ► Carefully bring the vehicle to a halt, avoiding abrupt steering and braking maneuvers. Observe the traffic situation around you. ► Check the tires and, if necessary, change the wheel (▷ page 323). ► Check and adjust tire inflation pressure as required (▷ page 231). ► Restart the tire pressure loss warning system after adjusting the tire inflation pressure values (▷ page 232).
Tire pressures will be displayed	after driving a few minutes	<p>The tire inflation pressure is being checked by the Advanced TPMS.</p> <ul style="list-style-type: none"> ► Drive the vehicle for a few minutes.
Tire Press. Monitor	Inoperative	<p>The Advanced TPMS is malfunctioning.</p> <ul style="list-style-type: none"> ► Have the Advanced TPMS checked at an authorized Mercedes-Benz Center.
Tire Pressure Monitor	Inoperative No Wheel Sensors	<p>There are wheels without appropriate wheel sensors mounted (e.g. winter tires). تلفن شماره روزی: ۰۲۱</p> <ul style="list-style-type: none"> ► Have the Advanced TPMS checked at an authorized Mercedes-Benz Center. ► Have the appropriate wheel sensors installed at an authorized Mercedes-Benz Center.
TirePress.	Sensor(s) Missing	<p>At least one sensor is defect (e.g. battery is empty). The respective tire is indicated by - - instead of the tire inflation pressure in the multifunction display.</p> <ul style="list-style-type: none"> ► Have the Advanced TPMS checked at an authorized Mercedes-Benz Center. ► Have the wheel sensors installed at an authorized Mercedes-Benz Center. <p>At least one wheel without appropriate wheel sensors is mounted (e.g. spare wheel). The respective tire is indicated by - - instead of the tire inflation pressure in the multifunction display.</p> <ul style="list-style-type: none"> ► Have the Advanced TPMS checked at an authorized Mercedes-Benz Center. ► Have the wheel sensors installed at an authorized Mercedes-Benz Center.

Display messages		Possible causes/consequences and ► Solutions
Tire Press. Monitor	Currently Unavailable	<p>The Advanced TPMS cannot monitor the tire inflation pressure due to a nearby radio interference source or insufficient power supply.</p> <p>As soon as the causes of the malfunction have been rectified, the Advanced TPMS becomes active again automatically after a few minutes of driving.</p>
Correct Tire Pressure		<p>The tire inflation pressure is too low in at least one tire.</p> <p>or</p> <p>The tire inflation pressures of the individual tires differ from each other significantly.</p> <p>The tire inflation pressure values are shown in the multifunction display.</p> <ul style="list-style-type: none"> ► Check and correct tire inflation pressure as required (► page 231). ► Restart the Advanced TPMS (► page 236).
Caution Tire Defect		<p>At least one tire is deflating.</p> <p>The respective tire is indicated in the multifunction display.</p> <ul style="list-style-type: none"> ► Carefully bring the vehicle to a halt, avoiding abrupt steering and braking maneuvers. ► If necessary, change the wheel (► page 323).
Check Tires		<p>The tire inflation pressure in at least one tire is significantly below the reference value.</p> <p>The respective tire is indicated in the multifunction display.</p> <ul style="list-style-type: none"> ► Carefully bring the vehicle to a halt, avoiding abrupt steering and braking maneuvers. ► Check and adjust tire inflation pressure as required. ► If necessary, change the wheel (► page 323).

 **Warning!**

Do not drive with a flat tire. A flat tire affects the ability to steer or brake the vehicle. You may lose control of the vehicle. Continued driving with a flat tire will cause excessive heat build-up and possibly a fire.

 **Warning!**

Follow recommended tire inflation pressures.

Do not underinflate tires. Underinflated tires wear excessively and/or unevenly, adversely affect handling and fuel economy, and are more likely to fail from being overheated.

Do not overinflate tires. Overinflated tires can adversely affect handling and ride comfort, wear unevenly, increase stopping distance, and result in sudden deflation (blowout) because they are more likely to become punctured or damaged by road debris, potholes etc.

Symbol messages

Brake









Display messages	Possible causes/consequences and ► Solutions
 <p data-bbox="266 427 386 510">Check Brake Pad Wear</p>	<p data-bbox="420 427 884 454">The brake pads have reached their wear limit.</p> <ul style="list-style-type: none"> <li data-bbox="420 462 1013 518">► Have the brake pads replaced as soon as possible at an authorized Mercedes-Benz Center.







! Brake pad thickness must be visually inspected by a qualified technician at the intervals specified in the Maintenance Booklet.

امداد خودرو فارما

تلفن شبانه روزی: ۰۲۱-۸۸۸۶۲۰۸۵

FarmaSOS.com

Display messages	Possible causes/consequences and ► Solutions	
<p>BRAKE (USA only)</p> <p> (Canada only)</p>	<p>ABS and ESC Inoperative See Operator's Manual</p>	<p>In addition, the yellow ESC warning lamp , the yellow ESC OFF warning lamp , and the yellow ABS indicator lamp  come on.</p> <p>The brake system is still functioning normally but due to a malfunction, the ABS, the BAS, the BAS PLUS, the ESC, the hill-start assist system, the HOLD function, the PRE-SAFE® system, and the PRE-SAFE® Brake are unavailable. The ATTENTION ASSIST is disabled.</p> <ul style="list-style-type: none"> ► Continue driving with added caution. Wheels may lock during hard braking, reducing steering capability. ► Adjust driving to be consistent with reduced braking responsiveness. ► Have the system checked at an authorized Mercedes-Benz Center as soon as possible. <p>Failure to follow these instructions increases the risk of an accident.</p>
<p>BRAKE (USA only)</p> <p> (Canada only)</p>	<p>ABS and ESC Currently Unavailable See Operator's Manual</p>	<p>In addition, the yellow ESC warning lamp , the yellow ESC OFF warning lamp , and the yellow ABS indicator lamp  come on.</p> <p>The brake system still functions normally but due to insufficient power supply, the ABS, the BAS, the BAS PLUS, the ESC, the hill-start assist system, the HOLD function, the PRE-SAFE® system, and the PRE-SAFE® Brake are unavailable. The ATTENTION ASSIST is disabled.</p> <ul style="list-style-type: none"> ► Continue driving with added caution. Wheels may lock during hard braking, reducing steering capability. ► Adjust driving to be consistent with reduced braking responsiveness. <p>When the voltage is above the required value again, the ABS, the BAS, the BAS PLUS, the ESC, the hill-start assist system, the HOLD function, the PRE-SAFE® system, and the PRE-SAFE® Brake are operational again and the message should disappear.</p> <p>If the message does not disappear:</p> <ul style="list-style-type: none"> ► Have the alternator and the battery checked. <p>Failure to follow these instructions increases the risk of an accident.</p>

Display messages	Possible causes/consequences and ► Solutions	
<p>BRAKE (USA only)</p>  <p>(Canada only)</p>	<p>EBD, ABS, and ESC Inoperative See Operator's Manual</p>	<p>In addition, the yellow ESC warning lamp , the yellow ESC OFF warning lamp , and the yellow ABS indicator lamp  come on.</p> <p>The brake system is still functioning normally but due to a malfunction, the ABS, the BAS, the BAS PLUS, the EBP, the ESC, the HOLD function, the PRE-SAFE® system, and the PRE-SAFE® Brake are unavailable.</p> <p>The ATTENTION ASSIST is disabled.</p> <ul style="list-style-type: none"> ► Continue driving with added caution. Wheels may lock during hard braking, reducing steering capability. ► Adjust driving to be consistent with reduced braking responsiveness. ► Have the system checked at an authorized Mercedes-Benz Center as soon as possible. <p>Failure to follow these instructions increases the risk of an accident.</p>
<p>BRAKE (USA only)</p>  <p>(Canada only)</p>	<p>Release Parking Brake</p>	<p>You are driving with the parking brake engaged. In addition an acoustic warning sounds.</p> <ul style="list-style-type: none"> ► Release the parking brake.
<p>BRAKE (USA only)</p>  <p>(Canada only)</p>	<p>Check Brake Fluid Level</p>	<p>There is insufficient brake fluid in the reservoir. Risk of accident!</p> <ul style="list-style-type: none"> ► Stop the vehicle in a safe location or as soon as it is safe to do so. ► Engage the parking brake. ► Do not drive any further. ► Contact an authorized Mercedes-Benz Center or call Roadside Assistance. <p>Do not add brake fluid! This will not solve the problem.</p>







 **Warning!**





Driving with the message Check Brake Fluid Level displayed can result in an accident. Have your brake system checked immediately.

Do not add brake fluid before checking the brake system. Overfilling the brake fluid reservoir can result in spilling brake fluid on hot engine parts and the brake fluid catching fire. You can be seriously burned.

! If you find that the brake fluid in the brake fluid reservoir has fallen to the minimum mark or below, have the brake system checked for brake pad thickness and leaks.

Safety systems

Display messages		Possible causes/consequences and ► Solutions
	ESC Inoperative See Operator's Manual	<p>In addition, the yellow ESC warning lamp  and the yellow ESC OFF warning lamp  come on.</p> <p>The brake system is still functioning normally but due to a malfunction, the BAS, the BAS PLUS, the ESC, the hill-start assist system, the HOLD function, the PRE-SAFE® system, and the PRE-SAFE® Brake are unavailable.</p> <p>The ATTENTION ASSIST is disabled.</p> <ul style="list-style-type: none"> ► Continue driving with added caution. Wheels may lock during hard braking, reducing steering capability. ► Adjust driving to be consistent with reduced braking responsiveness. ► Have the system checked at an authorized Mercedes-Benz Center as soon as possible. <p>Failure to follow these instructions increases the risk of an accident.</p>
	Tele Aid Inoperative	<p>One or more main functions of the Tele Aid system are malfunctioning.</p> <ul style="list-style-type: none"> ► Have the Tele Aid system checked at an authorized Mercedes-Benz Center.
	SRS Malfunction Service Required	<p>There is a malfunction in the Supplemental Restraint System (SRS). The air bags or Emergency Tensioning Devices (ETDs) could deploy unexpectedly or fail to activate in an accident.</p> <ul style="list-style-type: none"> ► Drive with added caution to the nearest authorized Mercedes-Benz Center.
	Front Left SRS Malfunction Service Required	<p>Components of the driver's supplemental restraint system may not work properly.</p> <ul style="list-style-type: none"> ► Drive with added caution to the nearest authorized Mercedes-Benz Center.
	Front Right SRS Malfunction Service Required	<p>Components of the front passenger's supplemental restraint system may not work properly.</p> <ul style="list-style-type: none"> ► Drive with added caution to the nearest authorized Mercedes-Benz Center.

Display messages	Possible causes/consequences and ► Solutions
 <p>Rear Left SRS Malfunction Service Required</p>	<p>Components of the left rear passenger's supplemental restraint system may not work properly.</p> <p>► Drive with added caution to the nearest authorized Mercedes-Benz Center.</p>
 <p>Rear Center SRS Malfunction Service Required</p>	<p>Components of the center rear passenger's supplemental restraint system may not work properly.</p> <p>► Drive with added caution to the nearest authorized Mercedes-Benz Center.</p>
 <p>Rear Right SRS Malfunction Service Required</p>	<p>Components of the right rear passenger's supplemental restraint system may not work properly.</p> <p>► Drive with added caution to the nearest authorized Mercedes-Benz Center.</p>
 <p>Left Side Curtain Airbag Malfunction Service Required</p>	<p>The left window curtain air bag may not work properly.</p> <p>► Drive with added caution to the nearest authorized Mercedes-Benz Center.</p>
 <p>Right Side Curtain Airbag Malfunction Service Required</p>	<p>The right window curtain air bag may not work properly.</p> <p>► Drive with added caution to the nearest authorized Mercedes-Benz Center.</p>







⚠ Warning!

In the event a malfunction of the SRS is indicated as outlined above, the SRS may not be operational.

For your safety, we strongly recommend that you contact an authorized Mercedes-Benz







Center immediately to have the system checked. Otherwise the SRS may not be activated when needed in an accident, which could result in serious or fatal injury, or it might deploy unexpectedly and unnecessarily which could also result in injury.







Driving systems

Display messages	Possible causes/consequences and ► Solutions
 Vehicle Rising	The vehicle is adjusting to your level selection.
 Vehicle Rising Please Wait	The vehicle level is too low. ► Wait until the message disappears from the multifunction display.
 Pull Over Car Too Low	You have started driving although the vehicle level was too low. The vehicle will be raised. ► Stop the vehicle as soon as it is safe to do so. ► Engage the electronic parking brake. ► Wait until the message disappears from the multifunction display. You may then drive off.
 Pull Over Car Too Low	The AIRMATIC is malfunctioning. ► Avoid excessive steering maneuvers. The fenders or tires could otherwise be damaged. Listen for scraping noises. ► Do not drive faster than 50 mph (80 km/h). ► Drive to the side of the road and select a higher vehicle level (► page 163). Depending on the type of malfunction, this may raise the vehicle's level. ► Contact an authorized Mercedes-Benz Center as soon as possible. There is otherwise danger of an accident.
 Malfunction	The capability of the AIRMATIC system is restricted. This can impair the handling. ► Do not drive faster than 50 mph (80 km/h). ► Have the vehicle checked at an authorized Mercedes-Benz Center.
 Attention Assist Time for a rest?	The ATTENTION ASSIST has determined that your concentration has declined considering certain criteria. In addition, an acoustic warning sounds. ► Take a rest if required. During long trips, take regular and duly rests that allow you to recover sufficiently.

Display messages	Possible causes/consequences and ► Solutions
 <p>Attention Assist Inoperative</p>	<p>The ATTENTION ASSIST is malfunctioning.</p> <ul style="list-style-type: none"> ► Contact an authorized Mercedes-Benz Center as soon as possible.

Vehicle

Display messages	Possible causes/consequences and ► Solutions
	<p>The trunk is open.</p> <ul style="list-style-type: none"> ► Close the trunk (► page 82).
	<p>You are driving with the hood open.</p> <ul style="list-style-type: none"> ► Stop the vehicle in a safe location as soon as it is safe to do so. ► Close the hood (► page 224). <p>There is otherwise danger of an accident.</p>
	<p>You are driving with at least one door open.</p> <p>The display symbol shows you which doors are open.</p> <ul style="list-style-type: none"> ► Close all doors.
 <p>Rear Left Backrest Not Latched or Rear Right Backrest Not Latched</p>	<p>The left or right rear seat backrest is not engaged.</p> <ul style="list-style-type: none"> ► Adjust the rear seat backrest until it is fully engaged in position.
 <p>Take Your Key From Ignition</p>	<p>You have forgotten to remove the SmartKey.</p> <ul style="list-style-type: none"> ► Remove the SmartKey from the starter switch.
 <p>Obtain A New Key</p>	<p>The SmartKey is malfunctioning.</p> <ul style="list-style-type: none"> ► Contact an authorized Mercedes-Benz Center.
 <p>Close Doors To Lock Vehicle</p>	<p>You tried to lock the vehicle but not all doors were closed.</p> <ul style="list-style-type: none"> ► Close doors and lock the vehicle again.

Display messages		Possible causes/consequences and ► Solutions
	Key Does Not Belong to Vehicle	<p>The SmartKey in the starter switch does not belong to the vehicle.</p> <ul style="list-style-type: none"> ► Remove the SmartKey from the starter switch.
	Replace Key Battery	<p>The batteries in the SmartKey with KEYLESS-GO are discharged.</p> <ul style="list-style-type: none"> ► Replace the batteries (► page 317).
	Key Not Detected (message appears in red)	<p>The SmartKey with KEYLESS-GO is not detected while the engine is running because the SmartKey is not in the vehicle.</p> <ul style="list-style-type: none"> ► Stop the vehicle as soon as it is safe to do so. ► Engage the parking brake. ► Search for the SmartKey. <p>The vehicle cannot be locked centrally nor can the engine be started again after the engine is stopped.</p>
	Key Not Detected (message appears in red)	<p>The SmartKey with KEYLESS-GO is not detected while the engine is running because there is strong radio-frequency interference.</p> <ul style="list-style-type: none"> ► Stop the vehicle as soon as it is safe to do so. ► Engage the parking brake. ► Remove the KEYLESS-GO button from the starter switch (► page 86). ► Operate the vehicle with the SmartKey in the starter switch.
	Key Not Detected (message appears in white)	<p>The SmartKey with KEYLESS-GO is momentarily not detected.</p> <ul style="list-style-type: none"> ► Change the position of the SmartKey in the vehicle. ► If necessary, remove the KEYLESS-GO button from the starter switch (► page 86).
	Remove 'Start' Button and Insert Key	<p>The KEYLESS-GO system is malfunctioning.</p> <ul style="list-style-type: none"> ► Remove the KEYLESS-GO button from the starter switch (► page 86). ► Operate the vehicle with the SmartKey in the starter switch.
	Check Washer Fluid	<p>The washer fluid in the washer fluid reservoir has fallen below the minimum level.</p> <ul style="list-style-type: none"> ► Add washer fluid (► page 227).

Display messages	Possible causes/consequences and ► Solutions	
	Power Steering Malfunction See Operator's Manual	<p>Power assistance for the steering system is not available. A considerably higher degree of effort is necessary to steer the vehicle.</p> <ul style="list-style-type: none"> ► Check whether you are capable to apply the higher degree of effort necessary to safely steer the vehicle. <p>If you are able to steer the vehicle safely:</p> <ul style="list-style-type: none"> ► Continue driving with added caution. ► Have the system checked at an authorized Mercedes-Benz Center. <p>If, in any way, you feel that you are not able to steer the vehicle safely:</p> <ul style="list-style-type: none"> ► Stop the vehicle in a safe location as soon as it is safe to do so. ► Apply the parking brake. ► Do not continue to drive. ► Contact an authorized Mercedes-Benz Center.

Engine

Display messages	Possible causes/consequences and ► Solutions	
	Check Coolant Level See Operator's Manual	<p>The coolant level is too low.</p> <ul style="list-style-type: none"> ► Add coolant (► page 226). ► If you have to add coolant frequently, have the cooling system checked at an authorized Mercedes-Benz Center.

Warning!

Do not spill antifreeze on hot engine parts. Antifreeze contains ethylene glycol which may burn if it comes into contact with hot engine parts. You could be seriously burned.

! Do not ignore the low engine coolant level warning. Extended driving with the message and symbol displayed may cause serious engine damage not covered by the Mercedes-Benz Limited Warranty.

Do not drive without sufficient amount of coolant in the cooling system. The engine will overheat causing major engine damage.

Display messages	Possible causes/consequences and ► Solutions
 <p>Coolant Low Stop Vehicle! Turn Engine Off</p>	<p>The coolant is too hot.</p> <ul style="list-style-type: none"> ► Stop the vehicle immediately as soon as it is safe to do so. ► Turn off the engine immediately. ► Engage the parking brake. ► Only start the engine again after the message disappears. You could otherwise damage the engine. ► Observe the coolant temperature gauge in the instrument cluster. ► If the temperature rises again: Contact an authorized Mercedes-Benz Center immediately. <p>During severe operation conditions and stop-and-go city traffic, the coolant temperature may rise close to 248°F (120°C).</p>



 **Warning!**

Driving when your engine is overheated can cause some fluids which may have leaked into the engine compartment to catch fire. You could be seriously burned.

Steam from an overheated engine can cause serious burns which can occur just by opening the engine hood. Stay away from the engine if you see or hear steam coming from it.

Stop the vehicle in a safe location away from other traffic. Turn off the engine, get out of the vehicle and do not stand near the vehicle until the engine has cooled down.

- !** The engine should not be operated with the coolant temperature above 248°F (120°C). Doing so may cause serious damage which is not covered by the Mercedes-Benz Limited Warranty.

Display messages	Possible causes/consequences and ► Solutions
 <p>Coolant Low Stop Vehicle! Turn Engine Off</p>	<p>The poly-V-belt could be broken.</p> <ul style="list-style-type: none"> ► Stop the vehicle immediately as soon as it is safe to do so. ► Turn off the engine immediately. ► Check the poly-V-belt. ► If it is broken: Do not continue to drive. Otherwise the engine will overheat due to an inoperative water pump which may result in damage to the engine. Contact an authorized Mercedes-Benz Center. ► If it is intact: Do not continue to drive the vehicle with this message displayed. Doing so could result in serious engine damage that is not covered by the Mercedes-Benz Limited Warranty. ► Observe the coolant temperature gauge in the instrument cluster. ► Drive to the nearest authorized Mercedes-Benz Center immediately.
	<p>The radiator cooling fan is malfunctioning.</p> <ul style="list-style-type: none"> ► Observe the coolant temperature gauge in the instrument cluster. <p>If the coolant temperature is below 248°F (120°C), you may continue driving to an authorized Mercedes-Benz Center.</p> <ul style="list-style-type: none"> ► Avoid placing heavy loads on the engine (e.g. by driving uphill) as well as stop-and-go traffic. ► Have the fan replaced as soon as possible.
	<p>The battery is no longer charging.</p> <p>Possible causes:</p> <ul style="list-style-type: none"> • alternator malfunctioning • broken poly-V-belt • a malfunction in the electronic system <ul style="list-style-type: none"> ► Stop immediately in a safe location or as soon as it is safe to do so and check the poly-V-belt. ► If it is broken: Do not continue to drive. Otherwise the engine will overheat due to an inoperative water pump which may result in damage to the engine. Contact an authorized Mercedes-Benz Center. ► If it is intact: Drive to the nearest authorized Mercedes-Benz Center immediately. Adjust driving to be consistent with reduced braking responsiveness.

Display messages	Possible causes/consequences and ► Solutions
 <p>Check Engine Oil At Next Refueling</p>	<p>The engine oil has dropped to a critical level.</p> <ul style="list-style-type: none"> ► Check the engine oil level (▷ page 224) and add engine oil as required (▷ page 225). ► If you must add engine oil frequently, have the engine checked for possible leaks.





If the message Check Engine Oil At Next Refueling appears while the engine is running and at operating temperature, the engine oil level has dropped to approximately the minimum level.





The message will be stored in the vehicle status message memory after you have cleared it from the multifunction display.

Visually check for oil leaks. If there are no obvious oil leaks, drive to the nearest service station to refill your engine oil to the required level.

For information on approved engine oils contact an authorized Mercedes-Benz Center or visit www.mbusa.com (USA only).



! Engine oil level warnings should not be ignored. Extended driving with the symbol displayed could result in serious engine damage that is not covered by the Mercedes-Benz Limited Warranty.





Display messages	Possible causes/consequences and ► Solutions
	<p>The fuel level is low.</p> <ul style="list-style-type: none"> ► Refuel at the next gas station.
 <p>Fuel Level Low</p>	<p>The fuel level has dropped below the reserve mark.</p> <ul style="list-style-type: none"> ► Refuel at the next gas station.
 <p>Ultra Low-sulfur Diesel Fuel Only</p>	<p>Vehicles with diesel engine only:</p> <p>The fuel level has dropped below the reserve mark.</p> <ul style="list-style-type: none"> ► Refuel at the next gas station. ► Only use commercially available vehicular ULTRA-LOW SULFUR HIGHWAY DIESEL FUEL (ULSD, 15 ppm SULFUR MAXIMUM).
 <p>Gas Cap Loose</p>	<p>A loss of pressure has been detected in the fuel system. The fuel cap may not be closed properly or the fuel system may be leaking.</p> <ul style="list-style-type: none"> ► Check the fuel cap (▷ page 220). ► If it is not closed properly: Close the fuel cap. ► If it is closed properly: Have the fuel system checked at an authorized Mercedes-Benz Center.





Display messages	Possible causes/consequences and ► Solutions
 <p>Replace Air Filter</p>	<p>The air filter is clogged.</p> <ul style="list-style-type: none"> ► Have the air filter checked at an authorized Mercedes-Benz Center.
 <p>Check Fuel Filter</p>	<p>There is water in the fuel filter.</p> <ul style="list-style-type: none"> ► Have the water drained at an authorized Mercedes-Benz Center as soon as possible.
 <p>Check Additive See Operator's Manual</p>	<p>The AdBlue® supply is almost depleted.</p> <ul style="list-style-type: none"> ► Have the AdBlue® tank refilled as soon as possible (► page 333). Contact an authorized Mercedes-Benz Center.
 <p>Remaining Starts: 20</p>	<p>The AdBlue® supply has dropped to the minimum level.</p> <ul style="list-style-type: none"> ► Have the AdBlue® tank refilled immediately (► page 333). Contact an authorized Mercedes-Benz Center.





i When the message Remaining Starts: 20 appears in the multifunction display, you can start the engine 20 more times. If you do not add AdBlue®, the engine cannot be started beyond that point. Therefore, fill the AdBlue® tank with approximately 1 gal (3.79 l) AdBlue® (corresponds to approximately 2 refill containers AdBlue®) or have the AdBlue® tank filled at an authorized Mercedes-Benz Center. After AdBlue® was refilled, the engine can be started again.





Lamps

Display messages	Possible causes/consequences and ► Solutions
 <p>Active Headlamps Inoperative</p>	<p>The active Bi-Xenon headlamp system is malfunctioning.</p> <ul style="list-style-type: none"> ► Contact an authorized Mercedes-Benz Center as soon as possible.
 <p>Adaptive Highbeam Assist Inoperative</p>	<p>The Adaptive Highbeam Assist is malfunctioning.</p> <ul style="list-style-type: none"> ► Contact an authorized Mercedes-Benz Center as soon as possible.

Display messages	Possible causes/consequences and	Solutions
	Check Left Daytime Running Light or Check Right Daytime Running Light	The left or right daytime running lamps are malfunctioning. ► Contact an authorized Mercedes-Benz Center as soon as possible.
	Check Left Reverse Lamp or Check Right Reverse Lamp	The left or right backup lamp is malfunctioning. ► Contact an authorized Mercedes-Benz Center as soon as possible.
	Check Center Brake Lamp	The high-mounted brake lamp is malfunctioning. This message will only appear if all LEDs have stopped working. ► Contact an authorized Mercedes-Benz Center as soon as possible.
	Check Left Fog Lamp or Check Right Fog Lamp	The left or right front fog lamp is malfunctioning. This message will only appear if all LEDs have stopped working. ► Contact an authorized Mercedes-Benz Center as soon as possible.
	Check Front Left Sidemarker Lamp or Check Front Right Sidemarker Lamp	The front left side or right side marker lamp is malfunctioning. ► Contact an authorized Mercedes-Benz Center as soon as possible.

Display messages	Possible causes/consequences and ► Solutions
 <p>Check Rear Left Sidemarker Lamp or Check Rear Right Sidemarker Lamp</p>	<p>The rear left side or right side marker lamp is malfunctioning.</p> <ul style="list-style-type: none"> ► Contact an authorized Mercedes-Benz Center as soon as possible.
 <p>Check Front Left Parking Lamp or Check Front Right Parking Lamp</p>	<p>The left or right front parking lamp is malfunctioning.</p> <ul style="list-style-type: none"> ► Halogen headlamp: Replace the bulb as soon as possible (► page 318). ► Bi-Xenon headlamp: Contact an authorized Mercedes-Benz Center as soon as possible.
 <p>Check Left High Beam or Check Right High Beam</p>	<p>The left or right high-beam lamp is malfunctioning.</p> <ul style="list-style-type: none"> ► Halogen headlamp: Replace the bulb as soon as possible (► page 318). ► Bi-Xenon headlamp: Contact an authorized Mercedes-Benz Center as soon as possible.
 <p>Check Left License Plate Lamp or Check Right License Plate Lamp</p>	<p>The left or right license plate lamp is malfunctioning.</p> <ul style="list-style-type: none"> ► Contact an authorized Mercedes-Benz Center as soon as possible.

Display messages		Possible causes/consequences and ► Solutions
	Auto Lamp Function Inoperative	<p>The light sensor is malfunctioning. The headlamps come on automatically.</p> <p>► Contact an authorized Mercedes-Benz Center as soon as possible.</p> <p>To switch off the headlamps (U.S. vehicles only):</p> <p>► Switch off the daytime running lamp mode in the control system (► page 141).</p> <p>► Switch off the headlamps using the exterior lamp switch (► page 97).</p>
	Check Left Low Beam or Check Right Low Beam	<p>The left or right low-beam lamp is malfunctioning.</p> <p>► Halogen headlamp: Replace the bulb as soon as possible (► page 318).</p> <p>► Bi-Xenon headlamp: Contact an authorized Mercedes-Benz Center as soon as possible.</p>
	Check Rear Left Fog Lamp	<p>The rear fog lamp is malfunctioning. This message will only appear if all LEDs have stopped working.</p> <p>► Contact an authorized Mercedes-Benz Center as soon as possible.</p>
	Switch Off Lights	<p>You have removed the SmartKey from the starter switch, opened the driver's door and left the headlamps on or removed the SmartKey with KEYLESS-GO from the vehicle and left the headlamps on.</p> <p>► Turn the exterior lamp switch to <input type="checkbox"/> O or <input type="checkbox"/> A (► page 97).</p> <p>or</p> <p>► With the fog lamps switched on: Push in the exterior lamp switch to its stop.</p>
	Check Left Tail and Brake Lamps or Check Right Tail and Brake Lamps	<p>The left or right tail lamp/brake lamp is malfunctioning. This message will only appear if all LEDs have stopped working.</p> <p>► Contact an authorized Mercedes-Benz Center as soon as possible.</p>



Display messages	Possible causes/consequences and ► Solutions
 <p>Check Left Cornering Light or Check Right Cornering Light</p>	<p>The left or right corner-illuminating lamp is malfunctioning. ► Replace the bulb as soon as possible (▷ page 318).</p>
 <p>Check Rear Left Turn Signal or Check Rear Right Turn Signal</p>	<p>The left or right rear turn signal lamp is malfunctioning. ► Contact an authorized Mercedes-Benz Center as soon as possible.</p>
 <p>Check Front Left Turn Signal or Check Front Right Turn Signal</p>	<p>The left or right front turn signal lamp is malfunctioning. ► Replace the bulb as soon as possible (▷ page 318).</p>
 <p>Check Left Mirror Turn Signal or Check Right Mirror Turn Signal</p>	<p>The turn signal in the left or right exterior rear view mirror is malfunctioning. This message will only appear if all LEDs have stopped working. ► Contact an authorized Mercedes-Benz Center as soon as possible.</p>

امداد خودرو فارما

تلفن شبانه روزی: ۰۸۵۰۸۸۸۸۸۸۸۸

FarmaSOS.com

Tires

Display messages	Possible causes/consequences and ► Solutions
 <p>Tire Press. Warning Caution Tire Malfunction</p>	<p>At least one tire is deflating.</p> <ul style="list-style-type: none"> ► Carefully bring the vehicle to a halt, avoiding abrupt steering and braking maneuvers. ► If necessary, change the wheel (► page 323).
 <p>Check Tire Pressure</p>	<p>The tire inflation pressure in at least one tire is significantly below the reference value.</p> <ul style="list-style-type: none"> ► Carefully bring the vehicle to a halt, avoiding abrupt steering and braking maneuvers. ► Check and adjust tire inflation pressure as required. ► If necessary, change the wheel (► page 323).

 **Warning!**

Do not drive with a flat tire. A flat tire affects the ability to steer or brake the vehicle. You may lose control of the vehicle. Continued driving with a flat tire will cause excessive heat build-up and possibly a fire.

 **Warning!**

Follow recommended tire inflation pressures.

Do not underinflate tires. Underinflated tires wear excessively and/or unevenly, adversely affect handling and fuel economy, and are more likely to fail from being overheated.

Do not overinflate tires. Overinflated tires can adversely affect handling and ride comfort, wear unevenly, increase stopping distance, and result in sudden deflation (blowout) because they are more likely to become punctured or damaged by road debris, potholes etc.

What to do if ...





Lamps in instrument cluster







Notes

If any of the following lamps in the instrument cluster fails to come on during the bulb self-check when switching on the ignition, have the respective bulb checked and replaced if necessary.

When you switch on the ignition, all lamps in the instrument cluster come on. The low-beam headlamp indicator lamp, high-beam headlamp indicator lamp, turn signal indicator lamps, and the indicator lamps for the fog lamps will only come on if activated. If a lamp in the instrument cluster fails to come on when the ignition is switched on, have it checked and replaced if necessary.

Brake

Problem	Possible causes/consequences and ► Solutions
 <p>The yellow ABS indicator lamp comes on while the engine is running.</p>	<p>The brake system is still functioning normally but due to a malfunction, the ABS, the BAS, the BAS PLUS, the ESC, the hill-start assist system, the HOLD function, the PRE-SAFE® system, and the PRE-SAFE® Brake are unavailable. The ATTENTION ASSIST is disabled.</p> <ul style="list-style-type: none"> ► Continue driving with added caution. Wheels may lock during hard braking, reducing steering capability. ► Adjust driving to be consistent with reduced braking responsiveness. ► Read and observe messages that may appear in the multifunction display (► page 272). ► Have the system checked at an authorized Mercedes-Benz Center as soon as possible. <p>Failure to follow these instructions increases the risk of an accident.</p>
   <p>The yellow ESC warning lamp, the yellow ESC OFF warning lamp, and the yellow ABS indicator lamp come on while the engine is running and an acoustic warning sounds.</p>	<p>The Electronic Brake Proportioning (EBP) switched off due to a malfunction.</p> <p>The ABS, the BAS, the BAS PLUS, the ESC, the hill-start assist system, the HOLD function, the PRE-SAFE® system, and the PRE-SAFE® Brake are also switched off.</p> <p>The brake system is still functioning normally but without the systems specified above available. The ATTENTION ASSIST is disabled.</p> <ul style="list-style-type: none"> ► Continue driving with added caution. Wheels may lock during hard braking, reducing steering capability. ► Adjust driving to be consistent with reduced braking responsiveness. ► Read and observe messages that may appear in the multifunction display (► page 272). ► Have the system checked at an authorized Mercedes-Benz Center as soon as possible. <p>Failure to follow these instructions increases the risk of an accident.</p>

Problem	Possible causes/consequences and ► Solutions
<p> (USA only)  (Canada only)</p> <p>The red brake warning lamp comes on while driving.</p>	<p>The brake system is malfunctioning. Braking characteristics may be impaired. Risk of accident!</p> <ul style="list-style-type: none"> ► Do not drive any further. Stop the vehicle in a safe location as soon as it is safe to do so. ► Engage the parking brake. ► Read and observe messages that may appear in the multifunction display (▷ page 272). ► Contact an authorized Mercedes-Benz Center.
<p> (USA only)  (Canada only)</p> <p>The red brake warning lamp comes on while driving and an acoustic warning sounds.</p>	<p>You are driving with the parking brake engaged.</p> <ul style="list-style-type: none"> ► Release the parking brake.
<p> (USA only)  (Canada only)</p> <p>The red brake warning lamp comes on while the engine is running and an acoustic warning sounds.</p>	<p>There is insufficient brake fluid in the reservoir. Risk of accident!</p> <ul style="list-style-type: none"> ► Do not drive any further. Stop the vehicle in a safe location as soon as it is safe to do so. ► Engage the parking brake. <i>تلفن شماره روزی</i> ► Read and observe messages that may appear in the multifunction display (▷ page 272). ► Contact an authorized Mercedes-Benz Center. <p>Do not add brake fluid! This will not solve the problem.</p>





Warning!

Driving with the brake warning lamp illuminated can result in an accident. Have your brake system checked immediately if the brake warning lamp stays on. Do not add brake fluid before checking the brake system. Overfilling the brake fluid reservoir can result in spilling brake fluid on hot engine parts and

the brake fluid catching fire. You can be seriously burned.

- If you find that the brake fluid in the brake fluid reservoir has fallen to the minimum mark or below, have the brake system checked for brake pad thickness and leaks.

Safety systems

Problem	Possible causes/consequences and ► Solutions
 The red seat belt telltale comes on for a maximum of 6 seconds after starting the engine.	<p>The seat belt telltale reminds you and your passengers to fasten your seat belts before driving off.</p> <p>► Fasten your seat belts.</p> <p>Regardless of whether the seat belts are fastened or not, the seat belt telltale always comes on and remains lit for 6 seconds after starting the engine.</p>
 The red seat belt telltale comes on. In addition you hear a warning chime for a maximum of 6 seconds after starting the engine.	<p>You have forgotten to fasten your seat belt.</p> <p>► Fasten your seat belt. The warning chime stops sounding.</p>
 The red seat belt telltale comes on while the vehicle is standing still and the engine is running or while driving.	<p>You and/or your front passenger have forgotten to fasten your seat belts.</p> <p>► Fasten your seat belts. The seat belt telltale goes out. <small>تلفن شب</small></p> <p>There are items placed on the front passenger seat and therefore the system senses the front passenger seat as being occupied.</p> <p>► Remove the items from the front passenger seat and put them in a safe place. The seat belt telltale goes out.</p>
 The red seat belt telltale flashes while driving. In addition, an intermittent warning chime sounds with increasing intensity.	<p>The vehicle's speed once exceeded 15 mph (25 km/h) and you and/or your front passenger have forgotten to fasten your seat belts.</p> <p>► Fasten your seat belts. The seat belt telltale goes out and the warning chime stops sounding.</p> <p>There are items placed on the front passenger seat and therefore the system senses the front passenger seat as being occupied.</p> <p>► Remove the items from the front passenger seat and put them in a safe place. The seat belt telltale goes out and the warning chime stops sounding.</p>

- i** After 60 seconds with an unfastened seat belt the warning chime stops sounding and the seat belt telltale illuminates continuously. The seat belt telltale will only go out if both, the driver and front passenger's seat belt are fastened, or the vehicle is standing still and a front door is opened.



Problem	Possible causes/consequences and ► Solutions
 The red SRS indicator lamp comes on while driving.	There is a malfunction in the restraint systems. The air bags or Emergency Tensioning Devices (ETDs) could deploy unexpectedly or fail to activate in an accident. <ul style="list-style-type: none"> ► Drive with added caution to the nearest authorized Mercedes-Benz Center.



Warning!

In the event a malfunction of the SRS is indicated as outlined above, the SRS may not be operational.

For your safety, we strongly recommend that you contact an authorized Mercedes-Benz

Center immediately to have the system checked. Otherwise the SRS may not be activated when needed in an accident, which could result in serious or fatal injury, or it might deploy unexpectedly and unnecessarily which could also result in injury.

Problem	Possible causes/consequences and ► Solutions
 The yellow ESC OFF warning lamp comes on while the engine is running.	The ESC has been switched off. Risk of accident! When the ESC is switched off it will not stabilize the vehicle if the system recognizes that the vehicle starts to skid or that a wheel is spinning. <ul style="list-style-type: none"> ► Switch the ESC back on. Exceptions: All models except E 63 AMG (► page 66), E 63 AMG (► page 68). ► If leaving the ESC switched off, adapt your speed and driving to the prevailing road and weather conditions. ► If the ESC cannot be switched back on: Have the system checked at an authorized Mercedes-Benz Center as soon as possible.
 E 63 AMG only: The yellow ESC SPORT warning lamp comes on while the engine is running.	ESC SPORT is activated. Risk of accident! When ESC SPORT is activated it will only stabilize the vehicle to a limited extent if the system recognizes that the vehicle starts to skid or that a wheel is spinning. <ul style="list-style-type: none"> ► Switch the ESC SPORT off (► page 67). The message ESC-ON appears in the multifunction display.

Problem	Possible causes/consequences and ► Solutions
 The yellow ESC warning lamp and the yellow ESC OFF warning lamp come on while the engine is running.	<p>The ESC is not operational due to a malfunction.</p> <p>The ABS, the BAS, the BAS PLUS, the hill-start assist system, the HOLD function, the PRE-SAFE® system, and the PRE-SAFE® Brake are also switched off.</p> <p>The brake system is still functioning normally but without the systems specified above available.</p> <p>The ATTENTION ASSIST is disabled.</p> <ul style="list-style-type: none"> ► Read and observe additional messages that may appear in the multifunction display. ► Continue driving with added caution. Wheels may lock during hard braking, reducing steering capability. ► Adapt your speed and driving to the prevailing road and weather conditions. ► Have the system checked at an authorized Mercedes-Benz Center as soon as possible. <p>Failure to follow these instructions increases the risk of an accident.</p>
 The yellow ESC warning lamp flashes while driving.	<p>The ESC or the ETS has come into operation because of detected traction loss in at least one tire.</p> <ul style="list-style-type: none"> ► When driving off, apply as little throttle as possible. ► While driving, ease up on the accelerator pedal. ► Adapt your speed and driving to the prevailing road and weather conditions. ► Do not deactivate the ESC. <p>Exceptions: All models except E 63 AMG (► page 66), E 63 AMG (► page 68).</p> <p>Failure to follow these instructions increases the risk of an accident.</p>



Driving systems



Problem	Possible causes/consequences and ► Solutions
 The red distance warning lamp comes on while driving and an acoustic warning sounds.	<p>You are gaining too rapidly on the vehicle ahead of you or DISTRONIC PLUS or PRE-SAFE® Brake has recognized a stationary obstacle on your probable line of travel.</p> <ul style="list-style-type: none"> ► Apply the brakes immediately. ► Carefully observe the traffic situation. You may need to brake or maneuver to avoid hitting an obstacle.

Vehicle

Problem	Possible causes/consequences and ► Solutions
 The yellow fuel tank reserve warning lamp comes on when the engine is running.	<p>The fuel level has gone below the reserve mark.</p> <p>► Refuel at the next gas station.</p>

Engine

Problem	Possible causes/consequences and ► Solutions
 The yellow engine malfunction indicator lamp comes on when the engine is running.	<p>There may be a malfunction in</p> <ul style="list-style-type: none"> • the fuel management system • the ignition system (gasoline engine) • the emission control system • systems which affect emissions <p>Such malfunctions may result in excessive emissions values and may switch the engine to limp-home (emergency operation) mode.</p> <p>► Have the vehicle checked as soon as possible at an authorized Mercedes-Benz Center.</p> <p>i Some states may by law require you to visit a workshop as soon as the engine malfunction indicator lamp comes on. Check local requirements.</p>
 The yellow engine malfunction indicator lamp comes on when the engine is running.	<p>A loss of pressure has been detected in the fuel system. The fuel cap may not be closed properly or the fuel system may be leaky.</p> <p>► Check the fuel cap (> page 220).</p> <p>► If it is not closed properly: Close the fuel cap.</p> <p>► If it is closed properly: Have the fuel system checked by an authorized Mercedes-Benz Center.</p> <p>Diesel engine: Your fuel tank was driven empty.</p> <p>► After refueling, start, turn off and restart the engine three or four times in succession.</p> <p>The limp-home mode is canceled. You do not need to have your vehicle checked.</p>

Problem	Possible causes/consequences and ► Solutions
 The red coolant temperature warning lamp comes on when the engine is running.	<p>There is insufficient coolant in the reservoir.</p> <p>If this warning lamp comes on frequently, there is a leak in the cooling system.</p> <p>If the coolant level is correct, the electric radiator fan may be broken.</p> <ul style="list-style-type: none"> ► Immediately add coolant to prevent engine from overheating (► page 226). ► Have the cooling system checked. ► If the coolant temperature is below 248°F (120°C), you can continue driving to the nearest authorized Mercedes-Benz Center. ► Avoid high engine loads (e.g. driving uphill) and stop-and-go driving.
 The red coolant temperature warning lamp comes on when the engine is running and an acoustic warning sounds.	<p>The coolant temperature has exceeded 248°F (120°C).</p> <ul style="list-style-type: none"> ► Stop in a safe location as soon as possible and allow the engine and coolant to cool down.

Warning!



Driving when your engine is overheated can cause some fluids which may have leaked into the engine compartment to catch fire. You could be seriously burned.

Steam from an overheated engine can cause serious burns which can occur just by opening the engine hood. Stay away from the engine if you see or hear steam coming from it.

Stop the vehicle in a safe location away from other traffic. Turn off the engine, get out of the vehicle and do not stand near the vehicle until the engine has cooled down.

! The engine should not be operated with the coolant temperature above 248°F (120°C). Doing so may cause serious damage which is not covered by the Mercedes-Benz Limited Warranty.

Tires

Problem	Possible causes/consequences and ► Solutions
<p> USA only: Combination low tire pressure telltale/TPMS malfunction telltale for the Advanced TPMS illuminates continuously.</p> <p>Canada only: Low tire pressure telltale for the Advanced TPMS illuminates continuously.</p>	<p>The Advanced TPMS detects a loss of pressure in at least one tire.</p> <ul style="list-style-type: none"> ► Carefully bring the vehicle to a halt, avoiding abrupt steering and braking maneuvers. Observe the traffic situation around you. ► Read and observe messages in the multifunction display (► page 272). <p>If the tire inflation pressure in the respective tire(s) has (have) been corrected, the combination low tire pressure/TPMS malfunction telltale goes out after a few minutes of driving.</p>
<p> USA only: Combination low tire pressure telltale/TPMS malfunction telltale for the Advanced TPMS flashes 60 seconds and then stays illuminated.</p>	<p>There is a malfunction in the Advanced TPMS.</p> <ul style="list-style-type: none"> ► Read and observe messages in the multifunction display (► page 272). ► Have the Advanced TPMS checked at an authorized Mercedes-Benz Center. <p>After the malfunction has been remedied, the combination low tire pressure/TPMS malfunction telltale goes out after a few minutes of driving.</p>

 **Warning!**

Each tire, including the spare (if provided), should be checked at least once a month when cold and inflated to the inflation pressure recommended by the vehicle manufacturer on the Tire and Loading Information placard on the driver's door B-pillar or the tire inflation pressure label on the inside of the fuel filler flap. If your vehicle has tires of a different size than the size indicated on the Tire and Loading Information placard or the tire inflation pressure label, you should

determine the proper tire inflation pressure for those tires.

As an added safety feature, your vehicle has been equipped with a tire pressure monitoring system (TPMS) that illuminates a low tire pressure telltale when one or more of your tires are significantly underinflated.

Accordingly, when the low tire pressure telltale illuminates, you should stop and check your tires as soon as possible, and inflate them to the proper pressure. Driving on a significantly underinflated tire causes the tire to overheat and can lead to tire failure.



Underinflation also reduces fuel efficiency and tire tread life, and may affect the vehicle's handling and stopping ability. Please note that the TPMS is not a substitute for proper tire maintenance, and it is the driver's responsibility to maintain correct tire pressure, even if underinflation has not reached the level to trigger illumination of the TPMS low tire pressure telltale.

USA only:

Your vehicle has also been equipped with a TPMS malfunction indicator to indicate when the system is not operating properly. The TPMS malfunction indicator is combined with the low tire pressure telltale. When the system detects a malfunction, the telltale will flash for approximately 1 minute and then

remain continuously illuminated. This sequence will continue upon subsequent vehicle start-ups as long as the malfunction exists. When the malfunction indicator is illuminated, the system may not be able to detect or signal low tire pressure as intended. TPMS malfunctions may occur for a variety of reasons, including the installation of incompatible replacement or alternate tires or wheels on the vehicle that prevent the TPMS from functioning properly. Always check the TPMS malfunction telltale after replacing one or more tires or wheels on your vehicle to ensure that the replacement or alternate tires and wheels allow the TPMS to continue to function properly.

Lamp in center console

Problem	Possible causes/consequences and ► Solutions
<p>Canada only:</p>  <p>The front passenger front air bag off indicator lamp illuminates and remains illuminated (> page 47).</p>	<p>A BabySmart™ child seat is installed on the front passenger seat. Therefore the front passenger front air bag is switched off.</p> <p>The system is malfunctioning when there is no BabySmart™ child seat installed on the front passenger seat.</p> <ul style="list-style-type: none"> ► Have the system checked as soon as possible at an authorized Mercedes-Benz Center.
<p>Canada only:</p>  <p>The front passenger front air bag off indicator lamp does not illuminate or does not remain illuminated with a BabySmart™ child seat properly installed on the passenger seat.</p>	<p>The system is malfunctioning.</p> <ul style="list-style-type: none"> ► Make sure there is nothing between seat cushion and child seat. ► Check installation of the child seat (> page 58). <p>If the front passenger front air bag off indicator lamp remains out:</p> <ul style="list-style-type: none"> ► Have the system checked as soon as possible at an authorized Mercedes-Benz Center. <p>Do not use the BabySmart™ restraint to transport children on the front passenger seat until the system has been repaired.</p>

Problem	Possible causes/consequences and ► Solutions
USA only:  The front passenger front air bag off indicator lamp illuminates and remains illuminated with the weight of a typical adult or someone larger than a small individual on the front passenger seat.	The system is malfunctioning. <ul style="list-style-type: none"> ► Have the system checked as soon as possible at an authorized Mercedes-Benz Center. ► Read and observe messages in the multifunction display and follow corrective steps (► page 272).

Warning!

If the  indicator lamp illuminates and remains illuminated with the weight of a typical adult or someone larger than a small

individual on the front passenger seat, do not have any passenger use the front passenger seat until the system has been repaired.

Problem	Possible causes/consequences and ► Solutions
USA only:  The front passenger front air bag off indicator lamp does not illuminate and/or does not remain illuminated with the weight of a typical 12-month-old child in a standard child restraint or less on the front passenger seat.	The system is malfunctioning. <ul style="list-style-type: none"> ► Make sure there is nothing between seat cushion and child seat and check installation of the child seat. ► Make sure no objects applying supplemental weight onto the seat are present. ► If the front passenger front air bag off indicator lamp remains out, have the system checked as soon as possible at an authorized Mercedes-Benz Center. Do not transport a child on the front passenger seat until the system has been repaired. ► Read and observe messages in the multifunction display and follow corrective steps (► page 272).

Warning!

If the  indicator lamp does not illuminate or remains out with the weight of a typical 12-month-old child in a standard child restraint or less on the front passenger seat, do not transport a child on the front passenger seat until the system has been repaired.

Unlocking/locking manually

Unlocking the vehicle

If you cannot unlock the vehicle with the SmartKey or with KEYLESS-GO, unlock the driver's door and the trunk using the mechanical key.

The anti-theft alarm system will trigger when you

- unlock the driver's door or the trunk with the mechanical key and
- open the driver's door or the trunk

To cancel the alarm, insert the SmartKey into the starter switch.

Removing the mechanical key

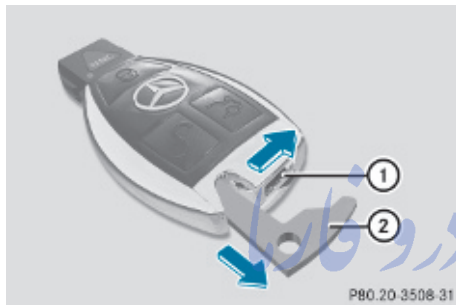

- ▶ Move locking tab ① in the direction of arrow.
- ▶ Slide mechanical key ② out of the housing.

Unlocking the driver's door

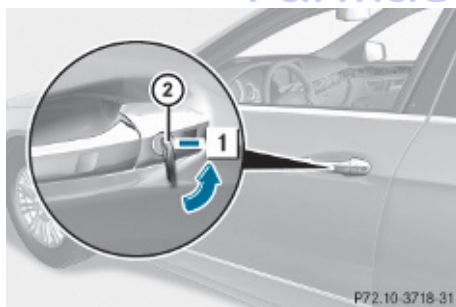

- ▶ Insert mechanical key ② into the driver's door lock.
- ▶ Turn mechanical key ② counterclockwise to position 1.

- ▶ Pull the door handle to open the driver's door.
- ▶ Turn mechanical key ② back and remove it from the driver's door lock.

Unlocking the trunk

A minimum height clearance of 5.78 ft (1.76 m) is required to open the trunk lid.

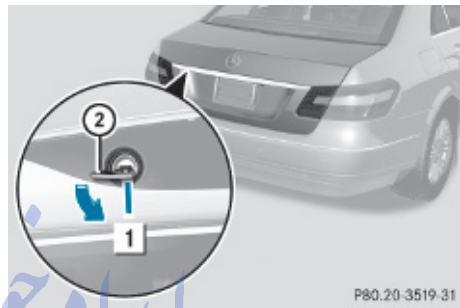

- ▶ Insert mechanical key ② into the trunk lid lock.
- ▶ Turn mechanical key ② counterclockwise to position 1.

! When you open the trunk, the trunk lid swings open upwards. Always make sure there is sufficient overhead clearance.

- ▶ Turn mechanical key ② back and remove it from the trunk lid lock.

Locking the vehicle

If you cannot lock the vehicle with the SmartKey or with KEYLESS-GO, lock it as follows:

- ▶ Open the driver's door.
- ▶ Close the front passenger door, the rear doors, and the trunk.
- ▶ Press the central locking switch (▷ page 81).
The locking knobs of the front passenger door and the rear doors move down.
- ▶ **If the vehicle battery is disconnected or drained:** Press down the locking knobs on

the front passenger door and the rear doors.

- ▶ Exit the vehicle.
- ▶ Close the driver's door.

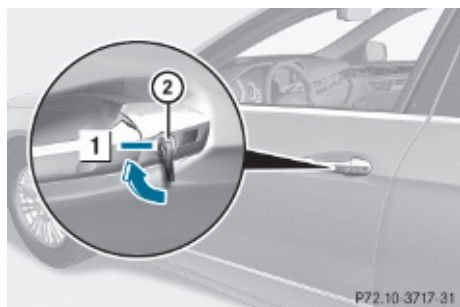

- ▶ Remove mechanical key ② from the SmartKey (▷ page 315).
- ▶ Insert mechanical key ② into the driver's door lock.
- ▶ Turn mechanical key ② clockwise to position ①. The vehicle is locked.
- ▶ Turn mechanical key ② back and remove it from the driver's door lock.
- ▶ Check whether the doors and the trunk are locked.
- ▶ If necessary, lock the trunk with the mechanical key (▷ page 85).

i This procedure does not arm the anti-theft alarm system, nor does it lock the fuel filler flap.

Fuel filler flap

⚠ Warning!

Avoid contact with the vehicle walls as they may contain sharp edges. Otherwise, you could injure yourself while releasing the fuel filler flap.

In case the central locking system does not release the fuel filler flap, you can open it manually.

The fuel filler flap release is located on the passenger side in the trunk behind the cover.

- ▶ Open the trunk (▷ page 81).
- ▶ Push the parcel net down.
- ▶ Open the cover (▷ page 268).

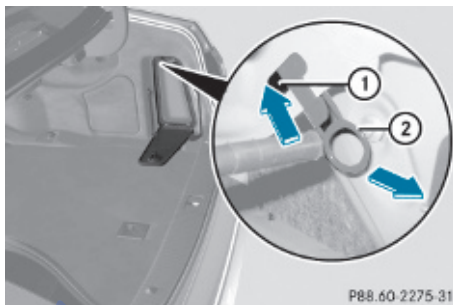

- ▶ Remove fuel filler flap release ② from holder ①.
- ▶ Pull fuel filler flap release ② in direction of the arrow.
- ▶ Open the fuel filler flap (▷ page 220).
- ▶ Close the cover.
- ▶ Close the trunk.

Resetting activated NECK-PRO active front head restraints

If the NECK-PRO active front head restraints have been triggered in a rear-end collision, they must be reset.

You can tell that the NECK-PRO active front head restraints have been triggered when they have been moved forward and cannot be adjusted.

⚠ Warning!

For safety reasons, have the NECK-PRO active front head restraints checked at an authorized Mercedes-Benz Center after a rear-end collision.

Warning!

When pushing back the head restraint cushion, make sure your fingers do not become caught between the head restraint cushion and the cover. Failing to do so may lead to injury.

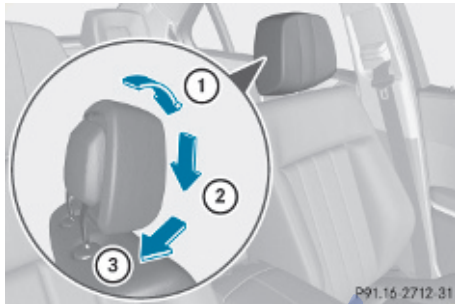

- ▶ Pull the top of the head restraint cushion in direction of arrow ① as far as it will go.
- ▶ Adjust the head restraint cushion downward in direction of arrow ② as far as it will go.
- ▶ Firmly press the top of the head restraint cushion towards the head restraint cover in direction of arrow ③ until it engages.
- ▶ Repeat this procedure on the NECK-PRO active front head restraint for the second front seat.

For information on NECK-PRO active front head restraints, see “NECK-PRO active front head restraints” (▷ page 54).

Replacing SmartKey batteries

If the batteries in the SmartKey are discharged, the vehicle can no longer be locked or unlocked. It is recommended to have the batteries replaced at an authorized Mercedes-Benz Center.

Warning!

Batteries contain poisonous and corrosive substances. Therefore, keep the batteries out of reach of children.

If a battery is swallowed, seek medical help immediately.

Warning!

SmartKey batteries contain perchlorate material, which may require special handling and regard for the environment. Check with your local government’s disposal guidelines. California residents, see www.dtsc.ca.gov/HazardousWaste/Perchlorate/index.cfm.

Batteries contain materials that can harm the environment if disposed of improperly. Recycling of batteries is the preferred method of disposal. Many states (USA only) or provinces (Canada only) require sellers of batteries to accept old batteries for recycling. When inserting the batteries, make sure they are clean and free of lint.

When replacing batteries, always replace both batteries.

i The required replacement batteries are available at any authorized Mercedes-Benz Center.

Replacement batteries: Lithium, type CR 2025 or equivalent.

- ▶ Remove the mechanical key from the SmartKey (▷ page 315).

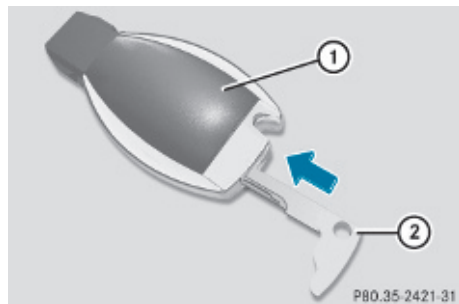

- ▶ Press mechanical key ② into the SmartKey opening until battery compartment cover ① opens. Do not keep the cover shut.

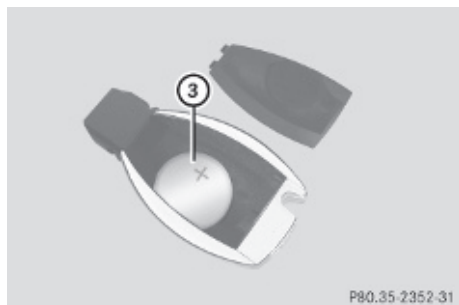

- ▶ Remove the battery compartment cover.
- ▶ Pat the SmartKey against the palm of your hand until battery ③ falls out.
- ▶ Insert the new battery with the positive terminal (+) facing up. Use a lint-free cloth.
- ▶ Insert the tabs of the battery compartment cover into the housing and press the cover closed.
- ▶ Check the operation of the SmartKey as well as the KEYLESS-GO function.

Replacing bulbs

Safety notes

Safe vehicle operation depends on proper exterior lighting and signaling to a large degree.

Correct headlamp adjustment is extremely important. Have headlamps checked and readjusted at regular intervals and when a bulb has been replaced. Contact an authorized Mercedes-Benz Center for headlamp adjustment.

⚠ Warning!

Bulbs and bulb sockets can be very hot. Allow the lamp to cool down before changing a bulb.

Keep bulbs out of reach of children.

Halogen lamps contain pressurized gas. A bulb can explode if you

- touch or move it when hot
- drop the bulb
- scratch the bulb

Wear eye and hand protection.

Because of high voltage in Xenon lamps, it is dangerous to replace the bulb or repair the lamp and its components. We recommend that you have such work done by a qualified technician.

- ❗ Since replacing bulbs is a technically highly demanding process, we recommend to have them replaced at an authorized Mercedes-Benz Center.

- ❗ If the headlamps or front fog lamps are fogged up on the inside as a result of high humidity, driving the vehicle a distance with the lights on should clear up the fogging.

Bulbs

You can replace the following bulbs yourself:

Halogen headlamps

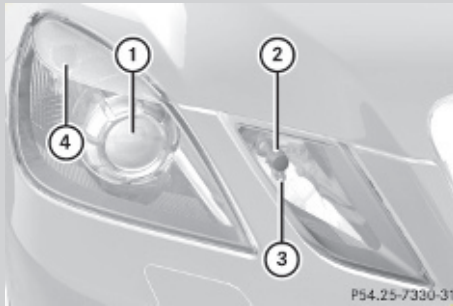

Type

- ① Low-beam lamp: H7 55 W
- ② High-beam lamp: H7 55 W
- ③ Parking and standing lamp: W 5 W
- ④ Turn signal lamp: 3457A

Bi-Xenon headlamps



Type

- ① Corner-illuminating lamp: H7 55 W
- ② IR emitter (for Night View Assist Plus): H11 55 W

Notes on bulb replacement

! Do not replace LEDs or bulbs not described in this section. You could otherwise damage the LEDs, the bulbs or parts of the vehicle. Only have the LEDs and bulbs replaced at an authorized Mercedes-Benz Center.

⚠ Observe Safety notes, see page 318.

- Only use 12-volt bulbs of the same type and with the specified watt rating.
- Switch the lights off before changing a bulb to prevent short circuits.
- Always use a clean lint-free cloth when handling bulbs.

- Your hands should be dry and free of oil and grease.
- If the newly installed bulb does not come on, contact an authorized Mercedes-Benz Center.
- i** Mercedes-Benz recommends using Longlife (LL) bulbs.

Replacing bulbs for front lamps

⚠ Warning!

Do not remove the cover for the Bi-Xenon headlamp. Because of high voltage in Xenon lamps, it is dangerous to replace the bulb or repair the lamp and its components. It is

recommended to have such work done by a qualified technician.

Before you start to replace a bulb for a front lamp, do the following:

- ▶ Switch off the ignition.
- ▶ Turn the exterior lamp switch to position **0**.
- ▶ Open the hood (▷ page 223).

Releasing/fixing the washer fluid reservoir

To replace bulbs of the driver's side headlamp, the washer fluid reservoir in the engine compartment must be released.

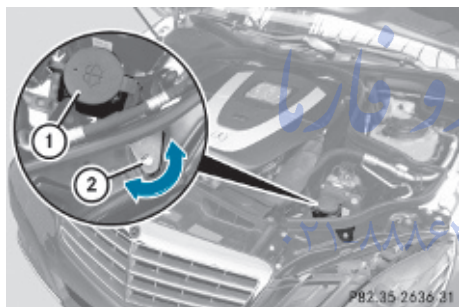

- ▶ **Releasing:** Turn screw (2) counterclockwise and remove it.
- ▶ Tilt washer fluid reservoir (1) to the side as far as necessary to access the headlamp bulbs.
- ▶ **Fixing:** Tilt washer fluid reservoir (1) back into fixing position.
- ▶ Fasten screw (2) by turning it clockwise.

Low beam (halogen headlamps only)

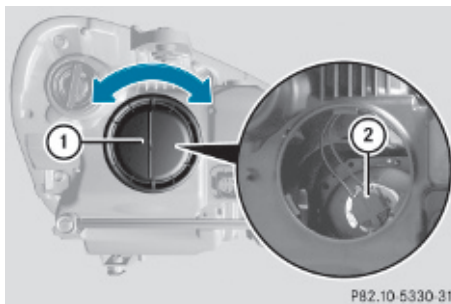

- ▶ Driver's side only: Release the washer fluid reservoir (▷ page 320).
- ▶ Turn housing cover (1) counterclockwise and remove it.
- ▶ Turn bulb socket (2) counterclockwise and pull it out.
- ▶ Pull the bulb out of bulb socket (2).
- ▶ Insert the new bulb into bulb socket (2).
- ▶ Insert bulb socket (2) into the housing and turn it clockwise.
- ▶ Align housing cover (1) and turn it clockwise.
- ▶ Driver's side only: Fix the washer fluid reservoir (▷ page 320).

High beam (halogen headlamps only) or Corner-illuminating lamp (Bi-Xenon headlamps only)

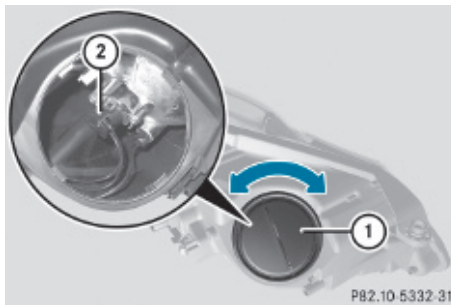

- ▶ Driver's side only: Release the washer fluid reservoir (▷ page 320).
- ▶ Turn housing cover ① counterclockwise and remove it.
- ▶ Turn bulb socket ② counterclockwise and pull it out.
- ▶ Pull the bulb out of bulb socket ②.
- ▶ Insert the new bulb into bulb socket ②.
- ▶ Insert bulb socket ② into the housing and turn it clockwise.
- ▶ Align housing cover ① and turn it clockwise.
- ▶ Driver's side only: Fix the washer fluid reservoir (▷ page 320).

Parking and standing lamp bulb (halogen headlamps only)

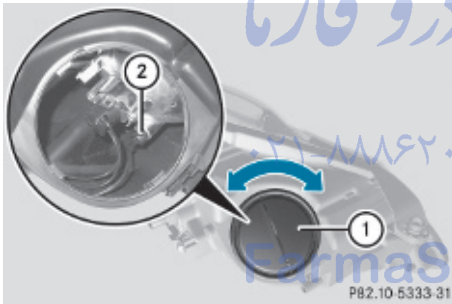

- ▶ Driver's side only: Release the washer fluid reservoir (▷ page 320).
- ▶ Turn housing cover ① counterclockwise and remove it.
- ▶ Pull out bulb socket ②.
- ▶ Pull the bulb out of bulb socket ②.
- ▶ Insert the new bulb into bulb socket ②.
- ▶ Insert bulb socket ②.
- ▶ Align housing cover ① and turn it clockwise.
- ▶ Driver's side only: Fix the washer fluid reservoir (▷ page 320).

IR emitter lamp bulb (Night View Assist Plus)

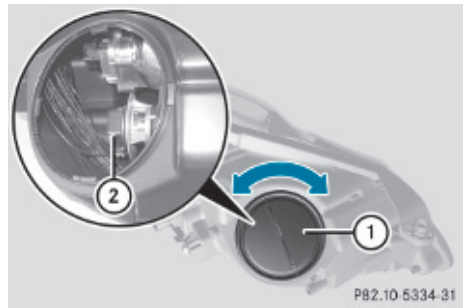

- ▶ Driver's side only: Release the washer fluid reservoir (▷ page 320).
- ▶ Turn housing cover ① counterclockwise and remove it.
- ▶ Turn bulb ② counterclockwise and pull it out.
- ▶ Insert bulb ② into the housing and turn it clockwise.
- ▶ Align housing cover ① and turn it clockwise.
- ▶ Driver's side only: Fix the washer fluid reservoir (▷ page 320).

Front turn signal lamp bulb (halogen headlamps only)

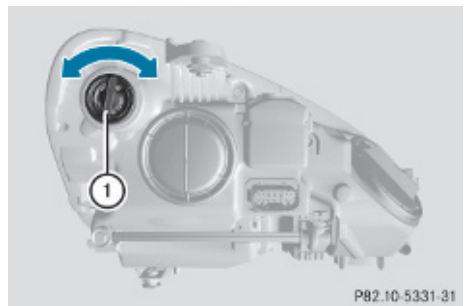

- ▶ Driver's side only: Release the washer fluid reservoir (▷ page 320).
- ▶ Turn bulb socket ① counterclockwise and pull it out.

- ▶ Turn the bulb counterclockwise with light pressure and pull it out of bulb socket ①.
- ▶ Insert the new bulb into bulb socket ① and turn the bulb clockwise.
- ▶ Insert bulb socket ① into the housing and turn it clockwise.
- ▶ Driver's side only: Fix the washer fluid reservoir (> page 320).

Replacing wiper blades

Safety notes

⚠ Warning!

For safety reasons, switch off the wipers and remove the SmartKey from the starter switch (vehicles with KEYLESS-GO: Make sure the vehicle's on-board electronics have status **0**) before replacing a wiper blade. Otherwise, the wiper motor could suddenly turn on and cause injury.

⚠ Warning!

Wiper blades are components that are subject to wear and tear. Replace the wiper blades twice a year, preferably in the spring and fall. Otherwise the windshield will not be wiped properly. As a result, you may not be able to observe surrounding traffic conditions and could cause an accident.

- ❗ Never open the hood when a wiper arm is folded forward.

Hold on to the wiper when folding a wiper arm back. If released, the force of the impact from the tensioning spring could crack the windshield.

Do not allow a wiper arm to contact the windshield glass without a wiper blade inserted.

Mercedes-Benz recommends that you have this work carried out at an authorized Mercedes-Benz Center.

- ▶ Remove the SmartKey from the starter switch.

Vehicles with KEYLESS-GO:

- ▶ Make sure the vehicle's on-board electronics have status **0** (> page 86).

Removing wiper blades

- ❗ Do not pull on the wiper blade inserts. They could tear.

- ▶ Fold the wiper arm forward until it snaps into place.



- ▶ Turn the wiper blade at a right angle to wiper arm.
- ▶ Slide the wiper blade sideways out of the retainer.

Installing wiper blades

- ▶ Slide the wiper blade onto the wiper arm until it locks in place.
- ▶ Rotate the wiper blade into a position parallel to the wiper arm.
- ▶ Fold the wiper arm backward to rest on the windshield. Make sure you hold on to the wiper when folding the wiper arm back.

Flat tire

Safety notes

Your vehicle may be equipped with:

- a Minispare wheel
- a spare wheel with collapsible tire
- an MOExtended system (your vehicle does not have a spare wheel or a TIREFIT kit)
- a TIREFIT kit¹⁹ (your vehicle does not have a spare wheel)

⚠ Warning!

The dimensions of the spare wheel are different from those of the road wheels. As a result, the vehicle handling characteristics change when driving with a spare wheel mounted. Adapt your driving style accordingly.

The spare wheel is for temporary use only. When driving with a spare wheel mounted, ensure proper tire inflation pressure and do not exceed a vehicle speed of 50 mph (80 km/h).

Contact the nearest authorized Mercedes-Benz Center as soon as possible to have the spare wheel replaced with a regular road wheel.

Never operate the vehicle with more than one spare wheel mounted.

Do not switch off the ESC when a spare wheel is mounted.

Preparing the vehicle

- ▶ Vehicles with AIRMATIC: Make sure the vehicle level is set to normal level (▷ page 163).
- ▶ Whenever possible, park the vehicle in a safe distance from moving traffic on a hard, flat surface.
- ▶ Turn on the hazard warning flasher.

- ▶ Turn the steering wheel so that the front wheels are in a straight-ahead position.
- ▶ Engage the parking brake.
- ▶ Shift the automatic transmission into park position **P**.
- ▶ Turn off the engine.
- ▶ Remove the SmartKey from the starter switch.

or

- ▶ Vehicles with KEYLESS-GO: Open the driver's door (this puts the starter switch in position **0**, same as with the SmartKey removed from the starter switch). The driver's door can then be closed again. Open doors only when conditions are safe to do so.
- ▶ Vehicles with KEYLESS-GO: Remove the KEYLESS-GO start/stop button from the starter switch.
- ▶ Have any passenger exit the vehicle at a safe distance from the roadway. Open doors only when conditions are safe to do so.

Mounting the spare wheel

Introduction

- ▶ Prepare the vehicle as described (▷ page 323).
- ▶ Take the following out of the vehicle:
 - spare wheel
 - jack
 - vehicle tool kit
 - collapsible wheel chock
 - electric air pump (required for vehicles with spare wheel with collapsible tire only)

For information on where to find the respective items, see "Where will I find ...?" (▷ page 268) and (▷ page 271).

¹⁹ Canada only.

i Vehicles without spare wheel are not factory-equipped with the tools required for a wheel change such as a jack or a wheel wrench. Some tools required for a wheel change are specific to your vehicle. Contact an authorized Mercedes-Benz Center to obtain the tools approved for your vehicle. This section describes the wheel change using the tools approved and recommended for your vehicle.

Lifting the vehicle

Warning!

When jacking up the vehicle, only use the jack which has been specifically approved by Mercedes-Benz for your vehicle.

The jack is designed exclusively for jacking up the vehicle at the jack take-up brackets built into both sides of the vehicle. Make sure the jack arm is fully seated in the jack take-up bracket. The jack must always be vertical when in use, especially on inclines or declines.

The jack is intended only for lifting the vehicle briefly for wheel changes. It is not suited for performing maintenance work under the vehicle. To help avoid personal injury, use the jack only to lift the vehicle during a wheel change.

Never get beneath the vehicle while it is supported by the jack. Keep hands and feet away from the area under the lifted vehicle. Always lower the vehicle onto sufficient capacity jackstands before working under the vehicle.

Always engage the parking brake firmly and block the wheels with wheel chocks or other sizeable objects before raising the vehicle with the jack. Do not disengage the parking brake while the vehicle is raised.

Make sure that the ground on which the vehicle is standing and where you place the jack is solid, level and not slippery. If necessary, use a large underlay. On slippery

surfaces, such as tiled floors, you should use a non-slip underlay, for example a rubber mat.

Do not use wooden blocks or similar objects to support the jack. Otherwise the jack may not be able to achieve its load-bearing capacity if it is not at its full height.

Never start the engine when the vehicle is raised.

Also observe the notes on the jack.

- ▶ Prevent the vehicle from rolling away by blocking wheels with wheel chocks or other sizeable objects.

When your vehicle is equipped with a wheel chock, it is included with the vehicle tool kit (▷ page 268). For information on setting up the collapsible wheel chock, see (▷ page 270).

When changing a wheel on a level surface:

- ▶ Place a wheel chock or other sizeable object in front of and another wheel chock or other sizeable object behind the wheel that is diagonally opposite to the wheel being changed.

Always try lifting the vehicle using the jack on a level surface. However, should circumstances require you to do so on a hill:

- ▶ Place wheel chocks or other sizeable objects on the downhill side in front of both wheels on the side opposite to the side on which the wheel is to be changed.

Warning!

Only jack up the vehicle on level ground or on slight inclines/declines. Otherwise, the vehicle could fall off the jack and injure you or others.

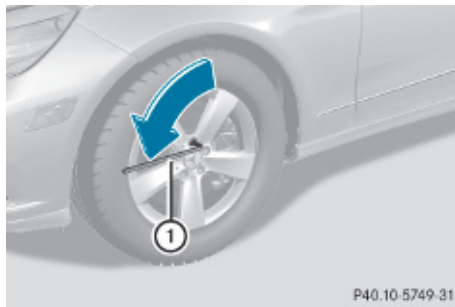

P40.10.5749.31

- ▶ On the wheel to be changed, loosen but do not yet remove the wheel bolts (approximately one full turn with wheel wrench ①).

The jack take-up brackets are located directly behind the front wheel housings and in front of the rear wheel housings.

E 63 AMG and vehicles with AMG

bodystyling: The respective cover in the door-sill trim must be removed to access the jack take-up brackets.

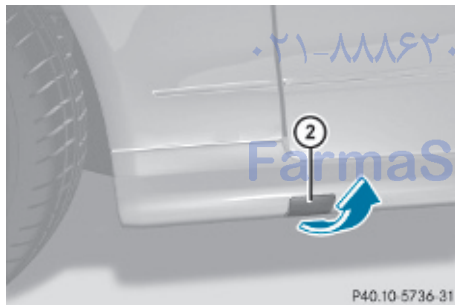

P40.10.5736.31

Example illustration: Vehicles with AMG bodystyling

- ▶ **E 63 AMG and vehicles with AMG bodystyling:** Remove cover ② in direction of arrow.

⚠ Warning!

The jack is designed exclusively for jacking up the vehicle at the jack take-up brackets. Make sure the jack arm is fully seated in the jack take-up bracket.

If you do not position the jack correctly in the jack take-up bracket, the vehicle can fall off

the jack and seriously or fatally injure you or others.

- ⚠ Do not position the jack on the body of the vehicle, as this may cause damage to the vehicle.

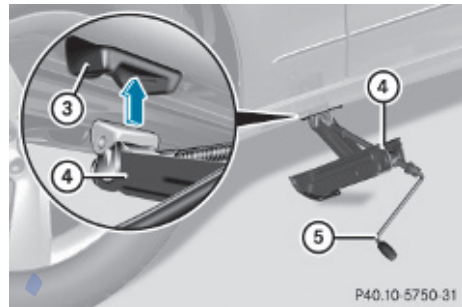

P40.10.5750.31

- ▶ Place jack ④ on firm ground.
- ▶ Position jack ④ under take-up bracket ③ so that it is always vertical as seen from the side, even if the vehicle is parked on an incline.

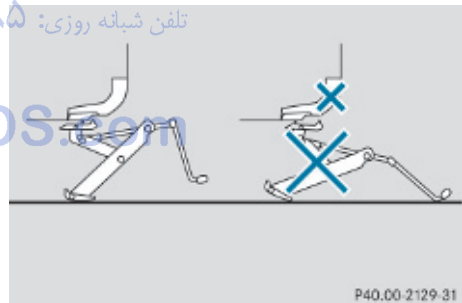

P40.00.2129.31

- ▶ Turn crank ⑤ clockwise until jack ④ is fully seated in take-up bracket ③ and the jack base evenly meets the ground.
- ▶ Jack up the vehicle until the wheel is a maximum of 1.2 in (3 cm) from the ground.

Removing the wheel

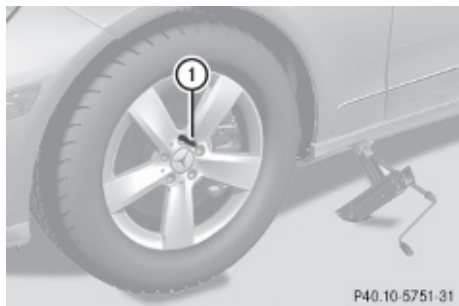

P40.10.5751.31

! **E 63 AMG with ceramic composite brake disk:** The rim could strike the ceramic composite brake disk when removing and attaching the spare wheel. The ceramic composite brake disk could be damaged. Exercise appropriate care and have a second person assist you if possible or use a second alignment bolt.

- ▶ Unscrew the uppermost wheel bolt and remove it.
- ▶ Replace this wheel bolt with alignment bolt ①.
- ▶ Remove the remaining bolts.

! Do not place wheel bolts in sand or dirt. This could result in damage to the wheel bolts and wheel hub threads.

- ▶ Remove the wheel.

Attaching the spare wheel

! Warning!

Vehicles with spare wheel with collapsible tire only: Inflate collapsible tire only after the wheel is properly attached.

Inflate the collapsible tire using the electric air pump before lowering the vehicle.

! Warning!

Always replace wheel bolts that are damaged or rusted.

Never apply oil or grease to wheel bolts.

Damaged wheel hub threads should be repaired immediately. Do not continue to drive under these circumstances! Contact an authorized Mercedes-Benz Center or call Roadside Assistance.

Incorrect wheel bolts or improperly tightened wheel bolts can cause the wheel to come off. This could cause an accident. Make sure to use the correct wheel bolts.

! Warning!

Only use genuine Mercedes-Benz wheel bolts. Other wheel bolts may come loose.

Do not tighten the wheel bolts when the vehicle is raised. Otherwise the vehicle could fall off the jack.

- ▶ Clean contact surfaces of wheel and wheel hub.

! To avoid paint damage, place wheel flat against hub and hold it there while installing first wheel bolt.

! **E 63 AMG with ceramic composite brake disk:** The rim could strike the ceramic composite brake disk when removing and attaching the spare wheel. The ceramic composite brake disk could be damaged. Exercise appropriate care and have a second person assist you if possible or use a second alignment bolt.

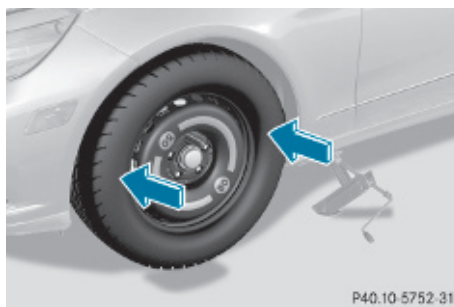

P40.10.5752.31

Example illustration: All models except E 63 AMG.

- ▶ Guide the spare wheel onto the alignment bolt and push it on.
- ▶ Insert the wheel bolts and tighten them slightly.
- ▶ Unscrew the alignment bolt.
- ▶ Install the last wheel bolt and tighten it slightly.
- ▶ **Vehicles with spare wheel with collapsible tire:** Continue the procedure by following the instructions under “Inflating the collapsible tire” (▷ page 327) and then “Lowering the vehicle” (▷ page 328).

or

- ▶ **Vehicles with Minispare wheel:** Continue the procedure by following the instructions under “Lowering the vehicle” (▷ page 328).

Inflating the collapsible tire

Warning!

Inflate collapsible tire only after the wheel is properly attached.

Inflate the collapsible tire using the electric air pump before lowering the vehicle.

Warning!

Observe safety instructions on air pump label.

- ! Do not lower the vehicle before inflating the collapsible tire. Otherwise the rim may be damaged.

Your vehicle may be equipped with either of two versions of the electric air pump:

- **Version 1:** The air hose with pressure gauge and the electrical plug are located behind a flap.
- **Version 2:** The pressure gauge is located in the pump housing. The air hose and electrical plug are located at the bottom of the pump housing.

The following description applies to both versions. Differences in usage are expressly declared.

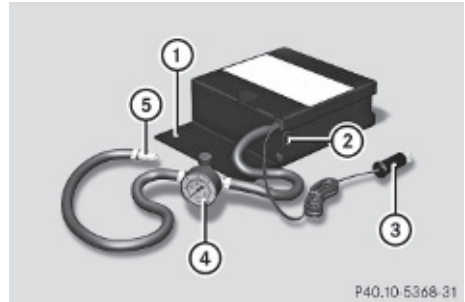

Version 1

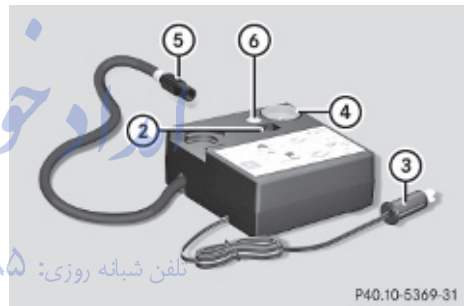

Version 2

- ▶ **Version 1 only:** Open flap ① on electric air pump.
- ▶ **Version 1 only:** Pull out electrical plug ③ and air hose with pressure gauge and vent screw ④.
- ▶ **Version 2 only:** Pull electrical plug ③ and the air hose out of the pump housing bottom.
- ▶ **Version 1 only:** Close vent screw on air hose ④.
- ▶ Remove the valve cap from the collapsible tire valve.
- ▶ Screw union nut ⑤ onto the collapsible tire valve.
- ▶ Make sure air pump switch ② is set to **0**.
- ▶ Insert electrical plug ③ into the cigarette lighter socket (▷ page 206) or a power outlet (▷ page 207).

- ▶ Turn the SmartKey in the starter switch to position **1**.

or

- ▶ Vehicles with KEYLESS-GO: Press the KEYLESS-GO start/stop button once. Do not depress the brake pedal.
- ▶ Press **I** on electric air pump switch (2). The electric air pump switches on and inflates the collapsible tire.
- ▶ Inflate the collapsible tire to the recommended tire inflation pressure as specified for your vehicle (▷ page 358). This should take approximately 5 minutes.

Warning!

The air hose and the union nut can become hot during inflation. Exercise proper caution to avoid burning yourself when using the equipment.

- !** Do not operate the electric air pump longer than 8 minutes without interruption. Otherwise it may overheat.

You may operate the air pump again after it has cooled off.

- !** Compare the recommended tire inflation pressure for your vehicle with the tire inflation pressure on the yellow label located on the spare wheel rim.

If the tire inflation pressure on the yellow label on the spare wheel rim differs from the values given in this Operator's Manual, inflate the tire to the recommended tire inflation pressure given on the yellow label on the spare wheel rim.

- ▶ Press **0** on electric air pump switch (2).
- ▶ Turn the SmartKey in the starter switch to position **0**.

or

- ▶ Vehicles with KEYLESS-GO: Press the KEYLESS-GO start/stop button twice. Do not depress the brake pedal.
- ▶ **Version 1 only:** If the tire inflation pressure is above the recommended tire inflation

pressure as specified for your vehicle (▷ page 358), decrease tire pressure using the vent screw on air hose (4).

- ▶ **Version 2 only:** If the tire inflation pressure is above the recommended tire inflation pressure as specified for your vehicle (▷ page 358), decrease tire pressure using deflate button (6).

Observe Safety notes, see page 231.

- ▶ Detach the electric air pump.
- ▶ Reinstall collapsible tire valve cap.
- ▶ **Version 1 only:** Store electrical plug (3) and air hose (4) behind flap (1).
- ▶ **Version 2 only:** Store electrical plug (3) and the air hose back into the pump housing bottom.
- ▶ Place the electric air pump back in its designated storage space.
- ▶ Lower the vehicle.

Lowering the vehicle

- ▶ Lower the vehicle by turning the crank counterclockwise until the vehicle is resting fully on its own weight.
- ▶ Remove the jack.

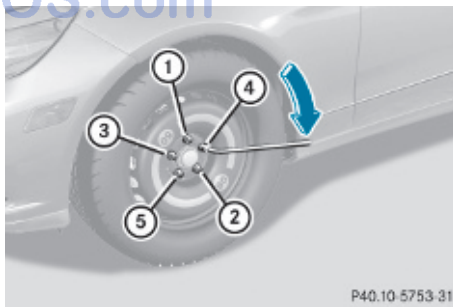

- ▶ Tighten the five wheel bolts evenly, following the diagonal sequence illustrated (1 to 5), until all bolts are tight. Observe a tightening torque of 96 lb-ft (130 Nm).

 **Warning!**

Have the tightening torque checked after changing a wheel. The wheels could come loose if they are not tightened to a torque of 96 lb-ft (130 Nm).

- ▶ Fully collapse the jack, with handle folded in (storage position), see (> page 270).
- ▶ Store the jack and the other vehicle tools in the designated storage space.
- ▶ **E 63 AMG and vehicles with AMG bodystyling:** Reinstall the respective cover of the door-sill trim.

 **Information:** Vehicles with Advanced TPMS:

Do not restart the Advanced TPMS until a full size wheel/tire with functioning sensor has been placed back into service on the vehicle.

- ▶ Do not exceed the maximum speed of 50 mph (80 km/h).

MOExtended system

The MOExtended system allows you to continue driving your vehicle even if there is a total loss of pressure in one or more tires. You may only use the MOExtended system in conjunction with the tire pressure loss warning system (> page 232) or the Advanced TPMS (> page 233).

The maximum distance in emergency mode depends on the vehicle's load. It is 50 miles (80 km) if the vehicle is partially loaded and 18 miles (30 km) if the vehicle is fully loaded. The point at which the maximum driving distance in emergency mode begins is when the warning message appears in the multifunction display indicating that there is a loss of tire inflation pressure.

- ▶ Do not exceed the maximum speed of 50 mph (80 km/h).

 **Warning!**

In emergency mode, your vehicle's driving characteristics are diminished in such situations as:

- driving around curves
- while braking
- while accelerating rapidly

Therefore, your driving style must be adapted accordingly. Avoid abrupt steering and driving maneuvers, as well as driving over obstacles (road curbs, potholes, or off-road areas). This is especially important if the vehicle is heavily loaded.

The emergency driving distance that can be achieved greatly depends on the demands placed on the vehicle. Depending on speed, load, driving maneuvers, road conditions, outside temperature, etc., the distance can be significantly shorter or, if the vehicle is driven cautiously, somewhat longer.

Do not continue driving in emergency mode if

- you notice knocking sounds
- the vehicle starts to shake
- smoke develops and you smell rubber
- ESC is intervening continuously
- you notice tears on the tire sidewalls

After driving in emergency mode, you must have the rims inspected by an authorized Mercedes-Benz Center to check if they are suitable for further use. The failed tire must be replaced in any case.

When replacing individual or all tires on the vehicle, make sure only tires marked with "MOExtended" are mounted in the size specified for your vehicle (> page 353).

Sealing tires with TIREFIT

This section applies to vehicles that are factory equipped²⁰ or retrofitted with a TIREFIT kit only.

²⁰ Canada only.

Small tire punctures, particularly those in the tread, can be sealed with TIREFIT.

TIREFIT can be used in ambient temperatures down to -4°F (-20°C).

⚠ Warning!

TIREFIT is a limited repair device. TIREFIT cannot be used for cuts or punctures larger than approximately 0.16 in (4 mm) and tire damage caused by driving with extremely low tire inflation pressure, or on a flat tire, or a damaged wheel.

Do not drive the vehicle under such circumstances.

Contact the nearest authorized Mercedes-Benz Center for assistance or call Roadside Assistance.

- ▶ Foreign objects (e.g. screws or nails) should not be removed from the tire.
- ▶ Take the TIREFIT kit, the sticker, and the electric air pump out of the vehicle.



Two-part sticker

- ▶ Attach upper part ① of the sticker where it will be easily seen by the driver on the instrument cluster.
- ▶ Attach lower part ② of the sticker to the damaged tire (close to the tire valve).

⚠ Warning!

Take care not to allow the contents of TIREFIT to come in contact with hair, eyes or clothing. TIREFIT is harmful if inhaled, swallowed or absorbed through the skin - causes skin, eye and respiratory irritation.

Any contact with eyes or skin should be flushed immediately with plenty of water.

If clothing comes in contact with TIREFIT, change clothing as soon as possible.

In case of allergic reaction or rash, consult a physician immediately.

⚠ Warning!

Keep TIREFIT out of reach of children. If swallowed, rinse mouth immediately with plenty of water and drink plenty of water.

Do not induce vomiting!

Consult a physician immediately.

- ❗ If sealant has leaked out, let it dry. You can then peel it off.

If clothing has come in contact with TIREFIT, have it dry-cleaned with perchloroethylene as soon as possible.

⚠ Warning!

Observe safety instructions on air pump label.

Your vehicle may be equipped with either of two versions of the electric air pump:

- **Version 1:** The air hose with pressure gauge and the electrical plug are located behind a flap.
- **Version 2:** The pressure gauge is located in the pump housing. The air hose and electrical plug are located at the bottom of the pump housing.

The following description applies to both versions. Differences in usage are expressly declared.

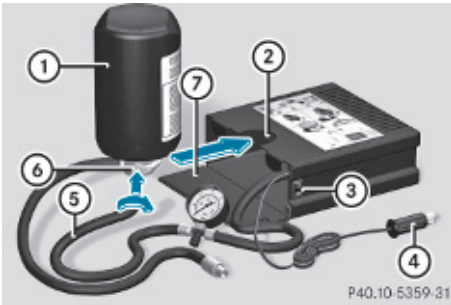

Version 1

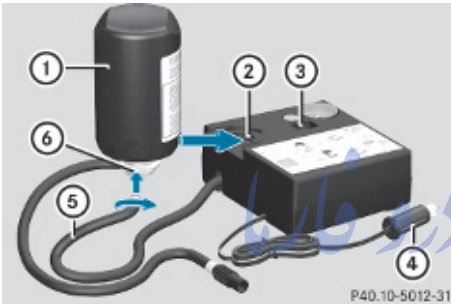

Version 2

- ▶ **Version 1 only:** Open flap ⑦ on the electric air pump.
- ▶ Pull plug ④ and air hose ⑤ out of the pump housing.
- ▶ Screw the air pump's air hose ⑤ onto flange ⑥ of TIREFIT container ①.
- ▶ Stick TIREFIT container ① upside down into notch ② of the electric air pump.

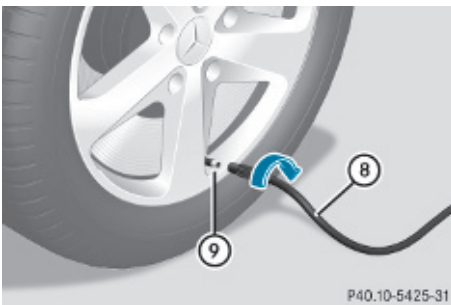

- ▶ Unscrew the valve cap of the damaged tire from tire valve ⑨.

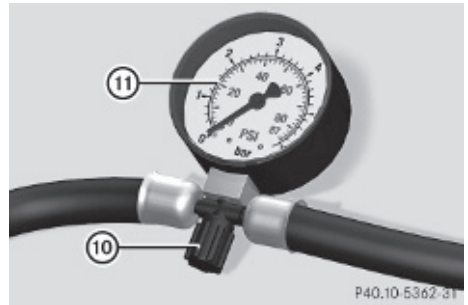

Version 1

- ▶ **Version 1 only:** Close vent screw ⑩ on pressure gauge ⑪.
- ▶ Screw filler hose ⑧ onto tire valve ⑨.
- ▶ Insert electrical plug ④ into the cigarette lighter socket (▷ page 206) or a power outlet (▷ page 207).
- ▶ Turn the SmartKey in the starter switch to position 1.

or

- ▶ Vehicles with KEYLESS-GO: Press the KEYLESS-GO start/stop button once. Do not depress the brake pedal.
 - ▶ Press I on electric air pump switch ③. The electric air pump is switched on and inflates the tire.
- i** First, the sealing is pumped into the tire. The pressure may briefly rise to up to 73 psi (5 bar). This is normal and not an indication of a malfunction. **Do not switch off the electric air pump.**
- ▶ Let the electric air pump inflate the tire for approximately 5 minutes. The pressure gauge must display at least 26 psi (1.8 bar).

⚠ Warning!

The air hose can become hot during inflation. Please exercise appropriate caution.

- !** Do not operate the electric air pump longer than 8 minutes without interruption. Otherwise it may overheat.

You may operate the air pump again after it has cooled off.

If the tire inflation pressure of at least 26 psi (1.8 bar) is not attained:

- ▶ Turn off the electric air pump by pressing **0** on electric air pump switch (3).
- ▶ Detach filler hose (8) from tire valve (9).
- ▶ Drive vehicle back or forth very slowly approximately 30 ft (10 m).
This serves to better distribute the TIREFIT sealant material inside the tire.
- ▶ Inflate the tire again.

Warning!

If a tire inflation pressure of 26 psi (1.8 bar) is not attained, the tire is too severely damaged for TIREFIT to provide a reliable tire repair.

In this case, TIREFIT cannot properly seal the tire.

Do not drive the vehicle.

Contact the nearest Mercedes-Benz Center or call Roadside Assistance.

After attaining a tire inflation pressure of at least 26 psi (1.8 bar):

- ▶ Press **0** on electric air pump switch (3).
The electric air pump is switched off.
- ▶ Detach the TIREFIT kit from the tire valve.

Warning!

The air hose may still be hot. Exercise proper caution to avoid burning yourself when detaching the electric air pump.

- ❗ Remaining TIREFIT sealant could escape from the filler hose after it has been detached from the tire valve. TIREFIT sealant may cause stains.

Therefore, cover the filler hose, e.g. by inserting it into the plastic bag the TIREFIT kit was packed in.

- ▶ **Drive off immediately.**

Warning!

Do not exceed a vehicle speed of 50 mph (80 km/h). A TIREFIT repair is not designed to operate at higher speeds.

The sticker must be attached on the instrument cluster where it will be easily seen by the driver.

Vehicle handling characteristics of a TIREFIT repaired tire may change. Adapt your driving accordingly.

- ▶ After driving the vehicle for an initial 10 minutes, check the tire inflation pressure using the pressure gauge.

Warning!

If tire inflation pressure has fallen below 20 psi (1.3 bar) do not continue to drive the vehicle.

Park your vehicle safely away from the roadway and contact the nearest authorized Mercedes-Benz Center or Roadside Assistance.

Have the damaged tire replaced.

If the tire inflation pressure is at least 20 psi (1.3 bar), inflate or deflate the tire to the correct tire inflation pressure (see Tire and Loading Information placard on the driver's door B-pillar):

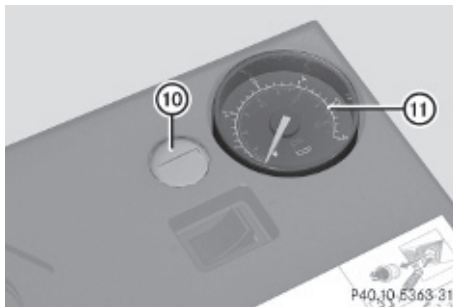

Version 2

- ▶ **To increase tire inflation pressure:**
Switch on the electric air pump.
- ▶ **To decrease tire inflation pressure:**

Version 1: Open vent screw ⑩ on pressure gauge ⑪ (▷ page 331).

Version 2: Press yellow deflate button ⑩ located in air pump housing next to pressure gauge ⑪.

- ▶ Drive to the nearest qualified workshop, e.g. an authorized Mercedes-Benz Center, to have the damaged tire replaced.
- ▶ Recommended duration of use: A maximum of 300 miles (500 km) at 50 mph (80 km/h) or below with the recommended tire inflation pressure.
- ▶ Contact an authorized Mercedes-Benz Center as soon as possible to obtain a new TIREFIT kit.
- ▶ Bring used TIREFIT materials to an authorized Mercedes-Benz Center for proper disposal.
- ▶ Replace your TIREFIT container every 4 years. Replacement containers are available at any authorized Mercedes-Benz Center.

Bleeding the fuel system (diesel engine only)

Driving the vehicle until the fuel tank is empty is not recommended. Otherwise, air may be sucked into the fuel system. If this happens, the malfunction indicator lamp  comes on and the engine may not start immediately after refueling the vehicle.

After refueling:

- ▶ Make sure the automatic transmission is in park position **P**. The transmission position indicator in the multifunction display should be on **P**.
- ▶ Do not depress the accelerator.
- ▶ If necessary, remove the KEYLESS-GO start/stop button from the starter switch.
- ▶ Turn the SmartKey in the starter switch to position **2** for at least 10 seconds.

- ▶ Return the SmartKey in the starter switch to position **0**.
- ▶ Turn the SmartKey in the starter switch to position **3** and hold it there for a maximum of 10 seconds or until the engine runs surge-free.

If the engine does not start:

- ▶ Turn the SmartKey in the starter switch once more to position **2** for at least 10 seconds.
- ▶ Return the SmartKey in the starter switch to position **0**.
- ▶ Turn the SmartKey in the starter switch once more to position **3** and hold it there for a maximum of 10 seconds or until the engine runs surge-free.
- ▶ If necessary, repeat the above steps.

If the engine still does not start after 3 attempts:

Do not make any further attempts to start the engine. Contact an authorized Mercedes-Benz Center or call Roadside Assistance (▷ page 210).

- 1 When the malfunction indicator lamp  in the instrument cluster has been illuminated for the above condition, it will remain illuminated until the engine was cycled on and off four times in a row.

AdBlue® (diesel engine only)

The BlueTEC exhaust gas aftertreatment system requires a reducing agent (AdBlue®) in order to function properly. Refilling with AdBlue® is part of the regular maintenance service work. A tankful of AdBlue® should suffice until the next maintenance service under normal driving conditions.

When the AdBlue® tank is low, the message Check Additive See Operator's Manual appears in the multifunction display.

When the AdBlue® level drops to the minimum level, the message Remaining

Starts: 20 appears in the multifunction display.

i When the message Remaining Starts: 20 appears in the multifunction display, you can start the engine 20 more times. If you do not add AdBlue®, the engine cannot be started beyond that point. Fill the AdBlue® tank with approximately 1 gal (3.79 l) AdBlue® (corresponds to approximately 2 AdBlue® refill containers) or have the AdBlue® tank filled by an authorized Mercedes-Benz Center.

i For refilling outside the maintenance service intervals, refill the AdBlue® tank with approximately 1 gal (3.79 l) AdBlue® (corresponds to approximately 2 AdBlue® refill containers).

Always use the particular AdBlue® refill containers for refilling outside the maintenance service interval. Contact an authorized Mercedes-Benz Center or call Roadside Assistance if necessary (▷ page 210).

Additional information on BlueTEC exhaust gas aftertreatment and AdBlue® is available at any authorized Mercedes-Benz Center.

Refilling with AdBlue®

Warning!

Make sure

- AdBlue® does not come into contact with skin, eyes, or clothing
- to keep AdBlue® out of the reach of children

If you and/or others have come into contact with AdBlue®:

- If AdBlue® has gotten into contact with eyes, flush with plenty of water immediately and seek medical help.
- Clean affected skin immediately with plenty of water.
- If AdBlue® was swallowed, rinse mouth immediately with plenty of water and drink plenty of water. Consult a physician.

Warning!

When opening the filler cap of the AdBlue® tank ammonia gas vapors may escape. Refill AdBlue® in a well ventilated area only. Ammonia gas vapors have a pungent odor and are particularly irritating for your skin, mucous membranes, and eyes. Inhaling ammonia gas vapors will cause burning eyes, nose, and throat, as well as coughing and watering eyes.

i Only use AdBlue® complying with ISO 22241. Do not add additives to AdBlue® and do not dilute AdBlue® with water. Otherwise, the BlueTEC exhaust gas aftertreatment system could be damaged. Damage caused by using additives or diluting with water are not covered by the Mercedes-Benz Limited Warranty.

i Rinse surfaces that have come into contact with AdBlue®, or remove AdBlue® with a moist cloth and cold water immediately. If AdBlue® has crystallized already, use cold water and a sponge. AdBlue® residues will crystallize and soil the affected surfaces.

i AdBlue® is not a fuel additive and must not be added to the diesel fuel tank. If AdBlue® reaches the diesel fuel tank, the engine could be damaged which is not covered by the Mercedes-Benz Limited Warranty.

For more information on AdBlue®, see (▷ page 364).

The AdBlue® filler neck is located in the space underneath the trunk floor.

- ▶ Switch off the ignition.
- ▶ Open the trunk (▷ page 81).
- ▶ Lift the trunk floor (▷ page 268).

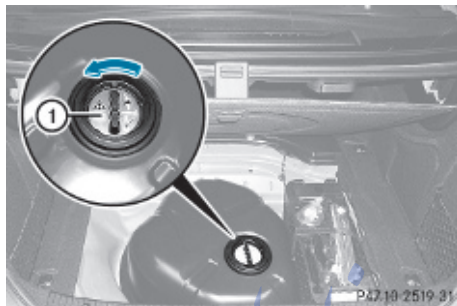

- ▶ Turn AdBlue® filler cap cover (1) counterclockwise and remove it.

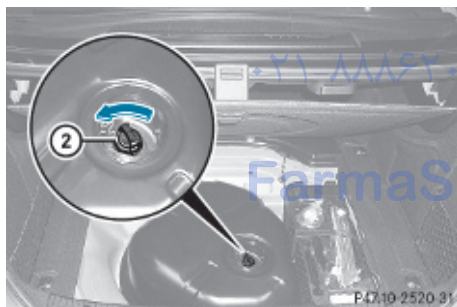

- ▶ Turn AdBlue® filler cap (2) counterclockwise and open it. Filler cap (2) is tethered with a plastic strap.

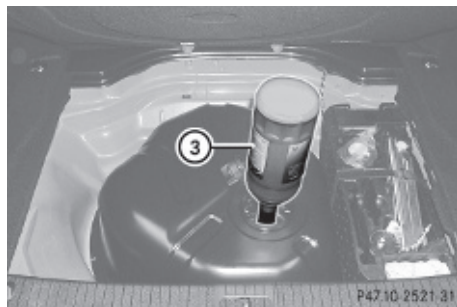

- ▶ Unscrew the dust cap from AdBlue® refill container (3).

- ▶ Place AdBlue® refill container (3) on the filler neck as illustrated and tighten it moderately (hand-tight) by turning it clockwise.

- ⚠ Make sure to tighten the AdBlue® refill container only moderately, i.e. hand-tight, as you could otherwise damage it.

- ▶ Push AdBlue® refill container (3) down. The AdBlue® tank is filled. This may take up to 1 minute. تلفن: ۰۲۱ ۸۸۶۲۰۸۵

- ⓘ When you stop pushing the AdBlue® refill container down, the filling process is stopped and you can remove the refill container.

- ▶ Release AdBlue® refill container (3).

- ▶ Turn AdBlue® refill container (3) counterclockwise and remove it.

- ▶ Place AdBlue® filler cap (2) on filler neck and turn it clockwise.

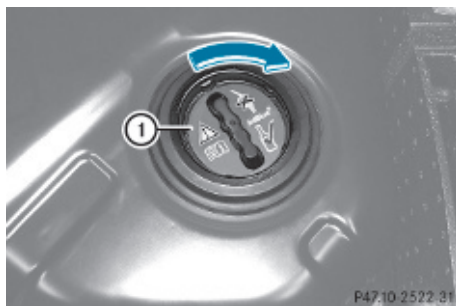

- ▶ Place AdBlue® filler cap cover ① as illustrated and turn it clockwise to its stop.
- ▶ Lower the trunk floor.
- ▶ Close the trunk.
- ▶ Drive the vehicle at a speed of at least 10 mph (16 km/h).
The message Check Additive See Operator's Manual disappears after approximately 1 minute.

i If the message Check Additive See Operator's Manual still appears in the multifunction display, refill with one more container of AdBlue®.

i Have the AdBlue® level checked and, if necessary, filled completely afterward at an authorized Mercedes-Benz Center.

Battery

Safety notes

A battery should always be sufficiently charged in order to achieve its rated service life. Refer to Maintenance Booklet for battery maintenance intervals.

If you use your vehicle mostly for short-distance trips, you will need to have the battery charge checked more frequently.

When replacing a battery, always use a battery approved by Mercedes-Benz.

If you do not intend to operate your vehicle for an extended period of time, contact an authorized Mercedes-Benz Center about steps you need to observe.

Warning!

Observe all safety instructions and precautions when handling automotive batteries.



Risk of explosion.



Fire, open flames and smoking are prohibited when handling batteries. Avoid creating sparks.



Battery acid is caustic. Do not allow it to come into contact with skin, eyes or clothing.

Wear suitable protective clothing, especially gloves, apron and faceguard.

Wear eye protection.



Rinse any acid spills immediately with clear water. Contact a physician if necessary.

Keep children away.



Follow the instructions in this Operator's Manual.

A battery contains materials that can harm the environment if disposed of improperly. A large 12 V storage battery contains lead. Recycling of the battery is the preferred method of disposal. Many states (USA only) or provinces (Canada only) require sellers of batteries to accept the old battery for recycling.

Warning!

Failure to follow these instructions can result in severe injury or death.

Never lean over batteries while connecting. You might get injured.

Battery fluid contains sulfuric acid. Do not allow this fluid to come in contact with eyes, skin or clothing. In case it does, immediately

flush affected area with water and seek medical help if necessary.

A battery will also produce hydrogen gas, which is flammable and explosive. Keep flames or sparks away from battery, avoid improper connection of jumper cables, smoking etc.

Warning!

Do not place metal objects on the battery as this could result in a short circuit.

Use leak-proof batteries only to avoid the risk of acid burns in the event of an accident.

Take care that you do not become statically charged, e.g. by wearing synthetic clothing or rubbing against textiles. For this reason, you also should not pull or push the battery over carpets or other synthetic materials.

Never touch the battery first. First touch the outside body of the vehicle in order to release any possible electrostatic charges.

Do not rub the battery with rags or cloths. The battery could explode if touched due to electrostatic charge or due to spark formation.

! The battery is a Valve-Regulated Lead Acid (VRLA) battery, also referred to as “fleece” battery.

Such batteries do not require topping-up of the electrolyte level. VRLA batteries therefore do not have cell caps and the battery cover is non-removable. Do not attempt to open the battery as otherwise the battery will be damaged.

VRLA batteries do not require topping-up of the electrolyte level. They cannot be opened to check the electrolyte level. However, the battery condition must be checked periodically by performing a battery conductance test. Refer to Maintenance Booklet for battery condition testing intervals.

The factory-equipped battery may only be replaced with a battery that

- has the same security features
- is of identical size
- is of identical voltage
- is of identical capacity

! As any other battery, the battery may discharge if you do not operate the vehicle for an extended period of time. Have the battery disconnected at a qualified workshop or an authorized Mercedes-Benz Center in such a case. You may also connect an accessory battery charge unit expressly approved by Mercedes-Benz for your vehicle model to maintain the battery charge. Contact an authorized Mercedes-Benz Center for further information.

The battery, the battery ventilation hose and the lateral plug must always be securely installed when the vehicle is in operation.

! Never loosen or detach battery terminal clamps while the engine is running or the SmartKey is in the starter switch or KEYLESS-GO button is in position 1. Otherwise the alternator and other electronic components could be severely damaged.

Have the battery checked regularly at an authorized Mercedes-Benz Center.

Refer to Maintenance Booklet for maintenance intervals or contact an authorized Mercedes-Benz Center for further information.

Charging the battery

Warning!

Never charge a battery while still installed in the vehicle unless the accessory battery charge unit approved by Mercedes-Benz is being used. Gases may escape during

charging and could cause an explosion that may result in personal injury, paint damage or corrosion.

An accessory battery charge unit specially adapted for Mercedes-Benz vehicles and tested and approved by Mercedes-Benz is available. It permits the charging of the battery in its installed position. Contact an authorized Mercedes-Benz Center for information and availability.

Charge battery in accordance with the separate instructions for the accessory battery charger.

Have the battery charged at an authorized Mercedes-Benz Center. If you charge the battery yourself, follow the operating instructions for your charging device.

Only use a battery charge unit with a maximum charging voltage of 14.8 V.

- Charge battery in accordance with the instructions of the battery charger manufacturer.

Jump starting

Warning!

Failure to follow these directions will cause damage to the electronic components, and can lead to a battery explosion and severe injury or death.

Never lean over batteries while connecting or jump starting. You might get injured.

Battery fluid contains sulfuric acid. Do not allow this fluid to come in contact with eyes, skin or clothing. In case it does, immediately flush affected area with water, and seek medical help if necessary.

A battery will also produce hydrogen gas, which is flammable and explosive. Keep flames or sparks away from battery, avoid

improper connection of jumper cables, smoking, etc.

Attempting to jump start a frozen battery can result in it exploding, causing personal injury.

Read all instructions before proceeding.

- ❗ Do not tow-start the vehicle. You could otherwise seriously damage the automatic transmission which is not covered by the Mercedes-Benz Limited Warranty.

- ❗ Jump starting should only be performed using the jump-start terminals located in the engine compartment.

Avoid repeated and lengthy starting attempts.

Do not attempt to start the engine using a battery quick-charge unit.

If the engine does not run after several unsuccessful starting attempts, have it checked at the nearest authorized Mercedes-Benz Center.

Excessive unburned fuel generated by repeated failed starting attempts may damage the catalytic converter²¹ and may present a fire risk.

Make sure the jumper cables do not have loose or missing insulation.

Make sure the cable clamps do not touch any other metal part while the other end is still attached to a battery.

If the battery is discharged, the engine can be started with jumper cables and the fully charged battery of another vehicle or an equivalent starter pack. Observe the following:

- Access to the battery is not possible on all vehicles. If you cannot access the battery of the other vehicle, provide jump start

²¹ Vehicles with gasoline engine only.

- power by an external battery or starter pack.
- Jump starting should only be performed when the engine and catalytic converter²² are cold.
- Do not jump start the engine or charge the battery if the battery is frozen. Let the battery thaw out first.
- Only jump start from batteries with the same voltage rating (12 V). Jump starting with a more powerful battery could damage the vehicle's electrical system. Such damage will not be covered by the Mercedes-Benz Limited Warranty.
- Only use jumper cables with sufficient cross-section and insulated terminal clamps.

- Always make sure the jumper cables are not on or near pulleys, fans or other parts that move when an engine is started or running.
- Should the battery be drained completely, let the donating power source charge the vehicle for several minutes before reattempting the starting process.

The jump-start contacts are located in the engine compartment on the passenger side.

- ▶ Make sure the two vehicles do not touch.
- ▶ Switch off all electrical consumers.
- ▶ Engage the parking brake.
- ▶ Make sure the automatic transmission is in park position **P**.
- ▶ Open the hood (▷ page 223).

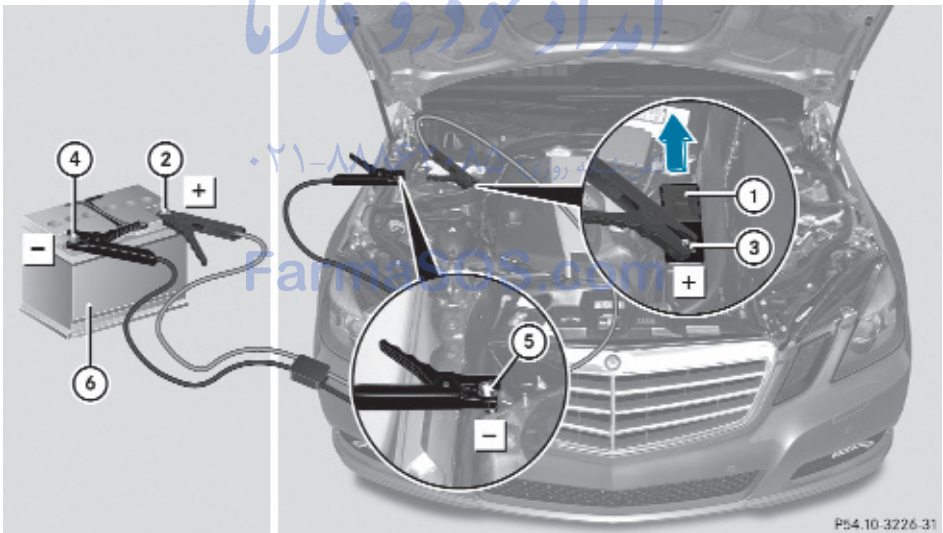

P54.10.3226.31

Position ⑥ represents the charged battery of another vehicle or an equivalent starter pack.

- ▶ Slide cover ① from positive terminal ③ in direction of arrow.

! Never invert the terminal connections!

- ▶ Connect positive terminal ② of charged battery ⑥ with positive terminal ③ with a jumper cable. Clamp the cable to positive terminal ② of charged battery ⑥ first.
- ▶ Start engine of the vehicle with charged battery ⑥ and run at idle speed.

²² Vehicles with gasoline engine only.

- ▶ Connect negative terminal ④ of charged battery ⑥ with negative terminal ⑤ with a jumper cable. Clamp the cable to negative terminal ④ of charged battery ⑥ first.
- ▶ Start engine of the vehicle with the discharged battery and run at idle speed. You can now turn on the electrical consumers. Do not switch on the headlamps under any circumstances.
- ▶ Remove the jumper cables from negative terminals ④ and ⑤ first.
- ▶ Remove the jumper cables from positive terminals ② and ③. You can now switch on the headlamps.
- ▶ Slide cover ① from positive terminal ③ back.
- ▶ Have the battery checked at the nearest authorized Mercedes-Benz Center.

Towing the vehicle

Safety notes

Warning!

The vehicle is braked when the HOLD function or DISTRONIC PLUS is activated. Therefore, deactivate the HOLD function or DISTRONIC PLUS if the vehicle is to be towed.

Mercedes-Benz recommends that the vehicle be transported with all wheels off the ground using flatbed or appropriate wheel lift/dolly equipment. This method is preferable to other types of towing.

- ❗ To prevent damage during transport, do not tie down vehicle by its chassis or suspension parts.

If circumstances do not permit the recommended towing methods, the vehicle may be towed with all wheels on the ground or front axle raised (except vehicles with 4MATIC) only so far as necessary to have the vehicle moved to a safe location where the

recommended towing methods can be employed.

- ❗ Before towing the vehicle observe the following instructions:

- Do not tow-start the vehicle. You could otherwise seriously damage the automatic transmission which is not covered by the Mercedes-Benz Limited Warranty.
- Do not tow with sling-type equipment. Towing with sling-type equipment over bumpy roads will damage radiator and supports.
- Towing of the vehicle should only be done using the properly installed towing eye bolt. Never attach a tow cable, tow rope or tow rod to the vehicle chassis, frame or suspension parts.

Warning!

With the engine not running, there is no power assistance for the brake and steering systems. In this case, it is important to keep in mind that a considerably higher degree of effort is necessary to brake and steer the vehicle. Adapt your driving accordingly.

- ❗ Avoid pulling the vehicle abruptly or diagonally, since it could result in damage to the chassis alignment.
 - ❗ Do not use the towing eye bolt for recovery, as this could damage the vehicle. If in doubt, recover the vehicle with a crane.
 - i If the battery is disconnected or discharged
 - the SmartKey will not turn in the starter switch
 - the automatic transmission will remain in park position **P**
- For more information see “Battery” (▷ page 336) or “Jump starting” (▷ page 338).

Installing towing eye bolt

Depending on whether you are towing a vehicle or you are being towed, the towing eye bolt can be screwed into threaded holes which are located behind covers on each bumper.

The towing eye bolt is supplied with the vehicle tool kit, located underneath the trunk floor (▷ page 268).

- ▶ Take the vehicle tool kit out of the trunk.

Removing cover in front bumper



- ▶ Press mark on cover ① as indicated by the arrow.
- ▶ Lift cover ① off to reveal the threaded hole for the towing eye bolt.

Removing cover in rear bumper

Warning!

In order to avoid possible serious burns or injury, use extreme caution when removing the rear cover, because the rear exhaust pipe is extremely hot.

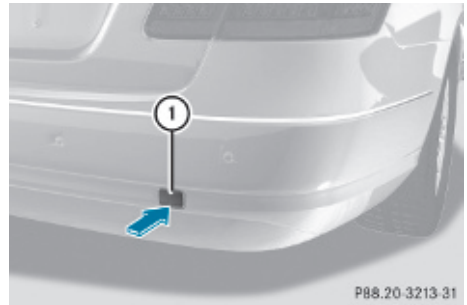

- ▶ Press mark on cover ① as indicated by the arrow.
- ▶ Lift cover ① off to reveal the threaded hole for the towing eye bolt.

Fixing towing eye bolt



Example illustration front bumper

- ▶ Take the towing eye bolt and, if so equipped, the wheel wrench from the vehicle tool kit (▷ page 268).
- ▶ Screw towing eye bolt ② clockwise into threaded hole to its stop.
- ▶ Insert wheel wrench into towing eye and tighten towing eye bolt ② by turning it clockwise.

or

- ▶ If your vehicle is not equipped with a wheel wrench, use a suitable object to turn the towing eye bolt.

Removing towing eye bolt

- ▶ Loosen towing eye bolt ② by turning it counterclockwise.
- ▶ Unscrew towing eye bolt ②.
- ▶ **Reinstalling cover:** Fit cover ① (▷ page 341) and snap it into place.
- ▶ Store the towing eye bolt ② and wheel wrench back into the vehicle tool kit.

Towing with one axle raised

! The vehicle may be towed only for distances up to 30 miles (50 km) and at a speed not to exceed 30 mph (50 km/h).

! Vehicles with 4MATIC: Do not tow with one axle raised. Doing so could damage the transfer case, which is not covered by the Mercedes-Benz Limited Warranty.

All wheels must be on or off the ground. Observe instructions for towing the vehicle with all wheels on the ground.

- ▶ Make sure the ignition is switched on.
- ▶ With the vehicle at a standstill, depress the brake pedal and keep it pressed.
- ▶ Release the brake pedal.
- ▶ If engaged, release the parking brake.
- ▶ Switch off the automatic central locking (▷ page 144).
- ▶ Switch off the ignition and leave the SmartKey in the starter switch.
- ▶ Switch on the hazard warning flasher (▷ page 101).

! Because the ESC operates automatically, the engine and ignition must be shut off (SmartKey in starter switch position **0** or **1** or KEYLESS-GO start/stop button in position **0** or **1**) when the vehicle is being towed with one axle raised.

Active braking action through the ESC may otherwise seriously damage the brake system which is not covered by the Mercedes-Benz Limited Warranty.

Towing with all wheels on the ground

Warning!

If circumstances require towing the vehicle with all wheels on the ground, always tow with a tow bar if:

- the engine will not run
- there is a malfunction in the brake system
- there is a malfunction in the power supply or in the vehicle's electrical system

This is necessary to adequately control the towed vehicle.

Prior to towing the vehicle with all wheels on the ground, make sure the SmartKey is in starter switch position **2**.

If the SmartKey is left in the starter switch position **0** for an extended period of time, it can no longer be turned in the switch. In this case, the steering is locked. To unlock, remove SmartKey from starter switch and reinsert.

Warning!

With the engine not running, there is no power assistance for the brake and steering systems. In this case, it is important to keep in mind that a considerably higher degree of effort is necessary to brake and steer the vehicle. Adapt your driving accordingly.

- ▶ Make sure the ignition is switched on.
- ▶ With the vehicle at a standstill, depress the brake pedal and keep it pressed.
- ▶ Shift the automatic transmission into neutral position **N**.
- ▶ Release the brake pedal.
- ▶ If engaged, release the parking brake.
- ▶ Switch on the hazard warning flasher (▷ page 101).

! The vehicle may be towed only for distances up to 30 miles (50 km) and at a speed not to exceed 30 mph (50 km/h).

- ▶ While being towed with the hazard warning flasher in use, use the combination switch in the usual manner to signal turns. Only the selected turn signal will operate. Upon canceling the turn signal, the hazard warning flasher will operate again.

Fuses

Introduction

The electrical fuses in your vehicle serve to switch off malfunctioning power circuits.

If a fuse is blown, the components and systems secured by that fuse will stop operating.

⚠ Warning!

Only use fuses approved by Mercedes-Benz with the specified amperage for the system in question and do not attempt to repair or bridge a blown fuse. Using other than approved fuses or using repaired or bridged fuses may cause an overload leading to a fire, and/or cause damage to electrical components and/or systems. Have the cause determined and remedied by an authorized Mercedes-Benz Center.

A blown fuse must be replaced by an appropriate spare fuse (recognizable by its color or the fuse rating given on the fuse) of the amperage recommended in the fuse chart. Any Mercedes-Benz Center will be glad to advise you on this subject.

- ▶ In case of a blown fuse contact Roadside Assistance or an authorized Mercedes-Benz Center.

If a newly inserted fuse blows again, have the cause determined and rectified by an authorized Mercedes-Benz Center.

The fuse chart is located in the trunk with the vehicle tool kit (▶ page 268). The fuse chart explains the fuse allocation and fuse amperages.

Before replacing fuses

- ▶ Engage the parking brake.
- ▶ Make sure the automatic transmission is in park position **P**.
The transmission position indicator in the multifunction display should be on **P**.
- ▶ Switch off all electrical consumers.
- ▶ Turn off the engine.
- ▶ Remove the SmartKey from the starter switch.
- ▶ Vehicles with KEYLESS-GO: Open the driver's door (this puts the starter switch in position **0**, same as with the SmartKey removed from the starter switch). The driver's door then can be closed again.

Fuse box in trunk



- ▶ Open the trunk.
- ▶ **Opening:** Insert flat, blunt object as a lever into the upper edge of cover ① and pull cover ① downward in direction of arrow.
- ▶ **Closing:** Install cover ①.

Fuse box in engine compartment

- ▶ Open the hood.

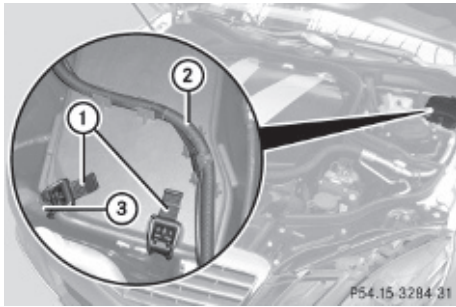

- ▶ With a dry cloth, remove any moisture from fuse box cover.
- ▶ **Opening:** Release wire ② from fuse box cover.
- ▶ Move aside wire ②. Route wire ② behind connection ③ to do this.
- ▶ Release clamps ①.
- ▶ **Closing:** Make sure the sealing rubber is positioned properly.
- ▶ Press fuse box cover down and secure with clamps ①.
- ▶ Fasten wire ② on fuse box cover.

! The fuse box cover must be properly positioned as described. Otherwise, moisture or dirt could enter the fuse box and possibly impair fuse operation.

- ▶ Close the hood after checking or replacing fuses.

Vehicle equipment	346
Parts service	346
Warranty coverage	346
Identification labels	346
Vehicle specification E 350 (212.056)	348
Vehicle specification E 350 Blue- TEC (212.024)	348
Vehicle specification E 350 4MATIC (212.087)	349
Vehicle specification E 550 (212.072)	350
Vehicle specification E 550 4MATIC (212.090)	351
Vehicle specification E 63 AMG (212.077)	352
Rims and tires	353
Fuels, coolants, lubricants, etc.	359

تلفن شبانه روزی: ۰۲۱-۸۸۸۶۲۰۸۵

FarmaSOS.com



Vehicle equipment

i This Operator's Manual describes all features, standard or optional, potentially available for your vehicle at the time of purchase. Please be aware that your vehicle might not be equipped with all features described in this manual.

Parts service

All authorized Mercedes-Benz Centers maintain a stock of Genuine Mercedes-Benz Parts required for maintenance and repair work. In addition, strategically located parts distribution centers provide quick and reliable parts service.

More than 300 000 different parts for Mercedes-Benz models are available.

Genuine Mercedes-Benz Parts are subjected to stringent quality inspections. Each part has been specifically developed, manufactured or selected for and adapted to Mercedes-Benz vehicles.

Therefore, Genuine Mercedes-Benz Parts should be installed.

! Do not use non-genuine Mercedes-Benz parts and accessories not authorized by Mercedes-Benz. Doing so could damage the vehicle, which is not covered by the Mercedes-Benz Limited Warranty. Also, it could compromise the vehicle's durability or safety.

Warranty coverage

Your vehicle is covered under the terms of the warranties printed in the Service and Warranty Information booklet.

Your authorized Mercedes-Benz Center will exchange or repair any defective parts originally installed in the vehicle in accordance with the terms of the following warranties:

- New Vehicle Limited Warranty
- Emission System Warranty
- Emission Performance Warranty
- California, Connecticut, Maine, Massachusetts, New York, Pennsylvania, Rhode Island, and Vermont Emission Control Systems Warranty
- State Warranty Enforcement Laws (Lemon Laws)

Replacement parts and accessories are covered by the Mercedes-Benz Parts and Accessories warranties, copies of which are available at any authorized Mercedes-Benz Center.

Loss of Service and Warranty Information booklet

Should you lose your Service and Warranty Information booklet, have an authorized Mercedes-Benz Center arrange for a replacement. It will be mailed to you.

تلفن شماره روزی: ۰۸۵-۸۸۸۲۰۸۵

Identification labels

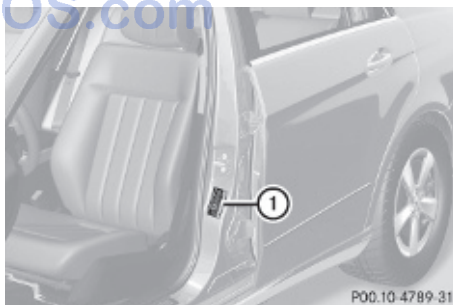

The Vehicle Identification Number (VIN) can be found

- on certification label ① on the driver's door B-pillar
- embossed underneath the carpet in the front passenger footwell
- on the lower edge of the windshield

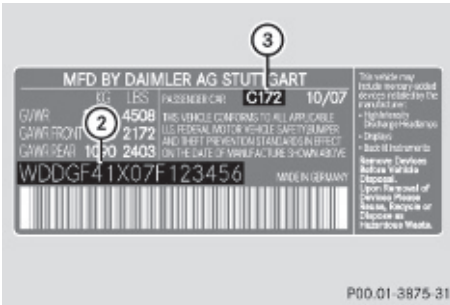

Example certification label (U.S. vehicles)

- ② VIN
- ③ Paintwork code

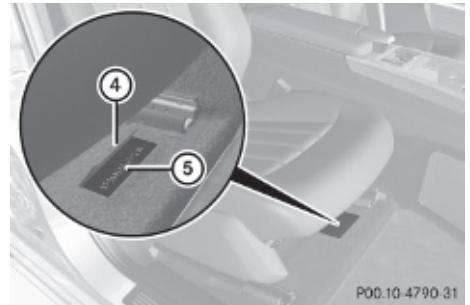

- ▶ Move the front passenger seat backward as far as possible (▷ page 88).
- ▶ Fold carpet ④ backward. VIN ⑤ is now visible.



Example certification label (Canada vehicles)

- ② VIN
- ③ Paintwork code

i Data shown on certification label are for illustration purposes only. These data are specific to each vehicle and may vary from data shown in the illustration. Refer to certification label on vehicle for actual data specific to your vehicle.

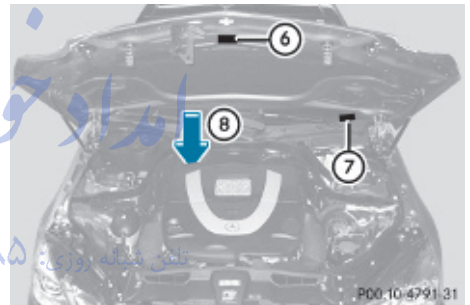

- ⑥ Emission control information label, includes both federal and California certification exhaust emission standards
- ⑦ VIN (on lower edge of windshield)
- ⑧ Engine number (engraved on engine)

i When ordering parts, please specify vehicle identification and engine number.

Vehicle specification E 350 (212.056)

The quoted data apply only to the standard vehicle. Contact an authorized Mercedes-Benz Center for the corresponding data of all special bodies and special equipment.

Engine E 350	
Engine, type	272
Mode of operation	4-stroke engine, gasoline injection
No. of cylinders	6
Bore	3.66 in (92.90 mm)
Stroke	3.39 in (86.00 mm)
Total piston displacement	213.5 cu in (3 498 cm ³)
Compression ratio	10.7:1
Output acc. to SAE J 1349 ²³	268 hp/6 000 rpm (200 kW/6 000 rpm)
Maximum torque acc. to SAE J 1349	258 lb-ft/2 400 - 5 000 rpm (350 Nm/2 400 - 5 000 rpm)
Maximum engine speed	6 500 rpm
Firing order	1-4-3-6-2-5
Poly-V-belt	2 392 mm

Electrical system E 350

Alternator	14 V/180 A
Starter motor	12 V/1.4 kW
Battery	12 V/70 Ah
Spark plugs, type	Bosch Y 7 MPP33

Electrical system E 350

Spark plugs, electrode gap	0.031 in (0.8 mm)
Spark plugs, tightening torque	15 - 18 lb-ft (20 - 25 Nm)

Main dimensions E 350

Overall vehicle length	191.9 in (4 874 mm)
Overall vehicle width ²⁴	81.5 in (2 071 mm)
Overall vehicle height	57.8 in (1 467 mm)
Wheelbase	113.1 in (2 874 mm)
Track, front	62.2 in (1 580 mm)
Track, rear	63.0 in (1 599 mm)
Ground clearance	4.1 in (104 mm)
Turning circle	36.9 ft (11.3 m)

Weights E 350

Roof load	max. 220 lb (100 kg)
Trunk load	max. 220 lb (100 kg)

Vehicle specification E 350 BlueTEC (212.024)

The quoted data apply only to the standard vehicle. Contact an authorized Mercedes-Benz Center for the corresponding data of all special bodies and special equipment.

²³ Premium fuel required. Performance may vary with fuel octane rating.

²⁴ Exterior rear view mirrors folded out.

Engine E 350 BlueTEC	
Engine, type	642
Mode of operation	Diesel 4-stroke engine
No. of cylinders	6
Bore	3.27 in (83.00 mm)
Stroke	3.62 in (92.00 mm)
Total piston displacement	182.3 cu in (2 987 cm ³)
Compression ratio	16.5:1
Output acc. to SAE J 1349	210 hp/3 400 rpm (157 kW/3 400 rpm)
Maximum torque acc. to SAE J 1349	400 lb-ft/1 600 - 2 400 rpm (543 Nm/1 600 - 2 400 rpm)
Maximum engine speed	4 500 rpm
Firing order	1-4-2-5-3-6
Poly-V-belt	2 035 mm

Electrical system E 350 BlueTEC	
Alternator	14 V/180 A
Starter motor	12 V/2.0 kW
Battery	12 V/95 Ah

Main dimensions E 350 BlueTEC	
Overall vehicle length	191.9 in (4 874 mm)
Overall vehicle width ²⁵	81.5 in (2 071 mm)

Main dimensions E 350 BlueTEC	
Overall vehicle height ²⁶	57.8 in (1 467 mm)
Wheelbase	113.1 in (2 874 mm)
Track, front	62.2 in (1 580 mm)
Track, rear	63.0 in (1 599 mm)
Ground clearance ²⁶	3.5 in (89 mm)
Turning circle	36.9 ft (11.3 m)

Weights E 350 BlueTEC	
Roof load	max. 220 lb (100 kg)
Trunk load	max. 220 lb (100 kg)

Vehicle specification E 350 4MATIC (212.087)

The quoted data apply only to the standard vehicle. Contact an authorized Mercedes-Benz Center for the corresponding data of all special bodies and special equipment.

Engine E 350 4MATIC	
Engine, type	272
Mode of operation	4-stroke engine, gasoline injection
No. of cylinders	6
Bore	3.66 in (92.90 mm)
Stroke	3.39 in (86.00 mm)
Total piston displacement	213.5 cu in (3 498 cm ³)
Compression ratio	10.7:1

²⁵ Exterior rear view mirrors folded out.

²⁶ Data apply to unladen vehicle with standard equipment. Data may vary in vehicles equipped with AIRMATIC depending on the selected damping settings and the current vehicle level.

Engine E 350 4MATIC

Output acc. to SAE J 1349²⁷	268 hp/6 000 rpm (200 kW/6 000 rpm)
Maximum torque acc. to SAE J 1349	258 lb-ft/ 2 400 - 5 000 rpm (350 Nm/ 2 400 - 5 000 rpm)
Maximum engine speed	6 500 rpm
Firing order	1-4-3-6-2-5
Poly-V-belt	2 392 mm

Electrical system E 350 4MATIC

Alternator	14 V/180 A
Starter motor	12 V/1.4 kW
Battery	12 V/70 Ah
Spark plugs, type	Bosch Y 7 MPP33
Spark plugs, electrode gap	0.031 in (0,8 mm)
Spark plugs, tightening torque	15 - 18 lb-ft (20 - 25 Nm)

Main dimensions E 350 4MATIC

Overall vehicle length	191.9 in (4 874 mm)
Overall vehicle width²⁸	81.5 in (2 071 mm)
Overall vehicle height	57.8 in (1 467 mm)
Wheelbase	113.1 in (2 874 mm)
Track, front	62.2 in (1 580 mm)
Track, rear	63.0 in (1 599 mm)

Main dimensions E 350 4MATIC

Ground clearance	4.1 in (104 mm)
Turning circle	36.9 ft (11.3 m)

Weights E 350 4MATIC

Roof load	max. 220 lb (100 kg)
Trunk load	max. 220 lb (100 kg)

Vehicle specification E 550 (212.072)

The quoted data apply only to the standard vehicle. Contact an authorized Mercedes-Benz Center for the corresponding data of all special bodies and special equipment.

Engine E 550

Engine, type	273
Mode of operation	4-stroke engine, gasoline injection
No. of cylinders	8
Bore	3.86 in (98.00 mm)
Stroke	3.56 in (90.50 mm)
Total piston displacement	333.2 cu in (5 461 cm ³)
Compression ratio	10.7:1
Output acc. to SAE J 1349²⁹	382 hp/6 000 rpm (285 kW/6 000 rpm)
Maximum torque acc. to SAE J 1349	391 lb-ft/ 2 800 - 4 800 rpm (530 Nm/ 2 800 - 4 800 rpm)
Maximum engine speed	6 500 rpm

²⁷ Premium fuel required. Performance may vary with fuel octane rating.

²⁸ Exterior rear view mirrors folded out.

²⁹ Premium fuel required. Performance may vary with fuel octane rating.

Engine E 550	
Firing order	1-5-4-2-6-3-7-8
Poly-V-belt	2 392 mm

Electrical system E 550	
Alternator	14 V/180 A
Starter motor	12 V/1.4 kW
Battery	12 V/95 Ah
Spark plugs, type	NGK PLKR 7A
Spark plugs, electrode gap	0.031 in (0.8 mm)
Spark plugs, tightening torque	15 - 18 lb-ft (20 - 25 Nm)

Main dimensions E 550	
Overall vehicle length	191.9 in (4 874 mm)
Overall vehicle width ³⁰	81.5 in (2 071 mm)
Overall vehicle height	57.0 in (1 447 mm)
Wheelbase	113.1 in (2 874 mm)
Track, front	62.5 in (1 587 mm)
Track, rear	63.0 in (1 599 mm)
Ground clearance	5.4 in (137 mm)
Turning circle	36.9 ft (11.3 m)

Weights E 550	
Roof load	max. 220 lb (100 kg)
Trunk load	max. 220 lb (100 kg)

Vehicle specification E 550 4MATIC (212.090)

The quoted data apply only to the standard vehicle. Contact an authorized Mercedes-Benz Center for the corresponding data of all special bodies and special equipment.

Engine E 550 4MATIC	
Engine, type	273
Mode of operation	4-stroke engine, gasoline injection
No. of cylinders	8
Bore	3.86 in (98.00 mm)
Stroke	3.56 in (90.50 mm)
Total piston displacement	333.2 cu in (5 461 cm ³)
Compression ratio	10.7:1
Output acc. to SAE J 1349 ³¹	382 hp/6 000 rpm (285 kW/6 000 rpm)
Maximum torque acc. to SAE J 1349	391 lb-ft/ 2 800 - 4 800 rpm (530 Nm/ 2 800 - 4 800 rpm)
Maximum engine speed	6 500 rpm
Firing order	1-5-4-2-6-3-7-8
Poly-V-belt	2 392 mm

Electrical system E 550 4MATIC	
Alternator	14 V/180 A
Starter motor	12 V/1.4 kW
Battery	12 V/95 Ah
Spark plugs, type	NGK PLKR 7A

³⁰ Exterior rear view mirrors folded out.

³¹ Premium fuel required. Performance may vary with fuel octane rating.

Electrical system E 550 4MATIC

Spark plugs, electrode gap	0.031 in (0.8 mm)
Spark plugs, tightening torque	15 - 18 lb-ft (20 - 25 Nm)

Main dimensions E 550 4MATIC

Overall vehicle length	191.9 in (4874 mm)
Overall vehicle width ³²	81.5 in (2071 mm)
Overall vehicle height	57.0 in (1447 mm)
Wheelbase	113.1 in (2874 mm)
Track, front	62.2 in (1580 mm)
Track, rear	63.0 in (1599 mm)
Ground clearance	5.4 in (137 mm)
Turning circle	36.9 ft (11.3 m)

Weights E 550 4MATIC

Roof load	max. 220 lb (100 kg)
Trunk load	max. 220 lb (100 kg)

Vehicle specification E 63 AMG (212.077)

The quoted data apply only to the standard vehicle. Contact an authorized Mercedes-Benz Center for the corresponding data of all special bodies and special equipment.

Engine E 63 AMG

Engine, type	156
Mode of operation	4-stroke engine, gasoline injection
No. of cylinders	8
Bore	4.02 in (102.20 mm)
Stroke	3.72 in (94.60 mm)
Total piston displacement	378.8 cu in (6 208 cm ³)
Compression ratio	11.3:1
Output acc. to SAE J 1349 ³³	518 hp/6 800 rpm (386 kW/6 800 rpm)
Maximum torque acc. to SAE J 1349	465 lb-ft/5 200 rpm (630 Nm/5 200 rpm)
Maximum engine speed	7 200 rpm
Firing order	1-5-4-2-6-3-7-8
Poly-V-belt	2 360 mm

Electrical system E 63 AMG

Alternator	14 V/180 A
Starter motor	12 V/1.7 kW
Battery	12 V/80 Ah
Spark plugs, type	NGK ILZKAR 7A10
Spark plugs, electrode gap	0.039 in (1.0 mm)
Spark plugs, tightening torque	15 - 18 lb-ft (20 - 25 Nm)

³² Exterior rear view mirrors folded out.

³³ Premium fuel required. Performance may vary with fuel octane rating.

Main dimensions E 63 AMG

Overall vehicle length	192.6 in (4 891 mm)
Overall vehicle width ³⁴	81.5 in (2 071 mm)
Overall vehicle height	56.8 in (1 442 mm)
Wheelbase	113.1 in (2 874 mm)
Track, front	64.0 in (1 625 mm)
Track, rear	62.8 in (1 594 mm)
Ground clearance	4.5 in (114 mm)
Turning circle	37.1 ft (11.30 m)

E 63 AMG

Roof load	max. 220 lb (100 kg)
Trunk load	max. 220 lb (100 kg)

Rims and tires

Notes

! Only use tires which have been tested and approved by Mercedes-Benz. Tires approved by Mercedes-Benz are developed to provide best possible performance in conjunction with the driving safety systems on your vehicle such as the ABS or the ESC. Tires specially developed for your vehicle and tested and approved by Mercedes-Benz can be identified by finding the following on the tire's sidewall:

- MO = Mercedes-Benz Original equipment tires
- MO1 = Mercedes-Benz Original equipment tires (applicable to selected tire sizes only)
- MOE = Mercedes-Benz Original Extended (tires with limited run-flat characteristics) original equipment tires

Using tires other than those approved by Mercedes-Benz may result in damage that is not covered by the Mercedes-Benz Limited Warranty.

For information on driving with MOExtended tires, see the "Practical hints" section (▷ page 329).

i USA only: Vehicles with MOExtended system are not factory-equipped with a TIREFIT kit. When retrofitting with tires that do not have run-flat characteristics, you should also equip your vehicle with a TIREFIT kit. TIREFIT kits are available at any authorized Mercedes-Benz Center.

! Using tires other than those approved by Mercedes-Benz can have detrimental effects, such as

- poor handling characteristics
- increased noise
- increased fuel consumption

³⁴ Exterior rear view mirrors folded out.

Moreover, tires and rims not approved by Mercedes-Benz may, under load, exhibit dimensional variations and different tire deformation characteristics that could cause them to come into contact with the vehicle body or axle parts. Damage to the tires or the vehicle may be the result.

- i** Further information on tires and rims is available at any authorized Mercedes-Benz Center. The Tire and Loading Information placard with the recommended tire inflation pressures for cold tires is located on the driver's door B-pillar. Supplemental tire inflation pressure information for driving at high speeds or for vehicle loads less than the maximum loaded vehicle condition can be found on the tire inflation pressure label. The tire inflation pressure label is located on the inside of the fuel filler flap. The tire inflation pressure should be checked regularly and should only be adjusted on cold tires. Follow tire manufacturer's maintenance recommendation included with the vehicle.

For information on recommended tire inflation pressure and supplemental tire

inflation pressure information for special driving situations, see (▷ page 229).

- i** Please keep in mind that the vehicle must be equipped
- with wheels of identical dimensions on each axle (left and right)
 - with tires of identical characteristics all around, i.e. summer tires, winter tires, all-season tires, or MOExtended tires etc.
- i** The following pages also list the approved rim and tire sizes for equipping your vehicle with winter tires. Winter tires are not available as standard or optional factory equipment, but can be purchased from an authorized Mercedes-Benz Center. Equipping your vehicle with winter tires approved for your vehicle model may require the purchase of rims of the recommended size for use with these winter tires. This depends on vehicle model and the standard or optional factory-equipped wheel rim/tire configuration on your vehicle. For more information contact an authorized Mercedes-Benz Center.

Same size tires			
		E 350 Luxury BlueTEC ³⁵	E 350 BlueTEC ³⁶
17" wheels	Rims (light alloy)	8.0 J x 17 H2	8.0 J x 17 H2
	Wheel offset	1.89 in (48 mm)	1.89 in (48 mm)
	All-season tires ³⁷	245/45 R17 95H M+S MOExtended ³⁸	245/45 R17 99H XL (Extra Load) M+S
	Winter tires ^{37,39}	245/45 R17 99V XL (Extra Load) M+S  MOExtended ³⁸	245/45 R17 99H XL (Extra Load) M+S 
		E 350 Sport BlueTEC ³⁵	E 350 BlueTEC ³⁶
17" wheels	Rims (light alloy)	8.5 J x 17 H2	8.5 J x 17 H2
	Wheel offset	1.89 in (48 mm)	1.89 in (48 mm)
	All-season tires ³⁷	245/45 R17 95H M+S MOExtended ³⁸	245/45 R17 99H XL (Extra Load) M+S
	Winter tires ^{37,39}	245/45 R17 99V XL (Extra Load) M+S  MOExtended ³⁸	245/45 R17 99H XL (Extra Load) M+S 
		E 350 Luxury ³⁵ E 550 Luxury ³⁵	
17" wheels	Rims (light alloy)	8.0 J x 17 H2	
	Wheel offset	1.89 in (48 mm)	
	All-season tires ³⁷	245/45 R17 99H XL (Extra Load) M+S	
	Winter tires ^{37,39}	245/45 R17 99H XL (Extra Load) M+S 	

تلفن شبانه روزی: ۰۸۵-۸۸۸۶۳-۲۱

³⁵ USA only.

³⁶ Canada only.

³⁷ Radial-ply tires.

³⁸ Must be used in conjunction with tire pressure loss warning system or Advanced Tire Pressure Monitoring System only.

³⁹ Not available as factory equipment.

		E 350 4MATIC³⁶ E 350 Luxury 4MATIC³⁵
18" wheels	Rims (light alloy)	8.5 J x 18 H2
	Wheel offset	1.89 in (48 mm)
	All-season tires³⁷	245/40 R18 97V XL (Extra Load) M+S
	Winter tires^{37,39}	245/40 R18 97H XL (Extra Load) M+S 

		E 350 4MATIC (Sport Package)³⁶ E 350 Sport 4MATIC³⁵ E 550 4MATIC³⁶ E 550 Sport 4MATIC³⁵
18" wheels	AMG rims (light alloy)	8.5 J x 18 H2
	Wheel offset	1.89 in (48 mm)
	All-season tires³⁷	245/40 R18 97V XL (Extra Load) M+S
	Winter tires^{37,39}	245/40 R18 97H XL (Extra Load) M+S 

Mixed size tires

			E 350 Sport⁴⁰
18" wheels	Front axle	Rims (light alloy)	8.5 J x 18 H2
		Wheel offset	1.89 in (48 mm)
		All-season tires⁴¹	245/40 R18 97V XL (Extra Load) M+S
	Rear axle	Rims (light alloy)	9.0 J x 18 H2
		Wheel offset	2.13 in (54 mm)
		All-season tires^{41,42}	265/35 R18 97V XL (Extra Load) M+S

³⁶ Canada only.

³⁵ USA only.

³⁷ Radial-ply tires.

³⁹ Not available as factory equipment.



⁴⁰ USA only.

⁴¹ Radial-ply tires.

⁴² Must not be used with snow chains.

			E 350 Sport⁴⁰ E 550 Sport⁴⁰
18" wheels	Front axle	AMG rims (light alloy)	8.5 J x 18 H2
		Wheel offset	1.89 in (48 mm)
		All-season tires⁴¹	245/40 R18 97V XL (Extra Load) M+S
	Rear axle	AMG rims (light alloy)	9.0 J x 18 H2
Wheel offset		2.13 in (54 mm)	
	All-season tires^{41,42}	265/35 R18 97V XL (Extra Load) M+S	

			E 63 AMG
18" wheels	Front axle	AMG rims (light alloy)	9.0 J x 18 H2
		Wheel offset	1.46 in (37 mm)
		Summer tires^{41,43}	255/40 ZR18 (99Y) XL (Extra Load) MO1
	Rear axle	AMG rims (light alloy)	9.5 J x 18 H2
Wheel offset		2.05 in (52 mm)	
	Summer tires^{41,42,43}	285/35 ZR18 (101Y) XL (Extra Load) MO1	

			E 63 AMG E 63 AMG (Performance Package)
18" wheels	Front axle	AMG rims (light alloy)	9.0 J x 18 H2
		Wheel offset	1.46 in (37 mm)
		Winter tires^{41,43,44}	255/40 R18 99V XL (Extra Load) M+S 
	Rear axle	AMG rims (light alloy)	9.5 J x 18 H2
Wheel offset		2.05 in (52 mm)	
	Winter tires^{41,43,44}	255/40 R18 99V XL (Extra Load) M+S 	

⁴⁰ USA only.



⁴¹ Radial-ply tires.

⁴² Must not be used with snow chains.

⁴³ Must not be used on vehicles that are equipped with ceramic composite brake disks.

⁴⁴ Not available as factory equipment.

			E 63 AMG (Performance Package)
19" wheels	Front axle	AMG rims (light alloy)	9.0 J x 19 H2
		Wheel offset	1.46 in (37 mm)
		Summer tires ⁴¹	255/35 ZR19 (96Y) XL (Extra Load)
	Rear axle	AMG rims (light alloy)	9.5 J x 19 H2
Wheel offset		2.05 in (52 mm)	
	Summer tires ^{41,42}	285/30 ZR19 (98Y) XL (Extra Load)	

			E 63 AMG E 63 AMG (Performance Package)
19" wheels	Front axle	AMG rims (light alloy)	9.0 J x 19 H2
		Wheel offset	1.46 in (37 mm)
		Winter tires ^{41,44}	255/35 R19 96V XL (Extra Load) M+S 
	Rear axle	AMG rims (light alloy)	9.5 J x 19 H2
Wheel offset		2.05 in (52 mm)	
	Winter tires ^{41,44}	255/35 R19 96V XL (Extra Load) M+S  ⁴⁵ or 285/30 R19 98V XL (Extra Load) M+S  ⁴²	

Spare wheel

- !** Compare the recommended tire inflation pressure for your vehicle with the tire inflation pressure on the yellow label located on the spare wheel rim.
If the tire inflation pressure on the yellow label on the spare wheel rim differs from the values given in this Operator's Manual, inflate the tire to the recommended tire inflation pressure given on the yellow label on the spare wheel rim.
- i** Please note that the tire inflation pressure of the spare wheel differs from the tire inflation pressure of the road tires.
- i** The E 350 BlueTEC does not have a spare wheel.

⁴¹ Radial-ply tires.

⁴² Must not be used with snow chains.

⁴⁴ Not available as factory equipment.

⁴⁵ For use with snow chains contact an authorized Mercedes-Benz-Center.

		E 350 E 350 4MATIC
17" wheel	Rim (light alloy)	4.0 B x 17 H2
	Wheel offset	1.54 in (39 mm)
	Minispare tire ⁴⁶	T 155/70 R17 110M
	Recommended tire inflation pressure	61 psi (4.2 bar)

		E 550 E 550 4MATIC
18" wheel	Rim (light alloy)	4.5 B x 18 H2
	Wheel offset	1.42 in (36 mm)
	Minispare tire ⁴⁶	T 155/60 R18 107M
	Recommended tire inflation pressure	61 psi (4.2 bar)

		E 63 AMG
19" wheel	Rim (light alloy)	6.5 B x 19 H2
	Wheel offset	0.55 in (14 mm)
	Collapsible tire ⁴⁶	175/50-19 97P
	Recommended tire inflation pressure	51 psi (3.5 bar)

Fuels, coolants, lubricants, etc.

Capacities

Vehicle components and their respective lubricants must match. Therefore only use products tested and approved by Mercedes-Benz.

For information on tested and approved products, contact an authorized Mercedes-Benz Center or visit www.mbusa.com (USA only).

Warning!

Comply with all valid regulations with respect to handling, storing, and disposing of service

fluids. Otherwise you could endanger persons or the environment.

Keep service fluids out of the reach of children.

For health reasons, you should prevent service fluids from coming into direct contact with your skin or clothing.

If a service fluid is swallowed, contact a physician immediately.

⁴⁶ Must not be used with snow chains.

	Model	Capacity	Fuels, coolants, lubricants, etc.
Engine with oil filter	E 350 E 350 BlueTEC E 350 4MATIC	8.5 US qt (8.0 l)	Approved engine oils
	E 550 E 550 4MATIC	9.0 US qt (8.5 l)	
	E 63 AMG ⁴⁷	9.3 US qt (8.8 l)	
Automatic transmission	E 350 E 350 BlueTEC E 550	9.5 US qt (9.0 l)	MB Automatic Transmission Fluid
	E 350 4MATIC E 550 4MATIC	10.5 US qt (9.9 l)	
	E 63 AMG ⁴⁸	9.3 US qt (8.8 l)	
Front axle	E 350 4MATIC E 550 4MATIC	0.63 US qt (0.6 l)	Hypoid gear oil
Rear axle	E 350	1.2 US qt (1.1 l)	Hypoid gear oil
	E 350 BlueTEC E 550	1.3 US qt (1.2 l)	
	E 350 4MATIC E 550 4MATIC	1.1 US qt (1.0 l)	Fuchs Titan EG 5010 D Castrol SAF-XJ ⁴⁹
	E 63 AMG	1.3 US qt (1.2 l)	
Transfer case	E 350 4MATIC E 550 4MATIC	0.74 US qt (0.7 l)	MB Automatic Transmission Fluid
Power steering	All models, except E 63 AMG	approx. 0.95 US qt (0.9 l)	MB Power Steering Fluid or approved Dexron III ATF
	E 63 AMG	1.3 US qt (1.2 l)	Chevron Texaco CHF 9109

⁴⁷ Engine with oil cooler.

⁴⁸ Automatic transmission with oil cooler.

⁴⁹ AMG vehicles with differential lock.

	Model	Capacity	Fuels, coolants, lubricants, etc.
Brake system	All models	approx. 0.53 US qt (0.5 l)	MB Brake Fluid (DOT 4+)
Cooling system	E 350 E 350 4MATIC	approx. 8.9 US qt (8.4 l)	MB 325.0 Anticorrosion/ Antifreeze
	E 350 BlueTEC	approx. 12.2 US qt (11.5 l)	
	E 550 E 550 4MATIC	approx. 10.9 US qt (10.3 l)	
	E 63 AMG	approx. 11.6 US qt (11.0 l)	
Fuel tank	All models	21.1 US gal (80.0 l)	Gasoline engine: Premium unleaded gasoline (Minimum Posted Octane 91 [Avg. of 96 RON/86 MON])
Fuel tank reserve	All models, except E 63 AMG	approx. 2.4 US gal (9.0 l)	
	E 63 AMG	approx. 3.7 US gal (14.0 l)	
Air conditioning system	All models	–	R134a refrigerant and special PAG lubricant oil (never R 12)
Washer system and headlamp cleaning system	All models, except E 350 BlueTEC	6.3 US qt (6.0 l)	MB Windshield Washer Concentrate ⁵⁰ (▷ page 367) Washer fluid mixing ratio (▷ page 367)
	E 350 BlueTEC	3.7 US qt (3.5 l)	

Approved engine oils

Engine oils are specifically tested for their suitability in our engines and durability for our service intervals. Therefore, only use approved engine oils and oil filters required for vehicles with the Maintenance System.

! Using engine oils and oil filters of a specification other than those expressly required for the Maintenance System, or changing of oil and oil filter at change intervals longer than those called for by the

Maintenance System will result in engine or emission control system damage not covered by the Mercedes-Benz Limited Warranty.

Please follow Maintenance System recommendations for scheduled oil changes. Failure to do so will result in engine or emission control system damage not covered by the Mercedes-Benz Limited Warranty.

⁵⁰ Mixed with water or commercially available premixed washer solvent/antifreeze.

Use the table below to determine the MB sheet number.

Model	Engine, type	MB sheet number
E 350 E 350 4MATIC	272	229.5
E 350 BlueTEC	642	229.51
E 550 E 550 4MATIC	273	229.5
E 63 AMG	156	229.5 ⁵¹

- i** MB sheet numbers are printed on the outside of oil containers.

Viscosity grades for engine oils

Using the chart below, select oil viscosity according to the lowest air temperature expected before the next oil change.

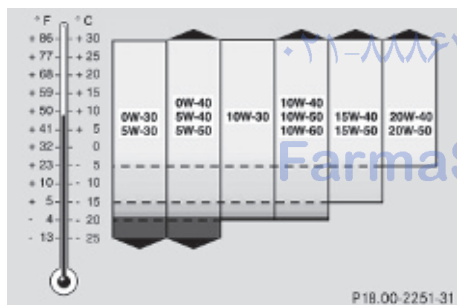

Engine oil additives

- !** Do not blend oil additives with engine oil. They may damage the engine. Damage or malfunctions resulting from blending oil additives are not covered by the Mercedes-Benz Limited Warranty.

Air conditioning refrigerant

R134a (HFC) refrigerant and special PAG lubricating oil are used in the air conditioning system.

- !** Never use R 12 (CFC) or mineral-based lubricating oil. Otherwise damage to the system will occur.

Brake fluid

⚠ Warning!

During vehicle operation, the boiling point of the brake fluid is continuously reduced through the absorption of moisture from the atmosphere.

Under extremely strenuous operating conditions, this moisture content can lead to the formation of bubbles in the system, thus reducing the system's efficiency.

Therefore, the brake fluid must be replaced regularly. Refer to your vehicle's Maintenance Booklet for replacement interval.

Only brake fluid approved by Mercedes-Benz is recommended. Any authorized Mercedes-Benz Center will provide you with additional information.

Premium unleaded gasoline

⚠ Warning!

Gasoline is highly flammable and poisonous. It burns violently and can cause serious personal injury.

Never allow sparks, flames or smoking materials near gasoline!

Turn off the engine before refueling.

Whenever you are around gasoline, avoid inhaling fumes and any skin or clothing contact. Extinguish all smoking materials.

⁵¹ Restriction: Only SAE 0W-40/SAE 5W-40 engine oils may be used.

Direct skin contact with fuels and the inhalation of fuel vapors are damaging your health.

! To maintain the engine's durability and performance, premium unleaded gasoline must be used.

If premium unleaded gasoline is not available and low octane gasoline is used, follow these precautions:

- Have the fuel tank only partially filled with unleaded regular gasoline and fill up with premium unleaded gasoline as soon as possible.
- Avoid full throttle driving and abrupt acceleration.
- Do not exceed an engine speed of 3 000 rpm if the vehicle is loaded with a light load such as two persons and no luggage.
- Do not exceed $\frac{2}{3}$ of maximum accelerator pedal position if the vehicle is fully loaded or operating in mountainous terrain.

Fuel requirements

Only use premium unleaded gasoline. The octane number (posted at the pump) must be 91 min. It is an average of both the Research Octane Number (RON) and the Motor Octane Number (MON): $(RON+MON)/2$. This is also known as the ANTI-KNOCK INDEX.

Reformulated gasolines (RFG) and/or unleaded gasoline containing oxygenates such as ethanol, TAME, ETBE, IPA, IBA, and TBA can be used provided the ratio of any one of these oxygenates to gasoline does not exceed 10%; MTBE must not exceed 15%.

The ratio of methanol to gasoline must not exceed 3% plus additional cosolvents.

Using mixtures of ethanol and methanol is not allowed. Gasohol, which contains 10%

ethanol and 90% unleaded gasoline, can be used.

These blends must also meet all other fuel requirements, such as resistance to spark knock, boiling range, vapor pressure, etc.

Diesel engine

Only use commercially available vehicular ULTRA-LOW SULFUR HIGHWAY DIESEL FUEL (ULSD, 15 ppm SULFUR MAXIMUM) that meets the ASTM D975 standard. Failure to use ULTRA-LOW SULFUR HIGHWAY DIESEL FUEL (ULSD) can severely damage the vehicle's exhaust after-treatment device.

To prevent malfunctions, diesel fuel with improved cold flow characteristics is offered in the winter months. Check with your fuel retailer.

! Do not fill the tank with gasoline. Do not blend diesel fuel with gasoline or kerosene. The fuel system and engine will otherwise be damaged, which is not covered by the Mercedes-Benz Limited Warranty.

For further information on diesel fuel pump labeling, contact an authorized Mercedes-Benz Center or visit www.mbusa.com (USA only).

Biodiesel (FAME = Fatty Acid Methyl Ester) containing fuels

Mercedes-Benz USA approves the use of B5 (standard ULSD which may contain a maximum of 5% biodiesel) in all Common-rail injection (CDI) and BlueTEC diesel engines.

Diesel fuels containing a higher percentage of biodiesel, e.g. B20, as well as straight biodiesel may cause severe damage to your engine/fuel system and are not approved.

Please ask your service station personnel for further information. If the B5 biodiesel blend is not sufficiently labeled to clearly indicate that it meets the ULSD standard, please do not use it.

The Mercedes-Benz Limited Warranty does not cover damages caused by the use of fuels

not meeting Mercedes-Benz approved fuel standards.

Gasoline additives

A major concern among engine manufacturers is carbon build-up caused by gasoline. Mercedes-Benz recommends only the use of quality gasoline containing additives that prevent the build-up of carbon deposits.

After an extended period of using fuels without such additives carbon deposits can build up, especially on the intake valves and in the combustion area, leading to engine performance problems such as:

- Warm-up hesitation
- Unstable idle
- Knocking/pinging
- Misfire
- Power loss

In areas where carbon deposits may be encountered due to lack of availability of gasoline which contains these additives, the use of Mercedes-Benz approved additives is recommended.

Contact an authorized Mercedes-Benz Center or visit www.mbusa.com (USA only) for a listing of approved products. Follow directions on the product label.

Do not blend other fuel additives with fuel. This only results in unnecessary cost and may be harmful to the engine operation.

! Damage or malfunction resulting from poor fuel quality or from blending additional fuel additives other than those tested and approved by us for use on Mercedes-Benz vehicles are not covered by the Mercedes-Benz Limited Warranty or by any pre-owned or Extended Limited Warranties.

AdBlue®

AdBlue® is a non-flammable, non-toxic, colorless and odorless, water-soluble liquid.

! Only use AdBlue® complying with ISO 22241. Do not blend with additives.

! Rinse surfaces that have come into contact with AdBlue®, or remove AdBlue® with a moist cloth and cold water immediately. If AdBlue® has crystallized already, use cold water and a sponge. AdBlue® residues will crystallize and soil the affected surfaces.

High ambient temperatures

If AdBlue® in the reservoir heats up to above 122°F (50°C) for a long period of time, for example due to direct sunlight, ammonia gas vapors may escape when opening the AdBlue® tank.

! Warning!

When opening the filler cap of the AdBlue® tank ammonia gas vapors may escape. Refill AdBlue® in a well ventilated area only. Ammonia gas vapors have a pungent odor and are particularly irritating for your skin, mucous membranes, and eyes. Inhaling ammonia gas vapors will cause burning eyes, nose, and throat, as well as coughing and watering eyes.

Low ambient temperatures

AdBlue® freezes at a temperature of approximately 12°F (-11°C). Your vehicle is factory equipped with an AdBlue® preheating system. The vehicle can thus be operated at temperatures below 12°F (-11°C).

Special additives

! Only use AdBlue® complying with ISO 22241. Do not add additives to AdBlue® and do not dilute AdBlue® with

water. Otherwise, the BlueTEC exhaust gas aftertreatment system could be damaged.

Damage caused by using additives or diluting with water are not covered by the Mercedes-Benz Limited Warranty.

Purity

The purity of AdBlue® is of particular importance for avoiding malfunctions in the exhaust gas aftertreatment.

If AdBlue® is pumped out of the tank, e.g. during repair work, the same liquid must not be used to refill the tank as its purity is no longer guaranteed.

! Impurities caused for example by other service products, cleaning agents, and dust result in increased emissions, malfunctions, catalyst damage, or engine damage.

Coolants

The engine coolant is a mixture of water and anticorrosion/antifreeze, which provides:

- Corrosion protection
- Freeze protection
- Boiling protection (by increasing the boiling point)

The cooling system was filled at the factory with a coolant providing freeze protection to approximately -35°F (-37°C) and corrosion protection.

! Add premixed coolant solution only. Adding water and MB 325.0 Anticorrosion/Antifreeze separately from each other, could cause engine damage not covered by the Mercedes-Benz Limited Warranty.

If the antifreeze mixture is effective to -35°F (-37°C), the boiling point of the coolant in the pressurized cooling system is reached at approximately 266°F (130°C).

The coolant solution must be used year round to provide the necessary corrosion protection

and increase boil-over protection. Refer to the Maintenance Booklet for replacement interval.

Coolant system design and coolant used determine the replacement interval. The replacement interval published in the Maintenance Booklet is only applicable if MB 325.0 Anticorrosion/Antifreeze solution or other Mercedes-Benz approved products of equal specification are used to renew the coolant concentration or bring it back up to the proper level.

For information on other Mercedes-Benz approved products of equal specification, contact an authorized Mercedes-Benz Center or visit www.mbusa.com (USA only).

To provide important corrosion protection, the solution must be at least 50% anticorrosion/antifreeze (equivalent to freeze protection to approximately -35°F [-37°C]).

If you use a solution that is more than 55% anticorrosion/antifreeze (freeze protection to approximately -49°F [-45°C]), the engine temperature will increase due to the lower heat transfer capability of the solution.

Therefore, do not use more than this amount of anticorrosion/antifreeze.

If the coolant level is low, water and MB 325.0 Anticorrosion/Antifreeze should be used to bring it up to the proper level (have cooling system checked for signs of leakage). Please make sure the mixture is in accordance with label instructions.

The water in the cooling system must meet minimum requirements, which are usually satisfied by normal drinking water.

If you are not sure about the water quality, contact an authorized Mercedes-Benz Center.

Anticorrosion/antifreeze

Your vehicle contains a number of aluminum parts. The use of aluminum components in motor vehicle engines necessitates that anticorrosion/antifreeze coolant used in

such engines be specifically formulated to protect the aluminum parts. Failure to use such anticorrosion/antifreeze coolant will result in a significantly shortened service life.

Therefore, the following product is strongly recommended for use in your vehicle:
MB 325.0 Anticorrosion/Antifreeze agent.

Before the start of the winter season (or once a year in hot southern regions), you should have the anticorrosion/antifreeze concentration checked.

The coolant is also regularly checked each time you bring your vehicle to an authorized Mercedes-Benz Center for service.

	Model	Approximate freeze protection	
		-35°F (-37°C)	-49°F (-45°C)
Cooling system	E 350 E 350 4MATIC	4.4 US qt (4.2 l)	4.9 US qt (4.6 l)
	E 350 BlueTEC	6.1 US qt (5.8 l)	6.7 US qt (6.3 l)
	E 550 E 550 4MATIC	5.5 US qt (5.2 l)	6.0 US qt (5.7 l)
	E 63 AMG	5.8 US qt (5.5 l)	6.3 US qt (6.0 l)

تلفن شبانه روزی: ۰۲۱-۸۸۸۶۲۰۸۵

FarmaSOS.com

Washer system and headlamp cleaning system

Warning!

Washer solvent/antifreeze is highly flammable. Do not spill washer solvent/antifreeze on hot engine parts, because it may ignite and burn. You could be seriously burned.

- ▶ Use MB Windshield Washer Concentrate “MB SummerFit”.
- ▶ Mix with water for temperatures above freezing point.
- ▶ Mix with commercially available premixed washer solvent/antifreeze for temperatures below freezing point.

Washer fluid mixing ratio

For temperatures above the freezing point:

1 part “MB SummerFit” to 100 parts water
(1.34 fl oz [40 ml] “MB SummerFit” to 1 gal [4.0 l] water)

For temperatures below freezing point:

1 part “MB SummerFit” to 100 parts solvent
(1.34 fl oz [40 ml] “MB SummerFit” to 1 gal [4.0 l] solvent)

امداد خودرو فارما

تلفن شبانه روزی: ۰۲۱-۸۸۸۶۲۰۸۵

FarmaSOS.com

Service and Literature

Your authorized Mercedes-Benz Center has trained technicians and Genuine Mercedes-Benz Parts to service your vehicle properly. For expert advice and quality service, contact an authorized Mercedes-Benz Center.

If you are interested in obtaining service literature for your vehicle, please contact an authorized Mercedes-Benz Center.

We consider this the best way for you to obtain accurate information for your vehicle.

For further information you can find us on the Mercedes-Benz web site **www.mbusa.com** (USA only) or **www.mercedes-benz.ca** (Canada only).

Warning!

To help avoid personal injury, be extremely careful when performing any service work or repairs. Improper or incomplete service or the use of incorrect or inappropriate parts or materials may damage the vehicle or its equipment, which may in turn result in personal injury.

If you have any questions about carrying out any type of service, turn to the advice of an authorized Mercedes-Benz Center.

We reserve the right to make changes in design and equipment.

Therefore, information, illustrations and descriptions in this Operator's Manual might differ from your vehicle.

Reprinting, translation and copying, even of excerpts, is not permitted without our prior authorization in writing.

Press time July 17, 2009

GSP/OIS

Printed in U. S. A.

امداد خود را

تلفن شبانه روزی: ۰۲۱-۸۸۸۶۲۰۸۵

FarmaSOS.com

امداد خودرو فارما

تلفن شبانه روزی: ۰۲۱-۸۸۸۶۲۰۸۵

FarmaSOS.com



2125845881

Order no. 6515 3473 13 Part no. 212 584 58 81 Edition B 2010