



ایجاد خودرو فارما

تلفن شماره روزی: ۰۲۱-۸۸۸۶۲۰۸۵

FarmaSOS.com

Mercedes-Benz

# E-Class

Sedan and Wagon  
Operator's Manual

## Symbols

Registered trademarks:

- BabySmart™ is a registered trademark of the Siemens Automotive Corp.
- Bluetooth® is a registered trademark of the Bluetooth SIG Inc.
- PRE-SAFE® is a registered trademark of Daimler AG.
- HomeLink® is a registered trademark of Prince, a Johnson Controls Company.
- SIRIUS and related brands are registered trademarks of SIRIUS XM Radio Inc.

In this Operator's Manual you will find the following symbols:

### **Warning**

Warning notices draw your attention to hazards that endanger your health or life, or the health or life of others.

**!** Warning notices draw your attention to hazards that could cause damage to your vehicle.

**i** Practical tips or other information that could be helpful to you.

▶ This symbol indicates instructions that you must follow.

▶ A number of these symbols appearing in succession indicates instructions with several steps.

▷ page This symbol tells you where to look for further information on a topic.

▷▷ This symbol marks a warning or procedure which is continued on the next page.

Display Text in the multifunction display/COMAND display.

## Welcome to the world of Mercedes-Benz

Before you drive off, please familiarize yourself with your vehicle and read this manual, especially the safety and warning notices. This will help you to obtain the maximum pleasure from your vehicle and to avoid endangering yourself and others.

The equipment or product designation of your vehicle may vary depending on:

- model
- order
- country specification
- availability

Mercedes-Benz is constantly updating its vehicles to the state of the art.

Mercedes-Benz therefore reserves the right to introduce changes in the following areas:

- design
- equipment
- technical features

You cannot therefore base any claims on the data, illustrations or descriptions contained in this manual.

The following are integral parts of the vehicle:

- Operator's Manual
- Brief Instructions<sup>1</sup>
- Service Booklet
- Supplements relating to vehicle equipment

Keep these documents in the vehicle at all times. When you sell the vehicle, always pass the documents on to the new owner.

The technical documentation team at Daimler AG wishes you safe and pleasant motoring.

Mercedes-Benz USA, LLC

Mercedes-Benz Canada, Inc.

A Daimler Company

امداد خودرو فارما

تلفن شبانه روزی: ۰۸۵-۸۸۸۸۸۸۸۸-۰۲۱

FarmaSOS.com

<sup>1</sup> Canada only.

# امداد خودرو فارما

تلفن شبانه روزی: ۰۲۱-۸۸۸۶۲۰۸۵

**FarmaSOS.com**



---

**Index** ..... 4

---

**Introduction** ..... 20

**At a glance** ..... 25

---

**Safety** ..... 35

---

**Opening and closing** ..... 75

---

**Seats, steering wheel and mirrors** .. 101

---

**Lights and windshield wipers** ..... 117

---

**Climate control** ..... 131

---

**Driving and parking** ..... 147

---

**On-board computer and displays** .... 215

---

**Loading, stowing and features** ..... 273

---

**Maintenance and care** ..... 307

---

**Roadside Assistance** ..... 321

---

**Tires and wheels** ..... 349

---

**Technical data** ..... 383

لیدر خودرو فارما

۰۲۱-۸۸۸۶۲۰۸۸

FarmaSOS.com

- 1, 2, 3 ...
- 115 V socket** ..... 294
- 12 V socket** ..... 292
- 4ETS**  
see ETS/4ETS
- 4MATIC (permanent four-wheel drive)** ..... 193
- A**
- ABS (Anti-lock Braking System)**  
Display message ..... 241  
Function/notes ..... 65  
Warning lamp ..... 265
- Accident (notes)** ..... 323
- Active Blind Spot Assist**  
Display message ..... 252  
Function/information ..... 209
- Active Driving Assistance package** ..... 208
- Active Lane Keeping Assist**  
Display message ..... 251  
Function/information ..... 211
- Active light function (display message)** ..... 245
- Active multicontour seat** ..... 107
- Active service system**  
see Service interval display
- ADAPTIVE BRAKE** ..... 71
- Adaptive Highbeam Assist**  
Display message ..... 246  
Switching on/off ..... 121  
Switching on/off (on-board computer) ..... 230
- AdBlue®**  
Adding ..... 167  
Display message ..... 249
- Air bags**  
Display message ..... 239  
Front air bag (driver, front passenger) ..... 39  
Important safety notes ..... 38  
Knee bag ..... 40  
PASSENGER AIRBAG OFF indicator lamp (only Canada) ..... 48  
PASSENGER AIRBAG OFF indicator lamp (only USA) ..... 43  
Pelvis air bag ..... 42  
Safety guidelines ..... 37  
Side impact air bag ..... 41  
Window curtain air bag ..... 43
- Air-conditioning system**  
see Climate control
- Air dehumidification**  
Activating/deactivating with cooling ..... 138
- Air distribution**  
Setting ..... 140
- Air filter (display message)** ..... 249
- Airflow**  
Setting ..... 141
- AIRMATIC**  
Function/notes ..... 191  
Suspension tuning ..... 192  
Vehicle level ..... 191
- AIRMATIC (display message)** ..... 250
- AIRMATIC (E 550 and E 550 4MATIC)** ..... 191
- Air nozzles**  
see Air vents ..... 144
- Air pressure**  
see Tire pressure
- Air-recirculation mode**  
Activating/deactivating ..... 143
- Air vents** ..... 144  
Glove box ..... 144  
Important safety information ..... 144  
Rear ..... 145  
Setting the center air vents ..... 144  
Setting the side air vents ..... 144
- Alarm system**  
see ATA
- Alertness Assistant**  
see ATTENTION ASSIST
- Ambient lighting (on-board computer)** ..... 230
- AMG menu (on-board computer)** ..... 221
- AMG Ride Control sports suspension (E 63 AMG)** ..... 192
- Anti-lock Braking System**  
see ABS
- Anti-Theft Alarm system**  
see ATA
- Anti-theft system**  
ATA (Anti-Theft Alarm system) ..... 74

- Ashtray** ..... 291
- Assistance menu (on-board computer)** ..... 227
- ATA (Anti-Theft Alarm system)**
- Activating/deactivating ..... 74
  - Function ..... 74
  - Switching off the alarm ..... 74
- ATTENTION ASSIST**
- Activating/deactivating (on-board computer) ..... 228
  - Display message ..... 250
  - Function/notes ..... 201
- Audio menu (on-board computer)** .... 225
- AUTO lights**
- see Light sensor
- Automatic car wash** ..... 314
- Automatic lane recognition system**
- see Lane Keeping Assist ..... 229
- Automatic transmission**
- DIRECT SELECT lever ..... 155
  - Display message ..... 258
  - Driving tips ..... 157
  - Emergency running mode ..... 162
  - Kickdown ..... 158
  - Malfunction ..... 162
  - Program selector button ..... 158
  - Pulling away ..... 151
  - Selector lever ..... 154
  - Starting ..... 151
- B**
- Backrest (display message)** ..... 259
- Bag hook** ..... 281
- BAS (Brake Assist System)** ..... 66
- BAS PLUS (Brake Assist System Plus\*)** ..... 66
- Battery**
- Charging ..... 340
  - Checking (SmartKey) ..... 80
  - Display message ..... 248
  - Important safety guidelines (SmartKey) ..... 80
  - Jump-starting ..... 341
  - Replacing (SmartKey) ..... 80
  - Safety notes ..... 338
- Belt**
- see Seat belts
- Blind Spot Assist**
- Activating/deactivating (on-board computer) ..... 228
  - Display message ..... 252
  - Function/notes ..... 205
- BlueTEC**
- AdBlue® ..... 390
  - Adding AdBlue® ..... 167
- Bottle holder** ..... 289
- Brake fluid**
- Notes ..... 392
- Brake fluid level** ..... 312
- Brake lamp (display message)** ..... 244
- Brakes**
- ABS ..... 65
  - BAS ..... 66
  - BAS PLUS ..... 66
  - Brake fluid (notes) ..... 392
  - Display message ..... 242
  - High-performance brake system .... 174
  - Important safety notes ..... 173
  - Maintenance ..... 174
  - Parking brake ..... 170
  - Warning lamp ..... 263
- Breakdown**
- see Accident (notes)
  - see Flat tire
- Bulb**
- Infrared light ..... 127
- Bulbs**
- High-beam headlamps ..... 126
  - Low-beam headlamps ..... 126
  - Overview ..... 125
  - Parking lamps ..... 126
  - Standing lamps (front) ..... 126
  - Turn signals (front) ..... 127
- C**
- CAC**
- (Customer Assistance Center) ..... 23
- California**
- Important notice for retail customers and lessees ..... 21
- Calling up a malfunction**
- see Display messages

**Capacities**

see Technical data

**Care**

Carpets .....	320
Car wash .....	314
Display .....	318
Gear or selector lever .....	319
Headlamps .....	317
Matte finish .....	316
Night View Assist Plus .....	318
Notes .....	313
Paint .....	316
Plastic trim .....	319
Power washer .....	315
Rear view camera .....	318
Roof lining .....	320
Seat belt .....	320
Seat covers .....	319
Sensors .....	317
Steering wheel .....	319
Tail pipes .....	318
Trim strips .....	319
Washing by hand .....	315
Wheels .....	315
Windows .....	316
Wiper blades .....	317
Wooden trim .....	319

**Cargo compartment cover** ..... 281

**Cargo compartment enlargement** ... 279

**Cargo compartment floor**

Stowage well (under) ..... 285

**Cargo net**

Important safety information ..... 283

**Cargo tie down rings** ..... 280

**CD player/CD changer (on-board computer)** ..... 225

**Center console** ..... 31

**Central locking**

Automatic locking (on-board computer) ..... 231

SmartKey ..... 76

**Changing bulbs**

Headlamps ..... 124

**Changing gears** ..... 157

**Changing the programming**

SmartKey ..... 79

**Child-proof locks**

Rear doors ..... 63

**Children**

In the vehicle ..... 58

Restraint systems ..... 59

**Child seat**

Automatic recognition ..... 48

Automatic recognition/air bag deactivation, self-test ..... 50

Display message ..... 236

LATCH-type (ISOFIX ) child seat anchors ..... 61

Special seat belt retractor ..... 61

Top Tether ..... 62

Troubleshooting ..... 51

**Cigarette lighter** ..... 292

**Classification system for****occupants (OCS)**

Faults ..... 47

Operation ..... 43

System self-test ..... 46

**Climate control**

3-zone automatic climate control . . 135

Activating/deactivating ..... 138

Activating/deactivating air-recirculation mode ..... 143

Controlling automatically ..... 139

Cooling with air dehumidification . . 138

Defrosting the windshield ..... 141

Demisting the windows ..... 142

Dual-zone automatic climate control ..... 133

Important safety information ..... 132

Indicator lamp ..... 139

Maximum cooling ..... 142

Problems with "cooling with air dehumidification" ..... 139

Problems with the rear window heating ..... 142

Rear control panel ..... 137

Refrigerant ..... 392

Setting the air distribution ..... 140

Setting the airflow ..... 141

Setting the air vents ..... 144

Setting the temperature ..... 139

Setting the temperature (rear compartment) ..... 140

Switching the rear window heating on/off ..... 142

Switching the residual heat function on/off .....	143
Switching the ZONE function on/off .....	141
<b>Coat hooks</b> .....	283
<b>Cockpit</b> .....	27
<b>Collapsible spare wheel</b>	
Inflating .....	335
see Emergency spare wheel	
<b>Combination switch</b> .....	120
<b>Combined cargo cover and net</b> .....	282
<b>Compass</b> .....	303
<b>Consumption statistics (on-board computer)</b> .....	220
<b>Convenience closing feature</b> .....	93
<b>Convenience opening feature</b> .....	93
<b>Coolant (engine)</b>	
Checking the level .....	311
Display message .....	246
Notes .....	392
Temperature (on-board computer) ..	221
Temperature gauge .....	216
Warning lamp .....	269
<b>Cooling</b>	
see Climate control	
<b>Cornering light (display message) ...</b>	243
<b>Crash-responsive emergency lighting</b> .....	124
<b>Cruise control</b>	
Cruise control lever .....	178
Display message .....	255
Function/notes .....	177
<b>Cup holder</b> .....	288
Center console .....	288
Rear compartment .....	288
<b>Current fuel consumption (on-board computer)</b> .....	220
<b>Customer Assistance Center (CAC)</b> .....	23
<b>Customer Relations Department</b> .....	23

## D

**Dashboard**

see Cockpit

**Daytime running lamps**

Display message .....	245
Switching on/off (on-board computer) .....	230

**Delayed switch-off**

Exterior lighting (on-board computer) .....	231
Interior lighting (on-board computer) .....	231

**Diesel particle filter** .....**Digital speedometer** .....**DIRECT SELECT lever**

see Automatic transmission

**Display (cleaning instructions)** .....**Display messages**

Brakes .....	241
Calling up (on-board computer) .....	234
Clearing (on-board computer) .....	234
Driving systems .....	250
Engine .....	246
KEYLESS-GO .....	260
Lamps .....	243
Safety systems .....	235
Service interval display .....	313
SmartKey .....	260
Tires .....	255
Vehicle .....	258

**Distance recorder** .....**Distance warning lamp** .....**DISTRONIC PLUS**

Deactivating .....	186
Display message .....	254
Displays in the multifunction display .....	185
Driving tips .....	187
Function/notes .....	179
Setting the specified minimum distance .....	185
Warning lamp .....	270

**Door**

Automatic locking .....	85
Automatic locking (on-board computer) .....	231
Display message .....	259

- Emergency locking ..... 86  
 Emergency unlocking ..... 85  
 Opening (from inside) ..... 84
- Door control panel**  
 Overview ..... 33
- Doors**  
 Important safety notes ..... 84
- Drinking and driving** ..... 172
- Drinks holder**  
 see Cup holder
- Drive program**  
 Automatic ..... 159  
 Manual ..... 160  
 SETUP (on-board computer) ..... 221
- Drive program display** ..... 155
- Driving abroad** ..... 177
- Driving on flooded roads** ..... 175
- Driving safety system**  
 BAS PLUS (Brake Assist System PLUS) ..... 66  
 EBD (Electronic Brake force Distribution) ..... 71  
 ESP® (Electronic Stability Program) ..... 67  
 ETS/4ETS (Electronic Traction System) ..... 68  
 Important safety information ..... 65
- Driving safety systems**  
 ABS (Anti-lock Braking System) ..... 65  
 ADAPTIVE BRAKE ..... 71  
 BAS (Brake Assist System) ..... 66  
 Overview ..... 65  
 PRE-SAFE® Brake ..... 71
- Driving system**  
 AIRMATIC (E 550 and E 550 4MATIC) ..... 191
- Driving systems**  
 Active Blind Spot Assist ..... 209  
 Active Driving Assistance package ..... 208  
 Active Lane Keeping Assist ..... 211  
 AIRMATIC ..... 191  
 AMG Ride Control sports suspension (E 63 AMG) ..... 192  
 ATTENTION ASSIST ..... 201  
 Blind Spot Assist ..... 205  
 Cruise control ..... 177  
 DISTRONIC PLUS ..... 179  
 HOLD function ..... 188  
 Lane Keeping Assist ..... 207  
 Lane Tracking package ..... 205  
 Night View Assist Plus ..... 202  
 Parking Guidance ..... 197  
 PARKTRONIC ..... 194  
 RACE START (AMG vehicles) ..... 190  
 Rear view camera ..... 200
- Driving tips** ..... 157  
 Braking ..... 174  
 DISTRONIC PLUS ..... 187  
 Downhill gradients ..... 173  
 Driving on flooded roads ..... 175  
 Wet road surface ..... 173  
 Winter ..... 176
- DVD audio (on-board computer)** ..... 225

## E

- EASY-ENTRY feature** ..... 112  
 Activating/deactivating (on-board computer) ..... 232
- EASY-EXIT feature** ..... 112  
 Activating/deactivating (on-board computer) ..... 232  
 Crash-responsive ..... 113
- EASY-PACK cargo compartment management system** ..... 284
- EASY-PACK folding luggage-compartment floor** ..... 285
- EASY-PACK load-securing kit** ..... 284
- EASY-PACK rear sill protector** ..... 286
- EBD (Electronic Brake force Distribution)**  
 Display message ..... 242  
 Function/notes ..... 71
- Electrical fuses**  
 see Fuses
- Electronic Brake force**  
 see EBD
- Electronic Stability Program**  
 see ESP®
- Electronic Traction System**  
 see ETS/4ETS
- Emergency call**  
 see mbrace

- Emergency release**
    - Fuel filler flap ..... 164
    - Trunk ..... 90, 91
    - Vehicle ..... 85, 86
  - Emergency running mode**
    - Automatic transmission ..... 162
  - Emergency spare wheel**
    - Storage location ..... 325
    - Stowing ..... 326
  - Emergency tensioning device**
    - Function ..... 57
    - Safety guidelines ..... 37
  - Emergency unlocking**
    - Tailgate ..... 91
  - Emissions purification**
    - Service and warranty information .... 20
  - Engine**
    - Irregular running ..... 153
    - Starting problems ..... 153
    - Starting the engine with the key .... 151
    - Starting with KEYLESS-GO ..... 151
    - Switching off ..... 170
    - Warning lamp Check Engine ..... 268
  - Engine electronics**
    - Malfunction ..... 153
  - Engine number** ..... 386
  - Engine oil**
    - Adding ..... 310
    - Checking the oil level ..... 309
    - Display message ..... 248
    - Lubricant additives ..... 391
    - Notes about oil grades ..... 391
    - Temperature (on-board computer) . 221
    - Viscosity ..... 391
  - ESC (Electronic Stability Control)**
    - see ESP®
  - ESP® (Electronic Stability Program)**
    - Activating/deactivating (AMG vehicles) ..... 70
    - Activating/deactivating (except AMG vehicles) ..... 68
    - Activating/deactivating (on-board computer) ..... 228
    - AMG menu (on-board computer) ... 221
    - Display message ..... 235
    - ETS/4ETS ..... 68
  - Important safety information ..... 67
  - Warning lamp ..... 265
  - ETS/4ETS (Electronic Traction System)** ..... 68
  - Exhaust check** ..... 172
  - Exhaust tail pipe (cleaning instructions)** ..... 318
  - Exterior lighting**
    - see Lights
  - Exterior mirrors**
    - Adjusting ..... 113
    - Dipping (automatic) ..... 114
    - Out of position ..... 114
    - Storing settings (memory function) ..... 115
    - Storing the parking position ..... 114
  - Exterior view** ..... 26
- F**
- First-aid kit** ..... 323
  - Flat tire**
    - Changing a wheel/mounting the spare wheel ..... 331
    - MOExtended run-flat system ..... 337
    - Preparing the vehicle ..... 326
    - Raising the vehicle ..... 333
    - TIREFIT kit ..... 327
  - Floormat** ..... 304
  - Folding bench seat (cargo compartment)** ..... 108
  - Front fog lamp (display message)** ... 244
  - Fuel**
    - Additives ..... 389
    - Notes ..... 388
    - Premium-grade unleaded gasoline . 388
    - Refueling ..... 162
    - Specifications ..... 388
    - Troubleshooting ..... 166
  - Fuel consumption**
    - Current (on-board computer) ..... 220
    - Notes ..... 172
  - Fuel filler cap (display message)** .... 249
  - Fuel filler flap**
    - Emergency release ..... 164
    - Opening/closing ..... 164
  - Fuel filter (display message)** ..... 249

- Fuel level**  
 Calling up the range (on-board computer) ..... 220
- Fuses**  
 Fuse allocation chart ..... 345  
 Fuse box in the cargo compartment ..... 346  
 Fuse box in the engine compartment ..... 346  
 Fuse box in the trunk ..... 346  
 Notes ..... 345
- G**
- Garage door opener**  
 Clearing the memory ..... 303  
 Notes ..... 300  
 Opening/closing the garage door .. 303  
 Programming the remote control ... 301
- Gear indicator (on-board computer)** ..... 221
- Gear or selector lever (cleaning guidelines)** ..... 319
- Genuine Mercedes-Benz parts** ..... 384
- Genuine wood trim and trim strips (cleaning instructions)** ..... 319
- Glove box** ..... 274
- H**
- Headlamp cleaning system** ..... 122  
 Adding washer fluid ..... 312  
 Notes ..... 393
- Headlamp mode (daytime driving)**  
 see Daytime running lamps
- Headlamps**  
 Cleaning ..... 317  
 Misting up ..... 123
- Head restraints**  
 Adjusting (angle) ..... 105  
 Adjusting (electrically) ..... 105  
 Adjusting (rear) ..... 105  
 Installing/removing (rear) ..... 106  
 Luxury ..... 105  
 see NECK-PRO head restraints
- Heating**  
 see Climate control
- High beam flasher** ..... 122
- Hill start assist** ..... 152
- HOLD function**  
 Display message ..... 251  
 Function/notes ..... 188
- Hood**  
 Closing ..... 309  
 Display message ..... 259  
 Opening ..... 308
- Hydroplaning** ..... 175
- I**
- Immobilizer** ..... 73
- Indicator and warning lamps**  
 DISTRONIC PLUS ..... 270
- Insect protection on the radiator** .... 309
- Instrument cluster**  
 Overview ..... 28  
 Submenu (on-board computer) ..... 229  
 Warning and indicator lamps ..... 29
- Instrument cluster lighting** ..... 28
- Instrument lighting**  
 see Instrument cluster lighting
- Interior lighting**  
 Automatic control ..... 124  
 Delayed switch-off (on-board computer) ..... 231  
 Emergency lighting ..... 124  
 Manual control ..... 124  
 Reading lamp ..... 123  
 Setting ambient lighting (on-board computer) ..... 230
- J**
- Jack**  
 Storage location ..... 324  
 Using ..... 333
- Jump-starting** ..... 341
- K**
- KEYLESS-GO**  
 Button ..... 150  
 Convenience closing feature ..... 94  
 Display message ..... 260  
 Locking ..... 77



- Starting the engine ..... 151  
 Unlocking ..... 77
- Key positions**  
 KEYLESS-GO ..... 150  
 SmartKey ..... 149
- Kickdown** ..... 158, 161
- Knee bag** ..... 40
- L**
- Lane-change assistant**  
 see Active Blind Spot Assist  
 see Blind Spot Assist
- Lane Keeping Assist**  
 Activating/deactivating (on-board computer) ..... 229  
 Display message ..... 251  
 Function/information ..... 207
- Lane Tracking package** ..... 205
- LATCH-type (ISOFIX) child seat anchors** ..... 61
- License plate lamp (display message)** ..... 244
- Light**  
 Setting ambient lighting (on-board computer) ..... 230
- Lights**  
 Activating/deactivating the interior lighting delayed switch-off (on-board computer) ..... 231  
 Automatic headlamp mode ..... 119  
 Cornering light function ..... 122  
 Daytime running lamps ..... 119  
 Driving abroad ..... 118  
 Fog lamps ..... 120  
 Hazard warning lamps ..... 122  
 High-beam headlamps ..... 120  
 Light switch ..... 118  
 Low-beam headlamps ..... 119  
 Rear fog lamp ..... 120  
 Switching the Adaptive Highbeam Assist on/off (on-board computer) ..... 230  
 Switching the daytime driving lights on/off (on-board computer) . 230  
 Switching the exterior lighting delayed switch-off on/off (on-board computer) ..... 231  
 Switching the surround lighting on/off (on-board computer) ..... 231
- Light sensor (display message)** ..... 246
- Loading guidelines** ..... 274
- Locking**  
 Automatic ..... 85  
 Emergency locking ..... 86  
 From inside the vehicle (central locking button) ..... 84
- Locking verification signal (on-board computer)** ..... 232
- Low-beam headlamp (display message)** ..... 243
- Luggage holder (EASY-PACK load-securing kit)** ..... 284
- Luggage net** ..... 276
- Lumbar support**  
 4-way lumbar support ..... 108
- Luxury head restraints** ..... 105
- M**
- M+S tires** تلفن شماره ۰۲۱۰۶۶۰۰۰۰۰۰۰۰ 175
- Main-beam headlamps (display message)** ..... 244
- Malfunction message**  
 see Display messages
- Malfunctions relevant to safety**  
 Reporting ..... 23
- Manual drive program** ..... 160
- Message function (PULSE)** ..... 107
- Matte finish (cleaning instructions)** ..... 316
- mbrace**  
 Call priority ..... 299  
 Display message ..... 235  
 Downloading destinations (COMAND) ..... 299  
 Emergency call ..... 296  
 Important safety notes ..... 295  
 Locating a stolen vehicle ..... 300  
 MB info call button ..... 298  
 Remote vehicle locking ..... 300  
 Roadside Assistance button ..... 297  
 Self-test ..... 295

System .....	295
Vehicle remote unlocking .....	299

### Mechanical key

Function/notes .....	79
----------------------	----

<b>Memory card (on-board computer)</b> ..	225
---	-----

<b>Memory function</b> .....	115
------------------------------	-----

### Menu (on-board computer)

AMG .....	221
Assistance .....	227
Audio .....	225
DISTRONIC PLUS .....	185
DVD .....	226
Navigation .....	224
Overview of menus .....	219
Service .....	229
Settings .....	229
Telephone .....	226
Trip .....	220

### Message memory (on-board

computer) .....	234
-----------------	-----

### Messages

see Display messages

### Mirrors

Sun visor .....	290
see Exterior mirrors or Rear-view mirror	

<b>MOExtended run-flat system</b> .....	337
---	-----

### MP3

Operating (on-board computer) .....	225
see separate operating instructions	

<b>Multifunction display</b> .....	218
------------------------------------	-----

### Multifunction steering wheel

Operating the on-board computer ..	217
Overview .....	30

## N

### Navigation

On-board computer .....	224
see separate operating instructions	

### NECK-PRO head restraints

Operation .....	52
Resetting after being triggered .....	53

### Night View Assist Plus

Activating/deactivating .....	203
Cleaning .....	318
Function/notes .....	202
Malfunction .....	205
Problem .....	205

### Notes on breaking-in a new

vehicle .....	148
---------------	-----

## O

### Occupant Classification System (OCS)

Faults .....	47
Operation .....	43
System self-test .....	46

### Occupant safety

Children in the vehicle .....	58
System overview .....	36

<b>Octane number (fuel)</b> .....	388
-----------------------------------	-----

<b>Odometer</b> .....	220
-----------------------	-----

### Off-road

4MATIC .....	193
--------------	-----

### Oil

see Engine oil

### On-board computer

AMG menu .....	221
Assistance menu .....	227
Audio menu .....	225
Convenience submenu .....	232
Display messages .....	234
Factory settings .....	233
Important safety notes .....	216
Instrument cluster submenu .....	229
Lighting submenu .....	230
Message memory .....	234
Navigation menu .....	224
Operating video DVD .....	226
Operation .....	217
Overview of menus .....	219
Service menu .....	229
Settings menu .....	229
Standard display submenu .....	220
Telephone menu .....	226
Trip menu .....	220
Vehicle submenu .....	231

### Operating system

see On-board computer

### Outside temperature

Display .....	217
---------------	-----

### Overhead control panel

Overview .....	32
----------------	----

### Override feature

Rear side windows .....	64
-------------------------	----

<b>P</b>	
<b>Paint code number</b> .....	385
<b>Paintwork (cleaning instructions)</b> ...	316
<b>Panic alarm</b> .....	64
<b>Panorama roof with power tilt/ sliding panel</b>	
Opening/closing .....	97
Resetting .....	98
<b>Parking</b> .....	169
<b>Parking aid</b>	
Parking Guidance .....	197
PARKTRONIC .....	194
Rear view camera .....	200
<b>Parking brake</b> .....	170
<b>Parking Guidance</b> .....	197
Display message .....	252
<b>Parking lamp (display message)</b> .....	245
<b>Parking position</b>	
Exterior mirror on the front- passenger side .....	114
<b>PARKTRONIC</b>	
Activating/deactivating .....	196
Function/notes .....	194
Malfunction .....	197
Problem .....	197
Range of the sensors .....	194
Warning display .....	195
<b>PASSENGER AIRBAG OFF indicator lamp (only Canada)</b> .....	48
<b>PASSENGER AIRBAG OFF indicator lamp (only USA)</b> .....	43
<b>Pedals</b> .....	172
<b>Permanent display (on-board computer)</b> .....	230
<b>Permanent four-wheel drive</b> see 4MATIC	
<b>Plastic hooks</b> .....	280
<b>Plastic trim (cleaning instructions)</b> .	319
<b>Power washers</b> .....	315
<b>Power windows</b> see Side windows	
<b>Pre-emptive occupant safety system</b> see PRE-SAFE® system	
<b>PRE-SAFE® Brake (vehicles with DISTRONIC PLUS)</b>	
Activating/deactivating (on- board computer) .....	228
Function/notes .....	71
<b>PRE-SAFE® Brake (vehicles with DISTRONIC PLUS)</b>	
Display message .....	236
Warning lamp .....	270
<b>PRE-SAFE® system</b>	
Display message .....	235
Operation .....	51
<b>Product information</b> .....	20
<b>Program selector</b> .....	158
<b>Program selector button</b> .....	158
<b>Pulling away</b>	
♦ Automatic transmission .....	151
<b>R</b>	
<b>RACE START (AMG vehicles)</b> .....	190
<b>RACETIMER (on-board computer)</b> ...	222
<b>Radar sensor system</b>	
Display message .....	251
<b>Radar sensor system (on-board computer)</b> .....	232
<b>Radiator cover</b> .....	309
<b>Radio</b>	
Changing stations (on-board computer) .....	225
see separate operating instructions	
<b>Range (on-board computer)</b> .....	220
<b>Rear axle level control</b> .....	192
<b>Rear compartment</b>	
Setting the airflow .....	141
Setting the air vents .....	145
Setting the temperature .....	140
<b>Rear fog lamp (display message)</b> ....	244
<b>Rear seat backrest</b>	
Display message .....	259
Folding forwards/back .....	278
<b>Rear seat backrest (display message)</b> .....	259
<b>Rear sill protector</b> .....	286
<b>Rear view camera</b>	
Function/notes .....	200
<b>Rear view camera (cleaning instructions)</b> .....	318

- Rear-view mirror**  
 Anti-glare (manual) ..... 113  
 Dipping (automatic) ..... 114
- Rear window blind** ..... 290
- Rear window heating**  
 Malfunction ..... 142  
 Switching on/off ..... 142
- Rear window wiper** ..... 128  
 Replacing the wiper blade ..... 129
- Refueling** ..... 162
- Remote control**  
 Programming (garage door opener) ..... 301
- Reporting**  
 Malfunctions relevant to safety ..... 23
- Reserve fuel**  
 Display message ..... 249  
 Warning lamp ..... 268
- Residual heat**  
 Switching on/off ..... 143
- Restraint systems**  
 see SRS
- Retaining hook** ..... 281
- Reversing lamp (display message)** .. 245
- Roadside Assistance (breakdown)** ..... 21
- Roller blind**  
 see Roller sunblind
- Roller sunblind**  
 Opening/closing ..... 98  
 Panorama roof with power tilt/  
 sliding panel ..... 98  
 Rear side windows ..... 290  
 Rear window ..... 290
- Roof carrier** ..... 287
- Roof lining and carpets (cleaning guidelines)** ..... 320
- Route**  
 see Route guidance (on-board computer)
- Route guidance (on-board computer)** ..... 224
- S**
- Safety**  
 Children in the vehicle ..... 58  
 Child restraint systems ..... 59
- Occupant Classification System (OCS) ..... 43  
 Overview of occupant safety systems ..... 36
- Safety systems**  
 see Driving safety systems
- Seat**  
 Active multicontour seat ..... 107
- Seat belts**  
 Adjusting the driver's and front-passenger seat belt ..... 56  
 Adjusting the height ..... 56  
 Belt force limiters ..... 57  
 center rear-compartment seat ..... 57  
 Cleaning ..... 320  
 Correct usage ..... 54  
 Emergency Tensioning Devices ..... 57  
 Fastening ..... 55  
 Important safety guidelines ..... 53  
 Releasing ..... 57  
 Safety guidelines ..... 37  
 Special seat belt retractor ..... 61  
 Switching belt adjustment on/off (on-board computer) ..... 233  
 Warning lamp ..... 264  
 Warning lamp (function) ..... 57
- Seat heating**  
 Indicator lamp (Malfunction) ..... 111
- Seats**  
 Adjusting (electrically) ..... 104  
 Adjusting the 4-way lumbar support ..... 108  
 Adjusting the head restraint ..... 105  
 Cleaning the cover ..... 319  
 Correct driver's seat position ..... 102  
 Important safety notes ..... 103  
 Storing settings (memory function) ..... 115  
 Switching seat heating on/off ..... 110  
 Switching the seat ventilation on/off ..... 111
- Seat ventilation**  
 Indicator lamp (Malfunction) ..... 111
- Sensors (cleaning instructions)** ..... 317
- Service indicator**  
 see Service interval display

- Service interval display** ..... 313
  - Displaying a service message (on-board computer) ..... 313
- Service menu (on-board computer)** . 229
- Service products**
  - AdBlue® special additives ..... 390
  - Brake fluid ..... 392
  - Capacities ..... 387
  - Coolant (engine) ..... 392
  - Engine oil ..... 391
  - Fuel ..... 388
  - Important safety notes ..... 386
  - Notes ..... 386
  - Refrigerant (air-conditioning system) ..... 392
  - Washer fluid ..... 393
- Settings**
  - Factory (on-board computer) ..... 233
  - On-board computer ..... 229
- SETUP (on-board computer)** ..... 221
- Shift ranges** ..... 159
- Showing the distance display (on-board computer)** ..... 227
- Side impact air bag** ..... 41
- Side marker lamp (display message)** ..... 245
- Side windows**
  - Convenience closing feature ..... 93
  - Convenience opening feature ..... 93
  - Important safety information ..... 91
  - Opening/closing ..... 92
  - Resetting ..... 94
  - Troubleshooting ..... 94
- Skibag** ..... 276
- Sliding sunroof**
  - Important safety information ..... 95
  - Troubleshooting ..... 99
  - see Panorama roof with power tilt/sliding panel
  - see Tilt/sliding sunroof
- SmartKey**
  - Changing the battery ..... 80
  - Changing the programming ..... 79
  - Checking the battery ..... 76, 80
  - Convenience closing feature ..... 93
  - Convenience opening feature ..... 93
  - Display message ..... 260
  - Important safety notes ..... 76
  - Malfunction ..... 82
  - Starting the engine ..... 151
- Snow chains** ..... 176
- Socket** ..... 292
  - Dashboard ..... 293
  - Rear compartment ..... 293
- SOS**
  - see mbrace
- Spare wheel**
  - Notes/data ..... 380
  - Storage location ..... 325
  - Stowing ..... 326
  - see Emergency spare wheel
- Speedometer**
  - Additional speedometer (on-board computer) ..... 220
  - Segments ..... 217
  - Setting the unit (on-board computer) ..... 229
- SPORT handling mode**
  - Activating/deactivating (AMG vehicles) ..... 69
  - Warning lamp ..... 266
- SRS (Supplemental Restraint System)**
  - Display message ..... 237
  - Introduction ..... 36
  - Warning lamp ..... 267
  - Warning lamp (function) ..... 36
- Standard display (on-board computer)** ..... 220
- Starting the engine**
  - Important safety notes ..... 151
- Station**
  - see Radio
- Steering (display message)** ..... 260
- Steering wheel**
  - Adjusting (electrically) ..... 111
  - Buttons (on-board computer) ..... 217
  - Cleaning ..... 319
  - Important safety notes ..... 111
  - Memory function (storing settings) ..... 111
  - Steering wheel heating ..... 112
  - Storing settings (memory function) ..... 115

- Steering wheel heating**  
Indicator lamp (Malfunction) ..... 112
- Steering wheel paddle shifters** ..... 159
- Stowage compartments**  
Armrest (under) ..... 275  
Glove box ..... 274
- Stowage space**  
Center console ..... 275  
Cup holders ..... 288  
Important safety information ..... 274
- Stowage well**  
Trunk floor (under) ..... 285
- Submenu (on-board computer)**  
Convenience ..... 232  
Factory setting ..... 233  
Instrument cluster ..... 229  
Lights ..... 230  
Standard display ..... 220  
Vehicle ..... 231
- Summer opening**  
see Convenience opening feature
- Sun visor** ..... 289
- Supplemental Restraint System**  
see SRS
- Surround lighting (on-board computer)** ..... 231
- Suspension tuning** ..... 192  
SETUP (on-board computer) ..... 221
- Switching off the alarm (ATA)** ..... 74
- T**
- Tachometer** ..... 217
- Tailgate**  
Display message ..... 259  
Emergency unlocking ..... 91  
Limiting the opening angle ..... 90
- Tail lamps (Display message)** ..... 244
- Tank content**  
Fuel gauge ..... 28
- Technical data** ..... 384  
E 350 ..... 393  
E 350 4MATIC ..... 394  
E 350 BlueTEC ..... 393  
E 550 ..... 394  
E 550 4MATIC ..... 395  
E 63 AMG ..... 395  
Tires/wheels ..... 374
- TELEAID**  
Call priority ..... 299  
Display message ..... 235  
Downloading destinations (COMAND) ..... 299  
Emergency call ..... 296  
Important safety notes ..... 295  
Locating a stolen vehicle ..... 300  
MB info call button ..... 298  
Remote vehicle locking ..... 300  
Roadside Assistance button ..... 297  
Self-test ..... 295  
System ..... 295  
Vehicle remote unlocking ..... 299
- Telephone**  
Accepting a call ..... 227  
Display message ..... 260  
Menu (on-board computer) ..... 226  
Number from the phone book ..... 227  
Redialing ..... 227  
Rejecting/ending a call ..... 227
- Telephone compartment** ..... 275
- Telescopic rod (EASY-PACK load-securing kit)** ..... 285
- Temperature**  
Coolant ..... 216  
Coolant (on-board computer) ..... 221  
Engine oil (on-board computer) ..... 221  
Outside temperature ..... 217  
Setting ..... 139
- Theft deterrent locking system**  
Immobilizer ..... 73
- Through-loading** ..... 278
- Through-loading feature** ..... 278
- Tilt/sliding sunroof**  
Opening/closing ..... 97  
Resetting ..... 97
- Timer (on-board computer)** ..... 222
- Tiredness assistant**  
see ATTENTION ASSIST
- TIREFIT kit** ..... 327
- Tire pressure**  
Calling up (on-board computer) ..... 357  
Checking manually ..... 355  
Display message ..... 255  
Maximum ..... 360  
Notes ..... 353  
Not reached (TIREFIT) ..... 330

Pressure loss warning .....	355	PSI (pounds per square inch)	
Reached (TIREFIT) .....	330	(definition) .....	373
Recommended .....	352	Replacing .....	367
<b>Tire pressure monitoring system</b>		Service life .....	351
Function/notes .....	357	Sidewall (definition) .....	373
Restarting .....	359	Speed index (definition) .....	372
Warning lamp .....	271	Storing .....	352
<b>Tires</b>		Structure and characteristics	
Aspect ratio (definition) .....	373	(definition) .....	371
Average weight of the vehicle		Temperature .....	366
occupants (definition) .....	371	TIN (Tire Identification Number)	
Bar (definition) .....	371	(definition) .....	373
Characteristics .....	371	Tire bead (definition) .....	373
Checking .....	351	Tire pressure (definition) .....	373
Cleaning .....	352	Tire pressures (recommended) .....	371
Definition of terms .....	371	Tire size (data) .....	374
Direction of rotation .....	365	Tire size designation, load-bearing	
Distribution of the vehicle		capacity, speed index .....	368
occupants (definition) .....	374	Tire tread .....	351
DOT, Tire Identification Number		Tire tread (definition) .....	373
(TIN) .....	370	Total load limit (definition) .....	374
DOT (Department of		Traction .....	366
Transportation) (definition) .....	371	Traction (definition) .....	373
Flat tire .....	326	Tread wear .....	366
GAWR (Gross Axle Weight Rating)		Uniform Tire Quality Grading	
(definition) .....	372	Standards .....	365
Guidelines to be observed .....	351	Uniform Tire Quality Grading	
GVW (Gross Vehicle Weight)		Standards (definition) .....	371
(definition) .....	372	Unladen weight (definition) .....	372
GVWR (Gross Vehicle Weight		Wear indicator (definition) .....	373
Rating) (definition) .....	372	Wheel rim (definition) .....	372
Increased vehicle weight due to		<b>Tires and wheels (important safety</b>	
optional equipment (definition) .....	372	<b>information)</b> .....	350
Kilopascal (kPa) (definition) .....	372	<b>Top Tether</b> .....	62
Labeling (overview) .....	367	<b>Towing</b>	
Load bearing index (definition) .....	373	Important safety guidelines .....	343
Load index .....	370	Installing the towing eye .....	343
Load index (definition) .....	372	Removing the towing eye .....	344
Maximum loaded vehicle weight		<b>Transfer case</b> .....	162
(definition) .....	372	<b>Transmission position</b>	
Maximum load on a tire		<b>display</b> .....	155
(definition) .....	373	<b>Transmission positions</b> .....	157
Maximum permissible tire		<b>Trip computer (on-board</b>	
pressure (definition) .....	373	<b>computer)</b> .....	220
Maximum tire load .....	365	<b>Trip odometer</b>	
Maximum tire load (definition) .....	372	Calling up .....	220
Optional equipment weight		Resetting (on-board computer) .....	221
(definition) .....	373		

- Trunk**  
 Automatic opening ..... 88, 89  
 Emergency release ..... 90, 91  
 Locking separately ..... 90
- Trunk/tailgate**  
 Important safety guidelines ..... 86
- Trunk lid**  
 Display message ..... 259
- Turn signal (display message)** ..... 243
- Turn signals** ..... 120
- Type plate**  
 see Vehicle identification plate
- U**
- Unlocking**  
 Emergency unlocking ..... 85  
 From inside the vehicle (central  
 unlocking button) ..... 84
- V**
- Vanity mirror**  
 Sun visor ..... 290
- Vehicle**  
 Data acquisition ..... 24  
 Emergency unlocking ..... 85, 86  
 Equipment ..... 20  
 Exterior view ..... 26  
 Individual settings (on-board  
 computer) ..... 229  
 Loading ..... 360  
 Lowering ..... 337  
 Maintenance ..... 21  
 Parking up ..... 171  
 Raising ..... 333  
 Reporting problems ..... 23  
 Towing away ..... 343  
 Tow-starting ..... 343  
 Transporting ..... 345
- Vehicle data**  
 see Technical data
- Vehicle identification number**  
 see VIN
- Vehicle identification plate** ..... 385
- Vehicle level** ..... 191
- Vehicle level (display message)** ..... 250
- Vehicle tool kit** ..... 324
- Video (DVD)** ..... 226
- Video DVD (on-board computer)** ..... 226
- VIN** ..... 385
- W**
- Warning and indicator lamps**  
 ABS ..... 265  
 Brakes ..... 263  
 Check Engine ..... 268  
 Coolant ..... 269  
 ESP® ..... 265  
 ESP® OFF ..... 266  
 Fuel tank ..... 268  
 Overview ..... 29  
 PASSENGER AIRBAG OFF  
 indicator lamp (only Canada) ..... 48  
 PASSENGER AIRBAG OFF  
 indicator lamp (only USA) ..... 43  
 Reserve fuel ..... 268  
 Seat belt ..... 264  
 SPORT handling mode ..... 266  
 SRS ..... 267  
 Tire pressure monitor ..... 271
- Warranty** ..... 384
- Wheel bolt tightening torque** ..... 337
- Wheel chock** ..... 332
- Wheels**  
 Changing/replacing ..... 367  
 Changing a wheel ..... 331  
 Checking ..... 351  
 Cleaning ..... 315  
 Guidelines to be observed ..... 351  
 Mounting a wheel ..... 335  
 Removing a wheel ..... 334  
 Tightening torque ..... 337  
 Wheel size/tire size ..... 374
- Window curtain air bag**  
 Display message ..... 237  
 Operation ..... 43
- Windows**  
 see Side windows
- Windows (cleaning instructions)** ..... 316
- Windshield**  
 Defrosting ..... 141
- Windshield washer fluid (display  
 message)** ..... 260



**Windshield washer system**

Adding washer fluid .....	312
Notes .....	393

**Windshield wipers**

Important safety notes .....	127
Replacing the wiper blades .....	129
Switching on/off .....	128
Troubleshooting .....	130

**Winter operation** .....

Radiator cover .....	309
----------------------	-----

**Winter tires**

M+S tires .....	175
-----------------	-----

**Wiper blades**

Cleaning .....	317
----------------	-----

امداد خودرو فارما

تلفن شبانه روزی: ۰۲۱-۸۸۸۶۲۰۸۵

FarmaSOS.com

## Product information

We recommend using genuine Mercedes-Benz parts as well as conversion parts and accessories explicitly approved by us for your vehicle model.

We have tested these parts to determine their reliability, safety and special suitability for Mercedes-Benz vehicles. Despite ongoing market research, Mercedes-Benz is unable to assess other parts. We cannot therefore be held responsible for them, even if in individual cases an official approval or authorization by governmental or other agencies should exist. The use of non-approved parts could affect your vehicle's operating safety. Mercedes-Benz therefore recommends that you use genuine Mercedes-Benz parts, conversion parts and accessories that have been approved for the type of vehicle. Genuine Mercedes-Benz parts, approved conversion parts and accessories are available from any authorized Mercedes-Benz Center. In addition, you will receive advice about permissible technical modifications, and the parts will be professionally installed.

## Operator's Manual

### Notes on the Operator's Manual

This Operator's Manual contains a great deal of helpful information. We urge you to read it carefully and familiarize yourself with the vehicle before driving.

For your own safety and longer service life of the vehicle, we urge you to follow the instructions and warnings contained in this Operator's Manual. Ignoring them could result in damage to the vehicle or personal injury to you or others. Vehicle damage caused by failure to follow instructions is not covered by the Mercedes-Benz Limited Warranty.

## Vehicle equipment

This manual describes all the standard and optional equipment of your vehicle available at the time of publication of the Operator's Manual. Country-specific differences are possible. Note that your vehicle may not be equipped with all functions described. This also refers to safety-related systems and functions. The equipment in your vehicle may therefore differ from that shown in the descriptions and illustrations. All the systems found in your vehicle are listed in the original purchase agreement of your vehicle. Should you have any questions concerning equipment and operation, please consult an authorized Mercedes-Benz Center.

The Operating Instructions and the Maintenance Booklet are important documents and should be kept in the vehicle.

## Service and vehicle operation

### Service and literature

The Service and Warranty Information booklet contains detailed information about the warranties covering your vehicle. Your authorized Mercedes-Benz Center will replace and repair any factory-fitted parts based on the terms and conditions of the following warranties:

- New Vehicle Limited Warranty
- Emission System Warranty
- Emission Performance Warranty
- California, Connecticut, Maine, Massachusetts, New York, Pennsylvania, Rhode Island and Vermont
- State Warranty Enforcement Laws (Lemon Laws)

### Information for customers in California

Under California law you may be entitled to a replacement of your vehicle or a refund of the purchase price or lease price, if after a reasonable number of repair attempts Mercedes-Benz USA, LLC and/or its authorized repair or service facilities fail to fix one or more substantial defects or malfunctions in the vehicle that are covered by its express warranty. During the period of 18 months from original delivery of the vehicle or the accumulation of 18 000 miles (approximately 29 000 km) on the odometer of the vehicle, whichever occurs first, a reasonable number of repair attempts is presumed for a retail buyer or lessee if one or more of the following occurs:

- (1) the same substantial defect or malfunction results in a condition that is likely to cause death or serious bodily injury if the vehicle is driven, that defect or malfunction has been subject to repair two or more times, and you have directly notified Mercedes-Benz USA, LLC in writing of the need for its repair.
- (2) the same substantial defect or malfunction of a less serious nature than category (1) has been subject to repair four or more times and you have directly notified Mercedes-Benz in writing of the need for its repair.
- (3) the vehicle is out of service by reason of repair of the same or different substantial defects or malfunctions for a cumulative total of more than 30 calendar days.

Please send your written notice to:  
 Mercedes-Benz USA, LLC  
 Customer Assistance Center  
 One Mercedes Drive  
 Montvale, NJ 07645-0350

### Maintenance

The Service and Warranty Information Booklet describes all necessary maintenance work that should be performed at regular intervals.

Always have the Service and Warranty Information Booklet with you when you bring the vehicle to an authorized Mercedes-Benz Center. The service advisor will record each service in the Service and Warranty Information Booklet for you.

### Roadside Assistance

The Mercedes-Benz Roadside Assistance Program provides factory-trained technical help in the event of a breakdown. Calls to the toll-free Roadside Assistance number will be answered by Mercedes-Benz Customer Assistance Representatives 24 hours a day, 365 days a year.

**1-800-FOR-MERCEdes(1-800-367-6372) (USA)**

**1-800-387-0100 (Canada)**

For additional information refer to the Mercedes-Benz Roadside Assistance Program brochure (in the USA) or the Roadside Assistance section of the Service and Warranty Information Booklet (in Canada) You will find both in your vehicle literature portfolio.

### Change of address or ownership

In the event of a change of address, be sure to send in the "Change of Address Notice" found in the Service and Warranty Information Booklet, or simply call the Mercedes-Benz Customer Assistance Center (in the USA) at 1-800-FOR-MERCEdes (1-800-367-6372) or Customer Service (in Canada) at 1-800-387-0100. This will assist us in contacting you in a timely manner should the need arise.

If you sell your Mercedes, please leave all literature with the vehicle to make it available to the next operator.

If you bought this vehicle used, be sure to find in the "Notice of Purchase of Used Car" found in the Service and Warranty Information Booklet, or call the Mercedes-Benz Customer Assistance Center (in the USA) at 1-800-FOR-MERCEdes (1-800-367-6372) or Customer Service (in Canada) at 1-800-387-0100.

### Vehicle operation outside the USA and Canada

If you plan to operate your vehicle in foreign countries, please be aware that:

- Service facilities or replacement parts may not be readily available.
- Unleaded gasoline for vehicles with catalytic converters may not be available. The use of leaded fuels can damage the catalytic converter.
- Gasoline may have a considerably lower octane rating. Improper fuel can cause engine damage.

Certain Mercedes-Benz models are available for delivery in Europe under our European Delivery Program. For details, consult an authorized Mercedes-Benz Center or write to one of the following addresses:

#### In the USA

Mercedes-Benz USA, LLC  
European Delivery Department  
One Mercedes Drive  
Montvale, NJ 07645-0350

#### In Canada

Mercedes-Benz Canada, Inc.  
European Delivery Department  
98 Vanderhoof Avenue  
Toronto, Ontario M4G 4C9

## Operating safety

### Safety notes

#### Warning

Work improperly carried out on electronic components and associated software could cause them to cease functioning. Because the vehicle's electronic components are interconnected, any modifications made may produce an undesired effect on other systems. Electronic malfunctions could seriously impair the operating safety of your vehicle.

Contact an authorized Mercedes-Benz Center for repairs or modifications to electronic components.

Other improper work or modifications on the vehicle could also have a negative impact on the operating safety of the vehicle.

Some safety systems only function when the engine is running. You should therefore never turn off the engine while driving.

#### Warning تلفن شش

Heavy blows against the vehicle underbody or tires/wheels may cause serious damage and impair the operating safety of your vehicle. Such blows can be caused, for example, by running over an obstacle, road debris or a pothole. If you feel a sudden significant vibration or ride disturbance, or you suspect that damage to your vehicle has occurred:

- turn on your hazard warning flashers.
- slow down carefully.
- drive with caution to an area which is a safe distance from the road.

Inspect the vehicle underbody and tires/wheels for possible damage. If the vehicle appears unsafe, have it towed to the nearest authorized Mercedes-Benz Center or other qualified maintenance or repair facility for further inspection or repairs.

## Proper use of the vehicle

To ensure proper use of the vehicle, you must familiarize yourself with the following information and rules:

- safety notes in this Operator's Manual
- technical data in this Operator's Manual
- traffic rules and regulations
- laws and safety standards pertaining to motor vehicles

### **Warning!**

Various warning labels are attached to your vehicle. These warning labels are intended to make you and others aware of various risks. Do not remove any of these warning labels unless explicitly instructed to do so by information on the label itself.

Removing warning labels may cause you and others to be unaware of certain risks which may result in an accident and/or personal injury.

## Problems with your vehicle

If you should experience a problem with your vehicle, particularly one that you believe may affect its safe operation, we urge you to contact an authorized Mercedes-Benz Center immediately to have the problem diagnosed and rectified. If the problem is not resolved to your satisfaction, please discuss the problem with the Mercedes-Benz Center again or, if necessary, contact us at one of the following addresses.

### In the USA

Customer Assistance Center  
Mercedes-Benz USA, LLC  
One Mercedes Drive  
Montvale, NJ 07645-0350

### In Canada

Customer Relations Department  
Mercedes-Benz Canada, Inc.  
98 Vanderhoof Avenue  
Toronto, Ontario M4G 4C9

### Reporting malfunctions relevant to safety

For the USA only:

The following text is reproduced as required of all manufacturers according to Title 49, Code of U.S. Federal Regulations, Part 575 pursuant to the National Traffic and Motor Vehicle Safety Act of 1966.

### Reporting safety defects

If you believe that your vehicle has a defect which could cause a crash or could cause injury or death, you should immediately inform the National Highway Traffic Safety Administration (NHTSA) in addition to notifying Mercedes-Benz USA, LLC.

If NHTSA receives similar complaints, it may open an investigation, and if it finds that a safety defect exists in a group of vehicles, it may order a recall and remedy campaign. However, NHTSA cannot become involved in individual problems between you, your dealer, or Mercedes-Benz USA, LLC.

To contact NHTSA, you may call the Vehicle Safety Hotline toll-free at 1-888-327-4236 (TTY: 1-800-424-9153); go to: <http://www.safercar.gov>; or write to: Administrator, NHTSA Headquarters, 1200 New Jersey Avenue, SE, West Building, Washington, DC 20590.

You can also obtain additional information about vehicle safety from:

<http://www.safercar.gov>.

### Limited Warranty

**!** Follow the instructions in this manual about the proper operation of your vehicle as well as about possible vehicle damage. Damage to your vehicle that arises from culpable contraventions against these instructions are not covered either by Mercedes-Benz Limited Warranty or by the New or Used-Vehicle Warranty of Daimler AG.

### Data stored in the vehicle

#### Information regarding electronic recording devices

(Including California Code Supplement § 9951)

Please note that your vehicle is equipped with devices that can record vehicle systems data. If your vehicle is equipped with mbrace<sup>2</sup> data is transmitted in the event of an accident.

This information serves, for example, to test vehicle systems after an accident and to continually improve vehicle safety.

Daimler AG can access this data and submit it:

- for safety research or vehicle diagnosis purposes
- with the consent of the vehicle owner or lessee
- in response to an official request by law enforcement or other government agency
- for use in arbitration of disputes that involve Daimler AG, its subsidiaries or its sales and service organizations
- as otherwise required or permitted by law

Please observe the mbrace<sup>2</sup> order agreement regarding further details on data that this system records and transmits.

<sup>2</sup> The system is called TELEAID in Canada.

Exterior view .....	26
Cockpit .....	27
Instrument cluster .....	28
Multifunction steering wheel .....	30
Center console .....	31
Overhead control panel .....	32
Door control panel .....	33

# امداد خودرو فارما

تلفن شبانه روزی: ۰۲۱-۸۸۸۶۲۰۸۵

[FarmaSOS.com](http://FarmaSOS.com)

## Exterior view

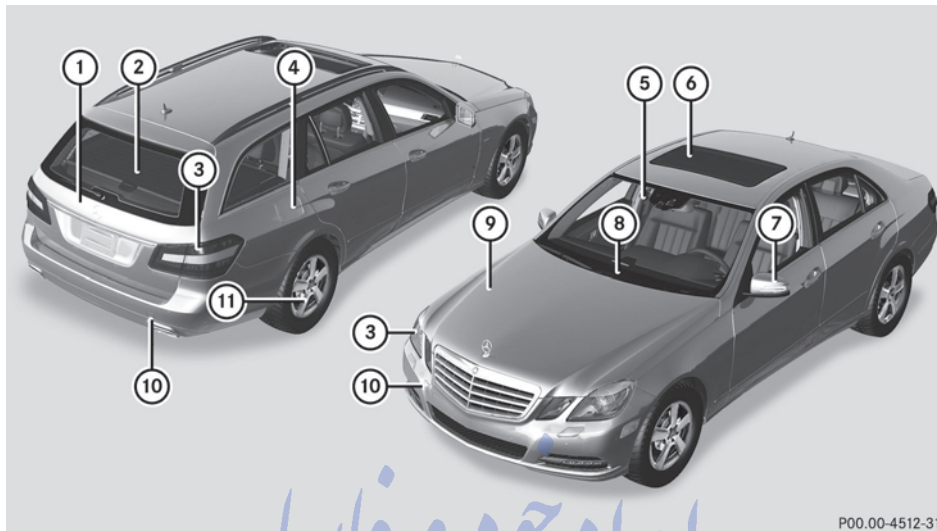

P00.00-4512-31

Function	Page	Function	Page
① Trunk lid/tailgate Vehicle tool kit	324	⑦ Exterior mirrors	113
② Rear window defroster	142	⑧ Windshield wipers	127
③ Lights	124	⑨ Opening the hood Engine oil	308 309
④ Fuel filler flap	162	Coolant	311
⑤ Defrosting the windshield Cleaning the windows	141 316	⑩ Towing	343
⑥ Sliding sunroof	95	⑪ Tires and wheels Flat tire	350 326



## Cockpit

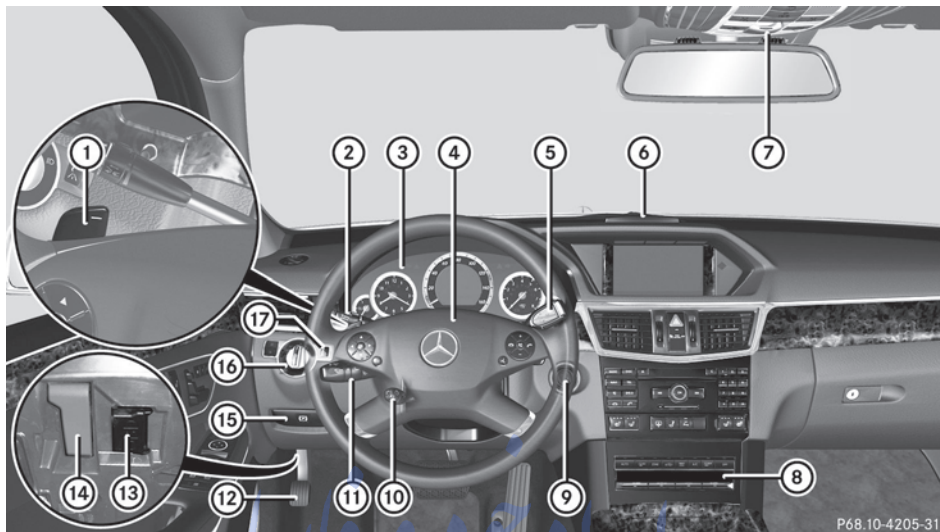

	Function	Page		Function	Page
①	Steering wheel paddle shifters	159	⑩	Adjusts the steering wheel electrically	111
②	Cruise control lever	178		Steering wheel heating	112
③	Instrument cluster	28	⑪	Combination switch	120
④	Horn		⑫	Parking brake	170
⑤	DIRECT SELECT lever	155	⑬	On-board diagnostic socket	
⑥	PARKTRONIC warning display	194	⑭	Opens the hood	308
⑦	Overhead control panel	32	⑮	Releases the parking brake	170
⑧	Operates the automatic climate control system	132	⑯	Light switch	118
⑨	Ignition lock Start/Stop button	149 150	⑰	Night View Assist Plus	202

## Instrument cluster

## Overview



P54.32-8245-31

	Function	Page
①	Fuel gauge	
②	Speedometer with segments	217
③	Multifunction display	218
④	Coolant temperature gauge	216
⑤	Tachometer	217

	Function	Page
⑥	Clock	
⑦	Brightness control knob for the instrument cluster lighting: turn clockwise or anti-clockwise	

## Warning and indicator lamps

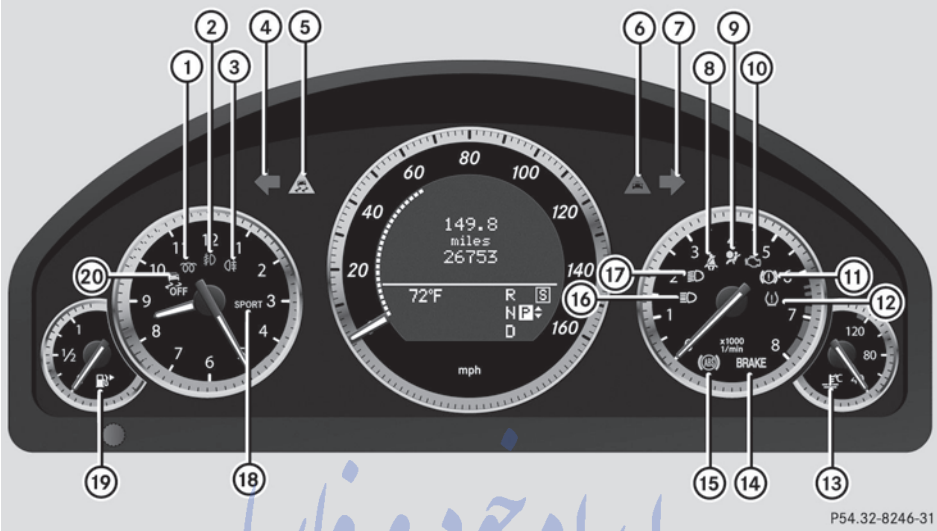











P54.32-8246-31

	Function	Page		Function	Page
①	Diesel engine: preglow	151	⑫	Tire pressure monitor	271
②	Fog lamp	120	⑬	Coolant	269
③	Rear fog lamp	120	⑭	Brakes (USA only)	263
④	Turn signal	120	⑮	ABS	265
⑤	ESP®	265	⑯	High beam	120
⑥	Distance warning lamp	270	⑰	Low beam	119
⑦	Turn signal	120	⑱	SPORT handling mode in AMG vehicles	266
⑧	Seat belt	264	⑲	Reserve fuel	268
⑨	SRS	267	⑳	ESP® OFF	265
⑩	Engine diagnostics	268			
⑪	Brakes (Canada only)	263			

Multifunction steering wheel



P46.10-3134-31

Function	Page	Function	Page
① Multifunction display	218	⑤  Back or deactivates voice control	
② COMAND; see the separate operating instructions		⑥  Selects a menu	219
③   Makes/accepts or rejects/ends a call	226	 Selects the submenu or scrolls through lists	219
  Adjusts the volume or operates the RACETIMER in AMG vehicles	222	 Confirms selections and hides display messages	
 Mute			
④  Activates voice control; see the separate operating instructions			

## Center console

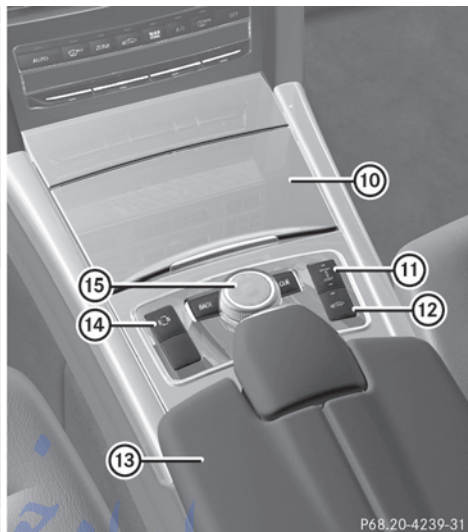
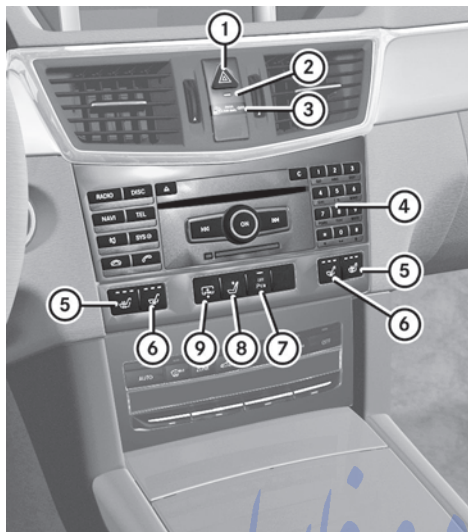

P68,20-4239-31







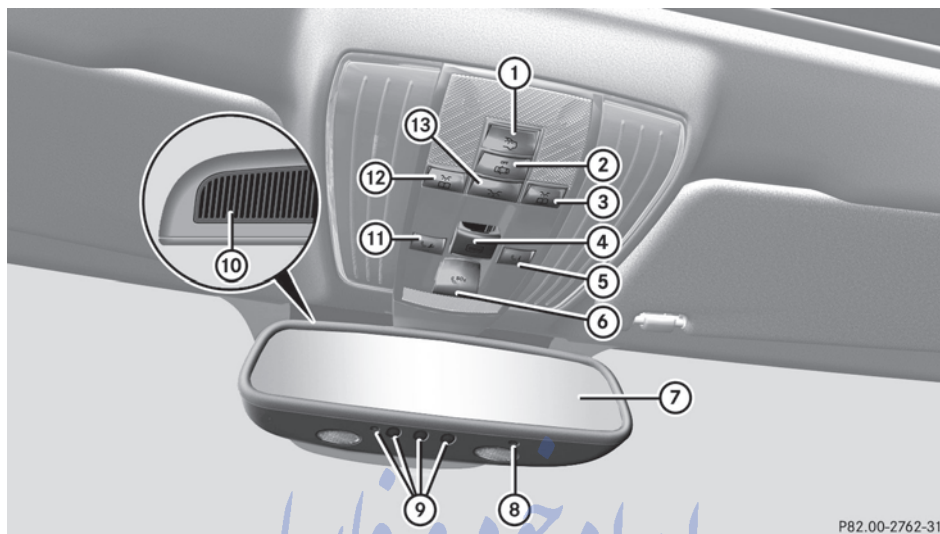





Function	Page	Function	Page
① Hazard warning lamps	122	⑨ Sedan: rear window roller sunblind	290
② ATA indicator lamp	74	⑩ Stowage compartment	274
③ Indicator lamp (USA only)	43	Ashtray	291
Indicator lamp (Canada only)	48	Cigarette lighter	292
④ COMAND; see the separate operating instructions		Cup holder	288
⑤ Seat heating	110	⑪ Sets the suspension tuning	192
⑥ Seat ventilation	111	⑫ Sets the vehicle level	191
⑦ PARKTRONIC	194	⑬ Stowage compartment	274
⑧ Lowers the rear head restraints	105	⑭ Selects the drive program	158
		⑮ COMAND controller	

## Overhead control panel

At a glance



P82.00-2762-31

Function	Page	Function	Page
①  To switch the rear interior lighting on/off	124	⑦ Rear-view mirror	114
②  To switch the automatic interior lighting control on/off	124	⑧  Integrated electronic compass	303
③  To switch the right-hand reading lamp on/off	123	⑨  Buttons for the garage door opener	301
④  To open/close the tilt/sliding sunroof	97	⑩  Microphone for mbrace (emergency call system), telephone and Voice Control System <sup>3</sup>	
 To open/close the panorama roof with power tilt/sliding panel with roller sunblinds	97	⑪  Roadside Assistance button (mbrace system)	297
⑤  Button for MB info call (mbrace system)	298	⑫  To switch the left-hand reading lamp on/off	123
⑥  SOS button (mbrace system)	296	⑬  To switch the front interior lighting on/off	124

<sup>3</sup> Observe the additional Operating Instructions.

## Door control panel

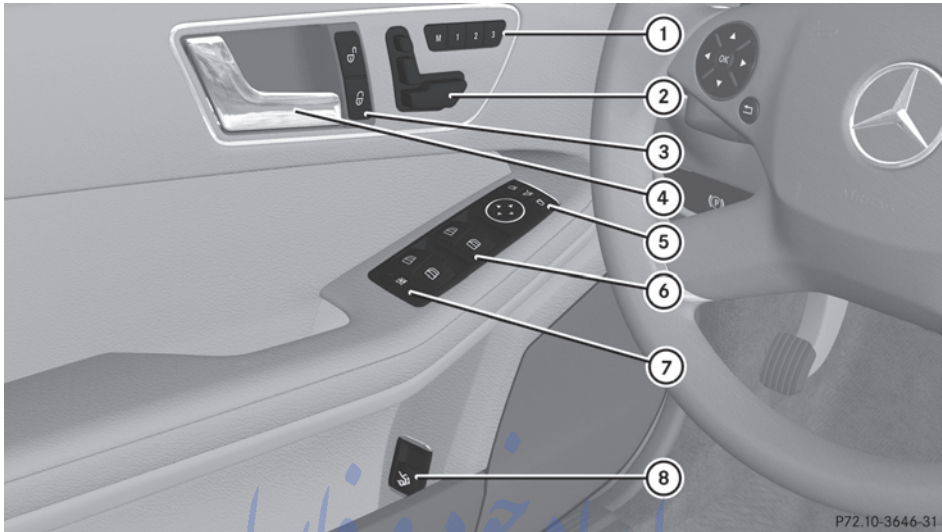

P72.10-3646-31

	Function	Page
①	M 1 2 3 Stores settings for the seat, exterior mirrors and steering wheel	115
②	Adjusts the seat electrically	104
③	Locks/unlocks the doors	84
④	Opens the door	84
⑤	 Adjusts and folds the exterior mirrors in/out electrically	113
⑥	Opens/closes the side windows	92
⑦	Activates/deactivates the override feature for the side windows in the rear compartment	64
⑧	Opens/closes the trunk lid/tailgate	88

# امداد خودرو فارما

تلفن شبانه روزی: ۰۲۱-۸۸۸۶۲۰۸۵

**FarmaSOS.com**



Vehicle equipment .....	36
Occupant safety .....	36
Children in the vehicle .....	58
Panic alarm .....	64
Driving safety systems .....	65
Anti-theft systems .....	73

# امداد خودرو فارما

تلفن شبانه روزی: ۰۲۱-۸۸۸۶۲۰۸۵

[FarmaSOS.com](http://FarmaSOS.com)

## Vehicle equipment

**i** This manual describes all the standard and optional equipment of your vehicle which was available at the time of purchase. Country-specific differences are possible. Bear in mind that your vehicle may not feature all functions described here. This also refers to safety-related systems and functions.

## Occupant safety

### Overview of occupant safety

In this section you will learn the most important facts about the restraint system components of the vehicle.

The restraint systems are:

- Seat belts
- Child restraint systems
- LATCH-type (ISOFIX) child seat anchors

Additional protection is provided by:

- SRS (Supplemental Restraint System)
- NECK-PRO head restraints
- PRE-SAFE®
- Air bag system components with:
  - PASSENGER air bag OFF indicator lamp
  - USA only: front passenger seat with Occupant Classification System (OCS)
  - Canada only: front passenger seat with BabySmart™ air bag deactivation system

The different air bag systems work independently of each other. The protective functions of the systems work in conjunction with each other. Not all air bags are deployed in an accident.

### Warning

Modifications to or work improperly conducted on restraint system components or their wiring, as well as tampering with interconnected electronic systems, can lead

to the restraint systems no longer functioning as intended.

Air bags or Emergency Tensioning Devices (ETDs), for example, could deploy inadvertently or fail to deploy in accidents although the deceleration threshold for air bag deployment is exceeded. Therefore, never modify the restraint systems. Do not tamper with electronic components or their software.

**i** See "Children in the vehicle" (> page 58) for more information on infants and children traveling with you in the vehicle and restraints for infants and children.

## SRS (Supplemental Restraint System)

### Introduction

SRS reduces the risk of occupants coming into contact with the vehicle's interior in the event of an accident. It can also reduce the effect of the forces to which occupants are subjected during an accident.

SRS consists of:

- the  SRS warning lamp
  - air bags
  - air bag control unit (with crash sensors)
  - belt tensioners
  - belt force limiters

### SRS warning lamps

SRS functions are checked regularly when you switch on the ignition and when the engine is running. Therefore, malfunctions can be detected in good time.

The  SRS warning lamp in the instrument cluster lights up when the ignition is switched on. It goes out no later than a few seconds after the engine is started.

The SRS components are in operational readiness when the  SRS warning lamp is not lit while the engine is running.

**Warning**

The SRS self-check has detected a malfunction if the  SRS warning lamp:

- does not come on at all
- fails to go out approximately 4 seconds after the engine was started
- comes on after the engine was started or while driving

For your safety, Mercedes-Benz strongly recommends that you have the system checked as soon as possible at an authorized Mercedes-Benz Center. Otherwise the SRS may not be activated when it is needed in an accident, which could result in serious or fatal injury. The SRS might also deploy unexpectedly and unnecessarily which could also result in injury.

In addition, improper work on the SRS creates a risk of rendering the SRS inoperative or causing unintended air bag deployment. Work on the SRS must therefore only be performed by qualified technicians. Contact an authorized Mercedes-Benz Center.

If it is necessary to modify an air bag system to accommodate a person with disabilities, contact an authorized Mercedes-Benz Center for details. USA only: Call our Customer Assistance Center at 1-800-FOR-MERCEDES (1-800-367-6372) for details.

### Safety guidelines for seat belts, Emergency Tensioning Devices (ETDs) and air bags

**Warning**

- Damaged seat belts or seat belts that have been subjected to stress in an accident must be replaced. Their anchoring points must also be checked. Only use seat belts installed or supplied by an authorized Mercedes-Benz Center.
- Air bags and pyrotechnic Emergency Tensioning Devices (ETDs) contain perchlorate material, which may require special handling and regard for the

environment. Check your national disposal guidelines. California residents, see [www.dtsc.ca.gov/HazardousWaste/Perchlorate/index.cfm](http://www.dtsc.ca.gov/HazardousWaste/Perchlorate/index.cfm).

- Air bags and ETDs are designed to function on a one-time-only basis. An air bag or ETD that has deployed must be replaced. PRE-SAFE® has electrically operated reversible belt tensioners in addition to the pyrotechnic ETDs.
- Do not pass seat belts over sharp edges. They could tear.
- Do not make any modification that could change the effectiveness of the seat belts.
- Do not bleach or dye seat belts as this may severely weaken them. In a crash they may not be able to provide adequate protection.
- No modifications of any kind may be made to any components or wiring of the SRS.
- Do not change or remove any component or part of the SRS.
- Do not install additional trim material, seat covers, badges, etc. to the:
  - padded steering wheel boss
  - knee bag covers
  - front-passenger air bag cover
  - outer side of front seat bolsters
  - side trim next to the rear seat backrest
  - roof lining trim
- Do not install additional electrical/electronic equipment on or near SRS components and wiring.
- Keep area between air bags and occupants free of objects (e.g. packages, purses, umbrellas, etc.).
- Do not hang items such as coat hangers from the coat hooks or handles over the door. These items may be thrown around in the vehicle and cause head and other injuries when the window curtain air bag is deployed.
- Air bag system components will be hot after an air bag has inflated. Do not touch them.

- Never place your feet on the instrument panel, dashboard, or on the seat. Always keep both feet on the floor in front of the seat.
- Improper repair work on the SRS creates a risk of rendering the SRS inoperative or causing unintended air bag deployment. Work on the SRS must therefore only be performed by qualified technicians. Contact an authorized Mercedes-Benz Center.
- For your protection and the protection of others, when scrapping the air bag unit or ETD, our safety instructions must be followed. These instructions are available from any authorized Mercedes-Benz Center.
- Given the considerable deployment speed, required inflation volume, and the material of the air bags, there is the possibility of abrasions or other, potentially more serious injuries resulting from air bag deployment.

If you sell your vehicle, Mercedes-Benz strongly recommends that you inform the subsequent owner that the vehicle is equipped with SRS. Also refer them to the applicable section in the Operator's Manual.

## Air bags

### Important safety notes

#### Warning

Air bags are designed to reduce the incidence of injuries and fatalities in certain situations:

- frontal impacts (driver's and front-passenger front air bags and driver's knee bag)
- side impacts (side impact air bags, window curtain air bags and pelvis air bags)
- rollover (window curtain air bags)

However, no system available today can completely eliminate injuries and fatalities.

When the air bags are deployed, a small amount of powder is released. The powder generally does not constitute a health hazard and does not indicate that there is a fire in the vehicle. In order to prevent potential breathing difficulties, you should leave the vehicle as soon as it is safe to do so. If you have any breathing difficulty but cannot get out of the vehicle after the air bag inflates, then get fresh air by opening a window or door.

#### Warning

To reduce the risk of injuries during front air bag inflation, the driver and front-passenger must always be seated correctly and have their seat belts fastened accordingly.

For maximum protection in the event of a collision, you must always be in the normal seat position with your back against the backrest. Fasten your seat belt and make sure that it is correctly positioned on your body.

Since the air bag inflates with considerable speed and force, a proper seating position and correct positioning of the hands on the steering wheel will help to keep you at a safe distance from the air bag. Occupants who are not wearing their seat belt, are not seated properly or are too close to the air bag can be seriously injured or killed by an air bag as it inflates with great force instantaneously:

- Sit with the seat belt properly fastened in a position that is as upright as possible with your back against the seat backrest.
- Move the driver's seat as far back as possible, still permitting proper operation of vehicle controls. The distance from the center of the driver's chest to the center of the air bag cover on the steering wheel must be at least 10 inches (25 cm) or more. You should be able to accomplish this by adjusting the seat and steering wheel. If you have any difficulties, please contact an authorized Mercedes-Benz Center.
- Do not lean your head or chest close to the steering wheel or dashboard.

- Only hold the steering wheel by the rim. Placing hands and arms inside the rim can increase the risk and potential severity of hand/arm injury when the driver front air bag inflates.
- Adjust the front-passenger seat as far back as possible from the dashboard when the seat is occupied.
- Occupants, especially children, should never place their bodies or lean their heads in the area of the door where the side impact air bag inflates. This could result in serious injuries or death should the side impact air bag be deployed. Always sit as upright as possible, wear the seat belt properly and use an appropriately sized child restraint, infant restraint or booster seat recommended for the size and weight of the child.
- Canada only: children under 12 years may only sit in the front-passenger seat if they are seated in a child restraint system which is compatible with BabySmart™ and approved by Mercedes-Benz. If the child restraint system is installed properly, the front-passenger front air bag is deactivated in conjunction with the BabySmart™ system installed in the vehicle. Otherwise, the child could be struck by the air bag when it inflates in a crash. This could lead to serious or fatal injuries.

Failure to follow these instructions can result in severe injuries to you or other occupants. If you sell your vehicle, it is important that you make the buyer aware of this safety information. Be sure to give the buyer this Operator's Manual.

### **Warning**

Accident research shows that the safest place for children in an automobile is in a rear seat.

A side impact air bag related injury may occur if occupants, especially children, are not properly seated or restrained when next to a side impact air bag which needs to deploy rapidly in a side impact in order to do its job.

To help avoid the possibility of injury, please follow these guidelines:

- (1) Always sit as upright as possible and use the seat belts properly. Make sure that children 12 years old and under use an appropriately sized child restraint, infant restraint, or booster seat recommended for the size and weight of the child.
- (2) Always wear seat belts properly.

The air bags are only deployed if the airbag control unit detects the need for deployment. Only in the event of such a situation will they provide their supplemental protection.

The driver and passenger should always wear their seat belts. Otherwise, it is not possible for the air bags to provide their supplemental protection.

In the event of other types of impacts and impacts below air bag deployment thresholds, air bags will not deploy. The driver and passengers will then be protected to the extent possible by a properly fastened seat belt. A properly fastened seat belt is also needed to provide the best possible protection in a rollover.

Air bags offer supplemental protection but are not a substitute for seat belts. All vehicle occupants must fasten their seat belts regardless of whether your vehicle is equipped with airbags or not.

It is important for your safety and that of your passenger to have deployed air bags replaced and to have any malfunctioning air bags repaired. This will help to make sure the air bags continue to perform their protective function for the vehicle occupants in the event of a crash.

### **Front air bags**

#### **Warning**

Observe "Important safety notes" ( page 38).

The front air bags increase protection for the driver's and front-passenger's head and chest.



Driver's air bag ① deploys in front of the steering wheel; front-passenger air bag ② deploys in front of and above the glove box. They are deployed:

- in the event of certain frontal impacts
- if the system determines that air bag deployment can offer additional protection to that provided by the seat belt
- if the seat belt is fastened
- independently of other air bags in the vehicle

If the vehicle overturns, the front air bags are generally not deployed unless the system detects high vehicle deceleration in a longitudinal direction.

Your vehicle has adaptive, two-stage front air bags. In the event of a collision, the air bag control unit evaluates the vehicle deceleration. When the first deployment threshold is reached, the front air bag is filled with enough propellant gas to reduce the risk of injuries. The front air bag is fully deployed if a second deployment threshold is exceeded within a few milliseconds.

Vehicles with OCS (USA only): front-passenger front air bag deployment is also influenced by the passenger's weight category as identified by the Occupant Classification System (OCS) (▷ page 43).

Vehicles with OCS (USA only): the lighter the passenger side occupant, the higher the

vehicle deceleration rate required for second stage inflation of the front-passenger front air bag. In the second stage, the front air bags are inflated with the maximum amount of propellant gas available.

In impact situations with deceleration or acceleration values lower than the vehicle deceleration or acceleration values preset in the system, the front air bags are not deployed. You will then be protected by the seat belt.

**!** Vehicles with BabySmart™ (Canada only): do not place any objects which weigh more than 20 lb (9 kg) on the front-passenger seat. This could cause the system to identify the seat as being occupied. In the event of an accident, the restraint systems on the front-passenger side are triggered. Have restraint systems that have been triggered replaced.

The front-passenger air bag will only deploy if:

- the system, based on the OCS weight sensor readings, detects that the front-passenger seat is occupied (USA only).
- the  indicator lamp in the center console is not lit, USA: (▷ page 43), Canada: (▷ page 48).
- the impact exceeds a preset deployment threshold.

### Driver's knee bag

#### Warning

Observe "Important safety notes" (▷ page 38).

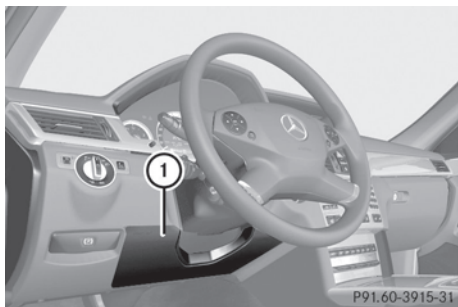

Driver's knee bag ① increases protection for the driver against the risk of:

- knee injuries
- thigh injuries
- lower leg injuries

Driver's knee bag ① inflates beneath the steering column. If the system determines that deployment of driver's knee bag ① can offer additional protection to that provided by the seat belt in the event of a frontal impact, the system will deploy it together with the driver's front air bag. Driver's knee bag ① operates best in conjunction with a properly positioned and fastened seat belt.

### Side impact air bags

#### Warning

Observe "Important safety notes" (> page 38).

#### Warning!

The pressure sensors for side impact air bag control are located in the doors. Do not modify any components of the doors or door trim panels including, for example, the addition of door speakers.

Improper repair work on the doors or the modification or addition of components to the doors create a risk of rendering the side impact air bags inoperative or causing unintended air bag deployment. Work on the doors must therefore only be performed by qualified technicians. Contact an authorized Mercedes-Benz Center.

#### Warning

Only use seat covers which have been tested and approved by Mercedes-Benz for your vehicle model. Using seat covers or other seat coverings can cause a malfunction of the side impact air bags and/or the pelvis air bags. Contact an authorized Mercedes-Benz Center for availability.

When deployed, the side impact air bags offer additional protection for the thorax of the vehicle occupants on the side of the vehicle on which the impact occurs. However, they do not protect the:

- head
- neck
- arms

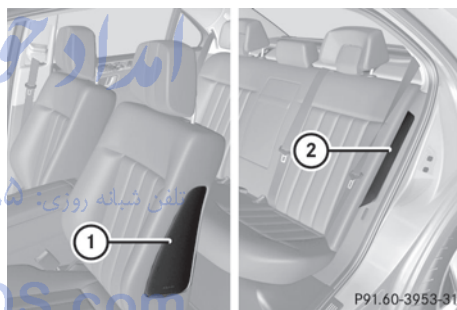

Example: Sedan

Front side impact air bags ① and rear side impact air bags ② deploy next to the outer seat cushions.

The side impact air bags are deployed:

- on the side on which an impact occurs
- at the start of an accident with a high rate of lateral vehicle deceleration or acceleration, e.g. in a side impact
- independently of seat belt use
- independently of the front air bags
- independently of the Emergency Tensioning Devices

If the vehicle overturns, the side impact air bags are generally not deployed. They are deployed if the system detects high vehicle deceleration or acceleration in a lateral



direction and determines that side impact air bag deployment can offer additional protection to that provided by the seat belt.

The side impact air bags will not deploy in side impacts with deceleration rates which do not exceed the system's preset deployment thresholds for vehicle deceleration or acceleration. You will then be protected by the seat belt.

Vehicles with OCS (USA only): if the OCS detects that the front-passenger seat is not occupied and the front-passenger seat belt is not fastened (the belt tongue is not engaged in the seat belt buckle), the side impact air bag on the front-passenger side will not deploy. The side impact air bag on the front-passenger side will deploy if the front-passenger seat belt is fastened, regardless of whether the front-passenger seat is occupied or not.

**!** Vehicles with BabySmart™ (Canada only): do not place any objects which weigh more than 20 lb (9 kg) on the front-passenger seat. This could cause the system to identify the seat as being occupied. In the event of an accident, the restraint systems on the front-passenger side are triggered. Have restraint systems that have been triggered replaced.

### Pelvis air bags

#### Warning

Observe "Important safety notes" (> page 38).

#### Warning

Only use seat covers which have been tested and approved by Mercedes-Benz for your vehicle model. Using seat covers or other seat coverings can cause a malfunction of the side impact air bags and/or the pelvis air bags. Contact an authorized Mercedes-Benz Center for availability.

Pelvis air bag deployment enhances the level of protection of the vehicle occupants on the

side of the vehicle on which the impact occurs.



Pelvis air bags ① deploy next to and below the outer seat cushions. They are deployed:

- on the side on which an impact occurs
- at the start of an accident with a high rate of lateral vehicle deceleration or acceleration, e.g. in a side impact
- independently of seat belt use
- independently of the front air bags
- independently of the Emergency Tensioning Devices

The pelvis air bags are generally not deployed if the vehicle overturns, unless the system detects high vehicle deceleration or acceleration in a lateral direction and determines that they can offer additional protection to that provided by the seat belt.

Pelvis air bags ① will not deploy in side impacts with deceleration rates which do not exceed the system's preset deployment thresholds for vehicle deceleration or acceleration. You will then be protected by the seat belt.

Vehicles with OCS (USA only): if the OCS detects that the front-passenger seat is not occupied and the front-passenger seat belt is not fastened (the belt tongue is not engaged in the seat belt buckle), the pelvis air bag on the front-passenger side will not deploy. The pelvis air bag on the front-passenger side will deploy if the front-passenger seat belt is fastened, regardless of whether the front-passenger seat is occupied or not.



## Window curtain air bags

### Warning

Observe "Important safety notes" (▷ page 38).

The window curtain air bags enhance the level of protection for the head (but not chest or arms) of the vehicle occupants on the side of the vehicle on which the impact occurs.

The window curtain air bags are integrated into the side of the roof frame and deploy in the area extending from the front door (A-pillar) to the rear door (C-pillar).

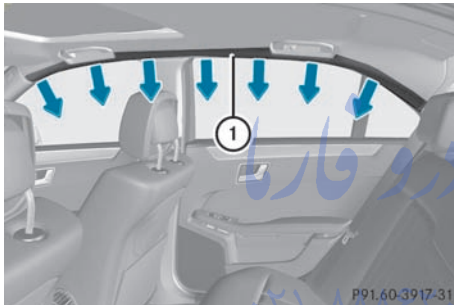

Example: Sedan

Window curtain air bags ① are deployed:



- on the side on which an impact occurs
- at the start of an accident with a high rate of lateral vehicle deceleration or acceleration, e.g. in a side impact
- regardless of whether the front-passenger seat is occupied
- independently of seat belt use
- if the vehicle overturns and the system determines that window curtain air bag deployment can offer additional protection to that provided by the seat belt
- independently of the front air bags

Window curtain air bags ① will not deploy in impacts with deceleration rates which do not exceed the system's preset deployment thresholds for vehicle deceleration or acceleration. You will then be protected by the seat belt.

## Occupant classification system (OCS)

### How the Occupant Classification System works

The Occupant Classification System (OCS) is standard equipment in the USA.

OCS categorizes the occupant on the front-passenger seat by means of a weight sensor. The front-passenger front air bag is automatically deactivated for certain weight categories. The respective status can be recognized by the  **PASS AIR BAG OFF** indicator lamp. With the  **PASS AIR BAG OFF** indicator lamp illuminated, the front-passenger front air bag is deactivated.

The system does not deactivate:

- the side impact air bag
- the pelvis air bag
- the window curtain air bag
- the Emergency Tensioning Devices

To be classified correctly, the front passenger must sit:





- with the seat belt properly fastened
- in a position that is as upright as possible with the back against the seat backrest
- with their feet on the floor

If the front-passenger's weight is transferred to another object in the vehicle (e.g. by leaning on armrests), OCS may not be able to approximate the occupant's weight category. If the front passenger seat, the seat cover, or the seat cushion are damaged, have the necessary repair work carried out at an authorized Mercedes-Benz Center.



For reasons of safety, Mercedes-Benz recommends that you only use seat accessories that have been approved by Mercedes-Benz.



Both the driver and the front passenger should observe the  **PASS AIR BAG OFF** indicator lamp to determine whether or not the front passenger is positioned correctly.

### Warning



If the   indicator lamp illuminates when an adult or someone larger than a small individual is in the front passenger seat, have the front passenger reposition himself or herself in the seat until the   indicator lamp goes out.



In the event of a collision, the air bag control unit will not allow front passenger front air bag deployment when the OCS has classified the front passenger seat occupant as weighing as much as or less than a typical 12-month-old child in a standard child restraint or if the front passenger seat is classified as being empty.



When the OCS senses that the front passenger seat occupant is classified as being up to or less than the weight of a typical 12-month-old child in a standard child restraint, the   indicator lamp will illuminate when the engine is started and remain illuminated. This indicates that the front passenger front air bag is deactivated.

When the OCS senses that the front passenger seat is classified as being empty, the   indicator lamp will illuminate when the engine is started and remain illuminated. This indicates that the front passenger front air bag is deactivated.



When the OCS senses that the front passenger seat occupant is classified as being heavier than the weight of a typical 12-month-old child seated in a standard child restraint or as being a small individual (such as a young teenager or a small adult), the



  indicator lamp will illuminate for approximately 6 seconds when the engine is started. Depending on occupant weight sensor readings from the seat, it will then remain illuminated or go out. With the



  indicator lamp illuminated, the front passenger front air bag is deactivated.

With the   indicator lamp out, the front passenger front air bag is activated.

When the OCS senses that the front passenger seat occupant is classified as an adult or someone larger than a small

individual, the   indicator lamp will illuminate for approximately six seconds when the engine is started and then go out. This indicates that the front passenger front air bag is activated.

If the   indicator lamp is illuminated, the front passenger front air bag is deactivated and will not be deployed.

If the   indicator lamp is not illuminated, the front passenger front air bag is activated and will be deployed

- in the event of certain frontal impacts
- if the impact exceeds a predetermined triggering threshold
- independent of the side impact air bag or pelvis air bag

If the front passenger front air bag is deployed, the rate of inflation will be influenced by

- the rate of vehicle deceleration as assessed by the air bag control unit
- the front passenger's weight category as identified by the OCS

For further information, see the section regarding air bag display messages (▷ page 239).





### Warning

According to accident statistics, children are safer when properly restrained on the rear seats than on the front-passenger seat. Thus, we strongly recommend that children be placed in the rear seats whenever possible. Regardless of seating position, children 12 years old and under must be seated and properly secured in an appropriate infant restraint, toddler restraint, or booster seat recommended for the size and weight of the child.

The infant or child restraint must be properly secured with the vehicle's seat belt, the seat belt and Top Tether strap, or lower anchors and Top Tether strap, fully in accordance with the child seat manufacturer's instructions.

Occupants, especially children, should always sit as upright as possible, wear the seat belt properly and use an appropriately sized infant restraint, toddler restraint, or booster seat recommended for the size and weight of the child.

Children can be killed or seriously injured by an inflating air bag. Note the following important information when circumstances require you to place a child in the front-passenger seat:

- Your vehicle is equipped with air bag technology designed to deactivate the front-passenger front air bag in your vehicle when the system senses the weight of a typical 12-month-old child or less along with the weight of a standard appropriate child restraint on the front-passenger seat.
- A child in a rear-facing child restraint on the front-passenger seat will be seriously injured or even killed if the front-passenger front air bag inflates in a collision which could occur under some circumstances, even with the air bag technology installed in your vehicle. The only means to eliminate this risk completely is never to place a child in a rear-facing child restraint in the front-passenger seat. We therefore strongly recommend that you always place a child in a rear-facing child restraint on the rear seat.
- If you install a rear-facing child restraint on the front-passenger seat, make sure the  indicator lamp is illuminated, indicating that the front-passenger front air bag is deactivated. Should the  indicator lamp not illuminate or go out while the restraint is installed, please check installation. Periodically check the  indicator lamp while driving to make sure that the  indicator lamp is illuminated. If the  indicator lamp goes out or remains out, do not transport a child on the front-passenger seat until the system has been repaired.

A child in a rear-facing child restraint on the front-passenger seat will be seriously injured or even killed if the front-passenger front air bag inflates.

- If you place a child in a forward-facing child restraint on the front-passenger seat:
  - move the seat as far back as possible
  - use the proper child restraint recommended for the age, size and weight of the child
  - secure child restraint with the vehicle's seat belt according to the child seat manufacturer's instructions
- For children larger than the typical 12-month-old child, the front-passenger front air bag may or may not be activated.



Deployment of the driver front air bag does not mean that the front-passenger front air bag should also have deployed.

OCS may have determined:



- that the seat was unoccupied or occupied by a weight of up to or less than that of a typical 12-month-old child seated in a standard child restraint
- that the seat was occupied by a small individual (e.g. a young teenager or a small adult) or a child who weighs more than a typical 12-month-old child in a standard child restraint system

These are examples of when OCS deactivates the front-passenger front air bag. The air bag is deactivated despite the impact fulfilling the criteria for deploying the driver's front air bag.



If the SmartKey has been removed from the ignition lock or is in position **0**, indicator lamp   **1** does not light up.

### **Warning**

If the red  SRS warning lamp in the instrument cluster and the  indicator lamp light up simultaneously, the OCS is malfunctioning. The front passenger front air bag will be deactivated in this case. Have the system checked by qualified technicians as soon as possible. Contact an authorized Mercedes-Benz Center.

Only have the seat repaired or replaced at an authorized Mercedes-Benz Center.

In order to ensure proper operation of the air bag system and OCS:

- Sit with the seat belt properly fastened in a position that is as upright as possible with your back against the seat backrest.
- When seated, a passenger should not position him/herself in such a way as to cause the passenger's weight to be lifted from the seat cushion as this may result in the OCS being unable to correctly approximate the passenger's weight category.
- Read and observe all warnings in this chapter.

unoccupied, the   indicator lamp will illuminate and not go out.

### **Warning!**

If the  indicator lamp does not illuminate, the system is not functioning. You must contact an authorized Mercedes-Benz Center before seating any child on the front passenger seat.

For more information, see "Problems with the Occupant Classification System" ([▷](#) page 47).

### **Warning**



Never place anything between seat cushion and child seat (e.g. a pillow), since it reduces the effectiveness of the OCS. The underside and rear side child restraint system must be placed entirely on the seat cushion and the backrest of the front-passenger seat backrest.

If necessary, adjust the tilt of the passenger seat backrest.

An incorrectly mounted child seat could cause injuries to the child in case of an accident, instead of increasing protection for the child.

Follow the manufacturer's instructions for installation of child restraint systems.

## System self-test

The   indicator lamp illuminates when you:

- turn the SmartKey to position **1** or **2** in the ignition lock
- on vehicles with KEYLESS-GO, press the Start/Stop button once or twice

If an adult is seated properly on the passenger seat and the OCS classifies the occupant as an adult, the  indicator lamp illuminates and goes out again after approximately 6 seconds.



If the seat is not occupied and the OCS classifies the front passenger seat as being

## Problems with the occupant classification system

Problem	Possible causes/consequences and ► Solutions
<p>The  indicator lamp illuminates and remains illuminated. The person sitting on the front-passenger seat:</p> <ul style="list-style-type: none"> <li>weighs as much as a typical adult</li> <li>weighs more than a child</li> </ul>	<p>OCS is malfunctioning.</p> <ul style="list-style-type: none"> <li>Have OCS checked as soon as possible at an authorized Mercedes-Benz Center.</li> <li>Observe the additional display messages in the multifunction display (► page 239).</li> </ul>

### Warning

If the  indicator lamp illuminates and remains illuminated when the weight of a typical adult or someone larger than a small individual has been detected on the passenger seat, do not allow any occupant to use the passenger seat until the system has been repaired.

Problem	Possible causes/consequences and ► Solutions
<p>The  indicator lamp does not illuminate and/or does not remain illuminated. The front-passenger seat is:</p> <ul style="list-style-type: none"> <li>unoccupied</li> <li>occupied with the weight of a typical 12-month-old child in a standard child restraint or less</li> </ul>	<p>OCS is malfunctioning. تلفن شبانه روزی: </p> <ul style="list-style-type: none"> <li>Make sure there is nothing between the seat cushion and the child seat.</li> <li>Check the installation of the child restraint system.</li> <li>Make sure there are no objects applying additional weight onto the seat.</li> <li>If the  indicator lamp remains out, have OCS checked as soon as possible at an authorized Mercedes-Benz Center. Do not transport a child on the front-passenger seat until OCS has been repaired.</li> <li>Observe the additional display messages in the multifunction display (► page 239).</li> </ul>

### Warning

If the  indicator lamp does not illuminate or remains out with the weight of a typical 12-month-old child in a standard child restraint or less, or is unoccupied, on the front-passenger seat, do not transport a child on the front-passenger seat until the system has been repaired.

## BabySmart™ air bag deactivation system

### How the air bag deactivation system functions

The BabySmart™ system is standard equipment in Canada.

#### Warning

According to accident statistics, children are safer when properly restrained on the rear seats than on the front-passenger seat. For this reason, Mercedes-Benz strongly advises that you always secure children in the rear seats. Regardless of seating position, children 12 years old and under must be seated and properly secured in an appropriately sized child restraint system or booster seat recommended for the size and weight of the child.

Secure the infant restraint system or child restraint system, using:

- the vehicle's seat belt
- the seat belt and a Top Tether belt
- the LATCH-type (ISOFIX) child seat mount and a Top Tether belt

The child restraint system must be installed and secured correctly, observing the manufacturer's installation instructions.





Occupants, especially children, should always sit as upright as possible, wear the seat belt properly and use an appropriately sized infant restraint, toddler restraint, or booster seat recommended for the size and weight of the child.

Children can be killed or seriously injured by an inflating air bag. Observe the following important information if it is necessary to carry a child on the front-passenger seat:

- Children under 12 years may only sit in the front-passenger seat if they are seated in a child restraint system which is compatible with BabySmart™ and approved by Mercedes-Benz. If the child restraint system is installed properly, the front-

passenger front air bag is deactivated in conjunction with the BabySmart™ system. Otherwise, the child could be struck by the air bag when it inflates in a crash. This could lead to serious or fatal injury.

- A child in a rear-facing child restraint on the front-passenger seat will be seriously injured or even killed if the front-passenger front air bag inflates in a collision which could occur under some circumstances, even with the air bag technology installed in your vehicle. The only means to eliminate this risk completely is never to place a child in a rear-facing child restraint in the front-passenger seat. We therefore strongly recommend that you always place a child in a rear-facing child restraint on the rear seat.

- If it is necessary to install a BabySmart™-compatible rear-facing child restraint system on the front-passenger seat, make sure the  indicator lamp is illuminated. This indicates that the front-passenger front air bag is deactivated. If the  indicator lamp does not light up or goes out when the child restraint system is installed, check the anchorages of the restraint system. Periodically check the  indicator lamp while driving to make sure the  is illuminated. If the  indicator lamp goes out or remains out, do not transport a child on the front-passenger seat until the system has been repaired.

A child in a rear-facing child restraint on the front-passenger seat will be seriously

injured or even killed if the front-passenger front air bag inflates.

- If you have to place a child in a forward-facing child restraint system on the front-passenger seat, you must:
  - move the seat as far back as possible
  - use the proper child restraint recommended for the age, size and weight of the child
  - secure child restraint with the vehicle's seat belt according to the child seat manufacturer's instructions

### Warning



The BabySmart™ air bag disabling system ONLY works with specially adapted child restraint systems. It does not work with child restraint systems that are not compatible with BabySmart™.

Never place anything between the seat cushion and the child restraint system (e.g. a cushion), as this reduces the effectiveness of the BabySmart™ air bag deactivation system. The underside of the child restraint system must lie against the seat cushion of the front-passenger seat. In the event of an accident, an incorrectly installed child restraint system could injure the child instead of offering protection.

Observe the manufacturer's instructions when installing special child restraint systems.

### Warning

When using a BabySmart™-compatible child restraint system on the front-passenger seat, the front-passenger front air bag is only disabled if the  indicator lamp is illuminated.

Check the  indicator lamp repeatedly, every time you use a BabySmart™-compatible child restraint system on the front-passenger seat. Should the  indicator lamp not illuminate or go out while the restraint is installed, please check installation. If the 

indicator lamp remains out, do not use the BabySmart™ child restraint system to carry a child on the front-passenger seat until the system has been repaired.



Special child restraint systems which are compatible with BabySmart™ are necessary for deactivating the front-passenger front air bag. When the special child restraint system which is compatible with BabySmart™ is installed correctly and is recognized by the sensor system in the front-passenger seat, the front-passenger front air bag is deactivated. In this case,  indicator lamp ① illuminates. If you have any questions regarding the special child restraint systems which are compatible with BabySmart™, consult an authorized Mercedes-Benz Center.

If the key has been removed from the ignition lock or is in position 0, indicator lamp



 ① does not light up.

The system does not deactivate:



- the side impact air bag
- the pelvis air bag
- the window curtain air bag
- the Emergency Tensioning Devices





## System self-test

The   indicator lamp illuminates when you:



- turn the SmartKey to position **1** or **2** in the ignition lock
- on vehicles with KEYLESS-GO, press the Start-Stop button once or twice



The   indicator lamp goes out again after approximately six seconds.

If the   indicator lamp does not illuminate or is lit continuously, the system is malfunctioning. Before transporting a child on the front-passenger seat, have the BabySmart™ system checked at an authorized Mercedes-Benz Center.

For more information, see "Problems with the air bag deactivation system" section (▷ page 51)

### **Warning**

Do not place powered-on laptops, mobile phones, electronic tags such as those used in ski passes or similar electronic devices on the front passenger seat. Signals from such devices may interfere with the BabySmart™ air bag deactivation system. Such signal interference may cause the   indicator lamp not to come on during self-test.

The  SRS indicator lamp and/or the   indicator lamp could be continuously lit, indicating that the system is not functioning. The front-passenger front air bag could deploy inadvertently or fail to deploy in an accident.

امداد خودرو فارما

تلفن شبانه روزی: ۰۸۵-۲۰۸۵۲۰۰۰۰

naSOS.com





## Problems with the air bag deactivation system

Problem	Possible causes/consequences and ► Solutions
The  indicator lamp illuminates and remains illuminated.	<p>A special BabySmart™ compatible child restraint system is installed on the front-passenger seat. The front-passenger front air bag is therefore deactivated.</p> <p>A BabySmart™-compatible child restraint system is not installed on the front-passenger seat. The BabySmart™ system is malfunctioning.</p> <p>► Have the BabySmart™ system checked as soon as possible at an authorized Mercedes-Benz Center.</p>

### Warning

If the  indicator lamp illuminates and remains illuminated when the weight of a typical adult or someone larger than a small individual has been detected on the passenger seat, do not allow any occupant to use the passenger seat until the system has been repaired.

Problem	Possible causes/consequences and ► Solutions
The  indicator lamp does not illuminate or does not remain illuminated with a BabySmart™-compatible child restraint system properly installed on the front-passenger seat.	<p>The BabySmart™ system is malfunctioning.</p> <ul style="list-style-type: none"> <li>► Make sure there is nothing between the seat cushion and the child seat.</li> <li>► Check the installation of the child restraint system.</li> <li>► If the  indicator lamp does not illuminate, have the BabySmart™ system checked as soon as possible at an authorized Mercedes-Benz Center.</li> </ul> <p>Do not transport a child on the front-passenger seat until the child seat recognition system has been repaired.</p>

### PRE-SAFE® system

#### Warning

The PRE-SAFE® system reduces the impact of an accident on vehicle occupants, as long as their seat belts have been fastened correctly. Although your vehicle is equipped with a PRE-SAFE® system, the possibility of injury in the event of an accident cannot be ruled out. You should therefore always drive carefully and adapt your driving style to the prevailing road, weather and traffic conditions.

PRE-SAFE® takes pre-emptive measures to protect the occupants in certain hazardous situations.

PRE-SAFE® intervenes:

- in emergency braking situations, e.g. if BAS is activated or, on vehicles with DISTRONIC PLUS, if BAS PLUS or PRE-SAFE® Brake intervenes powerfully
- if the radar sensor system detects an imminent danger of collision in certain

situations (on vehicles with DISTRONIC PLUS)

- in critical driving situations, e.g. when physical limits are exceeded and the vehicle understeers or oversteers severely or when having to swerve to avoid an obstacle at a speed above 85 mph (140 km/h).

PRE-SAFE® takes the following measures depending on the hazardous situation detected:

- the front seat belts are pre-tensioned.
- under accident conditions, the front-passenger seat is adjusted if it is in an unfavorable position.
- increases the air pressure in the side bolsters of the seat cushion and seat backrest of the active multicontour seats in the front.
- if the vehicle skids, the sliding roof with power tilt/sliding panel and the side windows are closed so that only a small gap remains.

If the hazardous situation passes without resulting in an accident, PRE-SAFE® slackens the belt pretensioning. The air pressure in the side bolsters on the active multicontour seat is reduced again. All settings made by PRE-SAFE® can then be reversed.

If the seat belts are not released:

- ▶ When the vehicle is stationary, move the backrest or seat back slightly. The belt pretensioning is reduced and the locking mechanism is released.

#### Warning

Make sure that nobody can become trapped as you adjust the seat.

- ❗ Make sure that there are no objects in the footwell or behind the seats when resetting the seats. There is a risk that the seats and/or the objects could be damaged.

More information about belt adjustment, a convenience function integrated into PRE-

SAFE®, can be found in the "Belt adjustment" section (▷ page 56).

### NECK-PRO head restraints

The NECK-PRO head restraints increase protection for the driver's and front-passenger's head and neck. In the event of a rear collision of a certain severity, the NECK-PRO head restraints on the driver's and front-passenger seats are moved forwards and upwards. This provides better head support.

#### Warning

Do not secure any objects (e.g. coat hangers) on the NECK-PRO head restraints. Otherwise, the NECK-PRO head restraints may not function properly, or in the event of a rear-end collision may not be able offer the level of protection they are designed to provide.

#### Warning

Only use seat covers/head restraint covers that have been tested and approved by Mercedes-Benz for your model.

Using seat covers and head restraint covers other than those recommended may cause a malfunction when NECK-PRO head restraints are triggered or front side impact air bags/pelvis air bags may be prevented from deploying.

Contact an authorized Mercedes-Benz Center for availability.

If the NECK-PRO head restraints have been triggered in an accident, you must reset the NECK-PRO head restraints on the driver's and front-passenger seat (▷ page 53).

Otherwise, the additional protection will not be available in the event of another rear-end collision. You can recognize that NECK-PRO head restraints have been triggered by the fact that they have moved forwards and can no longer be adjusted.

**⚠ Warning!**

For your protection, drive only with properly positioned head restraints.

Adjust the head restraint so that it is as close to the head as possible and the center of the head restraint supports the back of the head at eye level. This will reduce the potential for injury to the head and neck in the event of an accident or similar situation.

**Resetting triggered NECK-PRO head restraints****⚠ Warning**

For safety reasons, have the NECK-PRO head restraints checked at an authorized Mercedes-Benz Center after a rear-end collision.

**⚠ Warning**

When pushing back the NECK-PRO head restraint cushion, make sure your fingers do not become caught between the head restraint cushion and the cover. Failure to observe this could result in injuries.

- ❶ Resetting the NECK-PRO head restraints requires a lot of strength. If you have difficulty resetting the NECK-PRO head restraints, have this work carried out at a qualified specialist workshop, e.g. an authorized Mercedes-Benz Center.

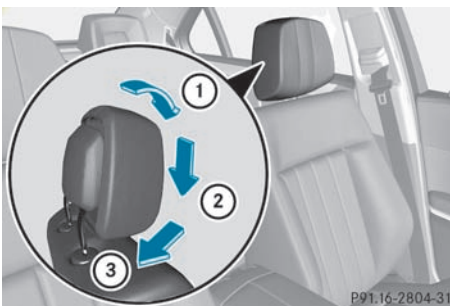

Example: Sedan

- ▶ Tilt the top of the NECK-PRO head restraint cushion forwards in the direction of arrow ①.
- ▶ Push the NECK-PRO head restraint cushion down in the direction of arrow ② as far as it will go.
- ▶ Firmly push the NECK-PRO head restraint cushion back in the direction of arrow ③ until the cushion engages.
- ▶ Repeat this procedure for the second NECK-PRO head restraint.

**Seat belts****Important safety notes**

The use of seat belts and infant and child restraint systems is required by law in all 50 states, the District of Columbia, the U.S. territories and all Canadian provinces.

Even where this is not the case, all vehicle occupants should have their seat belts fastened when the vehicle is in motion.

- ❶ See "Children in the vehicle" (▷ page 58) for more information on infants and children traveling with you in the vehicle and restraints for infants and children.

**⚠ Warning!**

Always fasten your seat belt before driving off. Always make sure all of your passengers are properly restrained. You and your passengers should always wear seat belts.

Failure to wear and properly fasten and position your seat belt greatly increases your risk of injuries and their likely severity in an accident.

If you are ever in an accident, your injuries can be considerably more severe without your seat belt properly buckled. Without your seat belt buckled, you are much more likely to hit the interior of the vehicle or be ejected from it. You can be seriously injured or killed.

In the same crash, the possibility of injury or death is lessened if you are properly wearing your seat belt. The air bags can only protect as intended if the occupants are properly wearing their seat belts.

#### Warning

Never ride in a moving vehicle with the seat backrest in an excessively reclined position as this can be dangerous. You could slide under the seat belt in a collision. If you slide under it, the seat belt would apply force at the abdomen or neck. That could cause serious or even fatal injuries. The seat backrest and seat belt provide the best restraint when the wearer is in a position that is as upright as possible and the seat belt is properly positioned on the body.

#### Warning

Never let more people ride in the vehicle than there are seat belts available. Make sure everyone riding in the vehicle is correctly restrained with a separate seat belt. Never use a seat belt for more than one person at a time.

#### Warning

Damaged seat belts or seat belts that have been subjected to stress in an accident must be replaced and their anchoring points must also be checked.

Only use seat belts which have been approved by Mercedes-Benz.

Do not make any modifications to the seat belts. This can lead to unintended activation of the ETDs or to their failure to activate when necessary.

Do not bleach or dye seat belts as this may severely weaken them. In a crash they may not be able to provide adequate protection.

Have all work carried out only by qualified technicians. Contact an authorized Mercedes-Benz Center.

## Correct use of the seat belt

### Warning

#### USE SEAT BELTS PROPERLY

- Seat belts can only work when used properly. Never wear seat belts in any other way than as described in this section, as that could result in serious injuries in the event of an accident.
- Each occupant should wear their seat belt at all times, because seat belts help reduce the likelihood of and potential severity of injuries in accidents, including rollovers. The integrated restraint system includes SRS (driver front air bag, driver's side knee bag, front-passenger front air bag, side impact air bags, pelvis air bags, window curtain air bags for the side windows), Emergency Tensioning Devices, seat belt force limiters, and front seat knee bolsters. The system is designed to enhance the protection offered to properly belted occupants in certain frontal (front air bags, driver's side knee bag and ETDs) and side (side impact air bags, window curtain air bags, and ETDs) impacts which exceed preset deployment thresholds and in certain rollovers (window curtain air bags and ETDs).
- Never wear the shoulder belt under your arm, across your neck or off your shoulder. In a frontal crash, your body would move too far forward. That would increase the chance of head and neck injuries. The seat belt would also apply too much force to the ribs or abdomen, which could severely injure internal organs such as your liver or spleen. Adjust the seat belt so that the shoulder section is located as close as possible to the middle of the shoulder. It should not touch the neck. Never pass the shoulder portion of the seat belt under your arm. For this purpose, you can adjust the height of the seat belt outlet.

- Position the lap belt as low as possible on your hips and not across the abdomen. If the lap belt is positioned across your abdomen, it could cause serious injuries in a crash.
- Never wear seat belts over rigid or breakable objects in or on your clothing, such as eyeglasses, pens, keys etc., as these might cause injuries.
- Make sure the seat belt is always fitted snugly. Take special care of this when wearing loose clothing.
- Never use a seat belt for more than one person at a time. Do not fasten a seat belt around a person and another person or other objects at the same time.
- Seat belts should not be worn twisted. In a crash, you would not have the full width of the seat belt to distribute impact forces. The twisted seat belt against your body could cause injuries.
- Pregnant women should also always use a lap-shoulder belt. The lap belt portion should be positioned as low as possible on the hips to avoid any possible pressure on the abdomen.
- Place the seat backrest in a position that is as upright as possible.
- Check your seat belt during travel to make sure it is properly positioned.
- Never place your feet on the instrument panel, dashboard, or on the seat. Always keep both feet on the floor in front of the seat.
- When using a seat belt to secure infant restraints, toddler restraints, or children in booster seats, always follow the child seat manufacturer's instructions.

#### **Warning**

Do not pass seat belts over sharp edges. They could tear.

Do not allow the seat belt to get caught in the door or in the seat adjustment mechanism. This could damage the seat belt.

Never attempt to make modifications to seat belts. This could impair the effectiveness of the seat belts.

### Fastening seat belts

#### **Warning**

According to accident statistics, children are safer when properly restrained on the rear seats than on the front-passenger seat. Thus, we strongly recommend that children be placed in the rear seat whenever possible. Regardless of seating position, children 12 years old and under must be seated and properly secured in an appropriately sized child restraint system or booster seat recommended for the size and weight of the child. For additional information, see the "Children in the vehicle" section.

A child's risk of serious or fatal injuries is significantly increased if the child restraints are not properly secured in the vehicle and/or the child is not properly secured in the child restraint.

#### **Warning**

Canada only: children 12 years old and under may ride on the front seat if a BabySmart™ compatible child restraint system is installed on the front-passenger seat. Use only Mercedes-Benz approved BabySmart™ compatible child restraint systems. A BabySmart™ compatible child restraint system will deactivate the front-passenger front air bag when installed correctly. The front-passenger front air bag will not be deactivated if the child restraint systems that are installed are not BabySmart™ compatible or if BabySmart™ compatible child restraint systems are not installed correctly. If the front-passenger front air bag is deployed in a collision, the child will be struck by the air bag. If this happens, serious or fatal injury will result.

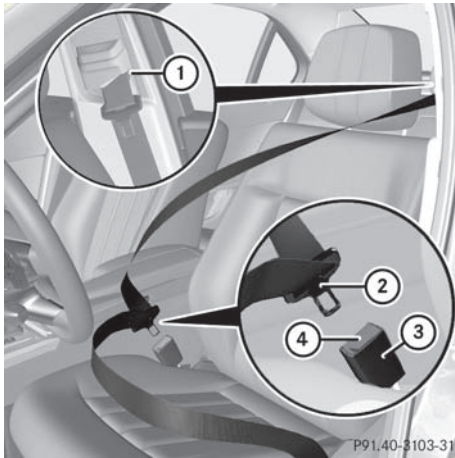

Example: Sedan

- ▶ Adjust the seat and move the backrest to an almost vertical position (▷ page 102).
- ▶ Pull the seat belt smoothly through belt sash guide ①.
- ▶ Without twisting it, guide the shoulder section of the seat belt across the middle of your shoulder and the lap section across your hips.
- ▶ Engage belt tongue ② in buckle ③.  
Seat belt adjustment: if necessary, the driver's and front-passenger seat belts automatically adjust to the upper body (▷ page 56).
- ▶ If necessary, adjust the seat belt to the appropriate height (▷ page 56).
- ▶ If necessary, pull upwards on the shoulder section of the seat belt to tighten the belt across your body.

All seat belts in the vehicle, except the driver's seat belt, are equipped with a special seat belt retractor to secure child restraint systems properly. For further information on "Special seat belt retractors", see (▷ page 61).

For more information about releasing the seat belt with release button ④, see "Releasing seat belts" (▷ page 57).

## Seat belt adjustment

The seat-belt adjustment function adjusts the driver's and front-passenger seat belt to the upper body of the occupants.

The belt strap is tightened slightly when:

- you engage the belt tongue in the belt buckle and you then turn the SmartKey to position **2** in the ignition lock.
- the SmartKey is in position **2** in the ignition lock and you then engage the belt tongue in the buckle.

The seat-belt adjustment will apply a certain tightening force if any slack is detected between the occupant and the seat belt. Do not hold on to the seat belt tightly while it is adjusting. You can switch the seat-belt adjustment on and off in the on-board computer (▷ page 233).

## Seat belt outlet height adjustment

You can adjust the seat belt height on the driver's seat and the front-passenger seat.

**Wagon:** you can also adjust the belt height on the outer rear seats.

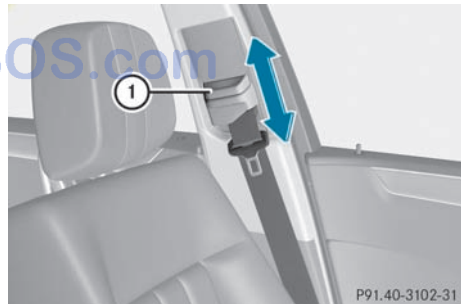

Adjust the height so that the upper part of the seat belt is routed across the center of your shoulder.

- ▶ **To raise:** slide the belt sash guide upwards. The belt sash guide engages in various positions.
- ▶ **To lower:** press and hold belt sash guide release ①.



- ▶ Slide the belt sash guide downwards.
- ▶ Release belt sash guide release ① and make sure that the belt sash guide has engaged.

### Using the seat belt on the center rear seat

If the left-hand rear seat backrest is folded down and back up again, the rear center seat belt may lock. The seat belt can then not be pulled out.

- ▶ **To unlock the rear center seat belt:** pull the seat belt out approximately 1 in (25 mm) from the belt outlet on the seat backrest and release again. The seat belt is retracted and released.

### Releasing seat belts

- ▶ Press release button ④ (▶ page 55) and guide belt tongue ② back towards belt sash guide ①.

**!** Make sure that the seat belt is fully rolled up. Otherwise, the seat belt or belt tongue will be trapped in the door or in the seat mechanism. This could damage the door, the door trim panel and the seat belt. Damaged seat belts can no longer fulfill their protective function and must be replaced. Consult an authorized Mercedes-Benz Center.



### Belt warning for driver and front passenger

Regardless of whether the driver's and front-passenger seat belts have already been fastened, the  seat belt warning lamp lights up for six seconds each time the engine is started. It then goes out once the driver and the front passenger have fastened their seat belts.

If the driver's seat belt is not fastened after the engine is started, an additional warning tone will sound. The warning tone goes out

after approximately six seconds or once the driver's seat belt is fastened.

If, after six seconds, the driver or front-passenger have not fastened their seat belts and the doors are closed:

- the  seat belt warning lamp remains illuminated as long as either the driver's or front-passenger seat belt is not fastened.
- if the vehicle speed exceeds 15 mph (25 km/h), the  seat belt warning lamp lights up. Additionally, a warning tone will sound with increasing intensity for a maximum of 60 seconds or until the driver's and front-passenger seat belt are fastened.

If the driver/front passenger unfasten their seat belt while the vehicle is in motion, the  seat belt warning lamp lights up and a warning tone sounds again.

The warning tone ceases even if the driver or front passenger have still not fastened their seat belt after 60 seconds. The  seat belt warning lamp stops flashing but remains illuminated. تلفن ش.

After the vehicle comes to a standstill, the warning tone is reactivated and the  seat belt warning lamp flashes again if the vehicle speed again exceeds 15 mph (25 km/h).

The  seat belt warning lamp only goes out if:

- both the driver and the front passenger have fastened their seat belts.
- or
- the vehicle is stationary and a door is open.

- i** For more information on the  seat belt warning lamp, see "Indicator and warning lamps in the instrument cluster, seat belt" (▶ page 264).

### Emergency Tensioning Devices and seat belt force limiters

The front seat belts and the outer seat belts in the rear are equipped with ETDs and belt force limiters.

**!** If the front-passenger seat is not occupied, do not engage the seat belt tongue in the buckle on the front-passenger seat. Otherwise, the Emergency Tensioning Device could be triggered in the event of an accident.

The ETDs tighten the seat belts in an accident, pulling them close against the body.

ETDs do not correct incorrect seat positions or incorrectly fastened seat belts.

ETDs do not pull vehicle occupants back towards the backrest.

Seat belt force limiters, when activated, are employed to help reduce the force exerted by the seat belts on occupants during a crash.

The front belt force limiters are synchronized with the front air bags, which take on a part of the deceleration force. Thus, the force exerted on the occupant is distributed over a greater area.

The ETDs can only be activated if:

- the ignition is switched on.
- the restraint systems are operational; see "SRS warning lamp" (▷ page 36).
- the belt tongue is engaged in the buckle on each of the lap-shoulder belts in the front.
- the front-passenger seat is occupied and the belt tongue is engaged in the buckle on the front-passenger side.

The ETDs on the outside seats in the rear compartment are triggered independently of the lock status of the seat belts.

The ETDs are triggered depending on the type and severity of an accident:

- in the event of a head-on or rear-end collision if the vehicle decelerates or accelerates rapidly in a longitudinal direction during the initial stages of the impact
- in the event of a side impact, on the side opposite the impact if the vehicle

decelerates or accelerates rapidly in a lateral direction

- in certain situations if the vehicle overturns and the system determines that it can provide additional protection

If the Emergency Tensioning Devices (ETDs) are triggered, you will hear a bang, and a small amount of powder may also be released. Only in rare cases will the bang affect your hearing. The powder that is released generally does not constitute a health hazard. The  SRS warning lamp lights up.

### Warning

Pyrotechnic Emergency Tensioning Devices that have been deployed must be renewed.

For your safety, when disposing of Emergency Tensioning Devices, always observe the safety instructions. These are available from any authorized Mercedes-Benz Center.

The PRE-SAFE® system has electrically operated reversible pre-tensioners that do not require replacement after activation.

## Children in the vehicle

### Important safety notes

#### Warning

When leaving the vehicle, always remove the SmartKey from the ignition lock. Always take the SmartKey with you and lock the vehicle. Do not leave children unattended in the vehicle, even if they are secured in a child restraint system, or with access to an unlocked vehicle. A child's unsupervised access to a vehicle could result in an accident and/or serious personal injury. The children could:

- injure themselves on parts of the vehicle
- be seriously or fatally injured through excessive exposure to extreme heat or cold
- injure themselves or cause an accident with vehicle equipment that can be operated even if the SmartKey is removed from the ignition lock or removed from the vehicle,



such as seat adjustment, steering wheel adjustment, or the memory function

If children open a door, they could injure other persons or get out of the vehicle and injure themselves or be injured by following traffic.

Do not expose the child restraint system to direct sunlight. The child restraint system's metal parts, for example, could become very hot, and the child could be burned on these parts.

#### **Warning!**

Do not carry heavy or hard objects in the passenger compartment, or trunk (sedan), or cargo compartment (wagon) unless they are firmly secured in place.

Unsecured or improperly positioned cargo increases a child's risk of injury in the event of

- strong braking maneuvers
- sudden changes of direction
- an accident

If an infant or child is traveling in the vehicle:

- ▶ Secure the child using an infant or child restraint system appropriate to the age and weight of the child.
- ▶ Make sure that the infant or child is properly secured at all times while the vehicle is in motion.

## Child restraint systems

### Important safety notes

#### **Warning**

Observe "Important safety notes" (> page 58).

We recommend all infants and children be properly restrained using the child restraint systems at all times while the vehicle is in motion.

The use of infant or child restraints is required by law in all 50 states, the District of

Columbia, the U.S. territories and all Canadian provinces.

Infants and small children should always be seated in an infant or child seat restraint system appropriate for the size and weight of the child. They must be properly secured in accordance with the manufacturer's installation instructions for the infant or child seat restraint system. All infant and child seat restraint systems must comply with the US Federal Motor Vehicle Safety Standards 213 and 225 and Canadian Motor Vehicle Safety Standards 213 and 210.2.

A statement by the child restraint manufacturer of compliance with these standards can be found on the instruction label on the restraint system. You will also find the statement in the instruction manual provided with the child restraint system.

When using an infant restraint system, child restraint system or booster seat, make sure to carefully read and follow all manufacturer's instructions for installation and use.

Please read the warning labels affixed to the interior of the vehicle or to the infant restraint or child restraint system.

#### **Warning**

Accident statistics show that children secured in the rear seats are safer than children secured in the front-passenger seat. For this reason, we strongly advise that you always secure children in the rear seats. Regardless of the seat position, children under 12 years must be secured correctly in a suitable infant or child restraint system or booster seat suitable for the size and weight of the child.

The infant or child restraint system must be correctly secured using the vehicle's seat belt, the seat belt and Top Tether belt or the lower anchorages and the Top Tether belt in complete accordance with the child seat manufacturer's instructions.





Occupants, in particular children, must sit as upright as possible, fasten the seat belt correctly and use a suitable infant restraint

system, child restraint system or booster seat suitable for the size and weight of the child.

Children can be seriously or even fatally injured by an air bag deploying. Observe the following important information if it is absolutely necessary to carry a child on the front-passenger seat:

- USA only: Your vehicle is equipped with air bag technology that is designed to deactivate the front-passenger front air bag, when the system on the front-passenger seat detects the weight of a typical 12-month old child in a standard child restraint.
- USA only: For children that weigh more than a typical 12-month old child, the front-passenger front air bag can be activated or deactivated. Always make sure that the  indicator lamp is illuminated indicating that the front-passenger front air bag is deactivated.
- Canada only: Children 12 years old and under may ride on the front seat if a BabySmart™ compatible child restraint system is installed on the front-passenger seat. Use only Mercedes-Benz approved BabySmart™ compatible child restraint systems. A BabySmart™ compatible child restraint system will deactivate the front-passenger front air bag when installed correctly. The front-passenger front air bag will not be deactivated if the child restraint systems that are installed are not BabySmart™ compatible or if BabySmart™ compatible child restraint systems are not installed correctly. If the front-passenger front air bag is deployed in a collision, the child could be struck by the air bag. This could lead to serious or fatal injury.
- A child in a rear-facing child restraint on the front-passenger seat will be seriously injured or even killed if the front-passenger front air bag inflates in a collision which could occur under some circumstances, even with the air bag technology installed in your vehicle. The only way to completely

rule out this risk is by making sure you never place a child in a rearward-facing child restraint system on the front-passenger seat. For this reason, we strongly advise that you always carry children in a rearward-facing child restraint system on a rear seat.

- If you must install a rear-facing child restraint on the front-passenger seat because circumstances require you to do so, make sure the  indicator lamp is illuminated, indicating that the front-passenger front air bag is deactivated. If the  indicator lamp does not light up or goes out when the child restraint system is installed, check the anchorages of the restraint system. Check the  indicator lamp regularly while driving to ensure that the  indicator lamp is illuminated. If the  indicator lamp goes out or remains out, you may only carry a child on the front-passenger seat once the system has been repaired.

A child in a rear-facing child restraint on the front-passenger seat will be seriously injured or even killed if the front-passenger front air bag inflates.

- when securing a child in a child restraint system on the front-passenger seat, you must:
  - move the front-passenger seat as far back as possible
  - use a child restraint system that is suitable for the age, size and weight of the child
  - observe the manufacturer's installation instructions in order to install and secure the child restraint system correctly.

### Warning

Infants and small children should never share a seat belt with another occupant. During an accident, they could be crushed between the occupant and seat belt.

A child's risk of serious or fatal injuries is significantly increased if the child restraints

are not properly secured in the vehicle and/or the child is not properly secured in the child restraint.

Children too big for a toddler restraint must ride in seats using regular seat belts. Position the shoulder belt across the chest and shoulder, not face or neck. A booster seat may be necessary to achieve proper seat belt positioning for children over 41 lb (18 kg) until they reach a height where a lap/shoulder belt fits properly without a booster.

When the child restraint is not in use, remove it from the vehicle or secure it with the seat belt to prevent the child restraint from becoming a projectile in the event of an accident.

### Special seat belt retractor

#### Warning

Observe "Important safety notes" (▷ page 58).

All seat belts in the vehicle, except the driver's seat belt, are equipped with a special seat belt retractor. When activated, the special seat belt retractor ensures that the seat belt cannot slacken after being fastened. Installing a child restraint system:

- ▶ Always comply with the manufacturer's installation instructions.
- ▶ Pull the seat belt smoothly from the inertia reel.
- ▶ Engage the seat belt tongue in the belt buckle.

Activating the special seat belt retractor:

- ▶ Pull the seat belt out fully and let the inertia reel retract it again. While the seat belt is retracting, you should hear a ratcheting sound. The special seat belt retractor function is enabled.
- ▶ Push down on the child restraint system to take up any slack.

Removing a child restraint system/  
deactivating the special seat belt retractor:

- ▶ Always comply with the manufacturer's installation instructions.
- ▶ Press the seat belt release button and guide the belt tongue to the belt outlet. The special seat belt retractor function is deactivated.

#### Warning

Never release the seat belt buckle while the vehicle is in motion, since the special seat belt retractor will be deactivated.

### LATCH-type (ISOFIX) child restraint in the rear

#### Warning

Observe "Important safety notes" (▷ page 58).

#### Warning

Children that are too large for a child restraint must travel in seats using normal seat belts. Position shoulder belt across the chest and shoulder, not face or neck.

In order to attain the correct seating position for children weighing over 41 lb (18 kg), it may be necessary to use a booster seat until they reach a height where a normal lap/shoulder seat belt lies properly across their bodies without the need for a booster seat.

Install the child restraint system according to the manufacturer's instructions.

The child restraint system must be installed firmly on both brackets.

An incorrectly installed child restraint system can come loose in the event of an accident, causing the child to be severely or fatally injured.

Child restraint systems/child restraint retaining brackets that are damaged or have suffered damage due to an impact must be replaced.

ISOFIX is a standardized securing system for specially designed child restraint systems on the rear seats. Securing rings for two LATCH-type (ISOFIX) child restraint systems are installed on the left and right of the rear seats.

Use the vehicle's seat belts to install child restraint systems without the ISOFIX securing system. Follow the manufacturer's instructions for of child restraint systems.

- ❗ When installing the child restraint system, make sure that the seat belt for the center seat does not get trapped. Otherwise, the seat belt could be damaged.

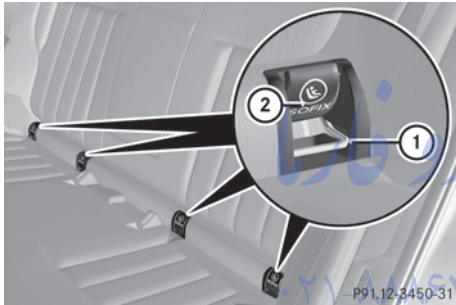

When installing the LATCH-type (ISOFIX) child restraint system, fold protective caps (2) of securing rings (1) inwards.

- Install the LATCH-type (ISOFIX) child restraint system. Comply with the manufacturer's instructions when installing the LATCH-type (ISOFIX) child restraint system.

## Top Tether

### Important safety information

#### ⚠ Warning

Observe "Important safety notes" (▷ page 58).

#### ⚠ Warning

Always lock the rear seat backrests in their upright position when the rear seats are occupied by passengers. Lock the rear seat backrests in their upright position before

installing the Top Tether straps or when the cargo compartment is not in use. Make sure that rear seat backrests are secured properly by pushing and pulling on the seat backrests. If the seat backrest is not locked properly, the seat backrest could fold forward. The child restraint system is no longer supported properly or held in position and can no longer fulfill its function. This could cause serious or even fatal injuries.

Top Tether facilitates an additional attachment point between the LATCH-type (ISOFIX) child seat mount child restraint system and the rear bench seat. This can further reduce the risk of injury.

### Sedan

The Top Tether anchorages are located in the rear compartment behind the head restraints.

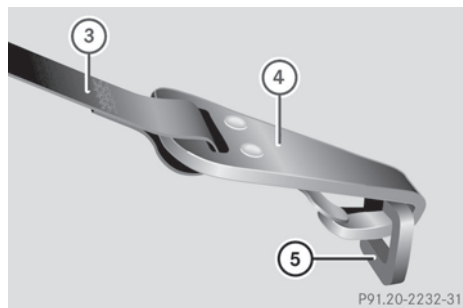
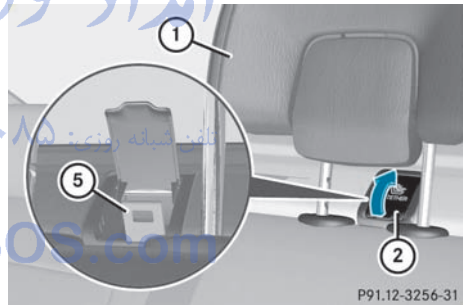

- Move head restraint (1) upwards.
- Fold up cover (2) of Top Tether anchorage (5).

- ▶ Route Top Tether belt (3) under head restraint (1) between both head restraint bars.
- ▶ Hook Top Tether hook (4) into Top Tether anchorage (5).
- ▶ Make sure that Top Tether belt (3) is not twisted.
- ▶ Fold down cover (2) of Top Tether anchorage (5).
- ▶ Move head restraint (1) back down again slightly if necessary (▷ page 105). Make sure that the routing of Top Tether belt (3) is not impaired.
- ▶ Install the ISOFIX child restraint system with Top Tether. Comply with the manufacturer's installation instructions when doing so. Make sure that Top Tether belt (3) sits taut.
- ▶ Move head restraint (1) upwards.
- ▶ Remove combined cargo cover and net (3) (▷ page 281).
- ▶ Route Top Tether belt (6) under head restraint (1) between both head restraint bars.
- ▶ Hook Top Tether hook (5) into Top Tether anchorage (4) on the back of rear seat backrest (2).
- ▶ Make sure that Top Tether belt (6) is not twisted.
- ▶ Move head restraint (1) back down again slightly if necessary (▷ page 105). Make sure that the routing of Top Tether belt (6) is not impaired.
- ▶ Install the ISOFIX child restraint system with Top Tether. Comply with the manufacturer's installation instructions when doing so. Make sure that Top Tether belt (6) sits taut.

### Wagon

The Top Tether anchorages are attached to the rear of the rear seat backrests.

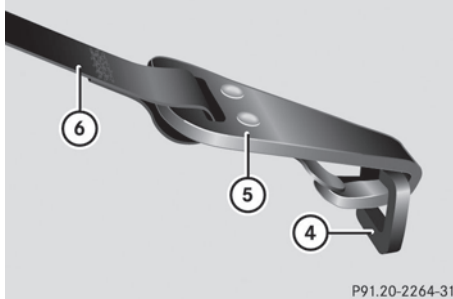
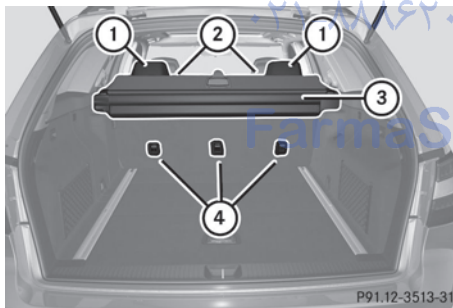

- ▶ Install combined cargo cover and net (3) (▷ page 281).

### Child-proof locks

#### Child-proof locks for the rear doors

##### ⚠ Warning

Observe "Important safety notes" (▷ page 58).

##### ⚠ Warning

Children could open a rear door from inside the vehicle. This could result in serious injuries or an accident. Therefore, when children ride in the rear always secure the rear doors with the child-proof locks.

You can secure each door individually with the child-proof locks on the rear doors. A door secured with a child-proof lock cannot be opened from inside the vehicle. When the vehicle is unlocked, the door can be opened from the outside.

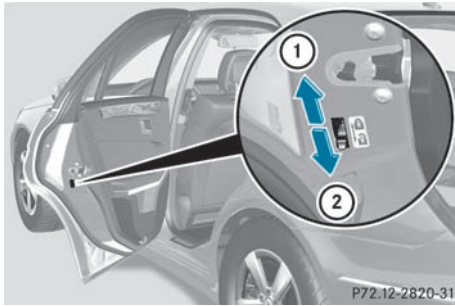

Example: Sedan

- ▶ **To activate:** press the child-proof lock lever up in the direction of arrow ①.
- ▶ Make sure that the child-proof locks are working properly.
- ▶ **To deactivate:** press the child-proof lock lever down in the direction of arrow ②.

### Override feature for the rear side windows

#### Warning

Observe "Important safety notes" (▷ page 58).

#### Warning

When children ride on the vehicle's rear seats, activate the override switch. Otherwise, the children could be injured, e.g. by trapping themselves in the rear side window.

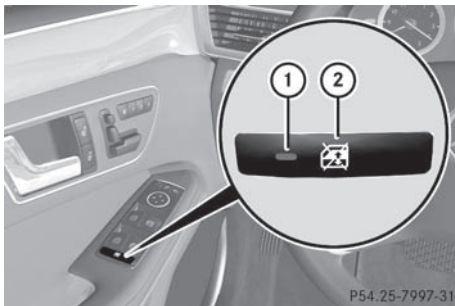

- ▶ **To activate/deactivate:** press button ②. If indicator lamp ① is lit, operation of the rear side windows is disabled. Operation is only possible using the switches in the

driver's door. If indicator lamp ① is off, operation is possible using the switches in the rear compartment.

### Panic alarm



- ▶ **To activate:** press and hold **PANIC** button ① for about one second. An alarm sounds and the exterior lighting flashes.
- ▶ **To deactivate:** press **PANIC** button ① again.
- or
- ▶ Insert the SmartKey into the ignition lock.
- or
- ▶ Press the KEYLESS-GO Start-Stop button. The KEYLESS-GO key must be in the vehicle.

#### USA only:

This device complies with the part 15 of the FCC regulations. Operation is subject to the following two conditions:

1. This device may not cause interference, and
2. This device must withstand any interference received, including interference that may cause undesired operation.

Any unauthorized modification to this device could void the user's authority to operate the equipment.

#### Canada only:



This device complies with the RSS-210 regulations of Industry Canada. Operation is subject to the following two conditions:

1. This device may not cause interference, and
2. This device must withstand any interference received, including interference that may cause undesired operation of the device.

Any unauthorized modification to this device could void the user's authority to operate the equipment.

## Driving safety systems

### Overview of driving safety systems

In this section, you will find information about the following driving safety systems:

- ABS (**A**nti-**l**ock **B**raking **S**ystem)
- BAS (**B**rake **A**ssist **S**ystem)
- BAS PLUS (**B**rake **A**ssist **S**ystem Plus\*)
- ESP® (**E**lectronic **S**tability **P**rogram)
- EBD (**E**lectronic **B**rake-power **D**istribution)
- ADAPTIVE BRAKE
- PRE-SAFE® Brake (vehicles with DISTRONIC PLUS)

### Important safety notes

#### **Warning**

The following factors increase the risk of accidents:

- Excessive speed, especially in turns
- Wet and slippery road surfaces
- Following another vehicle too closely

The driving safety systems described in this section cannot reduce these risks or prevent the natural laws of physics from acting on the vehicle. They cannot increase braking or steering efficiency beyond that afforded by the condition of the vehicle brakes and tires or the traction afforded.

Only a safe, attentive, and skillful driver can prevent accidents.

The capabilities of a vehicle equipped with the driving safety systems described in this section must never be exploited in a reckless or dangerous manner which could jeopardize the user's safety or the safety of others.

Always adjust your driving style to the prevailing road and weather conditions and keep a safe distance to other road users and objects on the street.

If a driving system malfunctions, other driving safety systems may also switch off. Observe indicator and warning lamps that may come on as well as messages in the multifunction display that may appear.

- i** In wintry driving conditions, always use winter tires (M+S tires) and if necessary, snow chains. Only in this way will the driving safety systems described in this section work as effectively as possible.

### ABS (Anti-lock Braking System)

#### Important safety notes

#### **Warning**

Observe "Important safety notes" (▷ page 65).

#### **Warning**

Do not pump the brake pedal. Use firm, steady brake pedal pressure instead. Pumping the brake pedal defeats the purpose of the ABS and significantly reduces braking effectiveness.

ABS regulates brake pressure in such a way that the wheels do not lock when you brake. This allows you to continue steering the vehicle when braking.

ABS works from a speed of about 5 mph (8 km/h) upwards, regardless of road-surface conditions. ABS works on slippery surfaces, even when you only brake gently.

The  warning lamp in the instrument cluster lights up when the ignition is switched on. It goes out when the engine is running.

## Braking

If ABS intervenes when braking, you will feel a pulsing in the brake pedal.

- ▶ **If ABS intervenes:** continue to depress the brake pedal with force until the braking situation is over.
- ▶ **To make a full brake application:** depress the brake pedal with full force.

### Warning

If the ABS malfunctions, other driving systems such as the BAS or the ESP® are also switched off. Observe indicator and warning lamps that may come on as well as messages in the multifunction display that may appear.

If the ABS malfunctions, the wheels may lock during hard braking, reducing the steering capability and extending the braking distance.

The pulsating brake pedal can be an indication of hazardous road conditions and functions as a reminder to take extra care while driving.

## BAS (Brake Assist)

### Warning

Observe "Important safety notes" (▷ page 65).

BAS operates in emergency braking situations. If you depress the brake pedal quickly, BAS automatically boosts the braking force, thus shortening the stopping distance.

- ▶ Keep the brake pedal firmly depressed until the emergency braking situation is over. ABS prevents the wheels from locking.

The brakes will function as usual once you release the brake pedal. BAS is deactivated.

### Warning

If the BAS malfunctions, the brake system still functions, but without the additional brake boost available that the BAS would normally provide in an emergency braking maneuver. Therefore, the braking distance may increase.

## BAS PLUS (Brake Assist PLUS)

### Warning

Observe "Important safety notes" (▷ page 65).

At speeds above approximately 20 mph (30 km/h), BAS PLUS assists you when braking in hazardous situations and uses the radar sensor system to evaluate the traffic conditions.

### Warning!

BAS PLUS is a convenience system designed to assist the driver during vehicle operation. The responsibility for the vehicle speed and the distance to the vehicle ahead, including most importantly brake operation to assure safe stopping distance, always remains with the driver.

Always pay attention to traffic conditions even while BAS PLUS is switched on. Otherwise, you may not be able to recognize dangerous situations until it is too late and could cause an accident. Personal or fatal injury to you or others may be the result.

- ❗ This equipment has been approved by the FCC as a "Vehicular Radar System". The radar sensor system is intended for use in an automotive radar system only. Removal, tampering, or altering of the device will void any warranties, and is not permitted by the FCC. Do not tamper with the device in any way.

Any unauthorized modification to this device could void the user's authority to operate the equipment.



BAS PLUS can detect obstacles that are in the path of your vehicle for an extended period of time. Should you approach a detected obstacle quickly, BAS PLUS calculates the braking force necessary to avoid a rear-end collision. Should you additionally apply the brakes, BAS PLUS will automatically increase the braking force to a level suitable for the traffic conditions.

If BAS PLUS demands particularly high braking force, PRE-SAFE® is activated simultaneously.

- ▶ Keep the brake pedal depressed until the emergency braking situation is over. ABS prevents the wheels from locking.

The brakes will work normally again when:

- you release the brake pedal
- no obstacle is detected in front of your vehicle
- there is no longer any danger of a rear-end collision

BAS PLUS is then deactivated.

At speeds up to approximately 40 mph (70 km/h), BAS PLUS can also detect stationary obstacles, for example, stopped or parked vehicles.

For BAS PLUS to assist you when driving, the radar sensor system must be switched on and operational. You can check this by activating DISTRONIC PLUS (▷ page 179) or via the "radar sensor" function in the on-board computer (▷ page 232).

#### **Warning!**

BAS PLUS will only respond with brake assistance if it has clearly detected an object. Detection can be impeded by

- dirty or covered sensors
- snowfall or heavy rain
- disturbance from other radar sources
- strong radar reflection such as in parking garages

BAS PLUS uses radar signals that are not reflected well by narrow objects and absorptive materials. For this reason BAS

PLUS will not react to persons, animals, and approaching traffic or cross-traffic.

BAS PLUS may not detect narrow vehicles driving in front of you, such as motorcycles and vehicles driving offset from your vehicle center.

Following a collision or accident-related damage to the front end of the vehicle, have the configuration and operation of the radar sensors checked at an authorized Mercedes-Benz Center.

If BAS PLUS is not available due to a malfunction in the radar sensor system, the brake system remains available with full brake boosting effect and BAS.

## ESP® (Electronic Stability Program)

### Important safety notes

#### **Warning**

Observe "Important safety notes"

(▷ page 65). تلفن شماره روزی: ۰۸۸۶۲۰۸۸

If ESP® detects that the vehicle is deviating from the direction desired by the driver, one or more wheels are braked to stabilize the vehicle. If necessary, the engine output is also modified to keep the vehicle on the desired course within physical limits. ESP® assists the driver when pulling away on wet or slippery roads. ESP® can also stabilize the vehicle during braking.

If ESP® intervenes, the  warning lamp flashes in the instrument cluster.

**⚠ Warning!**

Never switch off the ESP when you see the ESP warning lamp  flashing in the instrument cluster. In this case proceed as follows:

- When driving off, apply as little throttle as possible.
- While driving, ease up on the accelerator pedal.
- Adapt your speed and driving style to the prevailing road conditions.

Failure to observe these guidelines could cause the vehicle to skid. The ESP cannot prevent accidents resulting from excessive speed.

**!** Vehicles without 4MATIC: switch the ignition off when:

- the parking brake is being tested using a dynamometer
- the vehicle is being towed with the front/rear axle raised

Application of the brakes by ESP® may otherwise destroy the brake system.

**!** Vehicles with 4MATIC: switch off the ignition when the parking brake is being tested on a brake dynamometer.

Application of the brakes by ESP® may otherwise destroy the brake system.

**i** Only use wheels with the recommended tire sizes. Only then will ESP® function properly.

**ETS/4ETS (Electronic Traction System)****⚠ Warning!**

Observe "Important safety notes" (> page 65).

Traction control is part of ESP®.

Traction control brakes the drive wheels individually if they spin. This enables you to pull away and accelerate on slippery surfaces, for example if the road surface is slippery on

one side. On vehicles with 4MATIC, more drive torque is also transferred to the wheel or wheels with traction.

Traction control remains active if you deactivate ESP®.

**Deactivating/activating ESP® (except AMG vehicles)****⚠ Warning!**

The ESP should not be switched off during normal driving other than in the circumstances described below. Disabling the system will reduce vehicle stability in driving maneuvers.

Do not switch off the ESP when a spare wheel is mounted.

ESP® is activated automatically when the engine is running.

It may be best to deactivate ESP® in the following situations:

- when using snow chains
- in deep snow تلفن
- on sand or gravel

**⚠ Warning!**

Switch on the ESP immediately if the aforementioned circumstances do not apply anymore. Otherwise the ESP will not stabilize the vehicle when it is starting to skid or a wheel is spinning.

If you deactivate ESP®:

- ESP® no longer improves driving stability.
- the engine's torque is no longer limited and the drive wheels can spin. The spinning of the wheels results in a cutting action, which provides better grip.
- traction control is still activated.
- ESP® still provides support when you brake.

If ESP® is deactivated and one or more wheels start to spin, the  warning lamp in the



instrument cluster flashes. In such situations, ESP® will not stabilize the vehicle.

► **To deactivate:** (▷ page 228).

The  warning lamp in the instrument cluster lights up.

 **Warning**

When the  ESP OFF warning lamp lights up, ESP is switched off.

When the  ESP warning lamp and the  ESP OFF warning lamp are on continuously, ESP is not operational due to a malfunction.

When ESP is switched off or not operational, the vehicle's stability during standard driving maneuvers is reduced.

Adapt your driving style to suit the prevailing road conditions/weather conditions and to the non-operating status of ESP.

**!** Avoid spinning a drive wheel for an extended period with ESP switched off. This could cause serious damage to the drive train.

► **To activate:** (▷ page 228).

The  warning lamp in the instrument cluster goes out.

## Deactivating/activating ESP® (AMG vehicles)

### Activating/deactivating SPORT handling mode

 **Warning**

The SPORT handling mode should not be switched on during normal driving.

Switching on the SPORT handling mode will result in the following:

- no restriction to the engine torque
- system supported traction control is limited

The SPORT handling mode is designed for driving on closed tracks when the vehicle's own natural oversteer and understeer characteristics are desired and requires a

highly skilled and experienced driver able to handle these critical driving situations.

You could lose control of your vehicle and cause an accident.

Please be aware of these limits when you switch on the SPORT handling mode.

Do not switch on the SPORT handling when a spare wheel is mounted.

SPORT handling mode is active automatically as long as the engine is running.

It may be best to activate SPORT handling mode in the following situations:

- when using snow chains
- in deep snow
- on sand or gravel

 **Warning**

Switch off the SPORT handling mode and switch on the ESP® immediately if the aforementioned circumstances do not apply anymore. Otherwise the SPORT handling mode will only stabilize the vehicle to a limited extent when it is starting to skid or a wheel is spinning.

When SPORT handling mode is activated:

- ESP® only improves driving stability to a limited degree.
- the engine's torque is restricted to a limited degree and the drive wheels can spin. The spinning of the wheels results in a cutting action, which provides better grip.
- traction control is still activated.
- ESP® still provides support when you brake firmly.

If SPORT handling mode is activated and one or more wheels start to spin, the  warning lamp in the instrument cluster flashes. ESP® only stabilizes the vehicle to a limited degree.



► **To activate:** briefly press button ①.

The **SPORT** warning lamp in the instrument cluster lights up. The SPORT handling mode message appears in the multifunction display.

► **To deactivate:** briefly press button ①.

The **SPORT** warning lamp in the instrument cluster goes out.

### Activating/deactivating ESP®

#### ⚠ Warning!

The ESP should not be switched off during normal driving.

Disabling of the system will result in the following:

- no restriction to engine torque
- loss of system-supported traction control

"ESP OFF" is designed for driving on closed tracks when the vehicle's natural oversteer and understeer characteristics are desired and requires a highly skilled and experienced driver able to handle these critical driving situations.

You could lose control of your vehicle and cause an accident.

Please be aware of these limits when you switch off the ESP.

Do not switch off the ESP when a spare wheel is mounted.

ESP® is activated automatically when the engine is running.

It may be best to deactivate ESP® in the following situations:

- when using snow chains
- in deep snow
- on sand or gravel

#### ⚠ Warning!

Switch on the ESP immediately if the aforementioned circumstances do not apply anymore. Otherwise the ESP will not stabilize the vehicle when it is starting to skid or a wheel is spinning.

If you deactivate ESP®:

- ESP® no longer improves driving stability.
- the engine's torque is no longer limited and the drive wheels are able to spin. The spinning of the wheels results in a cutting action, which provides better grip.
- traction control is still activated.
- PRE-SAFE® is no longer available and is also not activated if you brake firmly with the assistance of ESP.
- PRE-SAFE® Brake is no longer available and is also not activated if you brake firmly with the assistance of ESP.
- ESP® still provides support when you brake firmly.



If ESP® is deactivated and one or more wheels start to spin, the  warning lamp in the instrument cluster does not flash. In such situations, ESP® will not stabilize the vehicle.



- **To deactivate:** press button ① until the  warning lamp lights up in the instrument cluster.  
The message ESC-OFF appears in the multifunction display.

### **Warning**

When the  ESP OFF warning lamp lights up, ESP is switched off.

When the  ESP warning lamp and the  ESP OFF warning lamp are on continuously, ESP is not operational due to a malfunction.

When ESP is switched off or not operational, the vehicle's stability during standard driving maneuvers is reduced.

Adapt your driving style to suit the prevailing road conditions/weather conditions and to the non-operating status of ESP.

- !** Avoid spinning a drive wheel for an extended period with ESP switched off. This could cause serious damage to the drive train.
- **To activate:** briefly press button ①.  
The  warning lamp in the instrument cluster goes out. The message ESC-ON appears in the multifunction display.

## EBD

### **Warning**

Observe "Important safety notes" (▷ page 65).

EBD monitors and controls the brake pressure on the rear wheels to improve driving stability while braking.

### **Warning!**

If the EBD malfunctions, the brake system will still function with full brake boost. However, the rear wheels could lock up during emergency braking situations, for example. You could lose control of the vehicle and cause an accident.

Adapt your driving style to the changed driving characteristics.

## Adaptive Brake

ADAPTIVE BRAKE enhances braking safety and offers increased braking comfort. In addition to the braking function, ADAPTIVE BRAKE also has the HOLD function (▷ page 188) and hill start assist (▷ page 152). For further information, see Driving tips (▷ page 173).

## PRE-SAFE® Brake (vehicles with DISTRONIC PLUS)

PRE-SAFE® Brake can help you to minimize the risk of a frontal collision with a vehicle ahead or reduce the effects of such a collision.

This function warns you from a speed of approximately 20 mph (30 km/h) when you are rapidly approaching a vehicle in front. An intermittent warning tone sounds and the  distance warning lamp lights up in the instrument cluster.

Due to the nature of the system, particularly complicated driving conditions may cause the system to display an unnecessary warning.

At speeds of above approximately 20 mph (30 km/h), if the driver and passengers have fastened their seat belts, the PRE-SAFE® Brake can:

- brake the vehicle automatically at speeds ranging up to approximately 124 mph (200 km/h)
- trigger preventative occupant protection measures (PRE-SAFE®) (▷ page 51)

### **Warning!**

An intermittent warning sounds and the distance warning lamp  in the instrument cluster is illuminated if the PRE-SAFE® Brake calculates that the distance to the vehicle ahead and your vehicle's current speed

indicate that the PRE-SAFE® Brake will not be capable of slowing the vehicle sufficiently to maintain the preset following distance, which creates a danger of a collision.

Immediately brake your vehicle to increase the distance between your vehicle and the vehicle driving in front of you. The warning sound is intended as a final caution that you have not interceded with your own braking inputs to avoid a potentially dangerous situation. Do not wait for the operation of the warning signal to intercede with your own braking, as that will result in potentially dangerous emergency braking which will not always result in an impact being avoided.

Tailgating increases the risk of an accident.

### **Warning!**

The PRE-SAFE® Brake is a convenience system designed to assist the driver during vehicle operation. The responsibility for the vehicle speed and the distance to the vehicle ahead, including most importantly brake operation to assure safe stopping distance, always remains with the driver.

Always pay attention to traffic conditions even while the PRE-SAFE® Brake is switched on. Otherwise, you may not be able to recognize dangerous situations until it is too late and could cause an accident resulting in personal or fatal injury to you or others.

**i** USA only: this device has been approved by the FCC as a "Vehicular Radar System". The radar sensor system is intended for use in an automotive radar system only. Removal, tampering, or altering of the device will void any warranties, and is not permitted by the FCC. Do not tamper with the device in any way.

Any unauthorized modification to this device could void the user's authority to operate the equipment.

**i** Canada only: this device complies with RSS-210 from Industry Canada. Operation is subject to the following two conditions:

1. This device may not cause interference, and
2. This device must withstand any interference received, including interference that may cause undesired operation.

Removal, tampering, or altering of the device will void any warranties, and is not permitted. Do not tamper with the device in any way.

Any unauthorized modification to this device could void the user's authority to operate the equipment.

With the help of the radar sensor system, PRE-SAFE® Brake can detect obstacles that are in front of your vehicle for an extended period of time. If you approach an obstacle and PRE-SAFE® Brake detects a risk of a collision, the system will initially alert you both visually and acoustically. If you do not brake or steer, the vehicle will at first automatically brake slightly. In the event of an increased risk of a collision, PRE-SAFE® is activated (> page 51). If the risk of collision remains and you do not brake, take evasive action or accelerate significantly, the vehicle may perform automatic emergency braking.

### **Warning!**

The PRE-SAFE® Brake will only respond with brake assistance if it has clearly detected an object. Detection can be impeded by:

- dirty or covered sensors
- snowfall or heavy rain
- disturbance from other radar sources
- strong radar reflection such as in parking garages

The PRE-SAFE® Brake uses radar signals that are not reflected well by narrow objects and absorptive materials. For this reason the PRE-SAFE® Brake will not react to persons, animals, and approaching traffic or cross-traffic.

The PRE-SAFE® Brake may not detect narrow vehicles driving in front of you, such as



motorcycles and vehicles driving offset from your vehicle center.

### **Warning**

Depending on the vehicle speed, PRE-SAFE® Brake brakes your vehicle with a maximum of 13 ft/s<sup>2</sup> (4 m/s<sup>2</sup>) before a possible hard stop. This corresponds to about 40 % of the maximum deceleration ability of your vehicle. The driver must apply the brakes additionally in order to prevent a collision. The self-acting hard stop will be initiated when the imminent danger of a collision exists, e.g. when an evasive maneuver cannot avoid an accident.

In order to maintain the appropriate distance to the vehicle in front and thus prevent a collision, you must apply the brakes yourself. At speeds up to approximately 40 mph (70 km/h), PRE-SAFE® Brake can also detect stationary obstacles, for example stopped or parked vehicles.

### **Warning!**

If you do not receive visual or acoustic warning signals, the PRE-SAFE® Brake may

- not have recognized the collision risk
- have been deactivated
- be malfunctioning

Apply the brakes yourself to avoid a collision.

- ▶ **To activate:** activate PRE-SAFE® Brake in the on-board computer (▷ page 228). The  symbol appears in the lower multifunction display, as long as the HOLD function is not activated (▷ page 188). On vehicles with parking guidance, the **P** gear must be engaged for the icon to be displayed.

For PRE-SAFE® Brake to assist you when driving, the radar sensor system must be switched on and operational.

PRE-SAFE® Brake does not always detect complex traffic situations properly. You can terminate the braking action of PRE-SAFE® Brake in a non-critical driving situation at any time if:

- an acoustic and visual warning occurs
- the vehicle brakes

To end this, you can either depress the accelerator pedal further, activate kickdown or release the brake pedal.

The braking action of PRE-SAFE® Brake is ended automatically if:

- you maneuver to avoid the obstacle
- you drive slower than approximately 9 mph (15 km/h)
- there is no longer an obstacle detected in front of your vehicle
- there is no longer any danger of a collision

Following a collision or accident-related damage to the front end of the vehicle, have the configuration and operation of the radar sensors checked. Choose a qualified specialist workshop for this which has the necessary specialist knowledge and tools for the work required. Mercedes-Benz recommends that you use an authorized Mercedes-Benz Center for this purpose.

## Anti-theft systems

### Immobilizer

The immobilizer prevents your vehicle from being started without the correct key.

When leaving the vehicle, always take the SmartKey with you and lock the vehicle. The engine can be started by anyone with a valid key that is left inside the vehicle.

- ▶ **To activate with the SmartKey:** remove the SmartKey from the ignition lock.
- ▶ **To activate with KEYLESS-GO:** switch the ignition off and open the driver's door.
- ▶ **To deactivate:** switch on the ignition.

**i** The immobilizer is always deactivated when you start the engine.

In the event that the engine cannot be started when the starter battery is fully charged, the immobilizer may be faulty. Contact an authorized Mercedes-Benz Center or call 1-800-FOR-MERCEdes (in USA) or 1-800-387-0100 (in Canada).

### ATA (Anti-Theft Alarm system)

A visual and audible alarm is triggered if the alarm system is armed and you open:

- a door
- the vehicle with the mechanical key
- the trunk lid/tailgate
- the hood

The alarm is not switched off, even if you close the open door that has triggered it, for example.

**i** If the alarm stays on for more than 30 seconds, the emergency call system mbrace (USA only) or TELEAID (Canada only) initiates a call to the Customer Assistance Center automatically. The emergency call system initiates the call provided that:

- you have subscribed to the mbrace/TELEAID service.
- the mbrace/TELEAID service has been activated properly.
- the required mobile phone, power supply and GPS are available.



► **To arm:** lock the vehicle with the SmartKey or KEYLESS-GO.

Indicator lamp ① flashes. The alarm system is armed after approximately 15 seconds.

► **To deactivate:** unlock the vehicle using the SmartKey or KEYLESS-GO.

► **To stop the alarm using the SmartKey:** insert the SmartKey into the ignition lock. The alarm is switched off.

or

► Press the  or  button on the SmartKey.

The alarm is switched off.

► **To stop the alarm using KEYLESS-GO:** grasp the outside door handle. The key must be outside the vehicle.

The alarm is switched off.

or

► Press the Start/Stop button on the dashboard. The key must be inside the vehicle.

The alarm is switched off.





Vehicle equipment .....	76
SmartKey .....	76
Doors .....	84
Trunk/cargo compartment .....	86
Side windows .....	91
Sliding sunroof .....	95

# امداد خودرو فارما

تلفن شبانه روزی: ۰۲۱-۸۸۸۶۲۰۸۵

[FarmaSOS.com](http://FarmaSOS.com)

## Vehicle equipment

- i** This manual describes all the standard and optional equipment of your vehicle which was available at the time of purchase. Country-specific differences are possible. Bear in mind that your vehicle may not feature all functions described here. This also refers to safety-related systems and functions.

## SmartKey

### Important safety notes

#### Warning!

When leaving the vehicle, always remove the SmartKey from the starter switch. Always take the SmartKey with you and lock the vehicle. Do not leave children unattended in the vehicle, even if they are secured in a child restraint system, or with access to an unlocked vehicle. A child's unsupervised access to a vehicle could result in an accident and/or serious personal injury. The children could

- injure themselves on parts of the vehicle
- be seriously or fatally injured through excessive exposure to extreme heat or cold
- injure themselves or cause an accident with vehicle equipment that can be operated even if the SmartKey is removed from the starter switch or removed from the vehicle, such as seat adjustment, steering wheel adjustment, or the memory function

If children open a door, they could injure other persons or get out of the vehicle and injure themselves or be injured by following traffic.

Do not expose the child restraint system to direct sunlight. The child restraint system's metal parts, for example, could become very hot, and the child could be burned by these parts.

#### Warning

Do not carry heavy or hard objects in the passenger compartment or trunk/cargo compartment unless they are firmly secured in place.

Unsecured or improperly positioned cargo increases a child's risk of injury in the event of

- strong braking maneuvers
- sudden changes of direction
- an accident

### General information

If you cannot open or lock the vehicle with the SmartKey, either the battery in the SmartKey is empty, the SmartKey is faulty, or the vehicle battery is discharged.

- ▶ Check the battery in the SmartKey and replace it if necessary (▷ page 80).
- ▶ Unlock the driver's door using the mechanical key (▷ page 79).
- ▶ Lock the vehicle using the mechanical key (▷ page 79).
- ▶ Have the vehicle battery and battery contacts checked by an authorized Mercedes-Benz Center.

If the SmartKey is faulty, contact Roadside Assistance or an authorized Mercedes-Benz Center.

### SmartKey functions



#### Locking and unlocking centrally

The SmartKey centrally locks/unlocks:

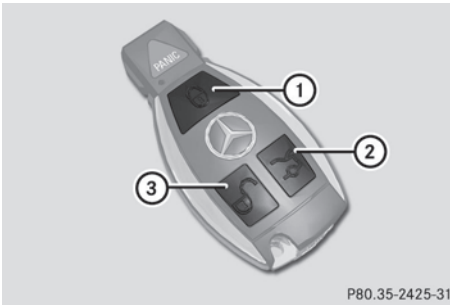
- the doors
- the trunk lid/tailgate
- the fuel filler flap



P80.35-2425-31

- ①  To lock the vehicle
- ②  To unlock the trunk lid/tailgate
- ③  To unlock the vehicle

When unlocking, the turn signals flash once. When locking, they flash three times.

When it is dark, the surround lighting also comes on if it is activated in the on-board computer.

You can also set an audible signal to confirm that the vehicle has been locked or unlocked. The audible signal can be activated and deactivated using the on-board computer (▷ page 232).

#### **i** Only for USA:

This equipment complies with Part 15 of the FCC regulations. Operation is subject to the following conditions:

- this equipment must not emit harmful, electromagnetic radiation.
- this equipment may be affected by electromagnetic radiation, including radiation which can trigger unwanted functions.

Any unauthorized change to this equipment can lead to the user's operating license being withdrawn.

#### **i** Only for Canada:

This equipment complies with the RSS-210 regulations of Industry Canada. Operation is subject to the following conditions:

- this equipment must not emit harmful, electromagnetic radiation.
- this equipment receives electromagnetic radiation, including radiation which can trigger unwanted functions.

Any unauthorized change to this equipment can lead to the user's operating license being withdrawn.

- ▶ **To unlock centrally:** press the  button.

If you do not open a door or the trunk lid/tailgate within approximately 40 seconds of unlocking the vehicle:

- the vehicle is locked again.
- the theft deterrent locking system is activated again.

- ▶ **To lock centrally:** press the  button.

## KEYLESS-GO

### General notes

#### **i** Only for USA:

This equipment complies with Part 15 of the FCC regulations. Operation is subject to the following conditions:

- this equipment must not emit harmful, electromagnetic radiation.
- this equipment may be affected by electromagnetic radiation, including radiation which can trigger unwanted functions.

Any unauthorized change to this equipment can lead to the user's operating license being withdrawn.

#### **i** Only for Canada:

This equipment has been released in accordance with RSS - 210 of Industry Canada. Operation is subject to the following conditions:

- this equipment must not emit harmful, electromagnetic radiation.
- this equipment receives electromagnetic radiation, including radiation which can trigger unwanted functions.

Any unauthorized change to this equipment can lead to the user's operating license being withdrawn.

### Important information for using KEYLESS-GO

- You can use the KEYLESS-GO key as a conventional key.
  - You can combine KEYLESS-GO functions with those of a conventional key (e.g. open with KEYLESS-GO and close with the  button).
  - Always carry your KEYLESS-GO key on your person.
  - Never keep the KEYLESS-GO key with:
    - electronic equipment, such as your mobile phone or another key
    - metal objects, such as coins or metal foil
- This may impair the functioning of KEYLESS-GO.
- To open or close the vehicle, the KEYLESS-GO key should be no more than 3 ft (1 m) from the door or trunk/cargo area.
  - When the vehicle is parked for more than 72 hours, the KEYLESS-GO function is deactivated. Pull one of the outer door handles and turn on the ignition to reactivate the KEYLESS-GO function.
  - If the KEYLESS-GO key is not near the vehicle, it is possible that the system may not recognize it. In this case, the vehicle cannot be locked or started with KEYLESS-GO.
  - If the KEYLESS-GO key has been removed from the vehicle (e.g. if a passenger leaves the vehicle with the KEYLESS-GO key):
    - while someone is holding the Start/Stop button or attempting to lock the vehicle with the outer door handle, the message
- Key not detected appears in the multifunction display
- while the engine is running, the red message Key not detected appears in the multifunction display as you pull away. Find the KEYLESS-GO key or change its current position immediately (e.g. place it on the front-passenger seat or carry it in your shirt pocket.)
- If you have started the engine using the Start/Stop button, you can turn it off again by:
    - pressing the Start/Stop button again
    - inserting the KEYLESS-GO key in the ignition lock when the vehicle is stationary and the automatic transmission is in parking position P.
  - You may accidentally unlock the vehicle if the KEYLESS-GO key is within 3 ft (1 m) of the vehicle and:
    - an outer door handle comes into contact with water
    - or
    - you are cleaning an outer door handle.
  - Note that the engine can be started by any vehicle occupant if a KEYLESS-GO key is in the vehicle.
 

**Option 1:** there is a KEYLESS-GO key in the vehicle and a KEYLESS-GO key outside the vehicle. If you leave the KEYLESS-GO key behind when you get out and lock the vehicle, a message does not appear in the multifunction display.

**Option 2:** there is a KEYLESS-GO key in the vehicle but no KEYLESS-GO key outside the vehicle. When you get out and try to lock the vehicle, the message *Key still in vehicle* appears in the multifunction display. The vehicle is not locked in this case.
- When starting the engine and while driving, KEYLESS-GO also checks whether a valid key is in the vehicle by periodically establishing radio contact.

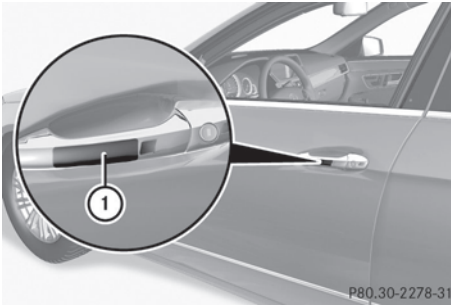



- ▶ **To unlock the vehicle:** touch the inner surface of the door handle.
- ▶ **To lock the vehicle:** touch sensor surface ①.



If you pull on the handle of the trunk lid/tailgate, only the trunk/cargo area of the vehicle is unlocked.

### Changing the settings of the locking system

You can change the settings of the locking system in such a way that only the driver's door and the fuel filler flap are unlocked. This is useful if you frequently travel on your own.

- ▶ **To change the setting:** press the  and  buttons simultaneously for approximately six seconds until the battery check lamp flashes twice.



The SmartKey now functions as follows:

- ▶ **To unlock the driver's door:** press the  button once.
- ▶ **To unlock centrally:** press the  button twice.
- ▶ **To lock centrally:** press the  button.

The KEYLESS-GO function is changed as follows:

- ▶ **To unlock the driver's door:** touch the inner surface of the door handle on the driver's door.
- ▶ **To unlock centrally:** touch the inner surface of the door handle on the front-passenger door or the rear door.
- ▶ **To lock centrally:** touch sensor surface ① on one of the door handles.

### Restoring the factory settings

- ▶ Press the  and  buttons simultaneously for approximately six seconds until the battery check lamp flashes twice.



### Mechanical key

#### General notes

If the vehicle can no longer be locked or unlocked with the SmartKey, use the mechanical key.

If you use the mechanical key to unlock and open the driver's door or the trunk lid/tailgate, the anti-theft alarm system will be triggered (▷ page 74).

There are several ways to turn off the alarm:

- ▶ Press the  or  button on the SmartKey.
- or
- ▶ Insert the SmartKey into the ignition lock.
- or
- ▶ Press the Start/Stop button in the ignition lock. The SmartKey must be in the vehicle.
- or
- ▶ Lock or unlock the vehicle using KEYLESS-GO. The SmartKey must be outside the vehicle.

If you unlock the vehicle using the mechanical key, the fuel filler flap will not be unlocked automatically.

- ▶ **To unlock the fuel filler flap:** insert the SmartKey in the ignition lock.

### Removing the mechanical key

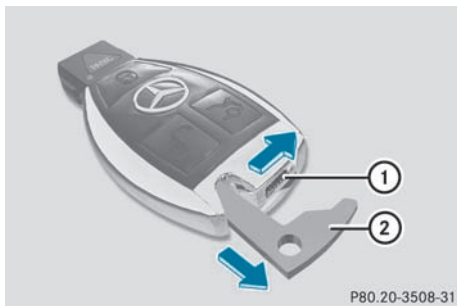

- ▶ Push release catch ① in the direction of the arrow and at the same time remove mechanical key ② from the SmartKey.

### SmartKey battery

#### Important safety notes

It is advisable to have batteries replaced at a qualified specialist workshop, e.g. at an authorized Mercedes-Benz Center.

#### Warning!

Batteries are toxic and contain caustic substances. For this reason, keep batteries out of the reach of children.



If a battery has been swallowed, visit a doctor immediately.

#### Warning

SmartKey batteries contain perchlorate material, which may require special handling and regard for the environment. Check with your local government's disposal guidelines. California residents, see [www.dtsc.ca.gov/HazardousWaste/Perchlorate/index.cfm](http://www.dtsc.ca.gov/HazardousWaste/Perchlorate/index.cfm).

### Checking the battery





- ▶ Press the  or  button. The battery is working properly if battery charge indicator lamp ① lights up briefly.

If battery charge indicator lamp ① does not light up briefly during the test, the key batteries are discharged.

- ▶ Change the key battery (▷ page 80).

 Consult any authorized Mercedes-Benz Center for a key battery.

 If the battery is tested within the signal range of the vehicle, you can open or close the vehicle by pressing  or  respectively.

### Changing the battery

You require a CR 2025 3 V cell battery.

- ▶ Take the mechanical key out of the SmartKey (▷ page 79).

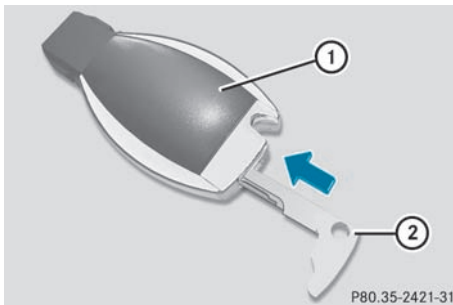

- ▶ Press mechanical key ② into the opening in the SmartKey in the direction of the

arrow until battery tray cover ① opens. Do not hold the cover closed while doing so.

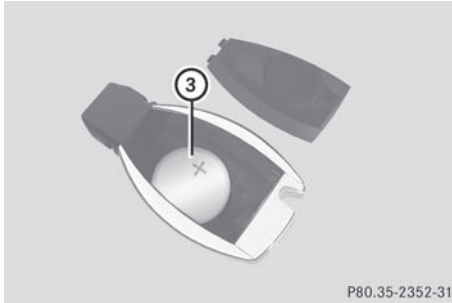





- ▶ Remove the cover of the battery tray.
- ▶ Repeatedly tap the SmartKey against your palm until battery ③ falls out.
- ▶ Insert the new battery with the positive pole facing upwards. Use a lint-free cloth to do so.
- ▶ Insert the front tabs of the battery tray's cover first and then press to close it.
- ▶ Check the function of all SmartKey buttons on the vehicle.

تلفن شبانه روزی: ۰۲۱-۸۸۸۶۲۰۸۵

FarmaSOS.com

## Problems with the SmartKey

Problem	Possible causes/consequences and ► Solutions
You cannot lock/unlock the vehicle using the SmartKey.	<p>The SmartKey battery is discharged or nearly discharged.</p> <ul style="list-style-type: none"> <li>► Point the tip of the SmartKey at the driver's door handle from a distance of approximately 1.5 ft (50 cm) and try to unlock or lock the vehicle again.</li> </ul> <p>If this does not work:</p> <ul style="list-style-type: none"> <li>► Lock or unlock the vehicle using the mechanical key (▷ page 79).</li> </ul> <p>The SmartKey is faulty.</p> <ul style="list-style-type: none"> <li>► Lock the vehicle as described in the "Locking the vehicle (mechanical key)" section (▷ page 86) or unlock it using the mechanical key (▷ page 79).</li> <li>► Have the SmartKey checked at a qualified specialist workshop.</li> </ul>
You can no longer lock/unlock the vehicle using KEYLESS-GO.	<p>KEYLESS-GO is in standby mode because the vehicle has not been unlocked for an extended period.</p> <ul style="list-style-type: none"> <li>► Pull the door handle and then turn the SmartKey to position <b>2</b> in the ignition lock.</li> </ul> <p>There is a malfunction with KEYLESS-GO.</p> <ul style="list-style-type: none"> <li>► Lock/unlock the vehicle using the remote control function of the SmartKey. Point the tip of the SmartKey at the driver's door handle from close range and press the  /  button.</li> <li>► Have the SmartKey checked at a qualified specialist workshop.</li> </ul> <p>There is interference from a powerful source of radio waves.</p> <ul style="list-style-type: none"> <li>► Lock/unlock the vehicle using the remote control function of the SmartKey. Point the tip of the SmartKey at the driver's door handle from close range and press the  /  button.</li> </ul>
You have lost a SmartKey.	<ul style="list-style-type: none"> <li>► Have the SmartKey canceled at an authorized Mercedes-Benz Center.</li> <li>► Report the loss immediately to the vehicle insurers.</li> <li>► If necessary, have the locks changed as well.</li> </ul>
You have lost the mechanical key.	<ul style="list-style-type: none"> <li>► Report the loss immediately to the vehicle insurers.</li> <li>► If necessary, have the locks changed as well.</li> </ul>



Problem	Possible causes/consequences and ► Solutions
The engine cannot be started using the SmartKey.	<p>The on-board voltage is too low.</p> <ul style="list-style-type: none"> <li>► Switch off non-essential consumers, e.g. seat heating or interior lighting, and try to start the engine again.</li> </ul> <p>If this does not work:</p> <ul style="list-style-type: none"> <li>► Check the starter battery and charge it if necessary (▷ page 338).</li> </ul> <p>or</p> <ul style="list-style-type: none"> <li>► Jump-start the vehicle (▷ page 341).</li> </ul> <p>or</p> <ul style="list-style-type: none"> <li>► Consult a qualified specialist workshop.</li> </ul>
The engine cannot be started using the SmartKey.	<p>The steering lock is mechanically blocked<sup>4</sup>.</p> <ul style="list-style-type: none"> <li>► Remove the SmartKey and re-insert it into the ignition lock. While doing this, turn the steering wheel in both directions.</li> </ul>
The engine cannot be started using KEYLESS-GO. The SmartKey is in the vehicle.	<p>A door is open. Therefore, the SmartKey cannot be detected as easily.</p> <ul style="list-style-type: none"> <li>► Close the door and try to start the vehicle again.</li> </ul> <p>There is interference from a powerful source of radio waves.</p> <ul style="list-style-type: none"> <li>► Start your vehicle with the SmartKey in the ignition lock.</li> </ul>

FarmaSOS.com

<sup>4</sup> Not vehicles with DIRECT SELECT lever.

## Doors

### Important safety notes

#### Warning!

When leaving the vehicle, always remove the SmartKey from the starter switch. Always take the SmartKey with you and lock the vehicle. Do not leave children unattended in the vehicle, even if they are secured in a child restraint system, or with access to an unlocked vehicle. A child's unsupervised access to a vehicle could result in an accident and/or serious personal injury. The children could

- injure themselves on parts of the vehicle
- be seriously or fatally injured through excessive exposure to extreme heat or cold
- injure themselves or cause an accident with vehicle equipment that can be operated even if the SmartKey is removed from the starter switch or removed from the vehicle, such as seat adjustment, steering wheel adjustment, or the memory function

If children open a door, they could injure other persons or get out of the vehicle and injure themselves or be injured by following traffic.

Do not expose the child restraint system to direct sunlight. The child restraint system's metal parts, for example, could become very hot, and the child could be burned by these parts.

#### Warning

Do not carry heavy or hard objects in the passenger compartment or trunk/cargo compartment unless they are firmly secured in place.

Unsecured or improperly positioned cargo increases a child's risk of injury in the event of

- strong braking maneuvers
- sudden changes of direction
- an accident

### Unlocking and opening doors from the inside

You can open a door from inside the vehicle even if it has been locked, unless the child-proof locks have been activated (▷ page 63). Only open the door if traffic conditions allow you to do so.

If the vehicle has previously been locked with the SmartKey or with KEYLESS-GO, opening a door from the inside will trigger the anti-theft alarm system. Switch off the alarm (▷ page 74).

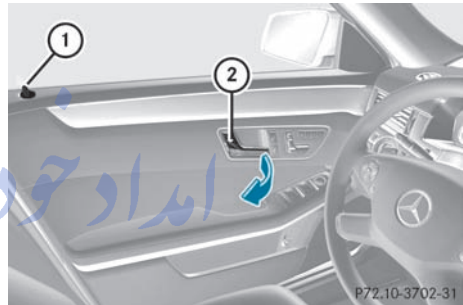

► **Front door:** pull door handle ②.

If the door is locked, locking knob ① pops up. The door is unlocked and can be opened.

► **Rear door:** pull up locking knob ① on the respective rear door.

The rear door is unlocked and can be opened.

### Centrally locking and unlocking the vehicle from the inside

The locking or unlocking buttons of the central locking do not lock or unlock the fuel filler flap.

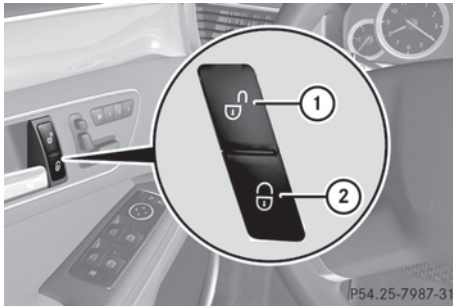

► **To unlock:** press button ①.

► **To lock:** press button ②.

The vehicle locks when all the doors are closed.

You can open a locked front door from inside the vehicle. Only open the door if traffic conditions allow you to do so.

If the vehicle has previously been locked with the central locking button:

- and the KEYLESS-GO key is restored to the factory settings, the entire vehicle is unlocked if a front door is opened from inside the vehicle.
- and the KEYLESS-GO key is set to individual settings, only the front door which is opened from inside the vehicle is unlocked.

If the vehicle has been locked centrally with the SmartKey or with KEYLESS-GO, it does not unlock if you use the unlocking button of the central locking.

### Automatic locking

**i** The vehicle locks automatically when the ignition is switched on and the wheels of the vehicle are moving at a speed of more than 9 mph (15 km/h). You may therefore lock yourself out if the vehicle is being pushed, towed, or located on a test rig.

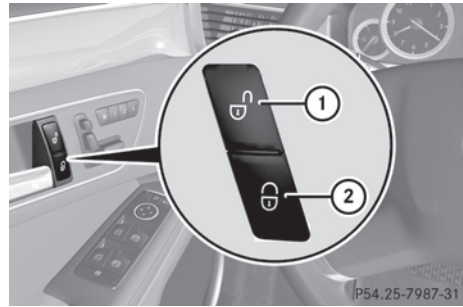

► **To deactivate:** press and hold button ① for about five seconds until a tone sounds.

► **To activate:** press and hold button ② for about five seconds until a tone sounds.

**i** When you push either of the two buttons and an audible warning signal does not sound, the relevant setting has already been selected.

You can switch the automatic locking function on and off using the on-board computer (► page 231).

### Unlocking the driver's door (mechanical key)

If the vehicle can no longer be unlocked centrally with the SmartKey or KEYLESS-GO:

► Take the mechanical key out of the SmartKey (► page 79).

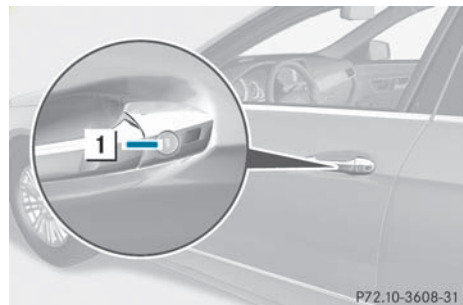

- ▶ Insert the mechanical key into the lock of the driver's door as far as it will go.
- ▶ Turn the mechanical key counter-clockwise to position **1**.  
The door is unlocked.
- ▶ Turn the mechanical key back and remove it.

### Locking the vehicle (mechanical key)

#### Emergency locking

If the vehicle can no longer be locked centrally with the SmartKey or KEYLESS-GO:

- ▶ Open the driver's door.
- ▶ Close the front-passenger door and the trunk lid/tailgate.
- ▶ Press the locking button (▷ page 84).
- ▶ Make sure that the locking knobs on the doors are still visible. Press down the locking knobs by hand, if necessary.
- ▶ Close the driver's door.
- ▶ Take the mechanical key out of the SmartKey (▷ page 79).

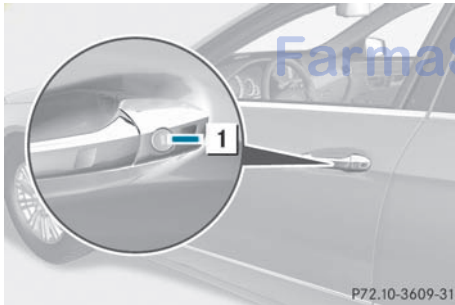

- ▶ Insert the mechanical key into the lock of the driver's door as far as it will go.
- ▶ Turn the mechanical key clockwise as far as it will go to position **1**.
- ▶ Turn the mechanical key back and remove it.
- ▶ Make sure that the doors and the trunk lid/tailgate are locked.

- i** If you lock the vehicle as described above, the fuel filler flap is not locked. The anti-theft alarm system is not activated.

### Trunk/cargo compartment

#### Important safety notes

Do not leave the SmartKey in the trunk/cargo compartment. You could otherwise lock yourself out.

#### **Warning**

When leaving the vehicle, always remove the SmartKey from the ignition lock. Always take the SmartKey with you and lock the vehicle. Do not leave children unsupervised in the vehicle, even if they are secured in a child restraint system, and do not give them access to an unlocked vehicle. A child's unsupervised access to a vehicle could result in an accident and/or serious personal injury. They could:

- injure themselves on vehicle parts
- be seriously or fatally injured by extreme heat or cold تلفن ۰۸۰۰۰۰۰۰۰۰
- injure themselves or have an accident with vehicle equipment that may still be in operation even after the SmartKey has been removed from the ignition, such as the seat adjustment, steering wheel adjustment or memory function.

If children open a door, they could cause severe or even fatal injury to other persons; if they get out of the vehicle, they could injure themselves when doing so or be seriously or even fatally injured by any passing traffic.

Do not expose the child restraint system to direct sunlight. The child restraint system's metal parts, for example, could become very hot, and a child could be burned on these parts.

#### **Warning**

Do not carry heavy or hard objects in the passenger compartment or trunk/cargo

compartment unless they are firmly secured in place.

Unsecured or improperly positioned cargo increases a child's risk of injury in the event of

- strong braking maneuvers
- sudden changes of direction
- an accident

### **Warning**

Ensure that the trunk/tailgate is closed when the engine is running and the vehicle is in motion. Among other dangers, deadly carbon monoxide (CO) may enter the vehicle interior and cause unconsciousness and even death.

- ❗ The trunk lid/tailgate swings upwards and to the rear when opened. Therefore, make sure that there is sufficient clearance above and behind the trunk lid/tailgate.

**Sedan:** For the trunk lid to be opened fully, there must be a minimum clearance from floor to ceiling of 5.78 ft (1.76 m).

**Wagon:** For the tailgate to be opened fully, there must be a minimum clearance from floor to ceiling of 6.36 ft (1.94 m).

The trunk lid/tailgate can be:

- opened and closed manually from outside
- opened and closed automatically from outside
- opened and closed automatically from inside

## Opening and closing manually

### Opening

You can only open the trunk lid/tailgate after unlocking it first.

You can only unlock the trunk lid when the vehicle is stationary.

- ▶ Press the  button on the SmartKey.

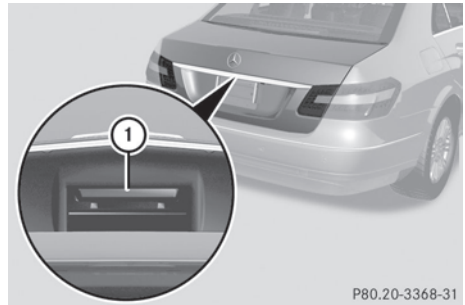

P80.20-3368-31

Handle (example: Sedan)

- ▶ Sedan: pull handle ①.
- ▶ Wagon: pull and hold handle ①. If you release the handle, the tailgate automatically opens fully.

### Closing

#### **Warning!**

To prevent possible personal injury, always keep hands and fingers away from the trunk/cargo compartment opening when closing the trunk lid/tailgate. Be especially careful when small children are around.



P72.20-3021-31

Recess (example: Sedan)

- ▶ Pull the trunk lid/tailgate down using recess ①.
- ▶ Lock the vehicle if necessary with the  button on the SmartKey or with KEYLESS-GO (▶ page 77).

### Opening the tailgate from inside the vehicle (Wagon with a folding bench seat)

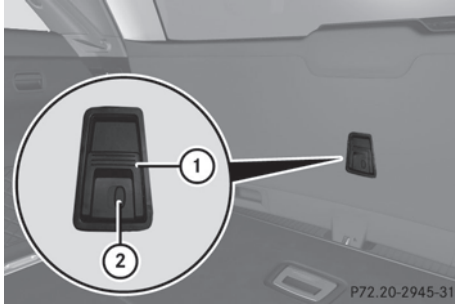

Inside of tailgate

- ▶ **To unlock the tailgate:** slide locking catch ② to the right.
- ▶ **To open:** pull the top of handle ①.
- ▶ Swing the tailgate upwards.
- ▶ **To lock the tailgate:** slide locking catch ② to the left.

### Automatic opening and closing from the outside

#### Important safety guidelines

##### **Warning**

Ensure that the trunk lid/tailgate is closed when the engine is running and the vehicle is in motion. Among other dangers, deadly carbon monoxide (CO) may enter the vehicle interior and cause unconsciousness and even death.

- ❗ The trunk lid/tailgate swings upwards and to the rear when opened. Therefore, make sure that there is sufficient clearance above and behind the trunk lid/tailgate.

**Sedan:** For the trunk lid to be opened fully, there must be a minimum clearance from floor to ceiling of 5.78 ft (1.76 m).

**Wagon:** For the tailgate to be opened fully, there must be a minimum clearance from floor to ceiling of 6.36 ft (1.94 m).

#### Opening

You can open the trunk lid/tailgate automatically with the SmartKey or the handle in the trunk lid/tailgate.

- ▶ Press and hold the  button on the SmartKey until the trunk lid/tailgate opens.

or

- ▶ When the trunk lid/tailgate is unlocked, pull the handle of the trunk lid/tailgate and let it go again immediately.

#### Closing

##### **Warning!**

Monitor the closing procedure carefully to make sure no one is in danger of being injured. To prevent possible personal injury, always keep hands and fingers away from the trunk opening when closing the trunk lid. Be especially careful when small children are around. To stop the closing procedure, do one of the following:

- Press button  on the SmartKey.
- Press the remote trunk opening/closing switch (on the driver's door).
- Press the trunk closing switch.
- Press the KEYLESS-GO locking/closing switch.
- Pull the trunk lid handle.

Even with the SmartKey removed from the starter switch or the SmartKey with KEYLESS-GO removed from the vehicle, the remote trunk opening/closing switch can be operated. Therefore, do not leave children unattended in the vehicle, or with access to an unlocked vehicle. A child's unsupervised access to a vehicle could result in an accident and/or serious personal injury.

**Sedan:** you can close the trunk lid automatically using the closing button<sup>5</sup> or the locking button<sup>6</sup>.

**Wagon:** you can close the tailgate automatically using either the closing button or the locking button<sup>7</sup>.

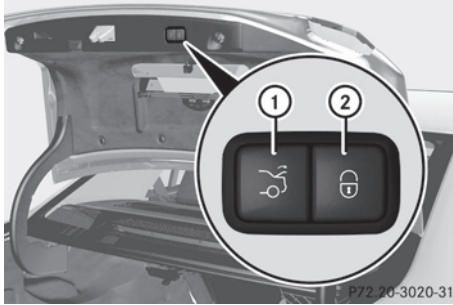

Closing button and locking button (example: Sedan)

► **To close:** press closing button ① in the trunk lid/tailgate.

► **To close and lock simultaneously:**

Press closing button ② in the trunk lid/tailgate.

**i** The trunk lid/tailgate can only be locked if there is a KEYLESS-GO key outside the vehicle.

### Automatic opening and closing from the inside

#### **Warning**

Keep an eye on the area at the rear end of the vehicle when operating the trunk lid/tailgate with the remote operating switch on the door. Monitor the entire closing procedure to ensure that there is no risk of injury to anyone near the vehicle.

Release the switch on the door to interrupt the closing procedure.

The remote operating switch can also be used if the SmartKey has been removed from the starter switch or the KEYLESS-GO key has been removed from the vehicle. Never leave children with no adult supervision in the vehicle or with access to an unlocked vehicle. If unsupervised children have access to a vehicle, it could lead to an accident and/or serious injury.

#### **Warning**

Ensure that the trunk lid/tailgate is closed when the engine is running and the vehicle is in motion. Among other dangers, deadly carbon monoxide (CO) may enter the vehicle interior and cause unconsciousness and even death.

You can open and close the trunk lid/tailgate from the driver's seat when the vehicle is stationary.



► **To open:** pull remote operating switch for trunk lid/tailgate ① until the trunk lid/tailgate opens.

► **To close (Sedan):** press remote operating switch for trunk lid ① until the trunk lid is closed.

► **To close (Wagon):** turn the SmartKey to position 1 or 2 in the ignition lock.

► Press remote operating switch for tailgate ① until the tailgate is closed.

<sup>5</sup> For vehicles with the trunk lid remote closing feature only.

<sup>6</sup> For vehicles with the trunk lid remote closing feature and KEYLESS-GO only.

<sup>7</sup> For vehicles with KEYLESS-GO only.



### Limiting the opening angle of the tailgate (Wagon)

#### Important safety guidelines

You can limit the opening angle of the tailgate. This is possible in the top half of its opening range, up to approximately 0.6 ft (20 cm) before the stop.

**!** Make sure there is sufficient clearance to open the tailgate fully when setting the opening angle. The tailgate could otherwise be damaged. Ideally, set the opening angle outside.

#### Activating the tailgate

- ▶ **To open the tailgate:** pull the handle on the tailgate.
- ▶ **To stop the opening procedure at the desired position:** press the close button (▷ page 88) on the tailgate or pull the handle on the outside of the tailgate again.
- ▶ **To store the position:** press and hold the closing button on the tailgate until you hear a short tone. The opening angle limiter is activated. The tailgate will now stop in the stored position when opening.

#### Deactivating the tailgate

- ▶ Press and hold the closing button (▷ page 88) in the tailgate until you hear two short tones.

#### Locking the trunk separately (Sedan)

You can lock the trunk separately. If you then unlock the vehicle centrally, the trunk remains locked and cannot be opened.

- ▶ Close the trunk lid.
- ▶ Take the mechanical key out of the SmartKey (▷ page 79).

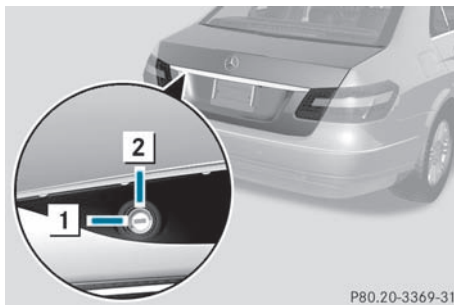

P80.20-3369-31

- ▶ Insert the mechanical key into the trunk lid lock as far as the stop.
- ▶ Turn the mechanical key clockwise from position **1** to position **2**.
- ▶ Remove the mechanical key.

#### Unlocking the trunk (Sedan)

**!** The trunk lid swings upwards when opened. Therefore, make sure that there is sufficient clearance above the trunk lid.

If the trunk can no longer be unlocked with the SmartKey or KEYLESS-GO:

- ▶ Take the mechanical key out of the SmartKey (▷ page 79).
- ▶ Insert the mechanical key into the trunk lid lock as far as the stop.

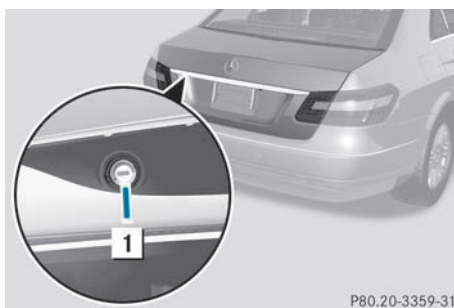

P80.20-3359-31

- ▶ Turn the mechanical key counter-clockwise as far as it will go to position **1**. The trunk is unlocked.
- ▶ Turn the mechanical key back and remove it.

### Trunk emergency release (Sedan)

You can open the trunk lid from inside the vehicle with the emergency release button.

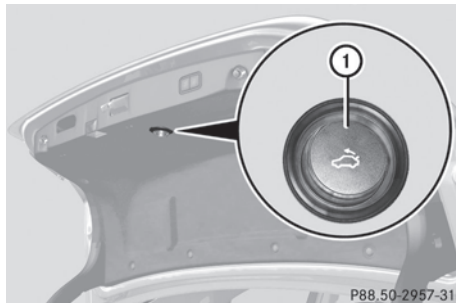

- ▶ Briefly press emergency release button ①.

The trunk lid unlocks and opens.

The trunk lid can be unlocked and opened with the trunk lid emergency release when the vehicle is stationary or while driving.

Trunk lid emergency release light:

- The button flashes for 30 minutes after the trunk lid is opened.
- The button flashes for 60 minutes after the trunk lid is closed.

The trunk lid emergency release does not open the trunk lid if the battery is disconnected or discharged.

### Tailgate emergency release (Wagon)

If the tailgate can no longer be opened from outside the vehicle, use the emergency release on the inside of the tailgate.

On vehicles with a folding bench seat, you can open the tailgate from inside the vehicle using the handle.

- ▶ Take the mechanical key out of the SmartKey (▷ page 79).

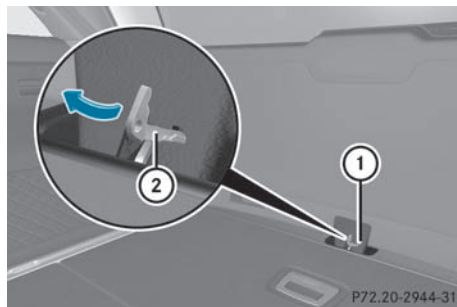

- ▶ **!** The tailgate swings upwards and to the rear when opened. Therefore, make sure that there is sufficient clearance above and behind the tailgate.

- ▶ Insert mechanical key ② into opening in trim ①.
- ▶ Turn mechanical key ② 90° clockwise.
- ▶ Push mechanical key ② in the direction of arrow and open the tailgate.

### Side windows

#### Important safety notes

#### **⚠ Warning!**

When leaving the vehicle, always remove the SmartKey from the starter switch. Always take the SmartKey with you and lock the vehicle. Do not leave children unattended in the vehicle, even if they are secured in a child restraint system, or with access to an unlocked vehicle. A child's unsupervised access to a vehicle could result in an accident and/or serious personal injury. The children could

- injure themselves on parts of the vehicle
- be seriously or fatally injured through excessive exposure to extreme heat or cold
- injure themselves or cause an accident with vehicle equipment that can be operated even if the SmartKey is removed from the starter switch or removed from the vehicle, such as seat adjustment, steering wheel adjustment, or the memory function

If children open a door, they could injure other persons or get out of the vehicle and injure themselves or be injured by following traffic.

Do not expose the child restraint system to direct sunlight. The child restraint system's metal parts, for example, could become very hot, and the child could be burned by these parts.

#### Warning

Do not transport heavy and hard objects in the vehicle interior or in the trunk/cargo compartment if they are unsecured.

Unsecured or improperly stowed cargo increases the risk of injury for a child in the event of:

- strong braking maneuvers
- sudden changes of direction
- an accident

#### Warning!

When opening or closing the door windows, make sure there is no danger of anyone being harmed by the opening/closing procedure.

The door windows are equipped with the automatic operation and anti-entrapment features. If during automatic operation a door window encounters an obstruction that blocks its path, the anti-entrapment feature will stop the door window and open it slightly.

The door windows operate differently when the switch is pulled and held. See the relevant section in this chapter for details.

The closing of the door windows can be immediately halted by releasing the switch or, if the switch was pulled past the resistance point and released, by either pressing or pulling the respective switch.

If a door window encounters an obstruction that blocks its path in a circumstance where you are closing the door windows by pressing and holding button  on the SmartKey or by touching and holding the sensor surface (vehicles with KEYLESS-GO) on an outside

door handle, the automatic reversal function will not operate.

Activate the override switch when children are riding in the back seats of the vehicle. The children may otherwise injure themselves, e.g. by becoming trapped in the door window opening.

#### Warning!

Do not keep any part of your body up against the window pane when opening a window. The downward motion of the pane may pull that part of your body down between the window pane and the door frame and trap it there. If there is a risk of entrapment, release the switch and pull it to close the window.

### Opening and closing the side windows



- ① Front left
- ② Front right
- ③ Rear left
- ④ Rear right

The switches for all side windows are located on the driver's door. There is also a switch on each door for the corresponding side window.

 It is not possible to operate the door windows from the rear compartment when the override feature is activated for the door windows.

- ▶ Turn the SmartKey to position **2** in the ignition lock.
- ▶ **To open:** press the corresponding switch.
- ▶ **To close:** pull the corresponding switch.

**i** If you press the switch beyond the point of resistance, an automatic opening/closing process is started in the corresponding direction. You can stop automatic operation by pressing again.



**i** You can continue to operate the side windows after you switch off the engine. This function remains active for five minutes or until one of the front doors is opened.

### Convenience opening



You can ventilate the vehicle before you start driving. To do this, you can use the key to simultaneously:

- open the side windows
- open the tilt/sliding sunroof or the panorama roof with power tilt/sliding panel and the roller sunblinds
- switch on the seat ventilation of the driver's seat

**i** The convenience opening feature can only be operated using the key. The key must be near the handle of the driver's door.

- ▶ Point the tip of the key at the driver's door handle.
- ▶ Unlock the vehicle by pressing the  button.
- ▶ Press and hold the  button until the side windows and the tilt/sliding sunroof or panorama roof with power tilt/sliding panel are in the desired position.

If the roller sunblinds of the panorama roof with power tilt/sliding panel are closed, the roller sunblinds are opened first.

- ▶ Press and hold the  button again until the panorama roof with power tilt/sliding panel is in the desired position.
- ▶ **To interrupt the convenience opening procedure:** release the  button.

### Convenience closing

#### General information

When you lock the vehicle, you can simultaneously:



- close the side windows
- close the tilt/sliding sunroof or the panorama roof with power tilt/sliding panel

On vehicles with a panorama roof with power tilt/sliding panel, you can then close the roller sunblinds.

#### Warning!

When closing the door windows and the tilt/sliding sunroof or panorama roof with power tilt/sliding panel, make sure there is no danger of anyone being harmed by the closing procedure.

If potential danger exists, proceed as follows:

- Release button  to stop the closing procedure. To open, press and hold button . To continue the closing procedure after making sure that there is no danger of anyone being harmed by the closing procedure, press and hold button .



Vehicles with KEYLESS-GO:

- Release the sensor surface on the outside door handle to stop the closing procedure.
- Immediately pull on the same outside door handle and hold firmly. The door windows and the tilt/sliding sunroof or panorama roof with power tilt/sliding panel will open for as long as the door handle is held but the door not opened.

### Using the SmartKey

- ❗ The key must be near the handle of the driver's door.
- ▶ Point the tip of the key at the driver's door handle.
- ▶ Press and hold the  button until the side windows and the tilt/sliding sunroof or the panorama roof with power tilt/sliding panel are fully closed.
- ▶ Make sure that all the side windows and the tilt/sliding sunroof or panorama roof with power tilt/sliding panel are closed.

On vehicles with a panorama roof with power tilt/sliding panel:

- ▶ Press and hold the  button again until the roller sunblinds of the panorama roof with power tilt/sliding panel close.
- ▶ **To interrupt the convenience closing procedure:** release the  button.

### Using KEYLESS-GO

The SmartKey with KEYLESS-GO must be outside the vehicle but no more than 3 ft (1 m) away from a door.

- ▶ Close all the doors.

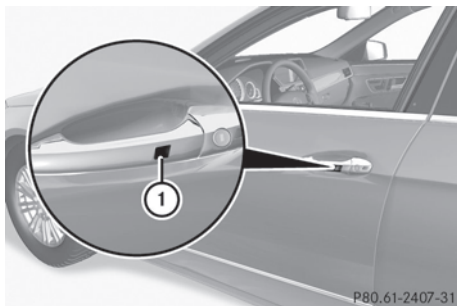

- ▶ Touch the sensor surface on door handle ① until the side windows and the

tilt/sliding sunroof or panorama roof with power tilt/sliding panel are fully closed.

- ❗ Make sure you only touch sensor surface ①.
- ▶ Make sure that all the side windows and the tilt/sliding sunroof or panorama roof with power tilt/sliding panel are closed.

On vehicles with a panorama roof with power tilt/sliding panel:

- ▶ Touch sensor surface ① on the door handle again until the roller sunblinds of the panorama roof with power tilt/sliding panel close.
- ▶ **To interrupt convenience closing:** release sensor surface ① on the door handle.

### Resetting the side windows

You must reset all the side windows if the side window cannot be closed fully.

- ▶ Close all the doors.
- ▶ Turn the key to position **2** in the ignition lock.
- ▶ Pull on the corresponding switch on the door control panel until the side window is completely closed (▷ page 92).
- ▶ Hold the switch for an additional second.

If the side window opens again slightly:

- ▶ Pull the corresponding switch again immediately and hold it for approximately one second.

### Problems with the side windows

**Problem: a side window cannot be closed because objects are trapped between the side window and the door frame.**

- ▶ Remove the objects.
- ▶ Close the side window.

**Problem: a side window cannot be closed because objects in the guide rail are preventing the window from being raised.**

- ▶ Remove the objects.
- ▶ Close the side window.

**Problem: a side window cannot be closed, and you cannot see the cause.**

 **Warning!**

Closing the side windows with increased force or without the anti-entrapment feature could lead to serious or even fatal injury. Make sure that nobody can become trapped when closing the side windows.

If a side window is obstructed during closing and reopens again slightly:

- ▶ Immediately after the window blocks, pull on the corresponding switch again until the side window has closed.  
The side window is closed with increased force.

If a side window is obstructed again during closing and reopens again slightly:

- ▶ Immediately after the window blocks, pull on the corresponding switch again until the side window has closed.  
The side window is closed without the anti-entrapment feature.

 **Warning!**

Pulling and holding the switch to close the door window immediately after it had been blocked two times will cause the door window to close without the anti-entrapment feature for as long as you hold the switch.

## Sliding sunroof

### Important safety notes

 **Warning!**

When leaving the vehicle, always remove the SmartKey from the starter switch. Always take the SmartKey with you and lock the vehicle. Do not leave children unattended in the vehicle, even if they are secured in a child restraint system, or with access to an unlocked vehicle. A child's unsupervised access to a vehicle could result in an accident and/or serious personal injury. The children could

- injure themselves on parts of the vehicle
- be seriously or fatally injured through excessive exposure to extreme heat or cold
- injure themselves or cause an accident with vehicle equipment that can be operated even if the SmartKey is removed from the starter switch or removed from the vehicle, such as seat adjustment, steering wheel adjustment, or the memory function

If children open a door, they could injure other persons or get out of the vehicle and injure themselves or be injured by following traffic.

Do not expose the child restraint system to direct sunlight. The child restraint system's metal parts, for example, could become very hot, and the child could be burned by these parts.

 **Warning**

Do not transport heavy and hard objects in the vehicle interior or in the trunk/cargo compartment if they are unsecured.

Unsecured or improperly stowed cargo increases the risk of injury for a child in the event of:

- strong braking maneuvers
- sudden changes of direction
- an accident

**⚠ Warning!**

When opening or closing the tilt/sliding sunroof, make sure there is no danger of anyone being harmed by the opening/closing procedure.

The tilt/sliding sunroof is equipped with the automatic operation and anti-entrapment features. If the movement of the tilt/sliding sunroof is blocked during the closing procedure, the tilt/sliding sunroof will stop and open slightly.

The tilt/sliding sunroof operates differently when the sunroof switch is pressed and held. See the section about problems with the sliding sunroof for details.

The opening/closing procedure of the tilt/sliding sunroof can be immediately halted by releasing the sunroof switch or, if the sunroof switch was moved past the resistance point and released, by moving the sunroof switch in any direction.

**⚠ Warning!**

The tilt/sliding sunroof is made out of glass. In the event of an accident, the glass may shatter. This may result in an opening in the roof.

In a vehicle rollover, occupants not wearing their seat belts or not wearing them properly may be thrown out of the opening. Such an opening also presents a potential for injury for occupants wearing their seat belts properly as entire body parts or portions of them may protrude from the passenger compartment.

**⚠ Warning!**

When opening or closing the tilt/sliding panel, make sure there is no danger of anyone being harmed by the opening/closing procedure.

The tilt/sliding panel is equipped with the automatic operation and anti-entrapment features. If the movement of the tilt/sliding panel is blocked during the closing procedure, the tilt/sliding panel will stop and open slightly.

The tilt/sliding panel operates differently when the roof panel switch is pressed and held. See the relevant section in this chapter for details.

The opening/closing procedure of the tilt/sliding panel can be immediately halted by releasing the roof panel switch or, if the roof panel switch was moved past the resistance point and released, by moving the roof panel switch in any direction.

**⚠ Warning!**

The panorama roof with tilt/sliding panel is made out of glass. In the event of an accident, the glass may shatter. This may result in an opening in the roof.

In a vehicle rollover, occupants not wearing their seat belts or not wearing them properly may be thrown out of the opening. Such an opening also presents a potential for injury for occupants wearing their seat belts properly as entire body parts or portions of them may protrude from the passenger compartment.

**!** Only open the sliding sunroof if it is free of snow and ice. Otherwise, malfunctions may occur.

Do not allow anything to protrude from the sliding sunroof. Otherwise, the seals could be damaged.

**!** If the sliding sunroof cannot be opened or closed due to a malfunction, contact a qualified specialist workshop, e.g. an authorized Mercedes-Benz Center.

**!** Do not forget that the weather can change abruptly. Make certain that the sliding sunroof is closed when you leave the vehicle. The vehicle electronics can be damaged if water enters the vehicle interior.

**i** Resonance noises can occur in addition to the usual airflow noises when the sliding sunroof is open. They are caused by minor pressure fluctuations in the vehicle interior. Change the position of the sliding sunroof



or open a side window slightly to reduce or eliminate these noises.

## Operating the tilt/sliding sunroof

### Opening and closing

- i** You can still operate the tilt/sliding sunroof even if you switch off the engine or remove the SmartKey. This function remains active for five minutes or until one of the front doors is opened.

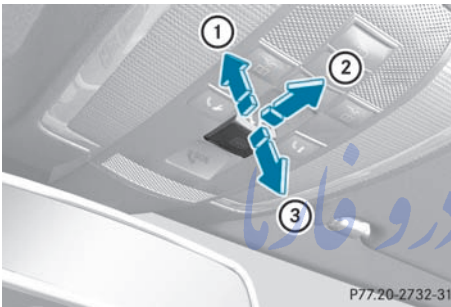

Overhead control panel

- ① To raise
- ② To open
- ③ To close

- ▶ Switch on the ignition.
- ▶ Push or pull the  switch in the corresponding direction.

- i** If you press the  switch beyond the point of resistance, an automatic opening/closing process is started in the corresponding direction. You can stop automatic operation by pressing again.

Automatic opening/raising is only available if the tilt/sliding sunroof is in the closed position.

You can open/close the cover for the sunblind manually when the tilt/sliding sunroof is raised/closed.

### Resetting

Reset the tilt/sliding sunroof if it does not open smoothly.

- !** Contact a qualified specialist workshop if the tilt/sliding sunroof cannot be closed fully or reset.
- ▶ Switch on the ignition.
- ▶ Raise the tilt/sliding sunroof fully at the rear (▷ page 97).
- ▶ Keep the  switch pressed for another second.
- ▶ Make sure that the tilt/sliding sunroof can be opened or closed fully again using the opening/closing process (▷ page 97).
- ▶ If the tilt/sliding sunroof can be raised fully at the rear it is set correctly. If this is not the case, you must repeat the previously described steps.

## Operating the panorama sliding sunroof

### Opening and closing

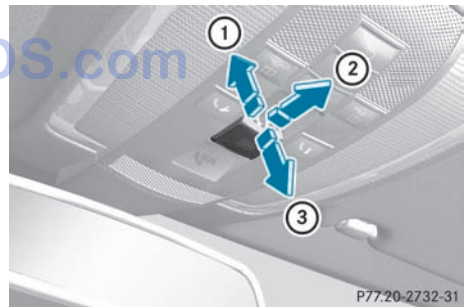



Overhead control panel

- ① To raise
- ② To open
- ③ To close

The panorama roof with power tilt/sliding panel can only be moved when the roller sunblinds are open.

تلفن: شیشه روزی: ۰۲۱-۸۸۶۲۰۸۵

FarmaSOS.com

- ▶ Turn the key to position **2** in the ignition lock.
- ▶ Push or pull the  switch in the corresponding direction.
- i** If you press the  switch beyond the point of resistance, an automatic opening/closing process is started in the corresponding direction. You can stop automatic operation by pressing again. Automatic raising is only available if the panorama roof with power tilt/sliding panel is in the closed position.

### Operating the roller sunblinds of the panorama sliding sunroof

#### General notes

The roller sunblinds provide protection from the sun. The two roller sunblinds can only be opened and closed together when the panorama roof with power tilt/sliding panel is closed.

#### Warning

When opening the roller sunblinds, make sure that nobody can be injured during the opening procedure.

The roller sunblinds are equipped with the express operation and anti-entrapment features. If the roller sunblinds block during the opening procedure, the anti-entrapment feature stops the roller sunblinds and opens them again slightly.

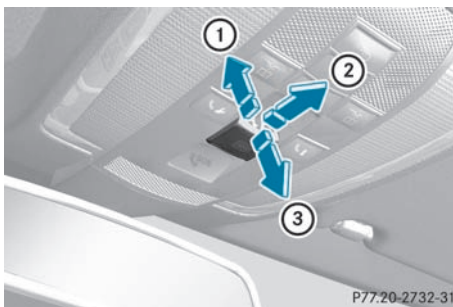

The opening procedure of the roller sunblinds can be stopped immediately by releasing the roof switch or by operating the roof switch in any direction if the roof switch has been pressed beyond the point of resistance and has been released.

### Opening and closing



Overhead control panel





- ① To open
- ② To open
- ③ To close

- ▶ Turn the key to position **2** in the ignition lock.
- ▶ Push or pull the  switch in the corresponding direction.
- i** If you press the  switch beyond the point of resistance, an automatic opening/closing process is started in the corresponding direction. You can stop automatic operation by pressing again.

### Resetting the panorama roof with power tilt/sliding panel and the roller sunblinds

Reset the panorama roof with power tilt/sliding panel and the roller sunblinds if the panorama roof with power tilt/sliding panel or the roller sunblind do not open smoothly.

- !** Do not open the panorama sliding sunroof until it has been reset properly. Otherwise, the panorama roof with power tilt/sliding panel may lock in the open position. If the panorama roof with power tilt/sliding panel cannot be closed or adjusted, contact a qualified specialist workshop, e.g. a Mercedes-Benz Service Center.

- ▶ Turn the key to position **2** in the ignition lock.
- ▶ Pull the  switch repeatedly to the point of resistance in the direction of arrow ③ until the panorama roof with power tilt/sliding panel is fully closed.
- ▶ Keep the  switch pulled for an additional second.
- ▶ Pull the  switch repeatedly to the point of resistance in the direction of arrow ③ until the roller sunblinds are fully closed.
- ▶ Keep the  switch pulled for an additional second.
- ▶ Make sure that the panorama roof with power tilt/sliding panel (> page 97) and the roller sunblinds (> page 98) can be fully opened again.

of resistance and hold it until the sliding sunroof is closed.

The sliding sunroof is closed without the anti-entrapment feature.

#### **Warning!**

Pressing and holding the sliding sunroof switch to close the sliding sunroof immediately after it had been blocked two times will cause the sliding sunroof to close without the anti-entrapment feature for as long as you hold the switch.

### Problems with the sliding sunroof

**Problem: the sunroof cannot be closed and you cannot see the cause.**

#### **Warning!**

You could be severely or even fatally injured when closing the sliding sunroof with increased closing force or if the anti-entrapment feature is deactivated. Make sure that nobody can become trapped when closing the sliding sunroof.

If the sliding sunroof is obstructed during closing:

- ▶ Immediately after the sliding sunroof blocks, pull the  switch in the overhead control panel down to the point of resistance and hold it until the sliding sunroof is closed.  
The sliding sunroof is closed with increased force.

If the sliding sunroof is obstructed during closing again:

- ▶ Immediately after the sliding sunroof blocks, pull the  switch in the overhead control panel down to the point

امداد خودرو فارما  
تلفن شبانه روزی: ۰۲۱-۸۸۸۶۲۰۸۵  
FarmaSOS.com

# امداد خودرو فارما

تلفن شبانه روزی: ۰۲۱-۸۸۸۶۲۰۸۵

**FarmaSOS.com**

Vehicle equipment .....	102
Correct driver's seat position .....	102
Seats .....	103
Steering wheel .....	111
Mirrors .....	113
Memory functions .....	115

# امداد خودرو فارما

تلفن شبانه روزی: ۰۲۱-۸۸۸۶۲۰۸۵

[FarmaSOS.com](http://FarmaSOS.com)

## Vehicle equipment

**i** This manual describes all the standard and optional equipment of your vehicle which was available at the time of purchase. Country-specific differences are possible. Bear in mind that your vehicle may not feature all functions described here. This also refers to safety-related systems and functions.

## Correct driver's seat position



Observe the important safety notes on (▷ page 103).

► Check whether you have adjusted seat ③ properly.

Electrical seat adjustment (▷ page 104)

When adjusting the seat, make sure:

- you are as far away from the driver's air bag as possible.
- you are sitting in a normal upright position.
- you can fasten the seat belt properly.
- you have moved the backrest to an almost vertical position.

- you have set the seat cushion angle so that your thighs are gently supported.
- you can depress the pedals properly.

► Check whether the head restraint is adjusted properly (▷ page 105).

When doing so, make sure that you have adjusted the head restraint so that the back of your head is supported at eye level by the center of the head restraint.

Observe the important safety notes on (▷ page 111).

► Check whether steering wheel ① is adjusted properly.

Adjusting the steering wheel electrically (▷ page 111)

When adjusting the steering wheel, make sure:

- you can hold the steering wheel with your arms slightly bent.
- you can move your legs freely.
- you can see all the displays in the instrument cluster clearly.

Observe the important safety notes on (▷ page 53).

► Check whether you have fastened seat belt ② properly (▷ page 55).

The seat belt should:

- fit snugly across your body
- be routed across the middle of your shoulder
- be routed in your pelvic area across the hip joints

► Before starting off, adjust the rear-view mirror and the exterior mirrors (▷ page 113) in such a way that you have a good view of road and traffic conditions.

► **Vehicles with memory function:** save the seat, steering wheel and exterior mirror settings (▷ page 115).

## Seats

### Important safety notes

#### Warning

In order to avoid possible loss of vehicle control, all seat, head restraint, steering wheel and rear view mirror adjustments, as well as fastening of seat belts, must be done before setting the vehicle in motion.

#### Warning

Do not adjust the driver's seat while driving. Adjusting the seat while driving could cause the driver to lose control of the vehicle.

Never travel in a moving vehicle with the seat backrest in an excessively reclined position as this can be dangerous. You could slide under the seat belt in a collision. If you slide under it, the seat belt would apply force at the abdomen or neck. This could cause serious or fatal injuries. The seat backrest and seat belts provide the best restraint when the wearer is in a position that is as upright as possible and seat belts are properly positioned on the body.

#### Warning

Your seat belt must be adjusted so that you can correctly fasten your seat belt.

Observe the following points:

- adjust the seat backrest until your arms are slightly angled when holding the steering wheel.
- adjust the seat to a comfortable seating position that still allows you to reach the accelerator/brake pedal safely. The position should be as far back as possible with the driver still able to operate the controls properly.
- adjust the head restraint so that it is as close to the head as possible and the center

of the head restraint supports the back of the head at eye level.

- never place hands under the seat or near any moving parts while a seat is being adjusted.

Failure to do so could result in an accident and/or serious personal injury.

#### Warning

The electrically adjustable seats can be operated at any time. Therefore, do not leave children unattended in the vehicle, or with access to an unlocked vehicle. A child's unsupervised access to a vehicle could result in an accident and/or serious personal injury.

#### Warning!

According to accident statistics, children are safer when properly restrained in the rear seating positions than in the front seating position. Thus, we strongly recommend that children be placed in the rear seats whenever possible. Regardless of seating position, children 12 years old and under must be seated and properly secured in an appropriately sized infant restraint, toddler restraint, or booster seat recommended for the size and weight of the child. For additional information, see "Children in the vehicle".

A child's risk of serious or fatal injuries is significantly increased if the child restraints are not properly secured in the vehicle and/or the child is not properly secured in the child restraint.

#### Warning

For your protection, drive only with properly positioned head restraints.

Adjust the head restraint so that it is as close to the head as possible and the center of the head restraint supports the back of the head at eye level. This will reduce the potential for injury to the head and neck in the event of an accident or similar situation.



Do not drive the vehicle without the seat head restraints. Head restraints are intended to help reduce injuries during an accident.

**!** To avoid damage to the seats and the seat heating, observe the following information:

- do not spill any liquids on the seats. If liquid is spilled on the seats, dry them as soon as possible.
- if the seat covers are damp or wet, do not switch on the seat heating. The seat heating should also not be used to dry the seats.
- clean the seat covers as recommended; see the "Interior care" section.
- do not transport heavy loads on the seats. Do not place sharp objects on the seat cushions, e.g. knives, nails or tools. The seats should only be occupied by passengers, if possible.
- when the seat heating is in operation, do not cover the seats with insulating materials, e.g. covers, bags, seat covers, child seats or booster seats.

**!** When you move the seats, make sure that there are no objects in the footwell or behind the seats. Otherwise, you could damage the seats and the objects.

**i** The head restraints in the front seats are installed with the NECK-PRO system (▷ page 52). For this reason, it is not possible to remove the head restraints from the front seats.

Vehicles without the through-loading feature: the head restraints cannot be removed from the rear compartment seats. Please contact an authorized Mercedes-Benz Center for more information.

**i** Related topics:

- Through-loading feature in the rear bench seat (Sedan) (▷ page 278)
- EASY-PACK through-loading feature in the rear bench seat (Wagon) (▷ page 279)

## Adjusting the seats

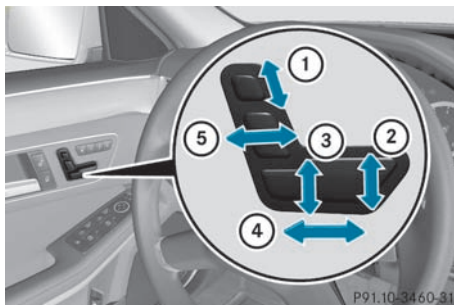

① Head restraint height

② Seat cushion angle

③ Seat height

④ Seat fore-and-aft adjustment

⑤ Backrest angle

**i** If PRE-SAFE® is triggered, the front-passenger seat will be moved to a better position if it was previously in an unfavorable position.

**i** You can store the seat settings using the memory function (▷ page 115).

**i** Vehicles with the through-loading feature: if you fold down a rear seat backrest, the respective front seat is moved forwards slightly, if necessary, to prevent contact with the backrest.

## Adjusting the head restraints

### Adjusting the angle of the head restraints

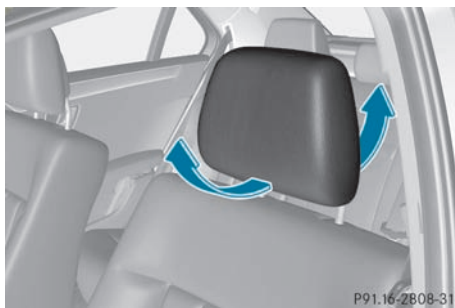

Example: Sedan

- Push or pull the lower edge of the head restraint in the direction of the arrow.

### Adjusting the height of the head restraints electrically

- **To adjust the height of the head restraints:** slide the button for head restraint adjustment (► page 104) up or down in the direction of the arrow.

### Adjusting the luxury head restraints

#### ⚠ Warning!

When folding back the head restraint side bolsters, do not put your hands between the side bolster and the cushion holder. There is a danger of becoming trapped.

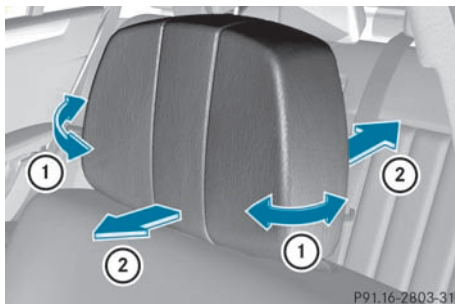

- **To adjust the side bolsters of the head restraint:** push or pull right and/or left-

hand side bolster ① into the desired position.

- **To adjust the angle of the head restraint:** push or pull the head restraint in the direction of arrow ②.

### Rear seat head restraints

#### ⚠ Warning!

For your protection, drive only with properly positioned head restraints.

Adjust the head restraint in such a way that it is as close to the head as possible and the center of the head restraint supports the back of the head at eye level. This will reduce the potential for injury to the head and neck in the event of an accident or similar situation.

With a rear seat occupied, make sure to move the respective head restraint up from the lowest non-use position and have the occupant adjust the head restraint properly.

Do not drive the vehicle without the seat head restraints installed when the rear seats are occupied. Head restraints are intended to help reduce injuries during an accident.

#### ⚠ Warning!

Make sure the rear seat head restraints engage when placing them upright manually. Otherwise their protective function cannot be ensured.

The back of the head will not be supported in the event of a collision. That could cause serious or even fatal injuries. Rear seat occupants can be seriously injured or killed.

### Lowering the rear seat head restraints from the front



- ▶ Make sure that the key is in position 2 in the ignition lock.
- ▶ Press button ①.

### Adjusting the height of the rear seat head restraints

On Sedans with the through-loading feature, you can only adjust the height of the two outer head restraints.

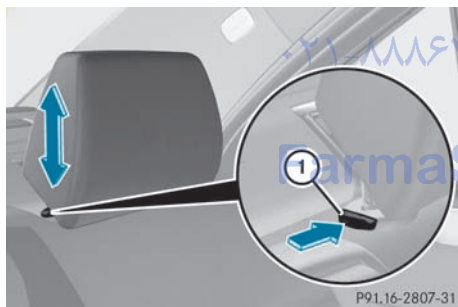

Example: Sedan

If the head restraint has been lowered completely, press release catch ①.

- ▶ **To raise:** pull the head restraint up to the desired height.
- ▶ **To lower:** press release catch ① and push the head restraint down to the desired position.

**i** If you pull the head restraint forward slightly, the effort required to adjust it is reduced.

<sup>8</sup> Only for vehicles with the through-loading feature.

### Adjusting the angle of the rear seat head restraints

Adjust the head restraint so that it is as close as possible to your head.

You can only adjust the two outer head restraints.

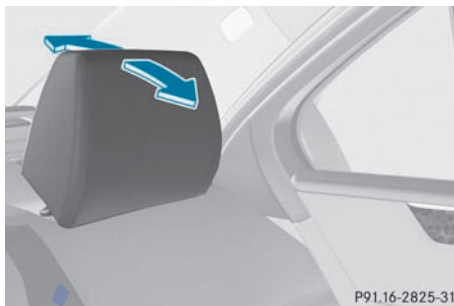

Example: Sedan

- ▶ Pull or push the top of the head restraint until it is in the desired position.

### Removing and installing the rear seat head restraints<sup>8</sup>

#### **Warning!** تلفن شیشه زوری

Occupants should only travel sitting on seats which have the head restraints installed. In the event of an accident, this reduces the risk of injury for passengers seated in the rear compartment.

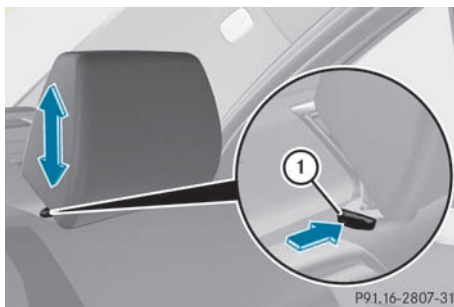

Example: Sedan

- ▶ Release the rear seat backrest and fold it slightly forwards (▷ page 278).
- ▶ **To remove:** pull the head restraint up to the stop.
- ▶ Press release catch ① and pull the head restraint out of the guides.
- ▶ **To refit:** insert the head restraint so that the notches on the bar are on the left when viewed in the direction of travel.
- ▶ Push the head restraint down until you hear it engage in position.
- ▶ Fold back the rear seat backrest until it engages.

### Adjusting the active multicontour seat

The active multicontour seat on the driver's side automatically adapts the sides of the backrest to your current driving style. You can adjust the contour of the seat individually so as to provide optimum support for your back and sides.

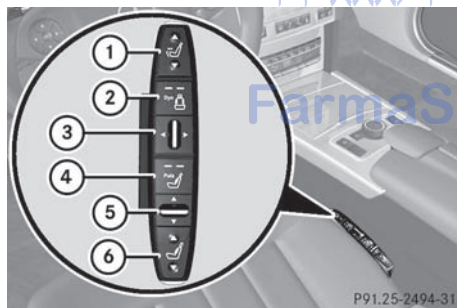

- ① To adjust the seat cushion length
- ② To switch the dynamic function on or off
- ③ To adjust the side bolsters of the seat backrest
- ④ To switch the massage function on or off
- ⑤ To adjust the contour of the backrest to increase/decrease support
- ⑥ To adjust the height/depth of the backrest contour

### Dynamic function

The dynamic function adapts the air cushions in the side bolsters of the seat backrest so that ideal lateral support is ensured at all times.

You can choose between two different levels.

Level 1 (one indicator lamp)	Standard setting: slightly increased lateral support and slow build up of air pressure in the side bolsters of the seat backrest.
Level 2 (two indicator lamps)	Sport setting: increased lateral support and fast build up of pressure in the side bolsters of the seat backrest.

- ▶ **To switch on:** press button ② once or twice until the desired level is set. One or two indicator lamps in button ② light up.
- ▶ **To switch off:** press button ② repeatedly until all indicator lamps in button ② go out.

### Massage function (PULSE)

The massage function helps you to prevent muscle tension on long journeys. You can choose between two levels.

- ▶ **To switch on:** press button ④ once or twice until the desired level is set. One or two indicator lamps in button ④ light up. The air cushions in the lumbar region vibrate for approximately 20 minutes.

### Adjusting the four-way lumbar support

You can adjust the contour of the front seat backrests individually to provide optimum support for your back.

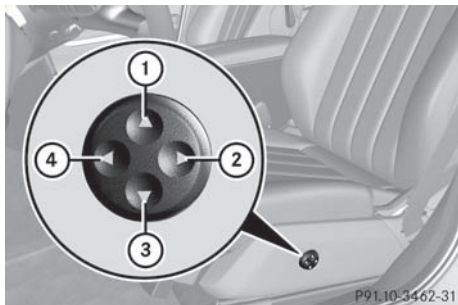

- ① To raise the backrest contour
- ② To soften the backrest contour
- ③ To lower the backrest contour
- ④ To harden the backrest contour

### Folding bench seat in the cargo compartment (Wagon)

The folding bench seat in the luggage compartment is only suitable for persons no more than 4.6 ft (1.40 m) tall and weighing a maximum of 110 lb (50 kg).

Maximum permissible passenger weight may be reduced by extensive optional extras and vehicle load. Observe the maximum gross vehicle weight and the gross axle weight rating, which can be found on the vehicle identification plate (▷ page 385).

The combined cargo cover and net must be installed if you are using the folding bench seat (▷ page 282).

#### **⚠ Risk of injury**

The rear seat backrests must be locked in the upright position if you are using the folding bench seat in the cargo compartment.

Do not pull away unless the head restraint in the folding bench seat is installed correctly. Make sure that the center of the head

restraint supports the seat occupant's head at about eye level. This can reduce the risk of injury to a child in the event of an accident.

Ensure that the seat belt is routed correctly across the body and the seat belt buckle is engaged.

Never leave children unsupervised in the vehicle. This applies even if they are secured in a child restraint system.

Secure children as recommended; see the "Children in the vehicle" section.

#### **⚠ Risk of injury**

Only replace damaged covers with genuine covers.

Make sure that items of luggage and other objects in the cargo compartment are well secured.

Otherwise, the load could cause injury in the event of sharp braking, a sudden change in direction or an accident.

### Folding out the folding bench seat

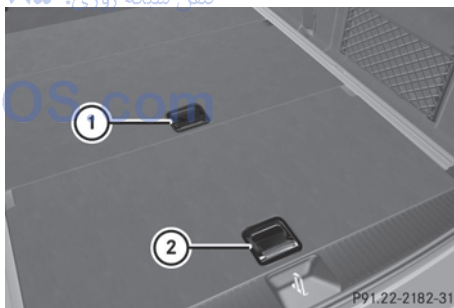

- ▶ Make sure that the backrests of the rear bench seat are locked in the upright position.
- ▶ Move the handle for the combined cargo cover and net upwards (▷ page 282).
- ▶ Pull release handle ① and fold the backrest of the folding bench seat upwards.

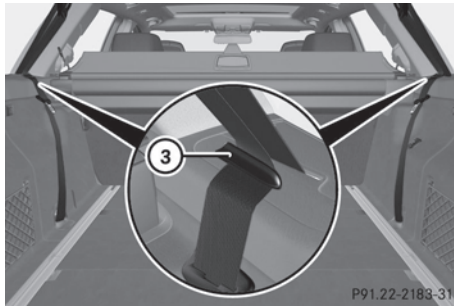

- ▶ Hook the seat belts into retainers (3).
- ▶ Pull release handle (2) and fold the folding bench seat cushion into the sitting position.
- ▶ Push down the seat cushion until the backrest engages fully.
- ▶ Fold the head restraints upwards.

### installing and removing the seat cushion

You must remove the seat cushion if you wish to lift the trunk floor, e.g. if the vehicle has a flat tire.

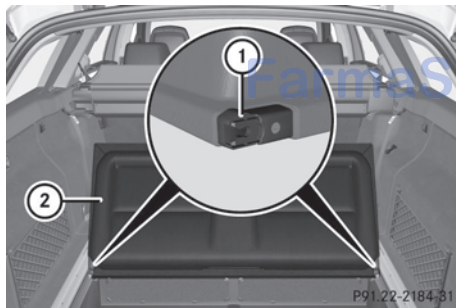

- ▶ **To remove:** fold seat cushion (2) upwards and remove it from seat cushion guides (1).

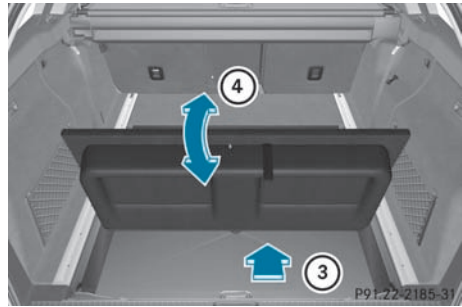

- ▶ **To install:** guide seat cushion (2) into seat cushion guides (1) at a slight angle from the rear (3).
- ▶ Fold seat cushion (2) back into its original position (4) until it engages.

### Folding back the folding bench seat

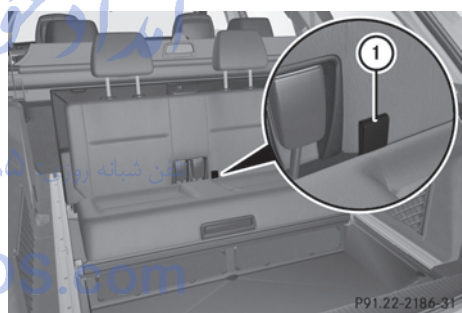

- ▶ Pull the seat cushion upwards by tab (1) and fold it back into its original position until it engages.

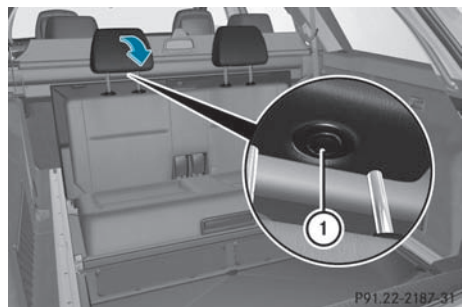

- ▶ Press release button (1) and fold the head restraints down.



**!** In order to avoid causing damage, push the head restraints completely into their guides and click the seat belt buckles into their guides.

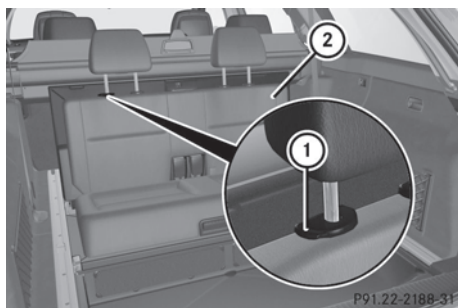

- ▶ Press release catch ① and push the head restraints in fully.
- ▶ Fold backrest ② of the folding bench seat into its original position until it engages.

### Switching the seat heating on/off

#### Switching on/off

##### **⚠ Warning!**

Repeatedly setting the seat heating to level **3** may result in excessive seat temperatures. The health of passengers that have limited temperature sensitivity or a limited ability to react to excessively high temperatures may be affected or they may even suffer burn-like injuries. Therefore, do not use seat heating level **3** repeatedly.

The three red indicator lamps in the button indicate the heating level you have selected.

- i** If the battery voltage is too low, the seat heating may switch off.



Driver's and front-passenger seat

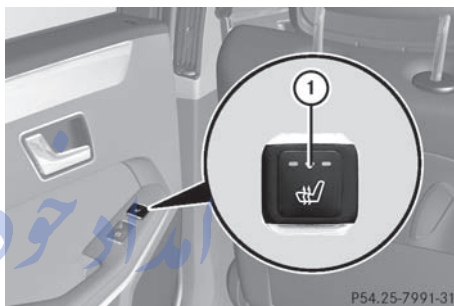

Rear compartment seats<sup>9</sup>

The system automatically switches down from level **3** to level **2** after about eight minutes (driver's seat and front-passenger seat) or five minutes (rear seats).

The system automatically switches down from level **2** to level **1** after approximately ten minutes.

The system automatically switches off approximately 20 minutes after it is set to level **1**.

- ▶ Make sure that the key is in position **2** in the ignition lock.
- ▶ **To switch on:** press button ① repeatedly until the desired heating level is set.
- ▶ **To switch off:** press button ① repeatedly until all the indicator lamps go out.

<sup>9</sup> Only for Canada.



## Problems with the seat heating

The seat heating has switched itself off prematurely or cannot be switched on. The vehicle's electrical system voltage is too low because too many electrical consumers are switched on.

- ▶ Switch off electrical consumers which you do not need, such as the rear window defroster or interior lighting.

## Switching the seat ventilation on/off

### Switching on/off

The three blue indicator lamps in the buttons indicate the ventilation level you have selected.

- ⓘ If the battery voltage is too low, the seat ventilation may switch off.



- ▶ Make sure that the key is in position 2 in the ignition lock.
- ▶ **To switch on:** press button ① repeatedly until the desired ventilation level is set.
- ⓘ You can open the side windows and the tilt/sliding sunroof with the key (▷ page 93). The seat ventilation of the driver's seat automatically switches to the highest level.
- ▶ **To switch off:** press button ① repeatedly until all the indicator lamps go out.

## Problems with the seat ventilation

The seat ventilation has switched itself off prematurely or cannot be switched on. The vehicle's electrical system voltage is too low because too many electrical consumers are switched on.

- ▶ Switch off electrical consumers which you do not need, such as the rear window defroster or interior lighting.

## Steering wheel

### Important safety notes

#### ⚠ Warning!

Do not adjust the steering wheel while driving. Adjusting the steering wheel while driving could cause the driver to lose control of the vehicle.

The electrical steering wheel adjustment feature can be operated at any time. Therefore, do not leave children unattended in the vehicle, or with access to an unlocked vehicle. A child's unsupervised access to a vehicle could result in an accident and/or serious personal injury.

### Adjusting the steering wheel

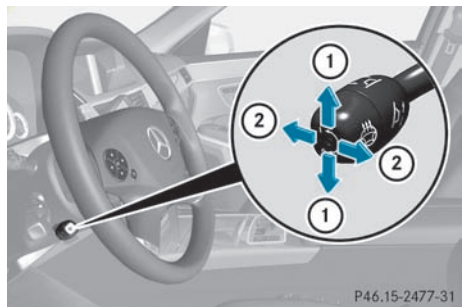

- ① To adjust the steering wheel height
- ② To adjust the steering wheel position (fore-and-aft adjustment)

**i** Related topics:

- EASY-ENTRY/EXIT feature (▷ page 112)
- storing settings (▷ page 115)

## Steering wheel heating

### Switching on/off

The steering-wheel heating heats the leather areas of the steering wheel.

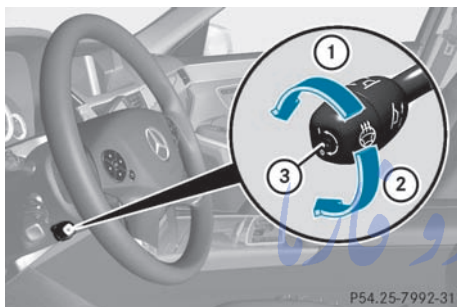

- ▶ Make sure that the key is in position **2** in the ignition lock.
- ▶ **To switch on/off:** turn the lever in the direction of arrow **1** or **2**. Indicator lamp **3** comes on or goes out.

**i** The steering wheel heating may switch off temporarily if:

- the temperature inside the vehicle exceeds 86 °F (30 °C).
- the temperature of the steering wheel exceeds 95 °F (35 °C)

Indicator lamp **3** remains on.

Vehicles without KEYLESS GO: If you switch off the ignition, the steering wheel heating is automatically switched off.

Vehicles with KEYLESS GO: If you remove the key from the ignition lock and open the driver's door, the steering wheel heating is automatically switched off.

## Problems with the steering wheel heating

If the steering wheel heating indicator lamp on the lower left lever of the steering column is flashing, the steering wheel heating has switched off automatically. The vehicle's electrical system voltage is too low because too many electrical consumers are switched on.

- ▶ Switch off electrical consumers which you do not need, such as the rear window defroster or interior lighting. Once the battery is sufficiently charged, the steering wheel heating will switch back on automatically.

## EASY-ENTRY/EXIT

### **Warning!**

You must make sure no one can become trapped or injured by the moving steering wheel when the easy-entry/exit feature is activated.

To stop steering wheel movement, move steering wheel adjustment stalk or press the memory position switch.

Do not leave children unattended in the vehicle, or with access to an unlocked vehicle. Children could open the driver's door and unintentionally activate the easy-entry/exit feature, which could result in an accident and/or serious personal injury.

The EASY-ENTRY/EXIT feature makes getting in and out of your vehicle easier.

The steering wheel swings upwards when you:

- remove the key from the ignition lock.
- open the driver's door and KEYLESS-GO is in position **1**
- open the driver's door and the key is in position **0** or **1** in the ignition lock.

- i** The steering wheel only moves upwards if it has not already reached the upper end stop.

The steering wheel is moved to the last selected position when:

- the driver's door is closed, and
- you insert the key into the ignition lock.
- or
- in vehicles with KEYLESS-GO, you press the Start/Stop button once.

When you close the driver's door with the ignition switched on, the steering wheel is also automatically moved to the previously set position.

The last position of the steering wheel is stored after each manual setting or when you store the setting with the memory function (▷ page 115).

You can activate and deactivate the EASY-ENTRY/EXIT feature in the on-board computer (▷ page 232).

#### **Warning**

Let the system complete the adjustment procedure before setting the vehicle in motion. All steering wheel adjustment must be completed before setting the vehicle in motion. Driving off with the steering wheel still adjusting could cause the driver to lose control of the vehicle.

- i** If the crash-responsive EASY-EXIT feature is triggered in an accident, the steering column will move upwards when the driver's door is opened. This occurs irrespective of the position of the key in the ignition lock. This makes it easier to exit the vehicle and rescue the occupants. The crash-responsive EASY-EXIT feature is only operational after an accident if the EASY-EXIT/ENTRY feature is activated in the on-board computer.

## Mirrors

### Rear-view mirror

#### Rear-view mirror (manual anti-glare)

- ▶ **Anti-glare mode:** flick anti-glare switch **1** forwards or back.

### Exterior mirrors

#### Adjusting the exterior mirrors

##### **Warning**

Exercise care when using the passenger-side exterior rear view mirror. The mirror surface is convex (outwardly curved surface for a wider field of view). Objects in mirror are closer than they appear. Check your interior rear view mirror and glance over your shoulder before changing lanes.

The exterior mirrors are automatically heated if the rear window heating is switched on and the outside temperature is low.

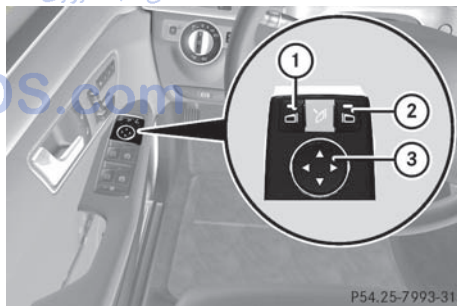

P54.25-7993-31

- ▶ Make sure that the SmartKey is in position **1** or **2** in the ignition lock.
- ▶ Press button **1** for the left-hand exterior mirror or button **2** for the right-hand exterior mirror. The indicator lamp in the corresponding button lights up in red. The indicator lamp goes out again after some time. You can adjust the selected

mirror using adjustment button ③ as long as the indicator lamp is lit.

- ▶ Press adjustment button ③ up, down, to the right or to the left until the exterior mirror is set to a position which provides you with a good overview of traffic conditions.

### Exterior mirror out of position

If an exterior mirror has been pushed out of position, proceed as follows:

- ▶ Move the exterior mirror into the correct position manually.

### Automatic anti-glare mirrors

#### Warning!

The auto dimming function does not react if incoming light is not aimed directly at sensors in the interior rear view mirror.

The interior rear view mirror and the exterior rear view mirror on the driver's side do not react, for example, if the rear window sunshade is in raised position.

Light hitting the mirror(s) at certain angles (incident light) could blind you. As a result, you may not be able to observe traffic conditions and could cause an accident.

The rear-view mirror and the exterior mirror on the driver's side automatically go into anti-glare mode if the ignition is switched on and incident light from headlamps strikes the sensor in the rear-view mirror.

The mirrors do not go into anti-glare mode if reverse gear is engaged or the interior lighting is switched on.

### Parking position for the exterior mirror on the front-passenger side

#### Setting and storing the parking position

You can position the front-passenger side exterior mirror in such a way that you can see the rear wheel on that side as soon as you engage reverse gear. You can store this position.

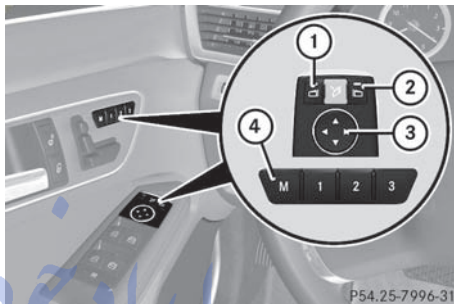

- ▶ Make sure that the vehicle is stationary and that the key is in position **2** in the ignition lock.

- ▶ Press button ② for the exterior mirror on the front-passenger side.

- ▶ Engage reverse gear.

The exterior mirror on the front-passenger side moves to the preset parking position.

- ▶ Use adjustment button ③ to adjust the exterior mirror to a position which allows you to see the rear wheel and the curb. The parking position is stored.

**i** If you shift the transmission to another position, the exterior mirror on the front-passenger side returns to the driving position.

**i** You can also store the parking position using memory button **M** ④.

- ▶ With the key in position **2** in the ignition lock and with the exterior mirror on the front-passenger side activated, use adjustment button ③ to

set the exterior mirror such that the rear wheel and curb are visible.

- ▶ Press memory button **M** ④ and one of the arrows on adjustment button ③ within three seconds.

The parking position is stored if the exterior mirror does not move.

If the mirror moves out of position, repeat the steps.

### Calling up a stored parking position setting

- ▶ With the key in position **2** in the ignition lock and the exterior mirror on the front-passenger side activated, engage reverse gear.

The exterior mirror on the front-passenger side moves to the stored parking position.

The exterior mirror on the front-passenger side moves back to its original position:

- as soon as you exceed a speed of 6 mph (10 km/h)
- about ten seconds after you have disengaged reverse gear
- if you press button ① for the exterior mirror on the driver's side

## Memory functions

### Storing settings

With the memory function, you can store up to three different settings, e.g. for three different people.

The following settings are stored as a single memory preset:

- position of the seat, backrest and head restraint
- active multicontour seat: dynamic function level
- driver's side: steering wheel position
- driver's side: position of the exterior mirrors on the driver's and front-passenger sides

### ⚠ Warning!

The memory function can still be used when the key has been removed. For this reason, children should never be left unsupervised in the vehicle. They could otherwise become trapped when adjusting the seat or the steering wheel.

### ⚠ Warning!

Only use the memory function on the driver's side when the vehicle is stationary. You could otherwise be distracted from the traffic conditions by the steering wheel and seat moving of their own accord, and as a result cause an accident.



- ▶ Adjust the seat (▷ page 104).
- ▶ On the driver's side, adjust the steering wheel (▷ page 111) and the exterior mirrors (▷ page 113).
- ▶ Press memory button **M** and one of the storage position buttons **1**, **2** or **3** within three seconds.  
The settings are stored in the selected preset position. A tone sounds when the settings have been completed.

### Calling up a stored setting

- ▶ Press and hold the relevant storage position button **1**, **2** or **3**, until the seat, steering wheel and exterior mirrors are in the stored position.

- i** The setting procedure is interrupted as soon as you release the storage position button.

امداد خودرو فارما

تلفن شبانه روزی: ۰۲۱-۸۸۸۶۲۰۸۵

[FarmaSOS.com](http://FarmaSOS.com)

Vehicle equipment .....	118
Exterior lighting .....	118
Interior lighting .....	123
Changing bulbs .....	124
Windshield wipers .....	127

# امداد خودرو فارما

تلفن شبانه روزی: ۰۲۱-۸۸۸۶۲۰۸۵

[FarmaSOS.com](http://FarmaSOS.com)



## Vehicle equipment

**i** This manual describes all the standard and optional equipment of your vehicle which was available at the time of purchase. Country-specific differences are possible. Bear in mind that your vehicle may not feature all functions described here. This also refers to safety-related systems and functions.

## Exterior lighting

### Important safety notes

For reasons of safety, Mercedes-Benz recommends that you drive with the lights switched on even during the daytime. In some countries, operation of the headlamps varies due to legal requirements and self-imposed obligations. In these countries, the daytime running lamps are automatically switched on when the engine is started.

### Notes on driving abroad

**Converting to symmetrical low beam when driving abroad:** switch the headlamps to symmetrical low beam in countries in which traffic drives on the opposite side of the road to the country where the vehicle is registered. This prevents oncoming traffic from being dazzled. Symmetrical lights do not illuminate as large an area of the edge of the road.

Have the headlamps converted at a qualified specialist workshop, e.g. an authorized Mercedes-Benz Center, as close to the border as possible before driving in these countries.

**Converting to asymmetrical low beam after returning:** have the headlamps converted back to asymmetrical low beam at a qualified specialist workshop, e.g. an authorized Mercedes-Benz Center, as soon as possible after crossing the border when returning.

## Light switch

### Operation

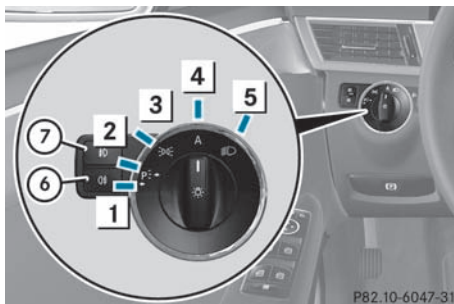

- 1 Left-hand standing lamps
- 2 Right-hand standing lamps
- 3 Parking lamps, license plate and instrument lighting
- 4 Automatic headlamp mode/daytime running lamps
- 5 Low-beam/high-beam headlamps
- 7 Front fog lamps
- 6 Rear fog lamp

The turn signals, high-beam headlamps and the high beam flasher are operated using the combination switch (> page 120).

**!** Switch off the parking lamps and standing lamps when you leave the vehicle. This prevents the battery from discharging.



The exterior lighting (except the parking lamps/standing lamps) switches off automatically if you:

- remove the key from the ignition lock
- open the driver's door with the key in position **0**

If you hear a warning tone when you leave the vehicle, the lights may still be switched on.

► Turn the light switch to **A**.



## Low-beam headlamps

- ▶ **To switch on the low-beam headlamps:** turn the key in the ignition lock to position **2** or start the engine.
- ▶ Turn the light switch to . The  indicator lamp in the instrument cluster lights up.

## Daytime running lamps

### Daytime running lamps in Canada

In Canada, the "daytime running lamps" function is required by law. It can therefore not be deactivated.

- ▶ Turn the light switch to . With the engine running: depending on the ambient light, either the daytime running lamps or the low-beam headlamps are switched on. If the low-beam headlamps are switched on, the  indicator lamp in the instrument cluster lights up.

With the engine running while the vehicle is stationary: the daytime running lamps/low-beam headlamps switch off after 3 minutes if you shift the selector lever to **P** from a driving position.

With the engine running, the vehicle stationary and bright ambient light: if you set the light switch to , the daytime running lamps and the parking lamps switch on.



If you set the light switch to  while the engine is running, the manual setting overrides the daytime running lamps.



### Daytime running lamps in the USA

The daytime running lamps are deactivated ex works on vehicles for the USA.

- ▶ **To switch on the daytime running lamps:** switch on the "daytime running



lamps" function via the on-board computer (▷ page 230).

- ▶ Turn the light switch to . With the engine running: depending on the ambient light, either the daytime running lamps or the low-beam headlamps are switched on. If the low-beam headlamps are switched on, the  indicator lamp in the instrument cluster lights up.

If you set the light switch to  or  while the engine is running, the manual setting overrides the daytime running lamps.

## Automatic headlamps

### Risk of accident

If the light switch is set to , the low-beam headlamps will not come on automatically if it is foggy. This could endanger you and others. Therefore, turn the light switch to  in fog.

The automatic headlamp feature is only an aid. The driver is responsible for the vehicle's lighting at all times.

- ▶ **To switch on automatic headlamp mode:** turn the light switch to . SmartKey in position **1** in the ignition lock: the parking lamps are switched on or off automatically depending on the brightness of the ambient light.

With the engine running: depending on the brightness of the ambient light, the daytime running lamps<sup>10</sup> or the low-beam headlamps are switched on or off automatically.

When the low-beam headlamps are switched on, the  indicator lamp in the instrument cluster lights up.

<sup>10</sup> Only if daytime running lamps have been activated via the on-board computer.

## Fog lamps and rear fog lamps

### Front fog lamps

Only vehicles with front fog lamps have the "fog lamps" function.

#### **Warning!**

If you suspect that driving conditions will be foggy, turn the light switch to  before you start your journey. Otherwise, your vehicle may not be visible and you could endanger yourself and others.

▶ **To switch on the front fog lamps:** turn the key in the ignition lock to position **2** or start the engine.

▶ Turn the light switch to  or **A**.

▶ Press the  button.

The green  indicator lamp in the instrument cluster lights up.

▶ **To switch off the front fog lamps:** press the  button.

The green  indicator lamp in the instrument cluster goes out.

**i** If you switch the engine off (key in position **1** in the ignition lock) and then restart it, the previous fog lamp settings are restored.

### Rear fog lamp

▶ **To switch on the rear fog lamp:** turn the key in the ignition lock to position **2** or start the engine.

▶ Turn the light switch to  or **A**.

When the light switch is set to **A**, the rear fog lamp only lights up if the low-beam headlamps are switched on.

▶ Press the  button.

The yellow  indicator lamp in the instrument cluster lights up.

▶ **To switch off the rear fog lamp:** press the  button.

The yellow  indicator lamp in the instrument cluster goes out.

**i** If you switch the engine off (key in position **1** in the ignition lock) and then restart it, the previous rear fog lamp settings are restored.

## Combination switch

### Turn signals

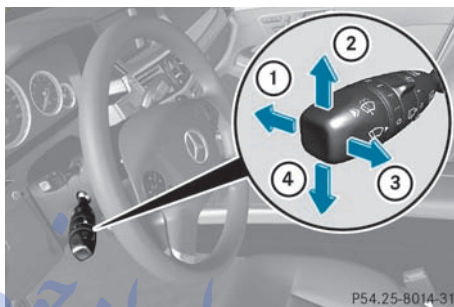

① High-beam headlamps

② Right turn signal

③ High beam flasher

④ Left turn signal

▶ **To indicate briefly:** press the combination switch briefly to the pressure point in the direction of arrow ② or ④.

The corresponding turn signal flashes three times.

▶ **To indicate:** press the combination switch beyond the pressure point in the direction of arrow ② or ④.

## High-beam headlamps

▶ **To switch on the high-beam headlamps:** turn the key in the ignition lock to position **2** or start the engine.

▶ Turn the light switch to  or **A**.

▶ Press the combination switch beyond the pressure point in the direction of arrow ①.

In the **A** position, the high-beam headlamps are only switched on when it is dark and the engine is running.

The  indicator lamp in the instrument cluster lights up when the high-beam headlamps are switched on.

► **To switch off the high-beam**

**headlamps:** move the combination switch back to its normal position.

The  indicator lamp in the instrument cluster goes out.

## Adaptive Highbeam Assist

### **Warning!**

The Adaptive Highbeam Assist is only an aid intended to support you while driving. The driver is and remains responsible for proper vehicle lighting in accordance with the prevailing light, sight and traffic conditions. The system may be impaired or unavailable when

- visibility is poor, e.g. due to snow, rain, fog, or heavy spray
- the optical sensor area of the windshield is dirty, fogged up, or covered by a sticker for example

The system cannot recognize the following road users:

- Road users without a lighting system of their own, e.g. pedestrians
- Road users with dim lighting of their own, e.g. cyclists
- Road users whose lighting is obstructed, e.g. road users behind a guardrail
- In some seldom cases, even road users with a lighting system of their own may be recognized too late or not at all.

The automatic high-beam headlamps will then not be deactivated or it will be activated in spite of preceding or oncoming road users.

This could endanger you and/or others and cause an accident. Always pay close attention to the traffic situation and switch off the high beam manually if necessary.

You can use this function to set the headlamps to change between low beam and

high beam automatically. The system recognizes vehicles with their lights on, either approaching from the opposite direction or traveling in front of your vehicle, and consequently switches the headlamps from high beam to low beam.

The system automatically adapts the low-beam headlamp range depending on the distance to the other vehicle. Once the system no longer detects any other vehicles, it reactivates the high-beam headlamps.

The system's optical sensor is located behind the windshield near the overhead control panel.



► **To activate:** activate the Adaptive Highbeam Assist function using the on-board computer (► page 230).

► Turn the light switch to .

► Press the combination switch beyond the pressure point in the direction of arrow ① (► page 120).

When the low-beam headlamps are switched on, the  indicator lamp in the instrument cluster lights up.



If you are driving at speeds above approximately 25 mph (40 km/h):

the headlamp range is set automatically depending on the distance between the vehicle and other road users.

if you are driving at speeds above approximately 35 mph (55 km/h) and no other road users have been detected:

the high-beam headlamps are switched on automatically. The  indicator lamp in the instrument cluster also lights up.

if you are driving at speeds below approximately 30 mph (45 km/h) and other road users have been detected or the roads are illuminated sufficiently:

the high-beam headlamps are switched off automatically. The  indicator lamp in the instrument cluster goes out. The  indicator lamp in the instrument cluster stays on.

- ▶ **To deactivate:** move the combination switch back to its normal position. The  indicator lamp in the instrument cluster goes out.

### High-beam flasher

- ▶ **To switch on:** turn the key in the ignition lock to position **1** or **2** or start the engine.
- ▶ Pull the combination switch briefly in the direction of arrow .

### Hazard warning lamps



The hazard warning lamps automatically switch on:

- if an air bag is deployed
- the vehicle decelerates rapidly from a speed of more than 45 mph (70 km/h) and comes to a standstill.

▶ **To switch on the hazard warning lamps:** press button .

All turn signals flash. If you now switch on a turn signal using the combination switch, only the turn signal lamp on the corresponding side of the vehicle will flash.

▶ **To switch off the hazard warning lamps:** press button .

The hazard warning lamp switches off automatically after full brake application if the vehicle then reaches a speed above 6 mph (10 km/h) again.

- ❗ The hazard warning lamps still operate if the ignition is switched off.

### Headlamp cleaning system

The headlamps are cleaned automatically if the "Wipe with washer fluid" function is operated ten times while the lights are on and the engine is running (▷ page 128). When you switch off the ignition, the automatic headlamp cleaning system is reset and counting is resumed from 0.

### Cornering light function



The cornering light function improves the illumination of the road over a wide angle in the direction you are turning, enabling better visibility in tight bends, for example. It can only be activated when the low-beam headlamps are switched on.

**Active:** if you are driving at speeds below 25 mph (40 km/h) and switch on the turn signals or turn the steering wheel.

**Not active:** if you are driving at speeds above 25 mph (40 km/h) or switch off the turn signal or turn the steering wheel to the straight-ahead position.

The cornering light function may remain lit for a short time, but is automatically switched off after no more than three minutes.

### Headlamps fogged up on the inside

The headlamps may fog up on the inside if there is high atmospheric humidity.

- ▶ Drive with the headlamps switched on. The headlamps clear up after a short distance.

If the moisture does not disappear, the headlamp casing is not sealed correctly and moisture has been able to enter.

- ▶ Have the headlamps checked at a qualified specialist workshop.



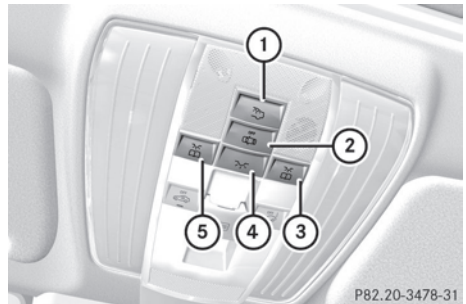

## Interior lighting

### Overview of interior lighting



P82.20-3478-31

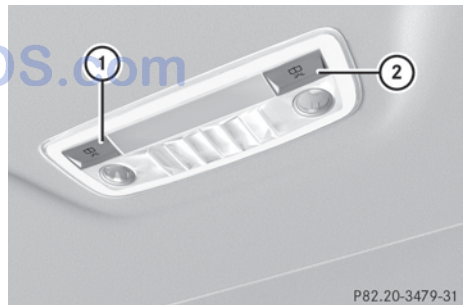

Front overhead control panel

- ①  To switch the rear interior lighting on/off
- ②  To switch the automatic interior lighting control on/off
- ③  To switch the right-hand front reading lamp on/off
- ④  To switch the front interior lighting on/off
- ⑤  To switch the left-hand front reading lamp on/off



P82.20-3479-31

Rear-compartment overhead control panel

- ①  To switch the right-hand reading lamp on/off
- ②  To switch the left-hand reading lamp on/off



## Interior lighting control

### Important notes

In order to prevent the vehicle's battery from discharging, the interior lighting functions are automatically deactivated after some time except for when the key is in position **2** in the ignition lock.

### Automatic interior lighting control



► **To switch on/off:** press the  button. When the automatic interior lighting control is activated, the button is flush with the overhead control panel.

The interior lighting automatically switches on if you:

- unlock the vehicle
- open a door
- remove the key from the ignition lock

The interior light is activated for a short while when the key is removed from the ignition lock. You can activate this delayed switch-off using the on-board computer (▷ page 231).

### Manual interior lighting control

- **To switch the front interior lighting on/off:** press the  button.
- **To switch the rear interior lighting on/off:** press the  button.
- **To switch the reading lamps on/off:** press the  button.

### Crash-responsive emergency lighting

If the interior lighting is set to automatic, the interior lighting is activated automatically if the vehicle is involved in an accident.

► **To switch off the crash-responsive emergency lighting:** press the hazard warning lamp button.

or

► Lock and then unlock the vehicle using the key.

## Changing bulbs

### Important safety notes

#### Xenon bulbs

If your vehicle is equipped with Xenon bulbs, you can recognize this by the following: the cone of light from the Xenon bulbs moves from the top to the bottom and back again when you start the engine. For this to be observed, the lights must be switched on before starting the engine.

#### **Warning!**

Xenon bulbs carry a high voltage. You could get an electric shock and be seriously or even fatally injured if you touch the electric contacts on Xenon bulbs. Therefore, never remove the cover from Xenon bulbs.

Do not change Xenon bulbs yourself, but have them replaced at a qualified specialist workshop which has the necessary specialist knowledge and tools to carry out the work required.

Mercedes-Benz recommends that you use an authorized Mercedes-Benz Center for this purpose. In particular, work relevant to safety or on safety-related systems must be carried out at a qualified specialist workshop.

Bulbs and lamps are an important aspect of vehicle safety. You must therefore make sure that these function correctly at all times. Have the headlamp setting checked regularly.

#### Other bulbs

#### **Warning!**

Bulbs and lamps can be very hot. You should therefore allow them to cool down before you change them. Otherwise, you could be burned if you touch them.

Keep bulbs out of the reach of children. Otherwise, they could damage the bulbs, for example, and injure themselves.



Never use a bulb which has been dropped. Such a bulb may break or even explode and injure you.

Halogen bulbs are pressurized and can explode when you change them, particularly if they are very hot. You should therefore wear eye protection and gloves when you are changing them.

There are bulbs other than the Xenon bulbs that you cannot replace. Replace only the bulbs listed (▷ page 125). Have the bulbs that you cannot replace yourself changed at a qualified specialist workshop.

Mercedes-Benz recommends that you use an authorized Mercedes-Benz Center for this purpose. In particular, work relevant to safety or on safety-related systems must be carried out at a qualified specialist workshop.

If you require assistance changing bulbs, consult a qualified specialist workshop.

Do not touch the glass tube of new bulbs with your bare hands. Even minor contamination can burn into the glass surface and reduce the service life of the bulbs. Always use a lint-free cloth or only touch the base of the bulb when installing.

Only use bulbs of the correct type.

If the new bulb still does not light up, consult a qualified specialist workshop.

Bulbs and lamps are an important aspect of vehicle safety. You must therefore make sure that these function correctly at all times. Have the headlamp setting checked regularly.

### Overview: changing bulbs/bulb types

You can change the following bulbs. The bulb type can be found in the legend.

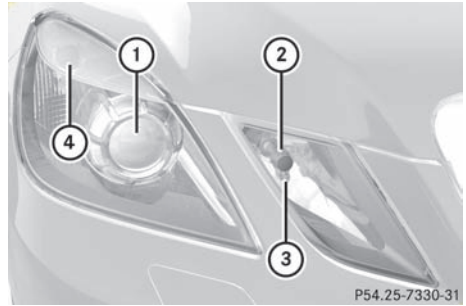

#### Halogen headlamps

- ① Low-beam headlamps<sup>11</sup>: H7 55 W
- ② High-beam headlamp: H7 55 W
- ③ Parking lamp/standing lamp: W 5 W
- ④ Turn signal lamp: 3457A

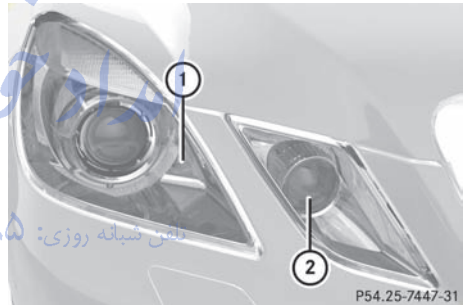

#### Bi-Xenon headlamps

- ① Cornering lamp: H7 55 W
- ② Infrared light (Night View Assist Plus): H11 55 W

<sup>11</sup> Due to their location, have the bulbs in the left-hand headlamp changed at a qualified specialist workshop, e.g. an authorized Mercedes-Benz Center.

### Changing the front bulbs

#### Low-beam headlamp (halogen headlamp)

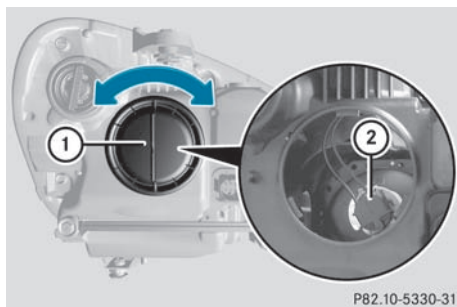

Due to their location, have the bulbs in the left-hand headlamp changed at a qualified specialist workshop, e.g. an authorized Mercedes-Benz Center.

- ▶ Switch off the lights.
- ▶ Open the hood.
- ▶ Turn housing cover ① counter-clockwise and pull it out.
- ▶ Turn bulb holder ② counter-clockwise and pull it out.
- ▶ Take the bulb out of bulb holder ②.
- ▶ Insert the new bulb into bulb holder ②.
- ▶ Insert bulb holder ② into the lamp and turn it clockwise.
- ▶ Align housing cover ① and turn it clockwise until it engages.

#### High-beam headlamp (halogen headlamp)/cornering lamp (bi-xenon headlamp)

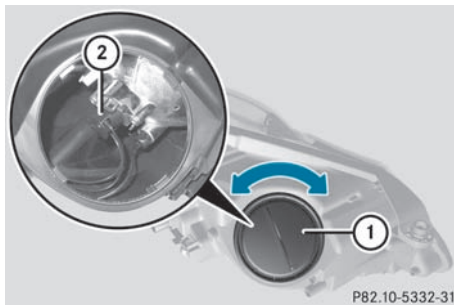

- ▶ Switch off the lights.
- ▶ Open the hood.
- ▶ Turn housing cover ① counter-clockwise and pull it out.
- ▶ Turn bulb holder ② counter-clockwise and pull it out.
- ▶ Take the bulb out of bulb holder ②.
- ▶ Insert the new bulb into bulb holder ②.
- ▶ Insert bulb holder ② into the lamp and turn it clockwise.
- ▶ Align housing cover ① and turn it clockwise until it engages.

#### Parking lamp/standing lamp (halogen headlamps)

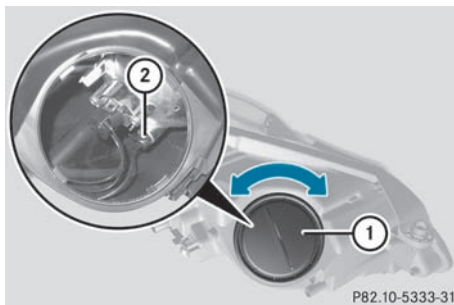

- ▶ Switch off the lights.
- ▶ Open the hood.
- ▶ Turn housing cover ① counter-clockwise and pull it out.

- ▶ Pull out bulb holder ②.
- ▶ Take the bulb out of bulb holder ②.
- ▶ Insert the new bulb into bulb holder ②.
- ▶ Insert bulb holder ②.
- ▶ Align housing cover ① and turn it clockwise until it engages.

### Infrared light (Night View Assist Plus)

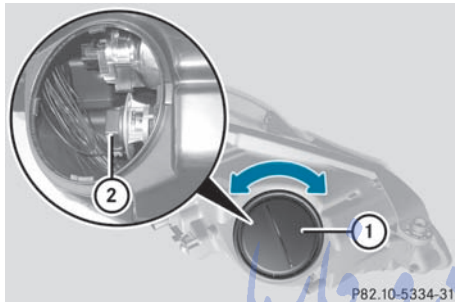

- ▶ Switch off the lights.
- ▶ Open the hood.
- ▶ Turn housing cover ① counter-clockwise and pull it out.
- ▶ Turn bulb ② counter-clockwise and pull it out.
- ▶ Insert new bulb ② and turn it clockwise.
- ▶ Align housing cover ① and turn it clockwise until it engages.

### Turn signals (halogen headlamps)

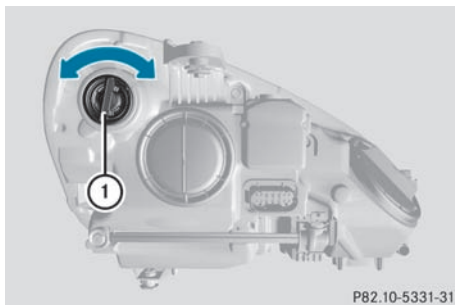

Due to their location, have the bulbs in the left-hand headlamp changed at a qualified

specialist workshop, e.g. an authorized Mercedes-Benz Center.

- ▶ Switch off the lights.
- ▶ Open the hood.
- ▶ Turn bulb holder ① counter-clockwise and pull it out.
- ▶ Turn the bulb counter-clockwise, applying slight pressure, and remove it from bulb holder ①.
- ▶ Insert the new bulb into bulb holder ① and turn it clockwise.
- ▶ Insert bulb holder ① into the lamp and turn it clockwise.

### Windshield wipers

#### Important safety notes

##### ⚠ Warning!

Wiper blades are components that are subject to wear and tear. Replace the wiper blades twice a year, preferably in the spring and fall. Otherwise the windows will not be wiped properly. As a result, you may not be able to observe surrounding traffic conditions and could cause an accident.

- ❗ Do not operate the windshield wipers when the windshield is dry, as this could damage the wiper blades. Moreover, dust that has collected on the windshield/rear window can scratch the glass if wiping takes place when the windshield/rear window is dry.
- If it is necessary to switch on the windshield wipers in dry weather conditions, always use washer fluid when operating the windshield wipers.

### Switching the windshield wipers on/off

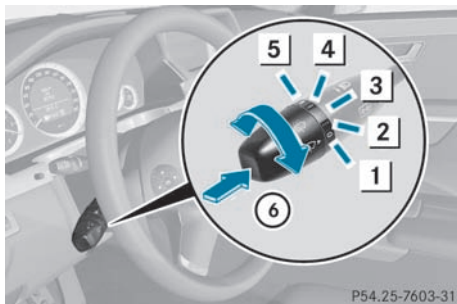

P54.25-7603-31

Combination switch

- 1  0 Windshield wipers off
- 2  ... Intermittent wipe, low<sup>12</sup>
- 3  .... Intermittent wipe, high<sup>13</sup>
- 4  — Continuous wipe, slow
- 5  = Continuous wipe, fast
- 6  Single wipe/  to wipe the windshield using washer fluid

► Switch the ignition on.

► Turn the combination switch to the corresponding position.

**!** Intermittent wiping with rain sensor: due to optical influences and the windshield becoming dirty in dry weather conditions, the windshield wipers may be activated inadvertently. This could then damage the windshield wiper blades or scratch the windshield.

For this reason, you should always switch off the windshield wipers in dry weather.

In the  ... or  .... position, the appropriate wiping frequency is automatically set according to the intensity of the rain. In the  .... position, the rain sensor is more sensitive than in the  ... position, causing the windshield wipers to wipe more frequently.

Intermittent wiping is interrupted when you stop the vehicle and open a front door. This

<sup>12</sup> Rain sensor set to low sensitivity.

<sup>13</sup> Rain sensor set to high sensitivity.

prevents a person from being splashed inadvertently when getting into or out of the vehicle.

Intermittent wiping continues when all doors are closed and

- you shift the automatic transmission to drive position **D** or reverse gear **R** or
- you change the wipe setting on the combination switch.

**i** To prevent smearing on the windshield or noise when wiping, wipe the windshield occasionally with washer fluid.

### Switching the rear window wiper on/off

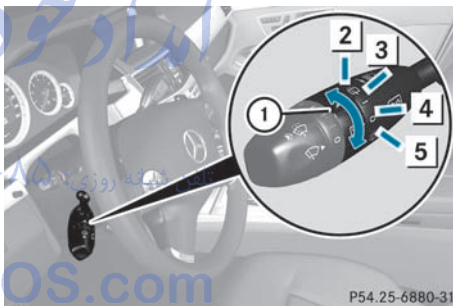

P54.25-6880-31

Combination switch

- ①  Switch
- 2  To wipe with washer fluid
- 3  | To switch on intermittent wiping
- 4  0 To switch off intermittent wiping
- 5  To wipe with washer fluid

► Turn the key to position **1** or **2** in the ignition lock.

► Turn switch ① on the combination switch to the corresponding position.

When the rear window wiper is switched on, the icon appears in the instrument cluster.

## Replacing the wiper blades

### Important safety notes

#### Warning

For safety reasons, switch off the windshield wipers and remove the key from the ignition lock before changing the wiper blades (vehicles with KEYLESS-GO: make sure that the on-board electronics are in state **0**). Otherwise, the wiper motor could be switched on suddenly and cause injury.

- !** To avoid damaging the wiper blades, make sure that you touch only the wiper arm of the wiper.
- !** Never open the hood if a windshield wiper arm has been folded away from the windshield.

Never fold a windshield wiper arm without a wiper blade back onto the windshield/rear window.

Hold the windshield wiper arm firmly when you change the wiper blade. If you release the windshield wiper arm without a wiper blade and it falls onto the windshield, the windshield may be damaged by the force of the impact.

Mercedes-Benz recommends that you have the wiper blades replaced by a qualified specialist workshop, e.g. at an authorized Mercedes-Benz Center.

### Replacing the windshield wiper blades

#### Removing the wiper blades

- ▶ Remove the key from the ignition lock or turn the key to position **0** (KEYLESS-GO).
- ▶ Fold the wiper arm away from the windshield until it engages.
- ▶ Set the wiper blade at right angles to the wiper arm.

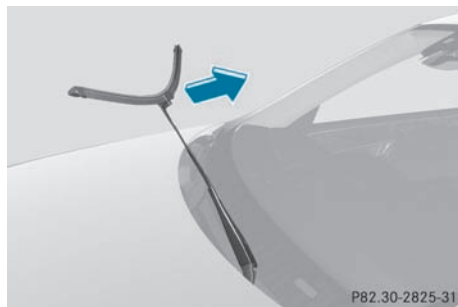

- ▶ Remove the wiper blade from the retainer on the wiper arm in the direction of the arrow.

#### Installing the wiper blade

- ▶ Slide the new wiper blade into the retainer on the wiper arm in the opposite direction to the arrow.
- ▶ Make sure that the wiper blade slides fully into the retainer on the wiper arm.
- ▶ Turn the wiper blade parallel to the wiper arm.
- ▶ Fold the wiper arm back onto the windshield.

### Replacing the rear window wiper blade

#### Warning

The wiper arm could be set in motion and injure you if the windscreen wipers are switched on.

Remove the key from the ignition lock before replacing the wiper blade.

#### Removing the wiper blade

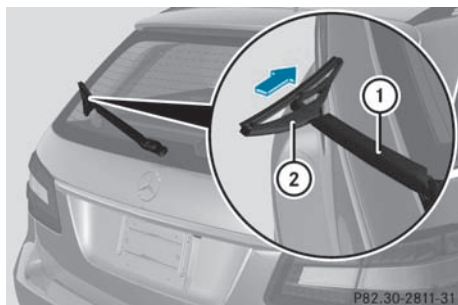

فارما سوس

تلفن: ۰۲۱-۸۸۸۸۸۸۸۸

FarmaSOS.com

P82.30-2825-31

P82.30-2811-31

- ▶ Remove the key from the ignition lock.
- ▶ Fold wiper arm ① away from the rear window until it engages.
- ▶ Position wiper blade ② at a right angle to wiper arm ①.
- ▶ Hold wiper arm ① and press wiper blade ② in the direction of the arrow until it is released.
- ▶ Remove wiper blade ②.
- ▶ Select another wiper speed on the combination switch.
- ▶ Have the windshield wipers checked at a qualified specialist workshop.

### Installing the wiper blade

- ▶ Place new wiper blade ② onto wiper arm ①.
- ▶ Hold wiper arm ① and press wiper blade ② in the opposite direction to the arrow until it engages.
- ▶ Make sure that wiper blade ② is seated correctly.
- ▶ Position wiper blade ② parallel to wiper arm ①.
- ▶ Fold wiper arm ① back onto the rear window.

امداد خودرو فارما  
تلفن شبانه روزی: ۰۲۱-۸۸۸۶۲۰۸۵

### Problems with the windshield wipers

#### The windshield wipers are obstructed

Leaves or snow, for example, may be obstructing the windshield wiper movement. The wiper motor has been deactivated.

- ▶ For safety reasons, you should remove the key from the ignition lock.

or

- ▶ Switch off the engine using the Start/Stop button and open the driver's door.
- ▶ Remove the cause of the obstruction.
- ▶ Switch the windshield wipers back on.

#### The windshield wipers are inoperative

The windshield wiper drive is malfunctioning.

Vehicle equipment .....	132
Overview of climate control systems .....	132
Operating the control systems .....	138
Setting the air vents .....	144

# امداد خودرو فارما

تلفن شبانه روزی: ۰۲۱-۸۸۸۶۲۰۸۵

[FarmaSOS.com](http://FarmaSOS.com)



## Vehicle equipment

**i** This manual describes all the standard and optional equipment of your vehicle which was available at the time of purchase. Country-specific differences are possible. Bear in mind that your vehicle may not feature all functions described here. This also refers to safety-related systems and functions.

## Overview of climate control systems

### Important safety notes

#### Warning

Severe conditions (e.g. strong air pollution) may require replacement of the filter before its scheduled replacement interval. A clogged filter will reduce the air volume to the interior and the windows could fog up, impairing visibility and endangering you and others. Have a clogged filter replaced as soon as possible at an authorized Mercedes-Benz Center.

#### Warning

Follow the recommended settings for heating and cooling given on the following pages. Otherwise, the windows could fog up, impairing visibility and endangering you and others.

Dual-zone automatic climate control/3-zone automatic climate control controls the temperature and the humidity of the vehicle interior and filters out undesirable substances from the air.

Dual-zone automatic climate control/3-zone automatic climate control is only operational when the engine is running<sup>14</sup>. It only works optimally if you drive with the side windows and tilt/sliding sunroof/panorama roof with power tilt/sliding panel closed.

**i** Ventilate the vehicle for a brief period during warm weather, e.g. using the convenience opening feature (▷ page 93). This will speed up the cooling process and the desired vehicle interior temperature will be reached more quickly.

**i** The integrated filter can filter out most particles of dust and completely filters out pollen. A clogged filter reduces the amount of air supplied to the vehicle interior. For this reason, you should always observe the interval for replacing the filter, which is specified in the Service Booklet. As it depends on environmental conditions, e.g. heavy air pollution, the interval may be shorter than stated in the Service Booklet.

**i** It is possible that the "residual heat" function may be activated automatically an hour after the SmartKey is removed. The vehicle is then ventilated for 30 minutes to dry the air-conditioning system.

<sup>14</sup> 3-zone automatic climate control: the "residual heat" function can only be activated or deactivated when the ignition is switched off.

## Control panel for the dual-zone automatic climate control

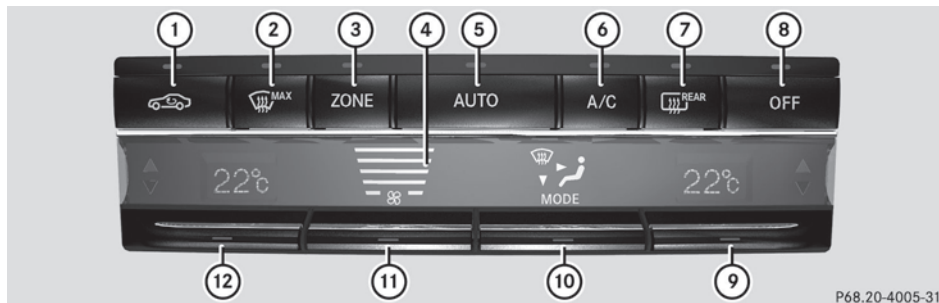

For Canada only

	Function	Notes/tips
①	Activates/deactivates air-recirculation mode	Only use "air-recirculation" mode briefly, e.g. if there are unpleasant outside odors or when in a tunnel. The windows could otherwise fog up as, in air-recirculation mode, no fresh air is drawn into the vehicle.
②	Defrosts the windshield	Only use the "defrosting" function briefly until the windshield is clear again.
③	Switches the ZONE function on/off	Use the ZONE function to adopt the temperature settings on the driver's side for the front-passenger side as well. The indicator lamp above the <b>ZONE</b> button goes out.
④	Display	
⑤	Sets climate control to automatic	Activate climate control using the <b>AUTO</b> and <b>A/C</b> buttons. The indicator lamps above the <b>AUTO</b> and <b>A/C</b> buttons light up.
⑥	Switches cooling with air dehumidification on/off	Activate climate control using the <b>AUTO</b> and <b>A/C</b> buttons. The indicator lamps above the <b>AUTO</b> and <b>A/C</b> buttons light up.
⑦	Switches the rear window heating on/off	
⑧	Switches climate control on/off	
⑨	Sets the temperature, right	Set the temperature to 72 °F (22 °C).
⑩	Sets the air distribution	

	Function	 Notes/tips
⑪	Sets the airflow	
⑫	Sets the temperature, left	Set the temperature to 72 °F (22 °C).

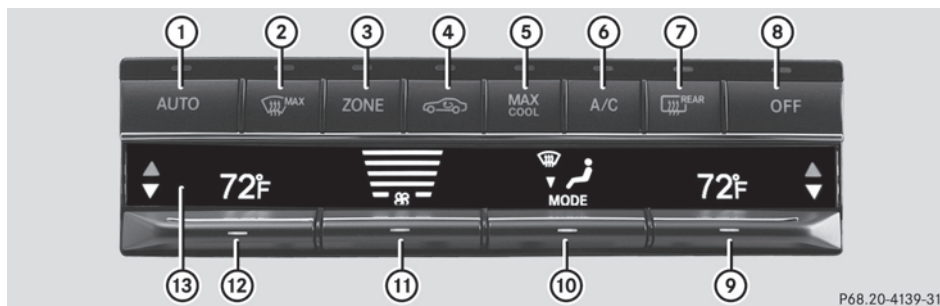

P68.20-4139-31

For USA only

	Function	 Notes/tips
①	Sets climate control to automatic	Activate climate control using the <b>AUTO</b> and <b>A/C</b> buttons. The indicator lamps above the <b>AUTO</b> and <b>A/C</b> buttons light up.
②	Defrosts the windshield	Only use the "defrosting" function briefly until the windshield is clear again.
③	Switches the ZONE function on/off	Use the ZONE function to adopt the temperature settings on the driver's side for the front-passenger side as well. The indicator lamp above the <b>ZONE</b> button goes out.
④	Activates/deactivates air-recirculation mode	Only use "air-recirculation" mode briefly, e.g. if there are unpleasant outside odors or when in a tunnel. The windows could otherwise fog up as, in air-recirculation mode, no fresh air is drawn into the vehicle.
⑤	Switches maximum cooling MAX COOL on/off	
⑥	Switches cooling with air dehumidification on/off	Activate climate control using the <b>AUTO</b> and <b>A/C</b> buttons. The indicator lamps above the <b>AUTO</b> and <b>A/C</b> buttons light up.
⑦	Switches the rear window heating on/off	

	Function	<b>i</b> Notes/tips
⑧	Switches climate control on/off	Activate climate control using the <b>AUTO</b> and <b>A/C</b> buttons. The indicator lamps above the <b>AUTO</b> and <b>A/C</b> buttons light up.
⑨	Sets the temperature, right	Set the temperature to 72 °F (22 °C).
⑩	Sets the air distribution	
⑪	Sets the airflow	
⑫	Sets the temperature, left	Set the temperature to 72 °F (22 °C).
⑬	Display	

**Control panel for the three-zone automatic climate control**

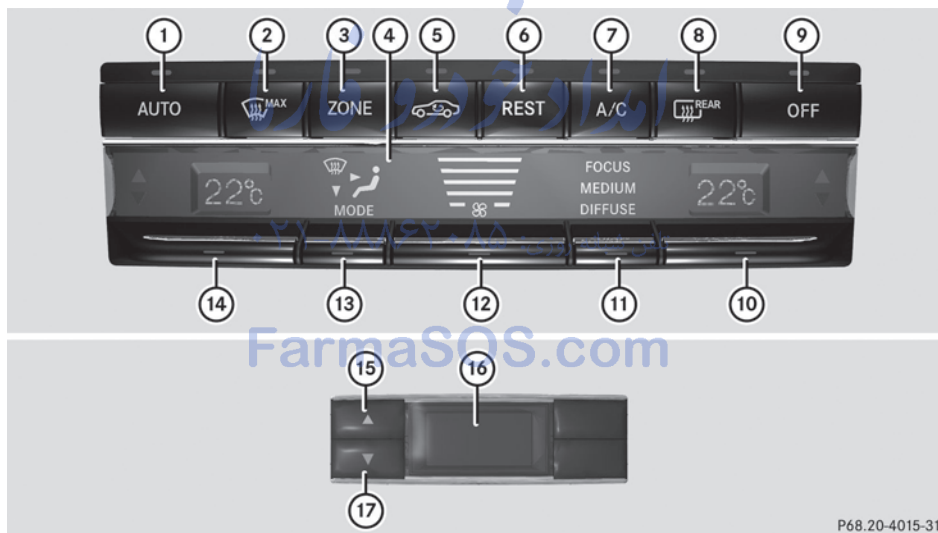

P68.20-4015-31

For Canada only

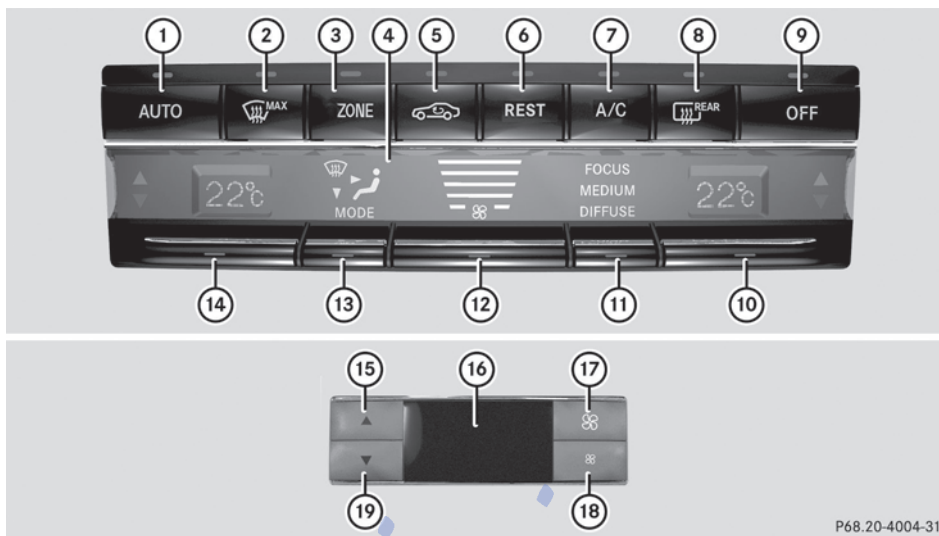

P68.20-4004-31

Function	Notes/tips
<b>Front control panel</b>	
① Sets climate control to automatic	Activate climate control using the <b>AUTO</b> and <b>A/C</b> buttons. The indicator lamps above the <b>AUTO</b> and <b>A/C</b> buttons light up. You can also set the airflow and air distribution of the automatic climate control to one of three levels (FOCUS/MEDIUM/DIFFUSE). You can set the desired level using button ⑪. The MEDIUM level is recommended.
② Defrosts the windshield	Only use the "defrosting" function briefly until the windshield is clear again.
③ Switches the ZONE function on/off	Use the ZONE function to adopt the temperature settings on the driver's side for the front-passenger side and the rear compartment as well. The indicator lamp above the <b>ZONE</b> button goes out.
④ Display	
⑤ Activates/deactivates air-recirculation mode	Only use "air-recirculation" mode briefly, e.g. if there are unpleasant outside odors or when in a tunnel. The windows could otherwise fog up as, in air-recirculation mode, no fresh air is drawn into the vehicle.

	Function	 Notes/tips
⑥	Switches the residual heat function on/off	Use the residual heat function if you want to heat or ventilate the vehicle interior when the ignition is switched off. The "residual heat" function can only be activated or deactivated with the ignition switched off.
⑦	Switches cooling with air dehumidification on/off	Activate climate control using the <b>AUTO</b> and <b>A/C</b> buttons. The indicator lamps above the <b>AUTO</b> and <b>A/C</b> buttons light up. You can also set the airflow and air distribution of the automatic climate control to one of three levels (FOCUS/MEDIUM/DIFFUSE). You can set the desired level using button ⑪. The MEDIUM level is recommended.
⑧	Switches the rear window heating on/off	
⑨	Switches climate control on/off	Activate climate control using the <b>AUTO</b> and <b>A/C</b> buttons. The indicator lamps above the <b>AUTO</b> and <b>A/C</b> buttons light up. You can also set the airflow and air distribution of the automatic climate control to one of three levels (FOCUS/MEDIUM/DIFFUSE). You can set the desired level using button ⑪. The MEDIUM level is recommended.
⑩	Sets the temperature, right	Set the temperature to 72 °F (22 °C).
⑪	Sets the climate control to automatic (FOCUS/MEDIUM/DIFFUSE)	Activate climate control using the <b>AUTO</b> and <b>A/C</b> buttons. The indicator lamps above the <b>AUTO</b> and <b>A/C</b> buttons light up. You can also set the airflow and air distribution of the automatic climate control to one of three levels (FOCUS/MEDIUM/DIFFUSE). You can set the desired level using button ⑪. The MEDIUM level is recommended.
⑫	Sets the airflow	
⑬	Sets the air distribution	
⑭	Sets the temperature, left	Set the temperature to 72 °F (22 °C).
<b>Rear control panel</b>		
⑮	Increases the temperature	Set the temperature to 72 °F (22 °C).
⑯	Display	
⑰	Increases the airflow	

	Function	 Notes/tips
⑱	Reduces the airflow	
⑲	Reduces the temperature	Set the temperature to 72 °F (22 °C).

## Operating the control systems

### Switching the control on/off

#### Important information

##### **Warning!**

When the climate control system is deactivated, the outside air supply and circulation are also deactivated. Only choose this setting for a short time. Otherwise the windows could fog up, impairing visibility and endangering you and others.

-  Activate climate control primarily using the **AUTO** button (> page 139).

#### Activating/deactivating

- ▶ Turn the SmartKey to position **2** in the ignition lock.
- ▶ **To activate:** press the **AUTO** button.  
The indicator lamp above the **AUTO** button lights up. Airflow and air distribution are set to automatic mode.

or

- ▶ Press the **OFF** button.  
The indicator lamp above the **OFF** button goes out. The previously selected settings come into effect again.
- ▶ **To deactivate:** press the **OFF** button.  
The indicator lamp above the **OFF** button lights up.

### Switching cooling with air dehumidification on/off

#### Important information

The cooling with air dehumidification function is only available when the engine is running. The air inside the vehicle is cooled and dehumidified according to the temperature selected.

##### **Warning**

If you switch off the cooling function, the vehicle will not be cooled when weather conditions are warm. The windows can fog up more quickly. Window fogging may impair visibility and endanger you and others.

Condensation may drip from the underside of the vehicle when automatic climate control is in cooling mode. This is normal and not a sign that there is a malfunction.

-  The cooling with air dehumidification function uses refrigerant R134a. This coolant does not contain chlorofluorocarbons, and therefore does not damage the ozone layer.

#### Activating/deactivating

- ▶ **To switch on:** press the **A/C** button.  
The indicator lamp above the **A/C** button lights up.
- ▶ **To switch off:** press the **A/C** button.  
The indicator lamp above the **A/C** button goes out. The cooling with air dehumidification function has a delayed switch-off feature.



## Problems with the "cooling with air dehumidification" function

If the indicator lamp in the  button does not go out when switched off, the cooling with air dehumidification function is switched off due to a malfunction. You can no longer activate the cooling with air dehumidification function.

- ▶ Consult a qualified specialist workshop.



## Setting climate control to automatic

### Warning

If you switch off the cooling function, the vehicle will not be cooled when weather conditions are warm. The windows can fog up more quickly. Window fogging may impair visibility and endanger you and others.

In automatic mode, the set temperature is maintained automatically at a constant level. The system automatically regulates the temperature of the dispensed air, the airflow and the air distribution.

Automatic mode will achieve optimal operation if cooling with air dehumidification is also activated. If desired, cooling with air dehumidification can be deactivated.

- ▶ Turn the SmartKey to position **2** in the ignition lock.
- ▶ Set the desired temperature.
- ▶ **To activate:** press the  button. The indicator lamp above the  button lights up. Automatic air distribution and airflow are activated.
- ▶ 3-zone automatic climate control: press switch  up or down and select the desired level (▷ page 135).

- FOCUS** Air flow high/air distribution via the center and side vents
- MEDIUM** Air flow medium/air distribution via the center and side vents
- DIFFUSE** Air flow low/air distribution via the center, side and defroster vents

- i** This setting is especially effective in automatic mode when outside temperatures are high.

- ▶ **To deactivate:** press the air distribution button.

Dual-zone automatic climate control: press button  (▷ page 133).

3-zone automatic climate control: press button  (▷ page 135).

The indicator lamp above the  button goes out.

or

- ▶ Press the airflow button.

Dual-zone automatic climate control: press button  (▷ page 133).



3-zone automatic climate control: press button  (▷ page 135).

The indicator lamp above the  button goes out.

## Setting the temperature

### Dual-zone automatic climate control

Different temperatures can be set for the driver's and front-passenger sides.

- ▶ Turn the SmartKey to position **2** in the ignition lock.
- ▶ **To increase/reduce:** press button  or  up or down (▷ page 133). Only change the temperature setting in small increments. Start at 72 °F (22 °C).



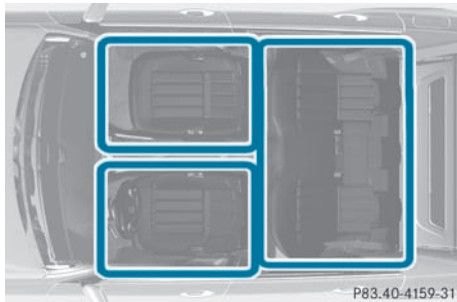



### 3-zone automatic climate control



Climate zones of 3-zone automatic climate control  
You can select different temperature settings for the driver's and front-passenger sides as well as for the rear compartment.

- ▶ Turn the SmartKey to position **2** in the ignition lock.
- ▶ **To increase/reduce the temperature in the front compartment:** press button **10** or **14** up or down (▷ page 135).  
Only change the temperature setting in small increments. Start at 72 °F (22 °C).
- ▶ **To increase/reduce the temperature in the rear compartment using the front control panel:** press the **ZONE** button (▷ page 135).  
The indicator lamp above the **ZONE** button goes out.
- ▶ Press button **10** or **14** up or down (▷ page 135).  
Only change the temperature setting in small increments. Start at 72 °F (22 °C).
- ▶ **To increase/reduce the temperature in the rear compartment using the rear control panel:** press button **15** or **19** (▷ page 135).  
Only change the temperature setting in small increments. Start at 72 °F (22 °C).

### Setting the air distribution

-  directs the airflow through the defroster vents
-  directs the airflow through the center and side air vents
-  directs the airflow through the footwell air vents
-  directs the airflow through the center, side, and footwell air vents<sup>15</sup>
-  directs the airflow through the defroster, center and side air vents<sup>16</sup>
-  directs the airflow through the footwell and defroster vents

**i** Regardless of the air distribution setting, airflow is always directed through the side air vents. The side air vents can only be closed when the controls on the side air vents are turned downwards.

### Dual-zone automatic climate control

- ▶ Turn the SmartKey to position **2** in the ignition lock.
- ▶ Press switch **10** up or down repeatedly until the desired symbol appears in the display (▷ page 133).

### 3-zone automatic climate control

- ▶ Turn the SmartKey to position **2** in the ignition lock.
- ▶ Press switch **10** or **13**<sup>16</sup> up or down repeatedly until the desired symbol appears in the display (▷ page 135).

<sup>15</sup> USA only.

<sup>16</sup> Canada only.

## Setting the airflow



### Dual-zone automatic climate control

- ▶ Turn the SmartKey to position **2** in the ignition lock.
- ▶ **To increase/reduce:** press switch (11) up or down (▷ page 133).



### 3-zone automatic climate control

- ▶ Turn the SmartKey to position **2** in the ignition lock.
- ▶ **To increase/reduce front-compartment airflow:** press switch (12) up or down (▷ page 135).
- ▶ **To increase/reduce the rear airflow:** press button (17) or (18) (▷ page 135).

## Switching the ZONE function on/off

- ▶ **To switch on:** press the  button (▷ page 133), (▷ page 135).  
The indicator lamp above the  button lights up.  
Dual-zone automatic climate control: the temperature setting for the driver's side is not adopted for the front-passenger side.  
3-zone automatic climate control: the temperature setting on the driver's side is not adopted for the front-passenger side or the rear compartment.



When the buttons for temperature, airflow or air distribution are activated, the temperature setting on the driver's side is not adopted for the other climate control zones.

- ▶ **To switch off:** press the  button (▷ page 133), (▷ page 135).  
The indicator lamp above the  button goes out.  
Dual-zone automatic climate control: the temperature setting for the driver's side is not adopted for the front-passenger side.

3-zone automatic climate control: the temperature setting on the driver's side is not adopted for the front-passenger side or the rear compartment.



## Defrosting the windshield

You can use this function to defrost the windshield or to defrost the inside of the windshield and the side windows.



- ▶ **i** You should only select the defrosting function until the windshield is clear again.
- ▶ Turn the SmartKey to position **2** in the ignition lock.
- ▶ **To activate:** press the  button.  
The indicator lamp above the  button lights up.

The climate control system switches to the following functions:

- cooling with air dehumidification on
- high airflow<sup>17</sup>
- high temperature<sup>17</sup>
- air distribution to the windshield and front side windows
- air-recirculation mode off

- ▶ **To deactivate:** press the  button.  
The indicator lamp above the  button goes out. The previously selected settings come into effect again. The cooling with air dehumidification function remains on. Air-recirculation mode remains deactivated.

or

- ▶ Press the  button.  
The indicator lamp above the  button goes out. Airflow and air distribution are set to automatic mode.

or

- ▶ **Dual-zone automatic climate control:** press switch (9) or (12) up or down (▷ page 133).

<sup>17</sup> Depending on the outside temperature.

**3-zone automatic climate control:** press switch (10) or (14) up or down (▷ page 135).

or

▶ **Dual-zone automatic climate control:** press switch (11) up or down (▷ page 133).



**3-zone automatic climate control:** press switch (12) up or down (▷ page 135).

### Maximum cooling MAX COOL

The MAX COOL function is only available in vehicles for the USA.



MAX COOL is only operational when the engine is running.

When you activate MAX COOL, climate control switches to the following functions:

- maximum cooling
  - maximum airflow
  - air-recirculation mode on
- ▶ **To activate:** press the  button. The indicator lamp above the button lights up.
- ▶ **To deactivate:** press the  button again. The indicator lamp goes out. The previously selected settings come into effect again.





### Defrosting the windows

#### Windows fogged up on the inside

- ▶ Activate the "cooling with air dehumidification" function .
- ▶ Activate automatic mode .
- ▶ If the windows continue to fog up, activate the defrosting function (▷ page 141).

**i** You should only select this setting until the windshield is clear again.

#### Windows fogged up on the outside

- ▶ Switch on the windshield wipers.
- ▶ **Dual-zone automatic climate control:** press switch (10) up or down (▷ page 133) until the  or  symbol appears in the display.
- ▶ **3-zone automatic climate control:** press switch (13) up or down (▷ page 135) until the  or  symbol appears in the display.

**i** You should only select this setting until the windshield is clear again.



### Rear window heating

#### Activating/deactivating

#### Warning

Any accumulation of snow and ice should be removed from the rear window before driving. Visibility could otherwise be impaired, endangering you and others.

The rear window heating has a high current draw. You should therefore switch it off as soon as the window is clear as it only switches off automatically after several minutes. If the battery voltage is too low, the rear window heating may switch off.

- ▶ Turn the SmartKey to position **2** in the ignition lock.
- ▶ Press the  button. The indicator lamp above the  button lights up or goes out.

#### Problems with the rear window heating

The rear window heating has deactivated itself prematurely or cannot be activated.

- ▶ Switch off any consumers that are not required, e.g. reading lamps or interior lighting. When the battery is sufficiently charged, the rear window heating is activated again automatically.





### Activating/deactivating air-recirculation mode





You can deactivate the flow of fresh air if unpleasant odors are entering the vehicle from outside. The air already inside the vehicle will then be recirculated.

The operation of the air-recirculation mode is the same for all control panels.

#### Warning

Fogged windows impair visibility, endangering you and others. If the windows begin to fog on the inside, switching off the air recirculation mode immediately should clear interior window fogging. If interior window fogging persists, make sure the air conditioning is activated, or press the  button.





- ▶ Turn the SmartKey to position **2** in the ignition lock.
- ▶ **To activate:** press the  button. The indicator lamp above the  button lights up.
- ▶ **To deactivate:** press the  button. The indicator lamp above the  button goes out.

- ▶ **To activate:** press the  button. The indicator lamp above the  button lights up.
  - ▶ **To deactivate:** press the  button. The indicator lamp above the  button goes out.
- ▶ **Information:**
    - ▶ Air-recirculation mode switches off automatically:
      - after approximately five minutes if outside temperatures are under about 41 °F (5 °C)
      - after approximately five minutes if cooling with air dehumidification is deactivated
      - after approximately 30 minutes if outside temperatures are over about 41 °F (5 °C)

### Switching the residual heat on/off

Only 3-zone automatic climate control in vehicles in Canada features the "residual heat" function.

It is possible to make use of the residual heat of the engine to continue heating the stationary vehicle for up to 30 minutes after the engine has been switched off. The heating time depends on the temperature that has been set.

- ▶ **Information:**
  - ▶ The blower will run at a low speed regardless of the airflow setting.
  - ▶ If you activate the "residual heat" function at high temperatures, only the ventilation will be activated. The blower runs at medium speed.
  - ▶ It is possible that the "residual heat" function may be activated automatically an hour after the SmartKey is removed. The vehicle is then ventilated for 30 minutes to dry the air-conditioning system.
- ▶ Turn the SmartKey to position **0** in the ignition lock or remove it.
- ▶ **To switch on:** press the  button. The indicator lamp above the  button lights up.
- ▶ **To switch off:** press the  button. The indicator lamp above button  goes out.

- i** Residual heat is deactivated automatically:
- after about 30 minutes
  - when the ignition is switched on
  - if the battery voltage drops
  - if the coolant temperature is too low

## Setting the air vents

### Important safety notes

#### **⚠ Warning**

When operating the climate control, the air that enters the passenger compartment through the air vents can be very hot or very cold (depending on the set temperature). This could cause burns or frostbite to unprotected skin in the immediate area of the air vents.

Always keep sufficient distance between unprotected parts of the body and the air vents. If necessary, use the air distribution adjustment to direct the air to air vents in the vehicle interior that are not in the immediate area of unprotected skin.

In order to ensure the direct flow of fresh air through the air vents into the vehicle interior, please observe the following notes:

- keep the air inlet between the windshield and the hood free of blockages, such as ice, snow or leaves
- never cover the vents or air inlet and outlet grilles in the vehicle interior.

- i** For virtually draft-free ventilation, adjust the sliders of the air vents to the center position.

### Setting the center air vents

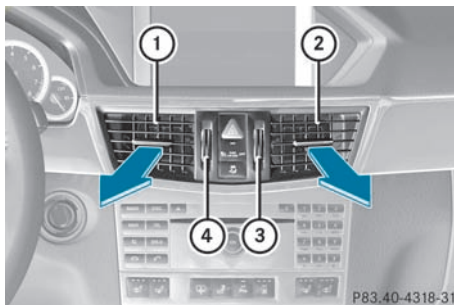

- ① Center air vent, left
- ② Center air vent, right
- ③ Center vent thumbwheel, right
- ④ Center vent thumbwheel, left

► **To open/close:** turn thumbwheels ③ and ④ up or down.

### Setting the side air vents

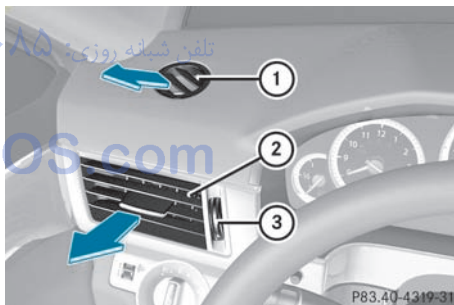

► **To open/close:** turn thumbwheel ③ up or down.

- i** Side window defroster vent ① is never completely shut, even if side air vent ② is shut.

### Setting the air vent in the glove box

When automatic climate control is activated, the glove box can be ventilated, for instance to cool its contents. The level of airflow

depends on the airflow and air distribution settings.

**!** Close the air vent when heating the vehicle.

At high outside temperatures, open the air vent and activate the "cooling with air dehumidification" function. Otherwise, temperature-sensitive items stored in the glove box could be damaged.

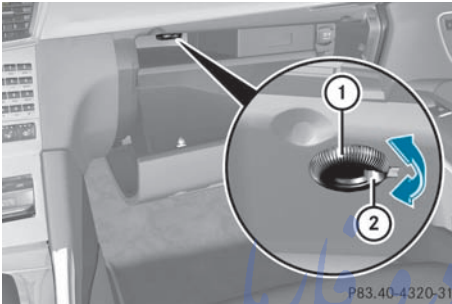

- ① Air vent thumbwheel
- ② Air vent

► **To open/close:** turn thumbwheel ① clockwise or counter-clockwise.

- ③ Rear control panel for 3-zone automatic climate control<sup>18</sup>
- ④ Rear-compartment air vent, left

► **To open/close:** turn thumbwheel ① up or down.

### Setting the rear-compartment side air vents

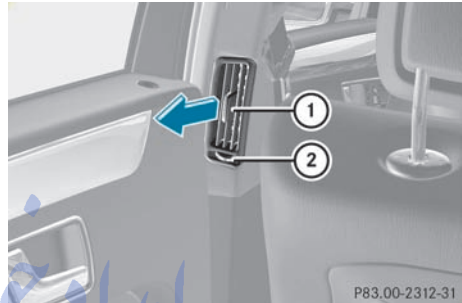

- ① B-pillar air vent
- ② Thumbwheel for B-pillar air vent

► **To open/close:** turn thumbwheel ② to the left or right.

### Setting the rear-compartment air vents

#### Setting the center vents in the rear compartment

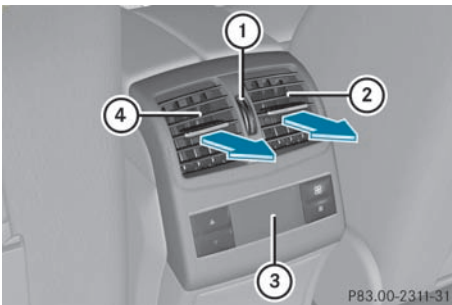

- ① Rear-compartment air vent thumbwheel
- ② Rear-compartment air vent, right

<sup>18</sup> For Canada only.



# امداد خودرو فارما

تلفن شبانه روزی: ۰۲۱-۸۸۸۶۲۰۸۵

**FarmaSOS.com**

Vehicle equipment .....	148
Notes on breaking-in a new vehicle .....	148
Driving .....	148
Automatic transmission .....	154
Refueling .....	162
Parking .....	169
Driving tips .....	171
Driving systems .....	177

# امداد خودرو فارما

تلفن شبانه روزی: ۰۲۱-۸۸۸۶۲۰۸۵

[FarmaSOS.com](http://FarmaSOS.com)

## Vehicle equipment

- i** This manual describes all the standard and optional equipment of your vehicle which was available at the time of purchase. Country-specific differences are possible. Bear in mind that your vehicle may not feature all functions described here. This also refers to safety-related systems and functions.

## Notes on breaking-in a new vehicle

### The first 1000 miles (1500 km)

The more you look after the engine when it is new, the happier you will be with its performance in the future.

- Drive at varying vehicle speeds and engine speeds for the first 1000 miles (1500 km) for this reason.
- Avoid overstraining the vehicle during this period, e.g. driving at full throttle.
- Change gear in good time, at the latest when the tachometer needle is  $\frac{2}{3}$  of the way to the red area in the tachometer display.
- If possible, do not depress the accelerator pedal past the point of resistance (kickdown).
- Only select shift ranges **3**, **2** or **1** when driving slowly, e.g. in mountainous terrain.

After 1000 miles (1500 km) you may gradually bring the vehicle up to full road and engine speeds.

Additional breaking-in notes for AMG vehicles:

- For the first 1000 miles (1500 km), do not exceed a speed of 85 mph (140 km/h).
- Only allow the engine to briefly reach a maximum engine speed of 4500 rpm.
- Shift gears in good time.

- i** Also observe these breaking-in notes when the vehicle's engine or axle gear have been replaced.

- i** Always observe the respective limit speeds.

### AMG vehicles with rear axle locking differential

Your vehicle is equipped with a self-locking differential on the rear axle. Change the oil after a breaking-in period of 2000 miles (3000 km) to improve protection of the rear axle differential. This oil change extends the service life of the differential. Have the oil change carried out at a qualified specialist workshop. Mercedes-Benz recommends that you use an authorized Mercedes-Benz Center for this purpose.

## Driving

### Important safety notes

#### Warning

Make sure absolutely no objects are obstructing the pedals' range of movement. Keep the driver's footwell clear of all obstacles. If there are any floor mats or carpets in the footwell, make sure the pedals still have sufficient clearance.

During sudden driving or braking maneuvers the objects could get caught between the pedals. You could then no longer brake or accelerate. This could lead to accidents and injury.

#### Warning

On slippery road surfaces, never downshift in order to obtain braking action. This could result in drive wheel slip and reduced vehicle control. Your vehicle's ABS will not prevent this type of loss of control.

### Warning

It is dangerous to shift the automatic transmission out of parking position **P** or neutral position **N** if the engine speed is higher than idle speed. If your foot is not firmly on the brake pedal, the vehicle could accelerate quickly forward or in reverse. You could lose control of the vehicle and hit someone or something. Only shift into gear when the engine is idling normally and when your right foot is firmly on the brake pedal.

**!** Warm up the engine quickly. Do not use the engine's full performance until it has reached operating temperature.

Only shift the automatic transmission to the desired drive position when the vehicle is stationary.

Where possible, avoid spinning the drive wheels when pulling away on slippery roads. You could otherwise damage the drive train.

**!** AMG vehicles: at low engine oil temperatures (below 68 °F (+20 °C), the maximum engine speed is restricted in order to protect the engine. To protect the engine and maintain smooth engine operation, avoid driving at full throttle when the engine is cold.

### SmartKey positions

#### SmartKey

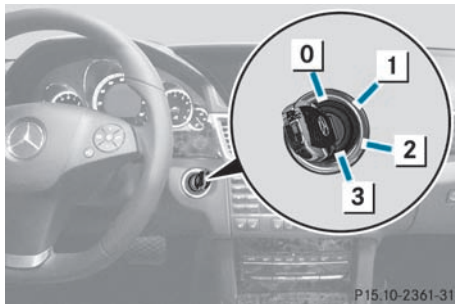

**0** To remove the SmartKey

(shift the transmission to position **P**)

- 1** Power supply for some consumers, such as the windshield wipers
- 2** Ignition (power supply for all consumers) and drive position
- 3** To start the engine

Once the ignition is switched on, all the indicator lamps in the instrument cluster light up. The indicator lamps of the low-beam headlamps, high-beam headlamps, turn signal lamps or front fog lamps only light up if the low-beam headlamps, high-beam headlamps, turn signal lamps or front fog lamps are switched on. If an indicator lamp does not light up when the ignition is switched on, check it and replace it if necessary. If an indicator lamp does not go out after starting the engine or lights up while the vehicle is in motion, see (▷ page 263).

If the SmartKey is in position **0** in the ignition lock for an extended period of time, it can no longer be turned in the ignition lock. The steering is then locked. To unlock, remove the SmartKey and reinsert it in the ignition lock. The steering is locked when you remove the SmartKey from the ignition lock.

- ▶ Remove the SmartKey when the engine is switched off.  
The battery may otherwise discharge.

If you cannot turn the SmartKey in the ignition lock, the vehicle battery may not be charged sufficiently.

- ▶ Check the vehicle battery and charge if necessary (▷ page 340).

or

- ▶ Jump-start the vehicle (▷ page 341).

**i** The SmartKey can be turned in the ignition lock even if it is not the correct SmartKey for the vehicle. The ignition is not switched on. The engine cannot be started.

P15.10-2361-31

## KEYLESS-GO

Vehicles with KEYLESS-GO are equipped with a SmartKey with an integrated KEYLESS-GO function and a detachable Start/Stop button.

The Start/Stop button must be inserted in the ignition lock and the SmartKey must be in the vehicle.

Pressing the Start/Stop button several times in succession corresponds to the different key positions in the ignition lock. This is only the case if you are not depressing the brake pedal.

If you depress the brake pedal and press the Start/Stop button, the engine starts immediately.

The Start/Stop button can be removed from the ignition lock. Then you can insert the SmartKey in the ignition lock.

**i** You do not have to remove the Start/Stop button from the ignition lock when you leave the vehicle. However, you should always take the SmartKey with you when leaving the vehicle. The vehicle can be started with the Start/Stop button and the electrical equipment can be operated while the SmartKey is in the vehicle.



① Start/Stop button

② Ignition lock

▶ Insert Start/Stop button ① into ignition lock ②.

**i** When you insert Start/Stop button ① into ignition lock ②, the system requires a

detection time of two seconds before you can use Start/Stop button ①.

▶ Shift the transmission to position **P**.

▶ Do not press the brake pedal.

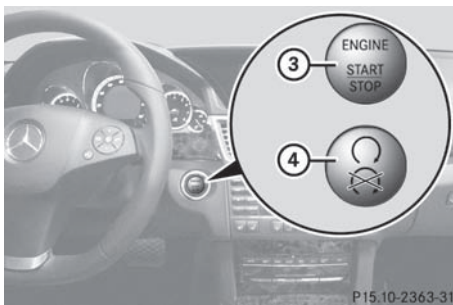

Start/Stop button

③ USA only

④ Canada only

▶ Position **0**: if Start/Stop button ① has not yet been pressed, this corresponds to the SmartKey being removed from the ignition.

▶ Position **1**: press Start/Stop button ①. You can now activate the windshield wipers, for example.

**i** If you then open the driver's door when in this position, the power supply is deactivated.

▶ Position **2** (ignition): press Start/Stop button ① twice.

**i** If you press Start/Stop button ① once when in this position and the driver's door is open, the power supply is deactivated again.

As soon as the ignition is switched on, all the indicator lamps in the instrument cluster light up. The indicator lamps of the low-beam headlamps, high-beam headlamps, turn signal lamps or front fog lamps only light up if the low-beam headlamps, high-beam headlamps, turn signal lamps or front fog lamps are switched on. If an indicator lamp does not light up when the ignition is switched on, check it and replace it if necessary. If an

indicator lamp does not go out after the engine is started or if it lights up while the vehicle is in motion, see (> page 263).

## Starting the engine

### Important safety notes

#### Warning

Inhalation of exhaust gas is hazardous to your health. All exhaust gas contains carbon monoxide (CO), and inhaling it can cause unconsciousness and possible death.

Do not run the engine in confined areas (such as a garage) which are not properly ventilated. If you think that exhaust gas fumes are entering the vehicle while driving, have the cause determined and corrected immediately. If you must drive under these conditions, drive only with at least one window fully open at all times.

 Do not depress the accelerator pedal when starting the engine.

### Automatic transmission

▶ Shift the transmission to position **P**.

 The transmission position display in the multifunction display shows **P**.

### Starting procedure with the SmartKey

▶ **To start a gasoline engine:** turn the SmartKey to position **3** in the ignition lock (> page 149) and release it as soon as the engine is running.

▶ **To start a diesel engine:** turn the SmartKey to position **2** in the ignition lock (> page 149).

The  preglow indicator lamp in the instrument cluster lights up.

▶ When the  preglow indicator lamp goes out, turn the SmartKey to position **3** (> page 149) and release it as soon as the engine is running.

 You can start the engine without preglow if the engine is warm.

### Using KEYLESS-GO to start the engine

#### Warning!

As long as the SmartKey is in your vehicle, the vehicle can be started. Therefore, never leave children unattended in the vehicle, as they could otherwise accidentally start the engine.

When leaving the vehicle, always take the SmartKey with you and lock the vehicle. Do not leave children unattended in the vehicle, or with access to an unlocked vehicle. A child's unsupervised access to a vehicle could result in an accident and/or serious personal injury.

 The Start/Stop button can be used to start the vehicle without inserting the SmartKey in the ignition lock. The SmartKey must be in the vehicle.

▶ The Start/Stop button must be inserted in the ignition lock.

 To start the engine with the SmartKey instead of with KEYLESS-GO, remove the Start/Stop button from the ignition lock.

▶ Depress the brake pedal and keep it depressed.

▶ **To start a gasoline engine:** press the Start/Stop button (> page 150) once. The engine starts.

▶ **To start a diesel engine:** press the Start/Stop button (> page 150) once. Preglow is activated and the engine starts.

 If the engine is warm, the preglow time is shortened.

### Pulling away

### Automatic transmission

#### Warning

It is dangerous to shift the automatic transmission out of parking position **P** or

neutral position **N** if the engine speed is higher than idle speed. If your foot is not firmly on the brake pedal, the vehicle could accelerate quickly forward or in reverse. You could lose control of the vehicle and hit someone or something. Only shift into gear when the engine is idling normally and when your right foot is firmly on the brake pedal.

**i** It is only possible to shift the transmission from position **P** to the desired position if you depress the brake pedal. Only then is the parking lock released. If you do not depress the brake pedal, you can move the DIRECT SELECT selector lever but the parking lock remains engaged.

- ▶ Depress the brake pedal and keep it depressed.
- ▶ Shift the transmission to position **D** or **R**.
- ▶ Wait until the gear change is completed before pulling away.
- ▶ Release the parking brake (▷ page 170).
- ▶ Release the brake pedal.
- ▶ Carefully depress the accelerator pedal.

**!** If a warning tone sounds and the Release Park. Brake message appears in the instrument cluster, the parking brake is still applied. Release the parking brake.

**i** The vehicle locks centrally once you have pulled away. The locking knobs in the doors drop down.

You can open the doors from the inside at any time.

You can also deactivate the automatic locking feature (▷ page 231).

**i** Upshifts take place at higher engine speeds after a cold start. This helps the catalytic converter to reach its operating temperature more quickly.

have removed your foot from the brake pedal. This gives you enough time to move your foot from the brake pedal to the accelerator pedal and depress it before the vehicle begins to roll.

#### **Warning**

Never leave the vehicle when it is held by hill start assist. After approximately one second, hill start assist will no longer brake your vehicle and it could roll away.

- ▶ Take your foot off the brake pedal.
- i** Once you have taken your foot off the brake pedal, the vehicle is held for around one second.
- ▶ Pull away.

Hill start assist will not function if:

- you are pulling away on a level road or a downhill gradient.
- the transmission is in position **N**.
- the parking brake is applied.
- ESP® is malfunctioning.

## Hill start assist

Hill start assist helps you when pulling away forwards or in reverse on an uphill gradient. It holds the vehicle for a short time after you



**Problems with the engine**

Problem	Possible causes/consequences and ► Solutions
<p>The engine does not start. The starter motor can be heard.</p>	<ul style="list-style-type: none"> <li>• There is a malfunction in the engine electronics.</li> <li>• There is a malfunction in the fuel supply.</li> </ul> <p>► Turn the SmartKey back to position <b>0</b> in the ignition lock before the next attempt to start with the SmartKey.</p> <p>► Before the next starting attempt with KEYLESS-GO: shut all open vehicle doors so that the signals from the SmartKey may be better received.</p> <p>or</p> <p>► Pull the Start/Stop button out of the ignition.</p> <p>► Use the SmartKey to start the engine, (► page 151) as external radio signals cause KEYLESS-GO to malfunction. Avoid excessively long and frequent attempts to start the engine as these will drain the battery.</p> <p>If the engine does not start after several attempts:</p> <p>► Consult a qualified specialist workshop.</p>
<p>The engine does not start. You cannot hear the starter motor.</p>	<p>The on-board voltage is too low because the starter battery is too weak or discharged.</p> <p>► Jump-start the vehicle (► page 341).</p> <p>If the engine does not start despite attempts to jump-start it:</p> <p>► Consult a qualified specialist workshop.</p> <p>The starter motor was exposed to a thermal load that was too high.</p> <p>► Allow the starter motor to cool down for approximately two minutes.</p> <p>► Try to start the engine again.</p> <p>If the engine still does not start:</p> <p>► Consult a qualified specialist workshop.</p>

www.FarmanSOS.com

www.FarmanSOS.com

Problem	Possible causes/consequences and ► Solutions
Vehicles with a gasoline engine: The engine is not running smoothly and is misfiring.	There is a malfunction in the engine electronics or a mechanical component of the engine management system. ► Only depress the accelerator pedal slightly. ► Have the cause rectified immediately at a qualified specialist workshop. Otherwise, non-combusted fuel may get into the catalytic converter and damage it.
The coolant temperature gauge shows a value above 248 °F (120 °C).	The coolant level is too low. The coolant is too hot and the engine is no longer being cooled sufficiently. ► Stop as soon as possible and allow the engine and the coolant to cool down. ► Check the coolant level (> page 311). Observe the warning notes as you do so and add coolant if necessary.

## Automatic transmission

### Important safety notes

#### ⚠ Warning

It is dangerous to shift the automatic transmission out of parking position **P** or neutral position **N** if the engine speed is higher than idle speed. If your foot is not firmly on the brake pedal, the vehicle could accelerate quickly forward or in reverse. You could lose control of the vehicle and hit someone or something. Only shift into gear when the engine is idling normally and when your right foot is firmly on the brake pedal.

#### ⚠ Warning!

Keep in mind that turning off the engine alone only will shift the automatic transmission into neutral position **N** automatically.

Always shift the automatic transmission into park position **P** before turning off the engine. Otherwise the vehicle could roll away which could result in an accident and/or serious personal injury.

## Selector lever

### Overview of transmission positions

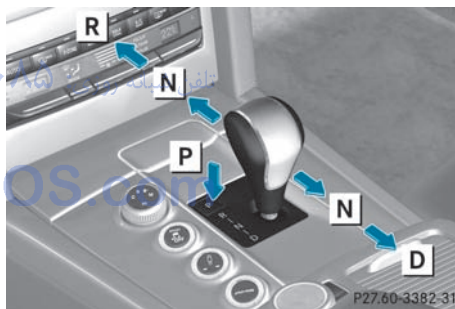

Selector lever in AMG vehicles with P button

P Park position with parking lock

R Reverse

N Neutral

D Drive

## Transmission position display

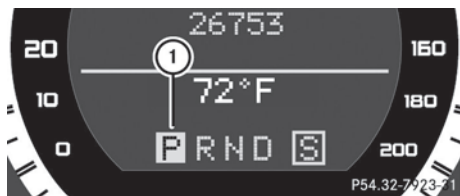

### ① Transmission position display

The displays light up when the SmartKey is inserted in the ignition lock. The displays go out when the SmartKey is removed from the ignition lock.

**AMG vehicles:** displays on the cover beside the selector lever also indicate the current position of the selector lever.

**!** If the transmission position display in the multifunction display is not working, you should pull away carefully to check whether the desired transmission position is engaged. Ideally, you should select transmission position **D** and drive program **E**. Do not restrict the shift range.

## Drive program display

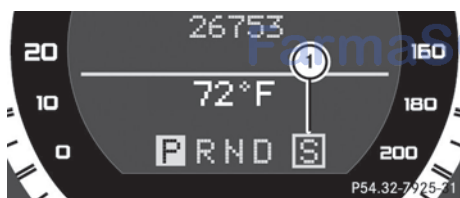

### ① Drive program display

## DIRECT SELECT lever

### Overview of transmission positions

The DIRECT SELECT lever is on the right of the steering column.



P Park position with parking lock

R Reverse

N Neutral

D Drive

**i** The DIRECT SELECT lever always returns to its original position. The current transmission position **P**, **R**, **N** or **D** appears in the transmission position display (▷ page 155) in the multifunction display.

## Transmission position display



### ① Transmission position display

**i** The arrows in the transmission position display show how and into which transmission positions you can change using the DIRECT SELECT lever.

## Engaging park position P

► Push the DIRECT SELECT lever in the direction of the arrow **P**.

**i** The automatic transmission shifts automatically into park position **P** if you open the driver's door when the vehicle is stationary or at very low speed and the transmission is in position **D** or **R**. This function depends on the date of manufacture of your vehicle.

**!** If the engine speed is too high or the vehicle is moving, do not shift the automatic transmission directly from **D** to **R**, from **R** to **D** or directly to **P**. The automatic transmission could otherwise be damaged.

HOLD function or DISTRONIC PLUS: if you brake the vehicle using the HOLD function or DISTRONIC PLUS, the automatic transmission shifts to transmission position **P** automatically. In addition, at least one of the following conditions must be fulfilled:

- the engine is switched off.
- the driver's door is open and the seat belt is not in the buckle.

### Shifting to park position P in AMG vehicles



- ▶ When the vehicle is stationary, press button **P** ①.

### Engaging reverse gear R

**!** Only shift the automatic transmission to **R** when the vehicle is stationary.

- ▶ When the vehicle is stationary, depress the brake pedal.
- ▶ Push the DIRECT SELECT lever up past the first point of resistance.

### Shifting to neutral N

- ▶ When the vehicle is stationary, depress the brake pedal.
- ▶ Push the DIRECT SELECT lever up or down to the first point of resistance.

When the engine is switched off, the automatic transmission shifts to **N** automatically.

### Remaining in neutral N

If you wish to keep the automatic transmission in neutral **N**, e.g. to wash the vehicle in a car wash with a towing device, observe the following:

#### **⚠ Warning!**

When leaving the SmartKey in the starter switch, do not leave children unattended in the vehicle. It is possible for children to switch on the ignition which could result in unsupervised use of vehicle equipment. Unsupervised use of vehicle equipment could result in an accident and/or serious personal injury.

### Using the SmartKey:

- make sure the ignition is switched on.
- when the vehicle is stationary, depress the brake pedal and keep it depressed.
- shift to neutral **N**.
- release the brake pedal.
- if applied, release the parking brake.
- switch off the ignition and leave the SmartKey in the ignition lock.

### Using KEYLESS-GO:

- make sure the ignition is switched on.
- when the vehicle is stationary, depress the brake pedal and keep it depressed.
- shift to park position **P**.
- release the brake pedal.
- remove the Start/Stop button from the ignition lock.
- insert the SmartKey into the ignition lock.
- switch on the ignition.

- depress the brake pedal and keep it depressed.
- shift to neutral **N**.
- release the brake pedal.
- if applied, release the parking brake.
- switch off the ignition and leave the SmartKey in the ignition lock.

### Shifting to transmission position **D**

- ▶ When the vehicle is stationary, depress the brake pedal.
- ▶ Push the DIRECT SELECT lever down past the first point of resistance.

### Transmission positions

**P**

#### Park position

Do not shift the transmission into position **P** unless the vehicle is stationary. The parking lock should not be used as a brake when parking. In addition to engaging the parking lock, you must always apply the parking brake to secure the vehicle.

The SmartKey can only be removed if the transmission is in position **P**. If the SmartKey is removed from the ignition lock, the selector lever is locked.

In the event of a fault in the vehicle electronics, the transmission can be locked in position **P**.

Have the vehicle electronics checked immediately at a qualified specialist workshop, e.g. an authorized Mercedes-Benz Center.

**R**

#### Reverse

Only shift the transmission to **R** when the vehicle is stationary.

**N**

#### Neutral

Do not shift the transmission to **N** while driving. The transmission could otherwise be damaged.

No power is transmitted from the engine to the drive wheels.

Releasing the brakes will allow you to move the vehicle freely, e.g. to push it or tow it.

If ESP<sup>®</sup> is deactivated or faulty: only shift the transmission to position **N** if the vehicle is in danger of skidding, e.g. on icy roads.

**!** Driving in neutral **N** can damage the drive train.

**D**

#### Drive

The automatic transmission changes gear automatically. All forward gears are available.

### Gearshifting

The automatic transmission shifts to the individual gears automatically when it is in transmission position **D**. This automatic gearshifting behavior is determined by:

- a shift range restriction, if selected
- the selected drive program  
**E/S** or **M** (AMG vehicles) (▷ page 158)
- the position of the accelerator pedal
- the road speed

### Driving tips

#### AMG vehicles

When shifting down, the double-clutch function is active regardless of the currently selected drive program. The double-clutch function reduces load change reactions and is conducive to a sporty driving style. The sound generated by the double-clutch

function depends on the drive program selected.

### Kickdown

Use kickdown for maximum acceleration.

► **Vehicles for USA except AMG vehicles:** fully depress the accelerator pedal.

The transmission shifts to a lower gear depending on the engine speed.

► **Vehicles for Canada except AMG vehicles:** depress the accelerator pedal beyond the pressure point.

The transmission shifts to a lower gear depending on the engine speed.

### Rocking the vehicle free

Rocking the vehicle free by repeatedly shifting back and forth between transmission positions **D** and **R** can help to free a vehicle that has become stuck in mud or snow. The engine management system of the vehicle limits shifting back and forth between transmission positions **D** and **R** to a maximum speed of 5 mph (9 km/h). To shift back and forth between transmission positions **D** and **R**, move the selector lever up and down beyond the pressure point.

### Working on the vehicle

#### Warning

When working on the vehicle, engage the parking brake and shift the automatic transmission into park position **P**. Otherwise the vehicle could roll away which could result in an accident and/or serious personal injury.

### Program selector button

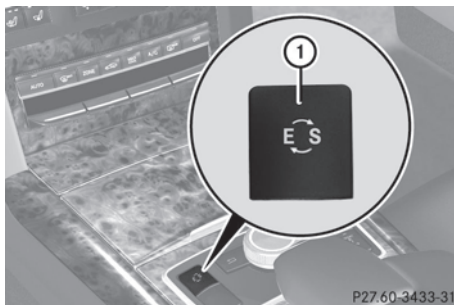

Program selector button on all models except AMG vehicles

<b>E</b> Economy	Comfortable, economical driving
<b>S</b> Sport	Sporty driving style

**i** For further information on "Automatic drive program" (> page 159).

► Press program selector button **1** repeatedly until the letter for the desired gearshift program appears in the multifunction display.

**i** The automatic transmission switches to automatic drive program **E** each time the engine is started.

### AMG vehicles



Program selector with manual drive program

<b>C</b> Comfort	Comfortable, economical driving
<b>S</b> Sport	Sporty driving style
<b>S+</b> SportPlus	Extremely sporty driving style
<b>M</b> Manual	Manual gearshifting
<b>RS RACE START</b>	Optimal vehicle acceleration from a standstill

**i** For further information on "Drive program" (▷ page 159).

Only change from automatic drive program **C**, **S** or **S+** to manual drive program **M** when the vehicle is stationary.

▶ Turn program selector **1** until the desired drive program appears in the multifunction display in the speedometer.

The drive program indicator on program selector **1** lights up in red.

**i** The automatic transmission switches to automatic drive program **C** each time the engine is started.

**i** **RS** cannot be selected during normal driving. For further information on RACE START (▷ page 190).

You can restrict or derestrict the shift range by using the steering wheel paddle shifters. You can change gear yourself by using the steering wheel paddle shifters in the manual drive program.

In the automatic drive program, you can restrict or derestrict the shift range by using the steering wheel paddle shifters (▷ page 159).

**i** You can only change gear with the steering wheel paddle shifters when the transmission is in position **D**.

### Automatic drive program

Drive program **E** (drive program **C** on AMG vehicles) is characterized by the following:

- the vehicle pulling away more gently in forward and reverse gears, unless the accelerator pedal is depressed fully
- increased sensitivity, which improves driving stability on slippery road surfaces, for example
- the automatic transmission shifting up sooner, which results in the vehicle being driven at lower engine speeds and the wheels being less likely to spin

In drive program **S**, the automatic transmission shifts up later.

### Steering wheel paddle shifters

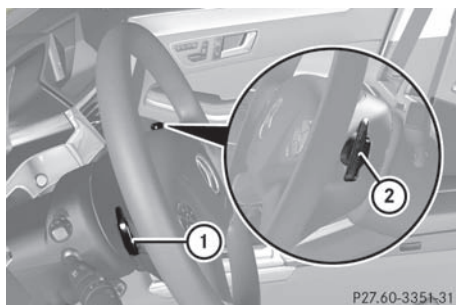

P27.60-3354-31

- 1** Left-hand steering wheel paddle shifter
- 2** Right-hand steering wheel paddle shifter

### Shift ranges

#### Introduction

When the automatic transmission is in position **D**, it is possible to restrict or derestrict the shift range (▷ page 159).

The shift range selected is shown in the multifunction display. The automatic transmission shifts only as far as the selected gear.

#### Driving situations

- 3** You can use the engine's braking effect.



**2** To use the braking effect of the engine on downhill gradients and for driving:

- on steep mountain roads
- in mountainous terrain
- in arduous conditions

**1** To use the braking effect of the engine on extremely steep downhill gradients and on long downhill stretches

### Restricting the shift range

- ▶ Pull the left-hand steering wheel paddle shifter.  
The shift range is restricted.
- i** In order to prevent the engine from overrevving, the automatic transmission does not shift down when the engine speed is too high.
- i** If the maximum engine speed for the shift range is reached and you continue to accelerate, the automatic transmission shifts up in order to prevent the engine from overrevving, even if the shift range is restricted.

### Derestricting the shift range

- ▶ Pull the right-hand steering wheel paddle shifter.  
The shift range is derestricted.

### Clearing the shift range restriction

- ▶ Pull and hold the right-hand steering wheel paddle shifter until **D** is shown again in the multifunction display.  
The automatic transmission shifts from the current shift range directly to **D**.

### Selecting the ideal shift range

- ▶ Pull the left-hand steering wheel paddle shifter and hold it in position.  
The automatic transmission shifts to the gear which allows ideal acceleration and deceleration. To do this, the automatic transmission shifts down one or more gears.

### Manual drive program

#### Switching on the manual drive program

The manual drive program is only available for AMG vehicles.

Manual drive program **M** is different from drive programs **S** and **S+** with regard to spontaneity, responsiveness and smoothness of gear changes.

Manual drive program **M** can be selected using the program selector button. You can change gear using the steering wheel paddle shifters in manual drive program **M** if the transmission is in position **D**. The gear currently selected and engaged is shown in the multifunction display.

- ▶ **AMG vehicles:** turn the program selector (▷ page 158) until **M** appears in the multifunction display.

The indicator **M** on the program selector lights up in red.

### Upshifting

- !** In manual drive program **M**, the automatic transmission does not shift up automatically even when the engine limiting speed for the current gear is reached. When the engine limiting speed is reached, the fuel supply is cut to prevent the engine from overrevving. Always make sure that the engine speed does not reach the red area of the tachometer. There is otherwise a risk of engine damage.

- ▶ Pull the right-hand steering wheel paddle shifter (▷ page 159).

The automatic transmission shifts up to the next gear.

Before the engine speed reaches the red area, you will see an upshift indicator in the multifunction display.

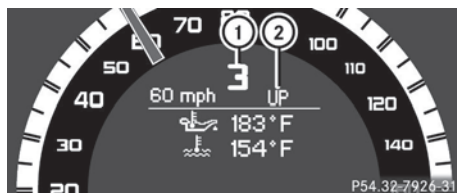

- ① Gear indicator
- ② Upshift indicator

### Downshifting

- ▶ Pull the left-hand steering wheel paddle shifter (▷ page 159).

The automatic transmission shifts down to the next gear.

- ⓘ If you brake the vehicle or stop without shifting down, the automatic transmission will shift down to a gear that will allow the vehicle to accelerate or pull away again.

### Kickdown

- ⓘ Kickdown is not possible in manual drive program **M**.

### Switching off the manual drive program

- ▶ **AMG vehicles:** turn the program selector (▷ page 158) until **C** or **S** appears in the multifunction display.

### Problems with the transmission

Problem	Possible causes/consequences and ► Solutions
The acceleration ability is deteriorating. The transmission no longer changes gear.	<p>The transmission is in emergency mode. It is only possible to shift into <b>2nd</b> gear and reverse gear.</p> <ul style="list-style-type: none"> <li>► Stop the vehicle.</li> <li>► Shift the transmission to position <b>P</b>.</li> <li>► Switch off the engine.</li> <li>► Wait at least 10 seconds before restarting the engine.</li> <li>► Shift the transmission to position <b>D</b> or <b>R</b>. If <b>D</b> is selected, the transmission shifts into <b>2nd</b> gear; if <b>R</b> is selected, the transmission shifts into reverse gear.</li> <li>► Have the transmission checked at a qualified specialist workshop immediately.</li> </ul>

### Transfer case

This section is only valid for vehicles with 4-wheel drive (4MATIC). Power is always transmitted to both axles.

❗ Performance tests may only be carried out on a 2-axle dynamometer. The brake system or transfer case could otherwise be damaged. Contact an authorized Mercedes-Benz Center for a performance test. Mercedes-Benz recommends that you use an authorized Mercedes-Benz Center for this purpose.

❗ To prevent ESP® from intervening, the ignition must be switched off (SmartKey or the Start/Stop button in position **0** or **1**) if:

- the parking brake is being tested on a brake dynamometer.
- the vehicle is being towed with only one axle raised (not permitted for vehicles with 4MATIC).

The brake system could otherwise be damaged.

### Refueling

#### Important safety notes

#### Warning!

Gasoline and diesel fuels are highly flammable and poisonous. They burn violently and can cause serious injury.

Never allow sparks, flames or smoking materials near gasoline or diesel fuel!

Turn off the engine before refueling.

Whenever you are around gasoline or diesel fuel, avoid inhaling fumes and any skin or clothing contact. Extinguish all smoking materials.

Direct skin contact with fuels and the inhalation of fuel vapors are damaging your health.

#### Warning

Overfilling of the fuel tank may create pressure in the system which could cause a gas discharge. This could cause the gasoline to spray back out when removing the fuel pump nozzle, which could cause personal injury.

**Warning!**

Do not fill diesel tanks with gasoline. Do not mix diesel fuel with gasoline. Otherwise the fuel system and engine could be damaged. In addition, the vehicle could catch fire.

- ❗ Do not use gasoline to refuel vehicles with a diesel engine. Do not use diesel to refuel vehicles with a gasoline engine. Even small amounts of the wrong fuel result in damage to the fuel system and engine.
- ❗ Do not switch on the ignition if you accidentally refuel with the wrong fuel. Otherwise, the fuel will enter the fuel lines. Notify a qualified specialist workshop and have the fuel tank and fuel lines drained completely.

**Gasoline****Fuel grade**

- ❗ You should only refuel with unleaded premium-grade gasoline as this avoids damaging the catalytic converter.  
If engine running problems are apparent, have the cause checked immediately and repaired. Excess unburned fuel can otherwise enter the catalytic converter, leading to overheating and possibly causing a fire.
- i Only refuel with unleaded premium-grade gasoline with a specified minimum octane number of 91 (average value of 96 RON/ 86 MON).  
Usually you will find information about the fuel grade on the pump. If you cannot find the label on the gasoline pump, ask the gas station staff.  
You can find further information under "Fuel" (> page 388), by consulting an authorized Mercedes-Benz Center or visiting <http://www.mbusa.com> (USA only).

**Diesel****Fuel grade**

- ❗ Only refuel with ULTRA-LOW SULFUR DIESEL FUEL (ULSD, 15 ppm SULFUR MAXIMUM). Using other diesel fuels could result in increased wear and damage to the engine and/or exhaust system.  
Never refuel with marine diesel or heating oil.  
Do not mix these fuels with diesel fuels and do not use any special additives, as this may result in damage.
- ❗ Use a filter when adding fuel from a fuel can. Otherwise, the fuel lines and/or the fuel injection system could be blocked by particles from the fuel can.

i Refuel only with ULTRA-LOW SULFUR HIGHWAY DIESEL FUEL (ULSD, 15 ppm SULFUR MAXIMUM).

Usually you will find information about the fuel grade on the pump. If you cannot find the label on the gasoline pump, ask the gas station staff.

You can find further information under "Fuel" (> page 388), by consulting an authorized Mercedes-Benz Center or by visiting <http://www.mbusa.com> (USA only).

**Low outside temperatures**

- ❗ Do not use gasoline to refuel vehicles with a diesel engine. Never mix diesel with gasoline or kerosene, as this may result in damage to the engine or fuel system.  
Diesel fuel with improved cold flow properties is available during the winter months. Further information on fuel properties can be obtained from oil companies, e.g. at filling stations.

## Refueling

### Fuel filler flap

The fuel filler flap is unlocked or locked automatically when you open or close the vehicle with the SmartKey or using KEYLESS-GO.

The position of the fuel filler flap is to the rear on the right. The position of the fuel filler cap is displayed in the instrument cluster .

The arrow next to the gas pump indicates the side of the vehicle.

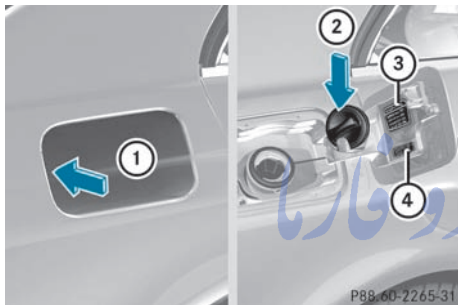

Example: Sedan

- ① To open the fuel filler flap
- ② To insert the fuel filler cap
- ③ Tire pressure table
- ④ Fuel type

### Opening

- ▶ Switch off the engine.

**i** When the engine is running and the fuel filler flap is open, the  engine diagnostics warning lamp may light up.

For further information on warning and indicator lamps in the instrument cluster, see (▶ page 268).

- ▶ Remove the SmartKey from the ignition lock.

KEYLESS-GO: the driver's door is open.

This returns the ignition to position **0**, which corresponds to the SmartKey being

removed. The driver's door can be closed again.

- ▶ Press the fuel filler flap in the direction of arrow ①.  
The fuel filler flap opens slightly.
- ▶ Open the fuel filler flap.
- ▶ Turn the fuel filler cap counter-clockwise and remove it.
- ▶ **Sedan:** insert the fuel filler cap into the bracket on the inside of fuel filler flap ②.

or

- ▶ **Wagon:** holding the fuel filler cap horizontally, insert it into the recesses in the fuel filler flap hinge arm from above.
- ▶ Completely insert the filler neck of the fuel pump nozzle into the tank and refuel.
- ▶ Only fill the tank until the pump nozzle switches off.

**!** Overfilling the fuel tank could damage the fuel system.

### Closing

- ▶ Replace the fuel filler cap and turn it clockwise. The fuel filler cap audibly engages.

**i** Close the fuel filler flap before locking the vehicle. A locking pin otherwise prevents the fuel filler flap from closing after the vehicle has been locked.

- ▶ Press the fuel filler flap closed until it engages audibly.

### Emergency fuel filler flap release

#### Warning!

Avoid contact with the vehicle walls as they may contain sharp edges. Otherwise, you could injure yourself while releasing the fuel filler flap.

The emergency release is located behind the side trim panel in the trunk/cargo compartment.

- ▶ **Sedan:** slide down the parcel net.
- ▶ Open the side trim.

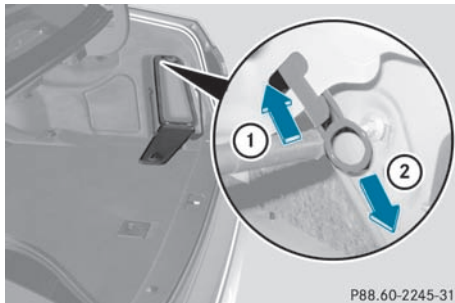

- ▶ Detach the emergency release from retainer ①.
- ▶ Pull the emergency release in the direction of arrow ②.  
The fuel filler flap is unlocked.
- ▶ Open the fuel filler flap.
- ▶ **Wagon:** open the side trim panel.
- ▶ Fold down the trim.

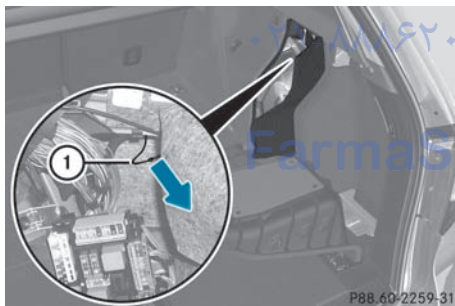

- ▶ Pull the emergency release in the direction of arrow ①.  
The fuel filler flap is unlocked.
- ▶ Open the fuel filler flap.

امداد خودرو فارما  
 تلفن شبانه روزی: ۰۲۱۸۸۶۲۰۸۵  
 Farma50S.com

## Problems with the fuel and fuel tank

Problem	Possible causes/consequences and ► Solutions
Fuel is leaking from the vehicle.	<p> <b>Risk of explosion or fire</b></p> <p>The fuel line or the fuel tank is defective.</p> <ul style="list-style-type: none"> <li>► Turn the key to position <b>0</b> (► page 149) in the ignition lock immediately and remove it.</li> <li>► Do not restart the engine under any circumstances.</li> <li>► Consult a qualified specialist workshop.</li> </ul>
The fuel filler flap cannot be opened.	<p>The fuel filler flap is not unlocked.</p> <p>or</p> <p>The key batteries are discharged.</p> <ul style="list-style-type: none"> <li>► Unlock the vehicle using the mechanical key (► page 79).</li> <li>► Open the trunk lid or the tailgate.</li> <li>► Manually unlock the fuel filler flap using the emergency release (► page 164).</li> </ul>

تلفن شبانه روزی: ۰۲۱-۸۸۸۶۲۰۸۵

FarmaSOS.com



Problem	Possible causes/consequences and ► Solutions
	<p>The fuel filler flap is unlocked, but the opening mechanism is jammed.</p> <ul style="list-style-type: none"> <li>► Manually unlock the fuel filler flap using the emergency release (▷ page 164).</li> <li>► Consult a qualified specialist workshop.</li> </ul>
<p>The engine will not start.</p>	<p>The fuel tank of a vehicle with a diesel engine has been run completely dry.</p> <ul style="list-style-type: none"> <li>► Refuel the vehicle with at least 5.3 US qt (5 liters) of diesel.</li> <li>► Turn the ignition on for at least 10 seconds (▷ page 149).</li> <li>► Start the engine continuously for up to 10 seconds until it runs smoothly.</li> </ul> <p>or</p> <ul style="list-style-type: none"> <li>► Start the engine via the touch-start function. To do this, turn the Smartkey to position <b>3</b> (▷ page 149) in the ignition lock and then release it immediately.</li> </ul> <p>If the engine does not start:</p> <ul style="list-style-type: none"> <li>► Turn the ignition on again for approximately 10 seconds (▷ page 149).</li> <li>► Start the engine again continuously for up to 10 seconds until it runs smoothly.</li> </ul> <p>or</p> <ul style="list-style-type: none"> <li>► Start the engine again via the touch-start function.</li> </ul> <p>If the engine does not start after three attempts:</p> <ul style="list-style-type: none"> <li>► Consult a qualified specialist workshop.</li> </ul>

## DEF

### Important notes on use

BlueTEC exhaust gas aftertreatment<sup>19</sup> must be operated with AdBlue<sup>®</sup> reducing agent in order to function properly. Adding AdBlue<sup>®</sup> is one of the tasks performed during maintenance. Under normal operating conditions, a tank of AdBlue<sup>®</sup> lasts until the next service due date.

When the AdBlue<sup>®</sup> supply has almost run out, the Check Additive See Operator's

Manual message is shown in the multifunction display.

When the AdBlue<sup>®</sup> supply sinks to a minimum level, the Remaining Starts: 20 message is shown in the multifunction display.

- i** When the Remaining Starts: 20 message is shown in the multifunction display, you can start the engine 20 more times. If AdBlue<sup>®</sup> is not topped up, it is then not possible to start the engine again. Top up the AdBlue<sup>®</sup> tank with approximately 1 gallon (3.8 l) AdBlue<sup>®</sup> or have the AdBlue<sup>®</sup> tank refilled at a qualified

<sup>19</sup> Only on BlueTEC vehicles.

specialist workshop, e.g. an authorized Mercedes-Benz Center.

Use the special AdBlue® refill bottle when adding between maintenance intervals. For more information, please contact an authorized Mercedes-Benz Center or Roadside Assistance if applicable (▷ page 21).

Further information about BlueTEC exhaust gas aftertreatment and AdBlue® is available at any authorized Mercedes-Benz Center.

### Adding AdBlue®

#### Warning!

Make sure

- AdBlue® does not come into contact with skin, eyes, or clothing
- to keep AdBlue® out of the reach of children

If you and/or others have come into contact with AdBlue®:

- If AdBlue® has gotten into contact with eyes, flush with plenty of water immediately and seek medical help.
- Clean affected skin immediately with plenty of water.
- If AdBlue® was swallowed, rinse mouth immediately with plenty of water and drink plenty of water. Consult a physician.

#### Warning!

When opening the filler cap of the AdBlue® tank ammonia gas vapors may escape. Refill AdBlue® in a well ventilated area only. Ammonia gas vapors have a pungent odor and are particularly irritating for your skin, mucous membranes, and eyes. Inhaling ammonia gas vapors will cause burning eyes, nose, and throat, as well as coughing and watering eyes.

**!** Only use AdBlue® that complies with ISO 22241. Do not add any special additives to AdBlue® and do not thin

AdBlue® with water. This could destroy the BlueTEC exhaust gas aftertreatment.

**!** Rinse surfaces that have come into contact with AdBlue® immediately with water or remove AdBlue® using a damp cloth and cold water. If the AdBlue® has already crystallized, use a sponge and cold water to clean it. AdBlue® residues crystallize after time and contaminate the affected surfaces.

**!** AdBlue® is not an additive and must not be added to the diesel tank. If AdBlue® is added to the diesel tank this could damage the engine.

**i** If you are adding between maintenance intervals, add approximately 1 gallon (3.8 l) of AdBlue® to the AdBlue® tank. 1 gallon (3.8 l) of AdBlue® is approximately 2 AdBlue® refill bottles.

Further information about AdBlue® (▷ page 390).

The AdBlue® filler neck is under the trunk floor.

- ▶ Switch off the ignition.
- ▶ Open the trunk.
- ▶ Lift the trunk floor (▷ page 285).

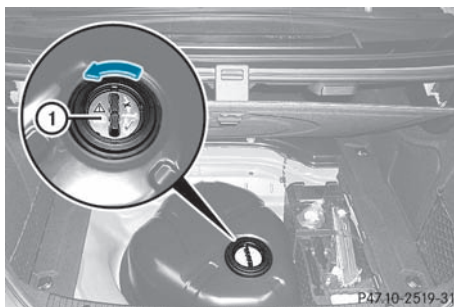

- ▶ Turn AdBlue® cap ① anti-clockwise and remove it.

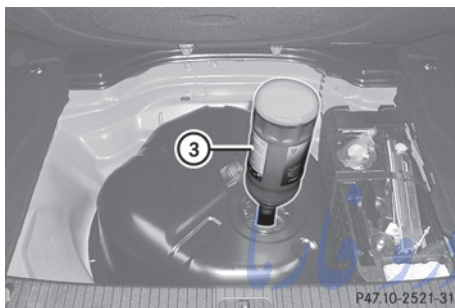
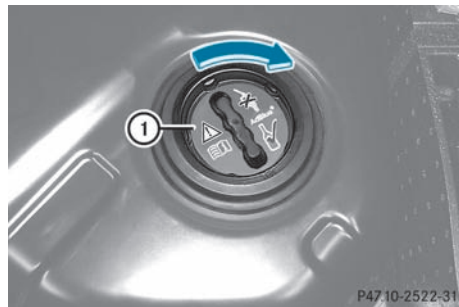
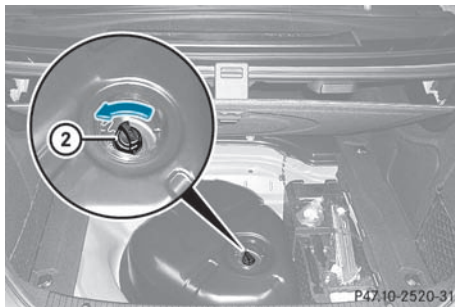

- ▶ Unscrew the covering cap from AdBlue® refill bottle (3).
- ▶ Place AdBlue® refill bottle (3) on the filler neck as shown and screw on clockwise hand-tight.
- ! Only screw on the AdBlue® refill bottle hand-tight. It could otherwise be damaged.
- ▶ Press AdBlue® refill bottle (3) down. The AdBlue® tank is filled. This may take up to one minute.
- i If the AdBlue® refill bottle is no longer pressed down, the filling process stops and the partially emptied bottle can be removed.
- ▶ Release AdBlue® refill bottle (3).
- ▶ Turn AdBlue® refill bottle (3) anti-clockwise and remove it.
- ▶ Place AdBlue® filler cap (2) on the filler neck and turn it clockwise.

- ▶ Insert AdBlue® cap (1) as shown and turn it clockwise as far as it will go.
- ▶ Fold the trunk floor down.
- ▶ Close the trunk lid.
- ▶ Drive at a speed above 10 mph (16 km/h). The Check Additive See Operator's Manual message disappears after approximately one minute.

- i If the Check Additive See Operator's Manual message is still displayed in the multifunction display, top up with another bottle of AdBlue®.
- i Then, have the AdBlue® supply checked and filled completely if necessary. Mercedes-Benz recommends that you use a qualified specialist workshop such as an authorized Mercedes-Benz Center for this purpose.

## Parking

### Important safety notes

#### ⚠ Warning!

Do not park this vehicle in areas where combustible materials such as grass, hay or leaves can come into contact with the hot exhaust system. These materials could be ignited and cause a vehicle fire.

Vehicle movement may result in serious personal injury or damage to the vehicle or vehicle drivetrain. Therefore, always do the following before turning off the engine and leaving the vehicle:

- Keep right foot on the brake pedal.
- Engage the parking brake.
- Shift the automatic transmission into park position **P**.
- Slowly release the brake pedal.
- When parked on an incline, always turn the front wheels towards the road curb.
- Turn the SmartKey in the starter switch to position **0** and remove the SmartKey from the starter switch, or press the KEYLESS-GO start/stop button.
- Take the SmartKey with you and lock the vehicle when leaving.

### Switching off the engine

#### Important safety notes

##### **Warning**

Do not turn off the engine before the vehicle has come to a complete stop. With the engine not running, there is no power assistance for the brake and steering systems. In this case, it is important to keep in mind that a considerably higher degree of effort is necessary to brake and steer the vehicle.

##### **Warning!**

Keep in mind that turning off the engine alone only will shift the automatic transmission into neutral position **N** automatically.

Always shift the automatic transmission into park position **P** before turning off the engine. Otherwise the vehicle could roll away which could result in an accident and/or serious personal injury.

### Vehicles with automatic transmission

- ▶ Shift the transmission to position **P**.

#### Using the SmartKey

- ▶ Turn the SmartKey to position **0** in the ignition lock and remove it. The parking lock is activated.
- ▶ Apply the parking brake firmly.

**i** If you turn off the engine with the SmartKey and then remove it from the ignition lock or open a front door, the automatic transmission switches to **P** automatically.

#### Using KEYLESS-GO

- ▶ Press the Start/Stop button (▷ page 150). The engine stops and all the indicator lamps in the instrument cluster go out.
- ▶ Apply the parking brake firmly.

**i** If you turn off the engine with the Start/Stop button, the automatic transmission shifts to **N**. If you then open the driver's or front-passenger door, the automatic transmission shifts to **P** automatically.

**i** In an emergency, you can turn off the engine while the vehicle is in motion by pressing and holding the Start/Stop button for three seconds.

If you have started the engine with the Start/Stop button and it cannot be switched off as described:

- ▶ remove the Start/Stop button from the ignition lock.
- ▶ insert the SmartKey into the ignition lock. The engine stops. The ignition lock is in position **0**.

### Parking brake

##### **Warning**

Engaging the parking brake while the vehicle is in motion can cause the rear wheels to lock up. You could lose control of the vehicle and

cause an accident. In addition, the vehicle's brake lights do not light up when the parking brake is engaged.

### **Warning!**

When leaving the vehicle, always remove the SmartKey from the starter switch, take it with you, and lock the vehicle. Do not leave children unattended in the vehicle, or with access to an unlocked vehicle. Children could release the parking brake and/or shift the automatic transmission out of park position **P**, either of which could result in an accident and/or serious personal injury.

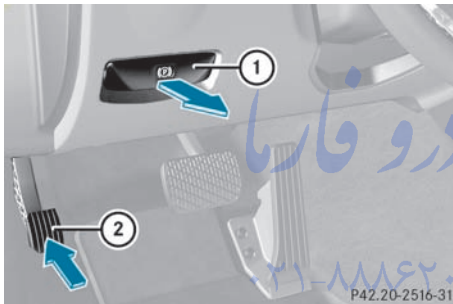

► **To apply:** depress parking brake ② firmly.

When the engine is running, the **BRAKE** (USA only) or  (Canada only) indicator lamp lights up in the instrument cluster.

► **To release:** depress the brake pedal and keep it depressed.

► Pull release handle ①.

When the ignition is switched on or the engine is running, the **BRAKE** (USA only) or  (Canada only) indicator lamp goes out in the instrument cluster.

### **Parking the vehicle**

If you leave the vehicle parked up for longer than four weeks, the battery may be damaged by exhaustive discharge.

► Disconnect the battery or connect it to a trickle charger.

 You can obtain information about trickle chargers from a qualified specialist workshop, e.g. an authorized Mercedes-Benz Center.

If you leave the vehicle parked up for longer than six weeks, the vehicle may suffer damage as a result of lack of use.

► Visit a qualified specialist workshop and seek advice.

### **Driving tips**

#### **General notes on driving**

#### **Important safety notes**

### **Warning**

Please do not forget that your primary responsibility is to drive the vehicle. A driver's attention to the road must always be his/her primary focus when driving. For your safety and the safety of others, we recommend that you pull over to a safe location and stop before placing or taking a telephone call.

If you use the telephone<sup>20</sup> while driving, please use the hands-free device and only use the telephone when road, weather and traffic conditions permit. Some jurisdictions prohibit the driver from using a mobile telephone while driving a vehicle.

Only operate the audio system or COMAND<sup>20</sup> (Cockpit Management and Data System) if road, weather and traffic conditions permit. Otherwise, you may not be able to observe traffic conditions and could endanger yourself and others.

Bear in mind that at a speed of just 30 mph (approximately 50 km/h), your vehicle is covering a distance of 44 feet (approximately 14 m) every second.

<sup>20</sup> Observe all legal requirements.

## Drive sensibly – save fuel

To save fuel, observe the following notes:

- ▶ Keep tires at the recommended inflation pressures.
- ▶ Remove unnecessary cargo.
- ▶ Remove the roof rack when not in use.
- ▶ Maintain a low engine speed until the engine is warm.
- ▶ Avoid frequent acceleration and deceleration.
- ▶ Have all maintenance work performed at the service intervals specified in the Service Booklet or indicated by the service interval indicator.

Fuel consumption is also increased by driving in cold weather, in stop-and-go traffic, on short trips and in mountainous areas.

## Drinking and driving

### Warning

Drinking and driving and/or taking drugs and driving are very dangerous combinations. Even a small amount of alcohol or drugs can affect your reflexes, perceptions and judgment.

The possibility of a serious or even fatal accident are greatly increased when you drink or take drugs and drive.

Do not drink or take drugs and drive or allow anyone to drive who has been drinking or taking drugs.

## Pedals

### Warning

Make sure absolutely no objects are obstructing the pedals' range of movement. Keep the driver's footwell clear of all obstacles. If there are any floor mats or carpets in the footwell, make sure that the pedals still have sufficient clearance.

During sudden driving or braking maneuvers, the objects could get caught between the pedals. You could then no longer brake or

accelerate. This could lead to accidents and injury.

## Coasting with the engine switched off

### Warning!

There is no power assistance for the steering and the brake when the engine is not running. Steering and braking requires significantly more effort and you could lose control of the vehicle and cause an accident as a result.

Do not turn off the engine while the vehicle is in motion.

## Exhaust check

### Warning

Inhalation of exhaust gas is hazardous to your health. All exhaust gas contains carbon monoxide (CO), and inhaling it can cause unconsciousness and possible death.

Do not run the engine in confined areas (such as a garage) which are not properly ventilated. If you think that exhaust gas fumes are entering the vehicle while driving, have the cause determined and corrected immediately. If you must drive under these conditions, drive only with at least one window fully open at all times.

Certain engine systems are designed to keep the level of poisonous components in exhaust fumes within legal limits.

These systems only work optimally if they are maintained exactly in accordance with the manufacturer's specifications. For this reason, all work on the engine must be carried out by qualified and authorized Mercedes-Benz technicians.

The engine settings must not be changed in any circumstances. Furthermore, all specific service work must be carried out at regular intervals and in accordance with the Mercedes-Benz service requirements. Details can be found in the Service Booklet.

## Engine oil

### **!** Vehicles with a diesel particle filter:

If the vehicle is mostly driven for short distances, it is possible that malfunctions may occur during the automatic cleaning of the diesel particle filter. This can lead to engine damage. Therefore, if you frequently drive short distances, make sure to drive on highways or inter-urban roads for 20 minutes at least every 310 miles (500 km).

## Brakes

### Important safety notes

#### Warning

On slippery road surfaces, never downshift in order to obtain braking action. This could result in drive wheel slip and reduced vehicle control. Your vehicle's ABS will not prevent this type of loss of control.

#### Warning

Make sure that you do not endanger other road users when you apply the brakes.

### Downhill gradients

**!** On long and steep gradients, you must reduce the cargo on the brakes by shifting to a lower gear in good time. This allows you to take advantage of engine braking and helps you to avoid overheating the brakes and wearing them out excessively.

When you take advantage of engine braking, a drive wheel may not turn for some time, e.g. on a slippery road surface. This could cause damage to the drive train. Such damage is not covered by the Mercedes-Benz warranty.

## Heavy and light loads

### Warning

Depressing the brake pedal constantly results in excessive and premature wear to the brake pads.

It may also cause the brakes to overheat, seriously impairing their effectiveness. It may then not be possible to stop the vehicle in sufficient time to avoid an accident.

If the brakes have been subjected to a heavy cargo, do not stop the vehicle immediately, but drive on for a short while. This allows the airflow to cool the brakes more quickly.

## Wet roads

### Warning

After driving in heavy rain for some time without applying the brakes or through water deep enough to wet brake components, the first braking action may be somewhat reduced. You have to depress the brake pedal more firmly. Maintain a safe distance from vehicles in front.

After driving on a wet road or having the vehicle washed, brake firmly while paying attention to the traffic conditions. This will warm up the brake discs, thereby drying them more quickly and protecting them against corrosion.

## Limited braking performance on salt treated roads

### Warning

The layer of salt on the brake discs and the brake pads/linings may cause a delay in the braking effect, resulting in a significantly longer braking distance, which could lead to an accident.

To avoid this danger, you should:

- occasionally brake carefully, without putting other road users at risk, when you are driving on salted roads. This helps to



remove any salt that may have started to build up on the brake discs and the brake pads/linings.

- maintain a greater distance to the vehicle ahead and drive with particular care.
- carefully apply the brakes at the end of a trip and immediately after commencing a new trip, so that salt residues are removed from the brake discs.

### Servicing the brakes

**!** If the red brake warning lamp lights up in the instrument cluster and you hear a warning tone while the engine is running, the brake fluid level may be too low. Observe additional warning messages in the multifunction display.

The brake fluid level may be too low due to brake pad wear or leaking brake lines.

Have the brake system checked immediately. This work should be carried out at an authorized Mercedes-Benz Center.

All checks and maintenance work on the brake system must be carried out at a qualified specialist workshop. This work should be carried out at an authorized Mercedes-Benz Center.

Only install brake pads and use brake fluid recommended by Mercedes-Benz.

#### Warning

If other than recommended brake pads are installed, or other than recommended brake fluid is used, the braking properties of the vehicle can be degraded to an extent that safe braking is substantially impaired. This could result in an accident.

**!** **Vehicles with 4MATIC:** a function or performance test may only be carried out on a two-axle dynamometer. If you are planning to have the vehicle tested on such a dynamometer, contact an authorized Mercedes-Benz Center to obtain further

information first. Otherwise, the drive train or the brake system may suffer damage.

**!** **Vehicles with 4MATIC:** as the ESP<sup>®</sup> system operates automatically, the engine and the ignition must be switched off (SmartKey in position **0** or **1** in the ignition lock or Start/Stop button in position **0** or **1**) while the parking brake is being tested on a brake dynamometer.

Braking maneuvers triggered automatically by ESP<sup>®</sup> may seriously damage the brake system.

**!** **Vehicles with 4MATIC:** as the ESP<sup>®</sup> system operates automatically, the engine and the ignition system must be switched off (SmartKey in position **0** or **1** in the ignition lock or Start/Stop button in position **0** or **1**) when:

- testing the parking brake on a brake dynamometer.
- you intend to have the vehicle towed with one of the axles raised.

Braking maneuvers triggered automatically by ESP<sup>®</sup> may seriously damage the brake system.

If your brake system is only subjected to moderate loads, you should regularly test your brake system's function by forcefully depressing the brake pedal when driving at high speed. This will give the brake pads better grip.

#### Warning

Make sure that you do not endanger other road users when you apply the brakes.

A description of Brake Assist (BAS) can be found on (▷ page 66) or of BAS PLUS on (▷ page 66).

### AMG high-performance brake system and ceramic brake system

The high-performance and ceramic brake system is only installed on the E 63 AMG.

**Warning**

New vehicle brake pads and discs, and replacement brake pads and discs may take several hundred miles of driving until they provide optimum braking efficiency. Until that time, you may need to use increased brake pedal pressure while braking. Please be aware of this and adjust your driving and braking accordingly during this break-in period.

Excessive high-demand braking will cause correspondingly high brake wear. Please be attentive to the brake warning lamp in the instrument cluster and brake condition messages in the multifunction display. Especially for high performance driving, it is important to maintain and have the brake system checked regularly.

The wear of individual components of the brake system, such as the brake pads/linings or brake discs, depends on the individual driving style and operating conditions.

**Driving on wet roads****Hydroplaning**

If water has accumulated to a certain depth on the road surface, there is a danger of hydroplaning occurring, even if:

- you drive at low speeds
- the tires have adequate tread depth

For this reason, in the event of heavy rain or in conditions in which hydroplaning can occur you must drive in the following manner:

- Lower your speed
- Avoid ruts
- Brake carefully

**Driving on flooded roads**

- ❗ Do not drive through flooded areas. Check the depth of any water before driving through it. Drive slowly through standing water. Otherwise, water may enter the vehicle interior or the engine compartment.

This can damage the electronic components in the engine or the automatic transmission. Water can also be drawn in by the engine's air suction nozzles and this can cause engine damage.

**Winter driving****General information**

Have your vehicle winterproofed at a qualified specialist workshop, e.g. at an authorized Mercedes-Benz Center, at the onset of winter.

Observe the notes in the "Winter operation" section (▷ page 176).

- ❗ Vehicles with a diesel engine: do not cover the radiator, e.g. with a protective cover. The measuring function of the Onboard Diagnosis System may otherwise provide inaccurate values. Some of these values are required by law and must therefore always be accurate.

**Winter tires**

At temperatures below 45 °F(+7 °C), use winter tires or all-season tires. Both types of tire are identified by the M+S marking.

Only winter tires also bearing the  snowflake symbol next to the M+S marking provide the best possible grip in wintry road conditions. Only these tires will allow driving safety systems such as ABS and ESP® to function optimally in winter, as these tires have been designed specifically for driving on snow.

Use M+S tires of the same make and tread on all wheels to maintain safe handling characteristics.

**Warning**

M+S tires with a tread depth of less than  $\frac{1}{6}$  inch (4 mm) must be replaced. They are no longer suitable for winter operation.

Always observe the maximum permissible speed specified for the M+S tires you have mounted.

Once you have installed the winter tires:

- ▶ Check the tire pressures (> page 355).
- ▶ Restart the tire pressure monitor (> page 357).

#### Warning

If you use your spare wheel when M+S tires are fitted on the other wheels, be aware that the difference in tire characteristics may very well impair turning stability and that overall driving stability may be reduced. Adapt your driving style accordingly.

Have the spare wheel replaced by a regular road wheel with an M+S tire at the nearest authorized Mercedes-Benz Center.

### Snow chains

For safety reasons, Mercedes-Benz recommends that you only use snow chains which have been specially approved for your vehicle by Mercedes-Benz, or are of a corresponding standard of quality.

**!** On vehicles with AIRMATIC, you must drive at raised vehicle level if snow chains have been mounted. The vehicle may otherwise be damaged.

**!** There is not enough space for snow chains on some wheel sizes. Observe the information under "Tires and wheels" in the "Technical Data" section to avoid damage to the vehicle or the wheels.

- Only use snow chains when driving on an area completely covered by snow. Do not exceed the maximum permissible speed of 30 mph (50 km/h). Remove the snow chains as soon as possible when you are no longer driving on snow-covered roads.
- Local regulations may restrict the use of snow chains. Applicable regulations must

be observed if you wish to mount snow chains.

- Snow chains must not be mounted on emergency spare wheels.

If you intend to mount snow chains, please bear the following points in mind:

- you may not attach snow chains to all wheel-tire combinations; see the "Tires and wheels" section in the "Technical data" chapter.
- mount snow chains only in pairs and only on the rear wheels. Observe the manufacturer's installation instructions.

**!** If snow chains are mounted on the front wheels, the snow chains could grind against the bodywork or components of the chassis. This could result in damage to the vehicle or the tires.

**!** Vehicles with steel wheels

If you wish to mount snow chains to steel wheels, make sure that you remove the respective wheels' hubcaps first. The hubcaps may otherwise be damaged.

**i** You may wish to deactivate ESP® (> page 67) when pulling away with snow chains installed. This way you can allow the wheels to spin in a controlled manner, achieving an increased driving force (cutting action).

### Slippery road surfaces

#### Warning

If the vehicle becomes stuck in snow, make sure snow is kept clear of the exhaust pipe and from around the vehicle with the engine running. Otherwise, deadly carbon monoxide (CO) gases may enter vehicle interior resulting in unconsciousness and death.

To assure sufficient fresh air ventilation, open a window slightly on the side of the vehicle not facing the wind.

**⚠ Warning!**

The outside temperature indicator is not designed to serve as an ice-warning device and is therefore unsuitable for that purpose.

Indicated temperatures just above the freezing point do not guarantee that the road surface is free of ice. The road may still be icy, especially in wooded areas or on bridges.

**⚠ Warning**

On slippery road surfaces, never downshift in order to obtain braking action. This could result in drive wheel slip and reduced vehicle control. Your vehicle's ABS will not prevent this type of loss of control.

You should drive particularly carefully on slippery road surfaces. Avoid sudden acceleration, steering and braking maneuvers. Do not use cruise control or DISTRONIC PLUS.

If the vehicle threatens to skid or cannot be stopped when moving at low speed:

► Shift the transmission to position **N**.

**i** For more information on driving with snow chains, see (► page 176).

**⚠ Warning**

Make sure that you do not endanger other road users when you apply the brakes.

**Driving abroad**

An extensive Mercedes-Benz Service network is also available in other countries. The Service Hotline's current telephone numbers for use when you are abroad are to be found in the "Service24h" section of the Service Booklet.

**Driving systems****Cruise control****Important safety notes**

Cruise control maintains a constant road speed for you. It brakes automatically in order to avoid exceeding the set speed. On long and steep downhill gradients, especially if the vehicle is laden, you must select shift range **1, 2** or **3** in good time. By doing so, you will make use of the braking effect of the engine, which relieves the load on the brake system and prevents the brakes from overheating and wearing too quickly.

Use cruise control only if road and traffic conditions make it appropriate to maintain a steady speed for a prolonged period. You can store any road speed above 20 mph (30 km/h).

**⚠ Warning**

The cruise control is a convenience system designed to assist the driver during vehicle operation. The driver is and must always remain responsible for the vehicle's speed and for safe brake operation.

Only use the cruise control if the road, traffic, and weather conditions make it advisable to travel at a constant speed.

- The use of the cruise control can be dangerous on winding roads or in heavy traffic because conditions do not allow safe driving at a constant speed.
- The use of the cruise control can be dangerous on slippery roads. Rapid changes in tire traction can result in wheel spin and loss of control.
- Deactivate the cruise control when driving in fog.

The "Resume" function should only be operated if the driver is fully aware of the previously set speed and wishes to resume this particular preset speed.

**Warning!**

The cruise control brakes automatically so that the set speed is not exceeded.

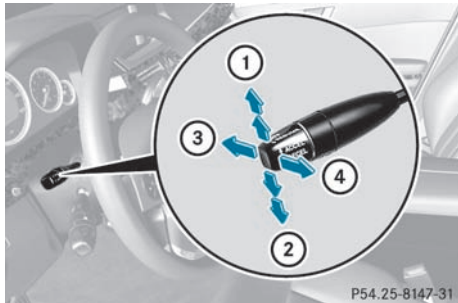
**Cruise control lever**

P54.25-8147-31

- ① To store the current speed or a higher speed
- ② To store the current speed or a lower speed
- ③ To deactivate cruise control
- ④ To store the current speed or to call up the last stored speed

When you activate cruise control, the stored speed is shown in the multifunction display for five seconds. In the multifunction display, the segments between the stored speed and the maximum speed light up.

**Storing and maintaining the current speed**

You can store the current speed if you are driving faster than 20 mph (30 km/h).

- ▶ Accelerate the vehicle to the desired speed.
- ▶ Briefly press the cruise control lever up ① or down ② to the pressure point.
- ▶ Remove your foot from the accelerator pedal.  
Cruise control is activated. The vehicle automatically maintains the stored speed.

**i** Cruise control may be unable to maintain the stored speed on uphill gradients. The stored speed is resumed when the gradient

evens out. Cruise control maintains the stored speed on downhill gradients by automatically applying the brakes.

**Storing the current speed or calling up the last stored speed****Warning**

The set speed stored in memory should only be set again if prevailing road conditions and legal speed limits permit. Possible acceleration or deceleration differences arising from returning to the preset speed could cause an accident and/or serious injury to you and others.

- ▶ Briefly pull the cruise control lever towards you ④.
- ▶ Remove your foot from the accelerator pedal.  
The first time cruise control is activated, it stores the current speed or regulates the speed of the vehicle to the previously stored speed.

**Setting a speed****Warning**

Keep in mind that it may take a brief moment until the vehicle has made the necessary adjustments.

Increase or decrease the set vehicle speed to a value that the prevailing road conditions and legal speed limits permit. Otherwise, sudden and unexpected acceleration or deceleration of the vehicle could cause an accident and/or serious injury to you and others.

- ▶ Press the cruise control lever to the pressure point, up ① for a higher speed or down ② for a lower speed.
- ▶ Keep the cruise control lever pressed until the desired speed is reached.
- ▶ Release the cruise control lever.  
The new speed is stored.

- i** Cruise control is not deactivated if you depress the accelerator pedal. For example, if you accelerate briefly to overtake, cruise control adjusts the vehicle's speed to the last speed stored after you have finished overtaking.

### Setting in 1 mph (Canada: 1 km/h) increments

- Briefly press the cruise control lever to the pressure point, up **①** for a higher speed or down **②** for a lower speed.  
The last speed stored is increased or reduced.

### Setting in 5 mph (Canada: 10 km/h) increments

- Briefly press the cruise control lever beyond the pressure point, up **①** for a higher speed or down **②** for a lower speed.  
The last speed stored is increased or reduced.

### Deactivating cruise control

There are several ways to deactivate cruise control:

- Briefly press the cruise control lever forwards **③**.

or

- Brake.

Cruise control is automatically deactivated if:

- you depress the parking brake.
- you are driving below 20 mph (30 km/h).
- ESP® intervenes or you deactivate ESP®.
- you shift the transmission to position **N** while driving.

If cruise control is deactivated, you will hear a warning tone. You will see the Cruise control off message in the multifunction display for approximately five seconds.

- i** The last speed stored is cleared when you switch off the engine.

## DISTRONIC PLUS

### Important safety notes

DISTRONIC PLUS regulates the vehicle's speed and automatically helps you maintain the distance to the vehicle detected in front. It brakes automatically in order to avoid exceeding the set speed.

On long and steep downhill gradients, especially if the vehicle is laden, you must select shift range **1**, **2** or **3** in good time. By doing so, you will make use of the braking effect of the engine, which relieves the load on the brake system and prevents the brakes from overheating and wearing too quickly.

If a slower-moving vehicle is detected in front, DISTRONIC PLUS causes your vehicle to brake and maintain a preset distance to the vehicle in front.

#### **⚠ Warning!**

The DISTRONIC PLUS requires familiarity with its operational characteristics. We strongly recommend that you review the following information carefully before operating the system.

#### **⚠ Warning!**

The DISTRONIC PLUS is a convenience system. Its speed adjustment reduction capability is intended to make cruise control more effective and usable when traffic speeds vary. It is not however, intended to, nor does it, replace the need for extreme care.

The responsibility for the vehicle's speed, distance to the preceding vehicle and, most importantly, brake operation to ensure a safe stopping distance, always remains with the driver.

The DISTRONIC PLUS cannot take street and traffic conditions into account.

Complex driving situations are not always fully recognized by the DISTRONIC PLUS. This could result in wrong or missing distance warnings.



If you want DISTRONIC PLUS to assist you, the radar sensor system must be activated (▷ page 232) and operational.

If there is no vehicle in front, DISTRONIC PLUS operates in the same way as cruise control in the speed range between 20 mph (Canada: 30 km/h) and 120 mph (Canada: 200 km/h). If there is a vehicle in front, DISTRONIC PLUS is operational in the speed range between 0 mph (Canada: 0 km/h) and 120 mph (Canada: 200 km/h).

Do not use DISTRONIC PLUS while driving on roads with steep gradients.

As DISTRONIC PLUS emits radar waves, it can simulate radar detectors used by police authorities. You can refer to the applicable section in the Operator's Manual if there are any questions concerning this.

**i** USA only:

This device has been approved by the FCC as a "Vehicular Radar System". The radar sensor is intended for use in an automotive radar system only. Removing, tampering with, or altering the device will void any warranties, and is not permitted by the FCC. Do not tamper with, alter, or use in any non-approved way.

Any unauthorized modification to this device could void the user's authority to operate the equipment.

**⚠ Warning!**

The DISTRONIC PLUS adaptive cruise control is not a substitute for active driving involvement. It does not react to pedestrians or on stationary objects, nor does it recognize or predict the curvature and lane layout or the movement of preceding vehicles. The DISTRONIC PLUS can only apply a maximum of 40% of the vehicle's braking power.

The DISTRONIC PLUS may not detect narrow vehicles possibly driving in front of you, such as motorcycles and vehicles driving in an offset formation.

It is the driver's responsibility at all times to be attentive to the road, weather and traffic conditions. Additionally, the driver must provide the steering, braking and other driving inputs necessary to remain in control of the vehicle.

High-frequency sources such as toll stations, speed measuring systems etc. can cause the DISTRONIC PLUS system to temporarily cease functioning.

**⚠ Warning!**

The DISTRONIC PLUS cannot take road and traffic conditions into account. Only use the DISTRONIC PLUS if the road, weather and traffic conditions make it advisable to travel at a constant speed.

**⚠ Warning!**

Use of the DISTRONIC PLUS can be dangerous on slippery roads. Rapid changes in tire traction can result in wheel spin and loss of control.

The DISTRONIC PLUS does not function in adverse sight and distance conditions. Do not use the DISTRONIC PLUS during conditions of fog, heavy rain, snow or sleet.

**⚠ Warning!**

The DISTRONIC PLUS cannot take weather conditions into account. Switch off the DISTRONIC PLUS or do not switch it on if:

- roads are slippery or covered with snow or ice. The wheels could lose traction while braking or accelerating, and the vehicle could skid.
- the DISTRONIC PLUS system sensor covers are dirty or visibility is diminished due to snow, rain or fog, for example. The distance control system functionality could be impaired.

Always pay attention to surrounding traffic conditions even while the DISTRONIC PLUS is switched on. Otherwise, you may not be able to recognize dangerous situations until it is



too late. This could cause an accident in which you and/or others could be injured.

### **Warning!**

The "Resume" function should only be operated if the driver is fully aware of the previously set speed and wishes to resume this particular preset speed.

### **Warning**

Your undivided attention to street and traffic conditions is necessary at all times whether DISTRONIC PLUS is active or not.

The use of DISTRONIC PLUS can be dangerous on winding roads or in heavy traffic because conditions do not allow safe driving at a constant speed.

DISTRONIC PLUS does not react to stationary objects on the road (for example, a vehicle stopped in traffic or an abandoned vehicle). DISTRONIC PLUS likewise does not react to oncoming vehicles.

Deactivate DISTRONIC PLUS:

- when changing to the right lane, if the vehicles in the left lane are driving slower
- when driving into a filter lane or an expressway exit
- in complex driving situations, for example at roadworks on an expressway

In these situations DISTRONIC PLUS will maintain the set speed if it is not deactivated.

DISTRONIC PLUS is intended only for maintaining a set speed and a set distance from the objects moving in front of the vehicle.

### **Warning!**

An intermittent warning sounds and the distance warning lamp  in the instrument cluster is illuminated if the DISTRONIC PLUS system calculates that the distance to the vehicle ahead and your vehicle's current speed indicate that the DISTRONIC PLUS will not be capable of slowing the vehicle sufficiently to maintain the preset following

distance, which creates a danger of a collision.

Immediately brake the vehicle to increase your distance to the preceding vehicle. The warning sound is intended as a final caution in which you should intercede with your own braking inputs to avoid a potentially dangerous situation. Do not wait for the operation of the warning signal to intercede with your own braking. This will result in potentially dangerous emergency braking which will not always result in an impact being avoided.

Tailgating increases the risk of an accident.

### **Warning**

DISTRONIC PLUS brakes your vehicle with a maximum deceleration of 13 ft/s(4 m/s<sup>2</sup>).

This corresponds to approximately 40% of your vehicle's maximum possible braking power.

You must apply the brakes yourself to avoid a collision. DISTRONIC PLUS brakes the vehicle to restore the set distance to the vehicle in front or to restore the set speed.

### **Warning!**

If you do not receive visual or acoustic warning signals during a critical traffic situation, DISTRONIC PLUS has either not recognized the collision risk, has been deactivated or is malfunctioning.

Remember, whether or not DISTRONIC PLUS is operating, it is ultimately always the drivers responsibility to apply the brakes in order to control the vehicle and avoid a collision.

## Cruise control lever

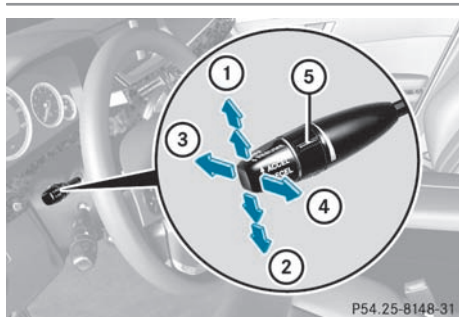

P54.25-8148-31

- ① To store the current speed or a higher speed
- ② To store the current speed or a lower speed
- ③ To deactivate DISTRONIC PLUS
- ④ To store the current speed or call up the last stored speed
- ⑤ To set the specified minimum distance

## Activating DISTRONIC PLUS, storing and maintaining the current speed

### Important safety notes

#### Warning!

When the DISTRONIC PLUS is switched on, the vehicle can be braked. You should therefore switch off the DISTRONIC PLUS if the vehicle must be towed.

You can activate DISTRONIC PLUS under the following circumstances:

- the engine has been started and you have been driving for up to two minutes
- the parking brake is not applied
- ESP® is activated
- the transmission is in position **D**
- the hood is closed
- the driver's door is closed and you shift the transmission from position **P** to **D** or your seat belt is fastened
- the front-passenger door and the rear doors are closed
- the vehicle has not skidded

## Activating while driving

When driving at speeds below 20 mph (30 km/h), you can only activate DISTRONIC PLUS if the vehicle in front has been detected and is shown in the multifunction display. If the vehicle in front is not shown in the multifunction display and is no longer detected, because it has changed lanes, for example, DISTRONIC PLUS is deactivated and a tone sounds.

- ▶ Briefly pull the cruise control lever towards you ④ or press it up ① or down ② to the pressure point. DISTRONIC PLUS is selected.
- ▶ Keep the cruise control lever pressed up ① or down ② until the desired speed is set.
- ▶ Remove your foot from the accelerator pedal. Your vehicle adapts its speed to that of the vehicle in front, but only up to the desired stored speed.

**i** If you do not fully release the accelerator pedal, the DISTRONIC PLUS Override message appears in the multifunction display. The set distance to a slower-moving vehicle in front will then not be maintained. You will be driving at the speed you determine by the position of the accelerator pedal.

## Activating when driving towards a stationary vehicle

If the vehicle in front of you is stationary, you can only activate DISTRONIC PLUS once your vehicle is stationary as well.

- ▶ Briefly pull the cruise control lever towards you ④. DISTRONIC PLUS is selected.
- i** DISTRONIC PLUS can only be activated at under 20 mph (30 km/h) if a vehicle in front has been detected. Therefore, the DISTRONIC PLUS distance display in the instrument cluster should be activated.

- ▶ Keep the cruise control lever pressed up ① or down ② until the desired speed is set.

**i** You can use the cruise control lever to set the stored speed and the control on the cruise control lever to set the specified minimum distance (> page 185).

### Pulling away

- ▶ **If the vehicle in front pulls away:** remove your foot from the brake pedal.

- ▶ Briefly pull the cruise control lever towards you ④.

or

- ▶ Accelerate briefly.  
Your vehicle pulls away and adapts its speed to that of the vehicle in front.

### Driving

If there is no vehicle in front, DISTRONIC PLUS operates in the same way as cruise control.

If a slower-moving vehicle is detected in front, DISTRONIC PLUS causes your vehicle to brake and maintain a preset distance to the vehicle in front.

If DISTRONIC PLUS detects a faster-moving vehicle in front, it increases the driving speed, but only up to the desired speed you have stored.

#### **Warning!**

When you step on the brake pedal, you switch off the DISTRONIC PLUS except when the vehicle is at a standstill. The DISTRONIC PLUS will no longer brake your vehicle. You are always responsible for maintaining a distance from other vehicles, observing road speeds and braking well in advance.

### Changing lanes

If you wish to change to the passing lane (in left-hand-drive vehicles, the passing lane is the left-hand lane), DISTRONIC PLUS supports you if:

- you are driving above 40 mph (60 km/h)
- DISTRONIC PLUS is maintaining the distance to a vehicle in front
- you switch on the appropriate turn signals
- DISTRONIC PLUS does not detect a danger of collision

If these conditions are met, your vehicle is accelerated. Acceleration will be interrupted if changing lanes takes too long or if the distance between your vehicle and the vehicle in front becomes too small.

#### **Warning**

DISTRONIC PLUS and Active Blind Spot Assist are only aids designed to assist driving.

They do not relieve you of the responsibility of paying attention. The driver remains fully responsible for the vehicle's distance from other vehicles, the vehicle's speed and for braking in good time. Always pay attention to traffic conditions and your surroundings.

Otherwise, you may fail to recognize dangers in time, cause an accident and injure yourself and others.

### Stopping

#### **Warning**

Never get out of the vehicle when DISTRONIC PLUS is activated.

DISTRONIC PLUS must also never be operated, activated or deactivated by a passenger or from outside the vehicle.

DISTRONIC PLUS does not replace the parking brake and must not be used for parking.

The DISTRONIC PLUS braking effect is canceled and the vehicle can start moving if:

- DISTRONIC PLUS is deactivated using the cruise control lever.
- you accelerate.

- there is a malfunction in the system or an interruption in the power supply, e.g. battery failure.
- the electrical system in the engine compartment, the battery or the fuses are tampered with.
- the battery is disconnected.

If you wish to leave the vehicle or park it, deactivate DISTRONIC PLUS and secure the vehicle against rolling away.

If DISTRONIC PLUS detects that the vehicle in front is stopping, it brakes your vehicle until it is stationary.

Once your vehicle is stationary, it remains stationary and you do not need to depress the brake.

- i** Depending on the specified minimum distance, your vehicle will come to a standstill at a sufficient distance behind the vehicle in front. The specified minimum distance is set using the control on the cruise control lever.

When DISTRONIC PLUS is activated, the transmission is shifted automatically to position **P** if:

- the driver's door is open and the driver's seat belt is unfastened.
- the engine is switched off.
- the hood is opened.
- a system malfunction occurs.
- the power supply is not sufficient.

### Setting a speed

#### Warning

Keep in mind that it may take a brief moment until the vehicle has made the necessary adjustments.

Increase or decrease the set vehicle speed to a value that the prevailing road conditions and legal speed limits permit. Otherwise, sudden and unexpected acceleration or deceleration of the vehicle could cause an accident and/or serious injury to you and others.

- ▶ Press the cruise control lever to the pressure point, up ① for a higher speed or down ② for a lower speed.
- ▶ Keep the cruise control lever pressed until the desired speed is reached.
- ▶ Release the cruise control lever. The new speed is stored. DISTRONIC PLUS is activated and adjusts the vehicle's speed to the new speed stored.

### Setting in 1 mph (Canada: 1 km/h) increments

- ▶ Briefly press the cruise control lever to the pressure point, up ① for a higher speed or down ② for a lower speed. The last speed stored is increased or reduced.

### Setting in 5 mph (Canada: 10 km/h) increments

- ▶ Briefly press the cruise control lever beyond the pressure point, up ① for a higher speed or down ② for a lower speed. The last speed stored is increased or reduced.

### Storing the current speed or calling up a stored speed

#### Warning

The set speed stored in memory should only be set again if prevailing road conditions and legal speed limits permit. Possible acceleration or deceleration differences arising from returning to the preset speed could cause an accident and/or serious injury to you and others.

- ▶ Briefly pull the cruise control lever towards you ④.
- ▶ Remove your foot from the accelerator pedal. DISTRONIC PLUS is activated and adopts either the current speed or adjusts to the

last speed stored when it is activated for the first time.

### Setting the specified minimum distance

You can set the specified minimum distance for DISTRONIC PLUS by varying the time span between one and two seconds. With this function, you can set the minimum distance that DISTRONIC PLUS keeps to the vehicle in front, dependent on vehicle speed. You can see this distance in the multifunction display (▷ page 185).

#### **Warning!**

It is up to the driver to exercise discretion to select the appropriate setting given road conditions, traffic, driver's preferred driving style and applicable laws and driving recommendations for safe following distance.

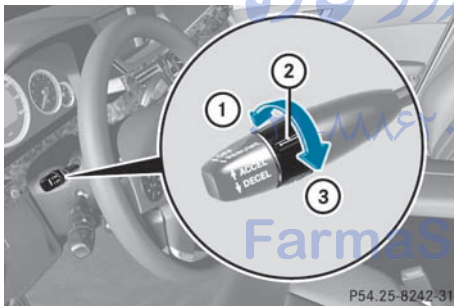

- ▶ **To increase:** turn control ② in direction ③.

DISTRONIC PLUS then maintains a greater distance between your vehicle and the vehicle in front.

- ▶ **To decrease:** turn control ② in direction ①.

DISTRONIC PLUS then maintains a shorter distance between your vehicle and the vehicle in front.

- i** Make sure that you maintain the minimum distance to the vehicle in front as required by law. Adjust the distance to the vehicle in front if necessary.

### DISTRONIC PLUS displays in the speedometer



When DISTRONIC PLUS is activated, one or two segments ② in the set speed range light up.

- i** For design reasons, the speed displayed in the speedometer may differ slightly from the speed set for DISTRONIC PLUS.

If DISTRONIC PLUS detects a vehicle in front, segments ② between speed of the vehicle in front ① and stored speed ③ light up.

### DISTRONIC PLUS displays in the multifunction display

#### General information

In the Assistance menu (▷ page 227) of the on-board computer, you can select the distance display and activate or deactivate PRE-SAFE® Brake.

#### Display when DISTRONIC PLUS is deactivated

- ▶ Select the Distance Display function using the on-board computer (▷ page 227).

When DISTRONIC PLUS is deactivated, you will see the following in the multifunction display:



Example

- ① Vehicle in front, if detected
- ② Distance indicator, current distance to the vehicle in front
- ③ Specified minimum distance to the vehicle in front, adjustable
- ④ Own vehicle
- ⑤ Symbol for the activated PRE-SAFE® Brake

### Display when DISTRONIC PLUS is activated

- ▶ Select the Distance Display function using the on-board computer (▷ page 227).

You will see the stored speed for about five seconds when you activate DISTRONIC PLUS. After this time, you will see the following in the multifunction display while DISTRONIC PLUS is activated:



Example

- ① DISTRONIC PLUS activated
- ② Own vehicle

- ③ Specified minimum distance to the vehicle in front, adjustable
- ④ Vehicle in front, if detected

### Deactivating DISTRONIC PLUS

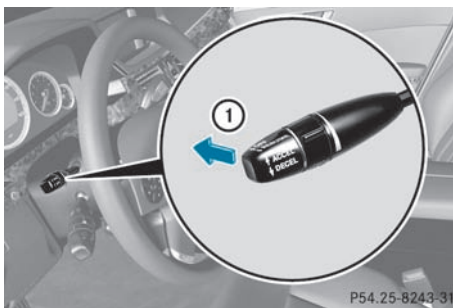

There are several ways to deactivate DISTRONIC PLUS:

- ▶ Briefly press the cruise control lever forwards ①.

or

- ▶ Brake, unless the vehicle is stationary.

**i** The last speed stored remains stored until you switch off the engine.

**i** DISTRONIC PLUS is not deactivated if you depress the accelerator pedal. If you accelerate to overtake, DISTRONIC PLUS adjusts the vehicle's speed to the last speed stored after you have finished overtaking.

DISTRONIC PLUS is automatically deactivated if:

- you apply the parking brake.
- you are driving slower than 15 mph (25 km/h) and there is no vehicle in front, or if the vehicle in front is no longer detected.
- ESP® intervenes or you deactivate ESP®.
- the transmission is in the **P**, **R** or **N** position.
- you switch off the radar sensor system (▷ page 232).
- you pull the cruise control lever towards you in order to pull away and the front-



passenger door or one of the rear doors is open.

- the vehicle has skidded.

If DISTRONIC PLUS is deactivated, you will hear a warning tone. You will see the DISTRONIC PLUS Off message in the multifunction display for approximately five seconds.

## Tips for driving with DISTRONIC PLUS

### Important safety guidelines

The following contains descriptions of certain road and traffic conditions in which you must be particularly attentive. In such situations, brake if necessary. DISTRONIC PLUS is then deactivated.

#### Warning!

The DISTRONIC PLUS works to maintain the speed selected by the driver unless a moving obstacle proceeding directly ahead of it in the same travel direction is detected (e.g. following another vehicle ahead of you at your set distance).

This means that:

- Your vehicle can pass another vehicle after you have changed lanes.
- While in a sharp turn or if the preceding vehicle is in a sharp turn, the DISTRONIC PLUS could lose sight of the preceding vehicle. Your vehicle could then accelerate to the previously selected speed.

The DISTRONIC PLUS regulates only the distance between your vehicle and those directly ahead of it. It may not register stationary objects in the road, e.g.:

- a stopped vehicle in a traffic jam
- a disabled vehicle
- an oncoming vehicle

The driver must always be alert, observe all traffic and intercede as required by means of steering or braking the vehicle.

#### Warning!

The DISTRONIC PLUS should not be used in snowy or icy road conditions.

### Cornering, going into and coming out of a bend

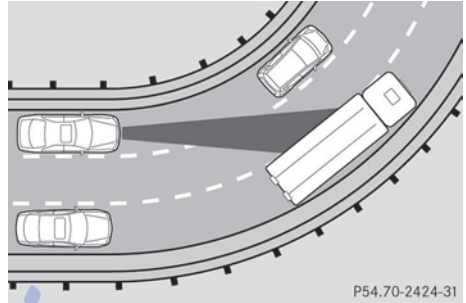

The ability of DISTRONIC PLUS to detect vehicles when cornering is limited. Your vehicle may brake unexpectedly or late.

### Vehicles traveling on a different line

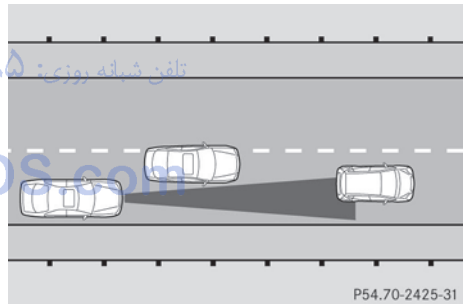

DISTRONIC PLUS may not detect vehicles traveling on a different line. The distance to the vehicle in front will be too short.



### Other vehicles changing lanes

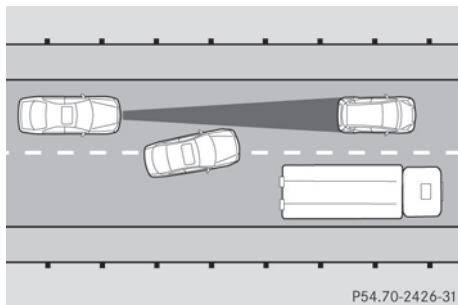

DISTRONIC PLUS has not detected the vehicle cutting in yet. The distance to this vehicle will be too short.

### Narrow vehicles

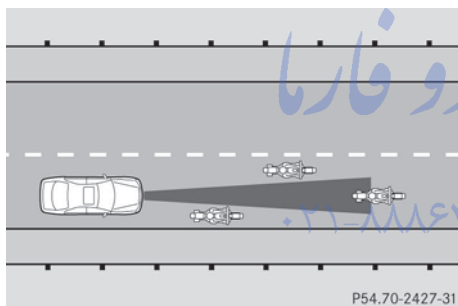

DISTRONIC PLUS has not yet detected the vehicle in front on the edge of the road, because of its narrow width. The distance to the vehicle in front will be too short.

### Obstructions and stationary vehicles

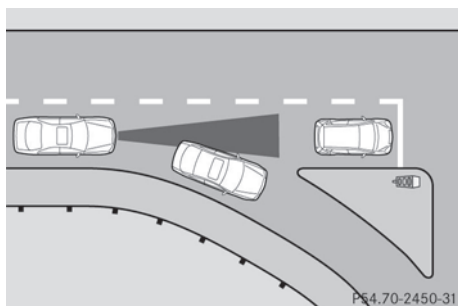

DISTRONIC PLUS does not brake for obstacles or stationary vehicles. If, for

example, the detected vehicle turns a corner and reveals an obstacle or stationary vehicle, DISTRONIC PLUS will not brake for these.

### Crossing vehicles

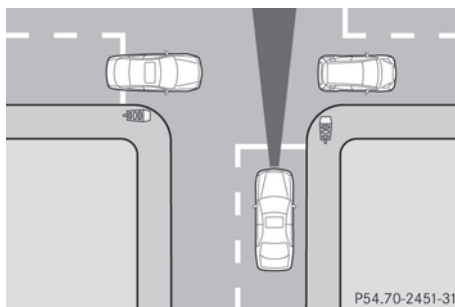

DISTRONIC PLUS may detect vehicles that are crossing your lane by mistake. Activating DISTRONIC PLUS at traffic lights with crossing traffic, for example, could cause your vehicle to pull away unintentionally.

### HOLD function

#### General information

The HOLD function can assist the driver in the following situations:

- when pulling away, especially on steep slopes
- when maneuvering on steep slopes
- when waiting in traffic

The vehicle is kept stationary without the driver having to depress the brake pedal.

The braking effect is canceled and the HOLD function deactivated when you depress the accelerator pedal to pull away.

#### Activation conditions

You can activate the HOLD function if:

- the vehicle is stationary.
- the engine is running.
- the driver's door is closed or if your seat belt is fastened.
- the parking brake is not applied.

- the hood is closed.
- the transmission is in position **D**, **R** or **N**.
- DISTRONIC PLUS is deactivated.

### Activating the HOLD function

- ▶ Make sure that the activation conditions are met.
- ▶ Depress the brake pedal.



Example

- ▶ Quickly depress the brake pedal further until the **HOLD** display appears in the multifunction display. The **HOLD** function is activated. You can release the brake pedal.
- i** If depressing the brake pedal the first time does not activate the **HOLD** function, wait briefly and then try again.

#### **Warning**

The vehicle's brakes are applied when the **HOLD** function is activated. For this reason, deactivate the **HOLD** function if the vehicle is to be set in motion by other means (e.g. in a car wash or by towing).

### Deactivating the HOLD function

The **HOLD** function is deactivated automatically if:

- you accelerate and the transmission is in position **D** or **R**.
- the transmission is in position **P**.
- you apply the brakes again with a certain amount of pressure until **HOLD** disappears from the multifunction display.
- you activate DISTRONIC PLUS.

#### **Warning**

Never get out of the vehicle when the **HOLD** function is activated.

The **HOLD** function must never be operated or deactivated by a passenger or from outside the vehicle.

The **HOLD** function does not replace the parking brake and must not be used for parking.

The braking effect of the **HOLD** function is canceled and the vehicle could roll away if:

- the **HOLD** function is deactivated by depressing the accelerator pedal or the brake pedal.
- there is a malfunction in the system or an interruption in the power supply, e.g. battery failure.
- the electrical system in the engine compartment, the battery or the fuses are tampered with.
- the battery is disconnected.

If you leave the vehicle or park it, deactivate the **HOLD** function and secure the vehicle against rolling away.

When the **HOLD** function is activated, the transmission is shifted automatically to position **P** if:

- the driver's door is open and the driver's seat belt is unfastened.
- the engine is switched off.
- the hood is opened.
- a system malfunction occurs.
- the power supply is not sufficient.

- i** If the engine has been switched off, it cannot be started again until the **HOLD** function has been deactivated.

If there is a malfunction in the system or power supply while the **HOLD** function is activated, the **Brake Immediately** message is shown in the multifunction display. Immediately depress the brake firmly until the warning message in the multifunction display goes out.

## RACE START

### Important safety guidelines

- i** RACE START is only available in AMG vehicles.

RACE START enables optimal acceleration from a standing start under suitable high-grip road surface conditions.

#### Risk of accident

RACE START is only available when SPORT handling mode is activated. SPORT handling mode only stabilizes the vehicle to a certain extent if it is swerving or the wheels are spinning.

RACE START may only be used on closed roads. Always adapt your speed and driving style to suit the current road and weather conditions.

### Conditions for activation

RACE START can be activated when:

- the doors are closed
- the engine is running and it has reached an operating temperature of approximately 80 °C. This is the case when the engine oil temperature in the multifunction display stops flashing.
- SPORT handling mode is activated (▷ page 69)
- the steering wheel is in the straight-ahead position
- the vehicle is at rest and the brake pedal is depressed (left foot)
- the transmission is in position **D**

### Activating RACE START

- ▶ Depress the brake pedal with your left foot, and keep it depressed.

- ▶ Turn the program selector switch clockwise (▷ page 158) until the **RS** lamp lights up.

The multifunction display shows the RACE START Confirm: Paddle UP Cancel: Paddle DOWN message.

- i** If the conditions for activation are no longer fulfilled, RACE START is canceled. The multifunction display shows the RACE START Canceled message.

- ▶ To cancel: pull the left steering wheel shift paddle (▷ page 159).

or

- ▶ To confirm: pull the right steering wheel shift paddle (▷ page 159).

The multifunction display shows the RACE START Available Depress gas pedal message.

- i** If you do not depress the accelerator pedal fully within two seconds, RACE START is canceled. The multifunction display shows the RACE START Not Possible See Operator's Manual message.

- ▶ Depress the accelerator pedal fully. The engine speed increases to approximately 4000 rpm.

The multifunction display shows the RACE START Release brake to start message.

- i** If you do not release the brake pedal within seven seconds, RACE START is canceled. The multifunction display shows the RACE START Canceled message.

- ▶ Take your foot off the brake, but keep the accelerator pedal depressed. The vehicle pulls away at maximum acceleration.

The multifunction display shows the RACE START Active message.

RACE START is deactivated when a speed of approximately 30 mph (Canada: 50 km/h) is reached. Drive program **S+** is activated. SPORT handling mode remains activated. RACE START is deactivated immediately if you release the accelerator pedal during RACE START or if any of the activation conditions are no longer fulfilled. The multifunction display shows the RACE START Not Possible See Operator's Manual message.

- i** If RACE START is used repeatedly in a short period of time, it is only available again after having driven the vehicle a certain distance.

## AIRMATIC

### General information

- i** AIRMATIC is available only for the E 550 and E 550 4MATIC models.

### Vehicle level

Your vehicle regulates its height automatically. All-round self-leveling ensures the best possible suspension and constant ground clearance, even with a laden vehicle. When you drive fast, the vehicle is lowered automatically to improve driving safety and to reduce fuel consumption.

The following vehicle levels are possible:

- normal.
- raised: the vehicle is raised above the normal level by 0.80 in (20 mm).
- lowered: the vehicle is lowered beyond the normal level by 0.40 in (10 mm).

The "Normal" and "Raised" vehicle levels can be set manually.

The "Lowered" vehicle level is set automatically:

- at speeds above 70 mph (113 km/h)
- if you have selected "Sports tuning" (▷ page 192)

### Setting the vehicle level

Select the "Normal" setting for normal road surfaces and "Raised" for driving with snow chains or on particularly poor road surfaces. Your selection remains stored even if you remove the SmartKey from the ignition lock.

#### Warning!

To help avoid personal injury, keep hands and feet away from wheel housing area, and stay away from under the vehicle when lowering the vehicle chassis.

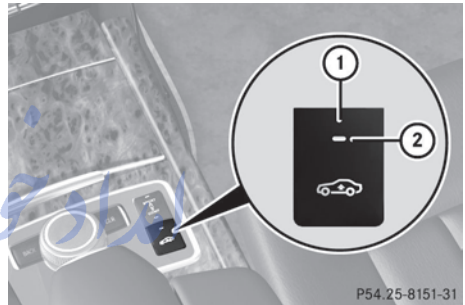

P54.25-8151-31

### Setting raised level

- ▶ Start the engine.

If indicator lamp ② is not lit:

- ▶ Press button ①. Indicator lamp ② lights up. The vehicle height is adjusted to raised level. The Vehicle Rising message appears in the display.

The "Raised Level" setting is canceled if you:

- drive at speeds above approximately 75 mph (120 km/h)
- drive about 3 minutes at speeds above 50 mph (80 km/h)

The "Raised Level" setting remains saved when you are not driving within these speed ranges.

### Setting normal level

- ▶ Start the engine.

If indicator lamp ② is lit:

- ▶ Press button ①.
- Indicator lamp ② goes out. The vehicle is adjusted to normal level.

### Suspension tuning

The electronically controlled damping system works continuously. This improves driving safety and ride comfort.

The damping is tuned individually to each wheel and depends on:

- your driving style, e.g. sporty
- the road surface condition, e.g. bumps
- your individual selection, i.e. sports or comfort

Your selection remains stored even if you remove the SmartKey from the ignition lock.

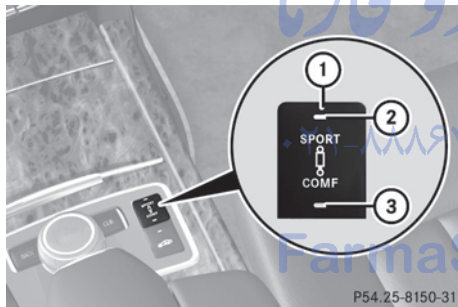

### Sports tuning

The firmer suspension tuning in Sport mode ensures even better contact with the road. Select this mode when employing a sporty driving style, e.g. on winding country roads.

- ▶ Press button ①.
- Indicator lamp ② lights up. You have selected the suspension for a sporty driving style.
- The AIRMATIC SPORT message appears in the multifunction display.

### Comfort tuning

In comfort mode, the driving characteristics of your vehicle are more comfortable. Select this mode if you prefer a more comfortable

driving style, but also when driving fast on straight roads, e.g. highways.

- ▶ Press button ①.
- Indicator lamp ③ lights up. You have selected the suspension for a comfortable driving style.
- The AIRMATIC COMFORT message appears in the multifunction display.

### AMG RIDE CONTROL sports suspension

#### General notes

- ① AMG RIDE CONTROL sports suspension is available for the E 63 AMG model.

#### Rear axle level control

The vehicle automatically sets the vehicle level at the rear axle. Rear axle self-leveling ensures the best possible suspension and ensures that the ground clearance remains constant, even when the vehicle is loaded. This improves driving safety and fuel consumption.

### Suspension tuning

The electronically controlled damping system works continuously. This improves driving safety and ride comfort.

The damping is tuned individually to each wheel and depends on:

- your driving style, e.g. sporty
- the road surface condition, e.g. bumps
- your individual selection of Sport, Sport + or Comfort

If you select Sport or Sport + mode and restart the engine, the suspension setting reverts to Comfort mode.

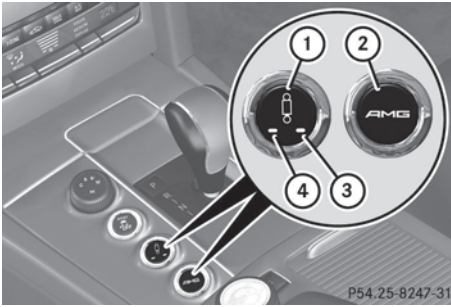

### Sport mode

The firmer suspension tuning in Sport mode ensures even better contact with the road. Select this mode when employing a sporty driving style, e.g. on winding country roads.

- ▶ Press button ① once.  
Indicator lamp ④ lights up. Sport suspension mode has been selected.  
The AMG Suspension System SPORT message appears in the multifunction display.

### Sport + mode

The very firm setting of the suspension tuning in Sport + mode ensures the best possible contact with the road. Select this mode only when driving on race circuits.

If indicator lamps ③ and ④ are off:

- ▶ Press button ① twice.  
Both indicator lamps ③ and ④ light up.  
Sport + suspension mode has been selected.  
The AMG Suspension System SPORT + message appears in the multifunction display.

If indicator lamp ④ lights up:

- ▶ Press button ① once.  
Second indicator lamp ③ lights up. Sport + suspension mode has been selected.  
The AMG Suspension System SPORT + message appears in the multifunction display.

### Comfort mode

In comfort mode, the driving characteristics of your vehicle are more comfortable. Select this mode if you prefer a more comfortable driving style, but also when driving fast on straight roads, e.g. highways.

- ▶ Press button ① repeatedly until indicator lamps ③ and ④ go out.  
Comfort suspension mode has been selected.

The AMG Suspension System COMFORT message appears in the multifunction display.

### Storing and calling up settings

Once the suspension tuning and drive program have been selected, you can store and call up your settings using AMG button ②.

- ▶ **To store:** press AMG button ② until you hear a tone.

- ▶ **To call up:** press AMG button ②.

The stored suspension tuning and drive program are selected.

- ▶ **To display:** briefly press AMG button ②.  
Your selection appears in the multifunction display.

### 4MATIC (permanent four-wheel drive)

4MATIC ensures that all four wheels are permanently driven. Together with ESP<sup>®</sup>, it improves the traction of your vehicle whenever a drive wheel spins due to insufficient grip.

**⚠ Warning!**

If a drive wheel is spinning due to insufficient traction:

- While driving off, apply as little throttle as possible.
- While driving, ease up on the accelerator pedal.
- Adapt your speed and driving style to the prevailing road conditions.

Failure to observe these guidelines could cause the vehicle to skid.

The 4MATIC cannot prevent accidents resulting from excessive speed.

**!** Never tow the vehicle with one axle raised. This may damage the transfer case. Damage of this sort is not covered by the Mercedes-Benz Limited Warranty. All wheels must remain either on the ground or be fully raised. Observe the instructions for towing the vehicle with all wheels in full contact with the ground.

**i** In wintry driving conditions, the maximum effect of 4MATIC can only be achieved if you use winter tires (M+S tires), with snow chains if necessary.

**PARKTRONIC****Important safety notes****⚠ Warning!**

The PARKTRONIC is a supplemental system. It is not intended to, nor does it replace, the need for extreme care. The responsibility during parking and other critical maneuvers always remains with the driver.

**⚠ Warning!**

Make sure no persons or animals are in or near the area in which you are parking/maneuvering. Otherwise, they could be injured.

PARKTRONIC is an electronic parking aid with ultrasonic sensors. It indicates visually and audibly the distance between your vehicle and an object.

PARKTRONIC is activated automatically when you:

- switch on the ignition.
- shift the transmission to position **D**, **R** or **N**.
- release the parking brake.

PARKTRONIC is deactivated at speeds above 11 mph (18 km/h). It is reactivated at lower speeds.

PARKTRONIC monitors the area around your vehicle using six sensors in the front bumper and four sensors in the rear bumper.

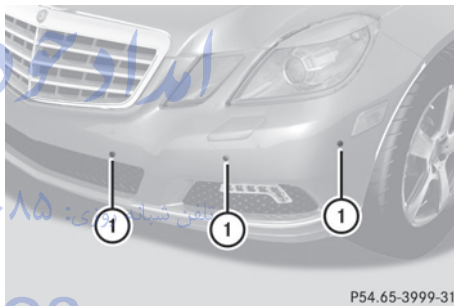

① Sensors in the front bumper, left-hand side (example)

**Range of the sensors**

The sensors must be free of dirt, ice and slush; otherwise they may not function correctly. Clean the sensors regularly, taking care not to scratch or damage them (> page 317).



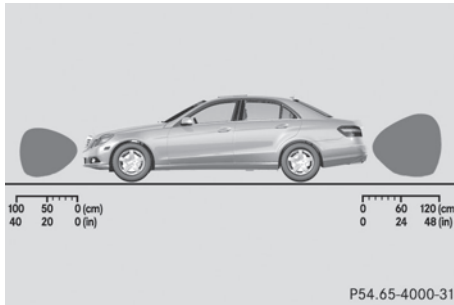

Side view, Sedan (example)

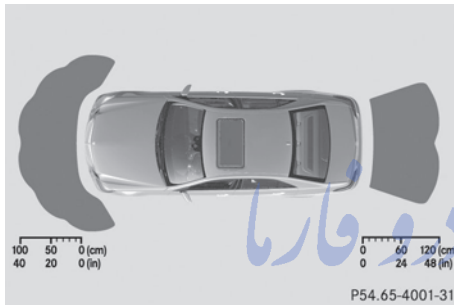

Top view, Sedan (example)

### Front sensors

Center	Approx. 40 in (100 cm)
Corners	Approx. 24 in (60 cm)

### Rear sensors

Center	Approx. 48 in (120 cm)
Corners	Approx. 32 in (80 cm)

**!** When parking, pay particular attention to objects above or below the sensors, such as flower pots or trailer drawbars. PARKTRONIC does not detect such objects when they are in the immediate vicinity of the vehicle. You could damage the vehicle or the objects.

Ultrasonic sources such as an automatic car wash, a truck's compressed-air brakes or a pneumatic drill could cause PARKTRONIC to malfunction.

### Minimum distance

Center	Approx. 8 in (20 cm)
Corners	Approx. 6 in (15 cm)

If there is an obstacle within this range, all warning displays light up and a warning tone sounds. If the distance falls below the minimum, the distance may no longer be shown.

### Warning displays

The warning displays show the distance between the sensors and the obstacle. The warning display for the front area is located on the dashboard above the center air vents. The warning display for the rear area is located on the headliner in the rear compartment.

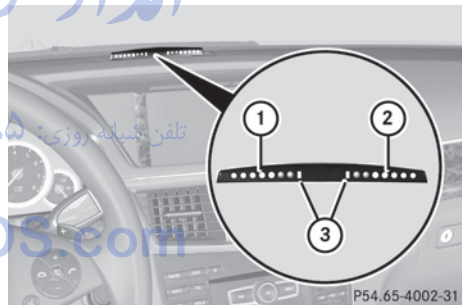

Warning display for the front area

- ① Segments on the left-hand side of the vehicle
- ② Segments on the right-hand side of the vehicle
- ③ Segments showing operational readiness

The warning display for each side of the vehicle is divided into five yellow and two red segments. PARKTRONIC is operational if yellow segments showing operational readiness ③ light up.

The selected transmission position determines which warning display is active when the engine is running.

Transmission position	Warning display
D	Front area activated
R or N	Rear and front areas activated
P	No areas activated

One or more segments light up as the vehicle approaches an obstacle, depending on the vehicle's distance from the obstacle.

From the:

- sixth segment onwards, you will hear an intermittent warning tone for approximately two seconds.
- seventh segment onwards, you will hear a warning tone for approximately two seconds. This indicates that you have now reached the minimum distance.

### Deactivating/activating PARKTRONIC

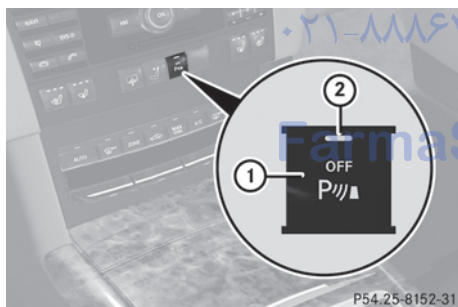

- ① To deactivate/activate PARKTRONIC
- ② Indicator lamp

If indicator lamp ② lights up, PARKTRONIC is deactivated.

- i** PARKTRONIC is automatically activated when you turn the SmartKey to position 2 in the ignition lock.

## Problems with PARKTRONIC

Problem	Possible causes/consequences and ► Solutions
Only the red segments in the PARKTRONIC warning displays are lit. You also hear a warning tone for approximately two seconds. PARKTRONIC is deactivated after approximately 20 seconds, and the indicator lamp in the PARKTRONIC button lights up.	<p>PARKTRONIC has malfunctioned and has switched off.</p> <p>► If problems persist, have PARKTRONIC checked at a qualified specialist workshop.</p>
Only the red segments in the PARKTRONIC warning displays are lit. PARKTRONIC is deactivated after approximately 20 seconds.	<p>The PARKTRONIC sensors are dirty or there is interference.</p> <p>► Clean the PARKTRONIC sensors (► page 317).</p> <p>► Switch the ignition back on.</p> <p>The problem may be caused by an external source of radio or ultrasound waves.</p> <p>► See if PARKTRONIC functions in a different location.</p>

## Parking Guidance

### Important safety notes

Parking Guidance is an electronic parking aid with ultrasound. Ultrasound is used to measure the road on both sides of the vehicle. A suitable parking space is indicated by the parking symbol. You receive steering instructions when parking. You may also use PARKTRONIC (► page 194).

#### **Warning**

Parking Guidance is merely an aid and may display parking spaces that are not suitable for parking, for example:

- no-parking areas
- parking spaces with unsuitable surfaces (road surface)

- driveways
- entrances and exits

Parking Guidance detects and measures potential parking spaces while driving past. Changes to the parking space after this point are not taken into account, for example if the vehicle in front of or behind the parking space changes position or objects in the parking space are moved.

Even when using Parking Guidance, you are still responsible for driving carefully. If you rely on Parking Guidance alone, you could cause an accident and injure yourself and others.

Safety always remains your responsibility and you must continue paying careful attention to your immediate surroundings when parking and maneuvering.

**⚠ Warning!**

The system cannot detect objects located above the area that the sensors scan. These objects, e.g. protruding load, overhang, or truck tail lifts, will be ignored when computing the parking procedure. The Parking Guidance might therefore provide untimely steering instructions. This could cause a collision. Thus, do not use the Parking Guidance in such situations.

**⚠ Warning!**

Make sure no persons or animals are in the area in which you are maneuvering. You could otherwise injure them.

- ❗ Pay particular attention to low objects or objects with flat surfaces, such as trailer drawbars, posts, cross beams and curbs. These types of objects cannot be detected by Parking Guidance and may damage the vehicle.

When PARKTRONIC is deactivated, Parking Guidance is also unavailable.

Use Parking Guidance for parking spaces:

- that are parallel to the direction of travel
- that are on straight roads, not bends
- that are on the same level as the road, i.e. not on the pavement, for example. Parking Guidance may not detect flat curbs

Parking tips:

- On narrow roads, drive as close to the parking space as possible.
- Parking spaces that are littered, overgrown or partially occupied by trailer drawbars might be identified incorrectly or not at all.
- Snowfall or heavy rain may lead to a parking space being measured inaccurately.
- Pay attention to the PARKTRONIC warning messages during the parking procedure (▷ page 195).
- When transporting a load which protrudes from your vehicle, you must not use Parking Guidance.

- Never use Parking Guidance with snow chains or an emergency spare wheel installed.
- Make sure that the tire pressures are always correct. This has a direct effect on the steering instructions.
- The way your vehicle is positioned in the parking space after parking is dependent on various factors. These include the position and shape of the vehicles parked in front and behind it and the conditions of the location. In some cases, Parking Guidance may guide you too far or not far enough into a parking space. In some cases, it may also lead you across or onto the curb. If necessary, cancel the parking procedure with Parking Guidance.

- ❗ If unavoidable, you should drive over obstacles such as curbs slowly and not at a sharp angle. Otherwise, you may damage the wheels or tires.

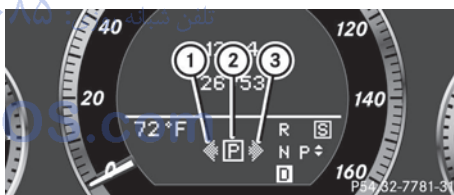
**Detecting a parking space**

Example

- ① Detected parking space on the left
- ② Parking symbol
- ③ Detected parking space on the right

Parking Guidance is automatically activated when you drive forwards. The system is operational at speeds of up to approximately 22 mph (35 km/h). While in operation, the system independently locates and measures parking spaces on both sides of the vehicle. When driving at speeds below 19 mph (30 km/h), you will see parking symbol ② as a status indicator in the instrument cluster. When a parking space has been detected, an arrow towards the right ③ or the left ① also

appears. Parking Guidance only displays parking spaces on the front-passenger side as standard. Parking spaces on the driver's side are displayed as soon as the turn signal on the driver's side is activated. To park on the driver's side, you must leave the driver's side turn signal switched on until you have engaged reverse gear.

Parking Guidance will only detect parking spaces:

- that are parallel to the direction of travel
- that are at least 5 ft (1.5 m) wide
- that are at least 4.3 ft (1.3 m) longer than your vehicle.

A parking space is displayed while you are driving past it, and until you are approximately 50 ft (15 m) away from it.

## Parking

### Warning!

The Parking Guidance is only an aid and may not detect all obstacles. The Parking Guidance does not relieve you of the responsibility to pay attention. You are always responsible for safety and must continue to pay attention to your immediate surroundings when parking and maneuvering. Otherwise, you could endanger yourself and others.

- ▶ Stop the vehicle when the parking space symbol shows the desired parking space in the instrument cluster.
- ▶ Shift the transmission to position **R**. The multifunction display shows the Check Vehicle Surroundings Press 'OK' to Confirm message.
- ▶ Press **[OK]** on the multifunction steering wheel to confirm. The multifunction display switches to Parking Guidance. Depending on your distance from the parking space, the Please Drive Backward message will appear in the multifunction display.

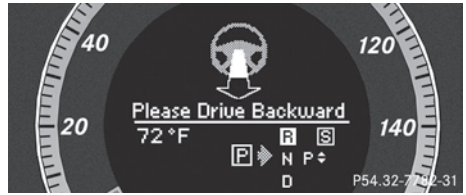

- ▶ If necessary, reverse towards the parking space. This is indicated by an arrow pointing backwards. Continue backing up until you hear a tone. Stop – the parking position has been reached. The arrow is white. The Please Steer Wheel to the Right or Please Steer Wheel to the Left message appears in the multifunction display.



- ▶ While the vehicle is stationary, turn the steering wheel in the specified direction until the arrow is white and a warning tone sounds.
- ▶ **To reverse into the parking space:** maintain the steering wheel angle and reverse carefully.
- ▶ Stop as soon as you hear an acoustic signal. The vehicle has reached the position in which you need to countersteer. The Please Steer Wheel to the Left or Please Steer Wheel to the Right message appears in the multifunction display.
- ▶ **Countersteering:** while the vehicle is stationary, turn the steering wheel in the specified direction until the arrow is white and a warning tone sounds.

- ▶ **To reverse into the parking space:** maintain the steering wheel angle and reverse carefully.
- ▶ Stop as soon as you hear an acoustic signal, at the latest when PARKTRONIC sounds the continuous warning tone. The Parking Guidance Finished message appears in the multifunction display and a tone sounds. You may be asked to steer in a different direction and then change gear. In this case, further displays in the multifunction display will direct you to the final position.
- ▶ Maneuver if necessary.
- ▶ Always observe the warning messages displayed by PARKTRONIC (▷ page 195).

### Canceling Parking Guidance

- ▶ Press the PARKTRONIC button on the center console (▷ page 196). Parking Guidance is canceled immediately and PARKTRONIC is deactivated.

Parking Guidance is canceled automatically if it is no longer possible to guide you into the parking space or if a malfunction occurs.

The parking space symbol disappears and the Parking Guidance canceled message appears in the multifunction display.

### Rear view camera

#### Important safety notes

The rear view camera is an optical parking aid. It shows the area behind your vehicle in the COMAND display.

#### Warning!

Make sure no persons or animals are in or near the area in which you are parking/maneuvering. Otherwise, they could be injured.

The rear view camera is located in the handle strip of the trunk lid/tailgate.

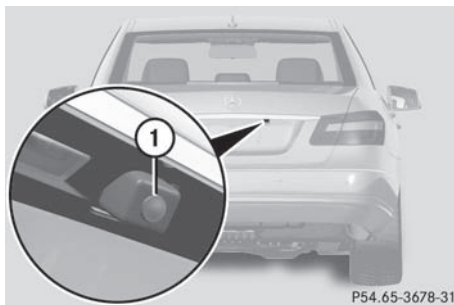

P54.65-3678-31

Sedan (example)

- ① Rear view camera

### View through the camera

The area behind the vehicle is displayed as a mirror image, as in the rear-view mirror.

#### Warning

The rear view camera is only an aid and the obstacle display may:

- show a distorted perspective
- be inaccurate
- not show obstacles at all

The rear view camera does not mean that you are no longer responsible for driving carefully. Be careful and be particularly alert. The rear view camera may not show objects that are:

- very close to the rear bumper
- underneath the rear bumper
- above the trunk handle/tailgate handle

Safety always remains your responsibility, and you must continue paying careful attention to your immediate surroundings when parking and maneuvering. This includes the area behind, in front of and beside the vehicle. You could otherwise endanger yourself or others.

#### Warning

The rear view camera does not work or does not work properly:

- if the trunk lid/tailgate is open
- in very heavy rain, snow or fog

- at night, or if you are parking/maneuvering your vehicle in a very dark area
- if very bright white light is shining on the camera
- if the surrounding area is lit by fluorescent light (the COMAND system display may flicker)
- if the temperature changes suddenly, for example if you drive into a heated garage after being in the cold (condensation on the lens)
- if the camera lens is dirty or covered
- if the rear of your vehicle is damaged

In this case, have the camera position and setting checked at a qualified specialist workshop. Mercedes-Benz recommends that you use an authorized Mercedes-Benz Center for this purpose.

Do not use the rear view camera in these types of situation. Otherwise, you could injure yourself and others and/or cause damage, even to your own vehicle, when parking/maneuvering.

### Activating the rear view camera

- ▶ Make sure that the SmartKey is in position **2** in the ignition lock.
- ▶ Make sure that the "rear view camera" function is selected in COMAND (see the separate operating instructions for COMAND).
- ▶ Engage reverse gear.  
The area behind the vehicle is shown in the COMAND display.

### ATTENTION ASSIST

#### Important safety notes

ATTENTION ASSIST helps you during long, monotonous journeys, such as on highways and arterial roads. It is active at speeds between 50 mph (80 km/h) and 112 mph (180 km/h).

If ATTENTION ASSIST detects fatigue or increasing lapses in concentration on the part of the driver, it suggests taking a break.

#### Warning!

The ATTENTION ASSIST is only an aid to the driver. It might not recognize fatigue or increasing inattentiveness in time or fail to recognize them at all. The system cannot substitute a rested and attentive driver.

Fatigue can cause you to recognize dangers too late, to misjudge potential dangers, or to react slower. Therefore, make sure to be rested before and during your trip. Take rests early enough and regularly, especially during long trips. Failure to do so could cause you to recognize dangers too late which could result in an accident and serious injury to you and/or others.

ATTENTION ASSIST assesses your level of fatigue or lapses in concentration by taking the following criteria into account:

- your personal driving style, e.g. steering characteristics
- journey details, e.g. time of day and length of journey

The functionality of ATTENTION ASSIST is restricted and warnings may be delayed or not occur at all:

- if the road condition is poor, e.g. if the surface is uneven or if there are potholes
- if there is a strong side wind
- if you have adopted a sporty driving style with high cornering speeds or high rates of acceleration
- if you predominantly drive at speeds under 50 mph (80 km/h) or over 112 mph (180 km/h)
- if you are currently using COMAND or making a telephone call with it
- if the time has been set incorrectly
- in active driving situations, such as when you change lanes or change your speed



## Warning and display messages in the multifunction display



Example

- ▶ Activate ATTENTION ASSIST using the on-board computer (▶ page 228). Symbol ① appears in the multifunction display.

If ATTENTION ASSIST is active, it will not warn you until at least 20 minutes after your journey has begun. You then hear an intermittent warning tone twice and the Attention Assist: Time for a rest? message appears in the multifunction display.

- ▶ If necessary, take a break.
- ▶ Press **[OK]** to confirm the message.

On long journeys, take regular breaks in good time to allow yourself to rest properly. If you do not take a break and ATTENTION ASSIST still detects fatigue or increasing lapses in concentration, you will be warned again after 15 minutes at the earliest.

ATTENTION ASSIST is reset when you continue your journey; it reassesses your tiredness if:

- you switch off the engine.
- you take off your seat belt and open the driver's door, e.g. for a change of drivers or to take a break.

### Night View Assist Plus

#### Important safety notes

In addition to the illumination provided by the normal headlamps, Night View Assist Plus uses infrared light to illuminate the road. A camera at the top of the windshield picks up

the infrared light and displays a black-and-white image in the COMAND display. The image displayed in COMAND corresponds to a road lit up by high-beam headlamps. This enables you to see the road's course and any obstacles in good time. If pedestrian recognition is activated, pedestrians recognized by the system are highlighted in the Night View Assist Plus display.

#### **Warning**

Night View Assist Plus is only an aid designed to assist driving. It is not a substitute for attentive driving. Do not rely solely on the Night View Assist Plus display. Continue to look through the windshield. You are responsible for safety and must drive in accordance with traffic conditions. You could otherwise put yourself and others in danger.

The system may be impaired or unavailable if:

- there is poor visibility, e.g. due to snow, rain, fog or heavy spray.
- the windshield is dirty, fogged up or covered, for instance by a sticker, in the vicinity of the camera.
- you are driving on bends, uphill gradients or downhill gradients.

Light from the headlamps of oncoming vehicles does not affect the Night View Assist Plus display in the multifunction display. This is also the case if you cannot switch on the high-beam headlamps because of oncoming traffic.

#### **Warning!**

The Night View Assist Plus cannot record objects immediately in front of or next to the vehicle. When maneuvering, continue to look through the windshield. Make sure no persons or animals are in the area in which you are maneuvering. You could otherwise injure them.

- ① Infrared light is not visible to the human eye and therefore does not glare. Night View Assist Plus can therefore remain

switched on even if there is oncoming traffic.

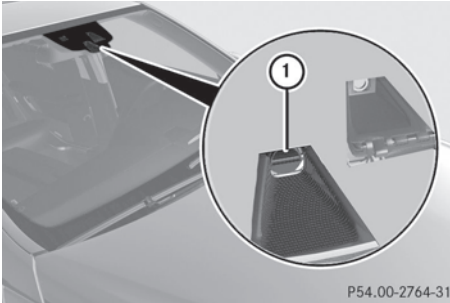

① Night View Assist Plus camera

### Switching on Night View Assist Plus

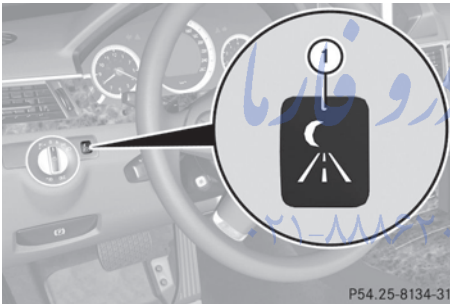

You can only activate Night View Assist Plus if:

- the SmartKey is in position **2** in the ignition lock.
  - it is dark.
  - the light switch is in the **A** or  position.
  - reverse gear has not been engaged.
- Make sure COMAND APS is switched on.
- Press button ①.

The Night View Assist Plus display appears in the COMAND APS display.

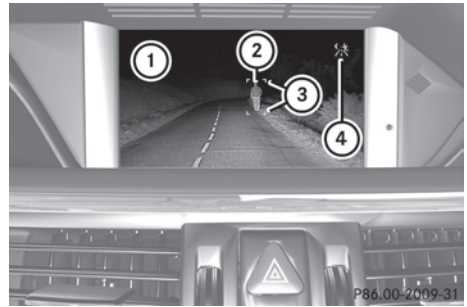

① Night View Assist Plus display

② Pedestrian recognized

③ Framing

④ Symbol for active pedestrian recognition

You can read about how to adjust the brightness of the COMAND APS display in the COMAND APS operating instructions.

**i** The infrared headlamps only switch on when the vehicle is driving at speeds of at least 6 mph (10 km/h). This means that you do not have the full visual range while stationary and cannot check whether Night View Assist Plus is working.

### Pedestrian recognition

Night View Assist Plus recognizes pedestrians using typical characteristics, e.g. a silhouette in the shape of a person.

Pedestrian recognition is activated automatically, if

- Night View Assist Plus is activated.
- you are driving faster than 6 mph (10 km/h).
- the surroundings are dark, e.g. when driving outside built-up areas without street lighting.

If pedestrian recognition is active, symbol ④ appears. If a pedestrian is now recognized, they are highlighted by a frame ③. If the pedestrian recognition system has brought a pedestrian to your attention, look through the windshield to evaluate the situation. The actual distance to objects and

pedestrians cannot be gauged accurately by looking at a screen.

It may be the case that objects are highlighted as well as pedestrians.

#### **Warning!**

The pedestrian detection may be impaired or unavailable when

- pedestrians are obstructed fully or in part by other objects such as parking vehicles
- the silhouette in the Night View Assist Plus image is displayed incomplete or interrupted, e.g. by significant light reflection
- a pedestrian's silhouette is not rich enough in contrast compared to the background
- pedestrians are not in erected position but, for example, sit, crouch down, or lie

- i** Animals are not recognized by pedestrian recognition.

### Fogged up or dirty windshield

If the windshield in front of the camera is fogged up or dirty on the inside or outside, the Night View Assist Plus display is affected.

#### **Warning!**

Please do not forget that your primary responsibility is to drive the vehicle. A driver's attention to the road must always be his/her primary focus when driving. For your safety and the safety of others, stop before trying to remove window fogging or cleaning the windshield in front of the Night View Assist Plus camera.

Bear in mind that at a speed of just 30 mph (approximately 50 km/h), your vehicle is covering a distance of 44 feet (approximately 14 m) every second.

- ▶ **To defrost:** check the automatic air conditioning settings (▷ page 142) and fold down the camera cover (▷ page 318).
- ▶ **To defrost the inside of the windshield:** fold down the camera cover (▷ page 318) and clean the windshield (▷ page 316).

امداد خودرو فارما

تلفن شبانه روزی: ۰۸۵ ۱۱۱۶۲۰۸۵

FarmaSOS.com

## Problems with Night View Assist Plus

Problem	Possible causes/consequences and ► Solutions
The picture quality of Night View Assist Plus has deteriorated.	The windshield wipers are smearing the windshield. ► Replace the wiper blades (▷ page 129).
	The windshield is smeared after the vehicle has been cleaned in a car wash. ► Clean the windshield (▷ page 316).
	There is windshield chip damage in the camera's field of vision. ► Replace the windshield.
	The windshield is fogged up on the inside. ► Defrost the windshield (▷ page 142).
	The windshield is iced up. ► De-ice the windshield (▷ page 141).
	There is dirt on the inside of the windshield. ► Clean the inside of the windshield (▷ page 316).

### Lane Tracking package

#### General information

The Lane Tracking package consists of Blind Spot Assist (▷ page 205) and Lane Keeping Assist (▷ page 207).

#### Blind Spot Assist

##### Important safety notes

Blind Spot Assist uses a radar sensor system to monitor the areas on both sides of your vehicle. It is active at speeds above approximately 20 mph (30 km/h). A warning display in the exterior mirrors draws your attention to a vehicle detected in the monitored area. If you switch on the corresponding turn signal before changing lane, you will also receive visual and audible collision warnings. For this purpose, Blind Spot Assist uses sensors in the rear bumper.

#### Warning تلفن

Blind Spot Assist is only an aid designed to assist driving. It may fail to detect some vehicles and is no substitute for attentive driving.

Blind Spot Assist cannot detect road and traffic conditions. It may fail to detect narrow vehicles, such as motorcycles or bicycles, or may only detect them too late.

Monitoring may be affected by dirty sensors, strong spray or poor visibility caused by snow, rain or mist, for example. In this case, vehicles are detected late or not at all.

Always pay attention to traffic conditions and your surroundings. Otherwise, you may fail to recognize dangers in time, cause an accident and injure yourself and others.

#### USA only:

This device has been approved by the FCC as a "Vehicular Radar System". The radar sensor is intended for use in an automotive radar system only. Removal, tampering, or

altering of the device will void any warranties, and is not permitted by the FCC. Do not tamper with, alter, or use in any non-approved way.

Any unauthorized modification to this device could void the user's authority to operate the equipment.

For Blind Spot Assist to assist you when driving, the radar sensor system must be switched on (► page 232) and operational.

### Monitoring range of the sensors

Blind Spot Assist monitors the area up to 10 ft (3 m) behind your vehicle and directly next to your vehicle as shown in the diagram.

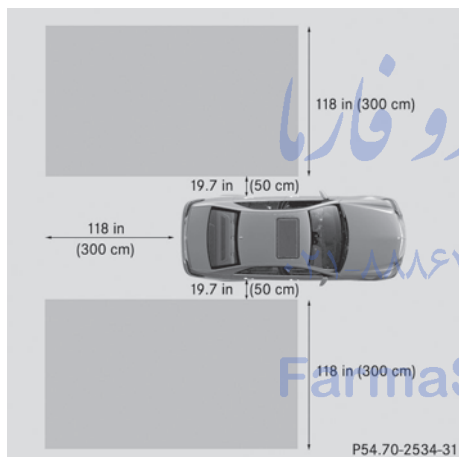

Sedan (example)

### Warning

Blind Spot Assist monitors certain areas in the immediate vicinity of your vehicle. Vehicles that approach and drive past at high speeds are not detected. There is no display and no warning.

If the lanes are very wide, it may not be possible to monitor the complete width of the neighboring lane. For this reason, vehicles in the next lane may not be detected, especially if they are driving in a staggered formation. This may be the case if vehicles are driving at that edge of their lane which is furthest away from your vehicle.

Always pay attention to traffic conditions and your surroundings. Otherwise, you may fail to recognize dangers in time, cause an accident and injure yourself and others.

If the lanes are narrow, the system may be unable to distinguish the neighboring lane from the one beyond it. For this reason, the system may indicate vehicles in the farther lane, especially if the vehicles are driving in a staggered formation in different lanes. In particular, this may be the case if the vehicles are driving at that edge of their lane which is nearest your vehicle.

Due to the nature of the system:

- warnings may be issued unnecessarily when driving close to crash barriers or similar solid lane borders.
- warnings may be interrupted when driving alongside particularly long vehicles for a prolonged time.

The two sensors for Blind Spot Assist are integrated into the sides of the rear bumper. Make sure that the bumper is free of dirt, ice or slush around the sensors. For example, the radar sensors must not be covered by bicycle racks or overhanging loads. In the event of a severe impact or damage to the bumpers, have the function of the radar sensors checked at a qualified specialist workshop, e.g. an authorized Mercedes-Benz Center. Blind Spot Assist may otherwise not work properly.

### Indicator and warning display

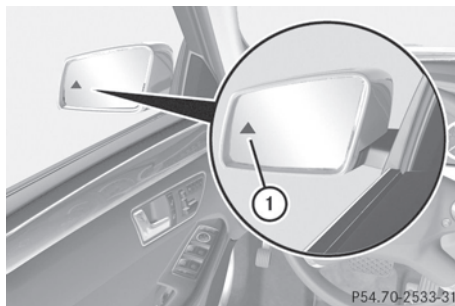

- ① Yellow indicator lamp/red warning lamp

If Blind Spot Assist is switched on, indicator lamp ① in the exterior mirrors lights up in yellow up to a speed of 20 mph (30 km/h). At speeds above 20 mph (30 km/h), the indicator lamp goes out and Blind Spot Assist is operational.

If a vehicle is detected within the monitoring range of Blind Spot Assist at speeds above 20 mph (30 km/h), warning lamp ① on the corresponding side lights up in red. This warning is always emitted when a vehicle enters the blind spot monitoring range from behind or from the side. When you overtake a vehicle, the warning only occurs if the difference in speed is less than 7 mph (12 km/h).

The yellow indicator lamp goes out if reverse gear is engaged. In this event, Blind Spot Assist is no longer active.

The brightness of the indicator/warning lamps is adjusted automatically according to the ambient light.

#### Warning

Blind Spot Assist is not active at speeds under approximately 20 mph (30 km/h). The indicator lamps in the exterior mirrors are yellow. Vehicles in the monitoring range are then not indicated.

Always pay attention to traffic conditions and your surroundings. Otherwise, you may fail to recognize dangers in time, cause an accident and injure yourself and others.

#### Collision warning

If a vehicle is detected in the monitoring range of Blind Spot Assist and you switch on the turn signal, a double warning tone sounds. Red warning lamp ① flashes. If the turn signal remains on, detected vehicles are indicated by the flashing of red warning lamp ①. There are no further warning tones.

#### Switching on Blind Spot Assist

- Make sure that the radar sensor system (▷ page 232) and Blind Spot Assist

(▷ page 228) are activated in the on-board computer.

- Turn the SmartKey to position **2** in the ignition lock.  
Warning lamps ① light up in red in the exterior mirrors for approximately 1.5 seconds and then turn yellow.

#### Lane Keeping Assist

##### Important safety notes

Lane Keeping Assist monitors the area in front of your vehicle by means of a camera at the top of the windshield. Lane Keeping Assist detects lane markings on the road and warns you before you leave your lane unintentionally.

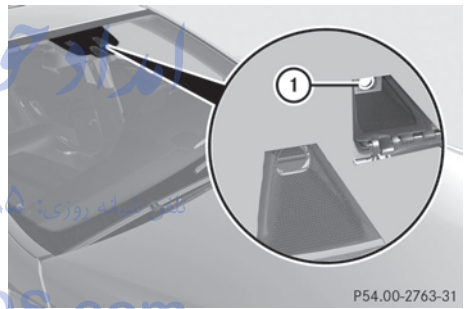

① Lane Keeping Assist camera

If you select km on the on-board computer in the Display Unit Speed-/Odometer: function (▷ page 229), Lane Keeping Assist is activated starting at a speed of 60 km/h. If the miles display unit is selected, the assistance range begins at 40 mph.

#### Warning

Lane Keeping Assist does not keep your vehicle in its lane. It is only an aid and may detect the lane markings on the road incorrectly or not at all.

The system may be impaired or may not function if:

- there is poor visibility, e.g. due to insufficient illumination of the road, or due to snow, rain, fog or spray.
- there is glare, e.g. from oncoming traffic, the sun, or reflection from other vehicles.
- the windshield is dirty, fogged up or covered, for instance by a sticker, in the vicinity of the camera.
- several or no lane markings for a single lane are present.
- the lane markings are worn away, dark or covered up, e.g. by dirt or snow.
- the distance to the vehicle in front is too small and the lane markings thus cannot be detected.
- the lane markings on the road are unclear, e.g. near roadworks.
- the lane markings change quickly, e.g. lanes branch off, cross one another or merge.
- the road is narrow and winding.

Lane Keeping Assist cannot detect road and traffic conditions. It is not a substitute for attentive driving. You are responsible for the vehicle's speed, braking in good time, and steering correctly. Always adapt your driving style to suit the prevailing road and weather conditions. Always pay attention to traffic conditions and your surroundings. Otherwise, you may fail to recognize dangers in time, cause an accident and injure yourself and others.

A warning can be given when a front wheel passes over a lane marking. It will warn you by means of intermittent vibration in the steering wheel for up to 1.5 seconds.

In order that you are warned only when necessary and in good time if you cross the lane marking, the system recognizes certain conditions and warns you accordingly.

The warning vibration occurs earlier if:

- you approach the outer lane marking on a bend.
- the road has very wide lanes, e.g. a freeway.
- the system recognizes solid lane markings.

The warning vibration occurs later if:

- the road has narrow lanes.
- you cut the corner on a bend.

No warning vibration occurs if:

- you clearly and actively steer, brake, or accelerate.
- you cut the corner on a sharp bend.
- a driving safety system intervenes, such as ABS, BAS or ESP®.
- you switch on the turn signals. In this event, the warnings are suppressed for a certain period of time.

### Activating Lane Keeping Assist



- ▶ Activate Lane Keeping Assist using the on-board computer (▷ page 229).

Symbol ① appears in the multifunction display.

If you drive at speeds above 40 mph (60 km/h) and lane markings are detected, symbol ① is highlighted. Lane Keeping Assist is ready for use.

### Active Driving Assistance package

#### General information

The Active Driving Assistance package consists of DISTRONIC PLUS (▷ page 179), Active Blind Spot Assist (▷ page 209) and Active Lane Keeping Assist (▷ page 211).



## Active Blind Spot Assist

### Important safety notes

Active Blind Spot Assist uses a radar sensor system to monitor the side areas of your vehicle. In addition, it uses the radar sensor system to monitor the front area as well. Active Blind Spot Assist is activated at speeds above approximately 20 mph (30 km/h). A warning lamp in the exterior mirrors calls your attention to a vehicle or certain obstacles in the area monitored. If you switch on the corresponding turn signal before changing lane, you will also receive visual and audible collision warnings. If a risk of lateral collision is detected, corrective braking may help you avoid a collision.

#### Warning

Active Blind Spot Assist is only an aid, and may detect vehicles/obstacles incorrectly or not at all.

The system may be impaired or may not function if:

- there is poor visibility, e.g. due to snow, rain, fog or spray.
- the rear and/or front sensors are dirty.

Active Blind Spot Assist may not detect narrow vehicles, such as motorcycles or bicycles, or only detect them too late. It cannot detect vehicles that are overtaken at a small distance and then enter the blind spot area.

Active Blind Spot Assist cannot detect road and traffic conditions. It is not a substitute for attentive driving. You are responsible for the vehicle's speed, braking in good time, and steering correctly. Always adapt your driving style to suit the prevailing road and weather conditions. Always pay attention to traffic conditions and your surroundings. Otherwise, you may fail to recognize dangers in time, cause an accident and injure yourself and others.

 USA only:

This device has been approved by the FCC as a "Vehicular Radar System". The radar sensor is intended for use in an automotive radar system only. Removal, tampering, or altering of the device will void any warranties, and is not permitted by the FCC. Do not tamper with, alter, or use in any non-approved way.

Any unauthorized modification to this device could void the user's authority to operate the equipment.

For Active Blind Spot Assist to assist you when driving, the radar sensor system must be activated (▷ page 232) and operational.

### Monitoring range

Active Blind Spot Assist monitors the area up to 10 ft (3 m) behind your vehicle and directly next to your vehicle as shown in the diagram. For this purpose, Active Blind Spot Assist uses sensors in the rear bumper.



Sedan (example)

#### Warning

Active Blind Spot Assist monitors certain areas in the immediate vicinity of your vehicle. Vehicles that approach and drive past at high speeds are not detected. No visual nor audible warnings are emitted and the system does not brake the vehicle to correct your course.

If the lanes are very wide, it may not be possible to monitor the complete width of the neighboring lane. For this reason, vehicles in the next lane may not be detected, especially if they are driving in a staggered formation. This may be the case if vehicles are driving at the edge of their lane that is furthest away from your vehicle.

Always pay attention to traffic conditions and your surroundings. Otherwise, you may fail to recognize dangers in time, cause an accident and injure yourself and others.

If the lanes are narrow, the system may be unable to distinguish the neighboring lane from the one beyond it. For this reason, the system may indicate vehicles in the farther lane, especially if the vehicles are driving in a staggered formation in different lanes. In particular, this may be the case if the vehicles are driving at that edge of their lane which is nearest your vehicle. Due to the nature of the system, warnings may be issued unnecessarily when driving close to crash barriers or similar solid lane borders.

Two Active Blind Spot Assist sensors are integrated into the front and rear bumpers respectively. An additional sensor is located behind the cover in the radiator grill. Make sure that the bumpers are free of dirt, ice or slush around the sensors. The rear radar sensors must not be covered, for example by bicycle racks or overhanging loads. In the event of a severe impact or damage to the bumpers, have the function of the radar sensors checked at a qualified specialist workshop, e.g. an authorized Mercedes-Benz Center. Active Blind Spot Assist may otherwise fail to work correctly.

## Indicator and warning display

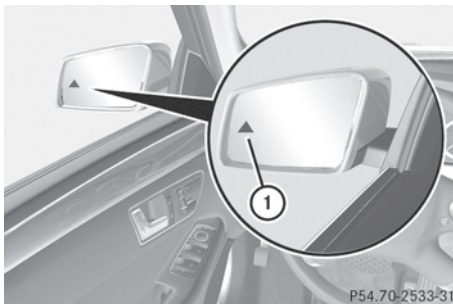

① Yellow indicator lamp/red warning lamp

If Active Blind Spot Assist is switched on, indicator lamp ① in the exterior mirrors lights up in yellow up to a speed of 20 mph (30 km/h). At speeds above 20 mph (30 km/h), the indicator lamp goes out and Active Blind Spot Assist is operational.

If a vehicle is detected within the monitoring range of Blind Spot Assist at speeds above 20 mph (30 km/h), warning lamp ① on the corresponding side lights up in red. This warning is always emitted when a vehicle enters the blind spot monitoring range from behind or from the side. When you overtake a vehicle, the warning only occurs if the difference in speed is less than 7 mph (12 km/h).

The yellow indicator lamp goes out if reverse gear is engaged. Active Blind Spot Assist is then no longer active.

The brightness of the indicator/warning lamps is adjusted automatically according to the ambient light.

### Warning

Active Blind Spot Assist is not active at speeds lower than 20 mph (30 km/h). The indicator lamps in the exterior mirrors are yellow. Vehicles in the monitoring range are then not indicated.

Always pay attention to traffic conditions and your surroundings. Otherwise, you may fail to recognize dangers in time, cause an accident and injure yourself and others.

### Optical and acoustic collision warning

When you switch on the appropriate turn signals to change lanes and a vehicle is detected in the side monitoring range of Active Blind Spot Assist, you receive an optical and acoustic collision warning. You then hear a double warning tone and red warning lamp ① flashes. If the turn signal remains on, detected vehicles are indicated by the flashing of red warning lamp ①. There are no further warning tones.

### Course-correcting brake application

If Active Blind Spot Assist detects a risk of collision in the monitoring range, under certain circumstances, it will brake the vehicle briefly on one side. This is designed to help you avoid a collision.

This function is available at speeds between 20 mph and 120 mph (30 km/h and 200 km/h).

When a course-correcting brake application occurs, red warning lamp ① flashes in the exterior mirror and the following is shown in the multifunction display, for example:



#### Warning

Active Blind Spot Assist is only an aid designed to assist driving. It is not a substitute for attentive driving. In some cases, the course-correcting brake application is not sufficient to avoid a collision. In such a case, you must steer, brake or accelerate.

In very rare cases, the system may erroneously detect a danger of collision in the area of crash barriers or similar lane borders and apply the brakes. Active Blind Spot Assist does not detect all traffic situations and road users. Always make sure that there is sufficient distance to the side for other traffic

or obstacles. An inappropriate brake application may be interrupted at any time if you steer slightly in the opposite direction or accelerate.

You are responsible for the vehicle's speed, braking in good time, and steering correctly. Always adapt your driving style to suit the prevailing road and weather conditions.

Always pay attention to traffic conditions and your surroundings. Otherwise, you may fail to recognize dangers in time, cause an accident and injure yourself and others.

Either a very slight, course-correcting brake application, or none at all, may occur if:

- other vehicles and/or objects, such as crash barriers, are detected in the immediate vicinity of your vehicle.
- a vehicle approaches you too closely at the side.
- you have adopted a sporty driving style with high cornering speeds.
- you clearly brake or accelerate.
- a driving safety system intervenes, such as ESP® or PRE-SAFE® Brake.
- ESP® is deactivated.
- a loss of tire pressure or a defective tire has been detected and shown in the display.

### Activating Active Blind Spot Assist

- ▶ Make sure that the radar sensor system (▷ page 232) and Active Blind Spot Assist (▷ page 228) are activated in the on-board computer.
- ▶ Turn the SmartKey to position **2** in the ignition lock.  
Warning lamps ① light up in red in the exterior mirrors for approximately 1.5 seconds and then turn yellow.

### Active Lane Keeping Assist

#### Important safety notes

Active Lane Keeping Assist monitors the area in front of your vehicle by means of a camera at the top of the windshield. Active Lane

Keeping Assist detects lane markings on the road and warns you before you leave your lane unintentionally. If you do not react to the warning, a lane-correcting application of the brakes can bring the vehicle back into the original lane.

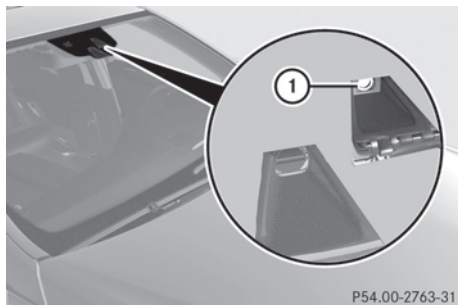

P54.00-2763-31

#### ① Active Lane Keeping Assist camera

If you select km on the on-board computer in the Display Unit Speed-/Odometer (▷ page 229) function, Active Lane Keeping Assist is activated starting at a speed of 60 km/h. If the miles display unit is selected, the assistance range begins at 40 mph.

#### **Warning**

Active Lane Keeping Assist does not keep your vehicle in its lane. It is only an aid and may detect the lane markings on the road incorrectly or not at all.

The system may be impaired or may not function if:

- several or no lane markings for a single lane are present.
- there is poor visibility, e.g. due to insufficient illumination of the road, or due to snow, rain, fog or spray.
- there is glare, e.g. from oncoming traffic, the sun, or reflection from other vehicles.
- the windshield is dirty, fogged up or covered, for instance by a sticker, in the vicinity of the camera.
- the lane markings are worn away, dark or covered up, e.g. by dirt or snow.

- the distance to the vehicle in front is too small and the lane markings thus cannot be detected.
- the lane markings on the road are unclear, e.g. near roadworks.
- the lane markings change quickly, e.g. lanes branch off, cross one another or merge.
- the road is narrow and winding.

Active Lane Keeping Assist cannot detect road and traffic conditions. It is not a substitute for attentive driving. You are responsible for the vehicle's speed, braking in good time, and steering correctly. Always adapt your driving style to suit the prevailing road and weather conditions. Always pay attention to traffic conditions and your surroundings. Otherwise, you may fail to recognize dangers in time, cause an accident and injure yourself and others.

#### **Warning vibration in the steering wheel**

A warning can be given when a front wheel passes over a lane marking. It will warn you by means of intermittent vibration in the steering wheel for up to 1.5 seconds.

In order that you are warned only when necessary and in good time if you cross the lane marking, the system recognizes certain conditions and warns you accordingly.

The warning vibration occurs earlier if:

- you approach the outer lane marking on a bend.
- the road has very wide lanes, e.g. a freeway.
- the system recognizes solid lane markings.

The warning vibration occurs later if:

- the road has narrow lanes.
- you cut the corner on a bend.

No warning vibration occurs if:

- you clearly and actively steer, brake, or accelerate.
- you cut the corner on a sharp bend.

- a driving safety system intervenes, such as ABS, BAS or ESP®.
- you switch on the turn signals. In this event, the warnings are suppressed for a certain period of time.

### Lane-correcting brake application

If you leave your lane under certain circumstances, the vehicle will brake briefly on one side. This is designed to help you bring the vehicle back into the original lane.

This function is available in the range between 40 mph and 120 mph (60 km/h and 200 km/h).

A lane-correcting brake application can only be made after driving over a solid, recognizable lane marking. You will be warned beforehand by means of an intermittent vibration in the steering wheel. In addition, a lane with lane markings on both sides must be recognized. The brake application also slightly reduces driving speed.

If a lane-correcting brake application occurs, the following message appears in the multifunction display:



- i** A further lane-correcting brake application can only occur after your vehicle has returned to the original lane.

#### **Warning**

Active Lane Keeping Assist does not keep your vehicle in its lane. It is only an aid designed to assist driving. It is not a substitute for attentive driving. In some cases, the lane-correcting brake application is not sufficient to bring your vehicle back to the original lane. In such cases, you must steer the vehicle

yourself to ensure that it does not leave the lane.

Active Lane Keeping Assist does not detect road and traffic conditions. Always make sure that there is sufficient distance to the side for other traffic or obstacles. In rare cases, unclear markings or particular structures on the roadway can be recognized as solid lane markings. An inappropriate brake application, e.g. after intentionally driving over a solid lane marking, may be interrupted at any time by steering slightly in the opposite direction.

Active Lane Keeping Assist cannot take account of weather conditions.

You are responsible for the vehicle's speed, braking in good time, and steering correctly. Always adapt your driving style to suit the prevailing road and weather conditions.

Always pay attention to traffic conditions and your surroundings. Otherwise, you may fail to recognize dangers in time, cause an accident and injure yourself and others.

No lane-correcting brake application occurs if: تلفن شبانه روزی:

- you clearly and actively steer, brake, or accelerate.
- you cut the corner on a sharp bend.
- you switch on the turn signals.
- a driving safety system intervenes, such as ESP®, PRE-SAFE® Brake or Active Blind Spot Assist.
- you have adopted a sporty driving style with high cornering speeds or high rates of acceleration.
- ESP® is deactivated.
- the transmission is not in position **D**.
- a loss of tire pressure or a defective tire has been detected and displayed.

Active Lane Keeping Assist does not detect road and traffic conditions. An inappropriate brake application may be interrupted at any time if you:

- steer slightly in the opposite direction
- use a turn signal
- clearly brake or accelerate

A lane-correcting brake application is interrupted automatically if:

- a driving safety system intervenes, such as ESP®, PRE-SAFE® Brake or Active Blind Spot Assist
- lane markings can no longer be recognized

### Activating Active Lane Keeping Assist



- ▶ Activate Active Lane Keeping Assist using the on-board computer (> page 229). Symbol ① appears in the multifunction display.

If you drive at speeds above 40 mph (60 km/h) and lane markings are detected, symbol ① is highlighted. Active Lane Keeping Assist is ready for use.

امداد خودرو

تلفن شبانه روزی: ۰۲۰۸۵۰۰۰۰۰۰۰۰

FormaSOS.com

Vehicle equipment .....	216
Important safety notes .....	216
Displays and operation .....	216
Menus and submenus .....	219
Display messages .....	234
Warning and indicator lamps in the instrument cluster .....	263

# امداد خودرو فارما

تلفن شبانه روزی: ۰۲۱-۸۸۸۶۲۰۸۵

[FarmaSOS.com](http://FarmaSOS.com)



## Vehicle equipment

- i** This manual describes all the standard and optional equipment of your vehicle which was available at the time of purchase. Country-specific differences are possible. Bear in mind that your vehicle may not feature all functions described here. This also refers to safety-related systems and functions.

## Important safety notes

You will find an illustration of the instrument cluster in the "At a glance" section (▷ page 28).

### Warning

A driver's attention to the road and traffic conditions must always be his/her primary focus when driving.

For your safety and the safety of others, selecting features through the multifunction steering wheel should only be done by the driver when traffic and road conditions permit it to be done safely.

Bear in mind that at a speed of just 30 mph (approximately 50 km/h), your vehicle is covering a distance of 44 feet (approximately 14 m) every second.

### Warning!

No messages will be displayed if either the instrument cluster or the multifunction display is inoperative.

As a result, you will not be able to see information about your driving conditions, such as

- speed
- outside temperature
- warning/indicator lamps
- malfunction/warning messages
- failure of any systems

Driving characteristics may be impaired.

If you must continue to drive, do so with added caution. Contact an authorized Mercedes-Benz Center as soon as possible.

### Warning

Malfunction and warning messages are only indicated for certain systems and are intentionally not very detailed. The malfunction and warning messages are simply a reminder with respect to the operation of certain systems. They do not replace the owner's and/or driver's responsibility to maintain the vehicle's operating safety. Have all required maintenance and safety checks performed on the vehicle. Bring the vehicle to an authorized Mercedes-Benz Center to address the malfunction and warning messages.

## Displays and operation

### Coolant temperature gauge

#### Warning

Driving when your engine is overheated can cause some fluids which may have leaked into the engine compartment to catch fire. You could be seriously burned.

Steam from an overheated engine can cause serious burns which can occur just by opening the engine hood. Stay away from the engine if you see or hear steam coming from it.

Stop the vehicle in a safe location away from other traffic. Turn off the engine, get out of the vehicle and do not stand near the vehicle until the engine has cooled down.

The coolant temperature gauge is in the instrument cluster on the right-hand side.

Under normal operating conditions and with the specified coolant level, the coolant temperature may rise to 248 °F (120 °C).

- !** If the coolant temperature is too high a display message is shown.

If the coolant temperature rises above 248 °F (120 °C), do not drive any further as this could damage the engine.

### Tachometer

The red band in the tachometer indicates the engine's overrevving range.

**!** Do not drive in the overrevving range, as this could damage the engine.

The fuel supply is interrupted to protect the engine when the red band is reached.

### Outside temperature display

The outside temperature display is in the multifunction display.

#### Warning!

The outside temperature indicator is not designed to serve as an ice-warning device and is therefore unsuitable for that purpose.

Indicated temperatures just above the freezing point do not guarantee that the road surface is free of ice. The road may still be icy, especially in wooded areas or on bridges.

Changes in the outside temperature are displayed after a short delay.

### Speedometer with segments

The segments in the speedometer indicate which speed range is available.

Cruise control mode:

The segments light up from the stored speed to the maximum speed.

DISTRONIC PLUS mode:







One or two segments around the stored speed light up.

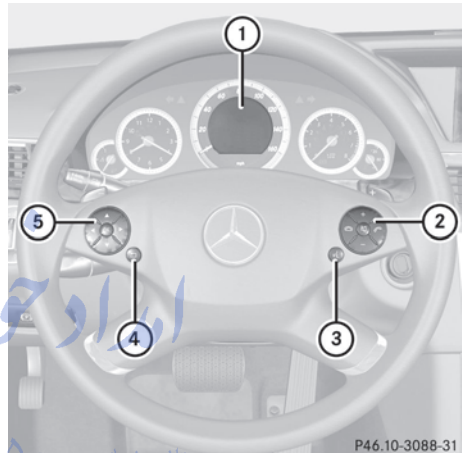







### Operating the on-board computer

The on-board computer is activated as soon as you turn the SmartKey to position 1 in the ignition lock.

You can control the multifunction display and the settings in the on-board computer using the buttons on the multifunction steering wheel.



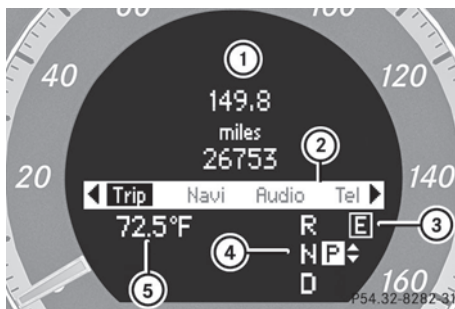

①	Multifunction display
②	 Makes/accepts or rejects/ends a call   Adjusts the volume or operates the RACETIMER in AMG vehicles  Mute
③	 Activates voice control; see the separate operating instructions
④	 <b>Press briefly:</b> Back Deactivates voice control Hides display messages

	 <b>Press and hold:</b> Selects the standard display
⑤	  Calls up the menu and menu bar
	  <b>Press briefly:</b> Selects the submenu or scrolls through lists In the Audio menu: selects a stored station, an audio track or a video scene In the Tel (telephone) menu: switches to the phone book and selects a name or telephone number
	  <b>Press and hold:</b> In the Audio menu: selects the previous/next station or selects an audio track or a video scene using rapid scrolling In the Tel (telephone) menu: starts rapid scrolling through the phone book
	 Confirms selections and hides display messages In the Tel (telephone) menu: switches to the phone book and starts dialing



- ① Text field
- ② Menu bar
- ③ Drive program indicator
- ④ Gear indicator
- ⑤ Outside temperature or speed

► **To display menu bar ②:** press the  or  button on the steering wheel.

**i** In AMG vehicles, the status indicator differs from the display shown here (► page 155).

Further information on the gear indicator (► page 155).

### Multifunction display

To activate the multifunction display:

- switch on the ignition
- switch on the lights
- open the driver's door

Values and settings as well as display messages are shown in the multifunction display.

## Menus and submenus

## Menu overview

The number of menus shown depends on the optional equipment in the vehicle.

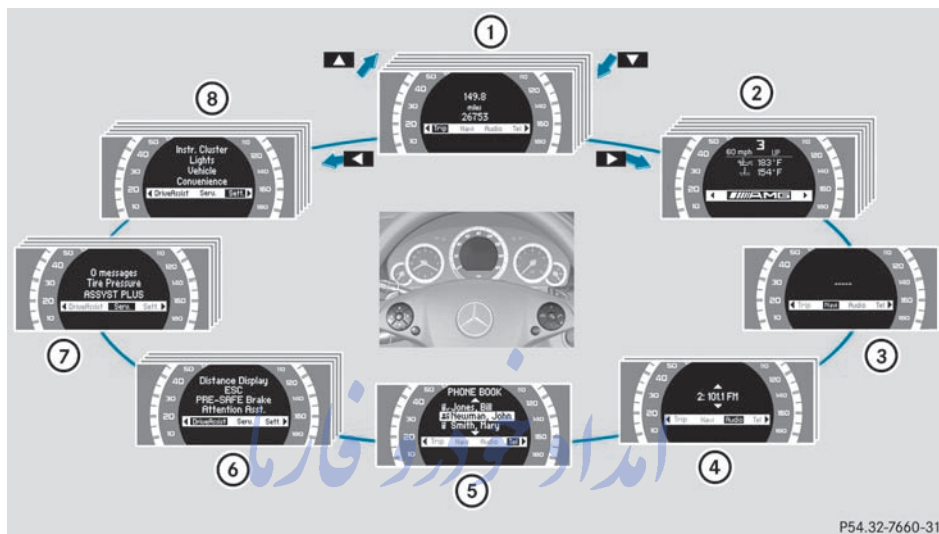

P54.32-7660-31

## Function

- تلفن شبانه روزی: ۰۲۱-۸۸۸۶۲۰۸۵
- FarmasOS.com
- ① Trip menu (▷ page 220)
  - ② AMG menu in AMG vehicles (▷ page 221)
  - ③ Navi menu (navigation instructions) (▷ page 224)
  - ④ Audio menu (▷ page 225)
  - ⑤ Tel menu (telephone) (▷ page 226)
  - ⑥ DriveAssist menu (assistance) (▷ page 227)
  - ⑦ Serv. menu (▷ page 229)
    - call up display messages (▷ page 234)
    - tire pressure loss warning system (Canada only) (▷ page 355)
    - tire pressure monitor (▷ page 357)
    - ASSYST PLUS service interval display (▷ page 313)
  - ⑧ Settings menu (▷ page 229)

## Trip menu



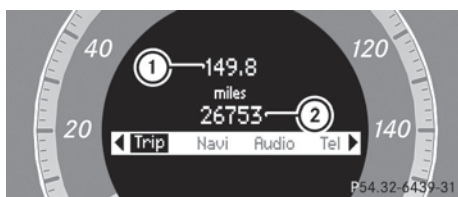

### Standard display



- ▶ Press and hold the  button on the steering wheel until the Trip menu with odometer ① and trip odometer ② is shown.

### Trip computer "From start" or "From reset"

The values in the From Start submenu are calculated from the start of a journey whilst the values in the From Reset submenu are calculated from the last time the submenu was reset.

- ▶ Press  or  on the steering wheel to select the Trip menu.
- ▶ Press  or  to select From Start or From Reset.

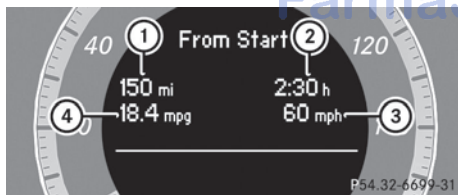

Trip computer "After start" (example)

- ① Distance
- ② Time
- ③ Average speed
- ④ Average fuel consumption





The From Start trip computer is reset automatically when

- the ignition has been switched off for more than 4 hours.
- 999 hours have been exceeded.
- 9999 miles have been exceeded.

The From Reset trip computer is automatically reset if the trip exceeds 9999 hours or 99,999 miles.

You can select km or miles as the unit of measurement for distance (> page 229).

### Displaying the range and current fuel consumption



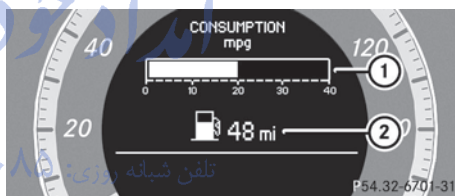

- ▶ Press  or  on the steering wheel to select the Trip menu.
- ▶ Press the  or  button to select current fuel consumption and approximate range.



- ① Current fuel consumption<sup>21</sup>
- ② Approximate range

Approximate range ② is calculated according to current driving style and the amount of fuel in the tank. If there is only a small amount of fuel left in the fuel tank, the display shows a vehicle being refueled  instead of range ②.

### Digital speedometer

- ▶ Press  or  on the steering wheel to select the Trip menu.
- ▶ Press  or  to select the digital speedometer.

<sup>21</sup> Not in AMG vehicles.

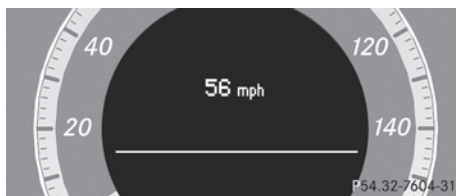

## Resetting values

You can reset the values of the following functions:

- Trip odometer
- Trip computer "From start"
- Trip computer "From reset"
- ▶ Press  or  on the steering wheel to select the Trip menu.
- ▶ Press  or  to select the function that you wish to reset.
- ▶ Press .

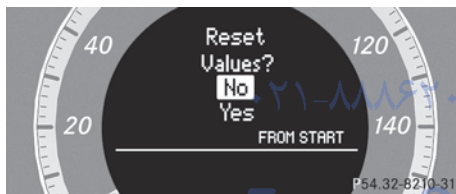

Resetting the trip computer "From start" (example)

- ▶ Press the  button to select Yes and press the  button to confirm.

## AMG menu in AMG vehicles

### AMG displays

- ▶ Press  or  on the steering wheel to select the AMG menu.

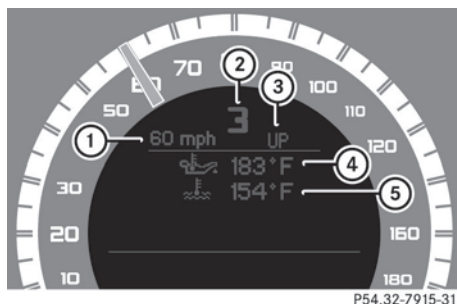

- ① Digital speedometer
- ② Gear indicator
- ③ Upshift instruction
- ④ Engine oil temperature
- ⑤ Coolant temperature

Shift UP instruction ③ indicates that the engine has reached the overrevving range when in the manual gearshift program. Shift up instruction ③ overrides other messages in the multifunction display until you have shifted up.

When the engine temperature is below 80 °C, the oil temperature gauge flashes. Avoid driving at full engine output during this time.

## SETUP

SETUP shows the drive program, the ESP® (Electronic Stability Program) mode and the SPORT handling mode.

- ▶ Press  or  on the steering wheel to select the AMG menu.
  - ▶ Press the  button repeatedly until SETUP is displayed.
- or
- ▶ Briefly press the AMG button on the center console.

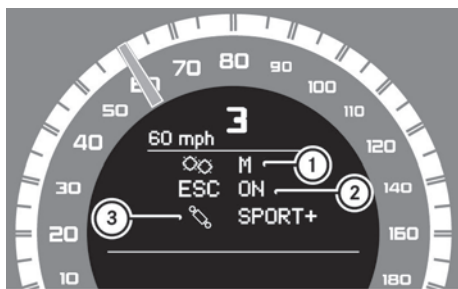

P54.32-7916-31

- ① Drive program (C/S/S+/M)
- ② ESP® mode (ON/OFF) or SPORT handling mode (SPORT)
- ③ Suspension tuning (COMFORT/SPORT/SPORT+)



## RACETIMER



### Displaying and starting RACETIMER

#### Warning

The RACETIMER feature is only for use on roads and in conditions where high speed driving is permitted. Racing on public roads is prohibited under all circumstances. The driver is and must always remain responsible for following posted speed limits.

You can use the RACETIMER to store lap times.

When RACETIMER is displayed, you cannot adjust the volume using the  and  buttons on the steering wheel.

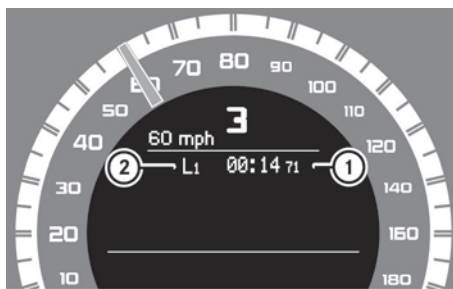

- ▶ Press  or  on the steering wheel to select the AMG menu.
- ▶ Press the  button repeatedly until the RACETIMER is shown.



P54.32-7917-31

- ① RACETIMER
- ② Lap



You can start the RACETIMER when the engine is running or if the SmartKey is in position **2** in the ignition lock.

- ▶ **To start:** press the  button to start the RACETIMER.
- ▶ **To display the intermediate time:** press  to show the intermediate time. The intermediate time is displayed for five seconds.
- ▶ **To stop:** press the  button to stop the RACETIMER. تلفن ش

The RACETIMER interrupts timing when you stop the vehicle and turn the SmartKey to position **1** in the ignition lock. When you turn the SmartKey to position **2** or **3** and then press the  button, timing is continued.

### Storing the lap time and starting a new lap

It is possible to store a maximum of sixteen laps.

- ▶ Press the  button on the steering wheel to show the intermediate time during timing. The intermediate time is displayed for five seconds.
- ▶ Press the  button again within five seconds. The displayed intermediate time is stored as a lap time. Timing starts for a new lap. The new lap is timed from when the intermediate time is called up.



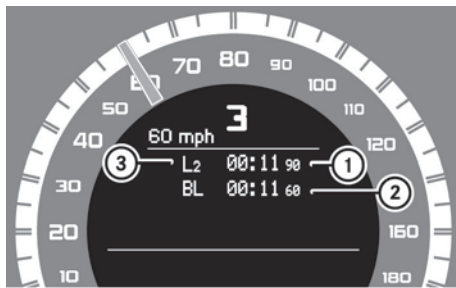

P54.32-7918-31

- ① RACETIMER
- ② Fastest lap time (best lap)
- ③ Lap

**Resetting the current lap**

- ▶ Press the  button on the steering wheel to stop the RACETIMER.
- ▶ Press  to reset the lap time to "0".

**Deleting all laps**

You cannot delete individual stored laps.

- ▶ Press the  button on the steering wheel to stop the RACETIMER.
- ▶ Press .

Reset Race-Timer? appears in the multifunction display.

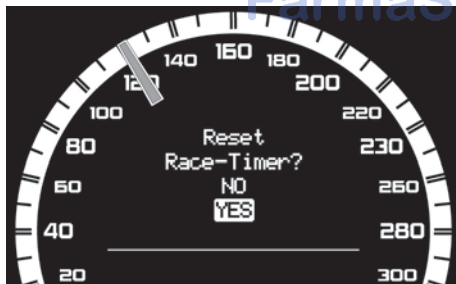

P54.32-6807-31

- ▶ Press the  button to select YES and press the  button to confirm. All laps are deleted.

**Overall evaluation**

This function is shown if you have stored at least one lap and stopped the RACETIMER.

- ▶ Press  or  on the steering wheel to select the AMG menu.
- ▶ Press the  button repeatedly until the overall evaluation is shown.

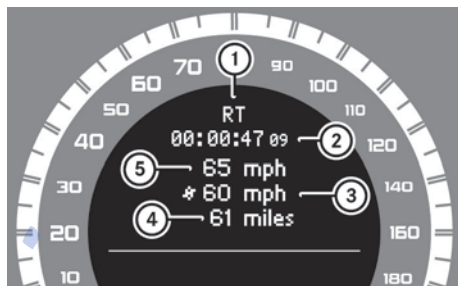

P54.32-7920-31

- ① RACETIMER overall evaluation
- ② Total time driven
- ③ Average speed
- ④ Distance covered
- ⑤ Top speed

**Lap evaluation**

This function is only available if you have stored at least two laps and have stopped the RACETIMER.

- ▶ Press  or  on the steering wheel to select the AMG menu.
- ▶ Press the  button repeatedly until the lap evaluation is shown. Each lap is shown in a separate submenu. The fastest lap is indicated by flashing symbol ①.

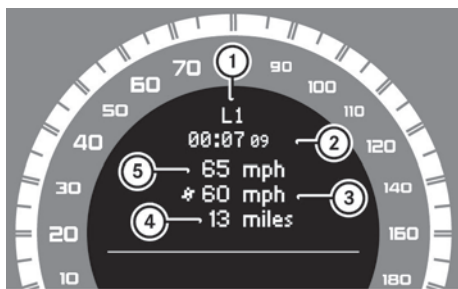

P54.32-7921-31

- ① Lap
- ② Lap time
- ③ Average lap speed
- ④ Lap length
- ⑤ Top speed during lap

▶ Press  or  to select a different lap evaluation.

## Navigation menu

### Displaying navigation instructions

In the Navi menu, the multifunction display shows navigation instructions. For more information, see the separate operating instructions.

- ▶ Switch on COMAND (see the separate operating instructions).
- ▶ Press the  or  button on the steering wheel to select the Navi menu.

### Route guidance inactive



P54.32-6445-31

- ① Direction of travel
- ② Current road

### Route guidance active

#### No change of direction announced

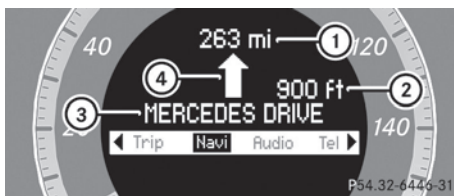

P54.32-6445-31

- ① Distance to destination
- ② Distance to next change of direction
- ③ Current road
- ④ Symbol for "follow the road's course"

#### Change of direction announced without a lane recommendation



P54.32-6447-31

- ① Road into which the change of direction leads
- ② Distance to change of direction and visual distance display
- ③ Symbol for change of direction

When a change of direction has been announced, you will see visual distance display ② next to symbol ③ for the change of direction. This decreases in size as you approach the announced change of direction.

#### Change of direction announced with a lane recommendation

Lane recommendations are only displayed if the relevant data is available on the digital map.

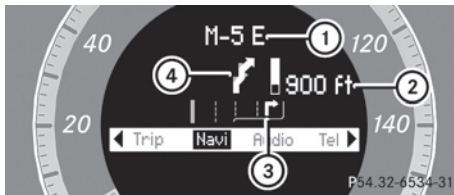

- ① Road into which the change of direction leads
- ② Distance to change of direction and visual distance display
- ③ Lane recommendation
- ④ Symbol for change of direction

On multi-lane roads, lane recommendation ③ may be shown for the next change of direction. Lanes may be added during a change of direction.



Lane recommendation display (example)

- ① Uninterrupted lane
- ② New lane during a change of direction
- ③ Lane recommended for the change of direction

### Other status indicators of the navigation system

- : you have reached the destination.
- New Route... or Calculating Route: a new route is being calculated.
- Off Map or Off Mapped Road: the vehicle position is outside the area of the digital map (off-map position).
- No Route: no route could be calculated to the selected destination.

### Audio menu

#### Selecting a radio station

❗ SIRIUS XM satellite radio acts like a normal radio.

For more information on satellite radio operation, see the separate operating instructions.

You can only change the waveband and store new stations using COMAND.

- ▶ Switch on COMAND and select Radio (see the separate operating instructions).
- ▶ Press the or button on the steering wheel to select the Audio menu.



① Waveband<sup>22</sup>

② Station تلفن شناسه زورنی

- ▶ **To select a stored channel:** briefly press the or button.
- ▶ **To select a channel from the channel list:** press and briefly hold the or button.
- ▶ **To select a station using the station search<sup>23</sup>:** press and briefly hold the or button.

#### Audio player or audio media operation

Audio data from various audio devices or media can be played, depending on the equipment installed in the vehicle.

<sup>22</sup> When station ② has been stored, the memory position will also be displayed.

<sup>23</sup> Only if no station list is received.

- ▶ Switch on COMAND and select the audio player or medium (see the separate operating instructions).
- ▶ Press the ◀ or ▶ button on the steering wheel to select the Audio menu.



CD player display (example)

① Current track

- ▶ **To select the next/previous track:** briefly press the ▲ or ▼ button.
- ▶ **To select a track from the track list (rapid scrolling):** press and hold the ▲ or ▼ button until the desired track has been reached.

If you press and hold ▲ or ▼, the rapid scrolling speed is increased. Not all audio players or media support this function.

If track information is stored on the audio player or medium, the multifunction display will show the number and name of the track. The current track does not appear in audio AUX mode (**A**uxiliary audio mode: external audio source connected).

### Video DVD operation

- ▶ Switch on COMAND APS and select video DVD (see the separate operating instructions).
- ▶ Press the ◀ or ▶ button on the steering wheel to select the Audio menu.



① Current scene

- ▶ **To select the next or previous scene:** briefly press the ▲ or the ▼ button.
- ▶ **To select a scene from the scene list (rapid scrolling):** press and hold the ▲ or ▼ button until the desired scene has been reached.

## Telephone menu

### Introduction

You can establish a Bluetooth® wireless connection to COMAND APS (see the separate operating instructions).

#### ⚠ Warning

A driver's attention to the road must always be his/her primary focus when driving. For your safety and the safety of others, we recommend that you pull over to a safe location and stop before placing or taking a telephone call. If you choose to use the telephone while driving, please use the hands-free device and only use the telephone when weather, road and traffic conditions permit.

Some jurisdictions prohibit the driver from using a mobile phone while driving a vehicle. Bear in mind that at a speed of just 30 mph (approximately 50 km/h), your vehicle is covering a distance of 44 feet (approximately 14 m) every second.

- ▶ Switch on the mobile phone and COMAND APS (see the separate operating instructions).
- ▶ Press the ◀ or ▶ button on the steering wheel to select the Tel menu.

You will see one of the following display messages in the multifunction display:

- Telephone Ready or the name of the network provider: the mobile phone has found a network and is ready to receive.
- No Service: No network is available.

## Accepting a call

If someone calls you when you are in the Tel menu, a display message appears in the multifunction display, for example:

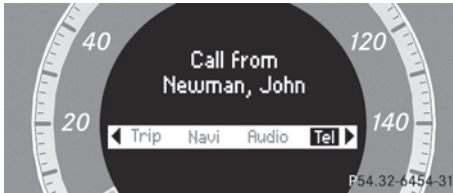

- ▶ Press on the steering wheel to accept an incoming call.

You can accept a call even if you are not in the Tel menu.

## Rejecting or ending a call

- ▶ Press the button on the steering wheel.

You can end or reject a call even if you are not in the Tel menu.

## Dialing a number from the phone book

If your mobile phone is able to receive calls, you can search for and dial a number from the phone book in COMAND at any time.

- ▶ Copy the telephone book of the mobile phone to COMAND (see the separate operating instructions).
- ▶ Press the or button on the steering wheel to select the Tel menu.
- ▶ Press the , or button to call up the phone book.
- ▶ Press or to select the name you are searching for.

To start scrolling rapidly, press and hold the or button for longer than one second. After a short time, the rapid scroll speeds up.

Rapid scrolling stops when you release the button or reach the end of the list.

- ▶ **If only one telephone number is stored for a name:** press the or button to start dialing.

or

- ▶ **If there is more than one number for a particular name:** press the or button to display the numbers.

- ▶ Press the or button to select the number you want to dial.

- ▶ Press the or button to start dialing.

or

- ▶ **If you do not want to make a call:** press the button.

## Redialing

The on-board computer saves the last names or numbers dialed in the redial memory.

- ▶ Press the or button on the steering wheel to select the Tel menu.
- ▶ Press the button to switch to the redial memory.
- ▶ Press the or button to select the desired name or number.
- ▶ Press the or button to start dialing.

## Assistance menu

### Showing the distance display

This function is only available with DISTRONIC PLUS.

- ▶ Press the or button on the steering wheel to select the DriveAssist menu.
- ▶ Press the or button to select Distance Display.
- ▶ Press .

The DISTRONIC PLUS distance display (> page 185) appears in the multifunction display.

## Deactivating/activating ESP®







### Warning!

Never switch off the ESP when you see the ESP warning lamp  flashing in the instrument cluster. In this case proceed as follows:

- When driving off, apply as little throttle as possible.
- While driving, ease up on the accelerator pedal.
- Adapt your speed and driving style to the prevailing road conditions.



Failure to observe these guidelines could cause the vehicle to skid. The ESP cannot prevent accidents resulting from excessive speed.

Further information about ESP® (▷ page 67). This function is not available in AMG vehicles.

- ▶ Start the engine.
- ▶ Press the  or  button on the steering wheel to select the DriveAssist menu.
- ▶ Press  or  to select ESP.
- ▶ Press .
- ▶ **To deactivate:** press  again.  
The  warning lamp in the instrument cluster comes on.



### Warning!

When the  ESP OFF warning lamp lights up, ESP is switched off.

When the  ESP warning lamp and the  ESP OFF warning lamp are on continuously, ESP is not operational due to a malfunction.







When ESP is switched off or not operational, the vehicle's stability during standard driving maneuvers is reduced.

Adapt your driving style to suit the prevailing road conditions/weather conditions and to the non-operating status of ESP.

- ▶ **To activate:** press  again.  
The  warning lamp in the instrument cluster goes out.







## Activating/deactivating PRE-SAFE® Brake

This function is only available with DISTRONIC PLUS.

- ▶ Press the  or  button on the steering wheel to select the DriveAssist menu.
- ▶ Press  or  to select PRE-SAFE Brake.
- ▶ Press .
- ▶ The current selection is displayed.
- ▶ **To activate/deactivate:** press  again.

When PRE-SAFE® Brake (▷ page 71) is activated, the multifunction display shows the  symbol.

## Activating/deactivating ATTENTION ASSIST

- ▶ Press the  or  button on the steering wheel to select the DriveAssist menu.
- ▶ Press the  or  button to select Attention Asst.
- ▶ Press .
- ▶ The current selection is displayed.
- ▶ **To activate/deactivate:** press  again.

When ATTENTION ASSIST (▷ page 201) is activated, the  symbol appears in the multifunction display when the ignition is on.

## Activating/deactivating Blind Spot Assist

You can use the Blind Spot Asst. function to activate or deactivate Blind Spot Assist (▷ page 205) or Active Blind Spot Assist (▷ page 209).

- ▶ Press the ◀ or ▶ button on the steering wheel to select the DriveAssist menu.
- ▶ Press the ▲ or ▼ button to select Blind Spot Asst..
- ▶ Press **OK**.  
The current selection is displayed.
- ▶ **To activate/deactivate:** press **OK** again.

### Activating/deactivating Lane Keeping Assist

You can use the Lane Keep. Asst. function to activate/deactivate Lane Keeping Assist (▷ page 207) or Active Lane Keeping Assist (▷ page 211).

- ▶ Press the ◀ or ▶ button on the steering wheel to select the DriveAssist menu.
- ▶ Press the ▲ or ▼ button to select Lane Keep. Asst..
- ▶ Press **OK**.  
The current selection is displayed.
- ▶ **To activate/deactivate:** press **OK** again.

When Lane Keeping Assist is activated, the  symbol appears in the multifunction display when the ignition is on.

### Maintenance menu



In the Serv. menu, you can:

- call up display messages (▷ page 234)
- restart the tire pressure loss warning system (Canada only) (▷ page 355)

- check the tire pressure electronically (▷ page 357)
- call up the service due date (▷ page 313)

### Settings menu

#### Introduction



In the Settings menu, you have the following options:

- Changing the instrument cluster settings
- Changing the lighting settings
- Changing the vehicle settings
- Changing the convenience settings
- Restoring the factory settings

#### Instrument cluster



##### Selecting the unit of measurement for distance

The Display Unit Speed-/Odometer: function allows you to choose whether certain displays appear in km/h or mph.

The selected unit of measurement for distance applies to:









- the digital speedometer in the Trip menu
- the odometer and the trip odometer
- the trip computer
- the navigation instructions in the Navi menu
- DISTRONIC PLUS
- ▶ Press the ◀ or ▶ button on the steering wheel to select the Settings menu.
- ▶ Press the ▼ or ▲ button to select the Instr. Cluster submenu.
- ▶ Press the **OK** button to confirm.



- ▶ Press the  or  button to select the Display Unit Speed-/Odometer. function.  
You will see the selected setting: km or miles.
- ▶ Press the  button to save the setting.

### Selecting the permanent display function

The Permanent Display: function allows you to choose whether the multifunction display always shows the outside temperature or the speed in km/h (USA) or mph (Canada).

- ▶ Press the  or  button on the steering wheel to select the Settings menu.
- ▶ Press the  or  button to select the Instr. Cluster submenu.
- ▶ Press the  button to confirm.
- ▶ Press  or  to select the Permanent Display: function.  
You will see the selected setting Outside Temperature or Speedometer [km/h]:.
- ▶ Press the  button to save the setting.

## Lights









### Switching the daytime running lamps on/off

This function is not available in Canada.









If you have activated the Daytime Running Lights: function and the light switch is in the  position the daytime running lamps are switched on automatically when the engine is running.

In the dark, the following also light up:













- the low-beam headlamps
- the parking lamps
- the tail lamps
- the license plate lamp
- the side marker lamps

- ▶ Press the  or  button on the steering wheel to select the Settings menu.
- ▶ Press the  or  button to select the Lights submenu.
- ▶ Press the  button to confirm.
- ▶ Press the  or  button to select the Daytime Running Lights: function.  
You will see the selected setting: Enabled or Disabled.
- ▶ Press the  button to save the setting.

### Switching Adaptive Highbeam Assist on/off

- ▶ Press the  or  button on the steering wheel to select the Settings menu.
- ▶ Press the  or  button to select the Lights submenu.
- ▶ Press the  button to confirm.
- ▶ Press the  or  button to select the Adaptive Highbeam Assist: function.  
You will see the selected setting: Enabled or Disabled.
- ▶ Press the  button to save the setting.

### Setting the brightness of the ambient lighting

- ▶ Press the  or  button on the steering wheel to select the Settings menu.
- ▶ Press the  or  button to select the Lights submenu.
- ▶ Press the  button to confirm.
- ▶ Press the  or  button to select the Ambient Light Brightness: function.  
You will see the selected setting.
- ▶ Press the  button to confirm.
- ▶ Press the  or  button to adjust the brightness to any level from Disabled to Level 5 (bright).
- ▶ Press the  or  button to save the setting.

### Activating/deactivating surround lighting and exterior lighting delayed switch-off

If you switch on the Locator Lighting: function and the light switch is set to **A**,

- the exterior lighting switches on when it is dark after unlocking the vehicle with the SmartKey.

The exterior lighting switches off when you open the driver's door.

- the exterior lighting remains on for 15 seconds when it is dark after closing the doors.

If the engine is switched off and then none of the doors are opened, or if an open door is not closed, the exterior lighting goes out after 60 seconds.

If you activate the Locator Lighting: function, the following light up:

- the parking lamps
  - the tail lamps
  - the fog lamps<sup>24</sup>
  - the low-beam headlamps<sup>25</sup>
  - the license plate lamp
  - the side marker lamps
- ▶ Press the **◀** or **▶** button on the steering wheel to select the Settings menu.
- ▶ Press the **▼** or **▲** button to select the Lights submenu.
- ▶ Press the **OK** button to confirm.
- ▶ Press the **▼** or **▲** button to select the Locator Lighting: function. You will see the selected setting: Enabled or Disabled.
- ▶ Press the **OK** button to save the setting.

To deactivate the delayed shut-off temporarily:

- ▶ Before leaving the vehicle, turn the SmartKey to position **0** in the ignition lock.
- ▶ Turn the SmartKey to position **2** in the ignition lock and back to position **0**. The delayed shut-off is deactivated.

The delayed shut-off is reactivated the next time you start the engine.

### Activating/deactivating the interior lighting delayed switch-off

When you activate the Interior Lighting Delay: function and remove the SmartKey from the ignition lock, the interior lighting remains on for 10 seconds.

- ▶ Press the **◀** or **▶** button on the steering wheel to select the Settings menu.
- ▶ Press the **▼** or **▲** button to select the Lights submenu.
- ▶ Press the **OK** button to confirm.
- ▶ Press the **▼** or **▲** button to select the Interior Lighting Delay: function. You will see the selected setting: Enabled or Disabled.
- ▶ Press the **OK** button to save the setting.

## Vehicle









### Activating/deactivating the automatic locking feature

If you select the Automatic Door Lock: function, the vehicle is centrally locked above a speed of around 9 mph (15 km/h).

- i** Further information on the automatic locking feature (▷ page 85).









<sup>24</sup> Only for vehicles with front fog lamps.

<sup>25</sup> Only for vehicles without front fog lamps.

- ▶ Press the  or  button on the steering wheel to select the Settings menu.
- ▶ Press the  or  button to select the Vehicle submenu.
- ▶ Press the  button to confirm.
- ▶ Press the  or  button to select the Automatic Door Lock: function. You will see the selected setting: Enabled or Disabled.
- ▶ Press the  button to save the setting.

### Activating/deactivating the acoustic locking confirmation

If you switch on the Acoustic Lock Feedback: function, an acoustic signal sounds when you lock or unlock the vehicle. When locking, it sounds three times.

- ▶ Press the  or  button on the steering wheel to select the Settings menu.
- ▶ Press the  or  button to select the Vehicle submenu.
- ▶ Press the  button to confirm.
- ▶ Press the  or  button to select the Acoustic Lock Feedback: function. You will see the selected setting: Enabled or Disabled.
- ▶ Press the  button to save the setting.

### Activating/deactivating the radar sensor system

The following systems are switched off when the radar sensor system is deactivated:

- DISTRONIC PLUS (▷ page 179)
- BAS PLUS (▷ page 66)
- PRE-SAFE® Brake (▷ page 71)
- Blind Spot Assist (▷ page 205)
- Active Blind Spot Assist (▷ page 209)

- i** USA only: This device has been approved by the FCC as a “Vehicular Radar System”. The radar sensor is intended for use in an

automotive radar system only. Removal, tampering, or altering of the device will void any warranties, and is not permitted by the FCC. Do not tamper with, alter, or use in any non-approved way.









Any unauthorized modification to this device could void the user’s authority to operate the equipment.

#### **i** Canada only:

This device complies with RSS-210 of Industry Canada. Operation is subject to the following two conditions:

1. This device may not cause interference, and
2. This device must accept any interference received, including interference that may cause undesired operation of the device.

Any unauthorized modification to this device could void the user’s authority to operate the equipment.

- ▶ Press the  or  button on the steering wheel to select the Settings menu.
- ▶ Press the  or  button to select the Vehicle submenu.
- ▶ Press the  button to confirm.
- ▶ Press the  or  button to select Radar Sensor (See Oper. Manual). You will see the selected setting: Enabled or Disabled.
- ▶ Press the  button to save the setting.

### Convenience

#### Activating/deactivating the EASY-ENTRY/EXIT feature

You can use the Easy Entry/Exit: function to activate or deactivate the easy-entry/exit feature (▷ page 112).

#### **Warning!**

You must make sure no one can become trapped or injured by the moving steering

wheel when the easy-entry/exit feature is activated.

To stop steering wheel movement, move steering wheel adjustment lever or press one of the memory position buttons.

Do not leave children unattended in the vehicle, or with access to an unlocked vehicle. Children could open the driver's door and unintentionally activate the easy-entry/exit feature, which could result in an accident and/or serious personal injury.

- ▶ Press the ◀ or ▶ button on the steering wheel to select the Settings menu.
- ▶ Press the ▼ or ▲ button to select the Convenience submenu.
- ▶ Press the OK button to confirm.
- ▶ Press the ▼ or ▲ button to select the Easy Entry/Exit: feature.  
You will see the selected setting: Enabled or Disabled.
- ▶ Press the OK button to save the setting.

### Switching the belt adjustment on/off

Further information on belt adjustment (▷ page 56).

- ▶ Press the ◀ or ▶ button on the steering wheel to select the Settings menu.
- ▶ Press the ▼ or ▲ button to select the Convenience submenu.
- ▶ Press the OK button to confirm.
- ▶ Press the ▼ or ▲ button to select the Belt Adjustment: function.  
You will see the selected setting: Enabled or Disabled.
- ▶ Press the OK button to save the setting.

### Resetting to factory settings

For safety reasons, the Daytime Running Lights: function in the Lights submenu is only reset if the vehicle is stationary.

- ▶ Press the ◀ or ▶ button on the steering wheel to select the Settings menu.
- ▶ Press the ▼ or ▲ button to select the Factory Setting submenu.
- ▶ Press the OK button to confirm.  
The Reset All Settings? message appears.
- ▶ Press the ▼ or ▲ button to select No or Yes.
- ▶ Press the OK button to confirm the selection.  
If you have selected Yes, the multifunction display shows a confirmation message.

تلفن شبانه روزی: ۰۲۱-۸۸۸۶۰۸۵

FarmaSOS.com

## Display messages



### Hiding display messages

#### Warning

All categories of messages contain important information which should be taken note of and, where a malfunction is indicated, addressed as soon as possible at an authorized Mercedes-Benz Center.

Failure to repair the condition noted may cause damage not covered by the Mercedes-Benz Limited Warranty, or result in property damage or personal injury.

Display messages appear in the multifunction display.

- ▶ Press the  or  button on the steering wheel to hide the display message. The display message is cleared.

The multifunction display shows high-priority display messages in red.







You cannot hide display messages of the highest priority. The multifunction display shows these messages continuously until the causes for the messages have been remedied.

Certain display messages are accompanied by an audible warning tone or a continuous tone. Please respond in accordance with the display messages and follow the additional notes in this Operator's Manual.







When you stop and park the vehicle, please observe the notes on HOLD (▷ page 188) and parking (▷ page 169).





### Message memory

The on-board computer saves certain display messages. You can call up the display messages in the **message memory**.

- ▶ Press the  or  button on the steering wheel to select the Service menu. If there are display messages, the multifunction display shows, for example, 2 messages.
- ▶ Press the  or  button to select the entry, e.g. 2 messages.
- ▶ Confirm with .
- ▶ Press the  or  button to scroll through the display messages.

When the ignition is switched off, all display messages are deleted apart from some high-priority display messages. Once the causes of the high-priority display messages have been rectified, the corresponding display messages are also deleted.

Safety systems	
Display messages	Possible causes/consequences and ► Solutions
 <p>Inoperative See Operator's Manual</p>	<p> <b>Risk of accident</b></p> <p>ESP® (Electronic Stability Program), BAS (Brake Assist), PRE-SAFE®, the HOLD function and hill start assist are not available due to a malfunction. BAS PLUS (Brake Assist PLUS) and PRE-SAFE® Brake may be inoperative as well. In addition, the  and  warning lamps light up in the instrument cluster. ATTENTION ASSIST is deactivated.</p> <p>The brake system continues to function normally, but without the functions listed above.</p> <ul style="list-style-type: none"> <li>► Drive on carefully.</li> <li>► Visit a qualified specialist workshop.</li> </ul>
 <p>Tele Aid Inoperative</p>	<p>USA only: one or more main functions in the mbrace system are malfunctioning.</p> <p>Canada only: one or more of the main functions of the TELEAID system is malfunctioning.</p> <ul style="list-style-type: none"> <li>► USA only: have the mbrace system checked at a qualified specialist workshop.</li> <li>► Canada only: have the TELEAID system checked at a qualified specialist workshop.</li> </ul>
<p>PRE-SAFE Inoperative See Operator's Manual</p>	<p> <b>Risk of injury</b></p> <p>Important functions of PRE-SAFE® have failed. All other occupant safety systems, e.g. air bags, remain available.</p> <ul style="list-style-type: none"> <li>► Visit a qualified specialist workshop immediately.</li> </ul>

Display messages	Possible causes/consequences and ► Solutions
<p>PRE-SAFE Function Currently Limited See Oper. Manual</p>	<p> <b>Risk of accident</b></p> <p>PRE-SAFE® Brake is temporarily inoperative if:</p> <ul style="list-style-type: none"> <li>• the DISTRONIC PLUS cover in the radiator grill is dirty.</li> <li>• the sensors in the bumpers are dirty.</li> <li>• its function is impaired due to heavy rain or snow.</li> <li>• the radar sensor system is temporarily inoperative, e.g. due to electromagnetic radiation emitted by nearby TV or radio stations or other sources of electromagnetic radiation.</li> <li>• the system is outside the operating temperature range.</li> <li>• the on-board voltage is insufficient.</li> <li>• E 63 AMG: you deactivate ESP®.</li> </ul> <p>PRE-SAFE® Brake is operational again and the display message disappears when:</p> <ul style="list-style-type: none"> <li>• the dirt (e.g. slush) drops away while the vehicle is in motion.</li> <li>• the system detects that the sensors are fully available again.</li> <li>• the system is within the operating temperature range.</li> <li>• E 63 AMG: you reactivate ESP®.</li> </ul> <p>If the display message continues to be displayed:</p> <ul style="list-style-type: none"> <li>► Clean the DISTRONIC PLUS cover in the radiator grill (&gt; page 317).</li> <li>► Clean the bumpers (&gt; page 317).</li> <li>► Restart the engine.</li> <li>► Wait until the battery is sufficiently charged.</li> </ul>
<p>PRE-SAFE Functions Limited See Operator's Manual</p>	<p> <b>Risk of accident</b></p> <p>PRE-SAFE® Brake is faulty. BAS PLUS or the distance warning signal may also have failed.</p> <ul style="list-style-type: none"> <li>► Visit a qualified specialist workshop.</li> </ul>
<p>Check Child Seat Pos. See Operator's Manual</p>	<p> <b>Risk of injury</b></p> <p>Vehicles with BabySmart™ (Canada only): The BabySmart™ child seat is positioned incorrectly.</p> <ul style="list-style-type: none"> <li>► Install the child seat in the correct position.</li> </ul> <p> <b>Risk of injury</b></p> <p>Vehicles with BabySmart™ (Canada only): The sensor for automatic child seat recognition is faulty.</p> <ul style="list-style-type: none"> <li>► Visit a qualified specialist workshop.</li> </ul>



Display messages	Possible causes/consequences and ► Solutions
 <p>SRS Malfunction Service Required</p>	<p> <b>Risk of injury</b></p> <p>There is a malfunction in the SRS (Supplemental Restraint System). The  warning lamp also lights up in the instrument cluster.</p> <p>► Visit a qualified specialist workshop.</p>
 <p>Front Left SRS Malfunction Service Required or Front Right SRS Malfunction Service Required</p>	<p> <b>Risk of injury</b></p> <p>SRS has malfunctioned at the front on the left or right. The  warning lamp also lights up in the instrument cluster.</p> <p>► Visit a qualified specialist workshop.</p>
 <p>Rear Left SRS Malfunction Service Required or Rear Right SRS Malfunction Service Required</p>	<p> <b>Risk of injury</b></p> <p>SRS has malfunctioned at the rear on the left or right. The  warning lamp also lights up in the instrument cluster.</p> <p>► Visit a qualified specialist workshop.</p>
 <p>Rear Center SRS Malfunction Service Required</p>	<p> <b>Risk of injury</b></p> <p>SRS has malfunctioned at the rear center. The  warning lamp also lights up in the instrument cluster.</p> <p>► Visit a qualified specialist workshop.</p>
 <p>Left Side Curtain Airbag Malfunction Service Required or Right Side Curtain Airbag Malfunction Service Required</p>	<p> <b>Risk of injury</b></p> <p>There is a malfunction in the left-hand and/or right-hand window curtain air bag. The  warning lamp also lights up in the instrument cluster.</p> <p>► Visit a qualified specialist workshop.</p>

 **Warning**



In the event a malfunction of the SRS is indicated as outlined above, the SRS may not be operational.

For your safety, we strongly recommend that you contact an authorized Mercedes-Benz Center immediately to have the system checked. Otherwise the SRS may not be activated when needed in an accident, which could result in serious or fatal injury, or it might deploy unexpectedly and unnecessarily which could also result in injury.

امداد خودرو فارما



تلفن شبانه روزی: ۰۲۱-۸۸۸۶۲۰۸۵

FarmaSOS.com

Display messages	Possible causes/consequences and ► Solutions
<p>Front Passenger Airbag Enabled See Operator's Manual</p>	<p>The front-passenger air bag is enabled during the journey, although:</p> <ul style="list-style-type: none"> <li>• there is a child, a small adult or an object weighing less than the system's weight threshold on the front-passenger seat.</li> <li>• the front-passenger seat is unoccupied.</li> </ul> <p>The system may detect the additional weight of objects on the seat or forces acting on the seat.</p> <ul style="list-style-type: none"> <li>► Pull over and stop the vehicle safely as soon as possible, paying attention to road and traffic conditions.</li> <li>► Engage the parking brake.</li> <li>► Switch off the ignition.</li> <li>► Open the front-passenger door.</li> <li>► Remove the child and the child restraint system from the front-passenger seat.</li> <li>► If necessary, secure the child in a child restraint system on a suitable rear seat.</li> <li>► Make sure that there are no objects adding to the weight applied to the seat. The system may otherwise detect the additional weight and interpret the seat occupant's weight as greater than it actually is.</li> <li>► Make sure that the seat is unoccupied and has no objects placed on it, close the front-passenger door, and switch on the ignition.</li> </ul> <p>Observe the  <b>PASS AIR BAG OFF</b> (► page 43) indicator lamps and the multifunction display and check the following: Seat unoccupied and ignition switched on:</p> <ul style="list-style-type: none"> <li>• the  <b>PASS AIR BAG OFF</b> indicator lamp must light up and remain lit. When the indicator lamp is on, OCS (► page 43) has deactivated the front-passenger air bag.</li> <li>• The Front Passenger Airbag Enabled See Operator's Manual or Front Passenger Airbag Disabled See Operator's Manual display messages must not appear. Wait for at least 60 seconds until the necessary system checks have been completed and to make sure that the display messages do not appear in the multifunction display.</li> </ul> <p>If these conditions are met, the front-passenger seat can be occupied again. Whether the  <b>PASS AIR BAG OFF</b> indicator lamp remains lit or goes out depends on how OCS classifies the occupant.</p> <p>If the conditions are not met, the system is not operating correctly.</p> <ul style="list-style-type: none"> <li>► Visit a qualified specialist workshop immediately.</li> </ul>











### Warning















If the  indicator lamp remains off even after performing the above corrective steps, do not have any children 12 years old and under and other small individuals use the front-passenger seat until the system has been repaired.

Display messages	Possible causes/consequences and ► Solutions
Front Passenger Airbag Disabled See Operator's Manual	<p>The front-passenger air bag is deactivated during the journey even though an adult or a person larger than a certain size is occupying the front-passenger seat. If additional forces are applied to the seat, the system may interpret the occupant's weight as lower than it actually is.</p> <ul style="list-style-type: none"> <li>► Pull over and stop the vehicle safely as soon as possible, paying attention to road and traffic conditions.</li> <li>► Engage the parking brake.</li> <li>► Switch off the ignition.</li> <li>► Have the occupant get out of the vehicle.</li> <li>► Make sure that the seat is unoccupied and has no objects placed on it, close the front-passenger door, and switch on the ignition.</li> </ul> <p>Observe the  (► page 43) indicator lamps and the multifunction display and check the following:</p> <p>Seat unoccupied and ignition switched on:</p> <ul style="list-style-type: none"> <li>• the  indicator lamp must light up and remain lit. When the indicator lamp is on, OCS (► page 43) has deactivated the front-passenger air bag.</li> <li>• The Front Passenger Airbag Enabled See Operator's Manual or Front Passenger Airbag Disabled See Operator's Manual display messages must not appear. Wait for at least 60 seconds until the necessary system checks have been completed and to make sure that the display messages do not appear in the multifunction display.</li> </ul> <p>If these conditions are met, the front-passenger seat can be occupied again. Whether the  indicator lamp remains lit or goes out depends on how OCS classifies the occupant.</p> <p>If the conditions are not met, the system is not operating correctly.</p> <ul style="list-style-type: none"> <li>► Visit a qualified specialist workshop immediately.</li> </ul>

### Warning

If the  indicator lamp remains lit with an adult occupant on the front-passenger seat even after performing the above corrective steps, do not have any passenger use the front-passenger seat until the system has been repaired.

Brakes	
Display messages	Possible causes/consequences and ► Solutions
<p><b>BRAKE</b> (USA only)</p> <p> (Canada only)</p> <p>ABS and ESC Currently Unavailable See Operator's Manual</p>	<p> <b>Risk of accident</b></p> <p>ABS (Anti-lock Braking System), ESP<sup>®</sup> (Electronic Stability Program), BAS (Brake Assist), PRE-SAFE<sup>®</sup>, HOLD and hill start assist are temporarily unavailable. The on-board voltage may be insufficient, for example. BAS PLUS (Brake Assist PLUS) and PRE-SAFE<sup>®</sup> Brake may be inoperative as well. In addition, the ,  and  warning lamps light up in the instrument cluster. ATTENTION ASSIST is deactivated.</p> <p>The brake system continues to function normally, but without the functions listed above. The wheels could therefore lock if you brake hard, for example.</p> <ul style="list-style-type: none"> <li>► Drive on carefully.</li> <li>    If the display message disappears, the functions mentioned above are available again.</li> </ul> <p>If the display message continues to be displayed:</p> <ul style="list-style-type: none"> <li>► Drive on carefully.</li> <li>► Visit a qualified specialist workshop.</li> </ul>
<p><b>BRAKE</b> (USA only)</p> <p> (Canada only)</p> <p>ABS and ESC Inoperative See Operator's Manual</p>	<p> <b>Risk of accident</b> • تلفن شبانه روزی: ۰۲۱۱۱۱۱۱۱۱</p> <p>ABS, ESP<sup>®</sup>, BAS, PRE-SAFE<sup>®</sup>, HOLD and hill start assist are unavailable due to a malfunction. BAS PLUS and PRE-SAFE<sup>®</sup> Brake may also have failed. In addition, the ,  and  warning lamps light up in the instrument cluster. ATTENTION ASSIST is deactivated.</p> <p>The brake system continues to function normally, but without the functions listed above. The wheels could therefore lock if you brake hard, for example.</p> <ul style="list-style-type: none"> <li>► Drive on carefully.</li> <li>► Visit a qualified specialist workshop.</li> </ul>

Display messages	Possible causes/consequences and ► Solutions
 (USA only)  (Canada only) EBD, ABS, and ESC Inoperative See Operator's Manual	<p> <b>Risk of accident</b></p> <p>EBD (Electronic Brake force Distribution), ABS, ESP®, BAS, PRE-SAFE®, HOLD and hill start assist are unavailable due to a malfunction. BAS PLUS and PRE-SAFE® Brake may also have failed. In addition, the ,  and  warning lamps in the instrument cluster light up and a warning tone sounds. ATTENTION ASSIST is deactivated.</p> <p>The brake system continues to function normally, but without the functions listed above. The wheels could therefore lock if you brake hard, for example.</p> <ul style="list-style-type: none"> <li>► Drive on carefully.</li> <li>► Visit a qualified specialist workshop immediately.</li> </ul>
 Check Brake Pad Wear	<p>The brake pads/linings have reached their wear limit.</p> <ul style="list-style-type: none"> <li>► Visit a qualified specialist workshop.</li> </ul>
 (USA only)  (Canada only) Release Park. Brake	<p>You are driving with the parking brake engaged. A warning tone also sounds.</p> <ul style="list-style-type: none"> <li>► Release the parking brake.</li> </ul>
 (USA only)  (Canada only) Check Brake Fluid Level	<p> <b>Risk of accident</b></p> <p>There is insufficient brake fluid in the brake fluid reservoir. Additionally, the red  (USA only) /  (Canada only) warning lamp lights up in the instrument cluster and a warning tone sounds.</p> <ul style="list-style-type: none"> <li>► Pull over and stop the vehicle safely as soon as possible, paying attention to road and traffic conditions. Do not continue driving under any circumstances.</li> <li>► Engage the parking brake.</li> <li>► Consult a qualified specialist workshop.</li> <li>► Do not add brake fluid. This will not rectify the malfunction.</li> </ul>

 **Warning**





Driving with the message Check Brake Fluid Level displayed can result in an accident. Have your brake system checked immediately.

Do not add brake fluid before checking the brake system. Overfilling the brake fluid reservoir can result in spilling brake fluid on hot engine parts and the brake fluid catching fire. You can be seriously burned.







## Lights

**i** Display messages about LEDs:





This display message will only appear if all LEDs have failed.

Display messages	Possible causes/consequences and ► Solutions
 Check Left Cornering Light or Check Right Cornering Light	The left or right-hand cornering light is faulty. ► Check whether you are permitted to change the bulb yourself (▷ page 124). or ► Visit a qualified specialist workshop.
 Check Left Low Beam or Check Right Low Beam	The left or right-hand low-beam headlamp is faulty. ► Check whether you are permitted to change the bulb yourself (▷ page 124). or ► Visit a qualified specialist workshop.
 Check Rear Left Turn Signal or Check Rear Right Turn Signal	The rear left-hand or rear right-hand turn signal is faulty. ► Check whether you are permitted to change the bulb yourself (▷ page 124). or ► Visit a qualified specialist workshop.
 Check Front Left Turn Signal or Check Front Right Turn Signal	The front left-hand or front right-hand turn signal is faulty. ► Check whether you are permitted to change the bulb yourself (▷ page 124). or ► Visit a qualified specialist workshop.
 Check Left Mirror Turn Signal or Check Right Mirror Turn Signal	The turn signal in the left-hand and/or right-hand exterior mirror is faulty. ► Check whether you are permitted to change the bulb yourself (▷ page 124). or ► Visit a qualified specialist workshop.



Display messages	Possible causes/consequences and ► Solutions
 <p>Check Center Brake Lamp</p>	<p>The high-mounted brake lamp is faulty.</p> <ul style="list-style-type: none"> <li>► Check whether you are permitted to change the bulb yourself (▷ page 124).</li> </ul> <p>or</p> <ul style="list-style-type: none"> <li>► Visit a qualified specialist workshop.</li> </ul>
 <p>Check Left Tail and Brake Lamps or Check Right Tail and Brake Lamps</p>	<p>The left or right brake/tail lamp is faulty.</p> <ul style="list-style-type: none"> <li>► Check whether you are permitted to change the bulb yourself (▷ page 124).</li> </ul> <p>or</p> <ul style="list-style-type: none"> <li>► Visit a qualified specialist workshop.</li> </ul>
 <p>Check Left High Beam or Check Right High Beam</p>	<p>The left or right-hand high beam is faulty.</p> <ul style="list-style-type: none"> <li>► Check whether you are permitted to change the bulb yourself (▷ page 124).</li> </ul> <p>or</p> <ul style="list-style-type: none"> <li>► Visit a qualified specialist workshop.</li> </ul>
 <p>Check Left License Plate Lamp or Check Right License Plate Lamp</p>	<p>The left or right-hand license plate lamp is faulty.</p> <ul style="list-style-type: none"> <li>► Check whether you are permitted to change the bulb yourself (▷ page 124).</li> </ul> <p>or</p> <ul style="list-style-type: none"> <li>► Visit a qualified specialist workshop.</li> </ul>
 <p>Check Left Fog Lamp or Check Front Fog Lamp</p>	<p>The left-hand or right-hand front fog lamp is faulty.</p> <ul style="list-style-type: none"> <li>► Check whether you are permitted to change the bulb yourself (▷ page 124).</li> </ul> <p>or</p> <ul style="list-style-type: none"> <li>► Visit a qualified specialist workshop.</li> </ul>
 <p>Check Rear Left Fog Lamp or Check Rear Right Fog Lamp</p>	<p>The left-hand or right-hand rear fog lamp is faulty.</p> <ul style="list-style-type: none"> <li>► Check whether you are permitted to change the bulb yourself (▷ page 124).</li> </ul> <p>or</p> <ul style="list-style-type: none"> <li>► Visit a qualified specialist workshop.</li> </ul>

Display messages	Possible causes/consequences and ► Solutions
 <p>Check Front Left Parking Lamp or Check Front Right Parking Lamp</p>	<p>The front left or front right standing lamp is faulty.</p> <ul style="list-style-type: none"> <li>► Check whether you are permitted to change the bulb yourself (▷ page 124).</li> </ul> <p>or</p> <ul style="list-style-type: none"> <li>► Visit a qualified specialist workshop.</li> </ul>
 <p>Check Left Reverse Lamp or Check Right Reverse Lamp</p>	<p>The left or right-hand backup lamp is faulty.</p> <ul style="list-style-type: none"> <li>► Check whether you are permitted to change the bulb yourself (▷ page 124).</li> </ul> <p>or</p> <ul style="list-style-type: none"> <li>► Visit a qualified specialist workshop.</li> </ul>
 <p>Check Front Left Sidemarkers Lamp or Check Front Right Sidemarkers Lamp</p>	<p>The front left or right side marker lamp is faulty.</p> <ul style="list-style-type: none"> <li>► Check whether you are permitted to change the bulb yourself (▷ page 124).</li> </ul> <p>or</p> <ul style="list-style-type: none"> <li>► Visit a qualified specialist workshop.</li> </ul>
 <p>Check Rear Left Sidemarkers Lamp or Check Rear Right Sidemarkers Lamp</p>	<p>The rear left or right side marker lamp is faulty.</p> <ul style="list-style-type: none"> <li>► Check whether you are permitted to change the bulb yourself (▷ page 124).</li> </ul> <p>or</p> <ul style="list-style-type: none"> <li>► Visit a qualified specialist workshop.</li> </ul>
 <p>Check Left Daytime Running Light or Check Right Daytime Running Light</p>	<p>The left or right-hand daytime running light is defective.</p> <ul style="list-style-type: none"> <li>► Check whether you are permitted to change the bulb yourself (▷ page 124).</li> </ul> <p>or</p> <ul style="list-style-type: none"> <li>► Visit a qualified specialist workshop.</li> </ul>
 <p>Active Headlamps Inoperative</p>	<p>The active light function is faulty.</p> <ul style="list-style-type: none"> <li>► Visit a qualified specialist workshop.</li> </ul>

Display messages	Possible causes/consequences and ► Solutions
 Malfunction See Operator's Manual	The exterior lighting is faulty. ► Visit a qualified specialist workshop.
 Auto Lamp Function Inoperative	The light sensor is faulty. ► Visit a qualified specialist workshop.
 Switch Off Lights	The lights are still switched on when you leave the vehicle. A warning tone also sounds. ► Turn the light switch to  .
Adaptive Highbeam Assist Inoperative	Adaptive Highbeam Assist is faulty. ► Visit a qualified specialist workshop.
Adaptive Highbeam Assist Currently Unavailable See Operator's Manual	Adaptive Highbeam Assist is deactivated and temporarily inoperative, if: <ul style="list-style-type: none"> <li>• the windshield is dirty in the camera's field of vision.</li> <li>• visibility is impaired due to heavy rain, snow or fog.</li> </ul> ► Clean the windshield. Adaptive Highbeam Assist is available again, if: <ul style="list-style-type: none"> <li>• the dirt (e.g. slush) drops away while the vehicle is in motion.</li> <li>• the system detects that the camera is fully operational again.</li> </ul> The Adaptive Highbeam Assist Now Available message is displayed.

## Engine

Display messages	Possible causes/consequences and ► Solutions
 Check Coolant Level See Operator's Manual	The coolant level is too low. ► Add coolant, observing the warning notes when doing so (> page 311). ► If coolant needs adding more often than usual, have the engine coolant system checked at a qualified specialist workshop.

### Warning

Do not spill antifreeze on hot engine parts. Antifreeze contains ethylene glycol which may burn if it comes into contact with hot engine parts. You could be seriously burned.

**!** The coolant level is too low. Avoid making long journeys with too little coolant in the cooling system. The engine will otherwise be damaged.

The display messages and the corresponding symbol that indicate that the coolant level is too low must not be ignored.

Display messages	Possible causes/consequences and ► Solutions
 <p>Coolant Level Low Stop Vehicle Turn Engine Off</p>	<p>The coolant is too hot.</p> <ul style="list-style-type: none"> <li>▶ Pull over and stop the vehicle safely as soon as possible, paying attention to road and traffic conditions.</li> <li>▶ Make sure that the air supply to the radiator is not blocked, e.g. by snow, slush or ice.</li> <li>▶ Wait until the display message disappears before restarting the engine. There is otherwise a risk of engine damage.</li> <li>▶ Pay attention to the coolant temperature display.</li> <li>▶ If the temperature increases again, visit a qualified specialist workshop immediately.</li> </ul>
	<p>The poly-V-belt may have torn.</p> <ul style="list-style-type: none"> <li>▶ Pull over and stop the vehicle safely as soon as possible, paying attention to road and traffic conditions.</li> <li>▶ Open the hood.</li> <li>▶ Check whether the poly-V-belt is torn.</li> </ul> <p><b>If the poly-V-belt is torn:</b> <small>تلفن شبانه روز</small></p> <p><b>!</b> Do not continue driving. The engine could otherwise overheat.</p> <ul style="list-style-type: none"> <li>▶ Consult a qualified specialist workshop.</li> </ul> <p><b>If the poly-V-belt is OK:</b></p> <ul style="list-style-type: none"> <li>▶ Wait until the display message disappears before restarting the engine. There is otherwise a risk of engine damage.</li> <li>▶ Pay attention to the coolant temperature display.</li> <li>▶ Visit a qualified specialist workshop.</li> </ul>



### Warning

Driving when your engine is overheated can cause some fluids which may have leaked into the engine compartment to catch fire. You could be seriously burned.

Steam from an overheated engine can cause serious burns which can occur just by opening the engine hood. Stay away from the engine if you see or hear steam coming from it.

Stop the vehicle in a safe location away from other traffic. Turn off the engine, get out of the vehicle and do not stand near the vehicle until the engine has cooled down.









**!** If the coolant temperature exceeds 248 °F(120 °C) do not continue driving. The engine will otherwise be damaged.





Display messages	Possible causes/consequences and ► Solutions
	<p>The engine fan is faulty.</p> <ul style="list-style-type: none"> <li>► At coolant temperatures below 248 °F (120 °C), continue driving to the next qualified specialist workshop.</li> <li>► Avoid subjecting the engine to heavy loads, e.g. driving in mountainous terrain, and stop-start driving.</li> </ul>
	<p>The battery is not being charged.</p> <p>Possible causes are:</p> <ul style="list-style-type: none"> <li>• a faulty alternator</li> <li>• a torn poly-V-belt</li> <li>• a malfunction in the electronics</li> </ul> <ul style="list-style-type: none"> <li>► Pull over and stop the vehicle safely and switch off the engine, paying attention to road and traffic conditions.</li> <li>► Open the hood.</li> <li>► Check whether the poly-V-belt is torn.</li> </ul> <p><b>If the poly-V-belt is torn:</b></p> <ul style="list-style-type: none"> <li>! Do not continue driving. The engine could otherwise overheat.</li> <li>► Consult a qualified specialist workshop.</li> </ul> <p><b>If the poly-V-belt is OK:</b></p> <ul style="list-style-type: none"> <li>► Visit a qualified specialist workshop.</li> </ul>
 <p>Check Engine Oil At Next Refueling Check Engine Oil at Next Refueling</p>	<p>The engine oil level has dropped to a critical level. A warning tone also sounds.</p> <ul style="list-style-type: none"> <li>► Check the oil level (► page 309).</li> <li>► If necessary, add the engine oil (► page 310).</li> <li>► Have the engine checked for leaks if engine oil has to be added more often than usual.</li> </ul>

Information on approved engine oils can be obtained from any qualified specialist workshop or on the Internet at <http://www.mbusa.com> (USA only).



**!** The oil level is too low. Avoid long journeys with too little engine oil. There is a risk of engine damage.



The display messages and the corresponding symbol that indicate that the oil level is too low must not be ignored.

Display messages	Possible causes/consequences and ► Solutions
	There is only a small amount of fuel in the fuel tank. ► Refuel at the nearest gas station.
 Fuel Level Low	The fuel level has dropped into the reserve range. ► Refuel at the nearest gas station.
 Gas Cap Loose	The fuel system pressure is too low. The fuel filler cap is not closed correctly or the fuel system is leaking. ► Check that the fuel filler cap is correctly closed. ► <b>If the fuel filler cap is not correctly closed:</b> close the fuel filler cap. ► <b>If the fuel filler cap is closed:</b> visit a qualified specialist workshop.
 Ultra Low-sulfur Diesel Fuel Only	Vehicles with a diesel engine: the fuel level has fallen below the reserve range. ► Check that the fuel filler cap is correctly closed. ► Refuel at the nearest gas station. ► Only use commercially available vehicular ULTRA-LOW SULFUR HIGHWAY DIESEL FUEL (ULSD, 15 ppm SULFUR MAXIMUM).
 Replace Air Filter	Vehicles with a diesel engine: the engine air filter is dirty and must be replaced. ► Visit a qualified specialist workshop.
 Check Fuel Filter	Vehicles with a diesel engine: there is water in the fuel filter. The water must be drained off. ► Visit a qualified specialist workshop.
 Check Additive See Operator's Manual	The AdBlue® tank is empty. ► Have the AdBlue® tank filled as soon as possible at a qualified specialist workshop (► page 167). Visit a qualified specialist workshop.
 Remaining Starts: 20	The AdBlue® level has fallen to a minimum. ► Have the AdBlue® tank filled as soon as possible at a qualified specialist workshop (► page 167). Visit a qualified specialist workshop.

Driving systems	
Display messages	Possible causes/consequences and ► Solutions
 Attention Assist Drowsiness Detected	<p>Based on specific criteria, ATTENTION ASSIST has determined tiredness or a decrease in attention. A warning tone also sounds.</p> <ul style="list-style-type: none"> <li>► If necessary, take a break.</li> </ul> <p>During long journeys, take regular breaks in good time so you get enough rest.</p>
 Attention Assist Inoperative	<p>ATTENTION ASSIST has failed.</p> <ul style="list-style-type: none"> <li>► Visit a qualified specialist workshop.</li> </ul>
 Vehicle Rising	<p>Your vehicle is adjusting to the level you have selected.</p>
 Vehicle Rising Please Wait	<p>The vehicle level is too low when the vehicle is stationary. A warning tone also sounds.</p> <ul style="list-style-type: none"> <li>► Do not pull away.</li> </ul> <p>When the display message goes out, the vehicle level is set.</p>
 Pull Over Car Too Low	<p>You have pulled away while the vehicle level is still too low. AIRMATIC sets the vehicle to the selected level after a short period.</p> <ul style="list-style-type: none"> <li>► Pull over and stop the vehicle safely as soon as possible, paying attention to road and traffic conditions.</li> <li>► Apply the parking brake.</li> <li>► Wait until the display message disappears before pulling away.</li> </ul> <p><b>⚠ Risk of accident</b></p> <p>AIRMATIC is faulty. A warning tone also sounds.</p> <ul style="list-style-type: none"> <li>► Drive no faster than 50 mph (80 km/h).</li> <li>► Make only slight steering movements. The front fender or the tires could otherwise be damaged when the steering movement is too large.</li> <li>► Listen for scraping sounds.</li> <li>► Pull over and stop the vehicle safely, paying attention to road and traffic conditions, and select a higher vehicle level. Depending on the malfunction, it may be possible to raise the vehicle.</li> <li>► Visit a qualified specialist workshop.</li> </ul>



Display messages	Possible causes/consequences and ► Solutions
 <p>Malfunction</p>	<p> <b>Risk of accident</b></p> <p>The AIRMATIC function is restricted. The vehicle's handling characteristics may be affected.</p> <ul style="list-style-type: none"> <li>► Drive no faster than 50 mph (80 km/h).</li> <li>► Visit a qualified specialist workshop.</li> </ul>
<p>HOLD Off</p>	<p>The HOLD function is deactivated. The vehicle is skidding. A warning tone also sounds.</p> <ul style="list-style-type: none"> <li>► Reactivate the HOLD function later.</li> </ul> <p>A condition for activation is no longer met when the brake pedal is firmly depressed. A warning tone also sounds.</p> <ul style="list-style-type: none"> <li>► Check the activation conditions for the HOLD function (► page 188).</li> </ul>
<p>Radar Sensors Deactivated See Operator's Manual</p>	<p>The radar sensor system is deactivated.</p> <ul style="list-style-type: none"> <li>► Check whether or not the radar sensor system may be activated (► page 232).</li> <li>► Switch on the radar sensor system (► page 232).</li> </ul>
<p>Lane Keeping Assist Currently Unavailable See Operator's Manual or Active Lane Keeping Assist Currently Unavailable See Operator's Manual</p>	<p>Lane Keeping Assist or Active Lane Keeping Assist is deactivated and temporarily inoperative if:</p> <ul style="list-style-type: none"> <li>• the windshield is dirty in the camera's field of vision.</li> <li>• visibility is impaired due to heavy rain, snow or fog.</li> <li>• there are no lane markings for a longer period.</li> <li>• the lane markings are worn, dark or covered, for example by dirt or snow.</li> </ul> <p>Lane Keeping Assist or Active Lane Keeping Assist is operational again and the display message disappears when:</p> <ul style="list-style-type: none"> <li>• the dirt (e.g. slush) drops away while the vehicle is in motion.</li> <li>• the system detects that the camera is fully operational again.</li> </ul> <p>If the display message continues to be displayed:</p> <ul style="list-style-type: none"> <li>► Clean the windshield.</li> </ul>
<p>Lane Keeping Assist Inoperative or Active Lane Keeping Assist Inoperative</p>	<p>Lane Keeping Assist or Active Lane Keeping Assist is faulty.</p> <ul style="list-style-type: none"> <li>► Visit a qualified specialist workshop.</li> </ul>

Display messages	Possible causes/consequences and ► Solutions
Blind Spot Assist Currently Unavailable See Operator's Manual or Active Blind Spot Assist Currently Unavailable See Operator's Manual	Blind Spot Assist or Active Blind Spot Assist is temporarily inoperative if: <ul style="list-style-type: none"> <li>• the sensors are dirty.</li> <li>• its function is impaired due to heavy rain or snow.</li> <li>• the radar sensor system is outside the operating temperature range.</li> <li>• the radar sensor system is temporarily inoperative, e.g. due to electromagnetic radiation emitted by nearby TV or radio stations or other sources of electromagnetic radiation.</li> </ul> The yellow  indicator lamps also light up in the exterior mirrors. Blind Spot Assist or Active Blind Spot Assist is operational again and the display message disappears when: <ul style="list-style-type: none"> <li>• the dirt (e.g. slush) drops away while the vehicle is in motion.</li> <li>• the system detects that the sensors are fully available again.</li> <li>• the radar sensor system is back within the operating temperature range.</li> </ul> If the display message continues to be displayed: <ul style="list-style-type: none"> <li>► Clean the sensors (► page 317).</li> <li>► Restart the engine.</li> </ul>
Blind Spot Assist Inoperative or Active Blind Spot Assist Inoperative	Blind Spot Assist or Active Blind Spot Assist is faulty. The yellow  indicator lamps also light up in the exterior mirrors. <ul style="list-style-type: none"> <li>► Visit a qualified specialist workshop.</li> </ul>
Parking Guidance Inoperative	Parking Guidance is faulty. <ul style="list-style-type: none"> <li>► Restart the engine.</li> </ul> If the display message continues to be displayed: <ul style="list-style-type: none"> <li>► Visit a qualified specialist workshop.</li> </ul>

Display messages	Possible causes/consequences and ► Solutions
Parking Guidance Canceled	<p>Parking Guidance is deactivated, because:</p> <ul style="list-style-type: none"> <li>• the vehicle is skidding.</li> <li>• the sensors are dirty.</li> <li>• a malfunction has occurred.</li> </ul> <p>A warning tone also sounds.</p> <p>► Reactivate Parking Guidance later.</p> <p>If the parking space symbol is not displayed in the multifunction display when you are driving at a speed of less than 19 mph (30 km/h):</p> <ul style="list-style-type: none"> <li>► Clean the sensors (▷ page 317).</li> <li>► Restart the engine.</li> </ul> <p>If the parking space symbol is still not displayed in the multifunction display when you are driving at a speed of less than 19 mph (30 km/h):</p> <ul style="list-style-type: none"> <li>► Visit a qualified specialist workshop.</li> </ul> <p>Parking Guidance is deactivated because you have left the lane.</p> <ul style="list-style-type: none"> <li>► Park again and, while doing so, observe the display messages in the multifunction display.</li> </ul>
Parking Guidance Finished	<ul style="list-style-type: none"> <li>• The vehicle is parked. A warning tone also sounds.</li> </ul> <p>The display message disappears automatically.</p>
DISTRONIC PLUS Off	<p>DISTRONIC PLUS has been switched off. When it is deactivated automatically, a warning tone also sounds (▷ page 186).</p>
DISTRONIC PLUS Now Available	<p>DISTRONIC PLUS is operational again after being temporarily unavailable. You can now activate DISTRONIC PLUS again (▷ page 179).</p>

Display messages	Possible causes/consequences and ► Solutions
DISTRONIC PLUS Currently Unavailable See Operator's Manual	<p>DISTRONIC PLUS is deactivated and is temporarily inoperative if:</p> <ul style="list-style-type: none"> <li>• the DISTRONIC PLUS cover in the radiator grill is dirty.</li> <li>• the sensors in the bumpers are dirty.</li> <li>• the radar sensor system is temporarily inoperative, e.g. due to electromagnetic radiation emitted by nearby TV or radio stations or other sources of electromagnetic radiation.</li> <li>• its function is impaired due to heavy rain or snow.</li> <li>• the system is outside the operating temperature range.</li> <li>• the on-board voltage is too low.</li> </ul> <p>A warning tone also sounds.</p> <p>DISTRONIC PLUS is operational again and the display message disappears when:</p> <ul style="list-style-type: none"> <li>• the dirt (e.g. slush) drops away while the vehicle is in motion.</li> <li>• the system detects that the sensors are fully available again.</li> <li>• the system is within the operating temperature range.</li> </ul> <p>If the display message continues to be displayed:</p> <ul style="list-style-type: none"> <li>► Clean the DISTRONIC PLUS cover in the radiator grill (▷ page 317).</li> <li>► Clean the bumpers (▷ page 317). تلفن شه</li> <li>► Restart the engine.</li> </ul>
DISTRONIC PLUS Inoperative	<p>DISTRONIC PLUS is faulty. BAS PLUS and PRE-SAFE® Brake may also have failed. A warning tone also sounds.</p> <ul style="list-style-type: none"> <li>► Visit a qualified specialist workshop.</li> </ul>
DISTRONIC PLUS Override	<p>You have depressed the accelerator pedal. DISTRONIC PLUS is no longer controlling the speed of the vehicle.</p> <ul style="list-style-type: none"> <li>► Take your foot off the accelerator pedal.</li> </ul>
DISTRONIC PLUS --- mph	<p>An activation condition for DISTRONIC PLUS is not fulfilled.</p> <ul style="list-style-type: none"> <li>► Check activation conditions for DISTRONIC PLUS (▷ page 179).</li> </ul>

Display messages	Possible causes/consequences and ► Solutions
Cruise Control Inoperative	Cruise control is faulty. A warning tone also sounds. ► Visit a qualified specialist workshop.
Cruise Control --- mph	A condition for activating cruise control has not been met. You attempted to save a speed of less than 20 mph (30 km/h). ► If the situation allows, drive faster than 20 mph (30 km/h) and save the speed. ► Check the activation conditions for cruise control (► page 177).

## Tires

### Warning



Do not drive with a flat tire. A flat tire affects the ability to steer or brake the vehicle. You may lose control of the vehicle. Continued driving with a flat tire will cause excessive heat build-up and possibly a fire.



### Warning

Follow recommended tire inflation pressures.



Do not underinflate tires. Underinflated tires wear excessively and/or unevenly, adversely affect handling and fuel economy, and are more likely to fail from being overheated.

Do not overinflate tires. Overinflated tires can adversely affect handling and ride comfort, wear unevenly, increase stopping distance, and result in sudden deflation (blowout) because they are more likely to become punctured or damaged by road debris, potholes etc.









Display messages	Possible causes/consequences and ► Solutions
Check Tire Pressure Soon	<p> <b>Risk of accident</b></p> <p>The tire pressure loss warning system has detected a significant loss in pressure.</p> <p>A warning tone also sounds.</p> <ul style="list-style-type: none"> <li>► Stop the vehicle without making any sudden steering or braking maneuvers. Pay attention to the traffic conditions as you do so.</li> <li>► Check the tires and, if necessary, change the wheel (▷ page 367).</li> <li>► Check the tire pressures and, if necessary, set to the correct tire pressure.</li> <li>► Restart the tire pressure loss warning system when the tire pressure is correct (▷ page 355).</li> </ul>
Check Tire Pressure Then Restart Run Flat Indicator	<p>A display message from the tire pressure loss warning system was shown and the system has not been restarted since.</p> <ul style="list-style-type: none"> <li>► Set the correct tire pressure in all four tires.</li> <li>► Restart the tire pressure loss warning system (▷ page 355).</li> </ul>
Run Flat Indicator Inoperative	<p>The tire pressure loss warning system is faulty.</p> <ul style="list-style-type: none"> <li>► Visit a qualified specialist workshop.</li> </ul>
Tire pressures will be displayed after driving a few minutes	<p>The tire pressure monitor is measuring the tire pressure.</p> <ul style="list-style-type: none"> <li>► Drive on.</li> </ul> <p>The tire pressures appear in the multifunction display after you have been driving for a few minutes.</p>
Tire Press. Monitor Inoperative	<p>The TPMS is faulty.</p> <ul style="list-style-type: none"> <li>► Visit a qualified specialist workshop.</li> </ul>
Tire Pressure Monitor Inoperative No Wheel Sensors	<p>The wheels mounted do not have a suitable tire pressure sensor. The tire pressure monitor is deactivated.</p> <ul style="list-style-type: none"> <li>► Mount wheels with suitable tire pressure sensors.</li> </ul> <p>The TPMS is activated automatically after driving for a few minutes.</p>
Check Tires	<p> <b>Risk of accident</b></p> <p>The tire pressure in one or more tires has dropped significantly. The wheel position is displayed in the multifunction display.</p> <ul style="list-style-type: none"> <li>► Stop the vehicle without making any sudden steering or braking maneuvers. Pay attention to the traffic conditions as you do so.</li> <li>► Correct the tire pressure (▷ page 357).</li> <li>► If necessary, change a wheel (▷ page 367).</li> </ul>



Display messages	Possible causes/consequences and ► Solutions
Caution Tire Malfunction	 <b>Risk of accident</b> The tire pressure in one or more tires has dropped suddenly. The wheel position is displayed in the multifunction display. <ul style="list-style-type: none"> <li>► Stop the vehicle without making any sudden steering or braking maneuvers. Pay attention to the traffic conditions as you do so.</li> <li>► If necessary, change a wheel (▷ page 367).</li> </ul>
Correct Tire Pressure	The tire pressure is insufficient in at least one of the tires or the tire pressure difference between the wheels is too great. <ul style="list-style-type: none"> <li>► Check the tire pressures at the next opportunity. If necessary, correct the tire pressure (▷ page 357).</li> <li>► Restart the tire pressure monitor (▷ page 359).</li> </ul>
Tire Press. Sensor(s)Missing	There is no signal from the tire pressure sensor of one or several wheels. The pressure of the affected tire is not displayed in the multifunction display. <ul style="list-style-type: none"> <li>► Have the faulty tire pressure sensor replaced at a qualified specialist workshop.</li> </ul>
Tire Press. Monitor Currently Unavailable	No signals are being received from the tire pressure sensors due to radio interference. The tire pressure monitor is temporarily malfunctioning. <ul style="list-style-type: none"> <li>► Drive on. The TPMS restarts automatically as soon as the problem has been solved.</li> </ul>
 Tire Press. Warning Caution Tire Malfunction	 <b>Risk of accident</b> The tire pressure in one or more tires has dropped suddenly. <ul style="list-style-type: none"> <li>► Stop the vehicle without making any sudden steering or braking maneuvers. Pay attention to the traffic conditions as you do so.</li> <li>► If necessary, change a wheel (▷ page 367).</li> </ul>







Display messages	Possible causes/consequences and ► Solutions
 Check Tire Pressure	 <b>Risk of accident</b> The tire pressure in one or more tires has dropped significantly. <ul style="list-style-type: none"> <li>► Stop the vehicle without making any sudden steering or braking maneuvers. Pay attention to the traffic conditions as you do so.</li> <li>► If necessary, change a wheel (▷ page 367).</li> <li>► Check the tire pressure. If necessary, correct the tire pressure (▷ page 357).</li> </ul>
 Correct Tire Pressure	The tire pressure is insufficient in at least one of the tires or the tire pressure difference between the wheels is too great. <ul style="list-style-type: none"> <li>► Check the tire pressures at the next opportunity. If necessary, correct the tire pressure (▷ page 357).</li> </ul>





Vehicle	
Display messages	Possible causes/consequences and ► Solutions
Shift to 'P' or 'N' to Start Engine	You have attempted to start the engine with the transmission in position <b>R</b> or <b>D</b> . <ul style="list-style-type: none"> <li>► Shift the transmission to position <b>P</b> or <b>N</b>.</li> </ul>
Auxiliary Battery Malfunction	The auxiliary battery for the automatic transmission is no longer being charged. <ul style="list-style-type: none"> <li>► Visit a qualified specialist workshop.</li> </ul>
Apply Brake to Shift from P	You have attempted to move the transmission selector lever to position <b>D</b> , <b>R</b> or <b>N</b> without depressing the brake pedal. <ul style="list-style-type: none"> <li>► Depress the brake pedal.</li> </ul>
Door Open Vehicle Not in P	The driver's door is open and the transmission is in position <b>R</b> , <b>N</b> or <b>D</b> . A warning tone also sounds. <ul style="list-style-type: none"> <li>► Shift the transmission to position <b>P</b>.</li> <li>► Engage the parking brake.</li> </ul>



Display messages	Possible causes/consequences and ► Solutions
Service Required Do Not Shift Gears Visit Dealer	You cannot change the transmission position due to a malfunction. A warning tone also sounds. If transmission position <b>D</b> is selected: ► Drive to a qualified specialist workshop without shifting the transmission from position <b>D</b> . If transmission position <b>R</b> , <b>N</b> or <b>P</b> is selected: ► Notify a qualified specialist workshop or breakdown service.
Only shift to P when Vehicle is Stationary	The vehicle is moving. ► Pull over and stop the vehicle safely as soon as possible, paying attention to road and traffic conditions. ► Shift the transmission to position <b>P</b> .
	Sedan: the trunk lid is open. ► Close the trunk lid.
	Wagon: the tailgate is open. ► Close the tailgate.
 or 	 <b>Risk of accident</b> The hood is open. ► Pull over and stop the vehicle safely as soon as possible, paying attention to road and traffic conditions. ► Engage the parking brake. ► Close the hood.
	At least one door is open. ► Close all doors.
 Rear Lt. Backrest Not Latched or Rear Rt. Backrest Not Latched	 <b>Risk of injury</b> The backrest in the rear is not engaged on the left-hand and/or right-hand side. ► Push the backrest back until it engages.

Display messages	Possible causes/consequences and ► Solutions
 <p>Power Steering Malfunction See Operator's Manual</p>	<p> <b>Risk of accident</b></p> <p>The power steering assistance is faulty. You will need to use more force to steer.</p> <p>A warning tone also sounds.</p> <ul style="list-style-type: none"> <li>► Check whether you are able to apply the extra force required.</li> <li>► <b>If you are able to steer safely:</b> carefully drive on to a qualified specialist workshop.</li> <li>► <b>If you are unable to steer safely:</b> do not drive on. Contact the nearest qualified specialist workshop.</li> </ul>
No Service	<p>Your vehicle is outside the network provider transmitter/receiver range.</p> <ul style="list-style-type: none"> <li>► Wait until the mobile phone operational readiness symbol appears in the multifunction display.</li> </ul>
 <p>Check Washer Fluid</p>	<p>The washer fluid level in the washer fluid reservoir has dropped below the minimum.</p> <ul style="list-style-type: none"> <li>► Add washer fluid (► page 312).</li> </ul>

### SmartKey

Display messages	Possible causes/consequences and ► Solutions
 <p>Key Does Not Belong to Vehicle</p>	<p>You have put the wrong SmartKey in the ignition lock.</p> <ul style="list-style-type: none"> <li>► Use the correct SmartKey.</li> </ul>
 <p>Take Your Key from Ignition</p>	<p>The SmartKey is in the ignition lock.</p> <ul style="list-style-type: none"> <li>► Remove the SmartKey.</li> </ul>
 <p>Obtain a new key</p>	<p>The SmartKey needs to be replaced.</p> <ul style="list-style-type: none"> <li>► Visit a qualified specialist workshop.</li> </ul>
 <p>Replace Key Battery</p>	<p>The batteries of the KEYLESS-GO key are discharged.</p> <ul style="list-style-type: none"> <li>► Change the batteries (► page 80).</li> </ul>

Display messages	Possible causes/consequences and ► Solutions
 <p>Don't Forget Your Key</p>	<p>The display message is displayed for a maximum of 60 seconds and is just a reminder.</p> <p>You have opened the driver's door with the engine switched off. The KEYLESS-GO key is not in the ignition lock.</p> <ul style="list-style-type: none"> <li>► Take the KEYLESS-GO key with you when leaving the vehicle.</li> </ul>
 <p>Key Not Detected (red display message)</p>	<p>The KEYLESS-GO key is not in the vehicle.</p> <p>A warning tone also sounds.</p> <p>If the engine is switched off, you can no longer lock the vehicle centrally or start the engine.</p> <ul style="list-style-type: none"> <li>► Pull over and stop the vehicle safely as soon as possible, paying attention to road and traffic conditions.</li> <li>► Engage the parking brake.</li> <li>► Locate the KEYLESS-GO key.</li> </ul> <p>The KEYLESS-GO key is not detected while the engine is running because there is interference from a strong source of radio waves. A warning tone also sounds.</p> <ul style="list-style-type: none"> <li>► Pull over and stop the vehicle safely as soon as possible, paying attention to road and traffic conditions.</li> <li>► Engage the parking brake.</li> <li>► Operate the vehicle with the KEYLESS-GO key in the ignition lock if necessary.</li> </ul>
 <p>Key Not Detected (white display message)</p>	<p>The KEYLESS-GO key cannot be detected at present.</p> <ul style="list-style-type: none"> <li>► Change the location of the key with the KEYLESS-GO functions in the vehicle.</li> </ul> <p>If the KEYLESS-GO key is still not detected:</p> <ul style="list-style-type: none"> <li>► Change the location of the key with the KEYLESS-GO functions in the vehicle.</li> <li>► Operate the vehicle with the KEYLESS-GO key in the ignition lock if necessary.</li> </ul>
 <p>Key Detected in Vehicle</p>	<p>The KEYLESS-GO key has been detected inside the vehicle during locking.</p> <ul style="list-style-type: none"> <li>► Remove the KEYLESS-GO key from the vehicle.</li> </ul>

Display messages	Possible causes/consequences and ► Solutions
 <p>Remove 'Start' Button and Insert Key</p>	<p>KEYLESS-GO is temporarily malfunctioning or is defective. A warning tone also sounds.</p> <ul style="list-style-type: none"> <li>► Insert the SmartKey into the ignition lock and turn it to the desired position.</li> <li>► Visit a qualified specialist workshop.</li> </ul>
 <p>Close Doors to Lock Vehicle</p>	<p>At least one door is open. A warning tone also sounds.</p> <ul style="list-style-type: none"> <li>► Close all doors and lock the vehicle again.</li> </ul>









امداد خودرو فارما

تلفن شبانه روزی: ۰۲۱-۸۸۸۶۲۰۸۵

FarmaSOS.com

## Warning and indicator lamps in the instrument cluster

## Brakes

Problem	Possible causes/consequences and ► Solutions
 (USA only)  (Canada only) The red brake system warning lamp comes on while the vehicle is moving. A warning tone also sounds.	You are driving with the parking brake engaged. <ul style="list-style-type: none"> <li>► Release the parking brake.</li> </ul> The warning lamp goes out and the warning tone ceases.
 (USA only)  (Canada only) The red brake system warning lamp comes on while the engine is running. A warning tone also sounds.	 <b>Risk of accident</b> The brake boosting effect is malfunctioning and the braking characteristics may be affected. <ul style="list-style-type: none"> <li>► Pull over and stop the vehicle safely as soon as possible, paying attention to road and traffic conditions. Do not continue driving under any circumstances.</li> <li>► Engage the parking brake.</li> <li>► Consult a qualified specialist workshop.</li> <li>► Observe the additional display messages in the multifunction display.</li> </ul>
 (USA only)  (Canada only) The red brake system warning lamp comes on while the engine is running. A warning tone also sounds.	 <b>Risk of accident</b> There is insufficient brake fluid in the fluid reservoir. <ul style="list-style-type: none"> <li>► Pull over and stop the vehicle safely as soon as possible, paying attention to road and traffic conditions. Do not continue driving under any circumstances.</li> <li>► Engage the parking brake.</li> <li>► Consult a qualified specialist workshop immediately.</li> <li>► Observe the additional display messages in the multifunction display.</li> </ul> Do not add brake fluid. This will not rectify the problem.

 **Warning**

Driving with the brake warning lamp illuminated can result in an accident. Have your brake system checked immediately if the brake warning lamp stays on. Do not add brake fluid before checking the brake system.

Overfilling the brake fluid reservoir can result in spilling brake fluid on hot engine parts and the brake fluid catching fire. You can be seriously burned.

## Seat belts

## Problem

## Possible causes/consequences and ► Solutions



After starting the engine, the red seat belt warning lamp lights up for 6 seconds.

The seat belt warning lamp reminds the driver and front passenger to fasten their seat belts.

- Fasten your seat belt (▷ page 53).



After starting the engine, the red seat belt warning lamp lights up. In addition, a warning tone sounds for up to 6 seconds.

## Risk of injury

The driver's seat belt is not fastened.

- Fasten your seat belt (▷ page 53).  
The warning tone ceases.



The red seat belt warning lamp lights up after the engine starts, as soon as the driver's or the front-passenger door is closed.

## Risk of injury

The driver or front passenger has not fastened their seat belt.

- Fasten your seat belt (▷ page 53).  
The warning lamp goes out.

## Risk of injury

There are objects on the front-passenger seat.

- Remove the objects from the front-passenger seat and stow them in a secure place.  
The warning lamp goes out.



The red seat belt warning lamp flashes and an intermittent audible warning sounds.

## Risk of injury

The driver or front passenger has not fastened their seat belt. In addition, you are driving faster than 15 mph (25 km/h) or you have briefly driven faster than 15 mph (25 km/h).







- Fasten your seat belt (▷ page 53).  
The warning lamp goes out and the intermittent audible warning ceases.







## Risk of injury





There are objects on the front-passenger seat. In addition, you are driving faster than 15 mph (25 km/h) or you have briefly driven faster than 15 mph (25 km/h).

- Remove the objects from the front-passenger seat and stow them in a secure place.  
The warning lamp goes out and the intermittent audible warning ceases.



Safety systems	
Problem	Possible causes/consequences and ► Solutions
 <p>The yellow ABS warning lamp is lit while the engine is running.</p>	<p> <b>Risk of accident</b></p> <p>ABS (Anti-lock Brake System) is deactivated due to a malfunction. Therefore, BAS (Brake Assist), BAS PLUS (Brake Assist PLUS), ESP® (Electronic Stability Program), EBD (Electronic Brake force Distribution), PRE-SAFE®, PRE-SAFE® Brake, the HOLD function and hill start assist are also deactivated.</p> <p>The brake system continues to function normally, but without the functions listed above. The wheels could therefore lock if you brake hard, for example.</p> <p>ATTENTION ASSIST is deactivated.</p> <ul style="list-style-type: none"> <li>► Observe the additional display messages in the multifunction display.</li> <li>► Drive on carefully.</li> <li>► Visit a qualified specialist workshop.</li> </ul>
 <p>The yellow ESP® and ESP® OFF warning lamps and the yellow ABS warning lamp are lit while the engine is running. A warning tone also sounds.</p>	<p> <b>Risk of accident</b></p> <p>EBD is faulty. Therefore, ABS, BAS, BAS PLUS, ESP®, PRE-SAFE®, PRE-SAFE® Brake, the HOLD function and hill start assist are also not available.</p> <p>The brake system continues to function normally, but without the functions listed above. The wheels could therefore lock if you brake hard, for example.</p> <ul style="list-style-type: none"> <li>► Observe the additional display messages in the multifunction display.</li> <li>► Drive on carefully.</li> <li>► Visit a qualified specialist workshop.</li> </ul>
 <p>The yellow ESP® and ESP® OFF warning lamps and the yellow ABS warning lamp are lit while the engine is running.</p>	<p> <b>Risk of accident</b></p> <p>ABS and ESP® are faulty. Therefore, BAS, BAS PLUS, PRE-SAFE®, PRE-SAFE® Brake, the HOLD function and hill start assist are not available either, due to a malfunction.</p> <p>The brake system continues to function normally, but without the functions listed above. The wheels could therefore lock if you brake hard, for example.</p> <p>ATTENTION ASSIST is deactivated.</p> <ul style="list-style-type: none"> <li>► Observe the additional display messages in the multifunction display.</li> <li>► Drive on carefully.</li> <li>► Visit a qualified specialist workshop.</li> </ul>

Problem	Possible causes/consequences and ► Solutions
 <p>The yellow ESP<sup>®</sup> warning lamp flashes while the vehicle is in motion.</p>	<p> <b>Risk of accident</b></p> <p>ESP<sup>®</sup> or traction control has intervened because there is a risk of skidding or at least one wheel has started to spin. Cruise control or DISTRONIC PLUS is deactivated.</p> <ul style="list-style-type: none"> <li>► Only depress the accelerator pedal as far as necessary when pulling away.</li> <li>► Release the accelerator pedal while the vehicle is in motion.</li> <li>► Adapt your driving style to suit the road and weather conditions.</li> <li>► Do not deactivate ESP<sup>®</sup>. Exceptions: (► page 67).</li> </ul>
 <p>The yellow ESP<sup>®</sup> OFF warning lamp is lit while the engine is running.</p>	<p> <b>Risk of accident</b></p> <p>ESP<sup>®</sup> is deactivated. ESP<sup>®</sup> will not stabilize the vehicle if it starts to skid or if a wheel starts to spin.</p> <ul style="list-style-type: none"> <li>► Reactivate ESP<sup>®</sup>. Exceptions: (► page 67).</li> <li>► Adapt your driving style to suit the road and weather conditions.</li> </ul> <p>If ESP<sup>®</sup> cannot be activated:</p> <ul style="list-style-type: none"> <li>► Have ESP<sup>®</sup> checked at a qualified specialist workshop.</li> </ul>
 (E 63 AMG only) <p>The yellow SPORT handling mode warning lamp is lit while the engine is running.</p>	<p> <b>Risk of accident</b></p> <p>SPORT handling mode is activated. ESP<sup>®</sup> only stabilizes the vehicle in extreme situations. ESP<sup>®</sup> intervention may not be able to provide sufficient assistance in such situations, and the vehicle may start to skid.</p> <ul style="list-style-type: none"> <li>► Reactivate ESP<sup>®</sup>. Exceptions: (► page 67).</li> </ul> <p>If ESP<sup>®</sup> cannot be activated:</p> <ul style="list-style-type: none"> <li>► Have ESP<sup>®</sup> checked at a qualified specialist workshop.</li> </ul>

Problem	Possible causes/consequences and ► Solutions
 <p>The yellow ESP® and ESP® OFF warning lamps are lit while the engine is running.</p>	<p> <b>Risk of accident</b></p> <p>ESP®, BAS, BAS PLUS, PRE-SAFE®, PRE-SAFE® Brake, the HOLD function and hill start assist are not available, due to a malfunction. ESP® will not stabilize the vehicle if it starts to skid or if a wheel starts to spin.</p> <p>The brake system continues to function normally, but without the functions listed above.</p> <p>ATTENTION ASSIST is deactivated.</p> <ul style="list-style-type: none"> <li>► Observe the additional display messages in the multifunction display.</li> <li>► Drive on carefully.</li> <li>► Visit a qualified specialist workshop.</li> </ul>
 <p>The red SRS warning lamp is lit while the engine is running.</p>	<p> <b>Risk of injury</b></p> <p>The restraint systems are malfunctioning. The air bags or ETDs may either be triggered unintentionally or, in the event of an accident, not be triggered at all.</p> <ul style="list-style-type: none"> <li>► Drive on carefully.</li> <li>► Visit a qualified specialist workshop immediately.</li> </ul>





 **Warning**



In the event a malfunction of the SRS is indicated as outlined above, the SRS may not be operational.

For your safety, we strongly recommend that you contact an authorized Mercedes-Benz Center immediately to have the system checked. Otherwise the SRS may not be activated when needed in an accident, which could result in serious or fatal injury, or it might deploy unexpectedly and unnecessarily which could also result in injury.

تلفن شماره روزی: ۰۲۱-۸۸۸۶۲۰۸۵

FarmaSOS.com

Engine	
Problem	Possible causes/consequences and ► Solutions
 <p>The yellow Check Engine warning lamp lights up while the engine is running.</p>	<p>There may be a malfunction, for example:</p> <ul style="list-style-type: none"> <li>• in the engine management</li> <li>• in the fuel injection system</li> <li>• in the exhaust system</li> <li>• in the ignition system (for vehicles with gasoline engines)</li> <li>• the fuel system</li> </ul> <p>The emission limit values may have been exceeded and the engine may be breaking in emergency mode.</p> <p>► Have the vehicle checked as soon as possible at a qualified specialist workshop.</p> <p><b>i</b> In some states, you are required by law to visit a qualified specialist workshop as soon as the Check Engine warning lamp lights up. If necessary, check whether this is the case in the state you are in.</p>
 <p>The yellow Check Engine warning lamp lights up while the ignition is switched on.</p>	<p>Vehicles with a diesel engine: the fuel tank has been run completely dry and the engine will not start (► page 166).</p>
 <p>The yellow reserve fuel warning lamp flashes while the engine is running.</p>	<p>The fuel system pressure is too low. The fuel filler cap is not closed correctly or the fuel system is leaking.</p> <p>► Check that the fuel filler cap is correctly closed.</p> <p>► <b>If the fuel filler cap is not correctly closed:</b> close the fuel filler cap.</p> <p>► <b>If the fuel filler cap is closed:</b> visit a qualified specialist workshop.</p>
 <p>The yellow reserve fuel warning lamp lights up while the engine is running.</p>	<p>The amount of fuel in the tank has dropped into the reserve range.</p> <p>► Refuel at the nearest gas station.</p>

Problem	Possible causes/consequences and ► Solutions
 <p>The red coolant warning lamp lights up while the engine is running and the coolant temperature gauge is at the start of the scale.</p>	<p>The temperature sensor for the coolant temperature gauge is faulty.</p> <p>The coolant temperature is no longer being monitored. There is a risk of engine damage if the coolant temperature is too high.</p> <ul style="list-style-type: none"> <li>► Pull over and stop the vehicle safely and switch off the engine, paying attention to road and traffic conditions. Do not continue driving under any circumstances.</li> <li>► Engage the parking brake.</li> <li>► Consult a qualified specialist workshop.</li> </ul>
 <p>The red coolant warning lamp comes on while the engine is running.</p>	<p>The coolant level is too low.</p> <p>If the coolant level is correct, the airflow to the radiator may be blocked or the electric radiator fan may be malfunctioning.</p> <p>The coolant is too hot and the engine is no longer being cooled sufficiently.</p> <ul style="list-style-type: none"> <li>► Pull over and stop the vehicle safely and switch off the engine, paying attention to road and traffic conditions.</li> <li>► Allow the engine and coolant to cool.</li> <li>► Check the coolant level and add the coolant (► page 311). Observe the warning notes.</li> <li>► If the coolant needs adding more often than usual, have the engine coolant system checked.</li> <li>► Make sure that the air supply to the radiator is not blocked, e.g. by snow, slush or ice.</li> <li>► At coolant temperatures below 248 °F (120 °C), continue driving to the next qualified specialist workshop.</li> <li>► Avoid subjecting the engine to heavy loads, e.g. driving in mountainous terrain, and stop-start driving.</li> </ul>
 <p>The red coolant warning lamp comes on while the engine is running. A warning tone also sounds.</p>	<p>The coolant has exceeded a temperature of 248 °F (120 °C). The airflow to the radiator may be blocked or the coolant level may be too low.</p> <p>The engine is not being cooled sufficiently and may be damaged.</p> <ul style="list-style-type: none"> <li>► Pull over and stop the vehicle safely and switch off the engine, paying attention to road and traffic conditions.</li> <li>► Allow the engine and coolant to cool.</li> </ul>

### Warning



Driving when your engine is overheated can cause some fluids which may have leaked into the engine compartment to catch fire. You could be seriously burned.

Steam from an overheated engine can cause serious burns which can occur just by opening the engine hood. Stay away from the engine if you see or hear steam coming from it.

Stop the vehicle in a safe location away from other traffic. Turn off the engine, get out of the vehicle and do not stand near the vehicle until the engine has cooled down.



- ❗ If the coolant temperature exceeds 248 °F(120 °C) do not continue driving. The engine will otherwise be damaged.

### Driving systems

Problem	Possible causes/consequences and ► Solutions
 <p>The red distance warning lamp lights up while the vehicle is in motion. A warning tone also sounds.</p>	<p> <b>Risk of accident</b></p> <p>A warning is issued if:</p> <ul style="list-style-type: none"> <li>• you are approaching a vehicle in front at too great a speed</li> <li>• DISTRONIC PLUS or PRE-SAFE® Brake has detected a stationary obstacle in your line of travel</li> </ul> <p>► Be prepared to brake immediately.</p> <p>► Pay careful attention to the traffic situation. You may have to brake or take evasive action.</p>

تلفن شبانه روزی: ۰۲۱-۸۸۸۶۲۰۸۵

FarmaSOS.com

Tires	
Problem	Possible causes/consequences and ► Solutions
 USA only: The yellow combination low tire pressure warning lamp/TPMS malfunction warning lamp is lit. Canada only: The yellow low tire pressure warning lamp for the TPMS is lit.	 <b>Risk of accident</b> The tire pressure monitor has detected a loss of pressure in at least one of the tires. <ul style="list-style-type: none"> <li>► Stop the vehicle without making any sudden steering or braking maneuvers. Pay attention to the traffic conditions as you do so.</li> <li>► Observe the additional display messages in the multifunction display.</li> <li>► Check the tire pressure. If necessary, correct the tire pressure (► page 357).</li> <li>► If necessary, change a wheel (► page 367).</li> </ul>
 USA only: The yellow combination low tire pressure warning lamp/TPMS malfunction warning lamp flashes for sixty seconds and then remains lit.	The tire pressure monitor is faulty. <ul style="list-style-type: none"> <li>► Observe the additional display messages in the multifunction display.</li> <li>► Visit a qualified specialist workshop.</li> </ul>

### Warning

Each tire, including the spare tire (if there is one), should be inspected at least every two weeks when they are cold and pumped to the pressure recommended by the vehicle manufacturer (see the tire and load data label on the B-pillar on the driver's side or the tire pressure table on the inside of the fuel filler flap of your vehicle, if there is one). If your vehicle has tires which are a different size to those on the tire and load data label or those specified in the tire pressure table, if there is one, you should determine the correct tire pressure for these tires.

As an added safety feature, your vehicle has been equipped with a tire pressure monitor (TPMS). An indicator lamp lights up if one or more of your tires are significantly underinflated. Accordingly, when the low tire pressure indicator lamp lights up, you should stop and check your tires as soon as possible, and inflate them to the proper pressure. Driving on a significantly underinflated tire causes the tire to overheat and can lead to tire failure.

An excessively low tire pressure also increases fuel consumption, reduces the service life of the tires and may impair the driving and braking characteristics of the vehicle. Please note that the TPMS is not a substitute for proper tire maintenance and it is the driver's responsibility to maintain correct tire pressure, even if underinflation has not reached the level at which the low tire pressure indicator lamp of the TPMS lights up.

USA only:

FarmaSOS.com

تلفن شماره روزی: ۰۲۱-۸۸۸۶۲۰۸۵

Your vehicle has also been equipped with a TPMS malfunction indicator to indicate when the system is not operating properly. The TPMS malfunction indicator is combined with the low tire pressure indicator lamp. When the system detects a malfunction, the indicator lamp will flash for approximately one minute and then remain illuminated. This sequence will continue upon subsequent vehicle start-ups as long as the malfunction exists. When the malfunction indicator is lit, the system may not be able to detect or signal low tire pressure as intended.

TPMS malfunctions may occur for a variety of reasons, including the installation of incompatible replacement or alternate tires or wheels on the vehicle that prevent the TPMS from functioning properly. Always check the TPMS malfunction indicator after replacing one or more tires or wheels on your vehicle to ensure that the replacement or alternate tires and wheels allow the TPMS to continue to function properly.

امداد خودرو فارما

تلفن شبانه روزی: ۰۲۱-۸۸۸۶۲۰۸۵

FarmaSOS.com



Vehicle equipment .....	274
Loading guidelines .....	274
Stowage compartments .....	274
Stowage areas .....	276
Features .....	288

# امداد خودرو فارما

تلفن شبانه روزی: ۰۲۱-۸۸۸۶۲۰۸۵

[FarmaSOS.com](http://FarmaSOS.com)

## Vehicle equipment

- i** This manual describes all the standard and optional equipment of your vehicle which was available at the time of purchase. Country-specific differences are possible. Bear in mind that your vehicle may not feature all functions described here. This also refers to safety-related systems and functions.

## Loading guidelines

### **Warning!**

Always fasten items being carried as securely as possible. Use cargo tie-down rings and fastening materials appropriate for the weight and size of the load.

In an accident, during hard braking or sudden maneuvers, loose items will be thrown around inside the vehicle. This can cause injury to vehicle occupants unless the items are securely fastened in the vehicle.

To help avoid personal injury during a collision or sudden maneuver, exercise care when transporting cargo. Do not pile luggage or cargo higher than the seat backrests.

The trunk is the preferred place to carry objects.

Never drive a vehicle with the trunk open. Deadly carbon monoxide (CO) gases may enter vehicle interior resulting in unconsciousness and death.

The handling characteristics of a laden vehicle are dependent on the distribution of the load within the vehicle. For this reason, you should observe the following notes when transporting a load:

- When transporting a load, never exceed the maximum permissible gross vehicle weight or the permissible axle loads for the vehicle (including occupants). The values are

stated on the vehicle identification plate on the B-pillar on the driver's side.

- Position heavy loads as far forwards as possible and as low down in the trunk/cargo compartment as possible.
- The load must not protrude above the upper edge of the seat backrests.
- always place the load against the rear or front seat backrests. Make sure that the seat backrests are securely locked into place.
- Always place the load behind unoccupied seats if possible.
- Secure the load with sufficiently strong and wear-resistant tie down. Pad sharp edges for protection.

## Stowage compartments

### Important safety notes

#### **Warning!**

To help avoid personal injury during a collision or sudden maneuver, exercise care when storing objects in the vehicle. Put luggage or cargo in the trunk if possible.

Do not pile luggage or cargo higher than the seat backrests.

Keep compartment lids closed. This will help to prevent stored objects from being thrown about and injuring vehicle occupants during

- braking
- vehicle maneuvers
- an accident

## Stowage compartments in the front

### Glove box

- i** Depending on the vehicle equipment, there is an AUX-IN connection or a Media Interface installed in the glove box. Media Interface is a universal interface for mobile audio equipment, e.g. for an iPod® or USB

devices; see separate COMAND operating instructions.

- i** The glove box can be ventilated (> page 144).

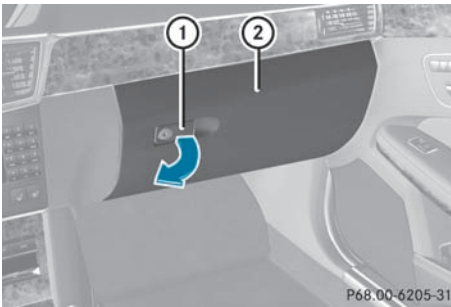

- ▶ **To open:** pull handle ① and open glove box flap ②.
- ▶ **To close:** fold glove box flap ② upwards until it engages.

The glove box can only be locked and unlocked using the mechanical key.

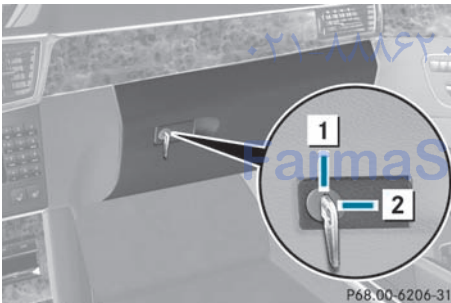

- ▶ **To lock:** insert the mechanical key into the lock and turn it 90° clockwise to position ②.
- ▶ **To unlock:** insert the mechanical key into the lock and turn it 90° counter-clockwise to position ①.

### Stowage compartment in the center console

- i** A stowage compartment is located under the cup holder at the front of the center console.

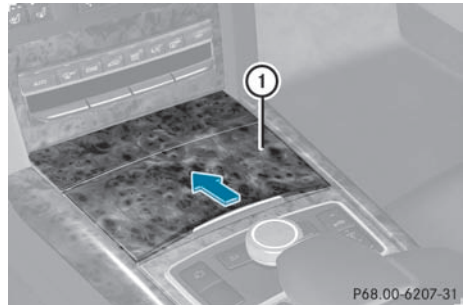

- ▶ **To open:** slide cover ① forwards until it engages.
- ▶ Remove the cup holder at the front of the center console (> page 288).

### Stowage compartment under the armrest

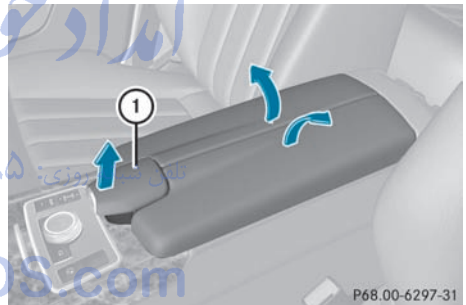

All models except E 63 AMG

- ▶ **To open:** pull handle ① upwards. The armrest folds out.

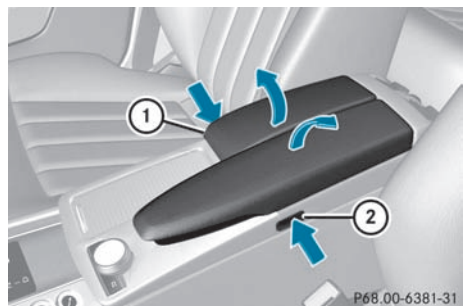

E 63 AMG

- ▶ **To open:** press left-hand button ② or right-hand button ①.

The stowage compartment opens.

### Stowage compartments in the rear

#### Stowage pockets

##### Warning!

Storage bags are intended for storing light-weight items only.

Heavy objects, objects with sharp edges or fragile objects may not be transported in the storage bag. In an accident, during hard braking, or sudden maneuvers, they could be thrown around inside the vehicle and cause injury to vehicle occupants.

Storage bags cannot protect transported goods in the event of an accident.

Storage bags are located in the rear compartment on the driver's and front-passenger seat backrests.

### Stowage areas

#### Parcel nets

##### Warning!

Parcel nets are intended for storing light-weight items only, such as road maps, mail, etc.

Heavy objects, objects with sharp edges, or fragile objects may not be transported in the parcel nets. In an accident, during hard braking, or sudden maneuvers, they could be thrown around inside the vehicle and cause injury to vehicle occupants.

Parcel nets cannot protect transported goods in the event of an accident.

Parcel nets are located in the front-passenger footwell and on the left and right-hand sides of the trunk/cargo compartment.

### Skibag

#### Unfolding the skibag and loading the skis

##### Warning

The skibag is designed for up to four pairs of skis. Do not load the skibag with any other objects.

Always fasten the skibag securely. In an accident, an unfastened ski bag can cause injury to vehicle occupants.

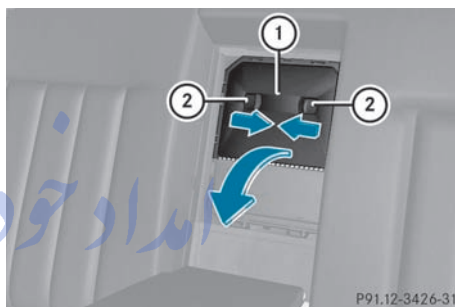

- ▶ Fold down the rear seat armrest.
- ▶ Press release catches ② together and fold down cover ①.



- ▶ Pull skibag ① into the vehicle interior. The skibag unfolds.
- ▶ Open the trunk lid.



### Through-loading feature in the rear

#### Warning!

Do not transport any unsecured items in the through-loading area.

The through-loading facility is opened from the trunk.

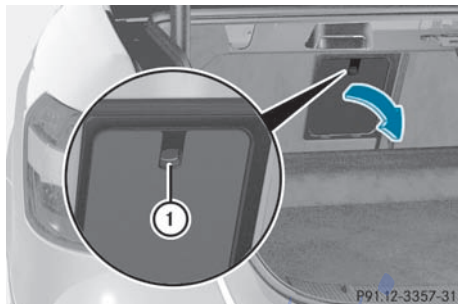

- ▶ Fold down the rear seat armrest.
- ▶ Press release button ①. The flap opens downwards.

### Through-loading feature, rear bench seat (Sedan)

#### Important safety notes

#### Warning!

When expanding the cargo volume, always fold the seat backrests fully forward.

Unless you are transporting cargo, the seat backrests must remain properly locked in the upright position.

In an accident, during hard braking or sudden maneuvers, loose items will be thrown around inside the vehicle. This can cause injury to vehicle occupants unless the items are securely fastened in the vehicle.

Always use the cargo tie-down rings.

The left-hand and right-hand rear seat backrests can be folded down separately to increase the trunk capacity.

### Folding the rear seat backrest forward

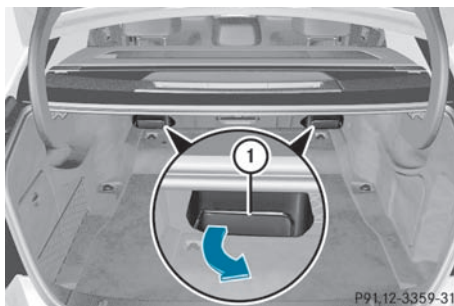

**i** Vehicles with memory function: when you fold one or both parts of the rear seat backrest forwards, the respective front seat moves forward slightly, when necessary, in order to avoid contact.

- ▶ Vehicles without memory function: if necessary, move the driver's or front-passenger seat forwards.
- ▶ Open the trunk.
- ▶ Pull right-hand or left-hand rear seat backrest release handle ①. The corresponding rear seat backrest is released and the rear seat head restraints are lowered.

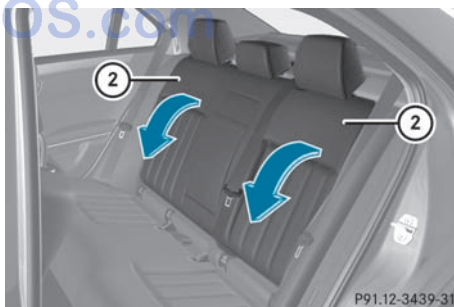

- ▶ Fold rear seat backrest ② forwards.
- ▶ Move the driver's or front-passenger seat back if necessary.



## Folding the rear seat backrest back

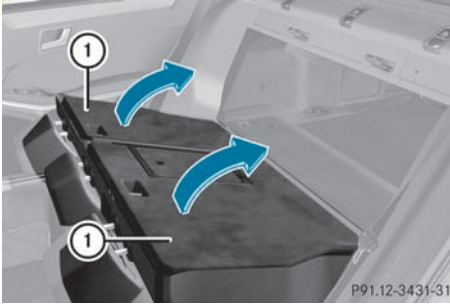

- ▶ Move the driver's or front-passenger seat forward if necessary.
- ❗ Make sure that the seat belt does not become trapped when folding the rear seat backrest back. Otherwise, it could be damaged.
- ▶ Fold rear seat backrest ① back until it engages.

### ⚠ Warning!

Always lock the seat backrest in its upright position when the rear seat bench is occupied, or the extended cargo volume is not in use.

Check for secure locking by pushing and pulling on the seat backrest.

In an accident, during hard braking or sudden maneuvers, loose items will be thrown around inside the vehicle. This can cause injury to vehicle occupants unless the items are securely fastened in the vehicle.

To help avoid personal injury during a collision or sudden maneuver, exercise care when transporting cargo.

- ① You should always engage the rear seat backrests if you do not need the through-loading feature. This will prevent unauthorized access to the trunk from the vehicle interior.

- ▶ Adjust the head restraints if necessary (▷ page 105).
- ▶ Move the driver's or front-passenger seat back if necessary.

## EASY-PACK through-loading feature, rear bench seat (Wagon)

### Important safety notes

#### ⚠ Warning!

Never drive a vehicle with the tailgate open. Deadly carbon monoxide (CO) gases may enter vehicle interior resulting in unconsciousness and death.

## Folding the rear seat backrest forward

The left-hand and right-hand rear seat backrests can be folded forwards separately to increase the cargo compartment capacity.

The combined cargo cover and net can remain installed.

- ❗ When folding the rear seat backrest forwards, ensure that there are no items lying on the seat cushions. These items could otherwise be damaged or could themselves damage the rear seats.
- ① When you fold either or both parts of the rear seat backrests forwards, the headrests are also lowered if necessary. In the case of vehicles with memory function, the respective front seat is moved forwards slightly to avoid contact with the seat behind it.

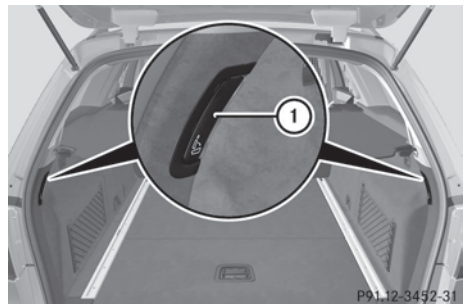

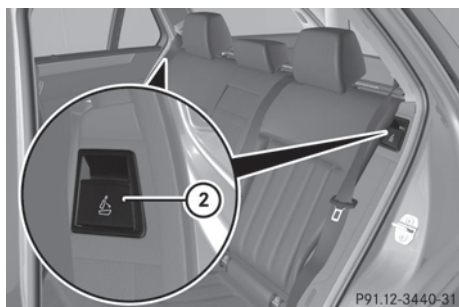

- ▶ Vehicles without memory function: if necessary, move the driver's or front-passenger seat forwards.
- ▶ Pull the left-hand or right-hand release handle at the rear in cargo compartment ① or at the side beside backrests ②. The corresponding backrest folds forwards.
- ▶ Move the driver's or front-passenger seat back if necessary.

### Folding the rear seat backrest back



- ▶ Move the driver's or front-passenger seat forward if necessary.
- ❗ Make sure that the seat belt does not become trapped when folding the rear seat backrest back. Otherwise, it could be damaged.
- ▶ Fold seat backrest ① back until it engages.

### Risk of injury

Make sure that the rear seat backrest is correctly engaged. Otherwise, vehicle occupants could be injured by objects being thrown around if you

- brake sharply
- change direction suddenly
- are involved in an accident

If the rear seat backrest is not engaged, this will be shown in the multifunction display in the instrument cluster.

- ▶ Adjust the head restraints if necessary (▷ page 105).
- ▶ Move the driver's or front-passenger seat back if necessary.

### Securing cargos

#### Coat hooks (Sedan)

On vehicles without a through-loading feature in the rear bench seat, six plastic hooks are installed to the trunk floor.

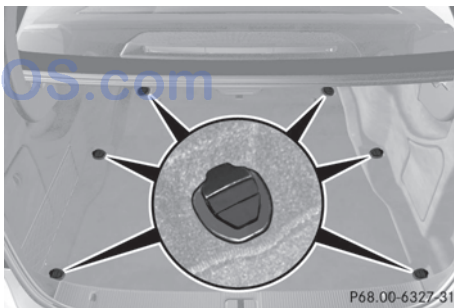

#### Lashing eyelets

Observe the following notes on securing loads:

- secure the load using the cargo tie down rings.
- do not use elastic straps or nets to secure a load, as these are only intended as an anti-slip protection for light loads.



- do not route tie downs across sharp edges or corners.
- pad sharp edges for protection.

There are six cargo tie down rings in the trunk/cargo compartment.



Sedan

① cargo tie down rings

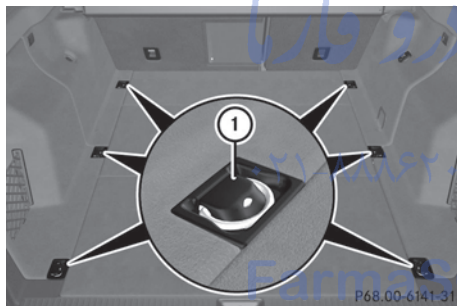

Wagon

① cargo tie down rings

### Bag hooks in the trunk/cargo compartment

#### Important safety notes

- ❗ The bag hook can bear a maximum load of 6.6 lbs (3 kg). Do not use it to secure a load.

#### Sedan

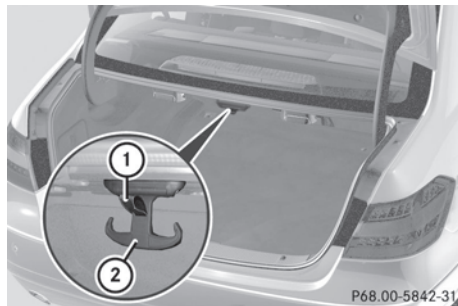

- ▶ Pull bag hook ② down by tab ①.

#### Wagon

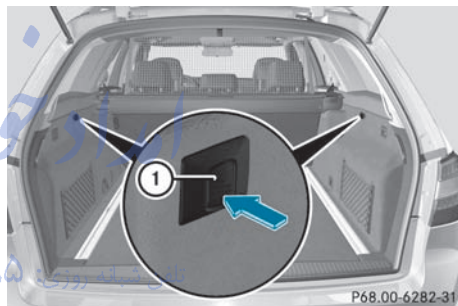

- ▶ **To open:** press bag hook ① (arrow). Bag hook ① slides out.
- ▶ **To close:** press bag hook ① until it engages.

### EASY-PACK cargo compartment cover

#### Important safety notes

- ❗ When loading the vehicle, make sure that you do not stack the load in the cargo compartment higher than the lower edge of the side windows. Do not place heavy objects on top of the cargo compartment cover.

The cargo compartment cover and the cargo net are attached to anchorages on the right and left in the cargo compartment as a combined cargo cover and net.

When the tailgate is opened, the cargo compartment cover is automatically raised to make loading easier. It is automatically lowered again when the tailgate is closed.

When the cargo compartment cover is clipped in, there should be no objects obstructing the downwards movement of the cover in the cargo compartment when the tailgate is closed. The cargo compartment cover will otherwise be raised again.

### Extending/retracting the luggage compartment cover

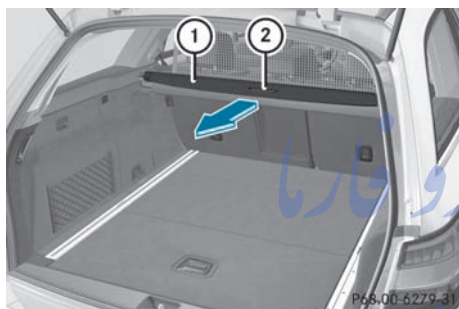

- ▶ **To extend:** pull cargo compartment cover ① back by grab handle ② and clip it into the retainers on the left and right.

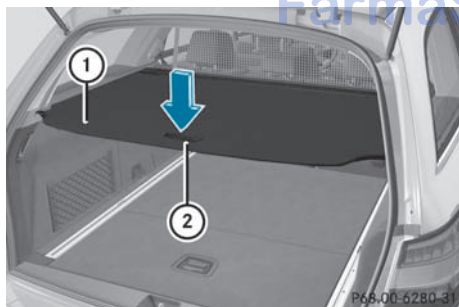

- ▶ **To retract:** unhook cargo compartment cover ① from the retainers on the left and right and guide it forwards by grab handle ② until it is fully retracted.

### Removing/installing the combined cargo cover and net

You can reach the combined cargo cover and net to install and remove it from the cargo compartment and, with the seat backrest folded forwards, from the left-hand rear door.

- ▶ Ensure that the cargo net and the cargo compartment cover are rolled up.

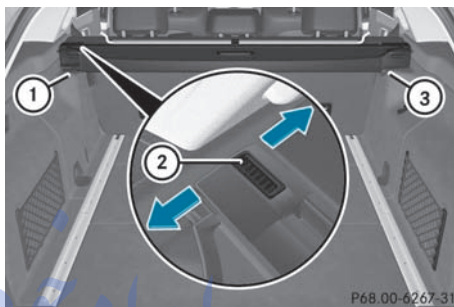

- ▶ **To remove:** press button ②.
- ▶ Fold the combined cargo cover and net forwards on the left-hand side with the seat backrest folded forwards and fold it backwards with the seat backrest folded up.
- ▶ First, detach the combined cargo cover and net from left-hand catch ① and then remove it from right-hand fixture ③.
- ▶ **To install:** push the combined cargo cover and net up to the stop into right-hand fixture ③.
- ▶ Place the combined cargo cover and net into the left-hand fixture and push it into catch ① until the combined cargo cover and net engages.

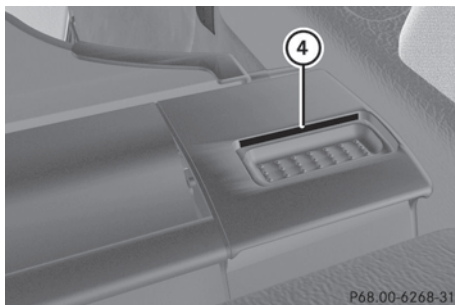

- ▶ Ensure that red lock status indicator ④ is no longer visible. The combined cargo cover and net will otherwise not be locked in place.

### Attaching the combined cargo cover and net to the seat backrest in the rear

- ▶ Fold the left and right seat backrest forwards (▷ page 279).

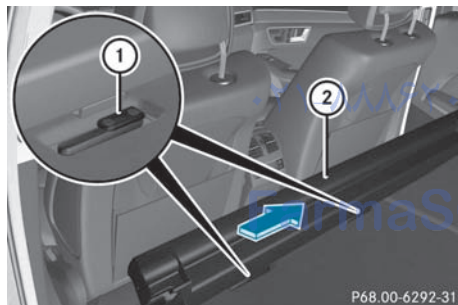

- ▶ Insert combined cargo cover and net ② into the two guides ① and push it up to the stop in the direction of the arrow.

**!** If you have attached the combined cargo cover and net to a rear seat backrest that is folded forwards, do not fold the backrest back.

### Cargo net (Wagon)

#### Important safety notes

When the vehicle is loaded with objects that extend beyond the seat backrests, using a

cargo net is particularly important. For reasons of safety, a cargo net should always be used when transporting cargo.

### Cargo net without cargo compartment enlargement

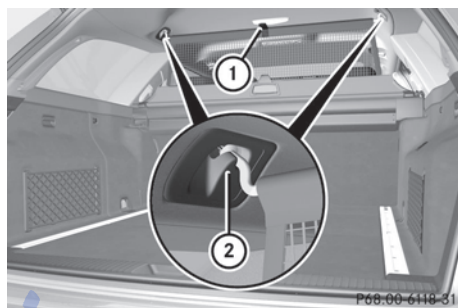

- ▶ Pull the cargo net up by tab ① and hook it into eyelets ②.

### Cargo net with cargo compartment enlargement

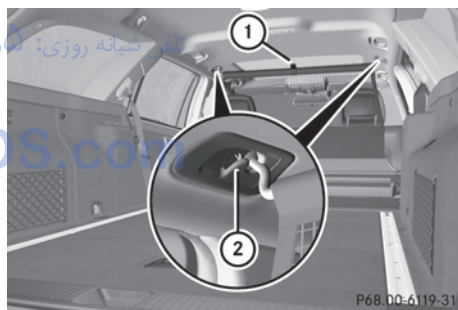

- ▶ Make sure that the cargo net is attached to the rear seat backrest (▷ page 282).
- ▶ Guide the cargo net up by tab ① and hook it into eyelets ②.

### Coat hooks on the tailgate

#### **⚠ Warning!**

The tailgate may close if too great a load is placed on the coat hooks.

You and/or others could be trapped and injured.

Only use the coat hooks for light clothing.

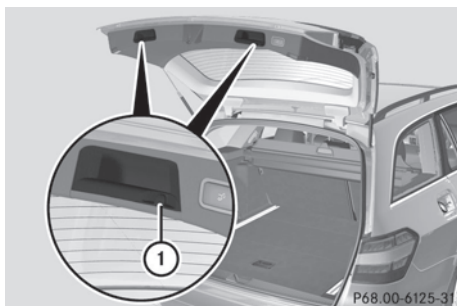

① Coat hooks

### EASY-PACK cargo securing kit (Wagon)

#### Components and stowage

The EASY-PACK load-securing kit allows you to use your cargo compartment for a variety of purposes. The accessory parts are located under the trunk floor.

- ▶ Open the EASY-PACK folding luggage-compartment floor (▷ page 285).

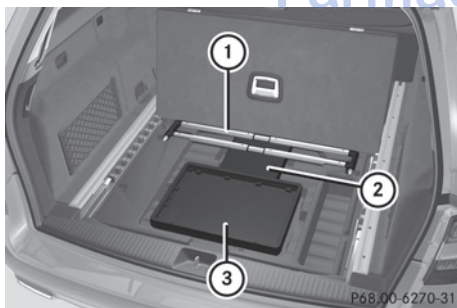

EASY-PACK load-securing kit accessory parts

- ① Telescopic rod
- ② Bag containing the brackets and luggage holder
- ③ Folding box

#### Luggage holder

The luggage holder can be used to secure light loads against the side wall of the cargo compartment to prevent them from moving around.

- ⚠ Only use the luggage holder to secure cargo with a maximum weight of 15.4 lb (7 kg) and with dimensions that the luggage holder can safely and securely contain.

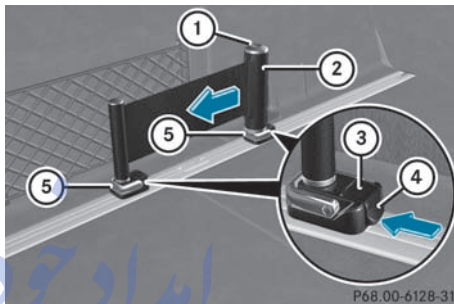

- ▶ **To install:** insert two brackets ⑤ into the left or right loading rail (▷ page 284).
- ▶ Press release button ① of the luggage holder and pull the belt out slightly.
- ▶ Insert luggage holder ② into brackets ⑤ and, while doing so, press release button ③ and push the luggage holder downwards until it engages.
- ▶ Press release button ① of the luggage holder and pull the belt out slightly in the direction of the arrow.
- ▶ Place the load between the belt and the cargo compartment side wall.
- ▶ Using one hand, press locking button ① of the luggage holder.
- ▶ With your other hand, slowly extend the belt around the load until it is secure.
- ▶ Make sure that locking button ④ on brackets ⑤ is pressed. This keeps brackets ⑤ in place on the loading rail.

- ▶ **To remove:** press release button ③ on respective bracket ⑤ and remove luggage holder ② by pulling upwards and out.

### Telescopic rod

The telescopic rod can be used to secure the load against the rear seats to prevent it from moving around.

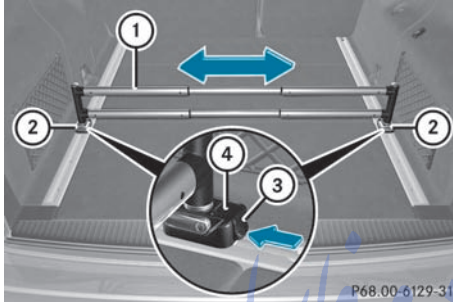

- ▶ **To install:** insert one bracket ② into both the left and the right loading rails and slide it to the desired position (▷ page 284).
- ▶ Insert telescopic rod ① into brackets ② and, while doing so, press release button ④ and push the rod downwards until it engages.
- ▶ Ensure that locking button ③ on brackets ② is pressed. This keeps brackets ② in place on the loading rail.
- ▶ **To remove:** press release button ④ on respective bracket ② and remove telescopic rod ① by pulling it upwards and out.

### Stowage space under the trunk floor (Sedan)

The TIREFIT kit, the vehicle tool kit, etc. are located in the stowage compartment.

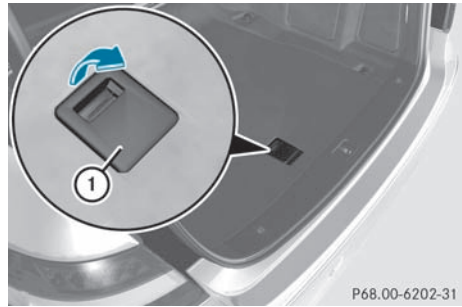

- ▶ **To open:** pull handle ① upwards.

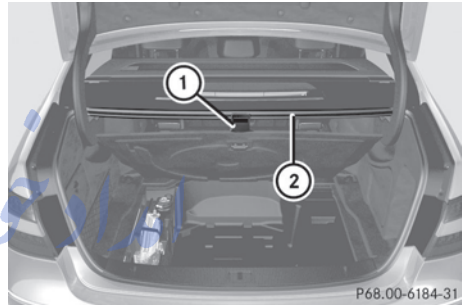

- ▶ Hook handle ① into rain trough ②.
- ▶ **!** Unhook the handle before again before closing the trunk lid and clip it in securely to prevent the handle flap from protruding. Otherwise, you could damage the handle.

### EASY-PACK folding floor with stowage space under the cargo compartment floor (Wagon)

#### Important safety notes

##### Risk of injury

Do not carry unsecured objects under the EASY-PACK folding luggage-compartment floor if it is open.

Otherwise, you and other vehicle occupants could be injured by objects being thrown around the vehicle in the event of sharp braking, a sudden change in direction or an accident.



**!** Do not apply pressure to the EASY-PACK folding luggage-compartment floor when it is fully open. You may otherwise damage the hinges of the EASY-PACK folding luggage-compartment floor.

### Opening and closing the folding cargo compartment floor

A removable insert under the EASY-PACK folding luggage-compartment floor contains the parts of the EASY-PACK load-securing kit and a folding box. Beneath the insert, you will find the TIREFIT kit, the "Minispare" emergency spare wheel, the vehicle tool kit, etc.

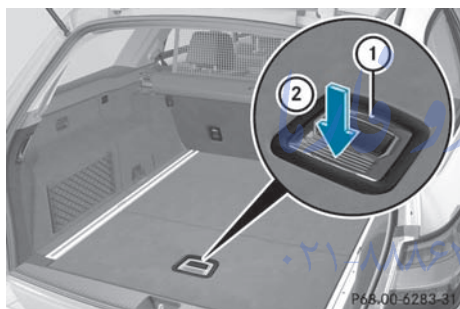

- ▶ **To open:** open the tailgate.
- ▶ Holding the ribbing, press handle ① downwards ②.
- Handle ① folds upwards.

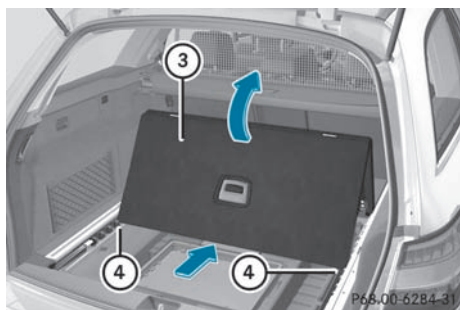

- ▶ Pull EASY-PACK folding luggage-compartment floor ③ in the direction of

the arrow by handle ① until it reaches the desired position and engages in side ④.

- ▶ **To close:** disengage the EASY-PACK folding luggage-compartment floor and pull it back.
- ▶ Press the EASY-PACK folding luggage-compartment floor down ② until it engages.

### Fitting and removing the folding cargo compartment floor

- ▶ Remove the combined cargo cover and net (▷ page 282).

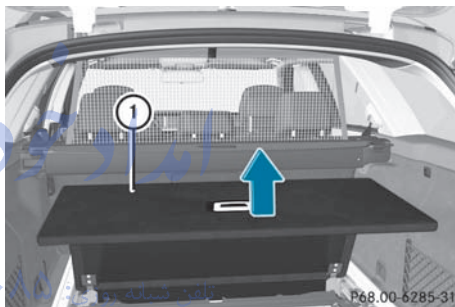

120° position

- ▶ **To remove:** move EASY-PACK folding luggage-compartment floor ① into the 120° position and lift it upwards.
- ▶ **To install:** push EASY-PACK folding luggage-compartment floor ① to the stop, move it into the 120° position and make sure it engages audibly.
- ▶ Pull EASY-PACK folding luggage-compartment floor ① forwards.

### EASY-PACK rear sill protector (Estate)

The EASY-PACK rear sill protector is attached to the underside of the EASY-PACK folding luggage-compartment floor by means of magnets. It is designed to prevent clothing becoming stained and the paintwork being scratched when loading.

- ▶ Open the EASY-PACK folding luggage-compartment floor (▶ page 285).

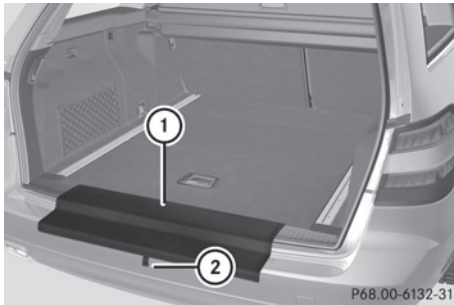

- ▶ Use tab ② to detach EASY-PACK rear sill protector ① from the magnets and place it over the loading sill.
- ▶ Close the EASY-PACK folding luggage-compartment floor.

- ❗ Before closing the tailgate, refasten the EASY-PACK rear sill protector on the underside of the EASY-PACK folding luggage-compartment floor.

The EASY-PACK rear sill protector could otherwise be damaged.

## Roof carrier

### Important safety notes

#### ⚠ Warning!

Only use roof racks approved by Mercedes-Benz for your vehicle model to avoid damage to the vehicle.

Follow the manufacturer's installation instructions. Otherwise, an improperly attached roof rack system or its load could become detached from the vehicle.

Do not exceed the maximum roof load of 220 lb (100 kg).

Take into consideration that when the roof rack is loaded, the handling characteristics are different from those when operating the vehicle without the roof rack loaded.

- ❗ Mercedes-Benz recommends that you only use roof carriers that have been tested and approved for Mercedes-Benz vehicles. This helps to prevent damage to the vehicle.

Position the cargo on the roof carrier in such a way that the vehicle will not sustain damage even when it is in motion.

Ensure that, depending on the vehicle's equipment, you can raise the tilt/sliding sunroof or panorama roof with power tilt/sliding panel fully and open the trunk lid/tailgate fully when the roof carrier is installed.

- ❗ To avoid damaging or scratching the covers, do not use metallic or hard objects to open them.

### Attaching the roof carrier (Sedan)

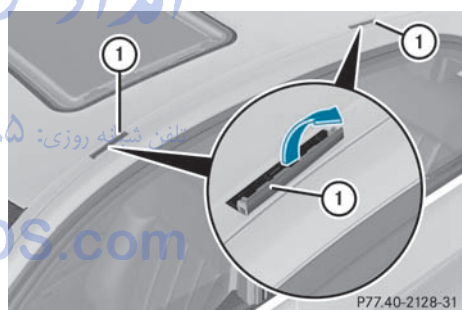

Vehicles with a steel roof or tilt/sliding sunroof (illustration)\*

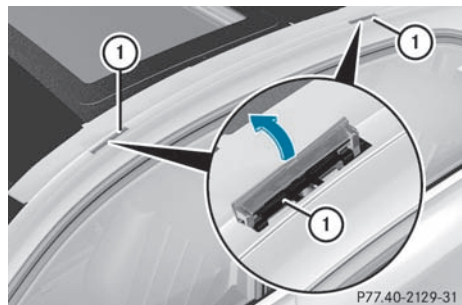

Vehicles with a panorama roof with power tilt/sliding panel

\* optional

- ▶ Open covers ① carefully in the direction of the arrow.
- ▶ Fold covers ① upwards.
- ▶ Only secure the roof carrier to the anchorage points under covers ①.
- ▶ Observe the manufacturer's installation instructions.

### Attaching the roof carrier (Wagon)

- ▶ Secure the roof carrier to the roof rails.
- ▶ Observe the manufacturer's installation instructions.

## Features

### Cup holder

#### Points to observe before use

#### Warning

In order to help prevent spilling liquids on vehicle occupants and/or vehicle equipment, only use containers that fit into the cup holder. Use lids on open containers and do not fill containers to a height where the contents, especially hot liquids, could spill during braking, vehicle maneuvers, or in an accident. Liquids spilled on vehicle occupants may cause serious personal injury. Liquids spilled on vehicle equipment may cause damage not covered by the Mercedes-Benz Limited Warranty.

When not in use, keep the cup holder closed. An open cup holder may cause injury to you or others when contacted during braking, vehicle maneuvers, or in an accident.

Keep in mind that objects placed in the cup holder may come loose during braking, vehicle maneuvers, or in an accident and be thrown around in the vehicle interior. Objects thrown around in the vehicle interior may cause an accident and/or serious personal injury.

### Cup holder in the center console

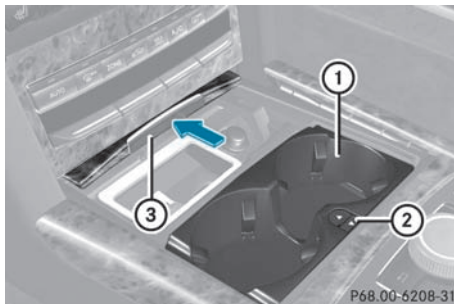

All vehicles except E 63 AMG

- ▶ **To open:** slide cover ③ forwards until it engages.
- ▶ **To remove:** slide catch ② forwards and pull out cup holder ①.
- ▶ **To insert:** insert cup holder ① and slide back catch ②.
- ▶ **To close:** press cover ③ briefly at the front. Cover ③ moves back.



E 63 AMG

- ▶ **To open:** slide cover ① back.

### Cup holder in the rear seat armrest

- ⚠ Do not sit or lean your bodyweight on the armrests when they are folded out as you could damage them.
- ⚠ Only fold the armrests up when the cup holder is closed. The cup holder may otherwise be damaged.



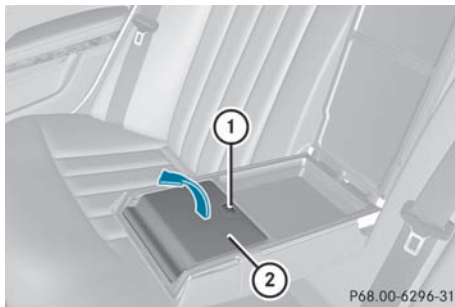

P68.00-6296-31

- ▶ **To open:** raise the armrest cover.
- ▶ Press release catch ①. Cup holder ② folds out forwards.
- ▶ Swing the armrest cover back down, if necessary.
- ▶ **To close:** raise the armrest cover.
- ▶ Swing cup holder ② back until it engages.
- ▶ Swing the armrest cover back down, if necessary.

### Bottle holder

#### **Warning!**

Do not transport heavy, sharp-edged, or fragile bottles in the bottle holder. In the event of an accident, the bottle holder cannot secure a bottle sufficiently. You and/or vehicle occupants could be injured.

- ! Make sure that any bottles weighing more than 0.5 kg that are stored in the bottle holder rest on the vehicle floor. The bottle holder could otherwise be damaged.

The bottle holder is designed for bottles with a capacity of 25 fl.oz (0.7 l) to 54 fl.oz (1.5 l). The bottle holder does not secure the bottles; it merely prevents them from tipping over.

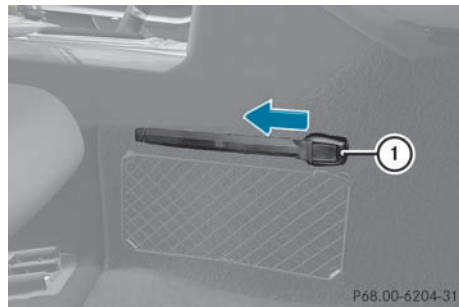

P68.00-6204-31

- ▶ Press the outer edge of button ① and slide in the direction of the arrow until the bottle fits into the opening.
- ▶ Insert the bottle into the bottle holder.

### Sun visors

#### **Warning**

Do not use the vanity mirror while driving. Keep the vanity mirrors in the sun visors closed while the vehicle is in motion. Reflected glare can endanger you and others.

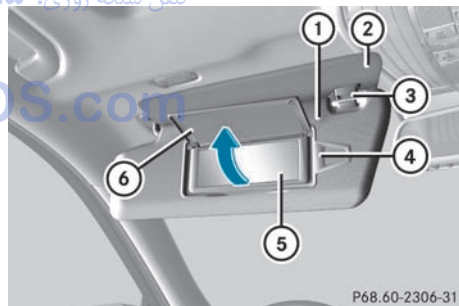

P68.60-2306-31

- ① Mirror light
- ② Additional sun visor
- ③ Bracket
- ④ Retaining clip, e.g. for a car park ticket
- ⑤ Vanity mirror
- ⑥ Mirror cover

### Vanity mirror in the sun visor

Mirror light ① only functions if the sun visor is clipped into retainer ② and mirror cover ⑤ has been folded up.

### Glare from the side

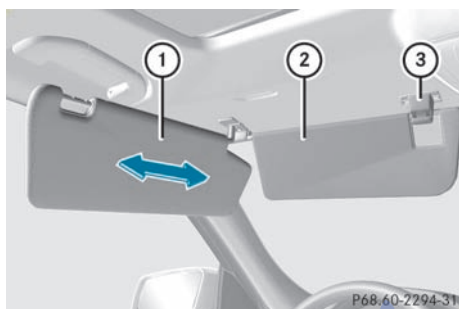

- ▶ Fold down sun visor ①.
- ▶ Pull sun visor ① out of retainer ③.
- ▶ Swing sun visor ① to the side.
- ▶ **Vehicles with an additional sun visor:** slide sun visor ① horizontally as desired.
- ▶ Fold down additional sun visor ②.

### Roller sunblinds for the rear side windows

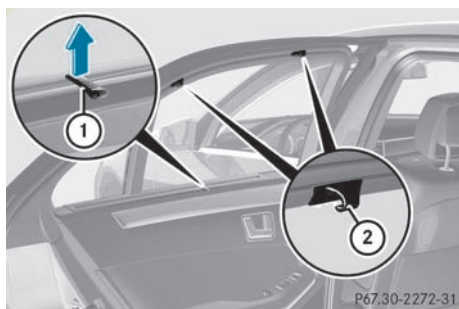

- ▶ **To extend:** pull the roller sunblind out by tab ① and hook it onto retainers ② at the top of the window.

❗ Always guide the roller sunblind by hand. Do not let it snap back suddenly as this

would damage the automatic roller mechanism.

- ❗ Do not drive the vehicle with the roller sunblind hooked in and the side windows opened simultaneously. The roller sunblind can jump out of the retainers and spring back suddenly when driving at high speeds, e.g. when driving on the freeway. This could damage the inertia reel. Therefore, either close the side window or retract the roller sunblind before driving at high speeds.

### Rear window roller sunblind (Sedan)

#### To extend/retract the roller sunblind

#### ⚠ Warning

When leaving the vehicle, always remove the SmartKey from the ignition lock. Always take the SmartKey with you and lock the vehicle. Do not leave children unattended in the vehicle, even if they are secured in a child restraint system, or with access to an unlocked vehicle. A child's unsupervised access to a vehicle could result in an accident and/or serious personal injury. The children could:

- injure themselves on parts of the vehicle
- be seriously or fatally injured through excessive exposure to extreme heat or cold
- injure themselves or cause an accident with vehicle equipment that can be operated even if the SmartKey is removed from the ignition lock or removed from the vehicle, such as seat adjustment, steering wheel adjustment, or the memory function

If children open a door, they could injure other persons or get out of the vehicle and injure themselves or be injured by following traffic.

Do not expose the child restraint system to direct sunlight. The child restraint system's metal parts, for example, could become very hot, and the child could be burned on these parts.

**Warning!**

When operating the rear window sunshade make sure there is no danger of anyone being harmed by the extending or retracting procedure.

The extending or retracting procedure can be immediately halted by briefly pressing rear window sunshade switch. To reverse direction of movement, press rear window sunshade switch again.

- Make sure that the roller sunblind can move freely. Otherwise, the roller sunblind or other objects could be damaged.

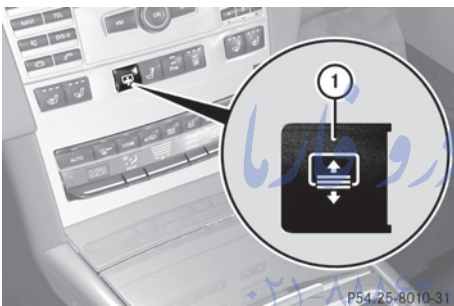

- Turn the key to position **2** in the ignition lock.
- To extend or retract:** briefly press button **1**.  
The roller sunblind fully extends or fully retracts.

**Ashtray**

**Ashtray in the cockpit**

- There is a stowage space under the ashtray.
- The stowage space under the ashtray is not heat resistant. Before placing lit cigarettes in the ashtray, make sure that the ashtray is properly engaged. Otherwise, the stowage space could be damaged.

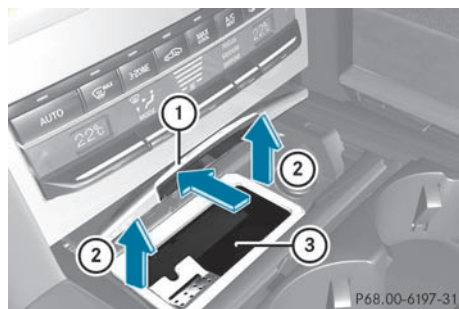

- To open:** slide cover **1** forwards until it engages.
- To remove the insert:** hold insert **3** by the ribbing at the sides and lift it up and out **2**.
- To refit the insert:** press insert **3** into the holder until it engages.
- To close:** press cover **1** briefly at the front.  
The cover moves back.

**Ashtray in the rear compartment**

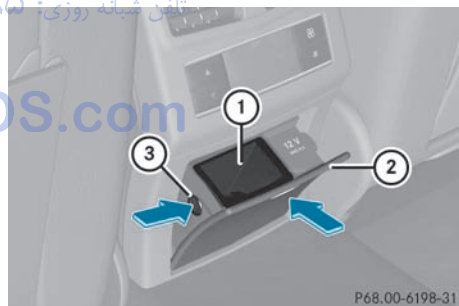

- To open:** briefly press cover **2** at the top.  
The ashtray opens.
- To remove the insert:** press release button **3** and lift the insert up and out.
- To re-insert the insert:** replace insert **1** from above.
- Press insert **1** into the holder until it engages.

## Cigarette lighter

### ⚠ Warning

When leaving the vehicle, always remove the SmartKey from the ignition lock. Always take the SmartKey with you and lock the vehicle. Do not leave children unattended in the vehicle, even if they are secured in a child restraint system, or with access to an unlocked vehicle. A child's unsupervised access to a vehicle could result in an accident and/or serious personal injury. The children could:

- injure themselves on parts of the vehicle
- be seriously or fatally injured through excessive exposure to extreme heat or cold
- injure themselves or cause an accident with vehicle equipment that can be operated even if the SmartKey is removed from the ignition lock or removed from the vehicle, such as seat adjustment, steering wheel adjustment, or the memory function

If children open a door, they could injure other persons or get out of the vehicle and injure themselves or be injured by following traffic.

Do not expose the child restraint system to direct sunlight. The child restraint system's metal parts, for example, could become very hot, and the child could be burned on these parts.

### ⚠ Warning

Never touch the heating element or sides of the lighter; they are extremely hot. Hold the knob only.

Make sure any children traveling with you do not injure themselves or start a fire with the hot cigarette lighter.

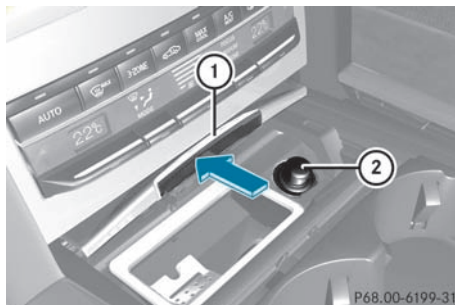

Center console, front

- ▶ Turn the key to position **2** in the ignition lock.
- ▶ Slide cover **①** forwards until it engages.
- ▶ Press in cigarette lighter **②**. Cigarette lighter **②** will pop out automatically when the heating element is red-hot.

## 12 V sockets

### Points to observe before use

- ⚠ If you are using all sockets in the vehicle, make sure that you do not exceed the maximum current draw of 55 A. Otherwise, you will overload the fuses.

The socket can be used for accessories with a maximum power consumption of 180 W, e.g. lamps or chargers for mobile phones.

If you use the socket for long periods when the engine is switched off, the battery may discharge.

### Dashboard socket

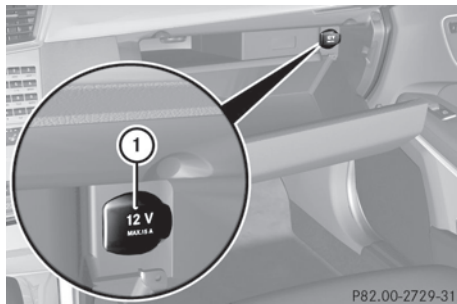

- ▶ Open the glove box (▷ page 274).
- ▶ Lift up the cover of socket ①.

An additional socket is installed in the center console on vehicles without an ashtray with cigarette lighter.

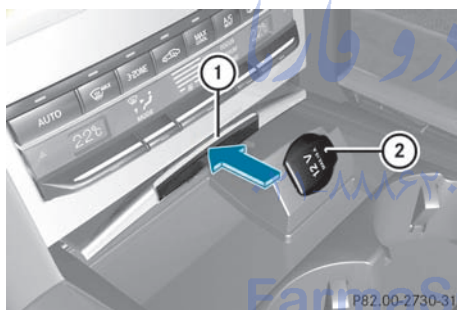

- ▶ **To open:** slide cover ① forwards until it engages.
- ▶ Lift up the cover of socket ②.
- ▶ **To close:** press cover ① briefly at the front.  
The cover moves back.

### Socket in the rear compartment

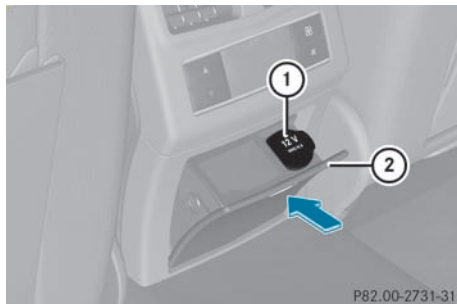

- ▶ Briefly press cover ② at the top.  
The cover opens.
- ▶ Lift up the cover of socket ①.

### Socket in the trunk/cargo compartment



#### Socket in the trunk (Sedan)

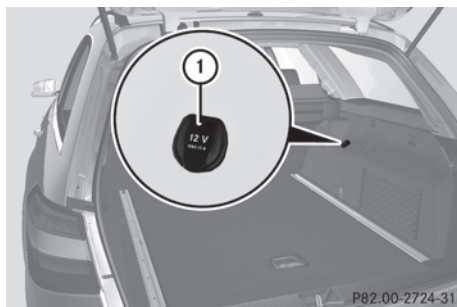

#### Socket in the cargo compartment (Wagon)

- ▶ Lift up the cover of socket ①.

## 115 V socket

### ⚠ Warning!

The 115V AC socket operates at high voltage. Use the 115V AC socket in the vehicle with the same caution and prudence that you exercise when using power outlets at home. Keep any fluids away from the 115V AC socket. Do not clean the socket with fluids or tapered objects. Keep the 115V AC socket cover in the closed position, when not in use. Otherwise, you could suffer an electric shock and be seriously or even fatally injured.

### ⚠ Warning!

A device that you connect must have a suitable plug that complies with U.S. standards. Never pull on the cable to unplug a plug from the 115V AC socket. Do not use a damaged connection cable. The 115V AC socket may not be connected to another 115V AC power source. Do not use converters to a grounding plug with the 115V AC socket. This could cause serious personal injury to you and/or others.

### ⚠ Warning!

If the 115V AC socket is damaged or torn out of the trim, do not use or touch the 115V AC socket. Using a 115V AC socket that is damaged or torn out of the trim could cause serious personal injury to you and/or others.

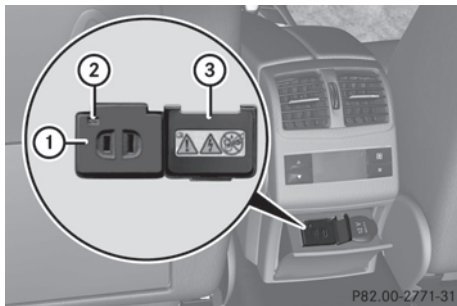

The 115 V AC socket ① provides an alternating voltage of 115 V, so that small electronic devices can be connected. These

devices, such as games consoles, chargers and laptops, together should not consume more than a maximum of 150 W.

Requirements for this are:

- 12 V sockets in the footwell of the second row of seats and in the stowage compartment must be functioning correctly (▷ page 292).
- the plug of the electronic device is plugged into the 115 V socket ①.
- the on-board voltage is within the permissible voltage range.
- the specified wattage of the electronic device is equal to or less than the maximum permissible wattage (150 W) of 115 V socket ①.

► Open flap ③.

► Insert the plug of the electronic device into 115 V socket ①. Indicator lamp ② lights up.

If indicator lamp ② does not light up, please read the chapter on malfunctions.

► **To turn off:** disconnect the plug from the 115 V socket ①.

Do not pull on the cable.

► Close flap ③.

Possible causes of malfunction:

- the on-board voltage is not within the permissible voltage range.
- the temperature of the DC/AC converter is momentarily too high.
- some small electronic devices have a constant power rating of less than 150 W but a very high switch-on current. These devices will not work. If you connect such a device, the 115 V socket ① will not supply it with power.

If indicator lamp ② still does not light up, consult a specialist workshop, e.g. an authorized Mercedes-Benz Center.



**mbrace<sup>26</sup>****Important safety notes**

**!** A license agreement must exist in order to activate the mbrace service. Make sure that your system is activated and ready for use, and press the  MB info call button to register. If you cannot carry out any of the steps mentioned, the system may not be activated.

If you have any questions concerning activation, please contact one of the following service hotlines:

- **USA:** Response Center under 866-990-9007
- **Canada:** Customer Service under 1-888-923-8367

Shortly after successfully registering with the mbrace service, a user ID and password will be sent to you by post. You can use this password to log in to the mbrace section under "Owners Online" at <http://www.mbusa.com><sup>27</sup>.

The mbrace system is available if:



- it has been activated and is operational. Activation requires an available cellular phone network, a valid SIM card and a service subscription to a surveillance service provider.
  - the battery is sufficiently charged.
  - the corresponding cellular phone network is available for transmitting data to the customer center.
- i** Determining the location of the vehicle on a map is only possible if there is sufficient GPS reception and the vehicle position can be forwarded to the customer center.

**The mbrace system**

The mbrace system provides three different services:

- automatic and manual emergency call
- Roadside Assistance call
- MB info call

To control the volume during an mbrace call, proceed as follows:

▶ Press the  or  button on the multifunction steering wheel.

or

▶ Use the volume controller of COMAND.





You can find information and a description of all available features under "Owners Online" at <http://www.mbusa.com><sup>28</sup>

**System self-test**

After you have switched on the ignition, the system carries out a self-diagnosis.

**⚠ Warning**

A malfunction in the system has been detected if any or all of the following conditions occur:

- The indicator lamp in the SOS button does not come on during the system self-test.
- The indicator lamp in Roadside Assistance button  does not come on during the system self-test.
- The indicator lamp in Information button  does not come on during the system self-test.
- The indicator lamp in the SOS button, Roadside Assistance button , or Information button  remains illuminated constantly in red after the system self-test.
- The message Tele Aid Inoperative or Tele Aid Not Activated appears in the

<sup>26</sup> The system is called TELEAID in Canada.

<sup>27</sup> USA only.

<sup>28</sup> USA only.



multifunction display after the system self-test.

If a malfunction is indicated as outlined above, the system may not operate as expected. In case of an emergency, help will have to be summoned by other means.

Have the system checked at the nearest authorized Mercedes-Benz Center or contact the following service hotlines:

- **USA:** Response Center under the number 866-990-9007
- **Canada:** Customer Service under 1-888-923-8367.

## Emergency call

### Important safety notes

**!** A license agreement must exist in order to activate the mbrace service. Make sure that your system is activated and ready for use, and press the  MB info call button to register. If you cannot carry out any of the steps mentioned, the system may not be activated.

If you have any questions concerning activation, please contact one of the following service hotlines:

- **USA:** Response Center under 866-990-9007
- **Canada:** Customer Service under 1-888-923-8367

An emergency call is dialed automatically if an air bag or Emergency Tensioning Device is triggered.

**i** An automatically dialed mbrace emergency call cannot be canceled.

An emergency call can also be dialed manually.

Once the emergency call is in progress, the indicator lamp in the SOS button flashes. The Connecting Call message appears in the multifunction display.

COMAND is muted.

Once a connection has been established, the Call Connected message appears in the multifunction display.

All important information on the emergency is compiled, for example:

- current location of the vehicle (as determined by the GPS system)
- vehicle model
- vehicle color
- vehicle identification number

A voice connection between the Response Center and the occupants of the vehicle will be established automatically soon after the emergency call has been initiated. If the vehicle occupants are able to respond, the Response Center will attempt to obtain more detailed information on the emergency.

**i** If no vehicle occupant answers, an ambulance is immediately sent to the vehicle.

### Warning

If the indicator lamp in the SOS button is flashing continuously and there was no voice connection to the Response Center established, then the mbrace system could not initiate an emergency call (e.g. the relevant cellular phone network is not available).

The message Call Failed appears in the multifunction display for approximately 10 seconds.

Should this occur, assistance must be summoned by other means.

### Making an emergency call

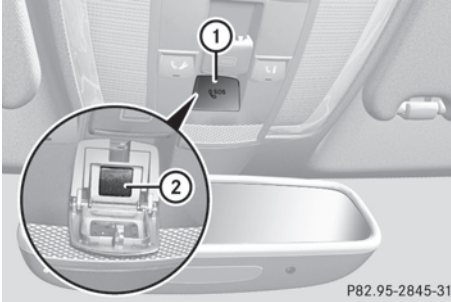

P82.95-2845-31

- ▶ **To initiate an emergency call manually:** press cover ① briefly to open.
- ▶ Press SOS button ② briefly. The indicator lamp in SOS button ② flashes until the emergency call is ended.
- ▶ Wait for the voice connection with the Response Center.
- ▶ After the emergency call is ended, close cover ①.

#### **Warning**

If you feel at any way in jeopardy when in the vehicle (e.g. smoke or fire in the vehicle, vehicle in a dangerous road location), please do not wait for voice contact after you have pressed the SOS button. Carefully leave the vehicle and move to a safe location. The Response Center will automatically contact local emergency officials with the vehicle's approximate location if they receive an automatic SOS signal and cannot make voice contact with the vehicle occupants.

### Roadside Assistance call button



P82.95-2840-31

- ▶ Press and hold Roadside Assistance button ① for more than two seconds. A call to a Mercedes-Benz Roadside Assistance Representative is initiated. The indicator lamp in Roadside Assistance button ① flashes while the call is active. The Connecting Call message appears in the multifunction display and the audio system or COMAND is muted.

If a connection can be established, the Call Connected message appears in the multifunction display.

If a mobile phone network is available and there is sufficient GPS reception, the mbrace system transmits data to the Response Center, for example:

- current location of the vehicle
- vehicle identification number
- vehicle model
- vehicle color

- ▶ **i** The COMAND display shows that an mbrace call is active. You can switch to the navigation menu by pressing the NAVI button on COMAND during the call. Spoken commands are not available.

A voice connection is established between the Mercedes-Benz Roadside Assistance Representative and the vehicle occupants.

- ▶ Describe the type of assistance needed.

The Mercedes-Benz Roadside Assistance Representative either sends a qualified Mercedes-Benz technician or organizes for

your vehicle to be transported to the nearest authorized Mercedes-Benz Center. You may be charged for services such as repair work and/or towing. Further details are available in your mbrace manual.

**i** If the indicator lamp in MB info call button ① flashes continuously and it was not possible to establish a voice connection to the Response Center, then the mbrace system has failed to initiate a Roadside Assistance call (e.g. the corresponding cellular phone network is not available). The **Call Failed** message appears in the multifunction display.

► **To end a call:** press the  button on the multifunction steering wheel.

or

► Press the corresponding button for ending a phone call on COMAND.

**i** Sign and Drive services<sup>29</sup>: you are not charged for services such as jump-starting, providing a few gallons of fuel for a fuel tank that has been run dry or changing a flat tire with the vehicle's own spare tire.

### MB Info call button



► Press and hold MB info call button ① for more than two seconds.

A call to the Response Center is initiated. MB info call button indicator lamp ① flashes while the connection is being

established. The **Connecting Call** message appears in the multifunction display and COMAND is muted.

If a connection can be established, the **Call Connected** message appears in the multifunction display.

If a mobile phone network is available and there is sufficient GPS reception, the mbrace system transmits data to the Response Center, for example:

- current location of the vehicle
- vehicle identification number
- vehicle model
- vehicle color

**i** The COMAND display shows that an mbrace call is active. You can switch to the navigation menu by pressing the NAVI button on COMAND during the call. Spoken commands are not available.

A voice connection between the Response Center and the vehicle occupants is established. You can obtain information on how to operate your vehicle's systems, on the location of the nearest authorized Mercedes-Benz Center, and on further products and services offered by Mercedes-Benz USA. Further details on the mbrace system can be found under <http://www.mbusa.com><sup>30</sup>. Log in under "Owners Online".

**i** If the indicator lamp in MB info call button ① flashes continuously and no voice connection to the Response Center has been established, then the mbrace system has failed to initiate an MB info call (e.g. the corresponding mobile phone network is not available). The **Call Failed** message appears in the multifunction display.

<sup>29</sup> USA only.

<sup>30</sup> USA only.

► **To end a call:** press the  button on the multifunction steering wheel.

or

► Press the corresponding button for ending a phone call on COMAND.

## Call priority

An emergency call can still be initiated even if a service call is currently active, e.g. a Roadside Assistance call or an MB info call. In this case, an emergency call will take priority and override all other active calls.

The indicator lamp of the respective button flashes until the call is ended. An emergency call can only be terminated by the Response Center. All other calls can be ended by pressing the  button on the multifunction steering wheel or the corresponding button for ending a telephone call on COMAND.

- ❗ When an mbrace call has been initiated, COMAND is muted. The mobile phone is no longer connected to COMAND. If you must use your mobile phone, we recommend that you do this only when the vehicle is stationary and in a safe location.

## Downloading destinations in COMAND

Destination Download gives you access to a database with over 10 million points of interest (POIs) which can be downloaded to the navigation system of your vehicle. If you know the destination, you can download the address or obtain the location of points of interest (POIs) or important destinations in the surrounding area.

You are prompted to confirm route guidance to the entered address.

The system calculates the route and subsequently starts the route guidance with the address entered.

- ❗ If you select No, the address can be stored in the address book.

- ❗ The Destination Download function is available if the corresponding cellular phone network is available and data transfer is possible.

## Search & Send

"Search & Send" is a destination entry service. You can find further information on "Search & Send" in the separate COMAND operating instructions.

## Vehicle remote opening

If you have unintentionally locked your vehicle (e.g. the SmartKey is inside the vehicle) and a replacement key is not available:

- Contact the following service hotlines:
  - **USA:** Response Center under the number 866-990-9007
  - **Canada:** Customer Service under 1-888-923-8367
 You will be asked for your password.
- Return to your vehicle at the time arranged with the Response Center.
- Pull the trunk handle/tailgate handle for at least 20 seconds until the indicator lamp in the SOS button (► page 296) flashes. The Connecting Call message appears in the multifunction display.

Alternatively, the vehicle can also be opened via the Internet in the "Owners Online" section using your ID number and password<sup>31</sup>.

- ❗ Vehicle remote unlocking is only possible if the corresponding cellular phone network is accessible.

The SOS button flashes and the Connecting Call message appears in the multifunction display to confirm that the

<sup>31</sup> USA only.

command for vehicle remote unlocking has been received.

If you pull the trunk handle for more than 20 seconds before receiving authorization for remote unlocking, you must wait 15 minutes before you can pull on the handle of the trunk lid again.

### Vehicle remote closing in an emergency

If you forget to lock your vehicle but are no longer in the vicinity of the vehicle, it can be locked for you by the Response Center.

The vehicle can be locked remotely up to four days after the ignition was last switched off.

► Contact the following service hotlines:

- **USA:** Response Center under 866-990-9007
- **Canada:** Customer Service under 1-888-923-8367

You will be asked for your PIN.

The next time you are in your vehicle and switch on the ignition, the Tele Aid Doors locked by remote control message appears in the multifunction display.

- ❗ The vehicle remote locking feature is available when the relevant mobile phone network is available and data connection is possible.

### Stolen Vehicle Recovery Services

If your vehicle has been stolen:

- Contact the police.  
The police will issue an incident report. This report has a number.
- This number will be forwarded to the Response Center together with your PIN. The Response Center will then attempt to covertly contact the mbrace system. The Response Center contacts you and the local law enforcement authority if the vehicle is located. However, only the law enforcement authority is informed of the location of the vehicle.

- ❗ If the anti-theft alarm system remains activated for longer than thirty seconds, mbrace is automatically connected to the Customer Assistance Center.

### Garage door opener

#### Important safety notes

Up to three different door and gate systems can be operated using the remote control integrated in the overhead control panel.

- ❗ Certain garage door openers are not compatible with the integrated remote control. If you experience difficulties with the programming of the integrated remote control, contact an authorized Mercedes-Benz Center or call the following telephone assistance service:
  - **USA:** Mercedes-Benz Customer Assistance Center on 1-800-FOR-MERCEdes
  - **Canada:** Customer Service on 1-800-387-0100

#### Warning

Before programming the integrated remote control to a garage door opener or gate operator, make sure people and objects are out of the way of the device to prevent potential harm or damage. When programming a garage door opener, the door moves up or down. When programming a gate operator, the gate opens or closes.

Do not use the integrated remote control with any garage door opener that lacks safety stop and reverse features as required by U.S. federal safety standards (this includes any garage door opener model manufactured before April 1, 1982). A garage door that cannot detect an object - signaling the door to stop and reverse - does not meet current U.S. federal safety standards.

When programming a garage door opener, park vehicle outside the garage.

Do not run the engine while programming the integrated remote control. Inhalation of exhaust gas is hazardous to your health. All exhaust gas contains carbon monoxide (CO), and inhaling it can cause unconsciousness and possible death. All exhaust gas contains carbon monoxide (CO), and inhaling it can cause unconsciousness and possible death.

**i** USA only:

This device complies with part 15 of the FCC rules. Operation is subject to the following two conditions:

1. The device must not cause harmful interference.
2. The device must withstand any interference received, including interference that may cause undesired operation.

Unauthorized modification of this device could void the device's operating permit.

**i** Canada only:

This device complies with the RSS-210 requirements of Industry Canada. Operation is subject to the following two conditions:

1. The device must not cause harmful interference.
2. The device must accept any interference received, including interference that may cause undesired operation.

Unauthorized modification of this device could void the user's authority to legally operate the device.

### Programming the remote control

#### Programming

**⚠ Warning!**

Only press the transmitter button on the integrated remote control if there are no persons or objects present within the sweep of the garage door. People could otherwise be injured by the movement of the door.

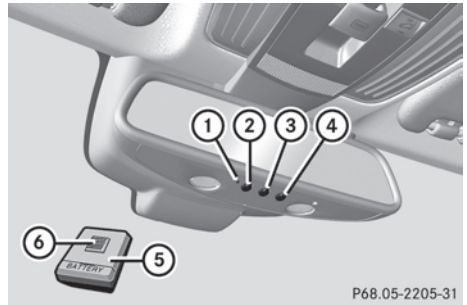

Remote control in the rear-view mirror

Garage door remote control ⑤ is not part of the garage door opener.

**i** To achieve the best result, insert new batteries in garage door remote control ⑤ of your garage door drive before programming.

▶ Erase the memory of the integrated remote control (▶ page 303) before programming it for the first time.

▶ Turn the SmartKey to position 2 in the ignition lock.

▶ Press and hold one of transmitter buttons ② to ④ on the integrated remote control. After a short time, indicator lamp ① will start flashing. It flashes about once per second.

**i** Indicator lamp ① flashes immediately the first time that the transmitter button is programmed. If this transmitter button has already been programmed, indicator lamp ① will only start flashing at a rate of once per second after 20 seconds have elapsed.

▶ Keep the transmitter button depressed.

▶ Point transmitter button ⑥ of garage door remote control ⑤ towards the transmitter buttons on the rear-view mirror from a distance of 2 to 12 inches (5 to 20 cm).

**i** The distance between garage door remote control ⑤ and the integrated garage door opener depends on the system of the garage door drive. You might require



several attempts. You should test every position for at least 20 seconds before trying another position.

- ▶ Keep transmitter button ⑥ on garage door remote control ⑤ pressed until indicator lamp ① starts to flash rapidly. The programming has been successful if indicator lamp ① flashes rapidly.
- ▶ Release transmitter buttons ②, ③ or ④ on the integrated remote control or transmitter button on the garage door remote control ⑥.

If indicator lamp ① goes out after approximately 20 seconds and has not flashed rapidly:

- ▶ Release transmitter buttons ②, ③ or ④ on the integrated remote control or transmitter button on the garage door remote control ⑥.
- ▶ Repeat the procedure for the other transmitter buttons. When doing so, vary the distance between the garage door's remote control and the transmitter buttons in the rear-view mirror.

- ❗ If the garage door system works with a rolling code, you must synchronize the remote control integrated into the rear-view mirror with the garage door system receiver after programming.

You will find further information in the garage door opening system's operating instructions, e.g. the sections on "Synchronizing the transmitter" or "Registering a new transmitter". You can also call the hotline mentioned above.

### Notes on programming the remote control

Canadian radio frequency laws require transmitter signals to "time-out" (or quit) after several seconds of transmission. This may not be long enough for the integrated signal transmitter to pick up the signal during programming. Similar to this Canadian law,

some U.S. gate operators are designed to "time-out" in the same manner.

If you live in Canada or have difficulties programming the garage door opener (regardless of where you live) when using the programming steps (see above), proceed as follows:

- ▶ Press transmitter button (②, ③ or ④) and hold it down during the following steps until the setup has been completed successfully.
- ▶ At the same time, press transmitter button ⑥ of the garage door remote control for two seconds, then release it for two seconds, then press it again for two seconds.
- ▶ Repeat this sequence on transmitter button ⑥ of the garage door remote control until the frequency signal has been learned.
- ▶ If the setup procedure is successful, indicator lamp ① flashes once slowly and goes out after a few seconds.
- ▶ Continue with the other programming steps (see above).

### Problems when programming

If you have problems when programming the integrated remote control, please note the following:

- check the transmitter frequency of garage door remote control ⑤ (which can usually be found on the rear of the remote control). The integrated remote control is compatible with equipment that operates in the frequency range 280 to 390 MHz.
- replace the batteries in garage door remote control ⑤. This increases the likelihood of garage door remote control ⑤ sending a strong and precise signal to the integrated remote control on the rear-view mirror.
- When aiming the garage door remote control at the transmitter buttons on the rear-view mirror, hold garage door remote control ⑤ at differing distances and angles



from the transmitter button that you are programming. Try different angles from a distance of 2 to 12 inches (5 to 30 cm) or the same angle from differing distances.

- If there is another garage door remote control for the same device, perform the programming steps again using the remote control. Before performing these steps, make sure that new batteries have been installed in the garage door remote control.
- Align the antenna cable of the garage door opener unit. This can improve signal reception/transmission.

### Opening or closing the garage door

Once programmed, the integrated remote control will assume the function of the garage door system's remote control. Please also read the operating instructions for the garage door system.

- ▶ Turn the SmartKey to position **2** in the ignition lock.
- ▶ Press transmitter button ②, ③ or ④ in the overhead control panel that you have programmed to operate the garage door. Garage door system with fixed code: indicator lamp ① lights up continuously. Garage door system with rolling code: indicator lamp ① flashes briefly and then lights up for approximately two seconds. This is repeated for up to 20 seconds.

- ❗ The transmitter will transmit a signal for as long as the transmitter button is being pressed. The transmission will be halted after a maximum of 20 seconds and indicator lamp ① will flash. Press the transmitter button again, if necessary.

### Clearing the remote control memory

- ▶ Turn the SmartKey to position **2** in the ignition lock.
  - ▶ Press and hold transmitter buttons ② and ④ for approximately 20 seconds until indicator lamp ① flashes rapidly. The memory is cleared.
- ❗ You should clear the remote control memory before selling the vehicle.

### Compass

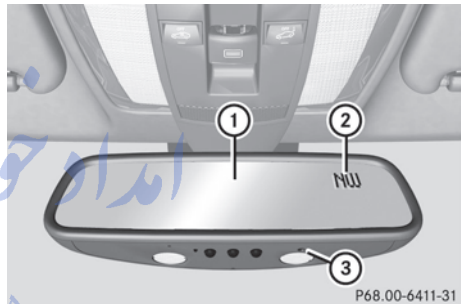

To obtain correct direction display in rearview mirror ①, the compass must be calibrated and the magnetic field zone set.

- ▶ **To call up the compass:** briefly press button ③.

The compass indicates the direction in which the vehicle is currently driving: N, NE, E, SE, S, SW, W or NW.

- ▶ **To calibrate the compass:** determine your position using the following the zone maps.

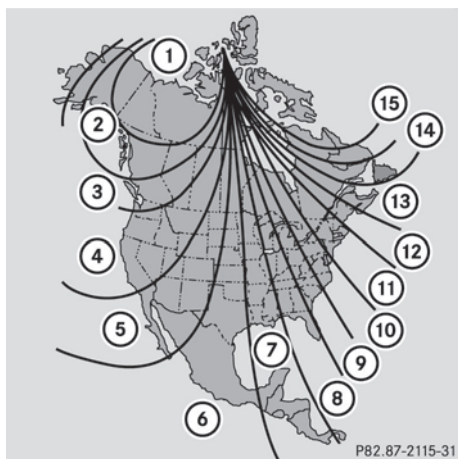

Zone map for North America

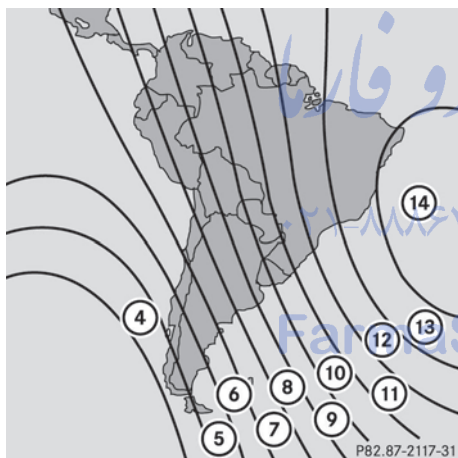

Zone map for South America

- ▶ Press and hold button ③ for approximately three seconds.

The currently selected zone appears in compass display ②.

- ▶ **To select the zone:** press button ③ repeatedly until the desired zone is selected.

The zone has been selected when compass display ② shows the point of the compass. This takes a few seconds.

- ▶ **To calibrate the compass:** make sure that there is sufficient space for you to drive in

a circle without impeding the remaining traffic.

In order to calibrate the compass correctly, observe the following points:

- calibrate the compass in the open and not in the vicinity of steel structures or high-voltage power lines
  - switch off electrical consumers such as climate control, the windscreen wipers or the rear window heating
  - close all doors and the trunk lid/tailgate
  - ▶ Switch on the ignition.
  - ▶ Press and hold button ③ for approximately six seconds until the C symbol appears in compass display ②.
  - ▶ Drive a full circle at approximately 3 mph (5 km/h) to 6 mph (10 km/h).
- Once the calibration has been successfully completed, the current heading appears in compass display ②.

### Floormat on the driver's side

#### ⚠ Warning!

Whenever you are using a floormat, make sure there is enough clearance and that the floormat is securely fastened.

The floormat should always be securely fastened using the fastening equipment.

Before driving off, check that the floormat is securely in place and adjust it if necessary. A loose floormat could slip and hinder proper functioning of the pedals.

Do not place several floormats on top of each other as this may impair pedal movement.

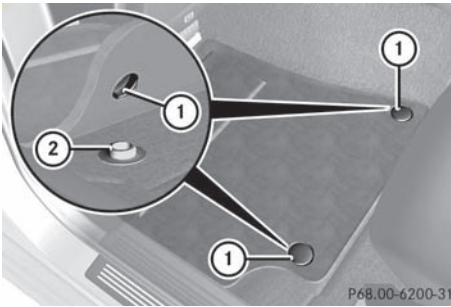

- ▶ Slide seat backwards.
- ▶ **To install:** place the floor mat in position.
- ▶ Press floor mat eyelets ① onto retainer pins ②.
- ▶ **To remove:** pull the floor mats off retainers ②.
- ▶ Remove the floor mat.

امداد خودرو فارما

تلفن شبانه روزی: ۰۲۱-۸۸۸۶۲۰۸۵

FarmaSOS.com

# امداد خودرو فارما

تلفن شبانه روزی: ۰۲۱-۸۸۸۶۲۰۸۵

**FarmaSOS.com**

Vehicle equipment .....	308
Engine compartment .....	308
Service .....	313
Care .....	313

# امداد خودرو فارما

تلفن شبانه روزی: ۰۲۱-۸۸۸۶۲۰۸۵

[FarmaSOS.com](http://FarmaSOS.com)

## Vehicle equipment

- i** This manual describes all the standard and optional equipment of your vehicle which was available at the time of purchase. Country-specific differences are possible. Bear in mind that your vehicle may not feature all functions described here. This also refers to safety-related systems and functions.

## Engine compartment

### Hood

#### Opening the hood

##### **Warning**

Do not pull the release lever while the vehicle is in motion. Otherwise, the hood could be forced open by passing air flow.

This could cause the hood to come loose and injure you and/or others.

##### **Warning**

Do not open the hood when the engine is overheated. You could be seriously injured. Observe the coolant temperature gauge to determine whether the engine may be overheated. If you see flames or smoke coming from the engine compartment, move away from the vehicle. Wait until the engine has cooled. If necessary, call the fire department.

##### **Warning**

There is a risk of injury if the hood is open, even if the engine is not running. Some engine components can become very hot.

To avoid the risk of burns, only touch those components described in the Operator's Manual and observe the relevant safety notes.

##### **Warning**

To help prevent personal injury, stay clear of moving parts when the hood is open and the engine is running.

The radiator fan may continue to run for approximately 30 seconds or may even restart after the engine has been turned off. Stay clear of fan blades.

##### **Warning!**

Vehicles with gasoline engine: The engine is equipped with a transistorized ignition system. Because of the high voltage it is dangerous to touch any components (ignition coils, spark plug sockets, diagnostic socket) of the ignition system

- with the engine running
- while starting the engine
- when the ignition is switched on and the engine is turned manually

##### **Warning!**

Vehicles with diesel engine: The engine is equipped with a high-voltage electronic control unit for the injection system. Because of the high voltage it is dangerous to touch any components of the injection system (injectors, electrical wires)

- with the engine running
- while starting the engine
- when the ignition is switched on

- ▶ Make sure that the windshield wipers are switched off.

##### **Warning**

The windshield wipers and wiper linkage could be set in motion.

When the hood is open, you or others could be injured by the wiper linkage.

Make sure that the windshield wipers are switched off. Remove the SmartKey or make sure that no ignition position has been selected with KEYLESS-GO. All indicator lamps must be off in the instrument cluster.

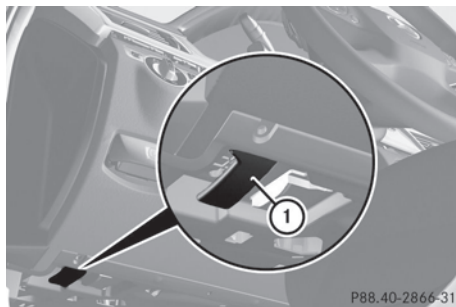

- ▶ Pull release lever ① on the hood. The hood is released.

**!** Make sure that the windshield wipers are not folded away from the windshield. You could otherwise damage the windshield wipers or the hood.

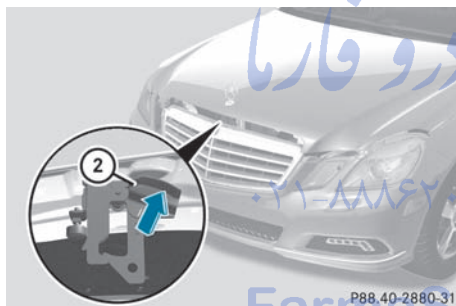

- ▶ Reach into the gap, pull hood catch handle ② up and lift the hood.

### Closing the hood

#### **Warning**

When closing the hood, use extreme caution not to catch hands or fingers. Be careful that you do not close the hood on anyone.

Make sure the hood is securely engaged before driving off. Do not continue driving if the hood can no longer engage after an accident, for example. The hood could otherwise come loose while the vehicle is in motion and injure you and/or others.

- ▶ Lower the hood and let it fall from a height of approximately 8 inches (20 cm).
- ▶ Check that the hood has engaged properly. If the hood can be raised slightly, it is not properly engaged. Open it again and close it with a little more force.

### Radiator

- i** **Vehicles with a diesel engine:** do not cover the radiator, for example with a winter front or bug cover. Otherwise, the readings of the on-board-diagnostic system may be inaccurate. Some of these readings are required by law and must be accurate at all times.

### Engine oil

#### Notes on the oil level

Depending on the driving style, the vehicle consumes up to 0.9 US qt (0.8 l) of oil over a distance of 600 miles (1000 km). The oil consumption may be higher than this when the vehicle is new or if you frequently drive at high engine speeds.

When checking the oil level:

- park the vehicle on a level surface.
- the engine should be switched off for at least five minutes if the engine is at normal operating temperature.
- the engine should be switched off for at least 30 minutes if it is not at normal operating temperature (i.e. if you only start the engine briefly).

#### Checking the oil level using the oil dipstick

Depending on the engine, the oil dipstick may be installed in a different location.

فارس فارما  
 ۰۲۱-۸۸۶۲۰۸۰  
 فارس فارما



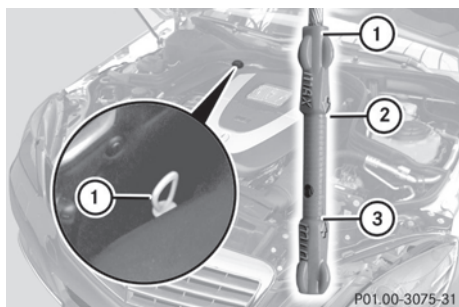

Example: vehicles with a gasoline engine

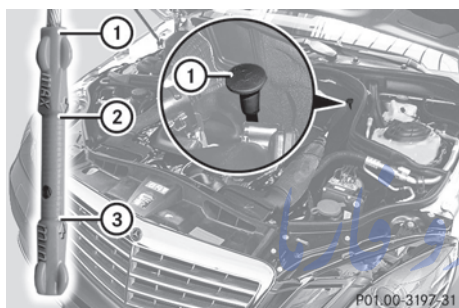

Example: vehicles with a diesel engine

- ▶ Pull oil dipstick ① out of the dipstick guide tube.
- ▶ Wipe off oil dipstick ①.
- ▶ Slowly insert oil dipstick ① into the dipstick guide tube to the stop, and take it out again.  
The oil level is correct if the level is between MIN mark ③ and MAX mark ②.
- ▶ Add oil if necessary.

## Adding engine oil

### Environmental note

When adding oil, take care not to spill any. If oil enters the soil or waterways, it is harmful to the environment.

- ❗ Only use engine oils and oil filters which have been approved for vehicles with a service system. A list of the engine oils and oil filters that have been tested and approved according to the Mercedes-Benz specifications for service products can be

found on the Internet at <http://www.mbusa.com> (USA only). Further information on tested and approved engine oils and oil filters can be obtained from any authorized Mercedes-Benz Center.

The following causes engine failure or damage to the exhaust system:

- using engine oils and oil filters that are not specifically approved for the service system
- replacing the engine oil and oil filter later than the specified replacement interval required by the service system
- using engine oil additives

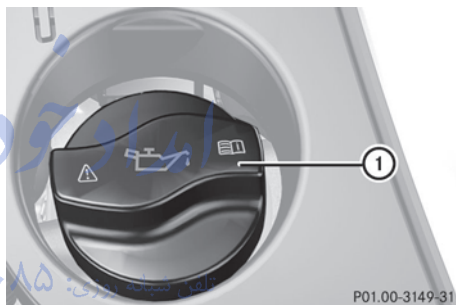

Example: engine oil cap

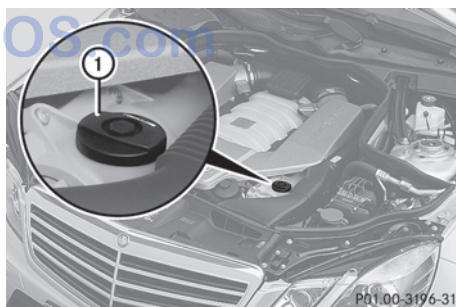

Engine oil cap (AMG vehicles)

- ▶ Turn cap ① counter-clockwise and remove it.
- ▶ Add the amount of oil required.

Fill carefully to the maximum mark on the oil dipstick.

- ❗ The difference in quantity between the MIN mark and the MAX mark on the

dipstick is (depending on the engine) approximately 1.6 to 2.1 US qt. (1.5 to 2 l).

**!** Do not add too much oil. If the oil level is above the MAX mark on the dipstick, too much oil has been added. This can lead to damage to the engine or the catalytic converter. Have excess oil siphoned off.

Further information on engine oil  
(▷ page 391).

- ▶ Replace cap ① on the filler neck and tighten clockwise. Ensure that the cap locks into place securely.

### Checking and adding other service products

#### Checking the coolant level

Only check the coolant level when the vehicle is on a level surface and the engine has cooled down.

- ▶ Turn the SmartKey to position 2 (▷ page 149) in the ignition lock. On vehicles with KEYLESS-GO, press the Start/Stop button twice (▷ page 150).
- ▶ Check the coolant temperature display in the instrument cluster. The coolant temperature must be below 158 °F (70 °C).

#### **⚠ Warning**

In order to avoid any potentially serious burns:

- use extreme caution when opening the hood if there are any signs of steam or coolant leaking from the cooling system, or if the coolant temperature display indicates that the coolant is overheated.
- do not remove the pressure cap on the coolant reservoir if the coolant temperature is above 158 °F (70 °C). Allow the engine to cool down before removing the cap. The coolant reservoir contains hot fluid and is under pressure.

- using a rag, slowly turn the cap approximately 1/2 turn to relieve excess pressure. If opened immediately, scalding hot fluid and steam will be blown out under pressure.
- do not spill antifreeze on hot engine parts. Antifreeze contains ethylene glycol which may burn if it comes into contact with hot engine parts.

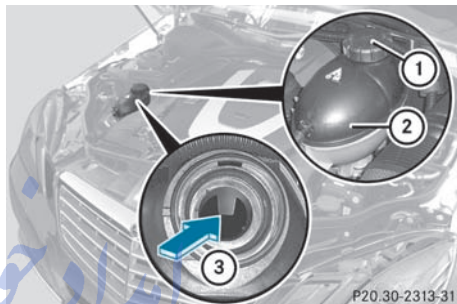

- ▶ Slowly turn cap ① half a turn counter-clockwise and allow excess pressure to escape.
- ▶ Turn cap ① further counter-clockwise and remove it. If the coolant is at the level of marker bar ③ in the filler neck when cold, there is enough coolant in coolant expansion tank ②. If the coolant is approximately 0.6 in (1.5 cm) higher when warm, there is enough coolant in coolant expansion tank ②.
- ▶ If necessary, add coolant which has been tested and approved by Mercedes-Benz.
- ▶ Replace cap ① and turn it clockwise as far as it will go.

For further information on coolant, see (▷ page 392).

## Windshield washer system/headlamp cleaning system

The washer fluid reservoir is used for both the windshield washer system and the headlamp cleaning system.

### Warning

Washer solvent/antifreeze is highly flammable. Do not spill washer solvent/antifreeze on hot engine parts, because it may ignite and burn. You could be seriously burned.

**!** At temperatures below freezing, always fill the washer fluid container with a mix of windshield washer concentrate and antifreeze additive. There is otherwise a risk of damaging the windshield washer system/headlamp cleaning system.

**!** Only use washer fluid concentrate which is suitable for plastic lenses. Unsuitable washer fluid concentrate could damage the plastic lenses of the headlamps.

**!** Do not add distilled or de-ionized water to the washer fluid container. Otherwise, the fluid level measuring gauge could be damaged.

**i** Add windshield washer concentrate, e.g. MB SummerFit, to the washer fluid all year round.

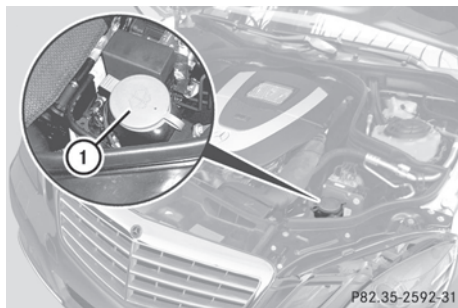

Example: washer fluid reservoir

- ▶ Mix the windshield washer fluid in a container beforehand.
- ▶ **At temperatures above freezing:** fill the washer fluid reservoir with a mix of water and windshield washer concentrate (e.g. MB SummerFit).
- ▶ **At temperatures below freezing:** fill the washer fluid reservoir with a mix of water and MB SummerFit windshield washer concentrate. For information on the mixing ratio, see (▶ page 393) or use the premixed windshield washer solution with antifreeze available in specialist stores.
- ▶ **To open:** pull cap ① upwards by the tab.
- ▶ Add the premixed washer fluid.
- ▶ **To close:** press cap ① onto the filler neck until it engages.

## Brake fluid level

**!** If you discover that the brake fluid level in the brake fluid reservoir has fallen to the MIN mark or below, check the brake system for leaks immediately. Also check the brake lining thickness. Contact a qualified specialist workshop, e.g. an authorized Mercedes-Benz Center immediately.

Do not top up the brake fluid. This will not rectify the malfunction.

Only check the brake fluid level when the vehicle is stationary and on a level surface.

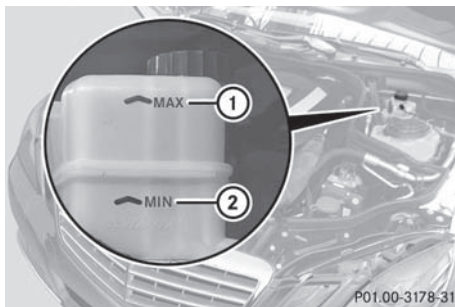

The brake fluid level is correct if it is between MIN marking ② and MAX marking ① on the brake fluid reservoir.

## Service

### Service interval display

#### Service messages

Information about the type of service and service intervals (see separate Service Booklet)

You can obtain more information at an authorized Mercedes-Benz Center or at **www.mbusa.com** (USA only).

The service interval display informs you of the next service due date.

If a service is overdue, you will also hear a warning tone.

The multifunction display shows a service message for a few seconds, e.g.

Next Service A in .. mls

Service A due

Service A Exceeded By .. mls

The letter indicates which service is due. A stands for a minor service and B for a major service. A number or another letter may be displayed after the letter. This figure indicates any necessary additional maintenance work to be performed.

You can obtain further information at an authorized Mercedes-Benz Center.

The service interval display does not take into account any periods of time during which the battery is disconnected.

Maintaining the time-dependent service schedule:

- ▶ Before disconnecting the battery, call up the service due date in the multifunction display and note it down.





or

- ▶ Subtract the battery disconnection periods from the service date shown on the display after reconnecting the battery.

#### Hiding the service message

- ▶ Press  or  on the steering wheel.

#### Displaying the service message

- ▶ Switch on the ignition.
- ▶ Press  or  to select the Service menu on the steering wheel.
- ▶ Press  or  to select the ASSYST PLUS submenu and press  to confirm. The service due date appears in the multifunction display.

#### Points to remember

A qualified specialist workshop, e.g. an authorized Mercedes-Benz Center, will reset the service interval display after the necessary service work has been carried out.

You can obtain more information, e.g. on maintenance work, at an authorized Mercedes-Benz Center or directly at Mercedes-Benz.

**!** If the service interval indicator has been inadvertently reset, this setting can be corrected at an authorized Mercedes-Benz Center.

Have the service work carried out as described in the Service Booklet. There may otherwise be increased wear, resulting in damage to the vehicle or to the major assemblies.

## Care

### Notes on care

Regular care of your vehicle is a condition for retaining the quality in the long term.

Use care products and cleaning agents recommended and approved by Mercedes-Benz.

#### Warning

Many cleaning products can be hazardous. Some are poisonous, others are flammable.

Always follow the instructions on the particular container. Always open your vehicle's doors or windows when cleaning the inside.

Never use fluids or solvents that are not designed for cleaning your vehicle.

Always lock away cleaning products and keep them out of reach of children.

**!** For cleaning your vehicle, do not use any of the following:

- dry, rough or hard cloths
- abrasive cleaning agents
- solvents
- cleaning agents containing solvents

Do not scrub.

Do not touch the surfaces or protective films with hard objects, e.g. a ring or ice scraper. You could otherwise scratch or damage the surfaces and protective film.

#### Environmental note

Dispose of empty packaging and cleaning cloths in an environmentally responsible manner.

**!** Do not park the vehicle for an extended period right after cleaning it, particularly after having cleaned the wheels with wheel cleaner. Wheel cleaners could cause increased corrosion of the brake discs and brake pads/linings. For this reason, you should drive for a few minutes after cleaning. Braking heats the brake discs and brake pads, thus drying them. The vehicle can then be parked up.

### Exterior care

#### Automatic car wash

##### Warning!

Braking efficiency is reduced after washing the vehicle. This could cause an accident. For this reason, you must drive particularly

carefully after washing the vehicle until the brakes have dried.

##### Risk of accident

The vehicle is braked when the HOLD function or DISTRONIC PLUS is activated. Therefore, deactivate the HOLD function and DISTRONIC PLUS before the vehicle is washed in an automatic car wash.

You can wash the vehicle in an automatic car wash from the very start.

**!** Never clean your vehicle in a Touchless Automatic Car Wash as these use special cleaning agents. These cleaning agents can damage the paintwork or plastic parts.

If the vehicle is very dirty, pre-wash it before cleaning it in an automatic car wash.

**!** In car washes with a towing mechanism, make sure that the automatic transmission is in transmission position **N**, otherwise the vehicle could be damaged.

- Vehicles with a SmartKey:

Do not remove the SmartKey from the ignition lock. Do not open the driver's door or front-passenger door when the engine is switched off. Otherwise, the automatic transmission selects park position **P** automatically and locks the wheels. You can prevent this by shifting the automatic transmission to **N** beforehand.

- Vehicles with KEYLESS-GO:

Do not open the driver's door or front-passenger door when the engine is switched off. Otherwise, the automatic transmission selects park position **P** automatically and locks the wheels.

Observe the following to make sure that the automatic transmission stays in position **N**:

- ▶ Make sure the vehicle is stationary and the ignition is switched off.
- ▶ Turn the SmartKey to position **2** (▷ page 149) in the ignition lock. Use the SmartKey instead of the Start/ Stop button on vehicles with KEYLESS-GO.
- ▶ Depress and hold the brake pedal.
- ▶ Shift the automatic transmission to position **N**.
- ▶ Release the brake pedal.
- ▶ Release the parking brake.
- ▶ Switch off the ignition and leave the SmartKey in the ignition lock.

**!** Make sure that the side windows are completely closed, that the ventilation/heating is switched off and that the windshield wiper switch is set to **0**. Otherwise, the rain/light sensor could be activated, triggering unintended wiper movements. This can cause damage to the vehicle.

After using an automatic car wash, wipe off wax from the windshield and the wiper blades. This will prevent smears and reduce wiping noises caused by residue on the windshield.

### Washing by hand

Carefully remove all deposits of road salt as soon as possible when driving in winter.

Also, clean the insides of the wheels when washing the underbody of the vehicle.

- ▶ Do not use hot water and do not wash the vehicle in direct sunlight.
- ▶ Use a soft car sponge for cleaning.
- ▶ Use a gentle cleaning agent, e.g. a Mercedes-Benz approved car shampoo.
- ▶ Wash down the vehicle with a gentle water jet.
- ▶ Do not point the water jet directly at the air inlets.
- ▶ Use plenty of water and rinse the sponge frequently.

- ▶ Rinse the vehicle with clean water and dry it thoroughly with a chamois.
- ▶ Do not allow the cleaning agent to dry on the paintwork.

### Power washers

#### Warning!

Do not use power washers with circular-jet nozzles (dirt grinders) to clean your vehicle, in particular the tires. You could otherwise damage the tires and cause an accident.

- !** Keep the distance between the vehicle and the nozzle of the power washer at 11.8 in (30 cm). Information about the correct distance is available from the equipment manufacturer.

Move the power washer nozzle around when cleaning your vehicle.

Do not aim directly at any of the following:

- tires
- door joint
- electrical components
- battery
- connectors
- lights
- seals
- trim elements
- ventilation slots

Damaged seals or electrical components can lead to leaks or failures.

### Cleaning the wheels

- !** Do not use acidic wheel cleaning products to remove brake dust. This could damage wheel bolts and brake components.

- !** Do not park the vehicle for an extended period right after cleaning it, particularly after having cleaned the wheels with wheel cleaner. Wheel cleaners could cause increased corrosion of the brake discs and brake pads/linings. For this reason, you should drive for a few minutes after



cleaning. Braking heats the brake discs and brake pads, thus drying them. The vehicle can then be parked up.

### Cleaning the paintwork

Scratches, corrosive deposits, areas affected by corrosion and damage caused by inadequate care cannot always be completely repaired. In such cases, visit a qualified specialist workshop immediately, e.g. an authorized Mercedes-Benz Center.

- ▶ Remove impurities immediately, where possible, whilst avoiding rubbing too hard.
- ▶ Soak insect remains with insect remover and rinse off the treated areas afterwards.
- ▶ Soak bird droppings with water and rinse off the treated areas afterwards.
- ▶ Remove coolant, brake fluid, tree resin, oils, fuels and greases by rubbing gently with a cloth soaked in petroleum ether or lighter fluid.
- ▶ Use tar remover to remove tar stains.
- ▶ Use silicone remover to remove wax.

**!** Do not affix:

- stickers
- films
- magnetic plates or similar items

to painted surfaces. You could otherwise damage the paintwork.

If water no longer forms "beads" on the painted surface, paint care products should be used that have been approved and recommended by Mercedes-Benz. This is the case approximately every three to five months, depending on climatic conditions and the care product used.

If dirt has entered the paint surface or the paintwork has become dull, a paint cleaner should be used that has been approved and recommended by Mercedes-Benz.

Never use such care products in direct sunlight or on a hot hood.

- ▶ Use a suitable touch-up stick, e.g. MB Touch Up stick, for quick, temporary repair of damaged paintwork.

### Matte finish care

If your vehicle has a clear matte finish, observe the following instructions in order to avoid damage to the paintwork due to incorrect care.

**!** Never polish the vehicle. Polishing causes the finish to shine.

**!** Do not use paintwork cleaner, grinding or polishing products or gloss preservers such as wax. These products are only suitable for high-gloss surfaces. Using them on vehicles with matte paintwork can cause severe damage to the surface (shiny, mottled patches).

Always have paintwork repairs performed at a qualified specialist workshop, e.g. an authorized Mercedes-Benz Center.

**!** Do not use wash programs with a hot wax treatment under any circumstances.

**i** Use only insect remover and car shampoo from the range of recommended and approved Mercedes-Benz care products.

### Cleaning the windows

#### Warning

Switch off the windshield wipers and remove the SmartKey from the ignition lock before cleaning the windshield or the wiper blades. On vehicles with KEYLESS-GO, press the Start/Stop button repeatedly until all indicator lamps in the instrument cluster have gone off. The windshield wipers could otherwise move and injure you.

- ▶ Clean the inside and outside of the windows with a damp cloth and a cleaning agent that is recommended and approved by Mercedes-Benz.



- ❗ Do not use dry cloths, abrasive products, solvents or cleaning agents containing solvents to clean the inside of the windows. Do not use hard objects to clean the insides of the windows, e.g. an ice scraper or ring. There is otherwise a risk of damaging the windows.
- ❗ Clean the water drainage channels of the windshield and the rear window at regular intervals. Deposits such as leaves, petals and pollen may under certain circumstances prevent water from draining away. This can lead to corrosion damage and damage to electronic components.

### Cleaning the wiper blades

#### ⚠ Warning

Switch off the windshield wipers and remove the SmartKey from the ignition lock before cleaning the windshield or the wiper blades. On vehicles with KEYLESS-GO, press the Start/Stop button repeatedly until all indicator lamps in the instrument cluster have gone off. The windshield wipers could otherwise move and injure you.

- ❗ Do not pull the wiper blade. Otherwise, the wiper blade could be damaged.
- ❗ Do not clean wiper blades too often and do not rub them too hard. Otherwise, the graphite coating could be damaged. This could cause wiper noise.
- ▶ Fold the wiper arms away from the windshield.
- ▶ Carefully clean the wiper blades with a damp cloth.
- ▶ Fold the windshield wipers back again before switching on the ignition.
- ❗ Hold the wiper arm securely when folding back. The windshield could be damaged if the wiper arm smacks against it suddenly.

### Cleaning the headlamps

- ▶ Clean the plastic lamp lenses on the headlamps using a wet sponge and a mild cleaning agent, e.g. Mercedes-Benz car shampoo or cleaning cloths.
- ❗ Only use cleaning agents or cleaning cloths which are suitable for plastic headlamp lenses. Unsuitable cleaning agents or cleaning cloths could scratch or damage the plastic headlamp lenses.

### Cleaning the sensors

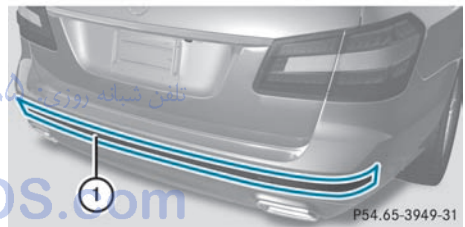

- ▶ Clean sensors ① of the driving systems with water, car shampoo and a soft cloth.
- ❗ When cleaning the sensors with a power washer, maintain a distance between the vehicle and the nozzle of the power washer of at least 11.8 in (30 cm). Information about the correct distance is available from the equipment manufacturer.

## Cleaning the rear view camera

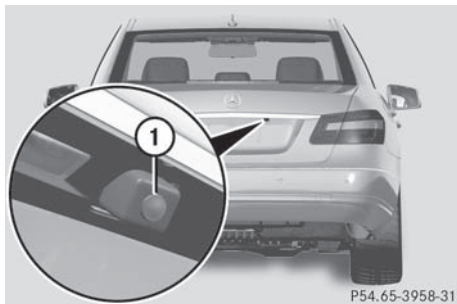

P54.65-3958-31

Sedan (example)

- ▶ Use clear water and a soft cloth to clean camera lens ①.

**!** Do not clean the camera lens and the area around the rear view camera with a power washer.

## Cleaning the exhaust tail pipes

Impurities combined with the effects of road grit and corrosive environmental factors may cause flash rust to form on the surface. You can restore the original shine of the exhaust tail pipe by cleaning it regularly, especially in winter and after washing.

**!** Do not clean the exhaust tail pipes with alkaline-based cleaning agents, such as wheel cleaner.

- ▶ Clean the exhaust tail pipes with a chrome care product tested and approved by Mercedes-Benz.

## Interior care

### Cleaning the display

- ▶ Before cleaning the display, make sure that it is switched off and has cooled down.
- ▶ Clean the display surface using a commercially-available microfiber cloth and TFT/LCD display cleaner.
- ▶ Dry the display surface using a dry microfiber cloth.

**!** For cleaning, do not use any of the following:

- alcohol-based thinner or gasoline
- abrasive cleaning agents
- commercially-available household cleaning agents

These may damage the display surface. Do not put pressure on the display surface when cleaning. This could lead to irreparable damage to the display.

## Cleaning Night View Assist Plus

**!** Never clean the camera lens. When cleaning the field of vision of the driving systems, make sure that you do not spray glass cleaner on the camera lens. If the camera lens is dirty, visit a qualified specialist workshop, e.g. an authorized Mercedes-Benz Center.

### **⚠ Warning!**

Please do not forget that your primary responsibility is to drive the vehicle. A driver's attention to the road must always be his/her primary focus when driving. For your safety and the safety of others, stop before trying to remove window fogging or cleaning the window in front of the Night View Assist Plus camera.

Bear in mind that at a speed of just 30 mph (approximately 50 km/h), your vehicle is covering a distance of 44 feet (approximately 14 m) every second.

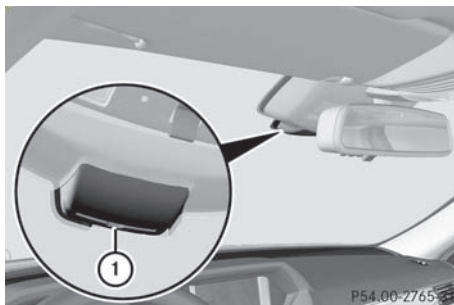

P54.00-2765

- ▶ Fold down the camera cover by recess ①.

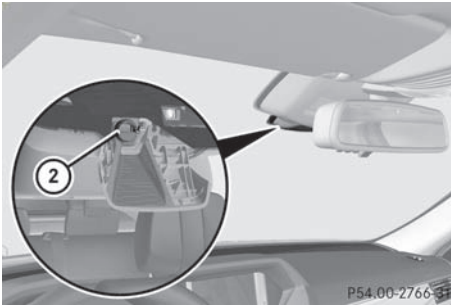

- ▶ Use a soft cloth to clean the windshield in front of camera ②.

### Cleaning the plastic trim

#### **Warning!**

When cleaning the steering wheel boss and dashboard, do not use cockpit sprays or cleaning agents containing solvents. Cleaning agents containing solvents cause the surface to become porous, and as a result, plastic parts may break away and be thrown around the interior when an air bag is deployed, which may result in severe injuries.

- ❗ Do not affix the following to plastic surfaces:
  - stickers
  - films
  - scented oil bottles or similar items
 You can otherwise damage the plastic.
- ❗ Do not allow cosmetics, insect repellent or sunscreen to come into contact with the plastic trim. This maintains the high-quality look of the surfaces.
- ▶ Wipe the plastic trim with a damp, lint-free cloth, e.g. a microfiber cloth.
- ▶ **Heavy soiling:** use car care and cleaning products recommended and approved by Mercedes-Benz.  
The surface may change color temporarily. Wait until the surface is dry again.

### Cleaning the steering wheel and gear or selector lever

- ▶ Wash thoroughly with a damp cloth or use a leather care agent that has been recommended and approved by Mercedes-Benz.

### Cleaning real wood and trim strips

- ▶ Wipe the wooden trim and trim strips with a damp, lint-free cloth, e.g. a microfiber cloth.
- ▶ **Heavy soiling:** use car care and cleaning products recommended and approved by Mercedes-Benz.
- ❗ Do not use solvent-based cleaning agents such as tar remover, wheel cleaners, polishes or waxes. There is otherwise a risk of damaging the surface.
- ❗ Do not use chrome polish for trim strips. The trim strips have a chrome look but are mostly made of anodized aluminum and can lose their shine if chrome polish is used. Use a damp, lint-free cloth instead when cleaning the trim strips.  
Chrome polish can be used to remove very heavy soiling from trim strips which you are sure are made of chrome. If you are unsure as to whether a trim strip is chrome-plated or not, consult an authorized Mercedes-Benz Center.

### Cleaning the seat covers

- ❗ Do not use microfiber cloths to clean genuine leather, artificial leather or Alcantara® covers. If used often, these can damage the cover.
- ❗ Observe the following when cleaning:
  - clean genuine leather covers carefully with a damp cloth and then wipe the covers down with a dry cloth. Make sure that the leather does not become soaked. It may otherwise become rough and cracked. Only use leather care

agents that have been tested and approved by Mercedes-Benz. You can obtain these from a qualified specialist workshop, e.g. an authorized Mercedes-Benz Center.

- clean artificial leather covers with a cloth moistened with a solution containing 1% detergent (e.g. dish washing liquid).
- clean cloth covers with a microfiber cloth moistened with a solution containing 1% detergent (e.g. dish washing liquid). Rub carefully and always wipe entire seat sections to avoid leaving visible lines. Leave the seat to dry afterwards. Cleaning results depend on the type of dirt and how long it has been there.
- clean Alcantara® covers with a damp cloth. Make sure you wipe entire seat sections to avoid leaving visible lines.

**i** Note that regular care is essential to ensure that the appearance and comfort of the covers is retained over time.

### Cleaning the seat belts • ۲۱-۸۸۸۶۲۰۸۵: تلفن شبانه روزی

► Use clean, luke-warm water and soap solution.

**!** Do not clean the seat belts using chemical cleaning agents. Do not dry the seat belts by warming them above 176 °F (80 °C) or placing them in direct sunlight.

#### **Warning**

Do not bleach or dye seat belts as this may severely weaken them. In a crash, they may not be able to provide adequate protection.

### Cleaning the roof lining and carpets

► **Roof lining:** use soft brushes or dry shampoo if it is particularly dirty.

► **Carpets:** use carpet and textile cleaners that have been approved and recommended by Mercedes-Benz.

Vehicle equipment .....	322
After an accident .....	323
Where will I find...? .....	323
Flat tire .....	326
Battery .....	338
Jump-starting .....	341
Towing and tow-starting .....	343
Fuses .....	345

# امداد خودرو فارما

تلفن شبانه روزی: ۰۲۱-۸۸۸۶۲۰۸۵

[FarmaSOS.com](http://FarmaSOS.com)

## Vehicle equipment

- i** This manual describes all the standard and optional equipment of your vehicle which was available at the time of purchase. Country-specific differences are possible. Bear in mind that your vehicle may not feature all functions described here. This also refers to safety-related systems and functions.

امداد خودرو فارما

تلفن شبانه روزی: ۰۲۱-۸۸۸۶۲۰۸۵

FarmaSOS.com

## After an accident

Problem	Possible causes/consequences and ► Solutions
Fuel is leaking from the vehicle.	<p><b>⚠ Risk of explosion or fire</b></p> <p>The fuel line or the fuel tank is faulty.</p> <ul style="list-style-type: none"> <li>► Immediately turn the key to position <b>0</b> (► page 149) in the ignition lock and remove it.</li> <li>► Do not restart the engine under any circumstances.</li> <li>► Consult a qualified specialist workshop.</li> </ul>
You are unable to determine the extent of the damage.	<ul style="list-style-type: none"> <li>► Consult a qualified specialist workshop.</li> </ul>
You cannot detect any damage.	<ul style="list-style-type: none"> <li>► Start the engine as normal.</li> </ul>
The NECK-PRO head restraints on the driver's and front-passenger seats have been triggered.	<p>Your vehicle has been involved in a rear-end collision.</p> <ul style="list-style-type: none"> <li>► Reset the triggered NECK-PRO head restraints (► page 53).</li> </ul>

## Where will I find...?

## First-aid kit

**Sedan:** the first-aid kit is in the right-hand stowage compartment in the trunk.

- Open the trunk lid.
- Slide down the parcel net.
- Open the stowage compartment.

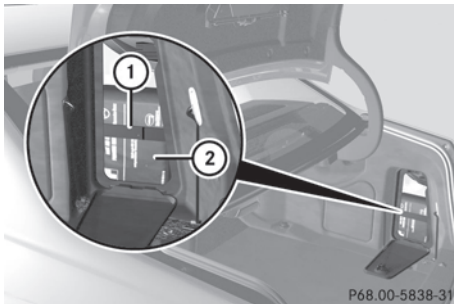

- Release strap ①.
- Remove first-aid kit ②.

**Wagon:** depending on the vehicle's equipment, the first-aid kit is in the parcel net or behind the side trim panel.

- Open the tailgate.

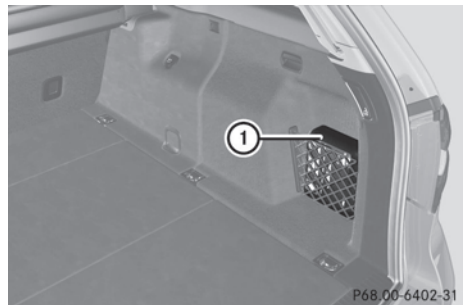

In the parcel net



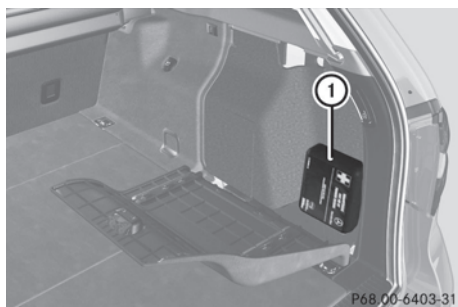

Behind the side trim panel

- ▶ Open the right-hand side trim panel if the first-aid kit is in the side trim panel.
- ▶ Remove first-aid kit ①.

**i** Check the expiration date on the first-aid kit at least once a year. Replace the contents if necessary, and replace missing contents.

### Vehicle tool kit

The vehicle tool kit can be found in the storage well under the trunk floor/cargo compartment floor.

**i** Vehicles without a spare wheel are not equipped with the tools needed to change a wheel when they leave the factory, e.g. jack or lug wrench. Some tools for changing a wheel are specific to the vehicle. To obtain tools approved for your vehicle, visit a qualified specialist workshop, e.g. an authorized Mercedes-Benz Center.

- ▶ **Sedan with TIREFIT kit<sup>32</sup>**: swing the trunk floor upwards (▷ page 285).
- ▶ **Wagon with TIREFIT kit**: remove the seat cushions of the folding bench seat (▷ page 108).
- ▶ Lift the cargo compartment floor up.

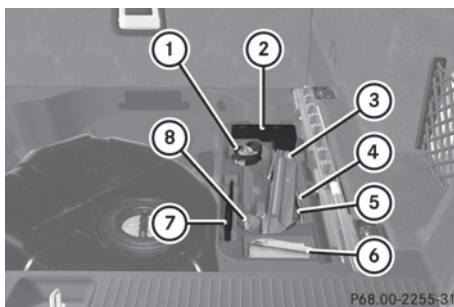

- ① TIREFIT kit
- ② Electric air pump
- ③ Jack
- ④ Towing eye
- ⑤ Lug wrench
- ⑥ Fuse allocation chart/one pair of gloves
- ⑦ Folding wheel chock
- ⑧ Alignment bolt

▶ **Sedan with spare wheel/"Minispare" emergency spare wheel**: swing the trunk floor upwards (▷ page 285).

▶ **Wagon with spare wheel/"Minispare" emergency spare wheel**: remove the seat cushions of the folding bench seat (▷ page 108).

- ▶ Lift the cargo compartment floor up.

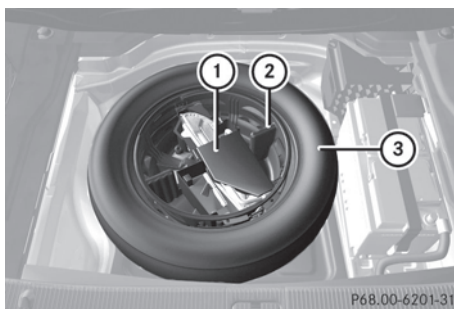

- ① Vehicle tool kit tray
- ② Stowage well
- ③ Spare wheel/"Minispare" emergency spare wheel

<sup>32</sup> Vehicles with BlueTEC only.

The vehicle tool kit contains:

- Foldable wheel chock
- Fuse allocation chart
- Jack
- Alignment bolt
- One pair of gloves
- Lug wrench
- Towing eye

► **Vehicles with "Minispare" emergency spare wheel<sup>33</sup>:** swing the trunk floor upwards (▷ page 285).

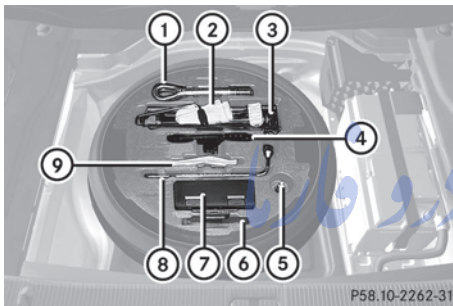

- ① Towing eye
- ② One pair of gloves
- ③ Jack
- ④ Folding wheel chock
- ⑤ Alignment bolt
- ⑥ Sheet for faulty wheel
- ⑦ Electric air pump
- ⑧ Lug wrench
- ⑨ Fuse allocation chart

### "Minispare" emergency spare tire/ collapsible emergency spare tire

#### Removing the "Minispare" emergency spare wheel/collapsible spare wheel

##### Opening the stowage well

**Sedan:** the emergency spare wheel can be found in the stowage well under the trunk floor.

► Lift the trunk floor upwards (▷ page 285).

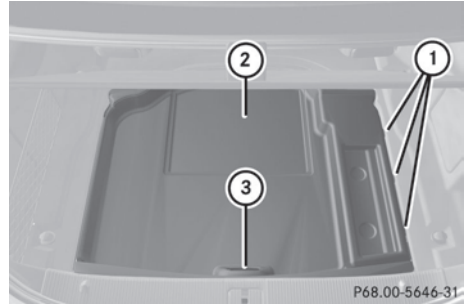

Example: well insert

- Release tabs ① on the right of well insert ②.
- Reach into recess ③ of well insert ②, swing the insert up and remove it.

**Wagon:** the emergency spare wheel is located in the stowage well under the cargo compartment floor.

- Remove the seat cushions of the folding bench seat (▷ page 108).
- Lift the cargo compartment floor up.

#### Removing the emergency spare wheel: Sedan

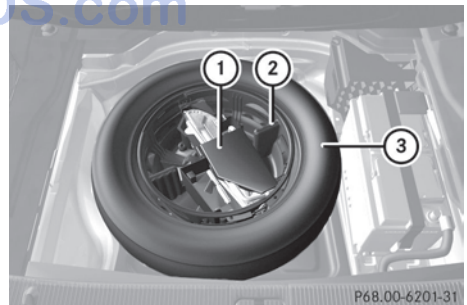

Example: Sedan

- Remove vehicle tool kit tray ①.
- Turn stowage well ② counter-clockwise and remove it.
- Remove "Minispare" emergency spare wheel ③.

<sup>33</sup> AMG vehicles only.

For further information on changing a wheel and mounting the spare wheel, see (▷ page 331).

### Removing the emergency spare wheel: Wagon

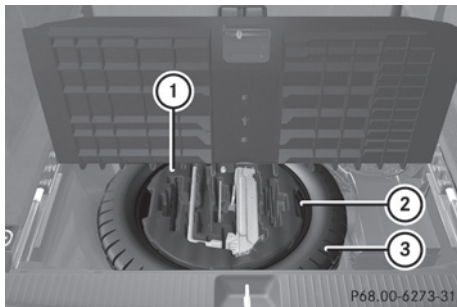

Example: emergency spare wheel

- ▶ Remove vehicle tool kit tray ① by recess ②.
- ▶ Remove "Minispare" emergency spare wheel ③.

For further information on changing a wheel and mounting the spare wheel, see (▷ page 331).

### Removing the emergency spare wheel: AMG vehicles

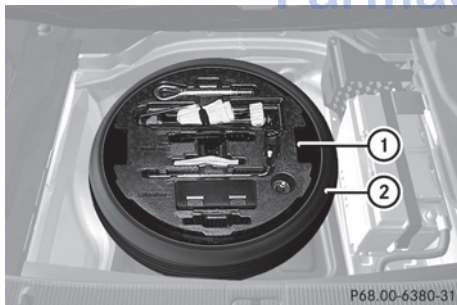

- ▶ Reach into recess ① of the tool holder and lift it up.
- ▶ Remove collapsible spare wheel ②.

For further information on changing a wheel and mounting the spare wheel, see (▷ page 331).

<sup>34</sup> Canada only.

### Stowing a used collapsible spare wheel

Take the following steps to stow a used collapsible spare wheel. It will otherwise not fit in the spare wheel well. Mercedes-Benz recommends that you have this work carried out at a qualified specialist workshop, e.g. an authorized Mercedes-Benz Center.

**!** Only place the collapsible spare wheel in the vehicle when it is dry. Otherwise, moisture may get into the vehicle.

- ▶ Unscrew the valve cap from the valve.
- ▶ Use the back of the valve cap to unscrew the valve insert from the valve and release the air.

**i** Fully deflating the tire can take a few minutes.

- ▶ Screw the valve insert back into the valve.
- ▶ Screw the valve cap back on.
- ▶ Remove the protective film from the vehicle tool kit and wrap it around the collapsible spare wheel.
- ▶ Stow the collapsible spare wheel in the emergency spare wheel well under the trunk.

### Flat tire

#### Preparing the vehicle

Your vehicle may be equipped with:

- a TIREFIT kit<sup>34</sup>
- a "Minispare" emergency spare wheel
- a collapsible spare wheel
- the MOExtended run-flat system (▷ page 337)

**i** Vehicle preparation is not necessary on vehicles with the MOExtended run-flat system.

**i** Vehicles featuring the MOExtended run-flat system are not equipped with the TIREFIT kit at the factory. It is therefore

recommended that you additionally equip your vehicle with the TIREFIT kit if you mount tires that do not feature run-flat properties, e.g. winter tires. You can obtain a TIREFIT kit from an authorized Mercedes-Benz Center, for example.

- ▶ Vehicles with AIRMATIC: make sure that "normal" level is selected (▷ page 191).
- ▶ Stop the vehicle as far away as possible from traffic on solid, non-slippery and level ground.
- ▶ Switch on the hazard warning lamps.
- ▶ Firmly depress the parking brake.
- ▶ Bring the front wheels into the straight-ahead position.
- ▶ Move the selector lever/DIRECT SELECT lever to **P**.
- ▶ Switch off the engine.
- ▶ **Vehicles without KEYLESS-GO:** remove the key from the ignition lock.
- ▶ **Vehicles with KEYLESS-GO:** open the driver's door.  
The on-board electronics have status **0**, which is the same as the key having been removed.
- ▶ **Vehicles with KEYLESS-GO:** remove the Start/Stop button from the ignition lock (▷ page 150).
- ▶ All occupants must get out of the vehicle. Make sure that they are not endangered as they get out of the vehicle.
- ▶ Make sure that no one is near the danger area whilst a wheel is being changed. Anyone who is not directly assisting in the wheel change should, for example, stand behind the barrier.
- ▶ Get out of the vehicle. Pay attention to traffic conditions when doing so.
- ▶ Close the driver's door.

## TIREFIT kit

### Using the TIREFIT kit

You can use the TIREFIT kit to seal small punctures, particularly those in the tire tread. You can use TIREFIT at outside temperatures down to -4 °F (-20 °C).

#### Warning

TIREFIT is a limited repair device. TIREFIT cannot be used for cuts or punctures larger than approximately 0.16 in (4 mm) and tire damage caused by driving with extremely low tire inflation pressure, or on a flat tire, or a damaged wheel.

Do not drive the vehicle under such circumstances.

Contact the nearest authorized Mercedes-Benz Center for assistance or call roadside assistance.

- ▶ Do not remove any foreign objects which have penetrated the tire, e.g. screws or nails.
- ▶ Remove the TIREFIT kit, the accompanying "max. 80 km/h" sticker and the electric air pump from the stowage well underneath the trunk/trunk floor (▷ page 324).

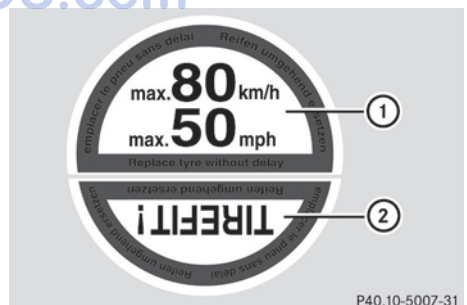

- ▶ Affix part ① of the sticker within the driver's field of vision.
- ▶ Affix part ② of the sticker near the valve on the wheel with the defective tire.

### ⚠ Warning

Take care not to allow the contents of TIREFIT to come in contact with hair, eyes or clothing. TIREFIT is harmful if inhaled, swallowed or absorbed through the skin - causes skin, eye and respiratory irritation.

Any contact with eyes or skin should be flushed immediately with plenty of water.

If clothing comes in contact with TIREFIT, change clothing as soon as possible.

In case of allergic reaction or rash, consult a physician immediately.

### ⚠ Warning

Keep TIREFIT away from children. If swallowed, rinse mouth immediately with plenty of water and drink plenty of water. Do not induce vomiting.

Consult a doctor immediately.

Keep away from open flame or heat source.

- i** If TIREFIT leaks out, allow it to dry. It can then be removed like a layer of film. If you get TIREFIT on your clothing, have it cleaned as soon as possible with perchloroethylene.

### ⚠ Warning

Comply with the manufacturer's safety instructions on the sticker on the electric air pump.

Your vehicle is provided with one of two different electric air pumps:

- **Version 1:** the hose with the pressure gauge and the cable are behind a flap.
- **Version 2:** the pressure gauge is in the electric air pump.

## TIREFIT kit version 1

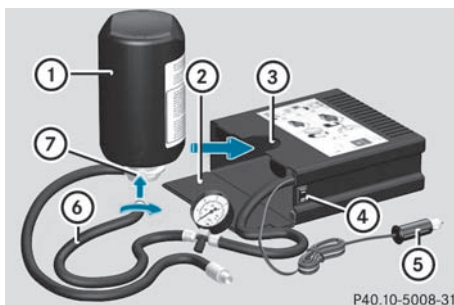

P40.10-5008-31

- ▶ Open flap ②.
- ▶ Pull connector ⑤ with the cable and hose ⑥ out of the housing.
- ▶ Screw hose ⑥ onto flange ⑦ of TIREFIT sealant filler bottle ①.
- ▶ Place TIREFIT sealant filler bottle ① head downwards into recess ③ of the electric air pump.

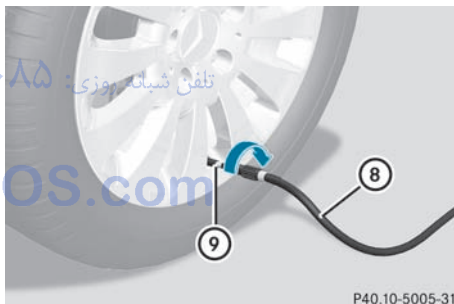

P40.10-5005-31

- ▶ Remove the cap from valve ⑨ on the faulty tire.

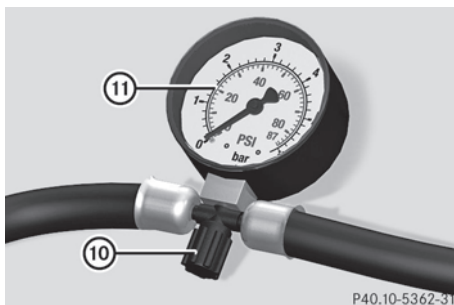

P40.10-5362-31

- ▶ Make sure pressure release screw ⑩ on pressure gauge ⑪ is fully closed.
- ▶ Screw filler hose ⑧ onto valve ⑨.
- ▶ Insert connector ⑤ into the cigarette lighter socket (▷ page 292) or into a 12 V socket in your vehicle (▷ page 292).
- ▶ Turn the key to position 1 (▷ page 149) in the ignition lock.
- ▶ Press on/off switch ④ on the electric air pump to I.  
The electric air pump is switched on. The tire is inflated.

**i** First, TIREFIT is pumped into the tire. The pressure can briefly rise to approximately 500 kPa (5 bar/73 psi).

**Do not switch off the electric pump during this phase.**

- ▶ Let the electric pump run for five minutes. The tire should then have attained a pressure of at least 180 kPa (1.8 bar/26 psi).

**⚠ Warning**

The air hose can become hot during inflation. Please exercise appropriate caution.

- !** Do not operate the electric air pump for longer than eight minutes at a time without a break. It may otherwise overheat.

The air pump can be operated again once it has cooled down.

If, after five minutes, a pressure of 180 kPa (1.8 bar/26 psi) has been achieved, see (▷ page 330).

If, after five minutes, a pressure of 180 kPa (1.8 bar/26 psi) has not been achieved, see (▷ page 330).

## TIREFIT kit version 2

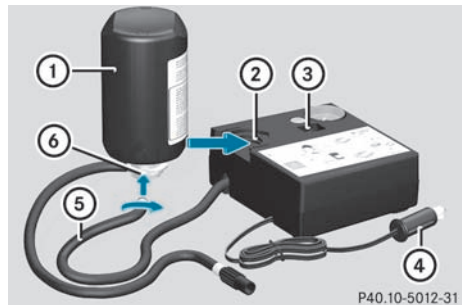

- ▶ Pull connector ④ with the cable and hose ⑤ out of the housing.
- ▶ Screw hose ⑤ onto flange ⑥ of TIREFIT sealant filler bottle ①.
- ▶ Place TIREFIT sealant filler bottle ① head downwards into recess ② of the electric air pump.

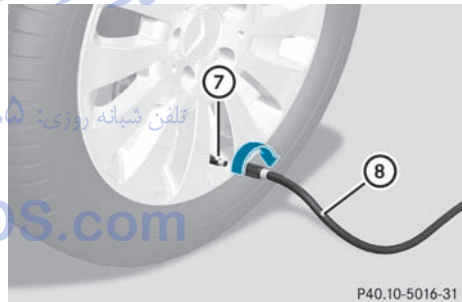

- ▶ Remove the cap from valve ⑦ on the faulty tire.
- ▶ Screw filler hose ⑧ onto valve ⑦.
- ▶ Insert plug ④ into the cigarette lighter socket (▷ page 292) or into a 12 V socket in your vehicle (▷ page 292).
- ▶ Turn the key to position 1 (▷ page 149) in the ignition lock.
- ▶ Press on/off switch ③ on the electric air pump to I.  
The electric air pump is switched on. The tire is inflated.



**i** First, TIREFIT is pumped into the tire. The pressure can briefly rise to approximately 500 kPa (5 bar/73 psi).

**Do not switch off the electric pump during this phase.**

- ▶ Let the electric pump run for five minutes. The tire should then have attained a pressure of at least 180 kPa (1.8 bar/26 psi).

#### **Warning**

The air hose can become hot during inflation. Please exercise appropriate caution.

**!** Do not operate the electric air pump for longer than eight minutes at a time without a break. It may otherwise overheat.

The air pump can be operated again once it has cooled down.

If, after five minutes, a pressure of 180 kPa (1.8 bar/26 psi) has been achieved, see (▷ page 330).

If, after five minutes, a pressure of 180 kPa (1.8 bar/26 psi) has not been achieved, see (▷ page 330).

#### **Tire pressure of 180 kPa (1.8 bar/26 psi) is not achieved**

If after five minutes a pressure of 180 kPa (1.8 bar/26 psi) has not been achieved:

- ▶ Press the on/off switch on the electric air pump to **0**. The electric air pump is switched off.
- ▶ Unscrew the filler hose from the valve.
- ▶ Very slowly drive forwards or reverse approximately 30 ft (10 m).
- ▶ Pump up the tire again.

#### **Warning**

If after five minutes a pressure of 180 kPa (1.8 bar/26 psi) cannot be achieved, the tire is too badly damaged to be repaired reliably using TIREFIT.

In this case TIREFIT cannot seal the tire properly.

Do not drive any further.

Contact the nearest authorized Mercedes-Benz Center for assistance or call roadside assistance.

#### **Tire pressure of 180 kPa (1.8 bar/26 psi) is achieved**

- ▶ Press the on/off switch on the electric air pump to **0**. The electric air pump is switched off.
- ▶ Remove the TIREFIT kit from the wheel.

#### **Warning**

The air hose may still be hot. Exercise proper caution to avoid burning yourself when detaching the electric air pump.

**!** After use, excess TIREFIT may run out of the filler hose. This could cause stains.

Therefore, place the filler hose in the plastic bag which contained the TIREFIT kit.

- ▶ Stow the TIREFIT kit and the electric air pump.
- ▶ **Pull away immediately.**

#### **Warning**

Do not exceed a vehicle speed of 50 mph (80 km/h). A TIREFIT repair is not designed to operate at higher speeds.

The sticker must be attached on the instrument cluster where it will be easily seen by the driver.

Vehicle handling characteristics of a TIREFIT repaired tire may change. Adapt your driving accordingly.

- ▶ Stop after driving for approximately ten minutes and check the tire pressure with the electric air pump.

#### **Warning**

If tire inflation pressure has fallen below 130 kPa (1.3 bar/26 psi) do not continue to drive the vehicle.



Park your vehicle safely away from the roadway and contact the nearest authorized Mercedes-Benz Center or roadside assistance.  
Have the damaged tire replaced.

- ▶ Correct the tire inflation pressure if it is at least 130 kPa (1.3 bar/26 psi) (for values see Tire and Load Information placard on the driver's side B-pillar or tire inflation pressure table inside the fuel filler flap).
- ▶ **To increase the tire pressure:** switch on the electric air pump.

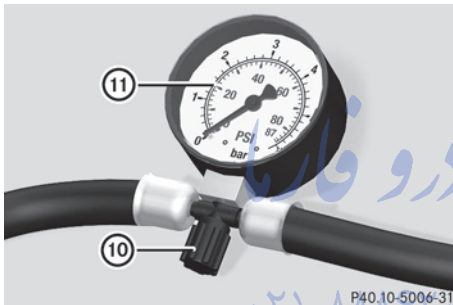

TIREFIT kit version 1

- ▶ **To reduce the tire pressure (version 1):** open pressure release screw (10) on pressure gauge (11).

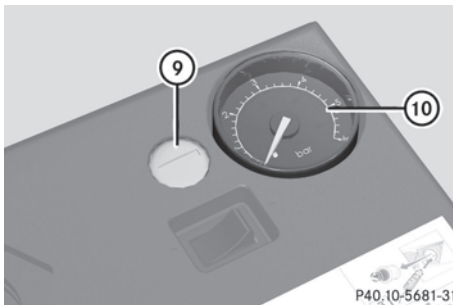

TIREFIT kit version 2

- ▶ **To reduce the tire pressure (version 2):** press pressure release button (9) next to pressure gauge (10).

- ▶ Stow the TIREFIT kit and the electric air pump.
- ▶ Drive to the nearest workshop and have the tire changed there.
- ▶ Have the TIREFIT kit replaced as soon as possible at a qualified specialist workshop, e.g. at an authorized Mercedes-Benz Center.

**Environmental note**

Have the used TIREFIT kit disposed of professionally, e.g. at an authorized Mercedes-Benz Center.

- ▶ Have the TIREFIT kit replaced every four years at a qualified specialist workshop, e.g. an authorized Mercedes-Benz Center.

**Changing a wheel and mounting the spare wheel**

**Preparing the vehicle**

**Warning!**

The wheel and tire size of the emergency spare wheel/spare wheel may differ to that of the damaged wheel. When using an emergency spare wheel/spare wheel the handling characteristics of the vehicle may change.

Adapt your style of driving accordingly.

Never operate the vehicle with more than one emergency spare wheel/spare wheel that differs in size.

Only use an emergency spare wheel/spare wheel of a differing size briefly and do not switch off ESP®.

When using an emergency spare wheel, you must not exceed a maximum speed of 50 mph (80 km/h).

**Warning!**

Have the emergency spare wheel/spare wheel replaced with a new wheel as soon as possible at a qualified specialist workshop which has the necessary specialist knowledge

and tools to carry out the work required. Mercedes-Benz recommends that you use an authorized Mercedes-Benz Center for this purpose. In particular, work relevant to safety or on safety-related systems must be carried out at a qualified specialist workshop.

**i** Vehicles without an emergency spare wheel/spare wheel are not equipped with wheel-changing tools at the factory. For more information on which tools are required to perform a wheel change on your vehicle, e.g. wheel chock, alignment bolt or lug wrench, consult an authorized Mercedes-Benz Center.

- ▶ Prepare the vehicle as described (▷ page 326).
- ▶ Remove the following items from the stowage well under the trunk/cargo compartment floor:
  - the emergency spare wheel<sup>35</sup>
  - the lug wrench
  - the folding wheel chock
  - the jack
  - the alignment bolt
  - the electric air pump<sup>35</sup>
- ▶ Secure the vehicle to prevent it from rolling away.

### Securing the vehicle to prevent it from rolling away

#### Warning

Only jack up the vehicle on level ground or on slight inclines/declines. The vehicle could otherwise fall off the jack and injure you or others.

If your vehicle is equipped with a wheel chock, it can be found in the vehicle tool kit (▷ page 324).

The folding wheel chock is an additional securing measure to prevent the vehicle from

rolling away, for example when changing a wheel.

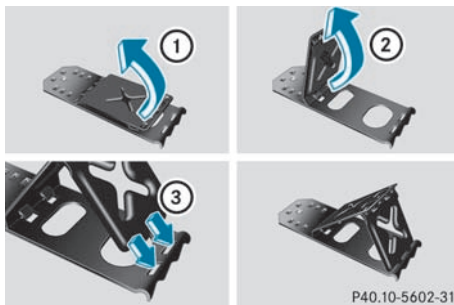

- ▶ Fold both plates upwards ①.
- ▶ Fold out lower plate ②.
- ▶ Guide the lugs on the lower plate fully into openings in base plate ③.



Securing the vehicle on level ground (example: Sedan)

- ▶ **On level ground:** place chocks or other suitable items under the front and rear of the wheel that is diagonally opposite the wheel you wish to change.

<sup>35</sup> Vehicles with an emergency spare wheel.

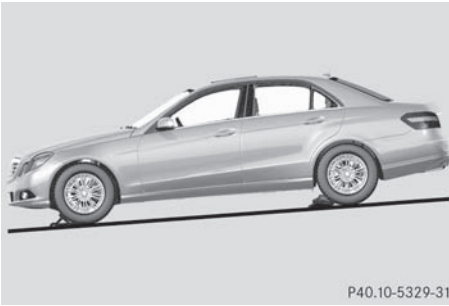

P40.10-5329-31

Securing the vehicle on slight downhill gradients (example: Sedan)

- **On downhill gradients:** place chocks or other suitable items in front of the wheels of the front and rear axle.

## Raising the vehicle

### Warning

When jacking up the vehicle, only use the jack which has been specifically approved by Mercedes-Benz for your vehicle.

The jack is designed exclusively for jacking up the vehicle at the jacking points built into both sides of the vehicle. The jack saddle must be placed centrally under the jacking point. The jack must always be vertical when in use, especially on inclines or declines.

The jack is intended only for lifting the vehicle briefly for wheel changes. It is not suited for performing maintenance work under the vehicle. To help avoid personal injury, use the jack only to lift the vehicle during a wheel change.

Never get beneath the vehicle while it is supported by the jack. Keep hands and feet away from the area under the lifted vehicle. Always lower the vehicle onto sufficient capacity jackstands before working under the vehicle.

Always firmly engage the parking brake and block the wheels with wheel chocks or other sizable objects before raising the vehicle with the jack. Do not disengage the parking brake while the vehicle is raised.

Make sure that the ground on which the vehicle is standing and where you place the jack is solid, level and not slippery. If necessary, use a large underlay. On slippery surfaces, such as tiled floors, you should use a non-slip underlay, for example a rubber mat. Do not use wooden blocks or similar objects as a jack underlay. Otherwise, the jack may not be able to achieve its load-bearing capacity if it is not at its full height.

Never start the engine when the vehicle is raised.

Also observe the notes on the jack.

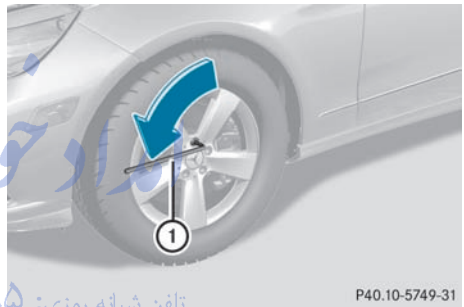

P40.10-5749-31

- Using lug wrench ①, loosen the bolts on the wheel you wish to change by about one full turn. Do not unscrew the bolts completely.

The jacking points for the jack are located behind the wheel housings of the front wheels and in front of the wheel housings of the rear wheels (arrows).

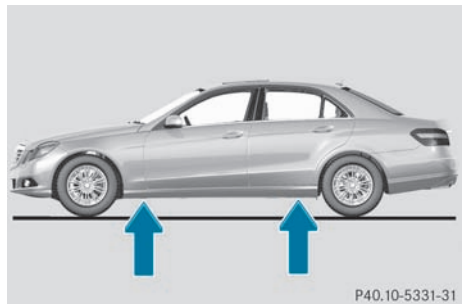

P40.10-5331-31

Jacking points for the jack (example: Sedan)

### AMG vehicles and vehicles with AMG

**equipment:** the vehicle has covers mounted next to the jacking points on the outer sills to protect the vehicle body.

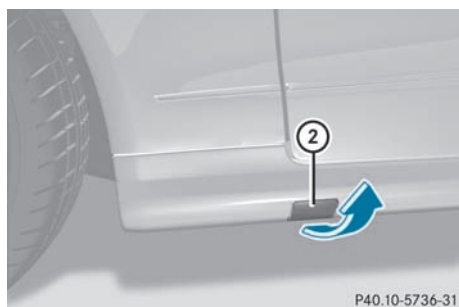

P40.10-5736-31

Covers, front (example: vehicles with AMG Sports package)

- ▶ **AMG vehicles and vehicles with AMG equipment:** fold cover (2) upwards.

#### ⚠ Warning

The jack is designed exclusively for jacking up the vehicle at the jacking points. The jack saddle must be placed centrally under the jacking point.

If you do not position the jack correctly in the jacking point, the vehicle can fall off the jack and seriously or fatally injure you or others.

- ❗ The jack is designed exclusively for jacking up the vehicle at the jacking points. Otherwise, your vehicle could be damaged.

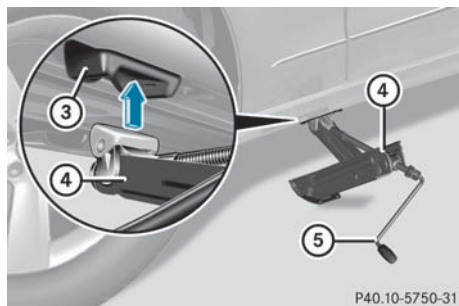

P40.10-5750-31

- ▶ Position jack (4) at jacking point (3).

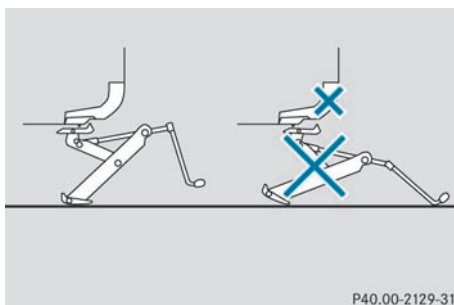

P40.00-2129-31

- ▶ Make sure that the base of the jack is positioned directly under the jacking point.
- ▶ Turn crank (5) clockwise until jack (4) sits completely on jacking point (3) and the base of the jack lies evenly on the ground.
- ▶ Turn crank (5) until the tire is raised a maximum of 1.2 inches (3 cm) off the ground.

### Removing a wheel

- ❗ **AMG vehicles:** during removal and repositioning of the wheel, the wheel rim can strike the ceramic-brake disc and damage it. Therefore, take precautions and get a second person to assist you. Alternatively, you can use a second alignment bolt.

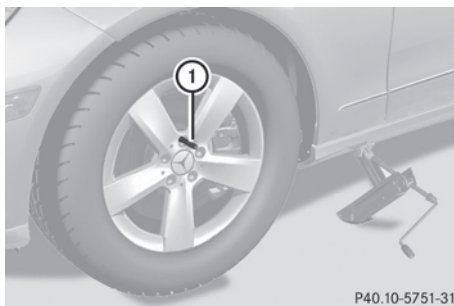

P40.10-5751-31

- ▶ Unscrew the uppermost wheel bolt completely.
- ▶ Screw alignment bolt (1) into the thread instead of the wheel bolt.
- ▶ Unscrew the remaining wheel bolts fully.

**!** Do not place wheel bolts in sand or on a dirty surface. The bolt and wheel hub threads could otherwise be damaged when you screw them in.

► Remove the wheel.

## Mounting a new wheel

### **⚠ Warning!**

Always replace wheel bolts that are damaged or rusted.

Never apply oil or grease to wheel bolts.

Damaged wheel hub threads should be repaired immediately. Do not continue to drive under these circumstances! Contact an authorized Mercedes-Benz Center or call Roadside Assistance.

Incorrect wheel bolts or improperly tightened wheel bolts can cause the wheel to come off. This could cause an accident. Make sure to use the correct wheel bolts.

### **⚠ Warning**

Only use genuine Mercedes-Benz wheel bolts. Other wheel bolts may come loose.

Do not tighten the wheel bolts when the vehicle is raised. Otherwise, the vehicle could fall off the jack.

### **⚠ Warning**

Make sure to use the original length wheel bolts when remounting the original wheel after it has been repaired.

► Clean the wheel and wheel hub contact surfaces.

**!** To prevent damage to the paintwork, hold the wheel securely against the wheel hub while screwing in the first wheel bolt.

**!** **AMG vehicles:** during removal and repositioning of the wheel, the wheel rim can strike the ceramic-brake disc and damage it. Therefore, take precautions and get a second person to assist you.

Alternatively, you can use a second alignment bolt.

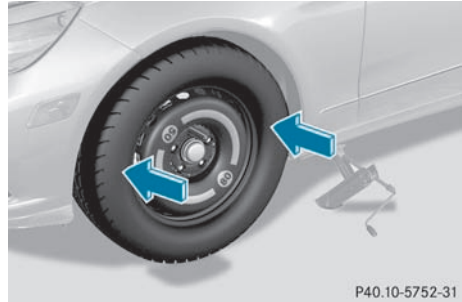

P40.10-5752-31

- Slide the emergency spare wheel onto the alignment bolt and push it on.
- Tighten the wheel bolts until they are finger-tight.
- Unscrew the alignment bolt.
- Tighten the last wheel bolt until it is finger-tight.

## Inflating the collapsible spare tire

### **⚠ Warning!**

Pump up the collapsible spare wheel before lowering the vehicle. You could otherwise damage the wheel rim.

### **⚠ Warning!**

Comply with the manufacturer's safety instructions on the sticker on the electric air pump.

Your vehicle is equipped with one of two electric air pumps:

- **Version 1:** electric air pump with pressure gauge on the air hose.
- **Version 2:** electric air pump with integrated pressure gauge.

The following description applies to both versions. Differences in the way they are used will be explained in detail.

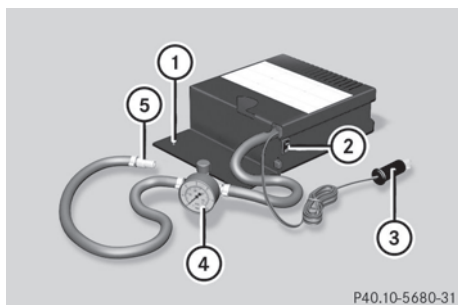

Version 1

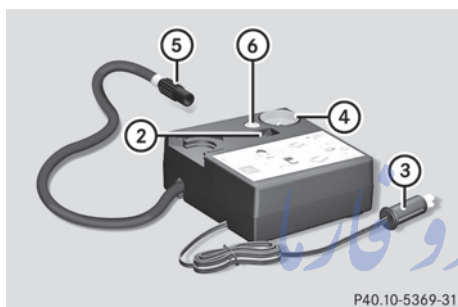

Version 2

- ▶ **Version 1:** open flap ①.
- ▶ **Version 1:** pull connector ③ and the air hose with pressure gauge ④ out of the housing.
- ▶ **Version 2:** pull connector ③ and the air hose out of the housing.
- ▶ **Version 1:** make sure that the pressure release screw on pressure gauge ④ is closed.
- ▶ Screw the valve cap onto the valve of the collapsible spare wheel.
- ▶ Screw union nut ⑤ on the air hose onto the valve.
- ▶ Make sure on/off switch ② of the electric air pump is set to **0**.
- ▶ Insert connector ③ into the cigarette lighter socket (▷ page 292) or into a 12 V socket (▷ page 292) in your vehicle.

- ▶ Make sure that the key is in position **1** (▷ page 149) in the ignition lock.
- ▶ Press on/off switch ② on the electric air pump to **I**.  
The electric air pump is switched on. The tire is inflated.

### **Warning**

The air hose and the union nut can become hot during inflation. Exercise proper caution to avoid burning yourself when using the equipment.

- ▶ **I** Do not operate the electric air pump for longer than eight minutes at a time without a break. It may otherwise overheat.  
The air pump can be operated again once it has cooled down.
- ▶ Inflate the tires to the prescribed tire pressure.  
The prescribed tire pressure is stated on the yellow sticker which is affixed to emergency spare wheel.
- ▶ When the prescribed tire pressure has been attained, press on/off switch ② on the electric air pump to **0**.  
The electric air pump is switched off.
- ▶ Turn the key to position **0** in the ignition lock.
- ▶ **Version 1:** if the tire pressure is higher than specified, open the pressure release screw on pressure gauge ④ until the correct tire pressure is set.
- ▶ **Version 2:** if the tire pressure is higher than specified, press pressure release button ⑥ until the correct tire pressure is set.
- ▶ Unscrew union nut ⑤ of the air hose from the valve.
- ▶ Screw the valve cap onto the valve of the collapsible spare wheel again.
- ▶ **Version 1:** stow connector ③ and the air hose behind flap ①.



- ▶ **Version 2:** stow connector ③ and the air hose in the lower section of the pump housing.
- ▶ Stow the electric air pump in the designated place in the vehicle.

## Lowering the vehicle

### ⚠ Warning!

Vehicles with spare wheel with collapsible tire only: Inflate collapsible tire only after the wheel is properly attached.

Inflate the collapsible tire using the electric air pump **before** lowering the vehicle.

- ▶ Turn the crank of the jack counterclockwise until the vehicle is once again standing firmly on the ground.
- ▶ Place the jack to one side.

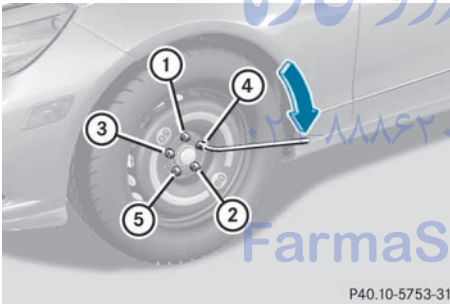

- ▶ Tighten the wheel bolts evenly in a crosswise pattern in the sequence indicated (① to ⑤). The tightening torque must be **96 lb-ft (130 Nm)**.

### ⚠ Risk of accident

Have the tightening torque checked immediately after a wheel is changed. The wheels could come loose if they are not tightened to a torque of **96 lb-ft (130 Nm)**.

- ▶ Turn the jack back to its initial position and store it together with the rest of the vehicle tool kit in the trunk/cargo compartment.

- ▶ **AMG vehicles and vehicles with AMG equipment:** insert the cover into the outer sill.

Vehicles with an emergency spare wheel:

- ▶ Transport the faulty wheel in the trunk/cargo compartment.
- or
- ▶ Depending on the size of the wheel, you may also be able to secure the faulty wheel in the spare wheel well. In this case, you will have to remove the stowage well casing from the spare wheel well and stow it securely in the trunk/cargo compartment.

Further information on stowing the collapsible spare wheel (> page 326).

- ▶ **i** When you are driving with the collapsible spare wheel mounted, the tire pressure loss warning system or the tire pressure monitor cannot function reliably. Only restart the tire pressure loss warning system/tire pressure monitor when the defective wheel has been replaced with a new wheel. تلفن

Vehicles with tire pressure monitor: all mounted wheels must be equipped with functioning sensors and the defective wheel should no longer be in the vehicle.

## MOExtended run-flat system

The MOExtended run-flat system allows you to drive on even if there is a complete loss of pressure in one or more tires.

The MOExtended run-flat system may only be used in conjunction with the activated tire pressure loss warning system or with the activated tire pressure monitor.

The maximum permissible distance which can be driven in run-flat mode depends on the cargo in the vehicle. You can drive 50 miles (80 km) if the vehicle is partially laden and 18 miles (30 km) if it is fully laden.

The maximum permissible distance which can be driven in run-flat mode is counted from



the moment the tire pressure loss warning appears in the multifunction display.

You must not exceed a maximum speed of 50 mph (80 km/h).

### **Warning!**

The handling characteristics of your vehicle deteriorate in run-flat mode, for example:

- when cornering
- when braking
- when accelerating rapidly

Adapt your driving style accordingly and avoid sudden changes in direction and sudden acceleration, as well as driving over obstacles (i.e. curbs, potholes), and driving off-road. This is particularly the case when the vehicle is heavily laden.

The maximum permissible distance that can be driven in run-flat mode depends to a large extent on the loads placed on the vehicle. It can be shorter due to high speeds, a heavy cargo, sudden changes in direction, the road surface condition, outside temperature, etc., or further if you drive carefully and conservatively.

Do not continue to drive in run-flat mode if:

- you hear banging noises.
- the vehicle starts to shake.
- you see smoke and smell rubber.
- ESP® is intervening constantly.
- there are tears in the sidewalls of the tire.

After driving in run-flat mode, you must have the wheel(s) checked for damage at a qualified specialist workshop which has the necessary specialist knowledge and tools to carry out the work required. The faulty tire must be replaced in every case.

Mercedes-Benz recommends that you use an authorized Mercedes-Benz Center for this purpose. In particular, work relevant to safety or on safety-related systems must be carried out at a qualified specialist workshop.

- i** When replacing one or all tires, make sure that you only use tires marked

MOExtended and of the specified size for the vehicle.

- i** Vehicles featuring the MOExtended run-flat system are not equipped with TIREFIT kit at the factory. It is therefore recommended that you additionally equip your vehicle with the TIREFIT kit if you mount tires that do not feature run-flat properties, e.g. winter tires. You can obtain a TIREFIT kit from an authorized Mercedes-Benz Center, for example.

## Battery

### Important safety notes

In order for the battery to achieve the maximum possible service life, it must always be sufficiently charged.

- i** Have the battery checked regularly at a qualified specialist workshop, e.g. an authorized Mercedes-Benz Center.

Observe the service intervals in the Service Booklet or for further information consult a qualified specialist workshop, e.g. an authorized Mercedes-Benz Center.

Have the battery charge checked more frequently if you use the vehicle mainly for short trips or if you leave it standing idle for a lengthy period.

To prevent damage from corrosion, only replace the battery with one that has a central ventilation cover.

Only replace a battery with a battery that has been recommended by Mercedes-Benz.

Consult an authorized Mercedes-Benz Center if you wish to leave your vehicle parked up for a long period of time.

### **Warning**

Comply with safety precautions and take protective measures when handling batteries.



Risk of explosion



Fire, naked flames and smoking are prohibited when handling the battery. Avoid creating sparks.



Battery acid is caustic. Avoid contact with the skin, eyes or clothing.

Wear suitable protective clothing, in particular gloves, an apron and a face mask.

Immediately rinse acid splashes off with clean water. Consult a doctor if necessary.

Wear eye protection.



Keep children away.



Observe this Operator's Manual.



#### Environmental note

Do not dispose of batteries in the household rubbish. Dispose of defective batteries in an environmentally responsible manner. Take them to an authorized Mercedes-Benz Center or to a special collection point for old batteries.

#### Warning

Failure to follow these instructions can result in severe injury or death.

Never lean over batteries while connecting. You might get injured.

Battery fluid contains sulfuric acid. Do not allow this fluid to come in contact with eyes,

skin or clothing. In case it does, immediately flush affected area with water and seek medical help if necessary.

A battery will also produce hydrogen gas, which is flammable and explosive. Keep flames or sparks away from battery, avoid improper connection of jumper cables, smoking etc.

#### Warning

Do not place any metal objects on the battery as this could result in a short circuit.

Use leak-proof batteries only to avoid the risk of acid burns in the event of an accident.

Take care that you do not become statically charged, e.g. by wearing synthetic clothing or rubbing against textiles. For this reason, you also should not pull or push the battery over carpets or other synthetic materials.

Never touch the battery first. First, touch the outside body of the vehicle in order to release any possible electrostatic charges.

Do not rub the battery with rags or cloths. The battery could explode if touched due to electrostatic charge or due to spark formation.

Switch off the engine and remove the key before disconnecting the terminal clamps from the battery. On vehicles with KEYLESS-GO, make sure that the ignition is switched off. Check that all the indicator lamps in the instrument cluster are off. You may otherwise destroy electronic components, such as the alternator.

Like other batteries, the vehicle battery may discharge over time if you do not use the vehicle. In this case, have the battery disconnected at a qualified specialist workshop, e.g. an authorized Mercedes-Benz Center. You can also charge the battery with a charger recommended by Mercedes-Benz. Contact an authorized Mercedes-Benz Center for further information.

The battery, breather hose and cover of the positive terminal clamp must be installed securely during operation.

- i** Remove the key if you park the vehicle and do not require any electrical consumers. The vehicle will then use very little energy, thus conserving battery power.

Mercedes-Benz recommends that you do not carry out work on batteries yourself, e.g. removing, charging or replacing. Always have this work performed at a qualified specialist workshop, e.g. an authorized Mercedes-Benz Center.

### Charging the battery

#### Warning

Never charge a battery while still installed in the vehicle unless the accessory battery charge unit approved by Mercedes-Benz is being used. Gases may escape during charging and cause explosions that may result in paint damage, corrosion or personal injury.

An accessory battery charge unit specially adapted for Mercedes-Benz vehicles and tested and approved by Mercedes-Benz is available. It permits the charging of the battery in its installed position. Contact an authorized Mercedes-Benz Center for information and availability.

Charge the battery in accordance with the separate instructions for the accessory battery charger.

#### Warning!

There is a risk of acid burns during the charging process due to the gases which escape from the battery. Do not lean over the battery during the charging process.

#### Warning!

Battery acid is caustic. Avoid contact with the skin, eyes or clothing.

**!** Only charge the installed battery with a battery charger which has been tested and approved by Mercedes-Benz. These battery chargers allow the battery to be charged while still installed.

**!** Only use battery chargers with a maximum charging voltage of 14.8 V.

**!** Only charge the battery using the jump-starting connection point.

The jump-starting connection point is in the engine compartment (▷ page 341).

- ▶ Open the hood (▷ page 308).
- ▶ Connect the battery charger to the positive terminal and earth point in the same order as when connecting the donor battery in the jump-starting procedure (▷ page 341).

امداد خودروفااربا  
تلفن شبانه روزی: ۰۸۵ ۰۸۶۲ ۰۸۵  
FarmaSOS.com

## Jump-starting

### Warning

Failure to follow these directions will cause damage to the electronic components, and can lead to a battery explosion and severe injury or death.

Never lean over batteries while connecting or jump starting. You might get injured.

Battery fluid contains sulfuric acid. Do not allow this fluid to come in contact with eyes, skin or clothing. In case it does, immediately flush affected area with water, and seek medical help if necessary.

A battery will also produce hydrogen gas, which is flammable and explosive. Keep flames or sparks away from battery, avoid improper connection of jumper cables, smoking, etc.

Attempting to jump start a frozen battery can result in it exploding, causing personal injury.

Read all instructions before proceeding.

**!** Avoid repeated and lengthy starting attempts. Otherwise, non-combusted fuel may damage the catalytic converter<sup>36</sup> and create a risk of fire.

Do not use a rapid-charging device to start the engine.

Make sure the jumper cables are not damaged.

Make sure the jumper cables are not touching any other metal objects when they are connected to the battery.

If your vehicle's battery is discharged, the engine can be jump-started from another vehicle or from a second battery using jumper cables.

Observe the following points: تلفن شبانه روزی: ۰۸۵-۸۸۶۲۰۸۵

- ▶ The battery is not accessible in all vehicles. If the other vehicle's battery is not accessible, jump-start the vehicle using a second battery or a jump-starting device.
  - ▶ Only jump-start the vehicle when the engine is cold and the catalytic converter system has cooled down<sup>37</sup>.
  - ▶ Do not start the engine if the battery is frozen. Let the battery thaw first.
  - ▶ Jump-starting may only be performed from batteries with a nominal voltage of 12 V. If you jump-start using a battery with higher voltage, it may damage the electrical systems of the vehicle.
  - ▶ Only use jumper cables which have a sufficient cross-section and insulated terminal clamps.
  - ▶ Make sure that the jumper cables cannot come into contact with parts, such as the pulley or the fan. These parts move when the engine is started and while it is running.
  - ▶ If the battery is fully discharged, leave the battery that is being used to jump-start connected for a few minutes before attempting to start. This charges the battery a little.
- i** Jumper cables and further information about jump-starting can be obtained from any authorized Mercedes-Benz Center.
- ▶ Make sure that the two vehicles do not touch.
  - ▶ Apply the parking brake firmly.

<sup>36</sup> Only vehicles with a gasoline engine.

<sup>37</sup> Only vehicles with a gasoline engine.

- ▶ Shift the transmission to position **P**.
- ▶ Switch off all electrical consumers (e.g. radio, blower etc.).
- ▶ Open the hood (> page 308).

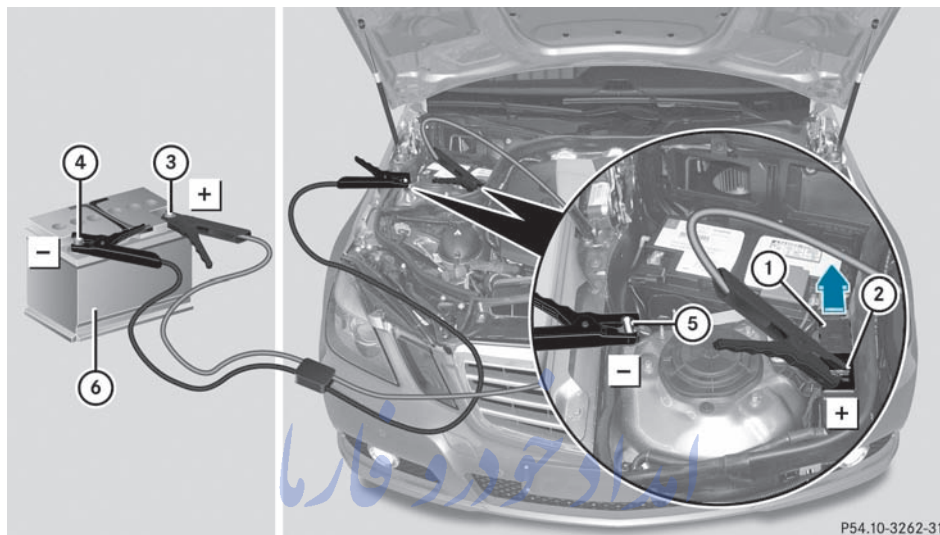

Position number ⑥ identifies the charged battery of the other vehicle or an equivalent jump-starting device.

**!** Never swap the terminal connections.

- ▶ Slide cover ① of positive terminal ② in the direction of the arrow.
- ▶ Connect positive terminal ② on your vehicle to positive terminal ③ of donor battery ⑥ using the jumper cable, beginning with your own battery.
- ▶ Start the engine of the donor vehicle and run it at idling speed.
- ▶ Connect negative terminal ④ of donor battery ⑥ to earth point ⑤ of your vehicle using the jumper cable, connecting the jumper cable to donor battery ⑥ first.
- ▶ Start the engine.
- ▶ First remove the jumper cable from earth point ⑤ and negative terminal ④, then from positive terminal ② and positive terminal ③, each time disconnecting from the battery on your own vehicle first.
- ▶ Have the battery checked at a qualified specialist workshop, e.g. an authorized Mercedes-Benz Center.

## Towing and tow-starting

### Important safety notes

#### Warning

If you tow the vehicle, you must use a rigid towing bar if:

- the engine will not run.
- there is a malfunction in the brake system.
- there is a malfunction in the power supply or the vehicle's electrical system.

With the engine not running, there is no power assistance for the brake and steering systems. You will then need considerably more force to steer and to brake and the brake pedal travel will be longer. If necessary, depress the brake pedal with maximum force.

Before towing away, make sure that the steering can be moved and is not locked.

If you tow or tow-start another vehicle, its weight must not exceed the maximum permissible gross vehicle weight of your vehicle.

#### Warning

The vehicle is braked when the HOLD function or DISTRONIC PLUS is activated. Therefore, deactivate HOLD and DISTRONIC PLUS if the vehicle is to be towed.

It is better to have the vehicle transported than to have it towed.

- ! You may only tow the vehicle a maximum distance of 30 miles (50 km). A towing speed of 30 mph (50 km/h) must not be exceeded.

For towing distances over 30 miles (50 km), the vehicle must be loaded onto a transporter.

- ! Only secure the tow rope or tow bar at the towing eyes. Otherwise, the vehicle could be damaged.
- ! Do not use the towing eye for recovery, as this could damage the vehicle. If in doubt, recover the vehicle with a crane.

- ! Drive slowly and smoothly when towing. Excessive tractive power could otherwise damage the vehicles.

- ! Do not tow with sling-type equipment. This could damage the vehicle.

- ! When towing vehicles with KEYLESS-GO, use the key instead of the Start/Stop button. Otherwise, the automatic transmission may shift to position **P** when the driver's or front-passenger door are opened, which could lead to damage to the transmission.

- ! Vehicles with automatic transmission must not be started by tow-starting. This could otherwise damage the transmission.

- ! Vehicles with 4MATIC must not be towed with the front or rear axle raised. This could otherwise damage the transmission.

The automatic transmission must be in position **N** when the vehicle is being towed. The battery must be connected and charged. You will otherwise be unable to:

- turn the SmartKey to position **2** in the ignition lock
- shift the automatic transmission to position **N**

- i Deactivate the automatic locking feature (> page 85) before towing. You could otherwise lock yourself out of the vehicle when pushing or towing the vehicle. Deactivate tow-away protection before towing.

### Installing/removing the towing eye

#### Installing the towing eye

- Remove the towing eye from the vehicle tool kit (> page 324).

#### Warning

The exhaust tail pipe may be hot. You could burn yourself if you touch the tail pipe. Be

particularly careful when removing the rear cover.

The mountings for the removable towing eyes are located in the bumpers. They are at the front and at the rear, behind the covers.

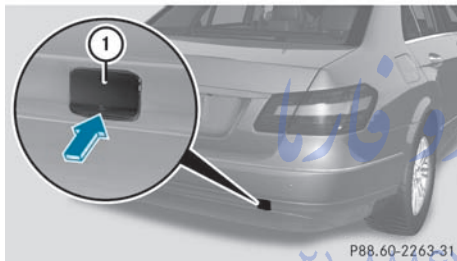
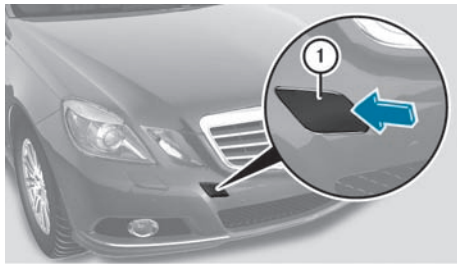

Example: Sedan

- ▶ Press the mark on cover ① inwards, in the direction of the arrow.
- ▶ Take cover ① off the opening.
- ▶ Screw in and tighten the towing eye clockwise to the stop.

### Removing the towing eye

- ▶ Unscrew and remove the towing eye.
- ▶ Attach cover ① to the bumper and press until it engages.
- ▶ Place the towing eye in the vehicle tool kit.

### Towing the vehicle with the rear axle raised

**Only possible for vehicles without 4MATIC.**

When having your vehicle towed with the rear axle raised, observe the important safety notes (▷ page 343).

**!** The ignition must be switched off if you are towing the vehicle with the rear axle raised. Intervention by ESP® could otherwise damage the brake system.

- ▶ Switch on the hazard warning flashers (▷ page 122).
- ▶ Turn the SmartKey to position **0** in the ignition lock and remove the SmartKey.
- ▶ When leaving the vehicle, take the SmartKey or the KEYLESS-GO key with you.

### Towing vehicles with both axles on the ground

When having your vehicle towed, observe the important safety notes (▷ page 343).

#### **⚠ Warning**

With the engine not running, there is no power assistance for the brake and steering systems. In this case, it is important to keep in mind that a considerably higher degree of effort is necessary to brake and steer the vehicle. Adapt your driving accordingly.

The automatic transmission automatically shifts to position **P** when you open the driver's or front-passenger door or when you remove the SmartKey from the ignition lock. In order to ensure that the automatic transmission stays in position **N** when towing, do the following:

- ▶ Make sure that the vehicle is stationary and that the SmartKey is in position **0** in the ignition lock.
- ▶ Turn the SmartKey to position **2** in the ignition lock.  
On vehicles with KEYLESS-GO, use the SmartKey instead of the Start/Stop button (▷ page 150).
- ▶ Depress and hold the brake pedal.



- ▶ Shift the automatic transmission to position **N**.
- ▶ **Vehicles with manual transmission:** depress the clutch pedal.
- ▶ Shift to neutral.
- ▶ Release the brake pedal.
- ▶ Release the parking brake.
- ▶ Switch on the hazard warning flashers (▷ page 122).
- ▶ Leave the SmartKey inserted in the ignition lock in position **2**.

**i** When towing with the hazard warning flashers switched on, use the combination switch as usual to signal in which direction you are changing. In this case, only the indicator lamps for the direction of travel flash. When you reset the combination switch, the hazard warning flashers start flashing again.

### Transporting the vehicle

The towing eye can be used to pull the vehicle onto a trailer or transporter for transporting purposes.

- ▶ Turn the SmartKey to position **2** in the ignition lock.
- ▶ Shift the automatic transmission to position **N**.

### As soon as the vehicle has been loaded:

- ▶ Prevent the vehicle from rolling away by applying the parking brake.
- ▶ Shift the automatic transmission to position **P**.
- ▶ Turn the SmartKey to position **0** in the ignition lock and remove the SmartKey.
- ▶ Secure the vehicle.

**!** Only lash the vehicle down by the wheels or wheel rims, not by parts of the vehicle such as axle or steering components. Otherwise, the vehicle could be damaged.

## Fuses

### Important safety notes

The fuses in your vehicle serve to close down faulty circuits. If a fuse blows, all the components on the circuit and their functions will fail.

### Warning

Only use fuses approved by Mercedes-Benz with the specified amperage for the system in question and do not attempt to repair or bridge a blown fuse. Using other than approved fuses or using repaired or bridged fuses may cause an overload leading to a fire, and/or cause damage to electrical components and/or systems. Have the cause determined and remedied by an authorized Mercedes-Benz Center.

Blown fuses must be replaced with fuses of the same rating, which you can recognize by the color and value. The fuse ratings are listed in the fuse allocation chart. An authorized Mercedes-Benz Center will be happy to advise you.

**i** If a fuse has blown, visit a breakdown service or an authorized Mercedes-Benz Center.

If the newly inserted fuse also blows, have the cause traced and rectified at a qualified specialist workshop, e.g. an authorized Mercedes-Benz Center.

**!** Only use fuses that have been approved for Mercedes-Benz vehicles and which have the correct fuse rating for the system concerned. Otherwise, components or systems could be damaged.

### Before changing a fuse

- ▶ Park the vehicle and apply the parking brake.
- ▶ Switch off all electrical consumers.
- ▶ Remove the key from the ignition lock.

The fuses are located in various fuse boxes:

- fuse box in the engine compartment on the left-hand side of the vehicle, when viewed in the direction of travel
- fuse box in the trunk/cargo compartment on the right-hand side of the vehicle, when viewed in the direction of travel

The fuse allocation chart is located in the vehicle tool kit (▷ page 324) in the stowage compartment under the trunk/trunk floor.

### Fuse box in the engine compartment

- ▶ Make sure that the windshield wipers are turned off.

#### Risk of injury

Make sure that the windshield wipers are turned off and the key is pulled out of the ignition lock before you open the cover of the fuse box. Otherwise, the windshield wipers and the wiper rods above the cover could be set in motion. This could lead to you or others being injured by the wiper rods.

- ▶ Open the hood (▷ page 308).

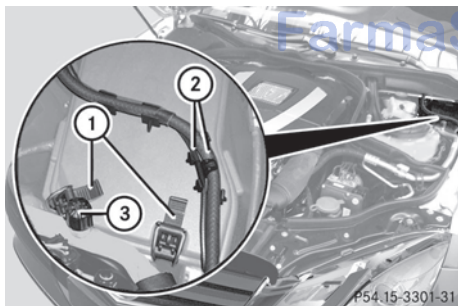

- ▶ Remove any existing moisture from the fuse box using a dry cloth.
- ▶ Take lines ② from the guides.
- ▶ Move aside lines ②. Route the lines behind connection ③ to do this.
- ▶ **To open:** open clamps ①.
- ▶ Remove the fuse box cover forwards.

- ▶ **To close:** check whether the rubber seal is lying correctly in the cover.
- ▶ Insert the cover at the rear of the fuse box into the retainer.
- ▶ Fold down the cover and close clamps ①.
- ▶ Secure lines ② in the guides.

**!** The cover must be seated properly, otherwise moisture or dirt could impair the function of the fuses.

- ▶ Close the hood (▷ page 309).

### Fuse box in the trunk

- ▶ Open the trunk lid.

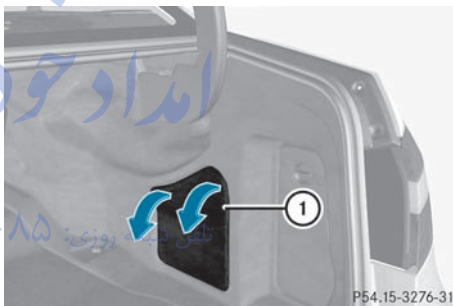

- ▶ **To open:** release cover ① at the top right and left-hand sides with a flat object.
- ▶ Open cover ① downwards in the direction of the arrow.

### Fuse box in the cargo compartment

- ▶ Open the tailgate.

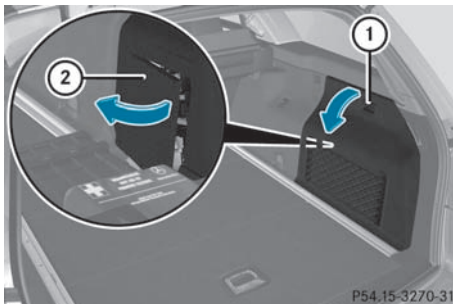

- ▶ **To open:** pull handle ①.
- ▶ Open the cover downwards.
- ▶ Fold trim ② forwards.

امداد خودرو فارما

تلفن شبانه روزی: ۰۲۱-۸۸۸۶۲۰۸۵

FarmaSOS.com

# امداد خودرو فارما

تلفن شبانه روزی: ۰۲۱-۸۸۸۶۲۰۸۵

**FarmaSOS.com**

Vehicle equipment .....	350
Important safety notes .....	350
Directives to be observed .....	351
Maintenance and care of wheels and tires .....	351
Tire pressures .....	352
Loading the vehicle .....	360
Maximum tire load .....	365
Direction of rotation .....	365
Uniform Tire Quality Grading Standards .....	365
Interchanging the wheels .....	367
Tire labeling .....	367
Definitions for tires and loading .....	371
Wheel/tire combinations .....	374

# امداد خودرو فارما

تلفن شبانه روزی: ۰۲۱-۸۸۸۶۲۰۸۵

[FarmaSOS.com](http://FarmaSOS.com)

## Vehicle equipment

- i** This manual describes all the standard and optional equipment of your vehicle which was available at the time of purchase. Country-specific differences are possible. Bear in mind that your vehicle may not feature all functions described here. This also refers to safety-related systems and functions.

## Important safety notes

Contact an authorized Mercedes-Benz Center if you require information on tested and recommended tires and wheels for summer and winter driving. Advice on purchasing and caring for tires is also available there.

### Warning

Replace rims or tires with the same designation, manufacturer and type as shown on the original part. For further information contact an authorized Mercedes-Benz Center. If incorrectly sized rims and tires are mounted, the wheel brakes or suspension components can be damaged. Also, the operating clearance of the wheels and the tires may no longer be correct.

### Warning

Worn, old tires can cause accidents. If the tire tread is worn to minimum tread depth, or if the tires have sustained damage, replace them.

When replacing rims, only use genuine Mercedes-Benz wheel bolts specified for the particular rim type. Failure to do so can result in the bolts loosening and possibly an accident.

Retreaded tires are not tested or recommended by Mercedes-Benz, since previous damage cannot always be recognized on retreads. The operating safety of the vehicle cannot be assured when such tires are used.

### Warning

If you feel a sudden significant vibration or ride disturbance, or you suspect that possible damage to your vehicle has occurred, you should turn on the hazard warning flashers, carefully slow down, and drive with caution to an area which is a safe distance from the road. Inspect the tires and the vehicle underbody for possible damage. If the vehicle appears unsafe, have the vehicle towed to the nearest authorized Mercedes-Benz Center or tire dealer for repairs.

### Warning

Do not drive with a flat tire. A flat tire affects the ability to steer or brake the vehicle. You might lose control of the vehicle. Continued driving with a flat tire or driving at high speed with a flat tire will cause excessive heat build-up and possibly a fire.

- i** For safety reasons, Mercedes-Benz recommends that you only use tires, wheels and accessories which have been approved by Mercedes-Benz specifically for your vehicle. These tires have been specially adapted for use with the control systems, such as ABS or ESP®, and are marked as follows:

- MO = Mercedes-Benz Original
- MOE = Mercedes-Benz Original Extended (tires with run-flat characteristics)
- MO1 = Mercedes-Benz Original (AMG)

Only use Mercedes-Benz Original Extended tires on wheels that have been specifically approved by Mercedes-Benz.

If you use other tires, wheels and accessories, Mercedes-Benz cannot accept any responsibility for damage that may result from this. Further information about tires, wheels and approved combinations can be obtained from any authorized Mercedes-Benz Center.

- i** Further information about tires and wheels can be obtained from any authorized Mercedes-Benz Center.

### Directives to be observed

- Only mount tires and wheels of the same type and make.
- Only mount tires of the correct size onto the wheels.
- After mounting new tires, run them in at moderate speeds for the first 60 miles (100 km) as they only reach their full performance after this distance.
- Do not use tires until they are excessively worn as the tire traction on wet road surfaces decreases significantly when the tread depth is less than  $\frac{1}{8}$  in (3 mm).
- If the vehicle is heavily laden, check the tire pressure and adjust it if necessary.
- When parking your vehicle, make sure that the tires do not get deformed by the curb or other obstacles. If it is necessary to drive over curbs, speed humps or similar elevations, try to do so slowly and at an obtuse angle. Otherwise, the tires, particularly the sidewalls, can get damaged.

### Maintenance and care of wheels and tires

#### Checking wheels and tires

##### Warning

Regularly check the tires for damage. Damaged tires can cause tire inflation pressure loss. As a result, you could lose control of your vehicle.

Worn, old tires can cause accidents. If the tire tread is worn to minimum tread depth, or if the tires have sustained damage, replace them.

- Regularly check the wheels and tires of your vehicle for damage (e.g. cuts, punctures, tears, bulges on tires and deformation or cracks or severe corrosion on wheels), at least once a month, as well as after driving off-road or on rough roads.

Damaged wheels can cause a loss of tire pressure.

- Regularly check the tire tread depth and the condition of the tread across the whole width of the tire (▷ page 35 1). If necessary, turn the front wheels to full lock in order to inspect the inner side of the tire surface.
- All wheels must have a valve cap to protect the valve against dirt and moisture. Do not install anything on the valve (such as tire pressure monitoring systems) other than the standard valve cap or other valve caps approved by Mercedes-Benz for your vehicle.
- Regularly check the pressure of all the tires including the emergency spare wheel or the spare wheel, particularly prior to long trips, and correct the pressure as necessary (▷ page 352).

#### Service life of tires

The service life of tires depends on the following factors amongst other things:

- driving style
- tire pressure
- mileage

Replace the tires after six years at the latest, regardless of wear. This also applies to the emergency spare wheel/spare wheel.

#### Tire tread

##### Warning

Although the applicable federal motor vehicle safety laws consider a tire to be worn when the tread wear indicators (TWI) become visible at approximately  $\frac{1}{16}$  in (1.6 mm), we recommend that you do not allow your tires to wear down to that level. As tread depth approaches  $\frac{1}{8}$  in (3 mm), the adhesion properties on a wet road are sharply reduced.



Depending upon the weather and/or road surface (conditions), the tire traction varies widely.

Do not use tires until they are excessively worn as the tire traction on wet road surfaces decreases significantly when the tread depth is less than  $\frac{1}{8}$  in (3 mm).

Tread wear indicators (TWI) are required by law. Six indicators are positioned over the tire tread. They are visible as soon as a tread depth of approximately  $\frac{1}{16}$  in (1.6 mm) is reached. If this is the case, the tire is so worn that it must be replaced.

The recommended tread depth for summer tires is at least  $\frac{1}{8}$  in (3 mm). The recommended tread depth for winter tires is at least  $\frac{1}{6}$  in (4 mm).

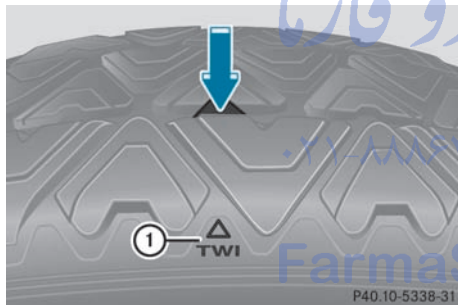

Bar marking ① for tread wear is integrated into the tire tread.

### Storing tires

Store tires that are not being used in a cool, dry and preferably dark place. Protect the tires from contact with oil, grease and fuel.

### Cleaning tires

#### ⚠ Warning

Do not use power washers with circular jet nozzles (concentrated-power jets) to clean your vehicle, especially for cleaning tires. You

could otherwise damage the tires and cause an accident.

## Tire pressures

### Recommended tire pressures

#### ⚠ Warning

Follow recommended tire inflation pressures.

Do not underinflate tires. Underinflated tires wear excessively and/or unevenly, adversely affect handling and fuel economy, and are more likely to fail from being overheated.

Do not overinflate tires. Overinflated tires can adversely affect handling and ride comfort, wear unevenly, increase stopping distance, and result in sudden deflation (blowout) because they are more likely to become punctured or damaged by road debris, potholes etc.

Do not overload the tires by exceeding the specified load limit as indicated on the Tire and Loading Information placard on the driver's door B-pillar. Overloading the tires can overheat them, possibly causing a blowout. Overloading the tires can also result in handling or steering problems, or brake failure.

You will find a table of recommended tire pressures on the Tire and Loading Information placard on the B-pillar on the driver's side (> page 360). You will find a table of tire pressures for various operating conditions on the inside of your vehicle's fuel filler flap.

Use a suitable pressure gauge. The outer appearance of a tire does not permit any reliable conclusion about the tire pressure. On vehicles equipped with the electronic tire pressure monitor, the tire pressure can be checked using the on-board computer.

#### ⚠ Warning

Should the tire pressure drop repeatedly:

- check the tire for foreign bodies.
- check whether the wheel is losing air or the valve is leaking.
- make sure that only a valve cap approved by Mercedes-Benz is installed on the tire valve.

Tire pressures that are too low have a negative effect on vehicle safety, which could lead you to cause an accident.

Only correct tire pressures when the tires are cold. The tires are cold when the vehicle has been parked for at least three hours or driven for less than 1 mile (1.6 km). The tire temperature changes depending on the outside temperature, the vehicle speed and the tire load. If the tire temperature changes by 18 °F (10 °C), the tire pressure changes by approximately 10 kPa (0.1 bar / 1.5 psi). Take this into account when checking the pressure of warm tires and only correct the tire pressure if it is too low for the current operating conditions. If you check the tire pressure when the tires are warm, the reading will be higher than if the tires were cold. This is normal. Do not reduce the tire pressure to the value specified for cold tires. The tire pressure would otherwise be too low. Observe the recommended tire pressure specifications for cold tires on the Tire and Loading Information placard on the B-pillar on the driver's side.

**i** The specifications given on the following Tire and Loading Information placard are examples. Tire pressure specifications are vehicle-specific and may deviate from the data shown here. The tire pressure specifications for your vehicle can be found on the Tire and Loading Information placard of your vehicle.

TIRE		LOADING INFORMATION	
RENSEIGNEMENTS		POUR LES PNEUS ET LE CHARGEMENT	
SEATING CAPACITY NOMBRE DE SIÈGES	7	FRONT AVANT	MIDDLE MILIEU
The combined weight of occupants and cargo should never exceed XXXX kg or XXXX lbs. Le poids total des occupants et des marchandises ne doit jamais dépasser XXXX kg ou XXXX lb.		REAR ARRIÈRE	2
TIRE PNEU	SIZE TAILLE	COLD TIRE PRESSURE PRESSION DES PNEUS À FROID	SEE OWNERS MANUAL FOR ADDITIONAL INFORMATIONS
FRONT AVANT	256/40 ZR18 99Y XL	200 KPA, 29 PSI	
REAR ARRIÈRE	285/35 ZR18 101Y XL	200 KPA, 29 PSI	
SPARE DE RECHANGE	175/55-18 99P	420 KPA, 40 PSI	

P40.00-2133-31

You will find recommended tire pressure specifications **1** for cold tires and for a fully loaded vehicle on the Tire and Loading Information placard. The tire pressure specifications apply to tires which are installed at the factory.

### Important notes on tire pressures

#### Warning

If the tire pressure drops repeatedly, check the tires for punctures from foreign objects and/or whether air is leaking from the valves or from around the rim.

The temperature and pressure of the tires increase when the vehicle is in motion. This is dependent on the driving speed and the load.

If you wish to drive at high speeds of 100 mph (160 km/h) or higher when this is allowed, use the tire pressure table on the inside of the fuel filler flap to set the correct tire pressures when the wheels are cold. If the tire pressure is not set correctly, this can lead to an excessive build up of heat and a sudden loss of pressure.

For more information, contact a qualified specialist workshop, e.g. an authorized Mercedes-Benz Center.

**i** Ride comfort may be affected if the tire pressure is adjusted to the recommended value for speeds of over 100 mph (160 km/h).

Make sure that the tire pressure for normal speeds is adopted again.

Additional specifications of tire pressure values for loads can also be found on the tire pressure table on the inside of the fuel filler flap.

The tire pressure for emergency spare wheels can be found:

- on the yellow label on the wheel rim of the emergency spare wheel
- in the "Wheel and tire combinations" section (▷ page 374) of this Operator's Manual
- on the Tire and Loading Information placard on the B-pillar on the driver's side

**i** The specifications shown in the examples in the tire pressure tables are only examples. Tire pressure specifications are vehicle-specific and may deviate from the data shown here. The tire pressure specifications that are valid for your vehicle can be found on your vehicle's tire pressure table.

The tire pressures in the tire pressure table on the inside of the fuel filler flap are valid for all approved tires installed at the factory, unless stated otherwise.

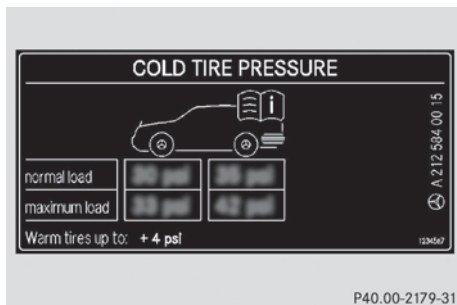

Tire pressure table for all approved tires installed at the factory (example)

If the tire pressure precedes a tire size, the tire pressure specification is only valid for this tire size. The vehicle loading conditions "partially laden" or "fully laden" are specified using a differing number of persons and

luggage in the table. The actual number of seats may differ from this.

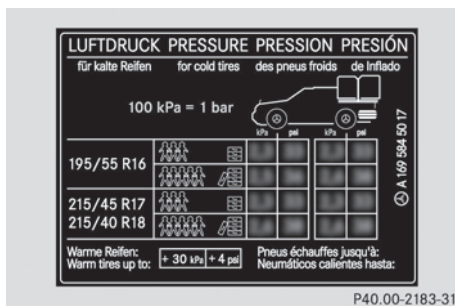

Tire pressure table with tire sizes (example)

Some tire pressure tables only show the rim diameter instead of the complete tire size, e.g. **R18**. The rim diameter is a component of the tire size and can be read from the tire sidewall (▷ page 368).

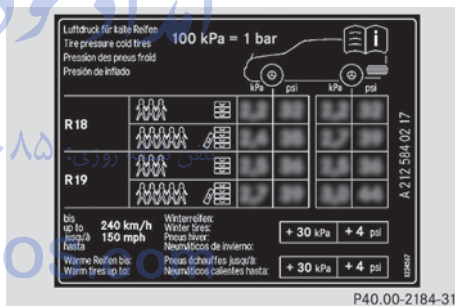

## Tire pressure too low or too high

### Underinflated tires

#### **Warning**

Follow recommended tire inflation pressures. Do not underinflate tires. Underinflated tires wear excessively and/or unevenly, adversely affect handling and fuel economy, and are more likely to fail from being overheated.

Underinflated tires can:

- wear excessively and/or unevenly
- adversely affect fuel economy

- fail from being overheated
- adversely affect handling

### Overinflated tires can:

#### Warning

Follow recommended tire inflation pressures.

Do not overinflate tires. Overinflated tires can adversely affect handling and ride comfort, wear unevenly, increase stopping distance, and result in sudden deflation (blowout) because they are more likely to become punctured or damaged by road debris, potholes etc.

Overinflated tires can:

- adversely affect handling
- wear excessively and/or unevenly
- be more likely to become damaged
- adversely affect ride comfort
- increase stopping distance

### Checking tire pressures

#### Important safety notes

#### Warning

Follow recommended tire inflation pressures.

Do not underinflate tires. Underinflated tires wear excessively and/or unevenly, adversely affect handling and fuel economy, and are more likely to fail from being overheated.

Do not overinflate tires. Overinflated tires can adversely affect handling and ride comfort, wear unevenly, increase stopping distance, and result in sudden deflation (blowout) because they are more likely to become punctured or damaged by road debris, potholes etc.

Do not overload the tires by exceeding the specified load limit as indicated on the Tire and Loading Information placard on the driver's door B-pillar. Overloading the tires can overheat them, possibly causing a blowout. Overloading the tires can also result

in handling or steering problems, or brake failure.

Check the tire pressure at least once a month. Only check and correct tire pressures when the tires are cold (> page 352).

### Checking the tire pressures manually

In order to determine and adjust the tire pressures, proceed as follows:

- ▶ Remove the valve cap of the tire you wish to check.
- ▶ Press the tire pressure gauge securely onto the valve.
- ▶ Read the tire pressure and compare it with the recommended value on the Tire and Loading Information placard on the B-pillar on the driver's side of your vehicle.
  - ▶ If necessary, increase the tire pressure to the recommended value (> page 352).
  - ▶ If the tire pressure is too high, release air by pressing down the metal pin in the valve using the tip of a pen, for example. Then, check the tire pressure again using the tire pressure gauge.
- ▶ Screw the valve cap onto the valve.
- ▶ Repeat the steps for the other tires.

### Tire pressure loss warning system (Canada only)

#### Important safety notes

While the vehicle is in motion, the tire pressure loss warning system monitors the set tire pressure using the rotational speed of the wheels. This enables the system to detect significant pressure loss in a tire. If the speed of rotation of a wheel changes as a result of a loss of pressure, a corresponding warning message will appear in the multifunction display.

**⚠ Warning**

If the Check Tire Pressure Soon message appears in the multifunction display, one or more tires are significantly underinflated. Stop the vehicle as soon as possible and inflate the tires to the pressure specified on the vehicle's Tire and Loading Information placard or (where available) in the tire pressure table.

Driving on a significantly underinflated tire causes the tire to overheat and can lead to tire failure. Underinflation also reduces fuel efficiency and tire tread life, and may affect the vehicle's handling and stopping ability.

Check all tires when cold, including the spare tire, at least once a month. The tires should be inflated to the recommended pressure.

This information can be found:

- on the Tire and Loading Information placard on the B-pillar on the driver's side  
or
- in the table for the tire pressure on the inside of the fuel filler flap

**⚠ Warning!**

The tire pressure loss warning system does not provide a warning for wrongly selected tire inflation pressures. Always adjust tire inflation pressure according to the Tire and Loading Information placard on the driver's door B-pillar or on the tire inflation pressure label located on the inside of the fuel filler flap.

The tire pressure loss warning system does not replace regular checks of the tire inflation pressures since a gradual pressure loss in more than one tire cannot be detected by the tire pressure loss warning system.

The tire pressure loss warning system is not able to issue a warning due to a sudden dramatic loss of tire inflation pressure (e.g. tire blowout caused by a foreign object). In this case bring the vehicle to a halt by carefully applying the brakes and avoiding abrupt steering maneuvers.

The function of the tire pressure loss warning system is limited or delayed if:

- snow chains are mounted on your vehicle.
- road conditions are wintry.
- you are driving on sand or gravel.
- you adopt a very sporty driving style (cornering at high speeds or driving with high rates of acceleration).
- you are driving with a heavy cargo (in the vehicle or on the roof).

**Restarting the tire pressure loss warning system**

Restart the tire pressure loss warning system if you have:



- changed the tire pressure
  - changed the wheels or tires
  - mounted new wheels or tires
- Before restarting, refer to the Tire and Loading Information placard on the B-pillar on the driver's side or the tire pressure table on the inside of the fuel filler flap to ensure the tire pressure in all four tires is set correctly for the current operating conditions.
- Observe the notes in the section on tire pressures (▷ page 352).



**⚠ Warning**

The tire pressure loss warning system can only give reliable warnings if you have set the correct tire pressure.





If an incorrect tire pressure is set, these incorrect values will be monitored.

A tire with insufficient pressure results in vehicle instability when driving, thus increasing the risk of an accident.

- Make sure that the SmartKey is in position **2** (▷ page 149) in the ignition lock.
- Press the  or  button to select the Service menu.





- ▶ Press the  or  button to select Tire Pressure.
- ▶ Press the  button.  
The Run Flat Indicator Active Press 'OK' to Restart message appears in the multifunction display.

#### If you wish to confirm the restart:

- ▶ Press the  button.  
The Tire Pressure Now OK? message appears in the multifunction display.
- ▶ Press  or  to select Yes.
- ▶ Press the  button.  
The Run Flat Indicator Restarted message appears in the multifunction display.

After a teach-in period, the tire pressure loss warning system will monitor the set tire pressures of all four tires.

#### If you wish to cancel the restart:

- ▶ Press the  button.
- or
- ▶ If the message: Tire Pressure now OK? appears, use  or  to select Cancel.
  - ▶ Press the  button.  
The tire pressure values stored at the last restart will continue to be monitored.

### Tire pressure monitoring system

#### Important safety notes

If a tire pressure monitor is installed, the vehicle's wheels have sensors installed that monitor the tire pressures in all four tires. The tire pressure monitor warns you when the pressure drops in one or more of the tires. The tire pressure monitor only functions if the correct wheel electronics units are installed in all wheels.

The tire pressure monitor has a yellow warning lamp in the instrument cluster for indicating pressure loss/malfunctions (USA) or pressure loss (Canada). Depending on how the warning lamp flashes or lights up, a tire pressure that is too low or a malfunction in the tire pressure monitor is displayed:

- if the warning lamp is lit continuously, the tire pressure on one or more tires is significantly too low. The tire pressure monitor is not malfunctioning.
- USA only: if the warning lamp flashes for 60 seconds and then remains lit constantly, the tire pressure monitor is malfunctioning.

#### Warning

Each tire, including the spare (if provided), should be checked at least once a month when cold and inflated to the inflation pressure recommended by the vehicle manufacturer on the Tire and Loading Information placard on the driver's door B-pillar or the tire inflation pressure label on the inside of the fuel filler flap. If your vehicle has tires of a different size than the size indicated on the Tire and Loading Information placard or the tire inflation pressure label, you should determine the proper tire inflation pressure for those tires.

As an added safety feature, your vehicle has been equipped with a tire pressure monitoring system (TPMS) that illuminates a low tire pressure telltale when one or more of your tires are significantly underinflated.

Accordingly, when the low tire pressure telltale illuminates, you should stop and check your tires as soon as possible, and inflate them to the proper pressure. Driving on a significantly underinflated tire causes the tire to overheat and can lead to tire failure.

Underinflation also reduces fuel efficiency and tire tread life, and may affect the vehicle's handling and stopping ability. Please note that the TPMS is not a substitute for proper tire maintenance, and it is the driver's responsibility to maintain correct tire pressure, even if underinflation has not



reached the level to trigger illumination of the TPMS low tire pressure telltale.

USA only:

Your vehicle has also been equipped with a TPMS malfunction indicator to indicate when the tire pressure monitoring system is not operating properly. The TPMS malfunction indicator is combined with the low tire pressure telltale. When the system detects a malfunction, the telltale will flash for approximately one minute and then remain continuously illuminated. This sequence will continue upon subsequent vehicle start-ups as long as the malfunction exists. When the malfunction indicator is lit, the system may not be able to detect or signal low tire pressure as intended.

TPMS malfunctions may occur for a variety of reasons, including the installation of incompatible replacement or alternate tires or wheels on the vehicle that prevent the TPMS from functioning properly. Always check the TPMS malfunction telltale after replacing one or more tires or wheels on your vehicle to ensure that the replacement or alternate tires and wheels allow the TPMS to continue to function properly.

**i** USA only:

If the tire pressure monitor is malfunctioning, it may take more than 10 minutes for the tire pressure warning lamp to inform you of the malfunction by flashing for 60 seconds and then remaining lit.

When the malfunction has been rectified, the tire pressure warning lamp goes out after driving for a few minutes.

Information on tire pressures is displayed in the multifunction display. After a few minutes of driving, the current tire pressure of each tire is shown in the multifunction display.

**i** The tire pressure values indicated by the on-board computer may differ from those measured at a gas station with a pressure gauge. The tire pressures shown by the on-

board computer refer to those measured at sea level. At high altitudes, the tire pressure values indicated by a pressure gauge are higher than those shown by the on-board computer. In this case, do not reduce the tire pressures.

**i** The operation of the tire pressure monitor can be affected by interference from radio transmitting equipment (e.g. radio headphones, two-way radios) that may be operated in or near the vehicle.

**i** USA only:

This device complies with Part 15 of the FCC Rules. Operation is subject to the following two conditions:

1. This device may not cause harmful interference, and
2. This device must withstand any interference received, including interference that may cause undesired operation.

Unauthorized modifications to the device could void the user's authority to operate the equipment.



**i** Canada only:

This device complies with the RSS-210 Rules from Industry Canada. Operation is subject to the following two conditions:

1. This device may not cause harmful interference, and
2. This device must accept any interference received, including interference that may cause undesired operation.

Unauthorized modifications to the device could void the user's authority to operate the equipment.

### Checking tire pressure electronically

- ▶ Make sure that the SmartKey is in position **2** (▷ page 149) in the ignition lock.
- ▶ Press the  or  button to select the Serv. menu.



▶ Press the  or  button to select Tire Pressure.

▶ Press the  button.

The current tire pressure for each wheel will be displayed in the multifunction display.

If the vehicle has been parked for longer than 20 minutes, the Tire pressures will be displayed after driving a few minutes message appears in the display.

After a teach-in period, the tire pressure monitor automatically recognizes new wheels or new sensors. As long as a clear allocation of the tire pressure values to the individual wheels is not possible, the Tire Pressure Monitor Active message is shown instead of the tire pressure display. The tire pressures are already being monitored.

- i** If a spare wheel/emergency spare wheel is mounted, the system may continue to show the tire pressure of the wheel that has been removed for a few minutes. If this occurs, note that the value displayed for the position where the spare wheel is mounted is not the same as the spare wheel/emergency spare wheel's current tire pressure.

### TPMS warning messages

If the tire pressure monitor detects a significant pressure loss on one or more tires, a warning message is shown in the multifunction display. A warning tone also sounds and the tire pressure warning lamp lights up in the instrument cluster.

Each tire that is affected by a significant loss of pressure is highlighted by a red rectangle.

If the Correct Tire Pressure message appears in the multifunction display:

▶ Check the tire pressure on all four wheels and correct it if necessary.

- i** If the wheel positions on the vehicle are interchanged, the tire pressures may be displayed for the wrong positions for a short time. This is rectified after a few

minutes of driving, and the tire pressures are displayed for the correct positions.

### Restarting the tire pressure monitor

#### Warning





It is the driver's responsibility to set the tire inflation pressure to the recommended cold tire inflation pressure. Underinflated tires affect the ability to steer or brake the vehicle. You might lose control over the vehicle.

When you restart the tire pressure monitor, all existing warning messages are deleted and the warning lamps go out. The monitor uses the currently set tire pressures as the reference values for monitoring.

The TPMS must be restarted when you set the tire pressure to a new value (as a result of changed handling or load characteristics, for example). The TPMS then monitors the new tire pressure values.

- i** Canada only: in most cases, the tire pressure monitor recognizes the new reference values automatically. However, you can also define reference values manually as described here.

Restart the tire pressure monitor after you have set the tire pressure to the value recommended for the desired driving situation (▶ page 352). Only correct tire pressures on cold tires. Comply with the recommended tire pressures on the Tire and Loading Information placard on the B-pillar on the driver's side. Additional tire pressure values for driving at high speeds or with heavy loads can be found in the Tire Pressure table on the inside of the fuel filler flap.

- ▶ Make sure that the tire pressure is correct on all four wheels.
- ▶ Make sure that the SmartKey is in position 2 in the ignition lock.
- ▶ Press the  or  button to select the Serv. menu.
- ▶ Press the  or  button to select Tire Pressure.

- ▶ Press the **OK** button.  
The current tire pressure of each wheel or the Tire pressures will be displayed after driving a few minutes message is shown in the multifunction display.
- ▶ Press the **▼** button.  
The Use Current Pressures as New Reference Values message appears in the multifunction display.

#### If you wish to confirm the restart:

- ▶ Press the **OK** button.  
The Tire Press. Monitor Restarted message appears in the multifunction display.  
After driving for a few minutes, the system checks whether the current tire pressures are within the specified range. The new tire pressures are then accepted as reference values and monitored.

#### If you wish to cancel the restart:

- ▶ Press the **↩** button.  
The tire pressure values stored at the last restart will continue to be monitored.

### Maximum tire pressures

#### Warning

Never exceed the maximum tire inflation pressure. Follow recommended tire inflation pressures.

Do not underinflate tires. Underinflated tires wear excessively and/or unevenly, adversely affect handling and fuel economy, and are more likely to fail from being overheated.

Do not overinflate tires. Overinflated tires can adversely affect handling and ride comfort, wear unevenly, increase stopping distance, and result in sudden deflation (blowout) because they are more likely to become punctured or damaged by road debris, potholes etc.

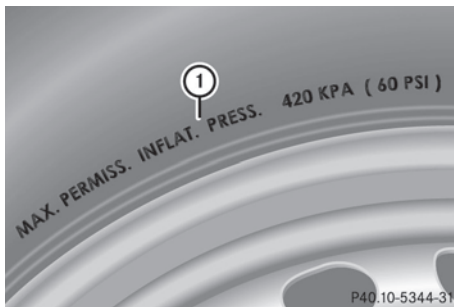

- ① Maximum permitted tire pressure (example)
- i** The actual values for tires are specific to each vehicle and may deviate from the values in the illustration.

When adjusting the tire pressures always observe the recommended tire pressure for your vehicle (▶ page 352).

### Loading the vehicle

#### Instruction labels for tires and loads

#### Warning

Do not overload the tires by exceeding the specified load limit as indicated on the Tire and Loading Information placard on the driver's door B-pillar. Overloading the tires can overheat them, possibly causing a blowout. Overloading the tires can also result in handling or steering problems, or brake failure.

Two instruction labels on your vehicle show the maximum possible load.

- (1) The Tire and Loading Information placard is on the B-pillar on the driver's side. The Tire and Loading Information placard shows the permissible number of occupants and the maximum permissible vehicle load. It also contains details of the

tire sizes and corresponding pressures for tires mounted at the factory.

- (2) The vehicle identification plate is on the B-pillar on the driver's side. The vehicle identification plate informs you of the gross vehicle weight rating. It is made up of the vehicle weight, all vehicle occupants, the fuel and the cargo. You can also find information about the maximum gross axle weight rating on the front and rear axle.

The maximum gross axle weight rating is the maximum weight that can be carried by one axle (front or rear axle). Never exceed the maximum load or the maximum gross axle weight rating for the front or rear axle.

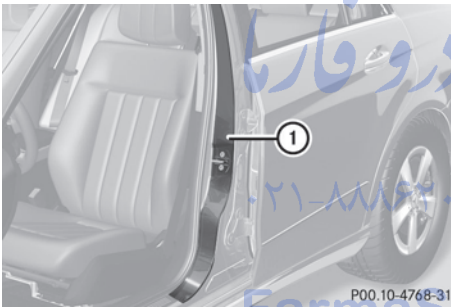

B-pillar (example: Sedan)

- ① B-pillar, driver's side

### Maximum permissible gross vehicle weight rating

- ① The data in the illustration of the Tire and Loading Information placard is an example. The maximum permissible gross vehicle weight rating is vehicle-specific and may differ from that which is illustrated. You can find the valid maximum permissible gross vehicle weight rating for your vehicle on the Tire and Loading Information placard.

TIRE / PNEU	SIZE / TAILLE	COLD TIRE PRESSURE / PRESSION DES PNEUS A FROID	SEE OWNERS MANUAL FOR ADDITIONAL INFORMATION
FRONT / AVANT	255/40 ZR18 99YXL	200 KPA, 29 PSI	SEE OWNERS MANUAL FOR ADDITIONAL INFORMATION
REAR / ARRIERE	285/35 ZR18 101YXL	200 KPA, 29 PSI	
SPARE / DE RECHANGE	175/55-18 95P	420 KPA, 60 PSI	

SEATING CAPACITY / NOMBRE DE SEGES: TOTAL 7, FRONT 2, MIDDLE 2, REAR 3

WARNING: The combined weight of occupants and cargo should never exceed XXXX kg or XXXX lbs. / Le poids total des occupants et des marchandises ne doit jamais dépasser XXXX kg ou XXXX lbs.

P40.00-2131-31

- The Tire and Loading Information placard gives you details on maximum permissible gross vehicle weight rating ①: "The gross weight of occupants and luggage must never exceed XXX kilograms or XXX pounds."

The gross weight of all vehicle occupants, cargo, luggage and trailer load/noseweight (if applicable) must not exceed the specified value.

### Number of seats

- ① The data in the illustration of the Tire and Loading Information placard is an example. The number of seats is vehicle-specific and can differ from the details shown. The number of seats in your vehicle can be found on the Tire and Loading Information placard.

TIRE / PNEU	SIZE / TAILLE	COLD TIRE PRESSURE / PRESSION DES PNEUS A FROID	SEE OWNERS MANUAL FOR ADDITIONAL INFORMATION
FRONT / AVANT	255/40 ZR18 99YXL	200 KPA, 29 PSI	SEE OWNERS MANUAL FOR ADDITIONAL INFORMATION
REAR / ARRIERE	285/35 ZR18 101YXL	200 KPA, 29 PSI	
SPARE / DE RECHANGE	175/55-18 95P	420 KPA, 60 PSI	

SEATING CAPACITY / NOMBRE DE SEGES: TOTAL 7, FRONT 2, MIDDLE 2, REAR 3

WARNING: The combined weight of occupants and cargo should never exceed XXXX kg or XXXX lbs. / Le poids total des occupants et des marchandises ne doit jamais dépasser XXXX kg ou XXXX lbs.

P40.00-2132-31

Maximum number of seats ① determines the maximum number of occupants allowed to travel in the vehicle. This information can be

found on the Tire and Loading Information placard.

امداد خودرو فارما

تلفن شبانه روزی: ۰۲۱-۸۸۸۶۲۰۸۵

FarmaSOS.com

### Determining the maximum load

The following steps have been developed as required of all manufacturers under Title 49, Code of U.S. Federal Regulations, Part 575 pursuant to the "National Traffic and Motor Vehicle Safety Act of 1966".

- ▶ **Step 1:** Locate the statement "The combined weight of occupants and cargo should never exceed XXX kg or XXX lbs." on your vehicle's Tire and Loading Information placard.
- ▶ **Step 2:** Determine the combined weight of the driver and passengers that will be traveling in your vehicle.
- ▶ **Step 3:** Subtract the combined weight of the driver and passengers from XXX kilograms or XXX lbs.
- ▶ **Step 4:** The resulting figure equals the available amount of cargo and luggage load capacity. For example, if the "XXX" amount equals 1400 lbs and there will be five 150 lbs passengers in your vehicle, the amount of available cargo and luggage load capacity is 650 lbs (1400 - 750 (5 x 150) = 650 lbs).
- ▶ **Step 5:** Determine the combined weight of luggage and cargo being loaded on the vehicle. For reasons of safety, that weight must not exceed the available cargo and luggage cargo capacity calculated in step 4.
- ▶ **Step 6 (if applicable):** If you intend to tow a trailer behind your vehicle, the load on the trailer is transferred to your vehicle. Consult this Operator's Manual to determine how this reduces the available cargo and luggage load capacity of your vehicle (▷ page 365).

The following table shows examples of how to calculate total and cargo load capacities with varying seating configurations and number and size of occupants. The following examples use a cargo limit of 1500 lbs (680 kg). **This is for illustration purposes only.** Make sure you always use the actual load limit for your vehicle stated on the vehicle's Tire and Loading Information placard (▷ page 361).

		Example 1	Example 2	Example 3
<b>Step 1</b>	<b>Combined maximum weight of occupants and cargo (data from the Tire and Loading Information placard)</b>	1500 lbs (680 kg)	1500 lbs (680 kg)	1500 lbs (680 kg)

		Example 1	Example 2	Example 3
<b>Step 2</b>	<b>Number of people in the vehicle (driver and occupants)</b>	5	3	1
	<b>Distribution of the occupants</b>	Front: 2 Rear: 3	Front: 1 Rear: 2	Front: 1

		Example 1	Example 2	Example 3
	<b>Weight of the occupants</b>	Occupant 1: 150 lbs (68 kg) Occupant 2: 180 lbs (82 kg) Occupant 3: 160 lbs (73 kg) Occupant 4: 140 lbs (63 kg) Occupant 5: 120 lbs (54 kg)	Occupant 1: 200 lbs (91 kg) Occupant 2: 190 lbs (86 kg) Occupant 3: 150 lbs (68 kg)	Occupant 1: 150 lbs (68 kg)
	<b>Gross weight of all occupants</b>	750 lbs (340 kg)	540 lbs (245 kg)	150 lbs (68 kg)

		Example 1	Example 2	Example 3
<b>Step 3</b>	<b>Permissible cargo and trailer load/noseweight (maximum gross vehicle weight rating from the Tire and Loading Information placard minus the gross weight of all occupants)</b>	1500 lbs (680 kg) - 750 lbs (340 kg) = 750 lbs (340 kg)	1500 lbs (680 kg) - 540 lbs (245 kg) = 960 lbs (435 kg)	1500 lbs (680 kg) - 150 lbs (68 kg) = 1350 lbs (612 kg)

The greater the combined weight of the occupants, the lower the maximum luggage load. Further information can be found under "Towing a trailer" (▷ page 365).

### Vehicle identification plate

Even if you have calculated the total cargo carefully, you should still make sure that the gross vehicle weight rating and the gross axle weight rating are not exceeded. Details can be found on the vehicle identification plate on the B-pillar on the driver's side (▷ page 360).

**Gross vehicle weight:** the gross weight of the vehicle, all passengers, cargo and trailer load/noseweight (if applicable) must not exceed the permissible gross vehicle weight.

**Gross axle weight rating:** the maximum permissible load that can be carried by one axle (front or rear axle).

To ensure that your vehicle does not exceed the maximum permissible values (gross vehicle weight and maximum gross axle weight rating), have your loaded vehicle (including driver, occupants, cargo, and full trailer load if applicable) weighed on a suitable vehicle weighbridge.

### Trailer load/noseweight

The trailer load/noseweight affects the gross weight of the vehicle. If a trailer is attached, the trailer load/noseweight is included in the load along with occupants and luggage. The trailer load/noseweight is usually approximately 10% of the gross weight of the trailer and its cargo.

Your Mercedes-Benz is designed for transporting persons and their luggage. Mercedes-Benz does not recommend towing a trailer with your vehicle.

### Maximum tire load

#### Warning

Do not overload the tires by exceeding the specified load limit as indicated on the Tire and Loading Information placard on the driver's door B-pillar. Overloading the tires can overheat them, possibly causing a blowout. Overloading the tires can also result in handling or steering problems, or brake failure.



- i** The actual values for tires are specific to each vehicle and may deviate from the values in the illustration.

Maximum tire load ① is the maximum permitted weight for which the tire is approved.

Further information on tire loads (▷ page 367).

### Direction of rotation

Tires with a specified direction of rotation have additional benefits, e.g. if there is a risk of hydroplaning. You will only gain these benefits if the correct direction of rotation is observed.

An arrow on the sidewall of the tire indicates its correct direction of rotation.

You may mount an emergency spare wheel/spare wheel against the direction of rotation. Observe the time restriction on use as well as the speed limitation specified on the emergency spare wheel/spare wheel.

### Uniform Tire Quality Grading Standards

#### Overview of tire quality standards

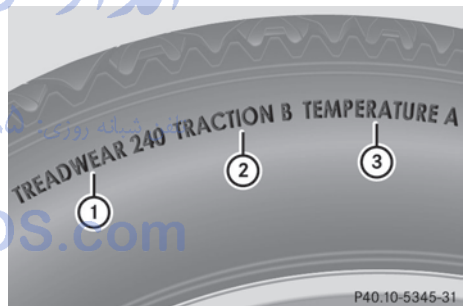

The Uniform Tire Quality Grading Standards are U.S. government specifications. Their purpose is to provide drivers with uniform reliable information on tire performance data. Tire manufacturers have to grade tires using three performance factors: ① tread wear, ② tire traction, and ③ heat resistance. All tires sold in North America are provided with the corresponding quality class mark on the sidewall of the tire, even though these regulations do not apply to Canada.

- i** The actual values for tires are specific to each vehicle and may deviate from the values in the illustration.



Where applicable, the tire grading information can be found on the tire sidewall between the tread shoulder and maximum tire width.

For example:

Tread wear	Traction	Temperature
200	AA	A

All passenger car tires must conform to the statutory safety requirements in addition to these grades.

### Tread wear

The tread wear grade is a comparative rating based on the wear rate of the tire when tested under controlled conditions on a specified U.S. government test track. For example, a tire graded 150 would wear one and one-half times as well on the government test track as a tire graded 100.

The relative performance of tires depends upon the actual conditions of their use, however, and may depart significantly from the norm due to variations in driving habits, service practices and differences in road characteristics and climate conditions.

### Traction

#### Warning

The traction grade assigned to this tire is based on straight-ahead braking traction tests, and does not include acceleration, cornering, hydroplaning, or peak traction characteristics.

The traction grades, from highest to lowest, are AA, A, B, and C. These grades represent the tire's ability to stop on a wet surface as measured under controlled conditions on specified government test surfaces of asphalt and concrete. A tire marked C may have poor traction performance.

#### Warning

If ice has formed on the road, tire traction will be substantially reduced. Under such weather conditions, drive, steer and brake with extreme caution.

The safe speed on a wet, snow covered or icy road is always lower than on dry road surfaces.

You should pay special attention to road conditions when temperatures are around the freezing point.

Mercedes-Benz recommends a minimum tire tread depth of 1/6 in (4 mm) for all four winter tires (> page 175) to maintain normal driving characteristics in winter. Winter tires can reduce the braking distance on snow covered surfaces in comparison to summer tires. The braking distance is still much further than on surfaces that are not icy or covered with snow. Take appropriate care when driving.

 Avoid wheelspin. This can lead to damage to the drive train.

### Temperature

#### Warning

The temperature grade for this tire is established for a tire that is properly inflated and not overloaded. Excessive speed, underinflation, or excessive loading, either separately or in combination, can cause excessive heat build-up and possible tire failure.

The temperature grades are A (the highest), B, and C. These represent the tire's resistance to the generation of heat and its ability to dissipate heat when tested under controlled conditions on a specified indoor laboratory test wheel. Sustained high temperature can cause the material of the tire to degenerate and reduce tire life. Furthermore, excessive temperature can lead to sudden tire failure. Grade C corresponds to a level of performance that all passenger

car tires must meet under Federal Motor Vehicle Safety Standard No. 109. Grades B and A represent higher levels of performance on the laboratory test wheel than the minimum required by law.

## Interchanging the wheels

### Warning

Rotate front and rear wheels only if the tires are of the same dimension.

If your vehicle is equipped with mixed-size tires (different tire dimensions front vs. rear), tire rotation is not possible.

### Warning!

Have the tightening torque checked after changing a wheel. Wheels could become loose if not tightened with a torque of 96 lb-ft (130 Nm).

Only use genuine Mercedes-Benz wheel bolts specified for your vehicle's rims.

The wear patterns on the front and rear tires differ, depending on the operating conditions. Rotate the wheels before a clear wear pattern has formed on the tires. Front tires typically wear more on the shoulders and the rear tires in the center.

If your vehicle's tire configuration allows, you can rotate the wheels according to the intervals in the tire manufacturer's warranty book in your vehicle documents. If no warranty book is available, the tires should be rotated every 3000 to 6000 miles (5000 to 10000 km), or earlier if tire wear requires. Do not change the direction of wheel rotation.

Clean the contact surfaces of the wheel and the brake disc thoroughly every time a wheel is rotated. Check the tire pressures.

Information on changing a wheel and mounting the spare wheel (▷ page 331).

## Tire labeling

### Overview of tire labeling

The following markings are on the tire in addition to the tire name (sales designation) and the manufacturer's name:

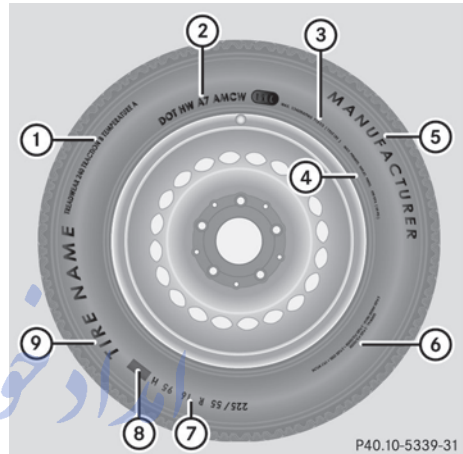

- ① Uniform Tire Quality Grading Standard (▷ page 371)
  - ② DOT, Tire Identification Number (▷ page 370)
  - ③ Maximum tire load (▷ page 365)
  - ④ Maximum tire pressure (▷ page 360)
  - ⑤ Manufacturer
  - ⑥ Tire material (▷ page 371)
  - ⑦ Tire size designation, load-bearing capacity and speed index (▷ page 368)
  - ⑧ Load index (▷ page 370)
  - ⑨ Tire name
- i** Tire data is vehicle-specific and may deviate from the data in the example.

### Tire size designation, load-bearing capacity and speed index

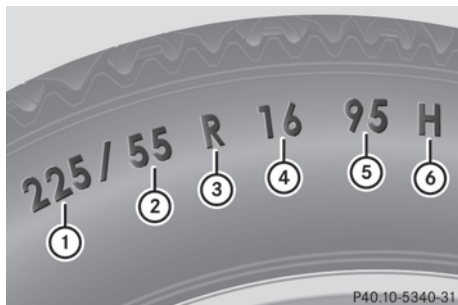

- ① Tire width
- ② Nominal aspect ratio in %
- ③ Tire code
- ④ Rim diameter
- ⑤ Load bearing index
- ⑥ Speed index

**i** Tire data is vehicle-specific and may deviate from the data in the example.

**General:** depending on the manufacturer's standards, the size imprinted in the tire wall may not contain any letters or may contain one letter that precedes the size description.

If there is no letter preceding the size description (as shown above): these are passenger vehicle tires according to European manufacturing standards.

If "P" precedes the size description: these are passenger vehicle tires according to U.S. manufacturing standards.

If "LT" precedes the size description: these are light truck tires according to U.S. manufacturing standards.

If "T" precedes the size description: these are compact emergency spare wheels at high tire pressure, to be used only temporarily in an emergency.

**Tire width:** tire width ① shows the nominal tire width in millimeters.

**Nominal aspect ration:** aspect ratio ② is the size ratio between the tire height and the tire width and is shown in percent. The aspect

ratio is calculated by dividing the tire width by the tire height.

**Tire code:** tire code ③ specifies the tire type. "R" represents radial tires. "D" represents diagonal tires, "B" represents diagonal radial tires.

Optionally, tires with a maximum speed of over 149 mph (240 km/h) may have "ZR" in the size description depending on the manufacturer (e.g. 245/40 ZR 18).

**Rim diameter:** rim diameter ④ is the diameter of the bead seat, not the diameter of the rim flange. The rim diameter is specified in inches (in).

**Load bearing index:** load bearing index ⑤ is a numerical code which specifies the maximum load-bearing capacity of a tire.

#### Warning

The tire load rating must always be at least half of the GAWR of your vehicle. Otherwise, sudden tire failure may be the result which could cause an accident and/or serious injury to you or others.

Always replace rims and tires with rims and tires having the same specifications (designation, manufacturer and type) as shown on the original part.

#### Warning

Do not overload the tires by exceeding the specified load limit as indicated on the Tire and Loading Information placard on the driver's door B-pillar. Overloading the tires can overheat them, possibly causing a blowout. Overloading the tires can also result in handling or steering problems, or brake failure.

Example:

The load bearing index 91 is equivalent to a maximum load of 1356 lbs (615 kg) that the tire can carry. For further information on the maximum tire load in kilograms and pounds, see (▷ page 365).

For further information on the load bearing index, see load index (▷ page 370).

**Speed index:** speed index ⑥ specifies the approved maximum speed of the tire.

### Warning

Even when permitted by law, never operate a vehicle at speeds greater than the maximum speed rating of the tires.

Exceeding the maximum speed for which tires are rated can lead to sudden tire failure, causing loss of vehicle control and possibly resulting in an accident and/or serious personal injury and possible death, for you and for others.

Regardless of the speed index always observe the speed limits. Drive carefully and adapt your driving style to the traffic conditions.

#### Summer tires

Index	Speed rating
Q	up to 100 mph (160 km/h)
R	up to 106 mph (170 km/h)
S	up to 112 mph (180 km/h)
T	up to 118 mph (190 km/h)
H	up to 130 mph (210 km/h)
V	up to 149 mph (240 km/h)
W	up to 168 mph (270 km/h)
Y	up to 186 mph (300 km/h)
ZR...Y	up to 186 mph (300 km/h)
ZR...(..Y)	above 186 mph (300 km/h)
ZR	above 149 mph (240 km/h)

- Optionally, tires with a maximum speed of over 149 mph (240 km/h) may have "ZR" in the size description depending on the manufacturer (e.g. 245/40 ZR 18).

The service specifications consists of load bearing index ⑤ and speed index ⑥.

- If the size description of your tire includes "ZR" and there are no service specifications, ask the tire manufacturer in order to find out the maximum speed.

If a service specification is available, the maximum speed is limited according to the speed index in the service specification.

Example: 245/40 ZR18 97 Y. In this example, "97 Y" is the service specification. The letter "Y" represents the speed index and the maximum speed of the tire is limited to 186 mph (300 km/h).



- Every tire that has a maximum speed above 186 mph (300 km/h) must have "ZR" in the size description **and** the service specification must be given in brackets.

Example: 275/40 ZR 18 (99 Y). The speed index "(Y)" shows that the maximum speed of the tire is above 186 mph (300 km/h).

Ask the tire manufacturer to find out the maximum speed.

#### All-weather tires and winter tires

Index	Speed rating
Q M+S <sup>38</sup>	up to 100 mph (160 km/h)
T M+S <sup>38</sup>	up to 118 mph (190 km/h)
H M+S <sup>38</sup>	up to 130 mph (210 km/h)
V M+S <sup>38</sup>	up to 149 mph (240 km/h)

-  Not all tires that have the M+S identification offer the driving characteristics of winter tires. Winter tires have, in addition to the M+S identification, the  snowflake symbol on the tire sidewall. Tires with this identification fulfill the requirements of the Rubber Manufacturers Association (RMA) and the Rubber Association of Canada (RAC) regarding the tire traction on snow and

<sup>38</sup> or M+S  for winter tires.

have been especially developed for driving on snow.

An electronic speed limiter prevents your vehicle from exceeding the following speeds:

- All vehicles (except AMG vehicles): 130 mph (210 km/h)
- AMG vehicles: 155 mph (250 km/h)
- AMG vehicles with Performance Package: 186 mph (300 km/h)

The speed index of tires installed at the factory may be higher than the maximum speed that the electronic speed limiter permits.

Make sure that your tires have the required speed index as specified in the "Tires" section (> page 374) for your vehicle, e.g. when buying new tires.

More information on reading the tire data can be obtained at any qualified specialist workshop, e.g. at an authorized Mercedes-Benz Center.

### Load index



- i** Tire data is vehicle-specific and may deviate from the data in the example.

In addition to the load bearing index, load index ① may be imprinted after the letters that identify speed index ⑥ (> page 368) on the sidewall of the tire.

- If no specification is given: no text (as in the example above), represents a standard load (SL) tire
- XL or Extra Load: represents a reinforced tire
- Light load: represents a light load tire
- C, D, E: represents a load range that depends on the maximum load that the tire can carry at a certain pressure

### DOT, Tire Identification Number (TIN)

U.S. tire regulations prescribe that every new tire manufacturer or retreader has to imprint a TIN in or on the sidewall of each tire produced.

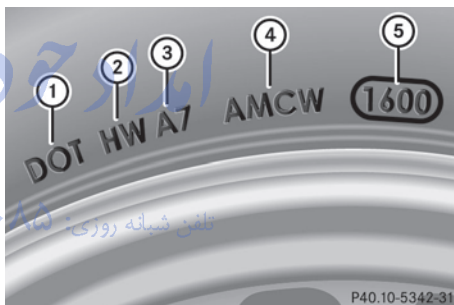

The TIN is a unique identification number. The TIN enables the tire manufacturers to inform purchasers of recalls and other safety-relevant matters. It makes it possible for the purchaser to easily identify the affected tires. The TIN is made up of manufacturer identification code ②, tire size ③, tire type code ④ and date of manufacture ⑤.

- i** Tire data is vehicle-specific and may deviate from the data in the example.

**DOT (Department of Transportation):** tire symbol ① marks that the tire complies with the requirements of the U.S. Department of Transportation.

**Manufacturer identification code:** manufacturer identification code ② provides details on the tire manufacturer. New tires

have a code with two symbols. Retreaded tires have a code with four symbols.

Further information about retreaded tires (▷ page 350).

**Tire size:** identifier ③ describes the tire size.

**Tire type code:** tire type code ④ can be used by the manufacturer as a code to describe specific characteristics of the tire.

**Date of manufacture:** date of manufacture ⑤ provides information about the age of a tire. The first and second positions represent the week of manufacture, starting with "01" for the first calendar week. Positions three and four represent the year of manufacture. For example, a tire that is marked with "3208", was manufactured in week 32 in 2008.

### Characteristics of the tire

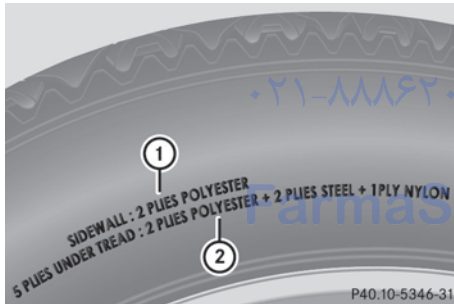

**i** Tire data is vehicle-specific and may deviate from the data in the example.

This information describes the tire cord and the number of layers in sidewall ① and under the tread ②.

## Definitions for tires and loading

### Tire ply composition and material used

Describes the number of layers or the number of rubber-coated belts in the tire tread and the tire wall. These are made of steel, nylon, polyester and other materials.

### Bar

Metric unit for tire pressure. 14.5038 pounds per square inch (psi) and 100 kilopascals (kPa) are the equivalent of 1 bar.

### DOT (Department of Transportation)

DOT marked tires fulfill the requirements of the United States Department of Transportation.

### Average weight of the vehicle occupants

The number of occupants for which the vehicle is designed multiplied by 68 kilograms (150 lb).

### Uniform Tire Quality Grading Standards

This is a uniform standard to grade the quality of tires with regards to tread quality, tire traction and temperature characteristics. The quality grading assessment is made by the manufacturer following specifications from the U.S. government. The quality grade of a tire is imprinted on the sidewall of the tire.

### Recommended tire pressure

This is the recommended tire pressure for your vehicle under normal driving conditions. You will find the recommendation on the Tire and Loading Information placard on the B-pillar on the driver's side of your vehicle. The recommended tire pressure provides the best balance between handling characteristics, ride comfort and wear. Additional information on particular driving conditions is located on the tire pressure table on the inside of the fuel filler flap.

**Increased vehicle weight due to optional equipment**

This is the combined weight of all standard and optional equipment available for the vehicle, regardless of whether it is actually installed on the vehicle or not.

**Wheel rim**

This is the part of the wheel on which the tire is mounted.

**GAWR (Gross Axle Weight Rating)**

The GAWR is the maximum gross axle weight rating. The actual load on an axle must never exceed the gross axle weight rating. The gross axle weight rating can be found on the vehicle identification plate on the B-pillar on the driver's side.

**Speed index**

The speed index is part of the tire identification. It specifies the speed range for which the tire is approved. Specifies the speed range for which the tire is approved.

**GVW (Gross Vehicle Weight)**

The gross vehicle weight includes the weight of the vehicle including fuel, tools, the spare wheel, accessories installed, occupants, luggage and the drawbar noseweight if applicable. The gross vehicle weight must not exceed the gross vehicle weight rating GVWR as specified on the vehicle identification plate on the B-pillar on the driver's side.

**GVWR (Gross Vehicle Weight Rating)**

The GVWR is the maximum permissible gross weight of a fully loaded vehicle (the weight of the vehicle including all accessories, occupants, fuel, luggage and the drawbar

noseweight if applicable). The gross vehicle weight rating is specified on the vehicle identification plate on the B-pillar on the driver's side.

**Maximum loaded vehicle weight**

The maximum weight is the sum of the unladen weight of the vehicle, the weight of the accessories, the maximum load and the weight of the optional equipment installed at the factory.

**Kilopascal (kPa)**

Metric unit for tire pressure. 6.9 kPa is the equivalent of 1 psi. Another unit for tire pressure is bar. 100 kilopascal (kPa) is the equivalent of 1 bar.

**Load index**

In addition to the load bearing index, the load index may also be imprinted on the sidewall of the tire. This specifies the load bearing capacity more precisely.

**Unladen weight**

The weight of a vehicle with standard equipment including the maximum capacity of fuel, oil and coolant. It also includes the air-conditioning system and optional equipment if these are installed on the vehicle, but does not include passengers or luggage.

**Maximum tire load**

The maximum tire load in kilograms or pounds is the maximum weight for which a tire is approved.



**Maximum permissible tire pressure**

Maximum permissible tire pressure for one tire.

**Maximum load on one tire**

Maximum load on one tire. This is calculated by dividing the maximum axle load of one axle by two.

**PSI (pounds per square inch)**

Standard unit of measurement for tire pressure.

**Aspect ratio**

Relationship between tire height and tire width in percent.

**Tire pressure**

Pressure inside the tire applying an outward force to every square inch of the tire's surface. The tire pressure is specified in pounds per square inch (psi), in kilopascal (kPa) or in bar. The tire pressure should only be corrected when the tires are cold. For this, the vehicle must have been stationary for at least three hours or not have traveled more than 1.6 km (1 mile) in this time.

**Tire tread**

The part of the tire that comes into contact with the road.

**Tire bead**

The tire bead ensures that the tire sits securely on the wheel. There are several steel wires in the bead to prevent the tire from coming loose from the wheel rim.

**Sidewall**

The part of the tire between the tread and the tire bead.

**Weight of optional extras**

The combined weight of those optional extras that weigh more than the replaced standard part and more than 2.3 kilograms (5 lbs). These optional extras, such as high-performance brakes, level control, a roof rack or a high-performance battery, are not included in the unladen weight and the weight of the accessories.

**TIN (Tire Identification Number)**

A unique identification number which can be used by a tire manufacturer to identify tires, for example for a product recall, and thus identify the purchasers. The TIN is made up of the manufacturer's identity code, tire size, tire type code and the manufacturing date.

**Load bearing index**

The load bearing index (also load index) is a code that contains the maximum load bearing capacity of a tire.

**Traction**

Traction is the result of friction between the tires and the road surface.

**Wear indicator**

This is indicated by narrow bars (tread wear bars) that are distributed over the tire tread. If the tire tread is level with the bars, the wear limit of  $\frac{1}{16}$  in (1.6 mm) has been reached.

### Distribution of the vehicle occupants

This is the distribution of vehicle occupants over designated seat positions in a vehicle.

### Maximum permissible payload weight

Nominal load and luggage load plus 68 kilograms (150 lb) multiplied by the number of seats in the vehicle.

## Wheel/tire combinations

### Points to remember

#### Warning

Observe the "Important safety notes" (> page 350).

**!** For safety reasons, Mercedes-Benz recommends that you only use tires, wheels and accessories which have been approved by Mercedes-Benz specifically for your vehicle.

These tires have been specially adapted for use with the control systems, such as ABS or ESP®, and are marked as follows:

- MO = Mercedes-Benz Original
- MOE = Mercedes-Benz Original Extended (tires with run-flat characteristics)
- MO1 = Mercedes-Benz Original (only certain AMG tires)

Mercedes-Benz Original Extended tires may only be used on wheels that have been specifically approved by Mercedes-Benz.

Only use tires, wheels or accessories tested and approved by Mercedes-Benz. Certain characteristics, e.g. handling, vehicle noise emissions or fuel consumption, may otherwise be adversely affected. In addition, when driving with a load, tire dimension variations could cause the tires to come into contact with the bodywork and axle components. This could result in damage to the tires or the vehicle.

Mercedes-Benz accepts no liability for damage resulting from the use of tires, wheels or accessories other than those tested and approved.

Further information about tires, wheels and approved combinations can be obtained from any authorized Mercedes-Benz Center.

- i** The Tire and Loading Information placard with the recommended tire pressures is attached to the B-pillar on the driver's side. Further information about driving at high speeds or driving with vehicle loads that are lighter than the maximum vehicle load can be found in the tire pressure table on the inside of the fuel filler flap. Check tire pressures regularly, and only when the tires are cold. Follow the tire manufacturer's maintenance recommendations in the vehicle document wallet.

Further information on recommended tire pressures including tire pressures for specific driving situations, see (> page 352).

- i** Notes on the vehicle equipment – always equip the vehicle:
- with tires of the same size on a given axle (left/right)
  - with the same type of tires at a given time (summer tires, winter tires, MOExtended tires)

- i** Vehicles featuring the MOExtended run-flat system are not equipped with a TIREFIT kit at the factory. It is therefore recommended that you additionally equip your vehicle with a TIREFIT kit if you mount tires that do not feature run-flat properties, e.g. winter tires. You can obtain a TIREFIT kit from an authorized Mercedes-Benz Center, for example.

- i** The following pages contain information on approved wheel rims and tire sizes for equipping your vehicle with winter tires. Winter tires are not available at the factory as standard equipment or optional extras.

If you wish to fit approved winter tires to your vehicle, rims of appropriate size are also required, as the sizes of the approved winter tires can differ from those of the original tires. This is dependent on the model and the equipment installed at the factory.

Tires and wheel rims as well as additional information are available from a qualified specialist workshop, e.g. an authorized Mercedes-Benz Center.

امداد خودرو فارما



تلفن شبانه روزی: ۰۲۱-۸۸۸۶۲۰۸۵



FarmaSOS.com

## Tires of the same dimensions

## Sedan

**i** BA: both axles

			<b>E 350 BlueTEC</b> <b>E 350<sup>39</sup></b> <b>E 350 4MATIC</b> <b>E 550<sup>39</sup></b> <b>E 550 4MATIC</b>	<b>E 350 BlueTEC</b> <b>E 350<sup>39</sup></b> <b>E 350 4MATIC</b> <b>E 550<sup>39</sup></b> <b>E 550 4MATIC</b>
R17	BA	<b>Alloy wheels</b>	8.0 J x 17 H2	8.0 J x 17 H2
		<b>Offset</b>	1.89 in (48 mm)	1.89 in (48 mm)
		<b>All-weather tires</b>	245/45 R17 95 H M+S MOExtended <sup>40</sup>	245/45 R17 99 H XL M+S
		<b>Winter tires<sup>41</sup></b>	245/45 R17 99 V XL M+S  MOExtended <sup>40</sup>	245/45 R17 99 H XL M+S 
R17	BA	<b>Alloy wheels</b>	8.5 J x 17 H2	8.5 J x 17 H2
		<b>Offset</b>	1.89 in (48 mm)	1.89 in (48 mm)
		<b>All-weather tires</b>	245/45 R17 95 H M+S MOExtended <sup>40</sup>	245/45 R17 99 H XL M+S
		<b>Winter tires<sup>41</sup></b>	245/45 R17 99 V XL M+S  MOExtended <sup>40</sup>	245/45 R17 99 H XL M+S 

			<b>E 350 4MATIC</b>	<b>E 350 BlueTEC<sup>42</sup></b>
R18	BA	<b>Alloy wheels</b>	8.5 J x 18 H2	8.5 J x 18 H2
		<b>Offset</b>	1.89 in (48 mm)	1.89 in (48 mm)
		<b>Summer tires</b>	245/40 R18 97 Y XL	245/40 R18 97 Y XL
		<b>Winter tires<sup>41</sup></b>	245/40 R18 97 H XL M+S 	245/40 R18 97 H XL M+S 



			<b>E 350 4MATIC</b>	<b>E 350 BlueTEC<sup>42</sup></b>
R18	BA	<b>Alloy wheels</b>	8.5 J x 18 H2	8.5 J x 18 H2
		<b>Offset</b>	1.89 in (48 mm)	1.89 in (48 mm)
		<b>All-weather tires</b>	245/40 R18 97 V XL M+S	245/40 R18 97 V XL M+S

			<b>E 350 4MATIC</b> <b>E 550 4MATIC</b>	
R18	BA	<b>AMG alloy wheels</b>	8.5 J x 18 H2	
		<b>Offset</b>	1.89 in (48 mm)	
		<b>Summer tires</b>	245/40 R18 97 Y XL	
		<b>Winter tires<sup>41</sup></b>	245/40 R18 97 H XL M+S 	
R18	BA	<b>AMG alloy wheels</b>	8.5 J x 18 H2	
		<b>Offset</b>	1.89 in (48 mm)	
		<b>All-weather tires</b>	245/40 R18 97 V XL M+S	

### Wagon

 BA: both axles

تلفن شبانه روزی: ۰۲۱-۸۸۶۲۰۸۵

			<b>E 350 4MATIC</b>	
R17	BA	<b>Alloy wheels</b>	8.0 J x 17 H2 or 8.5 J x 17 H2	
		<b>Offset</b>	1.89 in (48 mm)	
		<b>All-weather tires</b>	245/45 R17 99 H XL M+S or 245/45 R17 99 H XL M+SMOExtended <sup>40</sup>	
		<b>Winter tires<sup>41</sup></b>	245/45 R17 99 H XL M+S 	
			or 245/45 R17 99 V XL M+S  MOExtended <sup>40</sup>	

<sup>42</sup> Canada only.

<sup>39</sup> USA only.

<sup>40</sup> Tires with run-flat characteristics and only in combination with an activated tire pressure loss warning system or tire pressure monitor.

<sup>41</sup> Not available from the factory.

## Mixed size tires

## Sedan



**i** FA: front axle, RA: rear axle

			E 350 <sup>43</sup>
18"	FA	Alloy wheels	8.5 J x 18 H2
		Offset	1.89 in (48 mm)
		All-weather tires	245/40 R18 97 V XL M+S
	RA	Alloy wheels	9.0 J x 18 H2
		Offset	2.13 in (54 mm)
		All-weather tires <sup>44</sup>	265/35 R18 97 V XL M+S
18"	FA	Alloy wheels	8.5 J x 18 H2
		Offset	1.89 in (48 mm)
		Summer tires	245/40 R18 97 Y XL
	RA	Alloy wheels	9.0 J x 18 H2
		Offset	2.13 in (54 mm)
		Summer tires <sup>44</sup>	265/35 R18 97 Y XL
			E 350 <sup>43</sup> E 550 <sup>43</sup>
18"	FA	AMG alloy wheels	8.5 J x 18 H2
		Offset	1.89 in (48 mm)
		All-weather tires	245/40 R18 97 V XL M+S
	RA	AMG alloy wheels	9.0 J x 18 H2
		Offset	2.13 in (54 mm)
		All-weather tires <sup>44</sup>	265/35 R18 97 V XL M+S
18"	FA	AMG alloy wheels	8.5 J x 18 H2
		Offset	1.89 in (48 mm)
		Summer tires	245/40 R18 97 Y XL
	RA	AMG alloy wheels	9.0 J x 18 H2
		Offset	2.13 in (54 mm)
		Summer tires <sup>44</sup>	265/35 R18 97 Y XL

<sup>43</sup> USA only.

<sup>44</sup> Use of snow chains not permitted.

		<b>E 63 AMG</b>	
18"	FA	<b>AMG alloy wheels Offset</b>	9.0 J x 18 H2 1.46 in (37 mm)
		<b>Summer tires<sup>45</sup></b>	255/40 ZR 18 (99 Y) XL MO1
	RA	<b>AMG alloy wheels Offset</b>	9.5 J x 18 H2 2.05 in (52 mm)
		<b>Summer tires<sup>44, 45</sup></b>	285/35 ZR 18 (101 Y) XL MO1

		<b>E 63 AMG E 63 AMG (Performance Package)</b>	
18"	FA	<b>AMG alloy wheels Offset</b>	9.0 J x 18 H2 1.46 in (37 mm)
		<b>Winter tires<sup>45</sup></b>	255/40 R18 99 V XL M+S 
	RA	<b>AMG alloy wheels Offset</b>	9.5 J x 18 H2 2.05 in (52 mm)
		<b>Winter tires<sup>45, 46</sup></b>	255/40 R18 99 V XL M+S 

		<b>E 63 AMG (Performance Package)</b>	
19"	FA	<b>AMG alloy wheels Offset</b>	9.0 J x 19 H2 1.46 in (37 mm)
		<b>Summer tires</b>	255/35 ZR 19 (96 Y) XL
	RA	<b>AMG alloy wheels Offset</b>	9.5 J x 19 H2 2.05 in (52 mm)
		<b>Summer tires<sup>44</sup></b>	285/30 ZR 19 (98 Y) XL



		<b>E 63 AMG E 63 AMG (Performance Package)</b>	
19"	FA	<b>AMG alloy wheels Offset</b>	9.0 J x 19 H2 1.46 in (37 mm)
		<b>Winter tires</b>	255/35 R19 96 V XL M+S 

<sup>45</sup> Not in combination with ceramic brake system.

<sup>44</sup> Use of snow chains not permitted.

<sup>46</sup> Only fine-link snow chains are permitted.



		<b>E 63 AMG</b> <b>E 63 AMG (Performance Package)</b>
<b>RA</b>	<b>AMG alloy wheels</b>	9.5 J x 19 H2
	<b>Offset</b>	2.05 in (52 mm)
	<b>Winter tires</b>	255/35 R19 96 V XL M+S  47 or 285/30 R19 98 V XL M+S  44

### Spare wheel

- i** Vehicles with MOExtended tires (tires with run-flat characteristics) are not equipped with a TIREFIT kit at the factory.
- i** The specified tire pressure is printed in yellow on the emergency spare wheel.
- i** The E 350 BlueTEC is not equipped with an emergency spare wheel.

<b>"Minispare" emergency spare wheel<sup>48</sup></b>			
		<b>E 350</b> <b>E 350 4MATIC</b>	<b>E 550</b> <b>E 550 4MATIC</b>
<b>17"</b>	<b>Wheels</b>	4.0 B x 17 H2	—
	<b>Offset</b>	1.54 in (39 mm)	—
	<b>Tires</b>	T 155/70 R17 110 M	—
	<b>Tire pressure</b>	420 kPa (4.2 bar/61 psi)	—
<b>18"</b>	<b>Wheels</b>	—	4.5 B x 18 H2
	<b>Offset</b>	—	1.42 in (36 mm)
	<b>Tires</b>	—	T 155/60 R18 107 M
	<b>Tire pressure</b>	—	420 kPa (4.2 bar/61 psi)

<sup>47</sup> Snow chain usage: please contact an authorized Mercedes-Benz Center.

<sup>44</sup> Use of snow chains not permitted.

<sup>48</sup> Use of snow chains not permitted.

Collapsible spare wheel <sup>48</sup>		
E 63 AMG		
19"	<b>Wheels</b>	6.5 B x 19 H2
	<b>Offset</b>	0.55 in (14 mm)
	<b>Tires</b>	175/50-19 97 P
	<b>Tire pressure</b>	350 kPa (3.5 bar/51 psi)

امداد خودرو فارما

تلفن شبانه روزی: ۰۲۱-۸۸۸۶۲۰۸۵

FarmaSOS.com

<sup>48</sup> Use of snow chains not permitted.

# امداد خودرو فارما

تلفن شبانه روزی: ۰۲۱-۸۸۸۶۲۰۸۵

**FarmaSOS.com**

Vehicle equipment .....	384
Genuine Mercedes-Benz parts .....	384
Warranty .....	384
Vehicle identification plates .....	385
Service products and capacities .....	386
Vehicle data .....	393

# امداد خودرو فارما

تلفن شبانه روزی: ۰۲۱-۸۸۸۶۲۰۸۵

[FarmaSOS.com](http://FarmaSOS.com)

## Vehicle equipment

**i** This manual describes all the standard and optional equipment of your vehicle which was available at the time of purchase. Country-specific differences are possible. Bear in mind that your vehicle may not feature all functions described here. This also refers to safety-related systems and functions.

## Genuine Mercedes-Benz parts

All Mercedes-Benz Centers maintain a supply of genuine Mercedes-Benz parts for necessary service and repair work. In addition, strategically located parts delivery centers provide for quick and reliable parts service.

More than 300,000 different genuine Mercedes-Benz parts are available for Mercedes-Benz models.

Genuine Mercedes-Benz parts are subjected to stringent quality inspections. Every part has been specifically developed, manufactured or selected for and adapted to Mercedes-Benz vehicles.

Only genuine Mercedes-Benz parts should therefore be used.

**!** The use of non-approved parts could impair the vehicle's safety. For this reason, Mercedes-Benz recommends genuine Mercedes-Benz parts and approved conversion parts and accessories for your vehicle model.

### Environmental note

Daimler AG also supplies reconditioned major assemblies and parts which are of the same quality as new parts. They are covered by the same Limited Warranty entitlements as new parts.

Always specify the vehicle identification number and engine number when ordering genuine Mercedes-Benz parts. You will find

these numbers on your vehicle's identification plates, for example (▷ page 385).

## Warranty

Your vehicle is covered under the terms of the warranties printed in the Service and Warranty Information booklet.

Your authorized Mercedes-Benz Center will exchange or repair any defective parts originally installed in the vehicle in accordance with the terms of the following warranties:

- New Vehicle Limited Warranty
- Emission System Warranty
- Emission Performance Warranty
- California, Connecticut, Maine, Massachusetts, New York, Pennsylvania, Rhode Island and Vermont Emission Control Systems Warranty
- State Warranty Enforcement Laws (Lemon Laws) تلفن شبانه روز

Replacement parts and accessories are subject to the Mercedes-Benz Replacement Part and Accessory Warranties. You can obtain these at any Mercedes-Benz Center.

**i** Should you lose your Service and Warranty Information booklet, have an authorized Mercedes-Benz Center arrange for a replacement. It will be mailed to you.

Vehicle identification plates

Vehicle identification plate with vehicle identification number (VIN) and paint code number

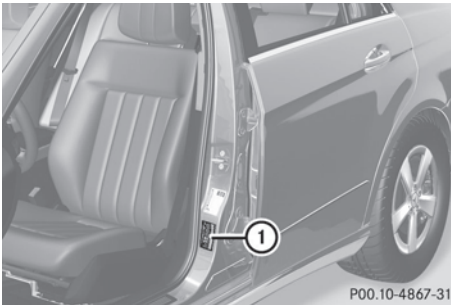

- ▶ Open the driver's door. You see vehicle identification plate ①.



Example: vehicle identification plate (USA only)

- ② VIN
- ③ Paint code number

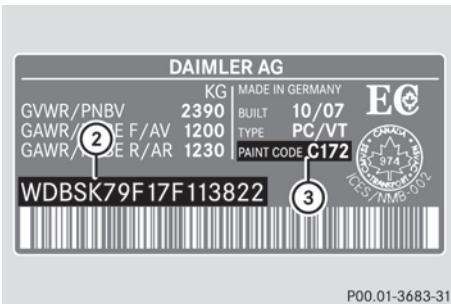

Example: vehicle identification plate (Canada only)

- ② VIN
- ③ Paint code number

**i** The data on the type plate is only an example. This data is vehicle-specific and can differ from the data given here. The data that applies to your vehicle can be found on your vehicle's type plate.

Vehicle identification number (VIN)

The vehicle identification number (VIN) can be found in the following locations:

- on the vehicle identification plate (▷ page 385)
- at the lower edge of the windshield (▷ page 386)

In addition to being stamped on the vehicle identification plate, the vehicle identification number (VIN) is also stamped onto the vehicle body.

It is located on the floor in front of the right-hand front seat.

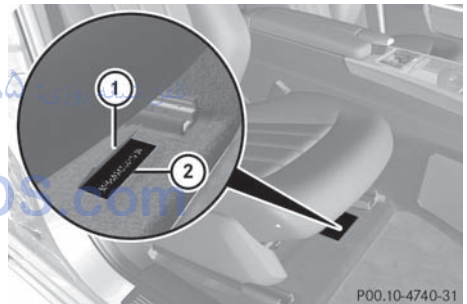

- ▶ Slide the right-hand front seat to its rearmost position.
- ▶ Fold floor covering ① upwards. You will see vehicle identification number (VIN) ②.

### Engine number

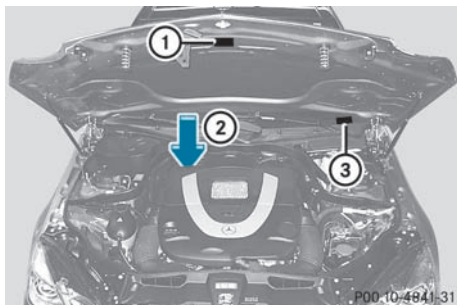

- ① Emissions control information label, including the certification of both federal and Californian emissions reference values
- ② Engine number (stamped into the crankcase)
- ③ VIN (on the lower edge of the windshield)

fluids. Otherwise, you could endanger persons or the environment.

Keep service fluids out of the reach of children.

For health reasons, you should prevent service fluids from coming into direct contact with your skin or clothing.

If a service fluid is swallowed, contact a physician immediately.

### Service products and capacities

#### Important safety notes

Service products include the following:

- fuels (e.g. gasoline, diesel)
- additives for exhaust gas aftertreatment (AdBlue®)
- lubricants (e.g. engine oil, transmission oil)
- coolant
- brake fluid
- windshield washer fluid

Vehicle components and their respective lubricants must match. You should therefore only use products that have been tested and approved by Mercedes-Benz.

Information on tested and approved products can be obtained at an authorized Mercedes-Benz Center or on the Internet at <http://www.mbusa.com> (USA only).

#### **Warning**

Comply with all valid regulations with respect to handling, storing and disposing of service

امداد خودرو فارما

تلفن شبانه روزی: ۰۸۵-۸۸۶۲۰۲۱

FarmaSOS.com



Capacities			
	Vehicle model	Capacity	Fuel, coolant, lubricants etc.
<b>Engine oil and filter</b>	E 350 <sup>49</sup> E 350 BlueTEC	8.5 US qt (8.0 l)	Approved engine oils
	E 350 4MATIC	7.4 US qt (7.0 l)	
	E 550 <sup>49</sup> E 550 4MATIC	9.0 US qt (8.5 l)	
	E 63 AMG <sup>50</sup>	9.3 US qt (8.8 l)	
<b>Power steering</b>	All models except AMG vehicles	Approximately 0.95 US qt (0.9 l)	MB power steering fluid or approved Dexron III ATF
	E 63 AMG	Approximately 1.3 US qt (1.2 l)	
<b>Cooling system</b>	E 350 <sup>49</sup> E 350 4MATIC	Approximately 8.9 US qt (8.4 l)	MB 325.0 corrosion inhibitor/antifreeze agent
	E 350 BlueTEC	Approximately 12.2 US qt (11.5 l)	
	E 550 <sup>49</sup> E 550 4MATIC	Approximately 10.9 US qt (10.3 l)	
	E 63 AMG	Approximately 11.6 US qt (11.0 l)	
<b>Tank capacity</b>	All models	21.1 US gal. (80.0 l)	gasoline engines: premium-grade unleaded gasoline (at least 91 octane, average value between 96 RON/86 MON) Diesel engines: ULTRA-LOW SULFUR DIESEL FUEL (ULSD, maximum sulfur content 15 ppm)
<b>Reserve</b>	All models except AMG vehicles	Approximately 2.4 US gal. (9.0 l)	
	E 63 AMG	Approximately 3.7 US gal. (14.0 l)	

<sup>49</sup> USA only.

<sup>50</sup> Including external oil cooler.

	Vehicle model	Capacity	Fuel, coolant, lubricants etc.
<b>AdBlue® tank</b>	E 350 BlueTEC	6.5 US gal. (24.5 l)	AdBlue® in accordance with ISO 22241
<b>Air-conditioning system</b>	All models	–	Refrigerant R134a and special PAG lubricant (never R 12)
<b>Windshield/headlamp cleaning system</b>	All models except E 350 BlueTEC	6.3 US qt (6.0 l)	MB windshield washer concentrate <sup>51</sup> (> page 393) Mixing ratio for washer fluid (> page 393)
	E 350 BlueTEC	3.7 US qt (3.5 l)	

## Fuel

### Important safety notes

#### **Warning!**

Gasoline and diesel fuels are highly flammable and poisonous. They burn violently and can cause serious injury.

Never allow sparks, flames or smoking materials near gasoline or diesel fuel!

Turn off the engine before refueling.

Whenever you are around gasoline or diesel fuel, avoid inhaling fumes and any skin or clothing contact. Extinguish all smoking materials.

Direct skin contact with fuels and the inhalation of fuel vapors are damaging your health.

If premium-grade unleaded gasoline is unavailable and regular gasoline is used, observe the following precautions:

- only fill the fuel tank to half full with regular unleaded gasoline and add the rest as soon as possible with premium-grade unleaded gasoline.
- do not drive at the maximum speed.
- avoid sudden acceleration.
- when the vehicle is carrying a light cargo, e.g. two passengers without luggage, do not allow the engine to rev above 3000 rpm.
- when the vehicle is fully loaded or being operated in mountainous terrain, do not depress the accelerator pedal further than  $\frac{2}{3}$  of the pedal travel.

### Premium-grade unleaded gasoline

**!** To ensure the longevity and full performance of the engine, only premium-grade unleaded gasoline must be used.

### Fuel requirements

#### Gasoline engines

Use only premium-grade unleaded gasoline. The octane number should be at least 91. Details can be found on the gas pump. The

<sup>51</sup> Mixed with water or premixed washer fluid with antifreeze protection.

octane number is the average value of the Research Octane Number (RON) and Motor Octane Number (MON):  $(RON + MON) / 2$ , also known as knock resistance.

Reformulated Gasoline (RFG) and/or unleaded gasoline with additives can be used if the concentration of the additives in the fuel does not exceed 10%, e.g.:

- Ethanol
- TAME
- ETBE
- IPA
- TBA

For MTBE, the concentration should not exceed 15%.

The concentration of methanol in gasoline including other additives must not exceed 3%.

Using mixtures of methanol and ethanol is not permitted. Gasohol, a mixture of 10% ethanol and 90% unleaded gasoline can be used.

All of these mix fuels must fulfill the fuel requirements, e.g.:

- knock resistance
- boiling point
- vapor pressure

### Diesel engines – important safety information

**!** Only use commercially available ULTRA-LOW SULFUR DIESEL FUEL (ULSD, 15 ppm MAXIMUM SULFUR) that meets the ASTM D975 standard. Failure to use ULTRA-LOW SULFUR DIESEL FUEL (ULSD) can severely damage the vehicle's exhaust gas aftertreatment system.

**!** Do not fill the tank with gasoline. Do not blend diesel fuel with gasoline or kerosene. Otherwise, the fuel system and the engine will be damaged. Damage resulting from the use of gasoline or kerosene is not covered by the Mercedes-Benz Limited Warranty.

To prevent malfunctions, diesel fuel with improved flow characteristics is available in

the winter months. Check with your fuel retailer.

Information on the fuel grade can usually be found on the gas pump. If the information cannot be found on the gas pump, ask service station personnel. For further information, contact an authorized Mercedes-Benz Center or visit <http://www.mbusa.com> (USA only).

### Diesel engines – Fuels containing bio-diesel (FAME [fatty acid methyl ester])

Mercedes-Benz USA approves the use of B5 (ULSD with a maximum of up to five percent by volume biodiesel) for all diesel engines with common rail direct injection (CDI) and BlueTEC.

Pure biodiesel and diesel fuels that contain a higher percentage of biodiesel, e.g. B20, may cause damage to the fuel system/engine and are, therefore, not approved.

For further information, please ask the service station personnel. The label on the gas pump must indicate clearly that the B5 biodiesel blend meets the ULSD standard. If the label is not clear, do not refuel the vehicle.

The Mercedes-Benz Limited Warranty does not cover damages caused by the use of fuels not meeting Mercedes-Benz approved fuel standards.

### Additives in gasoline

One of the major problems in engine design is the creation of carbon deposits during the process of burning fuel. Mercedes-Benz recommends that you use fuel brands that have the additives which prevent the build up of carbon deposits.

If you use fuels without these additives for a longer period of time, there may be a build up of carbon deposits, especially on the inlet valves and in the combustion chamber.

This could lead to engine running problems, e.g.:

- warm-up hesitation
- unstable idle

- knocking/pinging
- misfire
- power loss

In areas where carbon deposits may be encountered due to lack of availability of gasoline which contains these additives, Mercedes-Benz recommends the use of additives approved for use in Mercedes-Benz vehicles.

Consult an authorized Mercedes-Benz Center or visit <http://www.mbusa.com> (USA only) to view a list of approved products. Observe the instructions for use on the product label. Do not mix other fuel additives with fuel. This causes unnecessary costs and could damage the engine.

**!** Do not refuel with low-grade fuel and do not use fuel additives that are not tested and approved for Mercedes-Benz vehicles. Damage or malfunctions can result that are not covered:

- by the Mercedes-Benz Limited Warranty
- by an existing Limited Warranty
- by an extended Limited Warranty

## DEF

### Important safety notes

**i** For BlueTEC vehicles only.

AdBlue® is a non-flammable, non-toxic, colorless, odorless and water-soluble fluid.

**!** Only use AdBlue® that complies with ISO 22241. Do not add any special additives to AdBlue® and do not thin AdBlue® with water. This could destroy the BlueTEC exhaust gas aftertreatment.

**!** Rinse surfaces that have come into contact with AdBlue® immediately with water or remove AdBlue® using a damp cloth and cold water. If the AdBlue® has already crystallized, use a sponge and cold water to clean it. AdBlue® residues

crystallize after time and contaminate the affected surfaces.

### High outside temperatures

If AdBlue® is heated to above 122 °F (50 °C) for an extended period of time, e.g. due to direct sunlight on the AdBlue® tank, AdBlue® may start to decompose. Ammonia vapors develop as a result.

#### **!** Warning!

When opening the filler cap of the AdBlue® tank ammonia gas vapors may escape. Refill AdBlue® in a well ventilated area only. Ammonia gas vapors have a pungent odor and are particularly irritating for your skin, mucous membranes, and eyes. Inhaling ammonia gas vapors will cause burning eyes, nose, and throat, as well as coughing and watering eyes.

### Low outside temperatures

AdBlue® freezes at a temperature of approximately 12 °F (-11 °C). The vehicle is equipped with an AdBlue® preheating system at the factory. Winter operation can thus be guaranteed even at temperatures below 12 °F (-11 °C).

### Additives

**!** Use only AdBlue® complying with ISO 22241. Do not use any additives with AdBlue® and do not thin AdBlue® with water. This may destroy the BlueTEC exhaust gas aftertreatment system.

Damage resulting from the use of additives or water is not covered by the Mercedes-Benz Limited Warranty.

### Purity

Assuring the purity of AdBlue® is particularly important with respect to avoiding malfunctions in the exhaust gas aftertreatment system.

If AdBlue® is pumped out of the AdBlue® tank, e.g. during repair work, it must not be returned to the tank. The purity of the fluid can no longer be guaranteed.

**!** Impurities in AdBlue®, e.g. due to other service products, cleaning agents or dust, lead to increased emission values, system malfunctions, catalytic converter damage or damage to the BlueTEC system.

## Engine oil

### Points to remember

The engine oils are matched to the performance of Mercedes-Benz engines and service intervals. For this reason, only use engine oils and oil filters that are approved for vehicles with a service system.

Contact an authorized Mercedes-Benz Center or visit <http://www.mbusa.com> (USA only) for a list of approved engine oils and oil filters.

**!** Never use engine oil or an oil filter of a specification other than is necessary to fulfill the prescribed service intervals. Do not change the engine oil or oil filter in order to achieve longer replacement intervals than those prescribed. Otherwise, you may cause damage to the engine or exhaust gas aftertreatment; this is not covered by the Mercedes-Benz Limited Warranty.

Follow the instructions in the service interval display regarding the oil change. Otherwise, you may damage the engine and the exhaust gas aftertreatment.

Mercedes-Benz recommends MOBIL OIL.

The table shows which engines oil have been approved for your vehicle.

Model	Engine model	MB Approval
E 350 <sup>52</sup> E 350 4MATIC	272	229.5
E 350 BlueTEC	642	229.5 <sup>1</sup>
E 550 <sup>52</sup> E 550 4MATIC	273	229.5
E 63 AMG	156	229.5 <sup>53</sup>

**i** MB Approval is stated on the containers.

### Lubricant additives

**!** Do not mix any lubricant additives with the engine oil. This could damage the engine. Damage resulting from the use of such lubricant additives in the engine oil is not covered by the Mercedes-Benz Limited Warranty.

### Engine oil viscosity

Viscosity describes the flow characteristics of a fluid. If an engine oil has a high viscosity, this means that it is thick; a low viscosity means that it is thin.

Using the table below, make sure that the SAE classification (viscosity) is sufficient for the temperatures at which the vehicle is operated. The low temperature characteristics of engine oils can deteriorate significantly, e.g. by aging, soot and fuel deposits. It is therefore recommended that you carry out oil changes regularly using an approved engine oil with the appropriate SAE classification.

<sup>52</sup> USA only.

<sup>53</sup> Restriction: only SAE 0W-40 or SAE 5W-40 engine oils may be used.

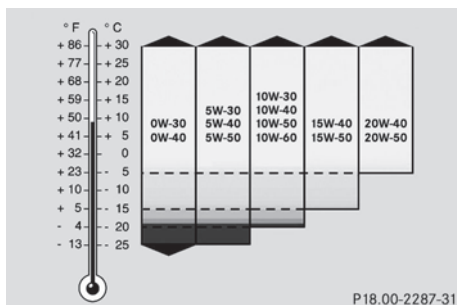

### Refrigerant of the air-conditioning system

The air-conditioning system is filled with R134a refrigerant and a special PAG lubricant.

**!** Never use refrigerant R 12 (CFC) or mineral lubricants. Otherwise, you could damage the air-conditioning system.

### Brake fluid

#### **Warning!**

The brake fluid constantly absorbs moisture from the air; this lowers its boiling point.

If the boiling point of the brake fluid is too low, vapor pockets may form in the brake system when the brakes are applied hard (e.g. when driving downhill). This would impair braking efficiency.

You should have the brake fluid renewed at regular intervals. The brake fluid change intervals can be found in the Service Booklet.

Only use brake fluid approved by Mercedes-Benz. Information about approved brake fluids can be obtained from any authorized Mercedes-Benz Center.

### Coolant

#### Important safety notes

The coolant is a mixture of water and antifreeze/corrosion inhibitor. It performs the following tasks:

- anti-corrosion protection
- antifreeze protection
- raising the boiling point

The cooling system is filled with coolant at the factory which contains antifreeze/corrosion inhibitor that ensures protection down to approximately  $-35^{\circ}\text{F}$  ( $-37^{\circ}\text{C}$ ).

**!** Only add coolant that has been premixed with the desired antifreeze protection. You could otherwise damage the engine.

Further information on coolants and on filling can be found in the Mercedes-Benz Specifications for Service Products, MB Approval 310.1, e.g. on the Internet at <http://bevo.mercedes-benz.com>. You can also consult an authorized Mercedes-Benz Center.

**!** Always use a suitable coolant mixture, even in countries where high temperatures prevail.

Otherwise, the cooling system will not be sufficiently protected from corrosion, and the boiling point will be too low.

If the coolant has antifreeze protection down to  $-35^{\circ}\text{F}$  ( $-37^{\circ}\text{C}$ ), the boiling point of the coolant in the pressurized system is approximately  $266^{\circ}\text{F}$  ( $130^{\circ}\text{C}$ ).

Your vehicle has a range of aluminum components. Use of aluminum components in the engine make it necessary to specifically match the antifreeze/corrosion inhibitor in these systems in order to protect the aluminum parts. Using other antifreeze/corrosion inhibitors without these characteristics affects the service life.

The coolant must be used throughout the year in order to maintain the necessary corrosion protection and provide protection from

overheating. In the Service Booklet, you can find information on the intervals for renewal.

The renewal interval is determined by the coolant type and the cooling system design. The renewal interval in the Service Booklet is only valid if the coolant is added or renewed with Mercedes-Benz approved products.

Therefore, only use MB 326.0 antifreeze/corrosion inhibitor or another Mercedes-Benz approved product of the same specification.

Information on other Mercedes-Benz approved products of the same specification can be obtained at any authorized Mercedes-Benz Center or on the Internet at

**http://bevo.mercedes-benz.com.**

The coolant is checked at every service date at an authorized Mercedes-Benz Center.

The antifreeze/corrosion inhibitor concentration in the cooling system should:

- be at least 50%. This will protect the cooling system against freezing down to around -35 °F (-37 °C).
- not exceed 55% (antifreeze protection down to -49 °F (-45 °C); otherwise, heat will not be dissipated as effectively.

If the coolant level is too low, MB 326.0 antifreeze/corrosion inhibitor should be added. Have the cooling system checked for leaks.

### Windshield and headlamp cleaning system

#### Warning

Washer solvent/antifreeze is highly flammable. Do not spill washer solvent/antifreeze on hot engine parts, because it may ignite and burn. You could be seriously burned.

- ▶ Use MB Windshield Washer Concentrate MB SummerFit.
- ▶ **At temperatures above freezing:** add 1 part MB SummerFit to 100 parts water, e.g.

1.34 fl oz (40 ml) MB SummerFit to 1 gal (4.0 l) of water.

- ▶ **At temperatures below freezing:** add 1 part MB SummerFit to 100 parts washer fluid, e.g. 1.34 fl oz (40 ml) MB SummerFit to 1 gal (4.0 l) of water.

### Vehicle data

#### Vehicle data, E 350

The data quoted here refers specifically to a vehicle with standard equipment. Contact an authorized Mercedes-Benz Center for the data for all vehicle variants and trim levels.

-  This vehicle is only available in the USA.

#### Vehicle dimensions, E 350

<b>Vehicle length</b>	191.9 in (4874 mm)
<b>Vehicle width including exterior mirrors</b>	81.5 in (2071 mm)
<b>Vehicle height</b>	57.8 in (1467 mm)
<b>Wheel base</b>	113.1 in (2874 mm)
<b>Front track</b>	62.2 in (1580 mm)
<b>Rear track</b>	63.0 in (1599 mm)
<b>Ground clearance</b>	6.2 in (157 mm)
<b>Turning circle</b>	37.0 ft (11.3 m)

#### Vehicle weight, E 350

<b>Maximum roof load</b>	Maximum 220 lb (100 kg)
<b>Maximum trunk load</b>	Maximum 220 lb (100 kg)

#### Vehicle data, E 350 BlueTEC

The data quoted here refers specifically to a vehicle with standard equipment. Contact an



authorized Mercedes-Benz Center for the data for all vehicle variants and trim levels.

Vehicle dimensions, E 350 BlueTEC	
Vehicle length	191.9 in (4874 mm)
Vehicle width including exterior mirrors	81.5 in (2071 mm)
Vehicle height	57.8 in (1467 mm) <sup>54</sup>
Wheel base	113.1 in (2874 mm)
Front track	62.2 in (1580 mm)
Rear track	63.0 in (1599 mm)
Ground clearance	6.2 in (157 mm) <sup>54</sup>
Turning circle	37.0 ft (11.3 m)

Vehicle weight, E 350 BlueTEC	
Maximum roof load	Maximum 220 lb (100 kg)
Maximum trunk load	Maximum 220 lb (100 kg)

#### Vehicle data, E 350 4MATIC

The data quoted here refers specifically to a vehicle with standard equipment. Contact an authorized Mercedes-Benz Center for the data for all vehicle variants and trim levels.

Vehicle dimensions, E 350 4MATIC	
Vehicle length	
Sedan	191.9 in (4874 mm)
Wagon	193.0 in (4901 mm)
Vehicle width including exterior mirrors	
Sedan	81.5 in (2071 mm)
Wagon	81.5 in (2071 mm)

#### Vehicle dimensions, E 350 4MATIC

Vehicle height	
Sedan	57.8 in (1467 mm)
Wagon	59.7 in (1514 mm)
Wheel base	
Sedan	113.1 in (2874 mm)
Wagon	113.1 in (2874 mm)
Front track	
Sedan	62.2 in (1580 mm)
Wagon	62.2 in (1580 mm)
Rear track	
Sedan	63.0 in (1599 mm)
Wagon	63.0 in (1599 mm)
Ground clearance	
Sedan	6.2 in (157 mm)
Wagon	6.2 in (156 mm)
Turning circle	
Sedan	36.9 ft (11.3 m)
Wagon	36.9 ft (11.3 m)

#### Vehicle weight, E 350 4MATIC

Maximum roof load	Maximum 220 lb (100 kg)
Maximum trunk load	Maximum 220 lb (100 kg)

#### Vehicle data, E 550

The data quoted here refers specifically to a vehicle with standard equipment. Contact an authorized Mercedes-Benz Center for the data for all vehicle variants and trim levels.

<sup>54</sup> These values refer to an unladen vehicle with standard equipment. On vehicles with the AIRMATIC package, the values vary according to the vehicle level.

**i** This vehicle is only available in the USA.

#### Vehicle dimensions, E 550

<b>Vehicle length</b>	191.9 in (4874 mm)
<b>Vehicle width including exterior mirrors</b>	81.5 in (2071 mm)
<b>Vehicle height</b>	57.0 in (1447 mm)
<b>Wheel base</b>	113.1 in (2874 mm)
<b>Front track</b>	62.2 in (1580 mm)
<b>Rear track</b>	62.5 in (1587 mm)
<b>Ground clearance</b>	5.5 in (140 mm)
<b>Turning circle</b>	37.0 ft (11.3 m)

#### Vehicle weight, E 550

<b>Maximum roof load</b>	Maximum 220 lb (100 kg)
<b>Maximum trunk load</b>	Maximum 220 lb (100 kg)

#### Vehicle data, E 550 4MATIC

The data quoted here refers specifically to a vehicle with standard equipment. Contact an authorized Mercedes-Benz Center for the data for all vehicle variants and trim levels.

#### Vehicle dimensions, E 550 4MATIC

<b>Vehicle length</b>	191.9 in (4874 mm)
<b>Vehicle width including exterior mirrors</b>	81.5 in (2071 mm)
<b>Vehicle height</b>	57.0 in (1447 mm)
<b>Wheel base</b>	113.1 in (2874 mm)
<b>Front track</b>	62.2 in (1580 mm)
<b>Rear track</b>	63.0 in (1599 mm)

#### Vehicle dimensions, E 550 4MATIC

<b>Ground clearance</b>	5.5 in (140 mm)
<b>Turning circle</b>	37.0 ft (11.3 m)

#### Vehicle weight, E 550 4MATIC

<b>Maximum roof load</b>	Maximum 220 lb (100 kg)
<b>Maximum trunk load</b>	Maximum 220 lb (100 kg)

#### Vehicle data, E 63 AMG

The data quoted here refers specifically to a vehicle with standard equipment. Contact an authorized Mercedes-Benz Center for the data for all vehicle variants and trim levels.

#### Vehicle dimensions, E 63 AMG

<b>Vehicle length</b>	192.6 in (4891 mm)
<b>Vehicle width including exterior mirrors</b>	81.5 in (2071 mm)
<b>Vehicle height</b>	56.8 in (1442 mm)
<b>Wheel base</b>	113.1 in (2874 mm)
<b>Front track</b>	64.0 in (1625 mm)
<b>Rear track</b>	62.8 in (1594 mm)
<b>Ground clearance</b>	4.5 in (114 mm)
<b>Turning circle</b>	37.1 ft (11.3 m)

#### Vehicle weight, E 63 AMG

<b>Maximum roof load</b>	Maximum 220 lb (100 kg)
<b>Maximum trunk load</b>	Maximum 220 lb (100 kg)

# امداد خودرو فارما

تلفن شبانه روزی: ۰۲۱-۸۸۸۶۲۰۸۵

**FarmaSOS.com**

## Publication details

### Internet

Further information about Mercedes-Benz vehicles and about Daimler AG can be found on the following websites:

<http://www.mbusa.com> (USA only)

<http://www.mercedes-benz.ca> (Canada only)

### Editorial office

Not to be reprinted, translated or otherwise reproduced, in whole or in part, without the written permission of Daimler AG.

امداد خودرو فارما

تلفن شبانه روزی: ۰۲۱-۸۸۸۶۲۰۸۵

FarmaSOS.com

# امداد خودرو فارما

تلفن شبانه روزی: ۰۲۱-۸۸۸۶۲۰۸۵

[FarmaSOS.com](http://FarmaSOS.com)



2125847081

Order no. 6515 3489 13 Part no. 212 584 70 81 Edition B 2011