



Operator's Manual

تلفن شبانه روزی: ۰۲۱-۸۸۶۲۸۸
S-Class

FarmaSOS.com



Mercedes-Benz

امداد خودرو فارما

تلفن شبانه روزی: ۰۲۱-۸۸۸۶۲۰۸۵

FarmaSOS.com



2205843582

Order No. 6515 2176 13 Part No. 220 584 35 82 USA Edition A 2005

امداد خودرو فارما

تلفن شبانه روزی: ۰۲۱-۸۸۸۶۲۰۸۵

S 430
S 430 4MATIC
S 500
S 500 4MATIC
S 55 AMG
S 600

FarmaSOS.com

Our company and staff congratulate you on the purchase of your new Mercedes-Benz.

Your selection of our product is a demonstration of your trust in our company name. Furthermore, it exemplifies your desire to own an automobile that will be as easy as possible to operate and provide years of service.

Your Mercedes-Benz represents the efforts of many skilled engineers and craftsmen. To help assure your driving pleasure, and also the safety of you and your passengers, we ask you to make a small investment of time:

- Please read this manual carefully, then return it to your vehicle where it will be handy for your reference.
- Please follow the recommendations contained in this manual. They are designed to acquaint you with the operation of your Mercedes-Benz.
- Please pay attention to the warnings and cautions contained in this manual. They are designed to help improve the safety of the vehicle operator and occupants.

We extend our best wishes for many miles of safe, pleasurable driving.

Mercedes-Benz USA, LLC
A DaimlerChrysler Company

FarmaSOS.com

Contents

Introduction	9	At a glance	21	Driving.....	43
Product information.....	9	Cockpit.....	22	Fastening the seat belts	43
Operator's Manual.....	10	Instrument cluster	24	Starting the engine	46
Service and warranty information ..	10	Multifunction steering wheel	26	Switching on headlamps.....	50
Important notice for California		Center console	27	Turn signals	51
retail buyers and lessees of		Upper part	27	Windshield wipers.....	52
Mercedes-Benz automobiles	11	Lower part	28	Problems while driving.....	54
Maintenance	12	Overhead control panel	29	Parking and locking.....	55
Roadside Assistance	12	Door control panel.....	30	Parking brake	56
Change of address or ownership....	12			Switching off headlamps.....	57
Operating your vehicle outside				Turning off the engine.....	57
the USA or Canada.....	13	Getting started	31	Locking	58
Where to find it.....	14	Unlocking	32		
Symbols.....	15	Unlocking with the SmartKey.....	32	Safety and Security	59
Operating safety	16	Unlocking with KEYLESS-GO*	33	Occupant safety	60
Proper use of the vehicle	16	Starter switch positions	34	Air bags	61
Problems with your vehicle.....	17	Adjusting	37	Seat belts	66
Reporting safety defects.....	18	Seats.....	37	Preventive occupant safety	
Reporting safety defects	18	Steering wheel.....	40	(PRE-SAFE)	70
Vehicle data recording.....	19	Mirrors.....	41	Children in the vehicle	71
Information regarding electronic				Override switch for rear	
recording devices.....	19			passenger compartment.....	78
				Panic alarm	79
				Activating.....	79
				Deactivating.....	79

Contents

Driving safety systems.....	80	Seats	114	Instrument cluster	140
ABS	80	Easy-entry/exit feature	114	Instrument cluster illumination	140
BAS	81	Removing and installing		Coolant temperature gauge	141
ESP.....	82	front seat head restraints.....	116	Trip odometer	141
Four wheel electronic traction		Rear seats.....	117	Tachometer.....	142
system (4MATIC) with the ESP	85	Rear seat head restraints	120	Outside temperature indicator	142
Anti-theft systems.....	86	Lumbar support.....	122	Clock.....	142
Immobilizer.....	86	Multicontour backrest*	122	Control system	143
Anti-theft alarm system	87	Drive-dynamic seat*	124	Multifunction display.....	143
Tow-away alarm	89	Seat heating*	125	Multifunction steering wheel.....	144
		Seat ventilation*	127	Menus	146
		Memory function	128	Standard display menu	148
Controls in detail	91	Storing positions into memory	129	AUDIO menu	148
Locking and unlocking	92	Recalling positions from memory	129	CD changer* operating mode	151
SmartKey	92	Storing exterior rear view		TEL menu*	153
SmartKey with KEYLESS-GO*	96	mirror parking position.....	130	NAVI menu.....	155
Opening the doors from		Lighting.....	131	Distronic* menu	156
the inside	102	Exterior lamp switch.....	131	Trip computer menu.....	157
Opening the trunk	103	Combination switch	135	Vehicle status message	
Closing the trunk.....	105	Hazard warning flasher	136	memory menu.....	159
Trunk lid emergency release	111	Interior lighting.....	137	Settings menu.....	160
Power closing assist		Courtesy lighting	139		
for doors and trunk lid.....	112	Door entry lamps	139		
Automatic central locking	112	Trunk lighting	139		
Locking and unlocking					
from the inside	113				

Contents

Automatic transmission.....	173	Automatic climate control	192	Power tilt/sliding sunroof	211
One-touch gearshifting.....	175	Setting the temperature.....	195	Opening and closing the power	
Gear ranges	176	Adjusting air distribution.....	196	tilt/sliding sunroof.....	211
Gear selector lever position	177	Adjusting air volume	198	Synchronizing the power	
Automatic shift program	179	Maximum cooling MAXCOOL.....	198	tilt/sliding sunroof.....	213
Driving tips.....	180	Defrosting	199	Driving systems.....	214
Steering wheel gearshift control		Air recirculation mode	199	Cruise control	214
(Speedshift) S 55 AMG.....	181	Charcoal filter	200	Distronic*	217
Manual shift program S 55 AMG..	183	Rear window defroster.....	201	Airmatic	229
Emergency operation		Deactivating the climate		Active Body Control (ABC)*	231
(Limp Home Mode)	185	control system	202	Parktronic system*	
Good visibility	186	Air conditioning.....	202	(Parking assist)	235
Headlamp cleaning system*		Residual heat and ventilation.....	203	Loading	240
(Standard on S 500, S 600,		Ventilated storage compartment ..	204	Roof rack*	240
S 55 AMG).....	186	Rear passenger compartment		Loading instructions	241
Rear view mirrors.....	186	adjustable air vents.....	204	Cargo tie-down hooks.....	241
Electrically folding exterior		Rear passenger compartment		Useful features.....	242
rear view mirrors.....	188	climate control*	205	Vanity mirrors.....	242
Windshield wipers	189	Power windows	207	Storage compartments.....	243
Sun visors	190	Opening and closing the power		Ashtrays.....	251
Rear window sunshade*	191	windows.....	207	Cigarette lighters.....	252
Rear door window sunshade*	191	Synchronizing the power		Heated steering wheel*	253
		windows.....	209	Telephone*	254
		Summer opening feature	209	Tele Aid.....	255
		Convenience closing feature.....	210	Garage door opener.....	264
				Infrared reflecting windshield	270

Contents

Operation	271	At the gas station	283	DOT, Tire Identification	
The first 1000 miles (1500 km)	272	Refueling	283	Number (TIN)	317
Driving instructions.....	273	Check regularly and before		Maximum tire load	318
Drive sensibly – save fuel.....	273	a long trip.....	284	Maximum tire inflation pressure ..	319
Drinking and driving	273	Engine compartment	286	Uniform Tire Quality Grading	
Pedals	273	Hood	286	Standards (U.S. vehicles).....	319
Power assistance	273	Engine oil	287	Tire ply material	321
Brakes	274	Transmission fluid level.....	292	Tire and loading terminology.....	322
Driving off.....	275	Active Body Control* (ABC*)		Rotating tires	325
Parking.....	275	fluid level.....	292	Winter driving	326
Tires	276	Coolant level	292	Winter tires	326
Hydroplaning.....	277	Battery	294	Block heater (Canada only).....	327
Tire traction.....	277	Windshield washer system and		Snow chains.....	327
Tire speed rating	278	headlamp cleaning system*	295	Maintenance.....	328
Winter driving instructions	279	Tires and wheels.....	296	Clearing the maintenance	
Standing water	280	Important guidelines	296	service indicator	328
Passenger compartment	280	Tire care and maintenance.....	297	Maintenance service term	
Driving abroad.....	280	Direction of rotation.....	299	exceeded	329
Control and operation of radio		Loading the vehicle	299	Calling up the maintenance	
transmitters.....	280	Recommended tire inflation		service indicator	329
Catalytic converter	281	pressure	305	Resetting the maintenance	
Emission control.....	282	Checking tire inflation pressure ...	307	service indicator	329
Coolant temperature	282	Tire labeling.....	312	Vehicle care.....	330
		Load identification	316	Cleaning and care of vehicle	330

Contents

Practical hints	337	Replacing wiper blades.....	396	Technical data	415
What to do if ...?.....	338	Removing wiper blades.....	396	Parts service	416
Lamps in instrument cluster	338	Installing wiper blades	397	Warranty coverage	417
Lamp in center console.....	346	Flat tire.....	398	Loss of Service and Warranty	
Vehicle status messages		Preparing the vehicle	398	Information Booklet.....	417
in the multifunction display.....	347	Mounting the spare wheel	398	Identification labels	418
Where will I find ...?	379	Battery.....	403	Layout of poly-V-belt drive.....	419
First aid kit.....	379	Disconnecting the battery.....	404	S 430/S 500 (all models).....	419
Vehicle jack, vehicle tool kit,		Removing the battery.....	404	S 55 AMG	419
luggage bowl, spare wheel.....	379	Charging and reinstalling the battery ...	404	S 600.....	419
Unlocking/locking in an emergency..	383	Reconnecting the battery.....	405	Engine	420
Unlocking the vehicle.....	383	Jump starting.....	406	Rims and tires	422
Locking the vehicle	384	Towing the vehicle	408	Same size tires	423
Fuel filler flap	385	Installing towing eye bolt	410	Mixed size tires.....	425
Opening/closing in an emergency.....	386	Fuses.....	411	Spare wheel.....	426
Tilt/sliding sunroof	386	Aids for replacing fuses	411	Electrical system	427
Replacing SmartKey batteries	387	Fuse boxes in passenger		Main dimensions and weights	428
SmartKey	387	compartment	412	Main dimensions.....	428
SmartKey with KEYLESS-GO*	388	Fuse boxes in engine		Weights.....	428
Replacing bulbs	389	compartment	413		
Bulbs.....	390				
Replacing bulbs for front lamps ...	392				
Replacing bulbs for rear lamps.....	394				

Contents

Fuels, coolants, lubricants, etc.	429	
Capacities	429	Technical terms 437
Engine oils.....	431	
Engine oil additives	431	
Air conditioning refrigerant	431	Index 443
Brake fluid	431	
Premium unleaded gasoline	432	
Fuel requirements	432	
Gasoline additives	432	
Coolants.....	433	
Windshield and headlamp washer system	436	

تلفن شبانه روزی: ۰۲۱-۸۸۶۲۰۸۵

FarmaSOS.com

▼ **Product information**

Please observe the following in your own best interest:

We recommend using genuine Mercedes-Benz parts as well as conversion parts and accessories explicitly approved by us for your vehicle model.

We have tested these parts to determine their reliability, safety and special suitability for Mercedes-Benz vehicles.

We are unable to make an assessment for other products and therefore cannot be held responsible for them, even if in individual cases an official approval or authorization by governmental or other agencies should exist. Use of such parts and accessories could adversely affect the safety, performance or reliability of your vehicle. Please do not use them.

Genuine Mercedes-Benz parts as well as conversion parts and accessories approved by us are available at your authorized Mercedes-Benz Center where you will receive comprehensive information, also on permissible technical modifications, and where proper installation will be performed.

تلفن شبانه روزی: ۰۲۱-۸۸۶۲۰۸۵

FarmaSOS.com

Introduction

Operator's Manual

This Operator's Manual contains a great deal of useful information. We urge you to read it carefully and familiarize yourself with the vehicle before driving.

For your own safety and longer service life of the vehicle, we urge you to follow the instructions and warnings contained in this manual. Ignoring them could result in damage to the vehicle or personal injury to you or others. Vehicle damage caused by failure to follow instructions is not covered by the Mercedes-Benz Limited Warranty.

Your vehicle may have some or all of the equipment described in this manual. Therefore, you may find explanations for optional equipment not installed in your vehicle. If you have any questions about the operation of any equipment, your authorized Mercedes-Benz Center will be glad to demonstrate the proper procedures.

We continuously strive to improve our product, and ask for your understanding that we reserve the right to make changes in design and equipment. Therefore, information, illustrations and descriptions in this Operator's Manual might differ from your vehicle.

Optional equipment is also described in this manual, including operating instructions wherever necessary. Since they are special-order items, the descriptions and illustrations herein may vary slightly from the actual equipment of your vehicle.

If there are any equipment details that are not shown or described in this Operator's Manual, your authorized Mercedes-Benz Center will be glad to inform you of correct care and operating procedures. The Operator's Manual and Maintenance Booklet are important documents and should be kept with the vehicle.

Service and warranty information

The Service and Warranty Information Booklet contains detailed information about the warranties covering your Mercedes-Benz, including:

- New Car Limited Warranty
- Emission System Warranty
- Emission Performance Warranty
- California, Maine, Massachusetts, and Vermont Emission Control System Warranty (California, Maine, Massachusetts, and Vermont only)
- State Warranty Enforcement Laws (Lemon Laws)

Important notice for California retail buyers and lessees of Mercedes-Benz automobiles

Under California law you may be entitled to a replacement of your vehicle or a refund of the purchase price or lease price, if Mercedes-Benz USA, LLC and/or its authorized repair or service facilities fail to fix one or more substantial defects or malfunctions in the vehicle that are covered by its express warranty after a reasonable number of repair attempts. During the period of 18 months from original delivery of the vehicle or the accumulation of 18 000 miles (approx. 29 000 km) on the odometer of the vehicle, whichever occurs first, a reasonable number of repair attempts is presumed for a retail buyer or lessee if one or more of the following occurs:

- (1) the same substantial defect or malfunction results in a condition that is likely to cause death or serious bodily injury if the vehicle is driven, that defect or malfunction has been subject to repair two or more times, and you have directly notified Mercedes-Benz USA, LLC in writing of the need for its repair,
- (2) the same substantial defect or malfunction of a less serious nature than category (1) has been subject to repair four or more times and you have directly notified us in writing of the need for its repair, or
- (3) the vehicle is out of service by reason of repair of the same or different substantial defects or malfunctions for a cumulative total of more than 30 calendar days.

Written notification should be sent to us, not a dealer, at Mercedes-Benz USA, LLC, Customer Assistance Center, One Mercedes Drive, Montvale, NJ 07645-0350.

Introduction

Operator's Manual

Maintenance

The Maintenance Booklet describes all the necessary maintenance work which should be performed at regular intervals.

Always have the Maintenance Booklet with you when you take the vehicle to your authorized Mercedes-Benz Center for service. The service advisor will record each service in the booklet for you.

Roadside Assistance

The Mercedes-Benz Roadside Assistance Program provides factory trained technical help in the event of a breakdown. Calls to the toll-free Roadside Assistance number

1-800-FOR-MERCEdes (in the USA)
1-800-387-0100 (in Canada)

will be answered by Mercedes-Benz Customer Assistance Representatives 24 hours a day, 365 days a year.

For additional information refer to the Mercedes-Benz Roadside Assistance Program brochure in your vehicle literature portfolio.

Change of address or ownership

If you change your address, be sure to send in the "Change of Address Notice" found in the Service and Warranty Information Booklet, or simply call the Mercedes-Benz Customer Assistance Center (in the USA) at 1-800-FOR-MERCEdes, or Customer Service (in Canada) at 1-800-387-0100. It is in your own interest that we can contact you should the need arise.

If you sell your Mercedes, please leave all literature with the vehicle to make it available to the next operator.

If you bought this vehicle used, be sure to send in the "Notice of Purchase of Used Car" found in the Service and Warranty Information Booklet, or call the Mercedes-Benz Customer Assistance Center (in the USA) at 1-800-FOR-MERCEdes, or Customer Service (in Canada) at 1-800-387-0100.

Operating your vehicle outside the USA or Canada

If you plan to operate your vehicle in foreign countries, please be aware that:

- service facilities or replacement parts may not be readily available,
- unleaded gasoline for vehicles with catalytic converters may not be available; the use of leaded fuels will damage the catalysis,
- gasoline may have a considerably lower octane rating, and improper fuel can cause engine damage.

Certain Mercedes-Benz models are available for delivery in Europe under our European Delivery Program. For details, consult your authorized Mercedes-Benz Center or write to:

In the USA:

Mercedes-Benz USA, LLC
European Delivery Department
One Mercedes Drive
Montvale, NJ 07645-0350

In Canada:

Mercedes-Benz Canada, Inc.
European Delivery Department
98 Vanderhoof Avenue
Toronto, Ontario M4G 4C9

FarmaSOS.com

Introduction

Where to find it

This Operator's Manual is designed to provide comprehensive support information for you, the vehicle operator. For you to find information quickly each section has its own reference color:

At a glance

Here you will find an overview of all the controls that can be operated from the driver's seat.

Getting started

Here you will find all the information you need for your first drive. You should read this section first if this is your first Mercedes-Benz vehicle or if you are renting or borrowing this vehicle.

Safety and Security

Here you will find descriptions of the safety features of your vehicle.

Controls in detail

Here you will find detailed information about the equipment installed in your vehicle. This section expands on the "Getting started" section and also describes technical innovations. If you are already familiar with the basic functions of your vehicle, this section will be of particular interest to you.

Operation

Here you will find all the information you need for the proper operation of your vehicle.

Practical hints

This section provides fast assistance for dealing with problems you may encounter.

Technical data

All important technical data for your vehicle can be found in this section.

Indexes

The glossary provides explanations of the most important technical terms.

The table of contents and the index are designed to help you find information quickly and easily.

The following publications are part of your vehicle documentation:

- this Operator's Manual
- the Maintenance Booklet

Separate operating instructions will be provided as required depending on the equipment options installed in your vehicle.

▼ Symbols

The following symbols are found in this Operator's Manual:

- * Optional equipment is identified with an asterisk. Since standard equipment varies between models, the descriptions and illustrations in this manual may differ slightly from the actual equipment of your vehicle.

Warning!



Warning notices draw your attention to hazards that may endanger your health or life, or the health or life of others.



Highlights hazards that may result in damage to your vehicle.



Helpful hints or further information you may find useful.

- ▶ This symbol points to instructions for you to follow.
- ▶ A number of these symbols appearing in succession indicates a multiple-step procedure.
- ▷ Page This symbol tells you where to look for further information on a topic.
- ▷▷ This continuation symbol marks an interrupted procedure which will be continued on the next page.
- In the glossary of technical terms, this symbol is used to indicate cross-references to term definitions.
- DISPLAY Words appearing in the multi-function display are printed in the type shown here.

Introduction

Operating safety

Warning!



Work improperly carried out on electronic components and associated software could cause them to cease functioning. Because the vehicle's electronic components are interconnected, any modifications made may produce an undesired effect on other systems. Electronic malfunctions could seriously impair the operating safety of your vehicle.

See an authorized Mercedes-Benz Center for repairs or modifications to electronic components.

Other improper work or modifications on the vehicle could also have a negative impact on the operating safety of the vehicle.

Some safety systems only function while the engine is running. You should therefore never turn off the engine while driving.

Warning!



Heavy blows against the vehicle underbody or tires/wheels, for example when running over an obstacle, road debris or a pothole, may cause serious damage and impair the operating safety of your vehicle. If you feel a sudden significant vibration or ride disturbance, or you suspect that damage to your vehicle has occurred, you should turn on your hazard warning flashers, carefully slow down, and drive with caution to an area which is a safe distance from the road.

Inspect the vehicle underbody and tires/wheels for possible damage. If the vehicle appears unsafe, have it towed to the nearest authorized Mercedes-Benz Center or other qualified maintenance or repair facility for further inspection or repairs.

Proper use of the vehicle

Proper use of the vehicle requires that you are familiar with the following information and rules:

- the safety precautions in this manual
- the "Technical data" section in this manual
- traffic rules and regulations
- motor vehicle laws and safety standards

Warning!



Various warning labels are attached to your vehicle. These warning labels are intended to make you and others aware of various risks. You should not remove any of these warning labels unless explicitly instructed to do so by information on the label itself. Removal of any of these labels may cause you and others to be unaware of certain risks which may result in an accident and/or personal injury.

▼ **Problems with your vehicle**

If you should experience a problem with your vehicle, particularly one that you believe may affect its safe operation, we urge you to immediately contact an authorized Mercedes-Benz Center to have the problem diagnosed and corrected if required. If the matter is not handled to your satisfaction, please discuss the problem with the Mercedes-Benz Center management, or if necessary contact us at one of the following addresses:

In the USA:

Customer Assistance Center
Mercedes-Benz USA, LLC
One Mercedes Drive
Montvale, NJ 07645-0350

In Canada:

Customer Relations Department
Mercedes-Benz Canada, Inc.
98 Vanderhoof Avenue
Toronto, Ontario, M4G 4C9

امداد خودرو فارما

تلفن شبانه روزی: ۰۲۱-۸۸۸۶۲۰۸۵

FarmaSOS.com

Introduction

Reporting safety defects

For the USA only:

The following text is published as required of manufacturers under Title 49, Code of U.S. Federal Regulations, Part 575 pursuant to the “National Traffic and Motor Vehicle Safety Act of 1966.”

Reporting safety defects

If you believe that your vehicle has a defect which could cause a crash or could cause injury or death, you should immediately inform the National Highway Traffic Safety Administration (NHTSA) in addition to notifying Mercedes-Benz USA, LLC.

If NHTSA receives similar complaints, it may open an investigation, and if it finds that a safety defect exists in a group of vehicles, it may order a recall and remedy campaign. However, NHTSA cannot become involved in individual problems between you, your dealer, or Mercedes-Benz USA, LLC.

To contact NHTSA, you may either call the Auto Safety Hotline toll-free at 1-888-327-4236 (or 366-0123 in Washington, D.C. area) or write to: NHTSA, U.S. Department of Transportation, Washington, D.C. 20590. You can also obtain other information about motor vehicle safety from the Hotline.

تلفن شبانه روزی: ۰۸۵۰۸۸۸۸-۰۲۱
FarmaSOS.com

▼ Vehicle data recording**Information regarding electronic recording devices**

(Including notice pursuant to California Code § 9951)

Please note that your vehicle is equipped with devices that can record vehicle systems data and, if equipped with the Tele Aid system, may transmit some data in certain accidents.

This information helps, for example, to diagnose vehicle systems after a collision and to continuously improve vehicle safety. DaimlerChrysler may access the information and share it with others

- for safety research or vehicle diagnosis purposes
- with the consent of the vehicle owner or lessee
- in response to an official request by law enforcement or other government agency
- for use in dispute resolution involving DaimlerChrysler, its affiliates or sales/service organization and/or
- as otherwise required or permitted by law.

Please check the Tele Aid subscription service agreement for details regarding the information that may be recorded or transmitted via that system.

FarmaSOS.com



امداد خودرو فارما

تلفن شبانه روزی: ۰۲۱-۸۸۸۶۲۰۸۵

FarmaSOS.com



At a glance

Cockpit

Instrument cluster

Multifunction steering wheel

Center console

Overhead control panel

Door control panel

تلفن شبانه روزی: ۰۲۱-۸۸۸۶۲۰۸۵

FarmaSOS.com

At a glance

Cockpit

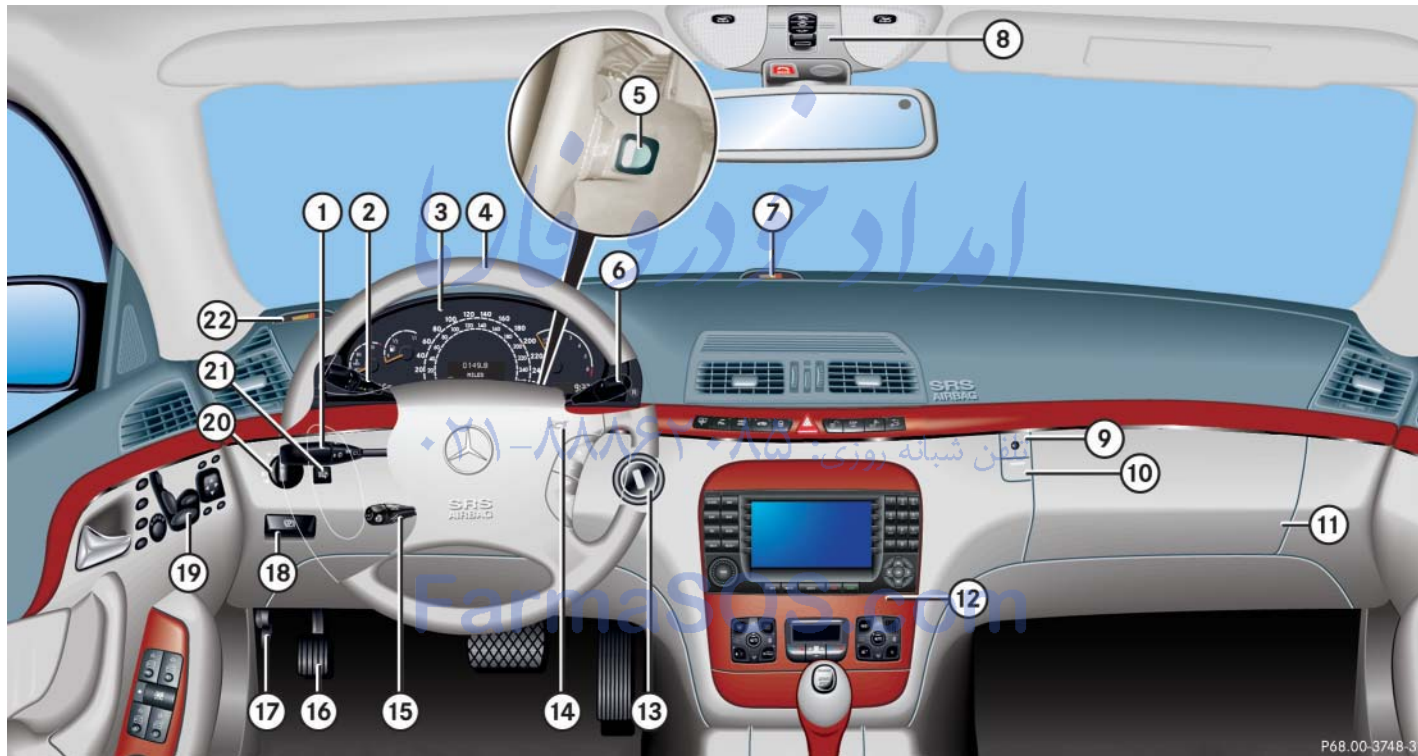

At a glance

Cockpit

Item	Page	Item	Page	Item	Page
① Combination switch		⑥ Lever for voice control system*, see separate operating instructions		⑮ Steering wheel adjustment stalk	40
• Turn signals	51			Heated steering wheel*	253
• Windshield wipers	52	⑦ Front Parktronic* warning indicator for right front area	237	⑯ Parking brake pedal	48
• High beam	135	⑧ Overhead control panel	29	⑰ Hood lock release	286
② Cruise control lever	221	⑨ Glove box lock	244	⑱ Parking brake release	48
• Cruise control	214	⑩ Glove box lid release	244	⑲ Door control panel	30
• Distronic*	217	⑪ Glove box	244	⑳ Exterior lamp switch	131
③ Instrument cluster	24	⑫ Center console	27, 28	㉑ Headlamp washer button*	186
④ Multifunction steering wheel	26	⑬ Starter switch	34	㉒ Front Parktronic* warning indicator for left front area	237
⑤ Steering wheel gearshift control (S 55 AMG only)	181	⑭ Horn			

FarmaSOS.com















At a glance

Instrument cluster



At a glance









Instrument cluster

Item	Page	Item	Page	Item	Page
① Coolant temperature gauge	141	⑥ Right display with:		⑩ Outside temperature indicator	142
② Fuel gauge with fuel tank reserve warning lamp	341	 Seat belt telltale	343	⑪ Left display with:	
③  Left turn signal indicator lamp	51	 High beam headlamp indicator lamp	50	 Supplemental restraint system indicator lamp	345
 Right turn signal indicator lamp	51	 Antilock Brake System (ABS) indicator lamp	338	 Brake warning lamp, USA only	339
④ Speedometer with:		⑦  Reset button	140	 Brake warning lamp, Canada only	
 Electronic Stability Program (ESP) warning lamp	343	⑧ Display with:		 Engine malfunction indicator lamp, USA only	340
 Distance warning lamp	342	• Gear selector lever position	174	 Engine malfunction indicator lamp, Canada only	
Vehicles without DISTRONIC*: Distance warning lamp without function. It illuminates when the ignition is on. It should go out when the engine is running.		• Program mode	174	 Tire inflation pressure warning lamp	307
⑤ Tachometer	142	• Digital clock (see COMAND operating instructions)		⑫ Knob for instrument cluster illumination	140
		⑨ Multifunction display with:			
		• Trip odometer	141		
		• Main odometer	141		

At a glance

Multifunction steering wheel



Item	Page	Item	Page
① Multifunction display	143	④ Menu systems: Press button	144
Operating control system	143	 for next menu  for previous menu	
② Selecting the submenu or setting the volume: Press button	144	⑤ Moving within a menu: Press button	144
 up/to increase  down/to decrease		 for next display  for previous display	
③ Telephone*: Press button	153		
 to take a call to dial a call  to end a call to reject an incoming call			

▼ Center console

Upper part

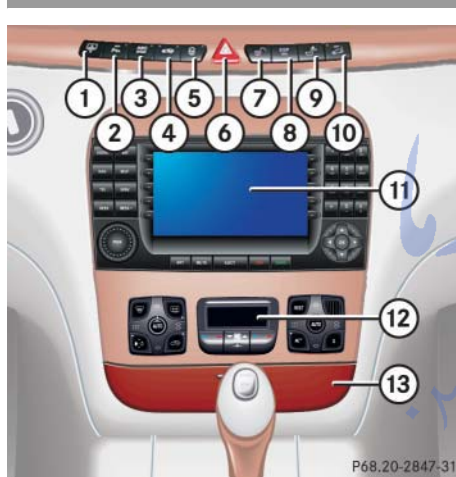

Item	Page	Item	Page
① Switch for rear window sunshade	191	⑨ Rear seat head restraints, switch for folding down	120
② Parktronic* deactivation button	238	⑩ Tow-away alarm switch	90
③ Airmatic or Active Body Control (ABC)* button	231	⑪ COMAND system (see separate operating instructions)	
④ Level control button	233	⑫ Automatic climate control	206
⑤ Central locking switch	113	⑬ Cover of:	
Anti-theft alarm system indicator lamp	87	• Ashtray	251
⑥ Hazard warning flasher on/off switch	136	• Lighter	252
⑦ Central unlocking switch	113		
⑧ Electronic Stability Program (ESP) control switch	83		

At a glance

Center console

Lower part

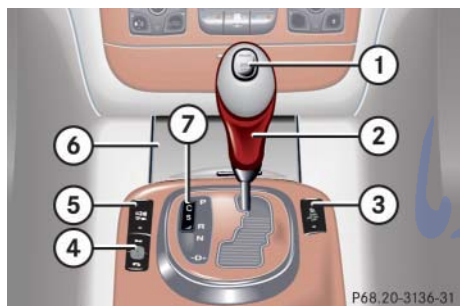

Item	Page
① KEYLESS-GO* start/stop button	35
② Gear selector lever for automatic transmission	46
③ Front passenger front air bag off indicator lamp	73
④ Thumbwheel for setting distance in DISTRONIC*	224
⑤ Distance warning function* on/off button	224
⑥ Lower storage compartments	
⑦ Program mode selector for automatic transmission	179

▼ Overhead control panel

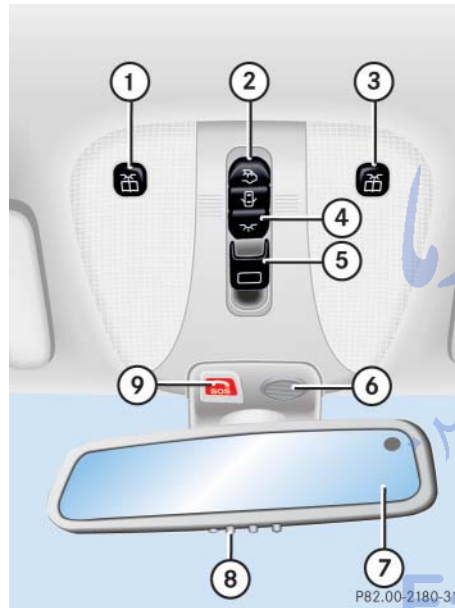

Item	Page
① Left reading lamp on/off	138
② Rear interior lighting on/off	138
③ Right reading lamp on/off	138
④ Interior lighting control	137
⑤ Tilt/sliding sunroof	211
⑥ Hands-free microphone for Tele Aid (emergency call system), telephone*, and voice control system* (see separate operating instructions)	255
⑦ Rear view mirror	41
⑧ Garage door opener	264
⑨ Tele Aid (emergency call system) button	257

At a glance

Door control panel

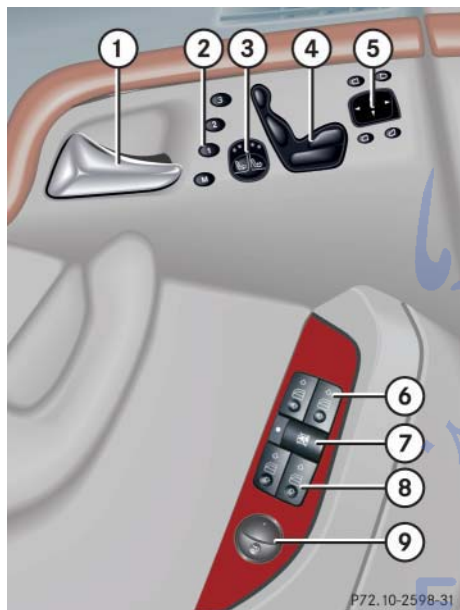

	Item	Page
①	Door handle	102
②	Memory function (for storing seat, exterior mirror, and steering wheel settings)	128
③	Seat heating*	125
	Seat ventilation*	127
④	Seat adjustment	38

	Item	Page
⑤	Exterior mirror adjustment	41, 186
⑥	Switches for opening/closing front door windows	207
⑦	Override switch for rear passenger compartment	78
⑧	Switches for opening/closing rear windows	207
⑨	Remote trunk lid switch	104

تلفن شبانه روزی: ۰۸۵۰۸۸۶۲-۲۱

FarmaSOS.com

Getting started

Unlocking

Adjusting

Driving

Parking and locking

امداد خودرو فارما

شماره تماس: ۰۲۱ ۸۸۴۰۰۵۵

FarmaSOS.com

Getting started

Unlocking



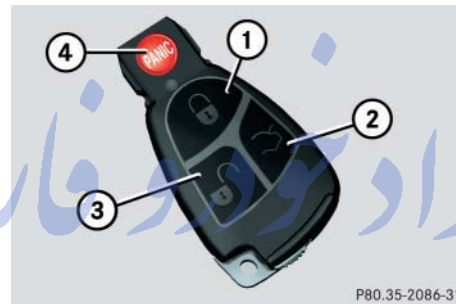

The “Getting started” section provides an overview of the vehicle’s most basic functions. First-time Mercedes-Benz owners should pay special attention to the information given here.

If you are already familiar with the basic functions described here, the “Controls in detail” section will provide you with further information. The corresponding page references are located at the end of each segment.

Unlocking with the SmartKey



SmartKey with remote control

- ①  Lock button
- ②  Opening button for trunk
- ③  Unlock button
- ④  Panic button (▷ page 79)

Warning!



When leaving the vehicle, always remove the SmartKey from the starter switch, take it with you, and lock the vehicle. Do not leave children unattended in the vehicle, or with access to an unlocked vehicle. Unsupervised use of vehicle equipment may cause an accident and/or serious personal injury.

- ▶ Press unlock button  on the SmartKey.

All turn signal lamps flash once. The vehicle unlocks. The locking knobs in the doors move up. The anti-theft alarm system is disarmed.

- ▶ Get in the vehicle and insert the SmartKey in the starter switch.

For more information, see “SmartKey” (▷ page 92).

Getting started

Unlocking

Unlocking with KEYLESS-GO*

With KEYLESS-GO you can open and start your vehicle without using the buttons on the SmartKey.



To unlock the vehicle, the SmartKey with KEYLESS-GO must be outside the vehicle, no further than approx. 3 feet (1 meter) away from the door.

Warning!



When leaving the vehicle, always take the SmartKey with KEYLESS-GO* with you and lock the vehicle. Do not leave children unattended in the vehicle, or with access to an unlocked vehicle. Unsupervised use of vehicle equipment may cause an accident and/or serious personal injury.

- ▶ Grasp the door handle.

All turn signal lamps flash once. The vehicle unlocks. The locking knobs in the doors move up. The anti-theft alarm system is disarmed.



If the vehicle has been parked for more than 72 hours, you must pull the outside door handle in order to activate the KEYLESS-GO function.

- ▶ Get in the vehicle.

For more information, see “SmartKey with KEYLESS-GO*” (▷ page 96).

تلفن شبانه روزی: ۰۲۱-۸۸۶۲۰۸۵

FarmaSOS.com

Getting started

Unlocking

Starter switch positions

Warning!



When leaving the vehicle, always remove the SmartKey or SmartKey with KEYLESS-GO* from the starter switch, take it with you, and lock the vehicle. Do not leave children unattended in the vehicle, or with access to an unlocked vehicle. Unsupervised use of vehicle equipment may cause an accident and/or serious personal injury.

SmartKey

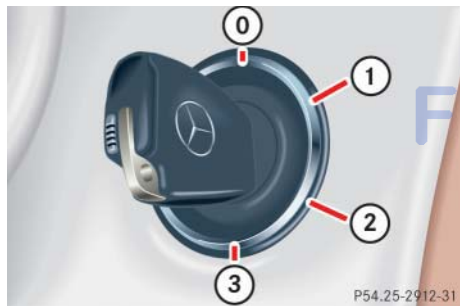

Starter switch

- 0 For removing SmartKey
- 1 Power supply to some electrical consumers, such as seat adjustment
- 2 Ignition (power supply for all electrical consumers) and driving position.
All lamps (except high beam headlamp indicator lamp and turn signal indicator lamps unless activated) in the instrument cluster come on. If a lamp in the instrument cluster fails to come on when the ignition is switched on, have it checked and replaced if necessary. If a lamp in the the instrument cluster remains on after starting the engine or comes on while driving, refer to “Lamps in instrument cluster” (▷ page 338).
- 3 Starting position

i

When you switch on the ignition, the indicator and warning lamps (except high beam headlamp indicator lamp and turn signal indicator lamps unless activated) in the instrument cluster come on. This indicates that the respective systems are operational. The indicator and warning lamps (except high beam headlamp indicator lamp and turn signal indicator lamps unless activated) should go out when the engine is running.

i

The SmartKey can only be removed from the starter switch with the gear selector lever in position **P**.

Getting started

Unlocking



If the SmartKey cannot be turned in the starter switch, the battery may not be sufficiently charged.

- Check the battery and charge it if necessary (▷ page 403).
- Get a jump start (▷ page 406).

To prevent accelerated battery discharge or a completely discharged battery, always remove the SmartKey from the starter switch when the engine is not in operation.

For information on starting the engine using the SmartKey, see “Starting with the SmartKey” (▷ page 46).

SmartKey with KEYLESS-GO*

Pressing the KEYLESS-GO start/stop button on the gear selector lever corresponds to turning the SmartKey to the various starter switch positions.

If you firmly depress the brake pedal during pressing KEYLESS-GO start/stop button, the engine starts automatically.



The function of the SmartKey overrides the KEYLESS-GO function.

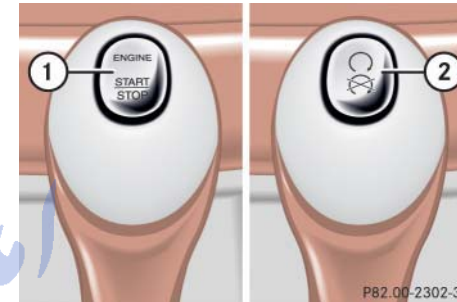

KEYLESS-GO start/stop button

- ① USA only
- ② Canada only

The SmartKey with KEYLESS-GO must be located in the vehicle.

- ▶ Make sure the gear selector lever is set to **P**.
- ▶ Do not depress the brake pedal.

Getting started

Unlocking

Position 0

Before you press the KEYLESS-GO start/stop button ①, the vehicle's on-board electronics have status **0** (as with SmartKey removed).

Position 1

- ▶ Press KEYLESS-GO start/stop button ① once.

This supplies power to some electrical consumers, such as seat adjustment.



If you now press the KEYLESS-GO start/stop button

- once again, the ignition (position **2**) is switched on
- twice, the power supply is again switched off

Ignition (or position 2)

- ▶ Press KEYLESS-GO start/stop button ① twice.

All lamps (except high beam headlamp indicator lamp and turn signal indicator lamps unless activated) in the instrument cluster come on. If a lamp in the instrument cluster fails to come on when the ignition is switched on, have it checked and replaced if necessary. If a lamp in the instrument cluster remains on after starting the engine or comes on while driving, refer to "Lamps in instrument cluster" (▷ page 338).



If you now press the KEYLESS-GO start/stop button once, the power supply is again switched off.



When you switch on the ignition, the indicator and warning lamps (except high beam headlamp indicator lamp and turn signal indicator lamps unless activated) in the instrument cluster come on. This indicates that the respective systems are operational. The indicator and warning lamps (except high beam headlamp indicator lamp and turn signal indicator lamps unless activated) should go out when the engine is running.

For information on starting the engine using the KEYLESS-GO start/stop button, see "Starting with KEYLESS-GO*" (▷ page 47).

▼ Adjusting

Warning!

All seat, head restraint, steering wheel, and rear view mirror adjustments, as well as fastening of seat belts, must be done before the vehicle is put into motion.

Seats**Warning!**

Do not adjust the driver's seat while driving. Adjusting the seat while driving could cause the driver to lose control of the vehicle.

Never ride in a moving vehicle with the seat back in an excessively reclined position as this can be dangerous. You could slide under the seat belt in a collision. If you slide under it, the belt would apply force at the abdomen or neck. That could cause serious or fatal injuries. The seat backrest and seat belts provide the best restraint when the wearer is in a nearly upright position and belts are properly positioned on the body.

Your seat must be adjusted so that you can correctly fasten your seat belt (▷ page 43).

Never place hands under the seat or near any moving parts while a seat is being adjusted.

Warning!

When leaving the vehicle, always remove the SmartKey or SmartKey with KEYLESS-GO* from the starter switch, take it with you, and lock the vehicle.

Even with the SmartKey or SmartKey with KEYLESS-GO* removed from the starter switch or the SmartKey with KEYLESS-GO* removed from the vehicle, the power seats can be operated when the respective door is open. Therefore, do not leave children unattended in the vehicle, or with access to an unlocked vehicle. Unsupervised use of vehicle equipment may cause an accident and/or serious personal injury.

Warning!

Children 12 years old and under must never ride in the front seat, except in a Mercedes-Benz authorized BabySmart™¹ compatible child seat, which operates with the BabySmart™ system installed in the vehicle to deactivate the passenger front air bag when it is properly installed. Otherwise they will be struck by the air bag when it inflates in a crash. If this happens, serious or fatal injury will result.

According to accident statistics, children are safer when properly restrained in the rear seating positions than in the front seating positions. Infants and small children must ride in back seats and be seated in an appropriate infant or child restraint system, which is properly secured with the vehicle's seat belt and top tether strap, or secured via lower anchors and top tether strap, fully in accordance with the child seat manufacturer's instructions. ▷▷

¹ BabySmart™ is a trademark of Siemens Automotive Corp.

Getting started

Adjusting

- ▷▷ A child's risk of serious or fatal injuries is significantly increased if the child restraints are not properly secured in the vehicle and the child is not properly secured in the child restraint.

Seat adjustment

The seat adjustment switches are located on the front doors.

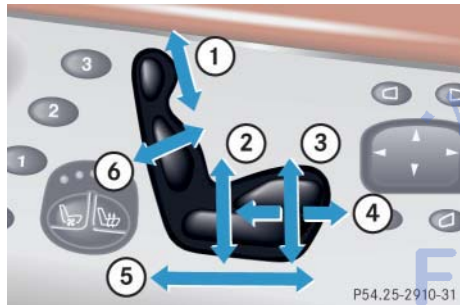

- ① Head restraint height
- ② Seat height
- ③ Seat cushion tilt
- ④ Seat cushion depth
- ⑤ Seat fore and aft adjustment
- ⑥ Seat backrest tilt

- ▶ Switch on ignition (▷ page 34).
- or
- ▶ Open the respective door.

Seat fore and aft adjustment

- ▶ Press the switch forward or backward in the direction of arrow ⑤. Adjust seat to a comfortable seating position that still allows you to reach the accelerator/brake pedal safely. The position should be as far to the rear as possible, consistent with ability to properly operate controls.



When moving the seat, make sure there are no items in the footwell or behind the seats. Otherwise you could damage the seats.

The memory function (▷ page 128) lets you store the setting for the seat position together with the settings for the steering wheel and the exterior rear view mirrors.

Seat cushion tilt

- ▶ Press the switch up or down in the direction of arrow ③ until your upper legs are lightly supported.

Seat cushion depth

- ▶ Press the switch forward or backward in the direction of arrow ④ until your legs are supported comfortably.

Seat backrest tilt

- ▶ Press the switch forward or backward in the direction of arrow ⑥ until your arms are slightly angled when holding the steering wheel.

Seat height

- ▶ Press the switch up or down in the direction of arrow ②.

Head restraint height

- ▶ Press the switch up or down in the direction of arrow ①.

Warning!

For your protection, drive only with properly positioned head restraints.

Adjust head restraint so that the center of the head restraint supports the back of the head at eye level. This will reduce the potential for injury to the head and neck in the event of an accident or similar situation.

Do not drive the vehicle without the seat head restraints. Head restraints are intended to help reduce injuries during an accident.



Adjust the head restraint in such a way that it is as close to the head as possible.

Head restraint tilt

Manually adjust the angle of the head restraint.

- ▶ Push or pull on the lower edge of the head restraint cushion.



Adjust the head restraint in such a way that it is as close to the head as possible.

For more information, see “Seats” (▶ page 114).



The feature below is deactivated at the factory for U.S. vehicles. If you wish to have it activated, contact an authorized Mercedes-Benz Center.

The front passenger seat head restraint automatically lowers after a few seconds when the front passenger seat is not occupied. This improves the driver's outward view as well as the forward view from the rear passenger compartment.

When the front passenger seat is occupied again, the front passenger head restraint returns to the last set position within a few seconds.

If the front passenger seat was moved fore or aft while not being occupied, the front passenger seat head restraint returns to a position that corresponds best with the seat's axial position when the seat is occupied again.

Getting started

Adjusting

Steering wheel

Warning!



Do not adjust the steering wheel while driving. Adjusting the steering wheel while driving could cause the driver to lose control of the vehicle.

When leaving the vehicle, always remove the SmartKey or SmartKey with KEYLESS-GO* from the starter switch, take it with you, and lock the vehicle.

Even with the SmartKey or SmartKey with KEYLESS-GO* removed from the starter switch or the SmartKey with KEYLESS-GO* removed from the vehicle, the steering wheel adjustment feature can be operated when the driver's door is open. Therefore, do not leave children unattended in the vehicle, or with access to an unlocked vehicle. Unsupervised use of vehicle equipment may cause an accident and/or serious personal injury.

Steering wheel adjustment

The stalk for steering wheel adjustment is located on the steering column (lower left).

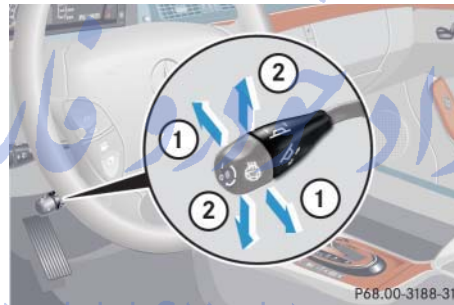

- ① Adjusting steering column, in or out
- ② Adjusting steering column, up or down

► Switch on ignition (▷ page 34).

or

► Open the driver's door.

Adjusting steering column in or out

- Move stalk forward or back in the direction of arrow ① until a comfortable steering wheel position is reached with your arms slightly bent at the elbow.

Adjusting steering column up or down

- Move the stalk up or down in the direction of arrow ②.

Make sure your legs can move freely and all the displays (incl. malfunction and indicator lamps) on the instrument cluster are clearly visible.



The memory function (▷ page 128) lets you store settings for the steering wheel together with the settings for the exterior rear view mirrors and the seat position.

For more information, see “Heated steering wheel*” (▷ page 253).

Mirrors

Adjust the interior and exterior rear view mirrors before driving so that you have a good view of the road and traffic conditions.

Warning!

In the case of an accident, liquid electrolyte may escape the mirror housing if the mirror glass breaks.

Electrolyte has an irritating effect. Do not allow the liquid to come into contact with eyes, skin, clothing, or respiratory system. In case it does, immediately flush affected area with water, and seek medical help if necessary.



Electrolyte drops coming into contact with the vehicle paint finish can only be completely removed while in their liquid state and by applying plenty of water.

Interior rear view mirror

- ▶ Manually adjust the interior rear view mirror.

For more information, see “Rear view mirrors” (> page 186).

Exterior rear view mirror**Warning!**

Exercise care when using the passenger side exterior rear view mirror. The mirror surface is convex (outwardly curved surface for a wider field of view). Objects in mirror are closer than they appear. Check your interior rear view mirror or glance over your shoulder before changing lanes.

Getting started

Adjusting

The buttons are located on the driver's door.

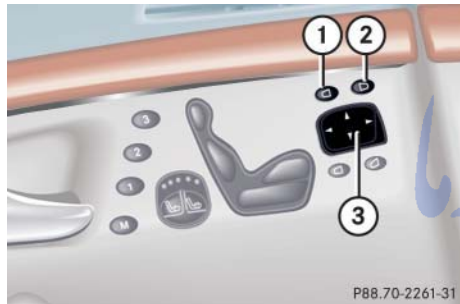

- ① Driver's side exterior rear view mirror button
- ② Passenger-side exterior rear view mirror button
- ③ Adjustment button

- ▶ Switch on ignition (▷ page 34).
- ▶ Press button ① for the left mirror or button ② for the right mirror.
- ▶ Push adjustment button ③ up, down, left, or right according to the desired setting.



For information on how to reposition the exterior mirror housing when it was forcibly pushed forward (hit from the rear) or forcibly pushed rearward (hit from the front), see "Folding exterior rear view mirrors in and out manually" (▷ page 189).



The memory function (▷ page 128) lets you store the setting for the exterior rear view mirrors together with the setting for the steering wheel and the seat position.

At low ambient temperatures, the mirrors will be heated automatically.

For more information, see "Folding exterior rear view mirrors in and out automatically" (▷ page 188).

▼ Driving

Warning!

Do not lay any objects in the driver's footwell. Be careful that floor mats or carpets in the driver's footwell have sufficient clearance for the pedals.

During sudden driving or braking maneuvers the objects could get caught between the pedals. You could then no longer brake or accelerate.

Fastening the seat belts**Warning!**

Always fasten your seat belt before driving off. Always make sure your passengers are properly restrained, even those sitting in the rear and pregnant women.

Failure to wear and properly fasten and position your seat belt greatly increases your risk of injuries and their likely severity in an accident. You and your passengers should always wear seat belts.

If you are ever in an accident, your injuries can be considerably more severe without your seat belt properly buckled. Without your seat belt buckled, you are much more likely to hit the interior of the vehicle or be ejected from it. You can be seriously injured or killed.

In the same crash, the possibility of injury or death is lessened if you are wearing your seat belt. The air bags can only provide the protection they were designed to afford if the occupants are using their seat belts (▷ page 60).

Warning!

Children 12 years old and under must never ride in the front seat, except in a Mercedes-Benz authorized BabySmartTM¹ compatible child seat, which operates with the BabySmartTM system installed in the vehicle to deactivate the passenger front air bag when it is properly installed. Otherwise they will be struck by the air bag when it inflates in a crash. If this happens, serious or fatal injury will result. ▷▷

¹ BabySmartTM is a trademark of Siemens Automotive Corp.

Getting started

Driving

▷▷ According to accident statistics, children are safer when properly restrained in the rear seating positions than in the front seating positions. Infants and small children must ride in back seats and be seated in an appropriate infant or child restraint system, which is properly secured with the vehicle's seat belt and top tether strap, or secured via lower anchors and top tether strap, fully in accordance with the child seat manufacturer's instructions.

A child's risk of serious or fatal injuries is significantly increased if the child restraints are not properly secured in the vehicle and the child is not properly secured in the child restraint.

Warning!



Never let more people ride in the vehicle than there are seat belts available. Be sure everyone riding in the vehicle is correctly restrained with a separate seat belt. Never use a seat belt for more than one person at a time.

Warning!



Never ride in a moving vehicle with the seat backrest in an excessively reclined position as this can be dangerous. You could slide under the seat belt in a collision. If you slide under it, the belt would apply force at the abdomen or neck. That could cause serious or even fatal injuries. The seat backrest and seat belt provide the best restraint when the wearer is in a nearly upright position and the belt is properly positioned on the body.

Warning!



Read and observe the additional warning notices printed in the "Safety and Security" section (▷ page 64).

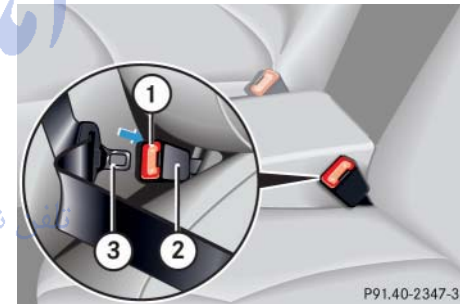

- ① Release button
- ② Buckle
- ③ Latch plate

- ▶ Pull the seat belt smoothly from the seat belt outlet.

- ▶ Place the shoulder portion of the belt across the top of your shoulder and the lap portion across your hips.
- ▶ Push latch plate ③ into buckle ② until it clicks.
- ▶ If necessary, tighten the lap portion to a snug fit by pulling shoulder portion up.

Proper use of seat belts

- Do not twist the belt when fastening.
- Adjust seat belt so that the shoulder portion is located as close as possible to the middle of the shoulder (it should not touch the neck). Never pass the shoulder portion of the belt under your arm.
- Position the lap belt as low as possible on your hips (over hip joint) and not across the abdomen.
- Place the seat backrest in a nearly upright position.
- Never use a seat belt for more than one person at a time.
- Do not fasten a seat belt around a person and another object at the same time. When using a seat belt to secure infant or toddler restraints or children in booster seats, always follow the child seat manufacturer's instructions.
- Check your seat belt during travel to make sure that it is properly positioned.
- Make sure the seat belt is always fitted snugly. Take special care of this when wearing loose clothing.

Warning!



Do not pass belts over sharp edges. They could tear.

Do not allow the belt to get caught in the door or in the seat adjustment mechanism. This could damage the belt.

Never attempt to make modifications to seat belts. This could impair the effectiveness of the belts.

Do not bleach or dye seat belts as this may severely weaken them. In a crash, they may not be able to provide adequate protection.

Damaged seat belts or belts that were highly stressed in an accident must be replaced. Contact an authorized Mercedes-Benz Center.

Getting started

Driving

Starting the engine

Warning!



Inhalation of exhaust gas is hazardous to your health. All exhaust gas contains carbon monoxide, and inhaling it can cause unconsciousness and lead to death.

Do not run the engine in confined areas (such as a garage) which are not properly ventilated. If you think that exhaust gas fumes are entering the vehicle while driving, have the cause determined and corrected immediately. If you must drive under these conditions, drive with at least one window fully open.

Automatic transmission

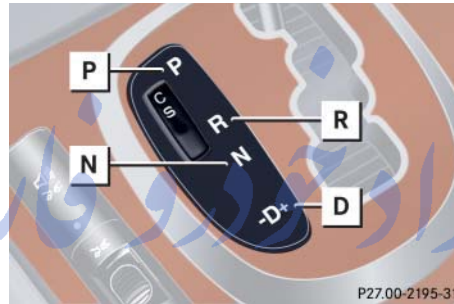

Gearshift pattern for automatic transmission

P Park position with gear selector lever lock

R Reverse gear

N Neutral

D Drive position

For more information, see the “Controls in detail” section (▷ page 173).

Starting with the SmartKey

- ▶ Make sure the gear selector lever is set to **P**.
- ▶ Do not depress accelerator.
- ▶ Turn the SmartKey in the starter switch to position **3** and hold until the engine starts (▷ page 34).



You can also use the “touch-start” function. Turn the SmartKey to position **3** and release it again immediately. The engine then starts automatically.

- ▶ Depress the brake pedal.

The gear selector lever lock is released.

For information on turning off the engine with the SmartKey, see “Turning off with the SmartKey” (▷ page 57).

Starting with KEYLESS-GO*

You can start your vehicle without the SmartKey in the starter switch using the KEYLESS-GO start/stop button on the gear selector lever.

The SmartKey with KEYLESS-GO must be located in the vehicle.

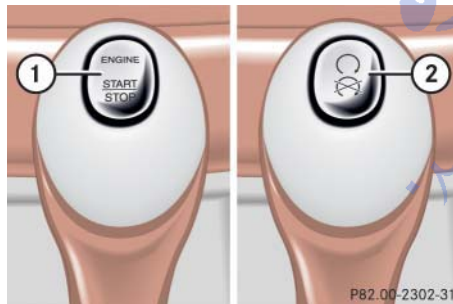
**KEYLESS-GO start/stop button**

- ① USA only
- ② Canada only

- ▶ Make sure the gear selector lever is set to **P**.

- ▶ Depress the brake pedal during the starting procedure. Do not depress accelerator.

The gear selector lever lock is released.

- ▶ Press KEYLESS-GO start/stop button ① once.

The engine starts automatically if the SmartKey with KEYLESS-GO is in the vehicle.

For information on turning off the engine with KEYLESS-GO, see “Turning off the engine with KEYLESS-GO*” (▷ page 57).

Starting difficulties

If the engine does not start as described, carry out the following steps:

- ▶ If you are starting the engine with the SmartKey, turn SmartKey in starter switch to position **0** and repeat starting procedure.

- ▶ If you are starting the engine with KEYLESS-GO: Close any doors that may be open to allow for better detection of the SmartKey with KEYLESS-GO.

or:

Start the engine with the SmartKey as radio signals from another source may be interfering with the SmartKey with KEYLESS-GO.

- ▶ Repeat the starting procedure (▷ page 46). Remember that extended starting attempts can drain the battery.
- ▶ Get a jump start (▷ page 406).

If the engine does not start after several starting attempts, there could be a malfunction in the engine electronics or in the fuel supply system.

- ▶ Notify an authorized Mercedes-Benz Center.

Getting started

Driving

Parking brake

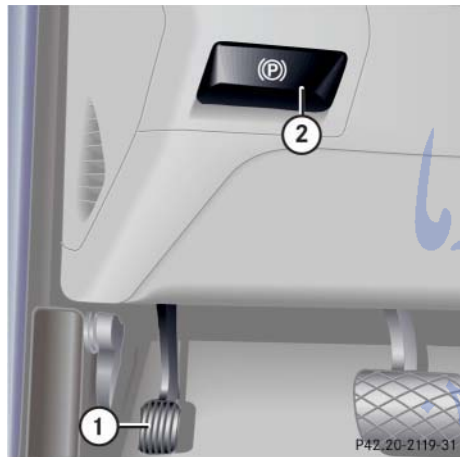

- ① Parking brake pedal
- ② Parking brake release handle

Warning!



When leaving the vehicle, always remove the SmartKey or SmartKey with KEYLESS-GO* from the starter switch, take it with you, and lock the vehicle. Do not leave children unattended in the vehicle, or with access to an unlocked vehicle. Children could release the parking brake, which could result in an accident and/or serious injury.

- ▶ Release the parking brake by pulling handle ②.

The indicator lamp **BRAKE** (USA only) or **(P)** (Canada only) in the instrument cluster goes out.

Driving

- ▶ Depress the brake pedal.
- ▶ Move gear selector lever to position **D** or **R**.

Warning!



It is dangerous to shift the gear selector lever out of **P** or **N** if the engine speed is higher than idle speed. If your foot is not firmly on the brake pedal, the vehicle could accelerate quickly forward or in reverse. You could lose control of the vehicle and hit someone or something. Only shift into gear when the engine is idling normally and when your right foot is firmly on the brake pedal.

FarmaSOS.com

Warning!

On slippery road surfaces, never downshift in order to obtain braking action. This could result in drive wheel slip and reduced vehicle control. Your vehicle's ABS will not prevent this type of loss of control.



In order to avoid damaging the transmission,

- wait for the gear selection process to complete before setting the vehicle in motion.
- place the gear selector lever in position **R** only when the vehicle is stopped.

- ▶ Release the brake pedal.
- ▶ Carefully depress the accelerator pedal.

Once the vehicle is in motion, the automatic central locking system engages and the locking knobs drop down.



If you hear a warning signal and a message appears in the multifunction display when driving off, you have forgotten to release the parking brake.

Release the parking brake.

After a cold start, the automatic transmission shifts at a higher engine revolution. This allows the catalytic converter to reach its operating temperature earlier.



Do not run cold engine at high engine speeds. Running a cold engine at high engine speeds may shorten the service life of the engine.



Simultaneously depressing the accelerator pedal and applying the brake reduces engine performance and causes premature brake and drivetrain wear.



You can open a locked door from the inside. Open doors only when conditions are safe to do so.

You can deactivate the automatic locking using the control system (▷ page 168).

For more information, see “Driving instructions” (▷ page 273).

Getting started

Driving

Switching on headlamps

Low beam headlamps

The exterior lamp switch is located on the dashboard to the left of the steering wheel.

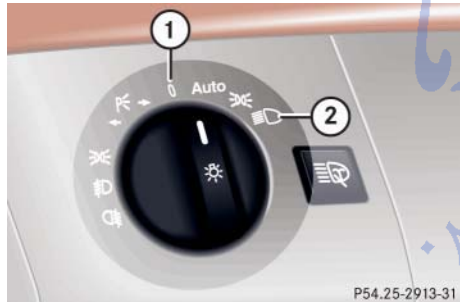

Exterior lamp switch

- ① Off
- ② Low beam headlamps on

► Turn the switch to .

The green indicator lamp  in the exterior lamp switch comes on.

For more information, see “Exterior lamp switch” (▷ page 131).

High beam

The combination switch is located on the left of the steering column.

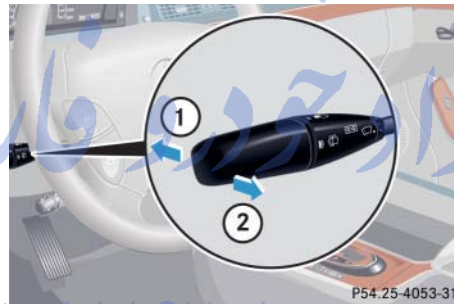

Combination switch

- ① High beam
- ② High beam flasher

► Push combination switch in direction of arrow ①.

The high beam headlamps are switched on.

The high beam headlamp indicator  in the tachometer comes on.

For more information, see “Lighting” (▷ page 131).

Turn signals

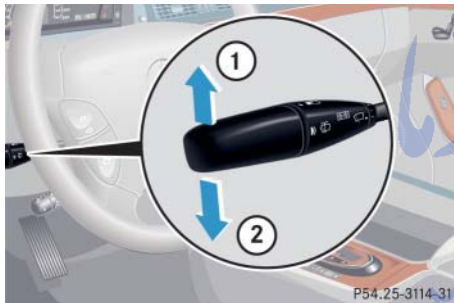

The combination switch is located on the left of the steering column.



Combination switch

- ① Turn signals, right
- ② Turn signals, left

- ▶ Press the combination switch up ① or down ②.

The corresponding turn signal indicator lamp  or  flashes in the instrument cluster (▷ page 24).

The combination switch resets automatically after major steering wheel movements.

i

To signal minor directional changes, e.g. passing or changing lanes, move combination switch to point of resistance only and release. The turn signal flashes three times.

تلفن شبانه روزی: ۰۸۵-۸۸۶۲۰۲۱

FarmaSOS.com

Getting started

Driving

Windshield wipers

The combination switch is located on the left of the steering column.



Combination switch

- ① Single wipe
 - ② Switching on windshield wipers
- Switch on ignition (▷ page 34).

Switching on windshield wipers

- Turn the combination switch to the desired position depending on the intensity of the rain.

- 0 Windshield wipers off
- I Intermittent wiping (interval dependent on wetness of windshield)
- II Normal wiper speed
- III Fast wiper speed

i Intermittent wiping interval is dependent on wetness of windshield. After the initial wipe, pauses between wipes are automatically controlled by the rain sensor.



Do not leave windshield wipers in intermittent setting when vehicle is taken to an automatic car wash or during windshield cleaning. Wipers will operate in the presence of water sprayed on the windshield, and wipers may be damaged as a result.

The switch should not be left in intermittent setting as the wipers will wipe the windshield once every time the engine is started. Dust that accumulates on the windshield might scratch the glass and/or damage the wiper blades when wiping occurs on a dry windshield.

Intermittent wiping

- ▶ Set the wiper switch to position **I**.



Intermittent wiping is interrupted when the vehicle is at a standstill and a front door is opened.

Single wipe

- ▶ Press the combination switch briefly in direction of arrow ①.

The windshield wipers wipe one time without washer fluid.

Wiping with windshield washer fluid

- ▶ Press switch in the direction of arrow ① past the resistance point.

The windshield wiper operates with washer fluid.

For information on filling up the washer reservoir, see “Windshield washer system and headlamp cleaning system*” (▷ page 295).



If anything blocks the windshield wipers (leaves, snow, etc.), switch them off immediately.

- For safety reasons,
 - turn off the engine by turning the SmartKey to position **0** and withdraw SmartKey from starter switch

or

- turn off the engine by pressing the KEYLESS-GO* start/stop button (▷ page 35) and open the driver’s door (with the driver’s door open, starter switch is in position **0**, same as with SmartKey removed from starter switch)

before attempting to remove any blockage.

- Remove blockage.
- Turn the windshield wipers on again.

If windshield wipers fail to function at all in switch position **I**,

- set the combination switch to the next highest wiper speed
- have the windshield wipers checked at the nearest authorized Mercedes-Benz Center

Getting started

Driving

Problems while driving

The engine runs erratically and misfires

- An ignition cable may be damaged.
- The engine electronics may not be operating properly.
- Unburned gasoline may have entered the catalytic converter and damaged it.
- ▶ Give very little gas.
- ▶ Have the problem repaired by an authorized Mercedes-Benz Center as soon as possible.

The coolant temperature is above 248°F (120°C)

The coolant is too hot and is no longer cooling the engine.

- ▶ Stop the vehicle as soon as possible and turn off the engine. Allow engine and coolant to cool.
- ▶ Check the coolant level and add coolant if necessary (▷ page 292).



Excessive coolant temperatures trigger a warning message in the multifunction display (▷ page 359).

In case of accident

If the vehicle is leaking gasoline:

- ▶ Do not start the engine under any circumstances.
- ▶ Notify local fire and/or police authorities.

If the extent of the damage cannot be determined:

- ▶ Notify an authorized Mercedes-Benz Center.

If no damage can be determined on the

- major assemblies
- fuel system
- engine mount:
- ▶ Start the engine in the usual manner.

▼ Parking and locking

You have now completed your first drive. You have properly stopped and parked your vehicle. End your drive as follows.

Warning!



With the engine not running, there is no power assistance for the brake and the steering systems. In this case, it is important to keep in mind that a considerably higher degree of effort is necessary to brake and steer the vehicle.

Warning!



Do not park this vehicle in areas where combustible materials such as grass, hay, or leaves can come into contact with the hot exhaust system, as these materials could be ignited and cause a vehicle fire.

To reduce the risk of personal injury as a result of vehicle movement, before turning off the engine and leaving the vehicle always:

- Keep right foot on brake pedal.
- Firmly depress parking brake pedal.
- Move the gear selector lever to position **P**.
- Slowly release brake pedal.
- When parked on an incline, turn front wheel towards the road curb.

- Turn the SmartKey to starter switch position **0** and remove, or press KEYLESS-GO* start/stop button (> page 35).
- Take the SmartKey or the SmartKey with KEYLESS-GO* with you and lock vehicle when leaving.

Getting started

Parking and locking

Parking brake



- ① Parking brake
- ② Release handle

- ▶ Step firmly on parking brake ①.

When the engine is running, the indicator lamp **BRAKE** (USA only) or **(P)** (Canada only) in the instrument cluster illuminates.

Warning!



When leaving the vehicle, always remove the SmartKey or SmartKey with KEYLESS-GO* from the starter switch, take it with you, and lock the vehicle. Do not leave children unattended in the vehicle, or with access to an unlocked vehicle. Children could release the parking brake and/or move the gear selector lever from position **P**, either of which could result in an accident and/or serious injury.

Warning!



Getting out of your vehicle with the gear selector lever not fully engaged in position **P** is dangerous. Also, when parked on an incline, position **P** alone may not prevent your vehicle from moving, possibly hitting people or objects.

Always set the parking brake in addition to shifting to position **P** (▷ page 177).

When parked on an incline, turn front wheels towards the road curb.

FarmaSOS.com

Switching off headlamps

- ▶ Turn the exterior lamp switch to **0**.
For more information, see “Lighting” (▷ page 131).

Turning off the engine

- ▶ Place the gear selector lever in position **P**.



Always set the parking brake in addition to shifting to position **P**.

On slopes, turn the front wheels towards the curb.

Turning off with the SmartKey

- ▶ Turn the SmartKey in the starter switch (▷ page 34) to position **0** and remove it.
The immobilizer is activated.



The SmartKey can only be removed from the starter switch with the gear selector lever in position **P**.

- ▶ Press the seat belt release button (▷ page 44).
Allow the retractor to completely re-wind the seat belt by guiding the latch plate.



With the SmartKey removed and the driver's door open, a warning sounds if the vehicle's exterior lamps are not switched off.

Turning off the engine with KEYLESS-GO*

- ▶ Place the gear selector lever in position **P**.
- ▶ Press the KEYLESS-GO start/stop button (▷ page 35) to shut off the engine.

With the driver's door closed, the starter switch is now in position **1**. With the driver's door opened, the starter switch is set to position **0**, same as SmartKey removed from starter switch (▷ page 34).

- ▶ Press the seat belt release button (▷ page 44).

Allow the retractor to completely re-wind the seat belt by guiding the latch plate.



If you hear a warning signal, you have either

- forgotten to turn off the lights before opening the driver's door
- or
- tried to turn off the engine while the gear selector lever is not in **P**.

Turn off the lights or place the gear selector lever in **P**.

Getting started

Parking and locking

Locking

Warning!



To prevent possible personal injury, always keep hands and fingers away from the door openings when closing the doors. Be especially careful when small children are around.

Before closing doors, make sure there is no possibility of someone getting caught in a door during closing.

Warning!



When leaving the vehicle, always remove the SmartKey or SmartKey with KEYLESS-GO* from the starter switch, take it with you, and lock the vehicle. Do not leave children unattended in the vehicle, or with access to an unlocked vehicle. Unsupervised use of vehicle equipment may cause an accident and/or serious personal injury.

Locking with the SmartKey

- ▶ After exiting the vehicle press the lock button  on the SmartKey (▷ page 32).

All turn signal lamps flash three times. The locking knobs on the doors move down.

For more information, see “SmartKey” (▷ page 92).

Locking with KEYLESS-GO*

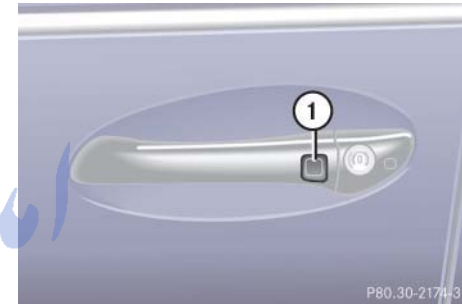

- ① Lock button on the outside door handle

- ▶ After exiting the vehicle, press lock button ① on the outside door handle or on the trunk lid (▷ page 101).

The turn signal indicators come on briefly. The vehicle locks. The locking knobs in the doors move down. The anti-theft alarm system is armed.

For more information, see “SmartKey with KEYLESS-GO*” (▷ page 96).

Safety and Security

Occupant safety

Panic alarm

Driving safety systems

Anti-theft systems

امداد خودرو فارما

تلفن شبانه روزی: ۰۲۱-۸۸۶۲۱۰۵

Farmasoc.com

S-Class

Safety and Security

Occupant safety

In this section you will learn the most important facts about the restraint systems of the vehicle.

The restraint systems are:

- Seat belts
- Emergency tensioning device
- Air bags
- Child seats
- Child seat recognition
- Lower anchors and tethers for children (LATCH)
- Preventive occupant safety (PRE-SAFE)

As independent systems, their protective effects work in conjunction with each other.



For information on infants and children traveling with you in the vehicle and restraint systems for infants and children, see “Children in the vehicle” (▷ page 71).

The **SRS** indicator lamp in the instrument cluster comes on

- for about four seconds when you turn the SmartKey in the starter switch to position **1** or press the KEYLESS-GO* start/stop button (▷ page 35) once. It then goes out briefly, comes on again and remains lit until you start the engine.
- for about four seconds when you start the engine by turning the SmartKey or pressing the KEYLESS-GO* start/stop button.



The **SRS** indicator lamp remains lit if the SmartKey is turned to position **2** and left there or the KEYLESS-GO* start/stop button is pressed twice. The indicator lamp will go out when you start the engine.

The restraint systems are fully operational if the **SRS** indicator lamp is not lit when the engine is running.

A malfunction in the system has been detected if the **SRS** indicator lamp:

- fails to extinguish after approximately four seconds.
- does not come on at all.
- comes on after the engine was started or while driving.

For safety reasons, we strongly recommend that you visit an authorized Mercedes-Benz Center immediately to have the system checked.

For more information, see “Practical hints” (e page 337).

Warning!



In the event that the **SRS** indicator lamp comes on during driving or does not come on at all, the SRS self-check has detected a malfunction. For your safety, we strongly recommend that you visit an authorized Mercedes-Benz Center immediately to have the system checked; otherwise the SRS may not be activated when needed in an accident, which could result in serious or fatal injury, or it might deploy unexpectedly and unnecessarily which could also result in injury.

In addition, improper repair work on the SRS creates a risk of rendering the SRS inoperative or causing unintended air bag deployment. Work on the SRS must therefore only be performed by qualified technicians. Contact an authorized Mercedes-Benz Center.

Air bags

Warning!



Air bags are designed to reduce the potential of injury and fatality in certain frontal impacts (front air bags), side impacts (side impact air bags and head protection window curtain air bags) or rollovers (head protection window curtain air bags). However, no system available today can totally eliminate injuries and fatalities.

The activation of the air bags temporarily releases a small amount of dust from the air bags. This dust, however, is neither injurious to your health, nor does it indicate a fire in the vehicle. The dust might cause some temporary breathing difficulty for people with asthma or other breathing trouble. To avoid this, you may wish to get out of the vehicle as soon as it is safe to do so. If you have any breathing difficulty but cannot get out of the vehicle after the air bag inflates, then get fresh air by opening a window or door.

Warning!



To reduce the risk of injury when the front air bags inflate, it is very important for the driver and passenger front to always be in a properly seated position and to wear your seat belts.

For maximum protection in the event of a collision always be in normal seated position with your back against the seat backrest. Fasten your seat belt and make sure it is properly positioned on your body.

Since the air bag inflates with considerable speed and force, a proper seating and hands on steering wheel position will help to keep you at a safe distance from the air bag. Occupants who are unbelted, out of position or too close to the air bag can be seriously injured by an air bag as it inflates with great force in the blink of an eye:

- Sit properly belted in a nearly upright position with your back against the seat backrest.



Safety and Security

Occupant safety



- Adjust the driver seat as far as possible rearward, still permitting proper operation of vehicle controls. The distance from the center of the driver's breastbone to the center of the air bag cover on the steering wheel must be at least 10 in (25 cm) or more. You should be able to accomplish this by a combination of adjustments to the seat and steering wheel. If you have any problems, please see an authorized Mercedes-Benz Center.
- Do not lean with your head or chest close to the steering wheel or dashboard.
- Keep hands on the outside of steering wheel rim. Placing hands and arms inside the rim can increase the risk and potential severity of hand/arm injury when driver front air bag inflates.
- Adjust the front passenger seat as far as possible rearward from the dashboard when the seat is occupied.
- Occupants, especially children, should never lean their heads in the area of the door where the side air bag inflates.

This could result in serious injuries or death should the air bag be triggered. Always sit nearly upright, properly use the seat belts and appropriate size infant or child restraint system.

- Children 12 years old and under must never ride in the front seat, except in a Mercedes-Benz authorized BabySmart^{TM1} compatible child seat, which operates with the BabySmartTM system installed in the vehicle to deactivate the passenger front air bag when it is properly installed. Otherwise they will be struck by the air bag when it inflates in a crash. If this happens, serious or fatal injury will result.

Failure to follow these instructions can result in severe injuries to you or other occupants.

If you sell your vehicle, it is important that you make the buyer aware of this safety information. Be sure to give the buyer this Operator's Manual.

¹ BabySmartTM is a trademark of Siemens Automotive Corp.

Warning!



Accident research shows that the safest place for children in an automobile is in the rear seat. Should you choose to place a child 12 years old or under in the front passenger seat of your vehicle, you must properly use a BabySmartTM child restraint which will turn off the passenger front air bag. BabySmartTM will not, however, turn off any side impact air bag.

It should be noted that with respect to both front and rear side impact air bags there is a possibility for a side air bag related injury if occupants, especially children, are not properly seated or restrained when next to a side air bag which needs to deploy rapidly in a side impact in order to do its job.

To help avoid the possibility of injury, please follow these guidelines:

- (1) Occupants, especially children, should never place their bodies or lean their heads in the area of the door where the side air bag inflates. This could result in

Safety and Security

Occupant safety

serious injuries or death should the side air bag be activated.

- (2) Always sit nearly upright, properly use the seat belts and use an appropriately sized infant or child restraint system for all children 12 years old or under.
- (3) Always wear seat belts properly.

If you believe that, even with the use of these guidelines, it would be safer for your rear seat occupants to have the rear mounted side air bags deactivated, then deactivation can be accomplished upon your written request to do so at your authorized Mercedes-Benz Center at an additional cost.

Please contact your local authorized Mercedes-Benz Center or call our Customer Assistance Center at 1-800-FOR-MERCEdes (1-800-367-6372) for details.



Air bags are designed to activate only in certain frontal (front air bags) impacts, side impacts (side impact and head protection window curtain air bags) which exceed preset thresholds, and in certain rollovers (head protection window curtain air bags). Only during these events will they provide their supplemental protection.

The driver and passengers should always wear their seat belts. Otherwise it is not possible for air bags to provide their supplemental protection.

In case of other types of impacts and impacts below air bag deployment thresholds, air bags will not be activated. The driver and passengers will then be protected to the extent possible by a properly fastened seat belt. A properly fastened seat belt is also needed to provide the best possible protection in a rollover.

We caution you not to rely on the presence of the air bags in order to avoid wearing your seat belt.

Your vehicle was originally equipped with air bags that are designed to activate in certain impacts exceeding a preset threshold to reduce the potential and severity of injury. It is important for your safety and that of your passengers that you replace deployed air bags and repair any malfunctioning air bags to make sure the vehicle will continue to provide supplemental crash protection for occupants.

Safety and Security

Occupant safety

Safety guidelines for the seat belt, emergency tensioning device and air bag

Warning!



- Damaged seat belts or belts that were highly stressed in an accident must be replaced and their anchoring points must also be checked. Use only belts installed or supplied by an authorized Mercedes-Benz Center.
- Air bags and pyrotechnic emergency tensioning devices (ETDs) are designed to function on a one-time only basis. An air bag or ETD that was activated must be replaced. PRE-SAFE has electrically operated reversible pre-tensioners in addition to the pyrotechnic ETDs.
- No modifications of any kind may be made to any components or wiring of the SRS. This includes changing or removing any component or part of the SRS, the installation of additional trim material, badges, etc. over the steering wheel hub, passenger front air bag

cover, door trim panels, or door frame trims, and installation of additional electrical/electronic equipment on or near SRS components and wiring. Keep area between air bags and occupants free from objects (e.g. packages, purses, umbrellas, etc.).

- Do not pass belts over sharp edges. They could tear.
- Do not make any modification that could change the effectiveness of the belts.
- Do not bleach or dye seat belts as this may severely weaken them. In a crash they may not be able to provide adequate protection.
- Do not hang items such as coat hangers from the coat hooks or handles over the door. These items may turn into projectiles and cause head and other injuries when curtain air bag is deployed.
- Never place your feet on the instrument panel, dashboard, or on the seat. Always keep both feet on the floor in front of the seat.

- Air bag system components will be hot after the air bag has inflated. Do not touch.
- In addition, improper repair work on the SRS creates a risk of rendering the SRS inoperative or causing unintended air bag deployment. Work on the SRS must therefore only be performed by qualified technicians. Contact an authorized Mercedes-Benz Center.
- For your protection and the protection of others, when scrapping the air bag unit or emergency tensioning device, our safety instructions must be followed. These instructions are available from your authorized Mercedes-Benz Center.
- Given the considerable deployment speed and the textile structure of the air bags, there is the possibility of abrasions or other injuries resulting from air bag deployment.

Safety and Security

Occupant safety

When you sell your vehicle we strongly urge you to give notice to the subsequent owner that it is equipped with an SRS by alerting them to the applicable section in the Operator's Manual.

Front air bags



① Driver's air bag

② Passenger front air bag

Driver's and front passenger air bags are deployed:

- in the event of certain frontal impacts
- if impact exceeds a preset deployment threshold
- independently of the side impact air bags

The air bags will not deploy in impacts which do not exceed the system's deployment thresholds. You will then be protected by the fastened seat belts.

The passenger front air bag will only be deployed if:

- the front passenger seat is occupied
- the  indicator lamp in the lower part of the front center console is not lit (▷ page 73)
- the impact exceeds a preset deployment threshold



Do not place objects heavier than 20 lbs (9 kg) on the front passenger seat. This could cause the front or side impact air bag on the front passenger side to deploy in a crash which exceeds the system's deployment threshold.

Side impact air bags

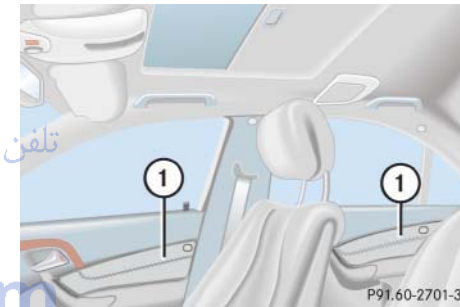

① Side impact air bags

Safety and Security

Occupant safety

The side impact air bags are deployed:

- in impacts exceeding a preset deployment threshold
- on the impacted side of the vehicle
- independently of the front air bags

The side impact air bags are not deployed in impacts which do not exceed the system's deployment threshold.

The front passenger side impact air bag will only deploy if the system senses that the front passenger seat is occupied.

Window curtain air bags

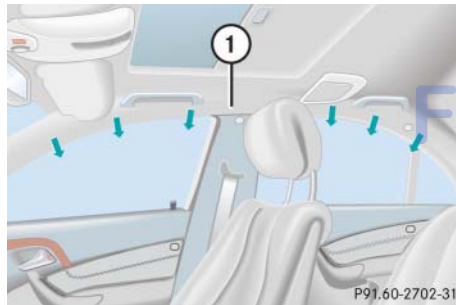

① Window curtain air bag



The side window curtain air bags are deployed:

- in impacts exceeding a preset deployment threshold
- on the impacted side of the vehicle
- independently of the front air bags
- in certain vehicle rollovers

The side window curtain air bags are not deployed in impacts which do not exceed the system's deployment threshold.

The window curtain air bags fill up the area between the A and C pillars (see arrows).

Seat belts

When the engine is started, the seat belt telltale  illuminates to remind you and your passengers to fasten your seat belts. If the driver's seat belt is not fastened before the engine is started, the seat belt telltale  illuminates and a warning chime sounds for approximately six seconds when the engine is started.

The use of seat belts and infant and child restraint systems is required by law in all 50 states, the District of Columbia, the U.S. territories and all Canadian provinces. Even where this is not the case, all vehicle occupants should have their seat belts fastened whenever the vehicle is in motion.

For more information, see "Fastening the seat belts" (▷ page 43).

Safety and Security

Occupant safety



For information on infants and children traveling with you in the vehicle and restraint systems for infants and children, see “Children in the vehicle” (▷ page 71).

Warning!



Always fasten your seat belt before driving off. Always make sure your passengers are properly restrained, even those sitting in the rear and pregnant women.

Failure to wear and properly fasten and position your seat belt greatly increases your risk of injuries and their likely severity in an accident. You and your passengers should always wear seat belts.

If you are ever in an accident, your injuries can be considerably more severe without your seat belt properly buckled. Without your seat belt buckled, you are much more likely to hit the interior of the vehicle or be ejected from it. You can be seriously injured or killed.

In the same crash, the possibility of injury or death is lessened if you are properly wearing your seat belt. Air bags can only protect as they are designed if the occupants are properly wearing their seat belts.

Warning!



Never ride in a moving vehicle with the seat backrest in an excessively reclined position as this can be dangerous. You could slide under the seat belt in a collision. If you slide under it, the belt would apply force at the abdomen or neck. That could cause serious or even fatal injuries. The seat backrest and seat belt provide the best restraint when the wearer is in a nearly upright position and the belt is properly positioned on the body.

Warning!



Never let more people ride in the vehicle than there are seat belts available. Be sure everyone riding in the vehicle is correctly restrained with a separate seat belt. Never use a seat belt for more than one person at a time.

تلفن شبانه روزی: ۰۸۵ ۰۸۸۶۲ ۰۲۱

FarmaSOS.com

Safety and Security

Occupant safety

Warning!



Damaged seat belts or belts that were highly stressed in an accident must be replaced and their anchoring points must also be checked.

Only use seat belts which have been approved by Mercedes-Benz.

Do not make any modifications to the seat belts. This can lead to unintended activation or to failure.

Do not bleach or dye seat belts as this may severely weaken them. In a crash, they may not be able to provide adequate protection.

Have all work carried out only by qualified technicians. Contact an authorized Mercedes-Benz Center.

Warning!



USE SEAT BELTS PROPERLY

- Seat belts can only work when used properly. Never wear seat belts in any other way than as described in this section, as that could result in serious injuries in case of an accident.
- Each occupant should wear their seat belt at all times, because seat belts help reduce the likelihood of and potential severity of injuries in accidents, including rollovers. The integrated restraint system includes SRS (driver air bag, passenger front air bag, side impact air bags, head protection window curtain air bags for side windows), ETD (seat belt emergency tensioning device), and front seat knee bolsters. The system is designed to enhance the protection offered to properly belted occupants in certain frontal (front air bags and ETD) and side (side impact, window curtain air bags and ETD) impacts which exceed preset deployment thresholds and in certain

rollovers (window curtain air bags and ETD).

- Never wear the shoulder belt under your arm, against your neck or off your shoulder. In a crash, your body would move too far forward. That would increase the chance of head and neck injuries. The belt would also apply too much force to the ribs or abdomen, which could severely injure internal organs such as your liver or spleen.
- Never wear belts over rigid or breakable objects in or on your clothing, such as eyeglasses, pens, keys, etc., as these might cause injuries.
- Position the lap belt as low as possible on your hips and not across the abdomen. If the belt is positioned across your abdomen, it could cause serious injuries in a crash.
- Never use a seat belt for more than one person at a time. Do not fasten a seat belt around a person and another person or other objects.

- Belts should not be worn twisted. In a crash, you wouldn't have the full width of the belt to manage impact forces. The twisted belt against your body could cause injuries.
- Pregnant women should also use a lap-shoulder belt. The lap belt portion should be positioned as low as possible on the hips to avoid any possible pressure on the abdomen.
- Never place your feet on the instrument panel, dashboard or on the seat. Always keep both feet on the floor in front of the seat.

Emergency tensioning device (ETD), seat belt force limiter

The seat belts for the front and rear outer seats are equipped with emergency tensioning devices and belt force limiters.

The ETD is designed to activate in the following cases:

- in frontal or rear-end impact exceeding a preset severity level
- in certain vehicle rollovers
- if the restraint systems are operational and functioning correctly, see **SRS** indicator lamp (▷ page 60)



The ETDs for the front seats will only activate if the respective front seat belt is fastened (latch plate properly inserted into buckle).

The ETDs for the rear outer seats will activate with or without the respective seat belt fastened.

In an impact, emergency tensioning devices remove slack from the belts in such a way that the seat belts fit more snugly against the body. Belt force limiters reduce the force exerted by the seat belts on occupants during a crash.

Warning!



A pyrotechnic emergency tensioning device (ETD) that was activated must be replaced.

When disposing of the pyrotechnic emergency tensioning device, our safety instructions must be followed. These are available at your authorized Mercedes-Benz Center.

PRE-SAFE has electrically operated reversible pre-tensioners that do not require replacement after activation.

Safety and Security

Occupant safety



Do not place objects heavier than 20 lbs (9 kg) on the front passenger seat. This could cause the front or side impact air bag on the front passenger side to deploy in a crash which exceeds the system's deployment threshold.

Automatic comfort-fit feature seat belt

An automatic comfort-fit feature for front seats and for the rear outer seats (only for vehicles with electrically adjustable rear bench seat* or with individual seats* in the rear) reduces the retracting force of the seat belts when they are in normal use.

Preventive occupant safety (PRE-SAFE)

Warning



The PRE-SAFE system is intended to reduce the effects of an accident on properly seat belted vehicle occupants. Despite having the PRE-SAFE systems in your car, the possibility of injuries occurring as a result of an accident cannot be totally eliminated. Therefore you should always drive carefully and adjust your driving to the prevailing road, weather, and traffic conditions.

Your vehicle automatically takes preventive measures to better protect the occupants in the following hazardous situations:

- You execute an emergency braking maneuver and the Brake Assist System (> page 81) is activated.
- The PRE-SAFE system detects a critical driving dynamics situation.

In such cases, the following systems are automatically activated:

- A front seat belt with the seat belt buckled is pre-tensioned electrically.
- If the occupied front passenger seat or rear seats are in an unfavorable position, they are adjusted to a better position. Rear seat adjustment occurs only in vehicles with individual seats* in the rear.
- The tilt/sliding sunroof closes if the vehicle is in a severe skid or is spinning.



The PRE-SAFE systems are activated in the previously described circumstances only at speeds exceeding 22 mph (35 km/h).

When the driving dynamic situation has passed without an accident occurring, the pre-tensioning on the seat belts is deactivated.

You can then adjust the seats and the tilt/sliding sunroof to their previous position.

If the seat belts do not release:

- ▶ Adjust the backrest or seat slightly to the rear until the seat belt tension is diminished.

The locking mechanism releases.

Children in the vehicle

If an infant or child is traveling with you in the vehicle:

- Secure the child using an infant or child restraint appropriate for the age and size of the child.
- Make sure the infant or child is properly secured at all times while the vehicle is in motion.

Infant and child restraint seats and information on choosing an appropriate restraint system can be obtained from any authorized Mercedes-Benz Center.

Infant and child restraint systems

Use only a BabySmart^{TM1} compatible child restraint for the front passenger seat in this vehicle.

We recommend all infants and children be properly restrained at all times while the vehicle is in motion.

¹ BabySmartTM is a trademark of Siemens Automotive Corp.

All lap-shoulder belts except the driver's seat belt have special seat belt retractors for secure fastening of child restraints.

To fasten a child restraint, follow child restraint instructions for mounting. Then pull the shoulder belt out completely and let it retract. During seat belt retraction, a ratcheting sound can be heard to indicate that the special seat belt retractor is activated. The belt is now locked. Push down on child restraint to take up any slack.

To deactivate, release seat belt buckle and let seat belt retract completely. The seat belt can again be used in the usual manner.



For more information on child seats with mounting fittings for tether anchorages, see "Installation of infant and child restraint systems" (▷ page 75).

For information on LATCH-type child seat mounts (▷ page 76).

Safety and Security

Occupant safety

Warning!



Never release the seat belt buckle while the vehicle is in motion, since the special seat belt retractor will be deactivated.



The use of infant or child restraints is required by law in all 50 states, the District of Columbia, the U.S. territories, and all Canadian provinces.

Infants and small children should be seated in an appropriate infant or child restraint system properly secured by a lap-shoulder belt or, if so equipped, a child restraint lower anchorage system that complies with U.S. Federal Motor Vehicle Safety Standards 213 and 225 and Canadian Motor Vehicle Safety Standards 213 and 210.2.

A statement by the child restraint manufacturer of compliance with this standard can be found on the instruction label on the restraint and in the instruction manual provided with the restraint.

When using any infant or child restraint system, be sure to carefully read and follow all manufacturer's instructions for installation and use.

Please read and observe warning labels affixed to inside of vehicle and to infant or child restraints.

Warning!



Children 12 years old and under must never ride in the front seat, except in a Mercedes-Benz authorized BabySmartTM¹ compatible child seat, which operates with the BabySmartTM system installed in the vehicle to deactivate the passenger front air bag when it is properly installed. Otherwise they will be struck by the air bag when it inflates in a crash. If this happens, serious or fatal injury will result.

According to accident statistics, children are safer when properly restrained in the rear seating positions than in the front seating positions. Infants and small children must ride in back seats and be seated in an appropriate infant or child restraint system, which is properly secured with the vehicle's seat belt and top tether strap, or secured via lower anchors and top tether strap, fully in accordance with the child seat manufacturer's instructions.

¹ BabySmartTM is a trademark of Siemens Automotive Corp.

Safety and Security

Occupant safety

Infants and small children should never share a seat belt with another occupant. During an accident, they could be crushed between the occupant and seat belt.

Children too big for child restraint systems must ride in back seats using regular seat belts. Position shoulder belt across chest and shoulder, not face or neck. A booster seat may be necessary to achieve proper belt positioning for children from 41 lbs until they reach a height where a lap/shoulder belt fits properly without a booster.

A child's risk of serious or fatal injuries is significantly increased if the child restraints are not properly secured in the vehicle and the child is not properly secured in the child restraint.

When the child restraint is not in use, remove it from the vehicle or secure it with the seat belt to prevent the child restraint from becoming a projectile in the event of an accident.

Do not leave children, unattended in the vehicle, even if the children are secured in a child restraint system. Unsupervised children in a child restraint system may use vehicle equipment and cause an accident and/or serious personal injury.

BabySmart™¹ air bag deactivation system

The  indicator lamp is located on the lower part of the center console.





① Indicator lamp

Special BabySmart™ compatible child seats, designed for use with the Mercedes-Benz system and available at any authorized Mercedes-Benz Center are required for use with the BabySmart™ air bag deactivation system. With the special child seat properly installed, the passenger front air bag will not deploy.

¹ BabySmart™ is a trademark of Siemens Automotive Corp.

Safety and Security

Occupant safety

The  indicator lamp  located on the lower part of the front center console will be illuminated, except with the SmartKey removed or in starter switch position **0**.



The system does not deactivate the side impact air bag or the emergency tensioning device.

Self-test BabySmart™¹ without special child seat installed

After turning the SmartKey in the starter switch to position **1** or **2** or pressing the KEYLESS-GO* start/stop button (▷ page 35) once or twice, the  indicator lamp comes on for approximately six seconds and then goes out.

If the  indicator lamp should not come on or is continuously lit, the system is not functioning. You must see an

¹ BabySmart™ is a trademark of Siemens Automotive Corp.

authorized Mercedes-Benz Center before seating any child on the front passenger seat.

For more information, see “Practical hints” (▷ page 337).

Warning!



The BabySmart™ air bag deactivation system will ONLY work with a special child seat designed to operate with it. It will not work with child seats which are not BabySmart™ compatible.



Never place anything between seat cushion and child seat (e.g. pillow), since it reduces the effectiveness of the deactivation system. The bottom of the child seat must make full contact with the passenger seat cushion. An incorrectly mounted child seat could cause injuries to the child in case of an accident, instead of protecting the child.

Follow the manufacturer's instructions for installation of special child seats.

Warning!



When using a BabySmart™ compatible child seat on the front passenger seat, the passenger front air bag will not deploy only if the  indicator lamp remains illuminated.

Make sure to check the  indicator lamp every time you use the special system child seat. Should the  indicator lamp go out while the restraint is installed, please check installation. If the  indicator lamp remains out, do not use the BabySmart™ restraint to transport children on the front passenger seat until the system has been repaired.

Safety and Security

Occupant safety

Warning!



Do not place powered-on laptops, cell phones and like electronic devices on the front passenger seat. Signals from such devices may interfere with the BabySmart™ system. Such signal interference may cause the  indicator lamp not to come on during self-test or be continuously lit, indicating that the system is not functioning.

Installation of infant and child restraint systems

This vehicle is equipped with tether anchorages for a top tether strap at each of the rear seating positions.

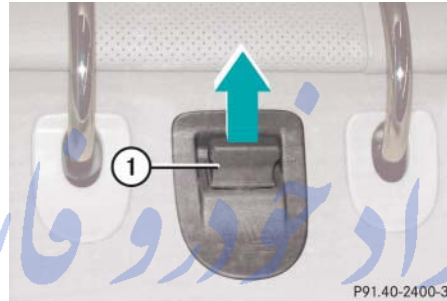

① Cover of top anchorage ring

- ▶ Remove cover ① from anchorage ring.
- ▶ Store cover ① in a convenient place (e.g. glove box).
- ▶ Guide tether strap between head restraint and top of seat back.

Head restraints must be positioned such that the top tether strap can pass freely between the head restraint and top of seat back.

Make sure the tether strap is not twisted.

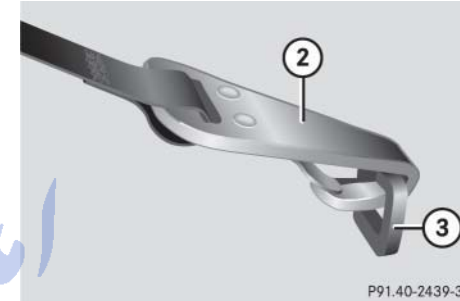

② Hook

③ Anchorage ring

- ▶ Securely fasten hook ②, which is part of the tether strap, to anchorage ring ③.

❶

For safety reasons, make sure hook ② has attached to ring ③ beyond the safety catch, as illustrated.

Once the top tether anchorage hook is attached, the child restraint itself can be secured. Tighten the top tether strap according to the child restraint manufacturer's instructions.

▷▷

Safety and Security

Occupant safety

- ▷▷ Reinstall cover after removing the tether strap.

Warning!



Vehicles with adjustable rear seats/bench*: Never adjust the rear seat position after installing the child restraint. Adjusting the rear seat position after installing the child restraint could damage the child restraint and/or introduce undesirable slack into the webbing and loosen or misposition the child restraint, lessening the effectiveness of the child restraint and thus increasing the chance or severity of injury in an accident.

Child seat anchors – LATCH type

This vehicle is equipped with two LATCH (Lower Anchors and Tethers for Children) type anchors (at each of the rear seats) for the installation of a LATCH child seat with the matching anchor fittings.

If you have not installed a child seat, the LATCH anchor are covered with an upholstery blend.

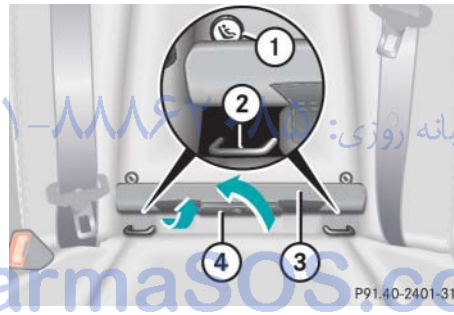

- ① Indicates the position of the anchors
- ② Anchors
- ③ Upholstery blend
- ④ Installation device

- ▶ Move rear power seats* /bench* to the rearmost position (▷ page 117).
- ▶ Fold upholstery blend ③ upward.
- ▶ Turn installation device ④ to a vertical position so that upholstery blend ③ does not fold down.
- ▶ Install child seat according to the manufacturer's instructions.

A solid connection is established between the child seat and the body of the vehicle.

Do not adjust rear power seat* /bench* position after installing child restraint.

Warning!



Vehicles with adjustable rear seats/bench*: Never adjust the rear seat position after installing the child restraint. Adjusting the rear seat position after installing the child restraint could damage the child restraint and/or introduce undesirable slack into the webbing and loosen or misposition the child restraint, lessening the effectiveness of the child restraint and thus increasing the chance or severity of injury in an accident.



The child seat must be firmly attached in the right and left side anchor fittings.

Make sure the seat belt for the center seat can operate freely with a child seat installed.

Non-LATCH type child seats may also be used and can be installed using the vehicle's seat belt system. Install child seat according to the manufacturer's instructions.

Warning!



Children too big for child restraint systems must ride in back seats using regular seat belts. Position shoulder belt across chest and shoulder, not face or neck. A booster seat may be necessary to achieve proper belt positioning for children from 41 lbs until they reach a height where a lap/shoulder belt fits properly without a booster.

Install child seat according to manufacturer's instructions.

The child seat must be firmly attached in right and left side anchors (2).

An incorrectly mounted child seat may come loose during an accident which could result in serious injury or death to the child.

Damaged or impact damaged child seats or child seat mounting fittings must be replaced.

Do not leave children unattended in the vehicle, even if the children are secured in a child restraint system.

Safety and Security

Occupant safety

Override switch for rear passenger compartment

You can disable select functions in the rear passenger compartment for added safety (for instance when you have children riding in the rear passenger compartment).

You can disable the following functions in the rear passenger compartment:

- rear door window operation (▷ page 207)
- adjustment of front passenger seat from the rear* (▷ page 118)
- cigarette lighter in rear (▷ page 252)

The override switch is located on the driver's door.

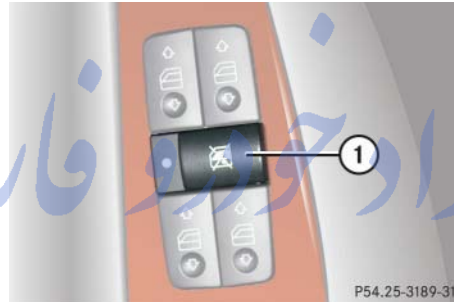

① Override switch

Activating override switch

- ▶ Slide override switch ① to the right.

A dot becomes visible. The functions in the rear are disabled.

Warning!



Activate the override switch when children are riding in the back seats of the vehicle.

The children may otherwise injure themselves, e.g. by becoming trapped in the window opening.

When leaving the vehicle, always remove the SmartKey or SmartKey with KEYLESS-GO* from the starter switch, take it with you, and lock your vehicle. Do not leave children unattended in the vehicle, or with access to an unlocked vehicle. Unsupervised use of vehicle equipment may cause an accident and/or serious personal injury.



Operation of the rear door windows with the switches located in the driver's door is still possible.

Deactivating override switch

- ▶ Slide override switch ① to the left.

The functions in the rear are enabled again.

▼ Panic alarm

An audible alarm and flashing exterior lamps will operate for approximately 2¹/₂ minutes.



① PANIC button

Activating

- ▶ Press and hold button ① for at least one second.

Deactivating

- ▶ Press button ① again.
- or
- ▶ Insert SmartKey in starter switch.



USA only:

This device complies with Part 15 of the FCC Rules. Operation is subject to the following two conditions:

- This device may not cause harmful interference, and
- this device must accept any interference received, including interference that may cause undesired operation.

Any unauthorized modification to this device could void the user's authority to operate the equipment.



Canada only:

This device complies with RSS-210 of Industry Canada. Operation is subject to the following two conditions:

- This device may not cause interference, and
- this device must accept any interference received, including interference that may cause undesired operation of the device.

Any unauthorized modification to this device could void the user's authority to operate the equipment.

Safety and Security

Driving safety systems

In this section you will find information on the following driving safety systems:

- ABS (Antilock Brake System)
- BAS (Brake Assist System)
- ESP (Electronic Stability Program)
- 4MATIC (Four Wheel Electronic Traction System)



In winter operation, the maximum effectiveness of the ABS, ESP, BAS and 4MATIC is only achieved with winter tires (M+S tires) or snow chains as required.

Warning!



The following factors increase the risk of accidents:

- Excessive speed, especially in turns
- Wet and slippery road surfaces
- Following another vehicle too closely

The ABS, BAS, ESP, and 4MATIC cannot reduce this risk.

Always adjust your driving style to the prevailing road and weather conditions.

ABS

Warning!



Do not pump the brake pedal. Use firm, steady brake pedal pressure instead. Pumping the brake pedal defeats the purpose of the ABS and significantly reduces braking effectiveness.

The Antilock Brake System (ABS) regulates the brake pressure so that the wheels do not lock during braking. This allows you to maintain the ability to steer your vehicle.

The ABS is functional above a speed of approximately 5 mph (8 km/h) independent of road surface conditions.

On slippery road surfaces, the ABS will respond even to light brake pressure.

The  indicator lamp in the instrument cluster (▷ page 24) comes on when you switch on the ignition (▷ page 34). It goes out when the engine is running.

Braking

At the instant one of the wheels is about to lock up, a slight pulsation can be felt in the brake pedal, indicating that the ABS is in the regulating mode.

- ▶ Keep firm and steady pressure on the brake pedal while experiencing the pulsation.

Continuous, steady brake pedal pressure yields the advantages provided by the ABS, namely braking power and the ability to steer the vehicle.

The pulsating brake pedal can be an indication of hazardous road conditions and functions as a reminder to take extra care while driving.

Emergency brake maneuver

- ▶ Keep continuous full pressure on the brake pedal.

Warning!



The ABS cannot prevent the natural laws of physics from acting on the vehicle, nor can it increase braking or steering efficiency beyond that afforded by the condition of the vehicle brakes and tires or the traction afforded. The ABS cannot prevent accidents, including those resulting from excessive speed in turns, following another vehicle too closely, or hydroplaning. Only a safe, attentive, and skillful driver can prevent accidents. The capabilities of an ABS equipped vehicle must never be exploited in a reckless or dangerous manner which could jeopardize the user's safety or the safety of others.

For more information, see "Practical hints" (▷ page 337).

BAS

The Brake Assist System (BAS) operates in emergency situations. If you apply the brakes very quickly, the BAS automatically provides full brake boost, thereby potentially reducing the braking distance.

- ▶ Apply continuous full braking pressure until the emergency braking situation is over.

The ABS will prevent the wheels from locking.

When you release the brake pedal, the brakes function again as normal. The BAS is then deactivated.

Warning!



If the BAS is malfunctioning, the brake system is still functioning normally, but without the additional brake boost available that BAS would normally provide in an emergency braking maneuver. Therefore, the braking distance may increase.

Safety and Security

Driving safety systems

Warning!



The BAS cannot prevent the natural laws of physics from acting on the vehicle, nor can it increase braking efficiency beyond that afforded by the condition of the vehicle brakes and tires or the traction afforded. The BAS cannot prevent accidents, including those resulting from excessive speed in turns, following another vehicle too closely, or hydroplaning. Only a safe, attentive, and skillful driver can prevent accidents. The capabilities of a BAS equipped vehicle must never be exploited in a reckless or dangerous manner which could jeopardize the user's safety or the safety of others.

For more information, see the "Practical hints" section (▷ page 338).

ESP

The Electronic Stability Program (ESP) is operational as soon as the engine is running and monitors the vehicle's traction (force of adhesive friction between the tires and the road surface) and handling.

The ESP recognizes when a wheel is spinning or if the vehicle starts to skid. By applying brakes to the appropriate wheel and by limiting the engine output, the ESP works to stabilize the vehicle. The ESP is especially useful while driving off and on wet or slippery road surfaces. The ESP also stabilizes the vehicle during braking maneuvers.

The ESP warning lamp  in the instrument cluster flashes when the ESP is engaged.

The ESP warning lamp  in the instrument cluster comes on when you switch on the ignition (▷ page 34). It goes out when the engine is running.

Warning!



Never switch off the ESP when you see the ESP warning lamp  flashing in the instrument cluster. In this case proceed as follows:

- While driving off, apply as little throttle as possible.
- While driving ease up on the accelerator.
- Adapt your speed and driving style to the prevailing road conditions.

Failure to observe these guidelines could cause the vehicle to skid.

The ESP cannot prevent accidents resulting from excessive speed.

Warning!



The ESP cannot prevent the natural laws of physics from acting on the vehicle, nor can it increase the traction afforded. The ESP cannot prevent accidents, including those resulting from excessive speed in turns, or hydroplaning. Only a safe, attentive, and skillful driver can prevent accidents. The capabilities of an ESP equipped vehicle must never be exploited in a reckless or dangerous manner which could jeopardize the user's safety or the safety of others.



Distronic* is switched off when ESP is activated.



The ESP will only function properly if you use wheels of the recommended tire size (▷ page 422).



Because of the ESP's automatic operation, the engine and ignition must be shut off (SmartKey in starter switch position **0** or **1** or KEYLESS-GO start/stop button* in position **0** or **1**) when

- the parking brake is being tested on a brake test dynamometer
- the vehicle is being towed with the front/rear axle raised

Active braking action through the ESP may otherwise seriously damage the brake system.

For more information, see "Practical hints" (▷ page 337).

Switching off the ESP

Warning!



The ESP should not be switched off during normal driving other than in the circumstances described below. Disabling of the system will reduce vehicle stability in standard driving maneuvers.

To improve the vehicle's traction, turn off the ESP in driving situations where it would be advantageous to have the drive wheels spin and thus cut into surfaces for better grip such as:

- starting out on slippery surfaces and in deep snow in conjunction with snow chains
- in sand or gravel



Distronic* cannot be activated when the ESP has been deactivated.

Safety and Security

Driving safety systems

When you switch off the ESP

- the ESP does not stabilize the vehicle
- the engine output is not limited, which allows the drive wheels to spin and thus cut into surfaces for better grip
- the traction control will still brake a spinning wheel
- the ESP continues to operate when you are braking



When the ESP is switched off and one or more drive wheels are spinning, the ESP warning lamp  in the instrument cluster flashes. However, the ESP will then not stabilize the vehicle.

The switch is located on the upper part of the center console.



① ESP off/on

- ▶ Press ESP switch ① until the ESP warning lamp  in the speedometer comes on.

The ESP is deactivated.

Warning!



When the ESP warning lamp  is illuminated continuously, the ESP is switched off.

Adapt your speed and driving to the prevailing road conditions and to the non-operating status of the ESP.



Avoid spinning of a drive wheel for an extended period with the ESP switched off. This may cause serious damage to the drivetrain which is not covered by the Mercedes-Benz Limited Warranty.

Switching on the ESP

- ▶ Press ESP switch ①.

The ESP warning lamp  in the instrument cluster goes out.

You are now again in normal driving mode with the ESP switched on.

Four wheel electronic traction system (4MATIC) with the ESP

Models with all-wheel drive only:

The 4MATIC improves the vehicle's ability to use available traction, e.g. during winter operation in mountains under snowy conditions, by applying power to all four wheels.

Warning!



If you see the ESP warning lamp  flashing in the speedometer dial, proceed as follows:

- While driving off, apply as little throttle as possible.
- While driving, ease up on the accelerator.
- Adapt your speed and driving style to the prevailing road conditions.

Failure to observe these guidelines could cause the vehicle to skid.

The ESP cannot prevent accidents resulting from excessive speed.



Do not tow with one axle raised.

Otherwise the transfer case can be damaged, which is not covered by the Mercedes-Benz Limited Warranty.



Performance testing must only be conducted on a two-axle dynamometer.

Otherwise the transfer case can be damaged, which is not covered by the Mercedes-Benz Limited Warranty.



Because of the ESP's automatic operation, the engine and ignition must be shut off (SmartKey in starter switch position **0** or **1** or KEYLESS-GO* start/stop button (▷ page 35) in position **0** or **1**) when the parking brake is being tested on a brake test dynamometer.

Active braking action through the ESP may otherwise seriously damage the front or rear axle brake system.

Operational tests with the engine running can only be conducted on a two-axle dynamometer.

Safety and Security

Anti-theft systems

Immobilizer

The immobilizer prevents unauthorized persons from starting your vehicle.

Activating

With the SmartKey

- ▶ Remove the SmartKey from the starter switch.

The immobilizer is activated.

*With KEYLESS-GO**

- ▶ Turn off the engine by means of the start/stop button (▷ page 35) on the gear selector lever.
- ▶ Open the driver's door.
The immobilizer is activated.

Deactivating

With the SmartKey

- ▶ Insert the SmartKey in the starter switch.

The immobilizer is deactivated.

*With KEYLESS-GO**

- ▶ Start the engine by means of the start/stop button (▷ page 35) on the gear selector lever.

The immobilizer is deactivated.



In case the engine cannot be started (yet the vehicle's battery is charged), the system is not operational. Contact an authorized Mercedes-Benz Center or call
1-800-FOR-MERCEdes (in the USA), or
1-800-387-0100 (in Canada).

FarmaSOS.com

Anti-theft alarm system

Once the alarm system has been armed, a visual and audible alarm is triggered when someone opens:

- a door
- the trunk
- the hood

The alarm will stay on even if the activating element (a door, for example) is immediately closed.

The alarm system will also be triggered when

- someone attempts to raise the vehicle
- the vehicle is opened with the mechanical key
- someone opens a door from the inside if the vehicle was locked from the outside with the SmartKey
- someone opens the trunk lid with the emergency release button



If the alarm stays on for more than 30 seconds, a call to the Response Center is initiated automatically by the by the Tele Aid system (▷ page 255) provided Tele Aid service was subscribed to and properly activated, and that necessary cellular service and GPS coverage are available.

Arming the alarm system

The indicator lamp located in the central locking switch in on the upper part of the front center console.



① Indicator lamp

- ▶ Lock your vehicle.

The turn signal lamps flash three times to indicate that the alarm system is activated. The indicator lamp ① flashes to indicate that the alarm system is armed.

Safety and Security

Anti-theft systems



If the turn signal lamps does not flash three times one of the following elements may not be properly closed:

- a door
- the trunk
- the hood

Close the respective element and lock the vehicle again.

Disarming the alarm system

- ▶ Unlock your vehicle.

The turn signal lamps flash once to indicate that the alarm system is deactivated.





The alarm system will rearm automatically again after approximately 40 seconds if no door was opened.

Canceling the alarm

To cancel the alarm:

With the SmartKey

- ▶ Insert the SmartKey in the starter switch.
- or
- ▶ Press the  or  button on the SmartKey.

The alarm is canceled.

With KEYLESS-GO*

- ▶ Grasp the outside door handle.

The SmartKey with KEYLESS-GO must be within 3 ft. (1 m) of the vehicle.

or

- ▶ Press the KEYLESS-GO* start/stop button (▷ page 35).

The SmartKey with KEYLESS-GO must be inside the vehicle.

The alarm is canceled.

تلفن شبانه روزی: ۰۲۱-۸۸۶۲۰۸۵

FarmaSOS.com

Tow-away alarm

Once the tow-away alarm is armed, a visual and audible alarm will be triggered when someone attempts to raise the vehicle.



The tow-away protection alarm is triggered, for example, if the vehicle is lifted on one side.

If the alarm stays on for more than 30 seconds, a call to the Response Center is initiated automatically by the Tele Aid system (> page 255) provided Tele Aid service was subscribed to and properly activated and that necessary cellular service and GPS coverage are available.

Arming tow-away alarm

- ▶ Lock your vehicle.

The tow-away alarm is automatically armed after about 30 seconds.

Disarming tow-away alarm

To prevent triggering the tow-away alarm, switch off the tow-away alarm feature before towing the vehicle, or when parking on a surface subject to movement, such as a ferry or auto train.

Safety and Security

Anti-theft systems

The button is located on the upper part of the front center console.



- ① Indicator lamp
- ② Tow-away alarm off button

- ▶ Switch off the ignition and remove the SmartKey from the starter switch.



You cannot disarm the tow-away alarm if the ignition is switched on.

- ▶ Press button ②.

The indicator lamp ① in the button comes on briefly.

- ▶ Exit the vehicle and lock it with the SmartKey or (vehicles with KEYLESS-GO*) the lock button at each outside door handle or trunk lid.



When you unlock your vehicle, the tow-away protection disarms automatically.

The tow-away alarm remains disarmed until you lock your vehicle again.

FarmaSOS.com



Controls in detail

Locking and unlocking

Seats

Memory function

Lighting

Instrument cluster

Control system

Automatic transmission

Good visibility

Automatic climate control

Power windows

Power tilt/sliding sunroof

Driving systems

Loading

Useful features

Controls in detail

Locking and unlocking

In the “Controls in detail” section you will find detailed information on how to operate the equipment installed in your vehicle. If you are already familiar with the basic functions of your vehicle, this section will be of particular interest to you.

To quickly familiarize yourself with the basic functions of the vehicle, refer to the “Getting started” section of this manual.

The corresponding page numbers are given at the beginning of each segment.

For more information on locking and unlocking, see “Getting started” (▷ page 32) and (▷ page 58).

SmartKey

Your vehicle comes supplied with two SmartKeys, each with remote control and a removable mechanical key.

The locking tabs for the mechanical key portion of the two SmartKeys are a different color to help distinguish each SmartKey unit.

The SmartKey provides an extended operating range. To prevent theft, however, it is advisable to only unlock the vehicle when you are in close proximity to it.

The SmartKey centrally locks and unlocks:

- the doors
- the trunk
- the fuel filler flap

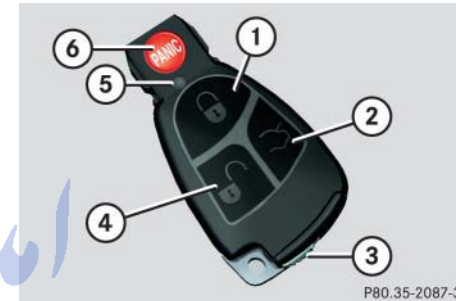

SmartKey with remote control

- ① Lock button
- ② Opening button for trunk
- ③ Mechanical key locking tab
- ④ Unlock button
- ⑤ Battery check lamp
- ⑥ PANIC Panic button (▷ page 79)

Controls in detail

Locking and unlocking

Warning!



When leaving the vehicle, always remove the SmartKey from the starter switch, take it with you, and lock the vehicle. Do not leave children unattended in the vehicle, or with access to an unlocked vehicle. It is possible for children to open a locked door from the inside, which could result in an accident and/or serious personal injury.



To prevent possible malfunction, avoid exposing the SmartKey to high levels of electromagnetic radiation.



USA only:

This device complies with Part 15 of the FCC Rules. Operation is subject to the following two conditions:

- This device may not cause harmful interference, and
- this device must accept any interference received, including interference that may cause undesired operation.

Any unauthorized modification to this device could void the user's authority to operate the equipment.



Canada only:

This device complies with RSS-210 of Industry Canada. Operation is subject to the following two conditions:

- This device may not cause interference, and
- this device must accept any interference received, including interference that may cause undesired operation of the device.

Any unauthorized modification to this device could void the user's authority to operate the equipment.



You can also open and close the power windows (▷ page 209) and tilt/sliding sunroof (▷ page 209) using the SmartKey.

Controls in detail

Locking and unlocking

Factory setting

Global unlocking

- ▶ Press button .

All turn signal lamps flash once. The locking knobs in the doors move up. The anti-theft alarm system is disarmed.

The vehicle will lock again automatically and reactivate the anti-theft alarm system within approximately 40 seconds of unlocking if:

- neither door nor trunk is opened
- the SmartKey is not inserted in the starter switch
- the central locking switch is not activated



Global locking

- ▶ Press button .

All turn signal lamps flash three times. The locking knobs in the doors move down. The anti-theft alarm system is armed.

Selective setting

If you frequently travel alone, you may wish to reprogram the SmartKey so that pressing  only unlocks the driver's door and the fuel filler flap.

- ▶ Press and hold buttons  and  simultaneously for about five seconds until battery check lamp  flashes twice.

The SmartKey will then function as follows:

Unlocking driver's door and fuel filler flap

- ▶ Press button  once.

All turn signal lamps flash once. The locking knob in the driver's door moves up. The anti-theft alarm system is disarmed.

Global unlocking

- ▶ Press button  twice.



All turn signal lamps flash once. The locking knobs in the doors move up. The anti-theft alarm system is disarmed.

Global locking

- ▶ Press button .

All turn signal lamps flash three times. The locking knobs in the doors move down. The anti-theft alarm system is armed.

Restoring to factory setting

- ▶ Press and hold buttons  and  simultaneously for about six seconds until battery check lamp  flashes twice.





If you can no longer lock or unlock the vehicle with the SmartKey, then either the batteries in the SmartKey are discharged, the SmartKey is malfunctioning or the vehicle battery is drained.

- Check the batteries in the SmartKey and replace them if necessary (▷ page 387).
- Use the mechanical key to unlock the driver's door (▷ page 383) and trunk (▷ page 384).
- Use the mechanical key to lock the driver's door (▷ page 383).
- Have the vehicle battery and the battery connections checked (▷ page 403).

If the SmartKey is malfunctioning, contact an authorized Mercedes-Benz Center.

Checking the batteries

- ▶ Press button  or .

Battery check lamp  comes on briefly to indicate that the SmartKey batteries are in order.





If battery check lamp  does not come on briefly during check, then the SmartKey batteries are discharged.

Replace the batteries (▷ page 387).

You can obtain the required batteries at any authorized Mercedes-Benz Center.



If the batteries are checked within signal range of the vehicle, pressing the  or  button will lock or unlock the vehicle accordingly.

Unlocking and opening the trunk

You can unlock and open the trunk separately.

A minimum height clearance of 6 ft. (1.85 m) is required to open the trunk lid.

- ▶ Press and hold button  until trunk unlocks and begins to open.



The trunk lid swings open upwards automatically. Always make sure that there is sufficient overhead clearance.

Vehicles with trunk lid opening/closing system*: To stop the opening procedure, press button . The trunk lid stops moving.

Controls in detail

Locking and unlocking

Loss of SmartKey or mechanical key

If you lose a SmartKey or mechanical key, you should do the following:

- ▶ Have the SmartKey deactivated by an authorized Mercedes-Benz Center.
- ▶ Report the loss of the SmartKey or the mechanical key immediately to your car insurance company.
- ▶ If necessary, have the mechanical lock replaced.

Your authorized Mercedes-Benz Center will be glad to supply you with a replacement.

SmartKey with KEYLESS-GO*

Vehicles equipped with KEYLESS-GO come with two SmartKeys with KEYLESS-GO, each with remote control and a removable mechanical key.

The locking tabs for the mechanical key portion of the two SmartKeys with KEYLESS-GO are a different color to help distinguish each SmartKey with KEYLESS-GO unit.

The function of the SmartKey overrides the KEYLESS-GO function.

The KEYLESS-GO function is integrated into the SmartKey. On these vehicles, the validity of the SmartKey with KEYLESS-GO is checked every time you grasp an outside door handle.

If the SmartKey with KEYLESS-GO is valid, your vehicle unlocks:

- the doors
- the trunk
- the fuel filler flap

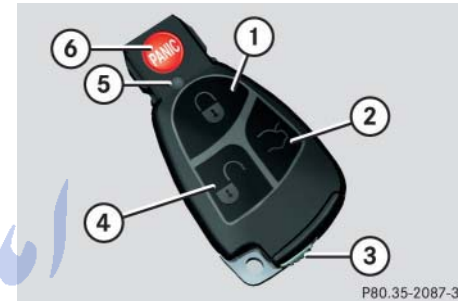

SmartKey with KEYLESS-GO

- ① Lock button
- ② Opening button for trunk
- ③ Locking tab for mechanical key
- ④ Unlock button
- ⑤ Battery check lamp
- ⑥ PANIC Panic button (> page 79)



When any outside door handle other than the driver's outside door handle is grasped, the vehicle is centrally unlocked.

Controls in detail

Locking and unlocking

Warning!



When leaving the vehicle, always take the SmartKey with KEYLESS-GO* with you and lock the vehicle. Do not leave children unattended in the vehicle, or with access to an unlocked vehicle. Unsupervised use of vehicle equipment may cause an accident and/or serious personal injury.



To prevent possible malfunction, avoid exposing the SmartKey with KEYLESS-GO to high levels of electromagnetic radiation.



USA only:

This device complies with Part 15 of the FCC Rules. Operation is subject to the following two conditions:

- This device may not cause harmful interference, and
- this device must accept any interference received, including interference that may cause undesired operation.

Any unauthorized modification to this device could void the user's authority to operate the equipment.



Canada only:

This device complies with RSS-210 of Industry Canada. Operation is subject to the following two conditions:

- This device may not cause interference, and
- this device must accept any interference received, including interference that may cause undesired operation of the device.

Any unauthorized modification to this device could void the user's authority to operate the equipment.



You can also open and close the power windows (▷ page 209) and tilt/sliding sunroof (▷ page 209) using the SmartKey with KEYLESS-GO.

Controls in detail

Locking and unlocking

Important notes on using KEYLESS-GO

- You can also use the SmartKey with KEYLESS-GO like a normal SmartKey (▷ page 92).
- You can combine KEYLESS-GO functions with normal SmartKey functions (e.g. unlocking with KEYLESS-GO and locking with the  button).
- Always carry the SmartKey with KEYLESS-GO with you.
- Never store the SmartKey with KEYLESS-GO together with:
 - Electronic items such as a cellular phone or another SmartKey with KEYLESS-GO
 - Metallic objects such as coins or metal foil

Doing so could impair the function of the KEYLESS-GO system.

- To lock or unlock the vehicle, the SmartKey with KEYLESS-GO must be located outside the vehicle within approximately 3 ft. (1 m) of a door or the trunk lid.
- In order to start the engine with the SmartKey with KEYLESS-GO:
 - The SmartKey with KEYLESS-GO must be located in the vehicle.
 - All doors must be closed.
 - The brake pedal must be firmly depressed. Do not depress the accelerator.

- If you have started the engine with the KEYLESS-GO start/stop button (▷ page 35), you can only turn it off again with this button, even if you have put the SmartKey in the starter switch in the meantime.

This does not apply if, after starting, the gear selector lever is still in position **P** and the SmartKey is then inserted in the starter switch. The SmartKey will then have priority over the KEYLESS-GO function and the vehicle's electrical system will operate according to the position of the SmartKey in the starter switch, even stopping the engine.

- If the SmartKey with KEYLESS-GO is positioned farther away from the vehicle, the system may no longer recognize the SmartKey with KEYLESS-GO. The vehicle then cannot be locked or the engine started via the KEYLESS-GO system.

- If the SmartKey with KEYLESS-GO is removed from the vehicle while the ignition is switched on (e.g. if passenger exits the vehicle with the SmartKey with KEYLESS-GO), the message

KEY
NOT RECOGNIZED

will appear in the multifunction display while driving off.

Find the SmartKey or change its present location immediately (e.g. place it on the front passenger seat or insert it in shirt pocket).

- Remember that the engine can be started by anyone with a SmartKey with KEYLESS-GO that is left inside the vehicle. If you leave the SmartKey with KEYLESS-GO behind when exiting and locking the vehicle, the message

KEY
STILL IN VEHICLE

will appear in the multifunction display.

Factory setting

Global unlocking

- ▶ Grasp the outside door handle.

All turn signal lamps flash once. The locking knob in the doors move up. The anti-theft alarm system is disarmed.



If the vehicle has been parked for more than 72 hours, you must pull the outside door handle in order to activate the KEYLESS-GO function.

The vehicle will lock again automatically and reactivate the anti-theft alarm system within approximately 40 seconds of unlocking if:

- neither door nor trunk is opened
- the central locking switch is not activated.



The vehicle could inadvertently be unlocked if the SmartKey with KEYLESS-GO is within 3 ft. (1 m) of the vehicle and:

- the outside door handle is splashed with water, or
- you attempt to clean the outside door handle.

Global locking

- ▶ Press lock button at the outside door handle (▷ page 58) or trunk lid (▷ page 101).



All turn signal lamps flash three times. The locking knobs in the doors move down. The anti-theft alarm system is armed.

Controls in detail

Locking and unlocking

Selective setting

If you frequently travel alone, you may wish to reprogram the SmartKey with KEYLESS-GO so when you, grasp the driver's outside door handle only the driver's door and the fuel filler flap unlocks.

- ▶ Press and hold buttons  and  simultaneously for about six seconds until battery check lamp ⑤ flashes twice.

The SmartKey with KEYLESS-GO will then function as follows:

Unlocking driver's door and fuel filler flap

- ▶ Grasp the driver's outside door handle.
All turn signal lamps flash once. The locking knob in the driver's door moves up. The anti-theft alarm system is disarmed.

Global unlocking

- ▶ Grasp any outside door handle other than the driver's outside door handle.

All turn signal lamps flash once. The locking knobs in the doors move up. The anti-theft alarm system is disarmed.

Global locking



- ▶ Press lock button at outside door handle (▷ page 58).

All turn signal lamps flash three times. The locking knobs in the doors move down. The anti-theft alarm system is armed.



You can also lock the vehicle using the lock button at trunk lid (▷ page 101) or, vehicles with trunk lid opening/closing system*, KEYLESS-GO locking/closing switch (▷ page 110).

Restoring to factory setting

- ▶ Press and hold buttons  and  simultaneously for about six seconds until battery check lamp ⑤ flashes twice.



If you can not lock or unlock the vehicle with the SmartKey with KEYLESS-GO, then either the battery in the SmartKey with KEYLESS-GO is discharged, the SmartKey with KEYLESS-GO is malfunctioning or the vehicle battery is drained.

- Check the battery in the SmartKey with KEYLESS-GO and replace it if necessary (▷ page 387).
- Use the mechanical key to unlock the driver's door (▷ page 383) and trunk (▷ page 384).
- Use the mechanical key to lock the driver's door (▷ page 383).

- Have the vehicle battery and the battery connections checked (> page 403).

If the SmartKey with KEYLESS-GO is malfunctioning, contact an authorized Mercedes-Benz Center.

Checking the battery

- ▶ Press button  or .

Battery check lamp  comes on briefly to indicate that the SmartKey with KEYLESS-GO battery is in order.





If battery check lamp  does not come on briefly during check, the SmartKey battery with KEYLESS-GO is discharged.

Replace the battery (> page 387).

You can obtain the required battery at any authorized Mercedes-Benz Center.



If the battery is checked within signal range of the vehicle, pressing the button  or  will lock or unlock the vehicle accordingly.

Global locking using the lock button at trunk lid



To prevent a possible inadvertent lock-out, the trunk will open automatically if a SmartKey with KEYLESS-GO is recognized inside the vehicle or in the trunk.

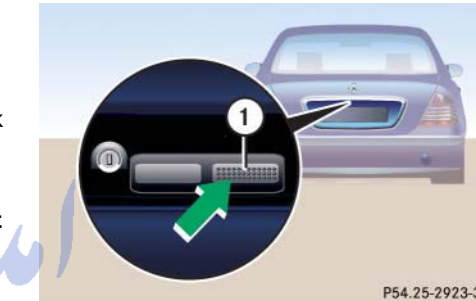

P54.25-2923-31

 Vehicle lock button

- ▶ Press vehicle lock button .

All turn signal lamps flash three times. The locking knobs in the doors move down. The anti-theft alarm system is armed.



You can also lock the vehicle using the lock button at outside door handle (> page 58) or, vehicles with trunk lid opening/closing system*, KEYLESS-GO locking/closing switch (> page 110).

Controls in detail

Locking and unlocking

Controls in detail

Locking and unlocking

Unlocking and opening the trunk

You can unlock and open the trunk separately.

A minimum height clearance of 6 ft. (1.85 m) is required to open the trunk lid.

- ▶ Press and hold button  until trunk unlocks and begins to open.



The trunk lid swings open upwards automatically. Always make sure that there is sufficient overhead clearance.

Vehicles with trunk lid opening/closing system*: To stop the opening procedure, press button . The trunk lid stops moving.

Loss of the SmartKey with KEYLESS-GO

If you lose your SmartKey with KEYLESS-GO or mechanical key, you should do the following:

- ▶ Have the SmartKey with KEYLESS-GO deactivated by an authorized Mercedes-Benz Center.
- ▶ Report the loss of the SmartKey with KEYLESS-GO or the mechanical key immediately to your car insurance company.
- ▶ Have the mechanical lock replaced if necessary.

Your authorized Mercedes-Benz Center will be glad to supply you with a replacement.

Opening the doors from the inside

You can open a locked door from the inside. Open door only when conditions are safe to do so.

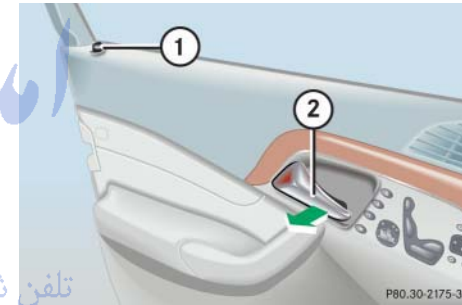



- ① Locking knob
- ② Inside door handle



If the vehicle has previously been locked from the outside with the SmartKey or KEYLESS-GO*, opening a door from the inside will trigger the anti-theft alarm system.

To cancel the alarm, do one of the following:

- Insert the SmartKey in the starter switch.
- Press button  or  on the SmartKey.

In vehicles with KEYLESS-GO*:

- Grasp the outside door handle.
The SmartKey with KEYLESS-GO must be within 3 ft. (1 m) of the vehicle.
- Press the KEYLESS-GO* start/stop button (▷ page 35).
The SmartKey with KEYLESS-GO must be inside the vehicle.

Front doors

- ▶ Pull on door handle ② on the respective front door to open door.

If door was locked, locking knob ① will move up.

Rear doors

- ▶ Pull up locking knob ① on the respective rear door to unlock door.
- ▶ Pull on door handle ② on the respective rear door to open door.

Controls in detail

Locking and unlocking

Opening the trunk

Opening the trunk from the outside

A minimum height clearance of 6 ft. (1.85 m) is required to open the trunk lid.

The trunk lid lock button is located in the rear license plate recess.

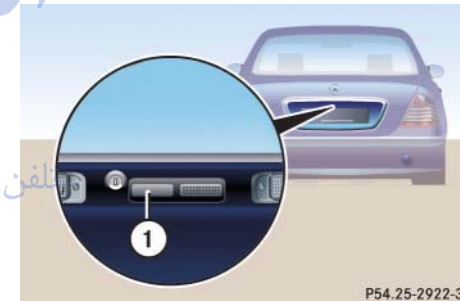

① Trunk lid lock button

In vehicles without KEYLESS-GO*: The vehicle must be unlocked.

- ▶ Press the outer left-hand side of trunk lid button ①.

The trunk lid opens.

Controls in detail

Locking and unlocking



The trunk lid swings open upwards automatically. Always make sure that there is sufficient overhead clearance.

Vehicles with trunk lid opening/closing system*: To stop the opening procedure, press button  on the SmartKey or SmartKey with KEYLESS-GO*.



The trunk can also be opened using button  on the SmartKey or SmartKey with KEYLESS-GO* or from its inside in an emergency, see “Trunk lid emergency release” (▷ page 111).

Opening the trunk from the inside

You can open the trunk from the inside if the vehicle is stationary.

A minimum height clearance of 6 ft. (1.85 m) is required to open the trunk lid.

The switch is located on the driver's door.

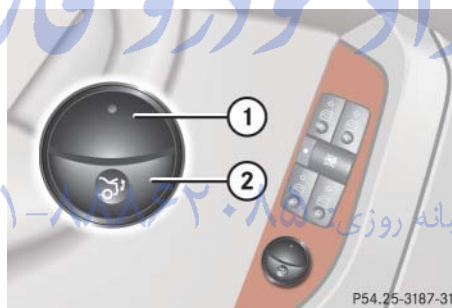

- ① Indicator lamp
- ② Remote trunk lid switch

► Pull remote trunk lid switch ② until trunk begins to open.

The trunk lid opens. The indicator lamp ① comes on and remains lit until the trunk is closed.



The trunk lid swings open upwards automatically. Always make sure that there is sufficient overhead clearance.

Vehicles with trunk lid opening/closing system*: To stop the opening procedure, press or pull remote trunk lid switch ②.



The trunk can also be opened using button  on the SmartKey or SmartKey with KEYLESS-GO* or from its inside in an emergency, see “Trunk lid emergency release” (▷ page 111).

Limiting opening height of trunk lid*

Vehicles with trunk lid opening/closing system*:

The trunk lid opening height can be limited when transporting goods on a roof rack (e.g. presence of an MB sport luggage container*). When activated, the trunk lid opens to approximately the height of the roof edge.

- ▶ Activate the limiting opening height of trunk lid using the control system (▷ page 169).

Closing the trunk

Closing the trunk from the inside automatically*

In vehicles with trunk lid opening/closing system* you can close the trunk from the inside using the remote trunk lid switch.

- ▶ Press remote trunk lid switch (▷ page 104) until the indicator lamp in the switch goes out and trunk lid is closed.

To interrupt the closing procedure:

- ▶ Release remote trunk lid switch.



You can also close the trunk by hand.

Warning!



Maintain sight of trunk area while operating door mounted switch. Monitor the closing procedure carefully to make sure no one is in danger of being injured.

To interrupt the closing procedure, release the door mounted remote trunk lid switch.

Even with the SmartKey or the SmartKey with KEYLESS-GO* removed from the starter switch or the SmartKey with KEYLESS-GO* removed from the vehicle, the remote trunk lid switch can be operated. Therefore, do not leave children unattended in the vehicle, or with access to an unlocked vehicle. Unsupervised use of vehicle equipment may cause an accident and/or serious personal injury.



Controls in detail

Locking and unlocking



Warning!



Only drive with the trunk closed as, among other dangers such as visibility blockage, exhaust fumes may enter the vehicle interior.

If the trunk lid comes into contact with an object while closing (e.g. luggage that has been piled too high) in the upper motion sequence, the closing procedure is stopped and the trunk reopens slightly.

Closing the trunk from the outside manually

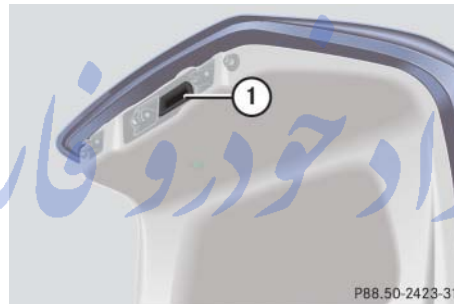

P88.50-2423-31

① Handle

- ▶ Lower trunk lid by pulling firmly on handle ①.

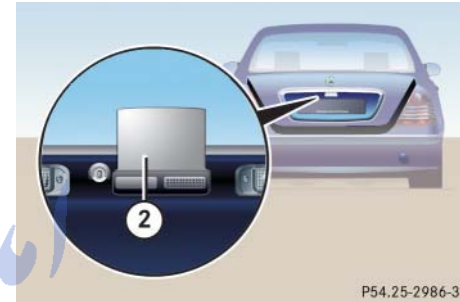

P54.25-2986-31

② Extending handle

- ▶ Push the trunk lid down gently at the extending handle ② until it engages into the lock.

The extending handle ② is retracted after a few seconds.

The power closing assist automatically ensures that the lid is pulled closed completely (▷ page 112).

Warning!



To prevent possible personal injury, always keep hands and fingers away from the trunk lid opening when closing the trunk. Be especially careful when small children are around.

When leaving the vehicle, always remove the SmartKey or SmartKey with KEYLESS-GO* from the starter switch, take it with you, and lock the vehicle. Do not leave children unattended in the vehicle, or with access to an unlocked vehicle. Unsupervised use of vehicle equipment may cause an accident and/or serious personal injury.

Warning!



Only drive with the trunk closed as, among other dangers such as visibility blockage, exhaust fumes may enter the vehicle interior.



Do not place the SmartKey in the open trunk. You may lock yourself out.

Vehicles with KEYLESS-GO*: To prevent a possible inadvertent lockout, the trunk lid will open automatically if a SmartKey with KEYLESS-GO is recognized inside the vehicle or in the trunk.



If the vehicle was previously centrally locked, the trunk will lock automatically after closing it. The turn signals flash three times to confirm locking.

Closing the trunk from the outside (vehicles without KEYLESS-GO*)

In vehicles with trunk lid opening/closing system* you can close the trunk separately from the outside using the trunk lid closing switch.

Controls in detail

Locking and unlocking

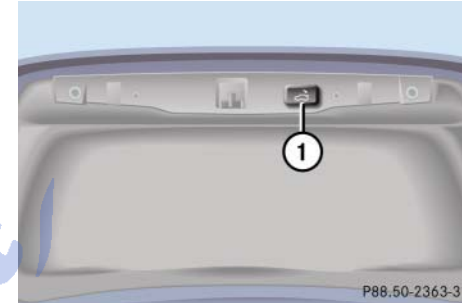

① Trunk lid closing switch

- ▶ Press trunk lid closing switch ① briefly. The trunk lid closes.



You can also close the trunk by hand.

If the trunk lid comes into contact with an object while closing (e.g. luggage that has been piled too high), the closing procedure is stopped and the trunk reopens slightly. ▷▷

Controls in detail

Locking and unlocking



Warning!



Monitor the closing procedure carefully to make sure no one is in danger of being injured. To prevent possible personal injury, always keep hands and fingers away from the trunk opening when closing the trunk. Be especially careful when small children are around. To stop the closing procedure, do one of the following:

- press trunk lid closing switch ①
- press the  button on the SmartKey
- press the remote trunk lid switch (on the driver's door)

Even with the SmartKey removed from the starter switch, the trunk lid closing switch can be operated. Therefore, do not leave children unattended in the vehicle, or with access to an unlocked vehicle. Unsupervised use of vehicle equipment may cause an accident and/or serious personal injury.

Warning!



Only drive with the trunk closed as, among other dangers such as visibility blockage, exhaust fumes may enter the vehicle interior.



Do not place the SmartKey in the open trunk. You may lock yourself out.



If the vehicle was previously centrally locked, the trunk will lock automatically after closing it. The turn signals flash three times to confirm locking.

Closing the trunk from the outside (vehicles with KEYLESS-GO*)

In vehicles with trunk lid opening/closing system* you can close the trunk separately from the outside using the trunk lid closing switch.

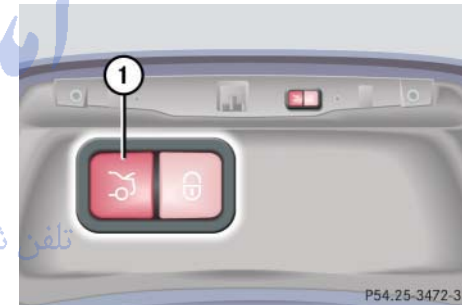

① Trunk lid closing switch

- ▶ Make sure you have the SmartKey with KEYLESS-GO with you.
- ▶ Press trunk lid closing switch ① briefly.

The trunk lid closes.

Controls in detail

Locking and unlocking



You can also close the trunk by hand.

If the trunk lid comes into contact with an object while closing (e.g. luggage that has been piled too high), the closing procedure is stopped and the trunk reopens slightly.



To prevent a possible inadvertent lock-out, the trunk lid will open automatically if a SmartKey with KEYLESS-GO is recognized inside the vehicle or in the trunk.

Warning!



Monitor the closing procedure carefully to make sure no one is in danger of being injured. To prevent possible personal injury, always keep hands and fingers away from the trunk opening when closing the trunk. Be especially careful when small children are around. To stop the closing procedure, do one of the following:

- press trunk lid closing switch ①
- press the  button on the SmartKey with KEYLESS-GO
- press the remote trunk lid switch (on the driver's door)

Even with the SmartKey with KEYLESS-GO removed from the vehicle, the trunk lid closing switch can be operated. Therefore, do not leave children unattended in the vehicle, or with access to an unlocked vehicle. Unsupervised use of vehicle equipment may cause an accident and/or serious personal injury.

Warning!



Only drive with the trunk closed as, among other dangers such as visibility blockage, exhaust fumes may enter the vehicle interior.



If the vehicle was previously centrally locked, the trunk will lock automatically after closing it. The turn signals flash three times to confirm locking.

Controls in detail

Locking and unlocking

Closing the trunk and locking the vehicle from the outside (vehicles with KEYLESS-GO*)

In vehicles with trunk lid opening/closing system* and KEYLESS-GO, you can close the trunk lid and lock the vehicle simultaneously from the outside using the KEYLESS-GO locking/closing switch.

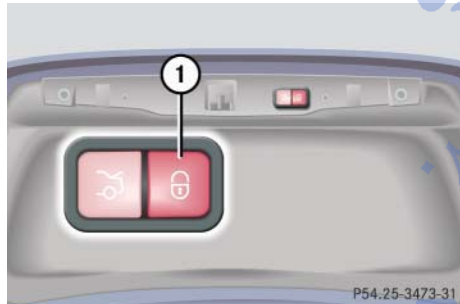

① KEYLESS-GO locking/closing switch

- ▶ Make sure you have the SmartKey with KEYLESS-GO with you.

- ▶ Press switch ① briefly.

The vehicle is locked and the trunk lid closes automatically. The turn signals flash three times to confirm locking. The locking knobs in the doors move down. The anti-theft alarm system is activated.



You can also close the trunk by hand.

If the trunk lid comes into contact with an object while closing (e.g. luggage that has been piled too high), the closing procedure is stopped and the trunk reopens slightly.



To prevent a possible inadvertent lock-out, the trunk lid will open automatically if a SmartKey with KEYLESS-GO is recognized inside the vehicle or in the trunk.

Warning!



Monitor the closing procedure carefully to make sure no one is in danger of being injured. To prevent possible personal injury, always keep hands and fingers away from the trunk opening when closing the trunk. Be especially careful when small children are around. To stop the closing procedure, do one of the following:

- press KEYLESS-GO locking/closing switch ①
- press the  button on the SmartKey with KEYLESS-GO
- press the remote trunk lid switch (on the driver's door)

Even with the SmartKey with KEYLESS-GO removed from the vehicle, the KEYLESS-GO locking/closing switch can be operated. Therefore, do not leave children unattended in the vehicle, or with access to an unlocked vehicle. Unsupervised use of vehicle equipment may cause an accident and/or serious personal injury.

Warning!



Only drive with the trunk closed as, among other dangers such as visibility blockage, exhaust fumes may enter the vehicle interior.

Trunk lid emergency release

The emergency release button is located on the inside of the trunk lid.

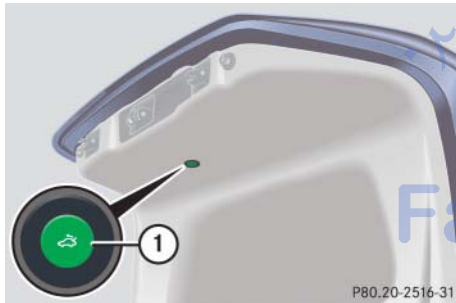

① Emergency release button

- ▶ Briefly press emergency release button ①.

The trunk unlocks and the trunk lid opens.



The emergency release button unlocks and opens the trunk while the vehicle is standing still or in motion.

Illumination of the emergency release button:

- The button will flash for 30 minutes after opening the trunk.
- The button will flash for 60 minutes after closing the trunk.



The emergency release button does not open the trunk lid if the vehicle battery is discharged or disconnected.



Controls in detail

Locking and unlocking



If the emergency release button is pressed and the vehicle was centrally locked, the exterior lamps will flash and the alarm will sound as the trunk lid opens:

To cancel the alarm, do one of the following:

- Insert the SmartKey in the starter switch.
- Press button  or  on the SmartKey.

In vehicles with KEYLESS-GO*:

- Grasp the outside door handle.

The SmartKey with KEYLESS-GO must be within 3 ft. (1 m) of the vehicle.

- Press the KEYLESS-GO* start/stop button (> page 35).

The SmartKey with KEYLESS-GO must be inside the vehicle.

Controls in detail

Locking and unlocking

Power closing assist for doors and trunk lid

It is not necessary to slam the door or trunk lid closed. A pneumatic power-assisted mechanism draws doors and trunk lid closed quietly and automatically once door and trunk lid has been latched. When the pneumatic power-assisted mechanism has stopped, doors and/or trunk can be re-opened.

Warning!



To prevent possible personal injury, always keep hands and fingers away from the door or trunk opening when closing a door or the trunk lid. Be especially careful when small children are around.

In case of danger, pull the inside or outside door handle, or press the trunk lid lock.

To prevent personal injury, never actuate the closing assist mechanism by tampering with the door or trunk lid latch.

Power closing assist for doors

- ▶ Press the doors gently past the initial engage position into the lock.
The doors close automatically.

Warning!



Only drive with the doors closed. Otherwise, one or more of the doors could open while the vehicle is in motion, putting you and/or others at risk.

Power closing assist for trunk lid

- ▶ Press the trunk lid gently into its lock.
The trunk closes automatically.

Warning!



Only drive with the trunk closed as, among other dangers such as visibility blockage, exhaust fumes may enter the vehicle interior.

Automatic central locking

The doors and the trunk automatically lock when the ignition is switched on and the wheels are turning at vehicle speeds of approximately 9 mph (15 km/h) or more.

You can open a locked door from the inside. Open door only when conditions are safe to do so.



The doors unlock automatically after an accident if the force of the impact exceeds a preset threshold. The vehicle locks automatically when the ignition is switched on and the wheels are turning at vehicle speeds of approximately 9 mph (15 km/h) or more. You could therefore lock yourself out when the vehicle

- is pushed or towed
- is on a test stand

You can deactivate the automatic locking using the control system (▷ page 168).

Controls in detail

Locking and unlocking

Locking and unlocking from the inside

You can lock or unlock the doors and the trunk from inside using the central locking or unlocking switch. This can be useful, for example, if you want to lock the vehicle before starting to drive.

The fuel filler flap will not be locked or unlocked with the central locking or unlocking switch, respectively.

Warning!



When leaving the vehicle, always remove the SmartKey or SmartKey with KEYLESS-GO* from the starter switch, take it with you, and lock the vehicle. Do not leave children unattended in the vehicle, or with access to an unlocked vehicle. Unsupervised use of vehicle equipment may cause an accident and/or serious personal injury.

The switches are located on the upper part of the front center console.



- ① Central locking switch
- ② Central unlocking switch

Locking

- ▶ Press central locking switch ①.

If the front passenger door is closed, the vehicle locks.

Unlocking

- ▶ Press central unlocking switch ②.

The vehicle unlocks.

i

You can open a locked door from the inside. Open door only when conditions are safe to do so.

If the vehicle was previously centrally locked with the SmartKey or the with KEYLESS-GO*, it will not unlock using the central unlocking switch ②.

If the vehicle was previously locked with the central locking switch ①:

- While in the global remote control mode, the vehicle is unlocked completely when a door is opened from the inside.
- While in the selective remote control mode, only the door opened from inside is unlocked.

Controls in detail

Seats

For more information on seat adjustment, see “Adjusting” (▷ page 37).

Easy-entry/exit feature

This feature allows for easier entry into and exit from the vehicle.

The easy-entry/exit feature can be activated or deactivated in the CONVENIENCE sub-menu of the control system (▷ page 170).

Warning!



You must make sure no one can become trapped or injured by the moving steering wheel and driver's seat when the easy-entry/exit feature is activated.

To cancel seat/steering wheel movement, do one of the following:

- Press seat adjustment switch (▷ page 38).
- Move steering column stalk (▷ page 40).
- Press one of the memory position buttons (▷ page 129).

Do not leave children unattended in the vehicle, or with access to an unlocked vehicle. Children could open the driver's door and unintentionally activate the easy-entry/exit feature, which could result in an accident and/or serious personal injury.

When exiting the vehicle, with the easy-entry/exit feature activated and depending on your selection, the steering wheel tilts upwards and/or the driver's seat moves a few inches to the rear when you:

- remove the SmartKey from the starter switch,
- or
- open the driver's door with the SmartKey in starter switch position **0** or **1** or the KEYLESS-GO* start/stop button (▷ page 35) in position **1**.



If the current position for the steering wheel is in the uppermost tilt position, the steering wheel will no longer be able to move upward when the easy-entry/exit feature is activated.

If the current seat position falls into a factory-set position range and the system recognizes the current seat position to be rearward enough for easy entry and exit, the driver's seat will not move to the rear when the easy-entry/exit feature is activated.

When entering the vehicle, with the easy-entry/exit feature activated, the steering wheel or, depending on your selection, the steering wheel and driver's seat will return to their last set memory position or a factory-set maximum forward position when you:

- close the driver's door with the ignition switched on
- insert the SmartKey into the starter switch or press the KEYLESS-GO* start/stop button (> page 35) once with the driver's door closed.



For safety reasons, the driver's seat will not return to its last set position with the easy-entry/exit feature activated if the system recognizes the last set position as an extreme forward position. Instead, the driver's seat will remain at or move to a factory-set maximum forward position. To again fully return the driver's seat to your last set position or to memory position, adjust the seat to the desired position or press and hold the respective memory position button (> page 129).

Controls in detail

Seats

Removing and installing front seat head restraints

For information on head restraint adjustment, see “Seats” (▷ page 37).

Warning!



For your protection, drive only with properly positioned head restraints.

Adjust head restraint so that the center of the head restraint supports the back of the head at eye level. This will reduce the potential for injury to the head and neck in the event of an accident or similar situation.

Do not drive the vehicle without the seat head restraints. Head restraints are intended to help reduce injuries during an accident.



Tilt the seat backrest to the rear for easier removal and installation of the head restraints.

Front seat head restraints

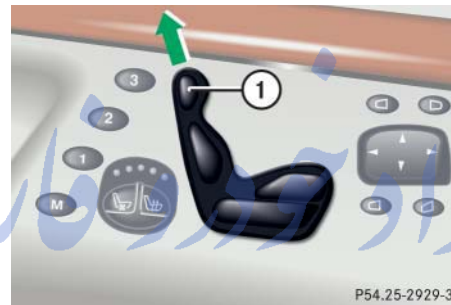

① Head restraint height switch

- ▶ Switch on ignition (▷ page 34).
or
- ▶ Open the respective door.

Removing front head restraints

- ▶ Press switch ① upwards and hold until the head restraint is fully extended.
- ▶ Pull out head restraint.

Installing front head restraints

- ▶ Press switch ① upwards and hold for about five seconds.
- ▶ Push the head restraint down until it engages.
- ▶ Adjust head restraint to desired position (▷ page 38).

Rear seats

Power seat bench*

The switches for adjusting the seat bench are located at the respective rear doors.



- ① Seat bench fore and aft adjustment
- ② Head restraint height

Seat bench fore and aft adjustment

- ▶ Press switch forward or backward in direction of arrow ①.

Head restraint height

- ▶ Press switch up or down in direction of arrow ②.

Warning!



For your protection, drive only with properly positioned head restraints.

Adjust head restraint so that the center of the head restraint supports the back of the head at eye level. This will reduce the potential for injury to the head and neck in the event of an accident or similar situation.

Do not drive the vehicle without the seat head restraints. Head restraints are intended to help reduce injuries during an accident.

Individual power seats*

The switches for adjusting the seats are located at the respective rear doors.



- ① Seat fore and aft adjustment
- ② Seat height
- ③ Head restraint height

Controls in detail

Seats

Seat fore and aft adjustment

- ▶ Press switch forward or backward in direction of arrow ①.

Seat height

- ▶ Press switch up or down in the direction of arrow ②.

Head restraint height

- ▶ Press switch up or down in direction of arrow ③.

Warning!



For your protection, drive only with properly positioned head restraints.

Adjust head restraint so that the center of the head restraint supports the back of the head at eye level. This will reduce the potential for injury to the head and neck in the event of an accident or similar situation.

Do not drive the vehicle without the seat head restraints. Head restraints are intended to help reduce injuries during an accident.

Power seat, setting front passenger seat position from rear*

This function lets you adjust the position of the front passenger seat from the rear.

Warning!



When adjusting the front passenger seat, make sure the seat, if occupied, is as far from the passenger front air bag as possible.

Otherwise, the passenger could be seriously or even fatally injured in the event of an accident or braking maneuver.

Make sure no one is caught or injured while the seat is being adjusted.

Even with the SmartKey or SmartKey with KEYLESS-GO* removed from the starter switch or the SmartKey with KEYLESS-GO* removed from the vehicle, the power seats can be operated when the respective door is open. Therefore, do not leave children unattended in the vehicle, or with access to an unlocked vehicle. Unsupervised use of vehicle equipment may cause an accident and/or serious personal injury.

Controls in detail

Seats

The switch is located on the right rear passenger door.



- ① Front passenger seat adjustment
- ② Right rear passenger seat adjustment
- ③ Seat height
- ④ Head restraint height
- ⑤ Backrest tilt
- ⑥ Seat fore and aft adjustment

- ▶ Switch on ignition (▷ page 34).
- or
- ▶ Open the right rear passenger door.
- ▶ Press button ① to adjust the front passenger seat.
- ▶ To adjust right rear passenger seat, press button ② (▷ page 119).



Adjusting the passenger seat position from the rear is not possible if you deactivate the operation of the rear door windows (▷ page 78).



Do not move the front passenger seat completely forward if objects are stored in the parcel net in the front passenger-side footwell. Items in the net may be damaged.

Passenger seat fore and aft adjustment

- ▶ Press the switch forward or backward in direction of arrow ⑥.

Passenger seat backrest tilt

- ▶ Press the switch forward or backward in direction of arrow ⑤.

Passenger seat height

- ▶ Press the switch up or down in the direction of arrow ③.

Passenger seat head restraint height

- ▶ Press the switch up or down in direction of arrow ④.



Adjust the head restraint in such a way that it is as close to the head as possible.

▷▷

Controls in detail

Seats



Warning!



For your protection, drive only with properly positioned head restraints.

Adjust head restraint so that the center of the head restraint supports the back of the head at eye level. This will reduce the potential for injury to the head and neck in the event of an accident or similar situation.

Do not drive the vehicle without the seat head restraints. Head restraints are intended to help reduce injuries during an accident.

Rear seat head restraints



The rear head restraints cannot be removed.

Folding head restraints back

The rear seat head restraints and the rear seat power head restraints* can be folded backward for increased visibility.

The switch is located on the upper part of the front center console.



① Switch in the front center console

- ▶ Switch on ignition (▷ page 34).
- ▶ Press switch ① in the front center console briefly.

The rear head restraints will fold backward.

Warning!



For safety reasons, always drive with the rear head restraints in the upright position when the rear seats are occupied.

Keep the area around head restraints clear of articles (e.g. clothing) to not obstruct the folding operation of the head restraints.

Placing head restraints upright

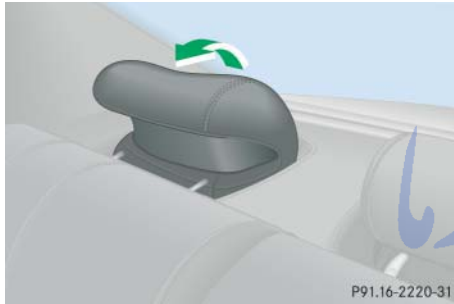

P91.16-2220-31

- ▶ Pull the rear head restraint upright until it locks into position.



Make sure the head restraints engage when placing them upright manually. Otherwise their protective function cannot be ensured.

Placing power head restraints* upright

- ▶ Switch on ignition (▷ page 34).
- ▶ Press switch ① in the front center console and hold.

The rear head restraints will fold upright.

Folding back and placing upright power head restraints* with the switches in the rear doors

You can fold the rear power head restraints backward or upright using the head restraint folding switches in the respective rear doors.



P54.25-3356-31

- ① Head restraint switch, rear
- ▶ Switch on ignition (▷ page 34).
- or
- ▶ Open the respective door.
- ▶ Press switch up in direction of arrow ①.



Controls in detail

Seats

- ▷▷ The rear power head restraint will fold upright.
 - ▶ Press switch down in direction of arrow ①.
- The rear power head restraint will fold backward.

Warning!



For safety reasons, always drive with the rear head restraints in the upright position when the rear seats are occupied.

Keep the area around head restraints clear of articles (e.g. clothing) to not obstruct the folding operation of the head restraints.

Head restraint tilt

You can adjust the angle manually by pulling or pushing the head restraints by hand.



Adjust the head restraint in such a way that it is as close to the head as possible.

Lumbar support

You can adjust the contour of the seat's lumbar support to best support your spine.

The thumbwheel for the driver's and front passenger seat are located on the inner side of the seat.

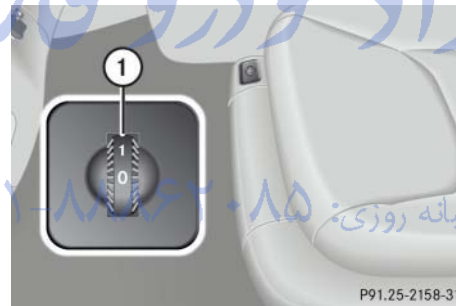

① Thumbwheel

- ▶ Switch on ignition (▷ page 34).
- ▶ Set the lumbar support between 0 and 5.

Multicontour backrest*

The multicontour backrest has inflatable air cushions built into the seat backrest to provide additional lumbar and side support.

The seat backrest cushion height and curvature can be continuously varied with switches on the right side of the seat after turning the SmartKey in the starter switch to position **2** or pressing the KEYLESS-GO* start/stop button (▷ page 35) twice.

The switches for the driver's and front passenger seat are located on the inner side of the seat.



- ① Shoulder region support
- ② Side bolster adjustment
- ③ Massage function (PULSE)
- ④ Lumbar region support

► Switch on ignition (▷ page 34).

Shoulder region support

- Press **+** or **-** on switch ①.
The air cushion inflates or deflates.

Lumbar region support

- Press **↕** or **↕** on rocker switch ④.

This selects the air cushion you wish to adjust.

- Press **+** or **-** on rocker switch ④.

The air cushion inflates or deflates.

Side bolsters adjustment

- Adjust the side bolsters so that they provide good lateral support using switch ②.



When the engine is turned off, the last cushion setting is retained in memory, and the cushion is automatically adjusted to this setting when the engine is restarted.

Massage function (PULSE)

You can reduce muscle tension during long trips by periodically using the massage function.

- Press button ③.

The indicator lamp on button ③ comes on. The air cushions in the lumbar region inflate and deflate rhythmically.



The massage function switches off automatically after approximately eight minutes. The indicator lamp extinguishes.

Controls in detail

Seats

Drive-dynamic seat*

The drive-dynamic seat automatically adjusts the lateral support provided by the seat backrest to your driving style.

The switches for the driver's and front passenger seat are located on the inner side of the seat.



① Activate drive-dynamic function

The drive-dynamic seat electronically controls the air pressure in the air chambers of the seat backrest side bolsters. This function improves driving comfort and pleasure.

► Switch on ignition (▷ page 34).

Activating

► Press button ①.

The indicator lamp in the switch comes on and the following message appears in the multifunction display for five seconds:



Message for the driver's seat

Message for the front passenger seat:

DRIV. DYN. SEAT ADJ.
FRONT PASSENGER
ACTIVATED



You can adjust the characteristics of the drive-dynamic seat using the control system (▷ page 172).

Deactivating

► Press button ① again.

The indicator lamp in the button goes out.

The message for the driver's seat:

DRIV. DYN. SEAT ADJ.
DRIVER
DEACTIVATED

or the message for the front passenger seat:

DRIV. DYN. SEAT ADJ.
FRONT PASSENGER
DEACTIVATED

appears in the multifunction display.



When the engine is turned off, the last cushion setting retained in memory. The cushion is automatically adjusted to this setting when the engine is restarted.

Seat heating*

Vehicles without seat ventilation*

The switch is located on the door.



- ① Normal heating
- ② Rapid heating

► Switch on ignition (▷ page 34).

Switching on seat heating

► Press switch ①.

A red indicator lamp above the switch comes on.

Switching off seat heating

► Press switch ① again.



The seat heating will be automatically switched off after approximately 30 minutes.

Switching on rapid seat heating

► Press switch ②.

Both red indicator lamps above the switch come on.



The system switches over to normal heating mode after approximately five minutes. Only the right-hand indicator lamp remains lit.

Switching off rapid seat heating mode

► Press switch ② again.



If one or both of the lamps on the seat heating switch are flashing, there is insufficient voltage available since too many electrical consumers are turned on. The seat heating switches off automatically.

The seat heating will switch back on again automatically as soon as sufficient voltage is available.

Controls in detail

Seats

Vehicles with seat ventilation*

The switch is located on the door. The red indicator lamps on the switch show the heating level selected:

Level	
off	No indicator lamp on
1	One indicator lamp on
2	Two indicator lamps on



① Seat heating switch

- ▶ Switch on ignition.

Switching on seat heating

- ▶ Press switch ① twice.

A red indicator lamp above the switch comes on.

Switching off seat heating

- ▶ Press switch ① again.



The seat heating will be automatically switched off after approximately 30 minutes.

Switching on rapid seat heating

- ▶ Press switch ① once.

Both indicator lamps above the switch come on.



The system switches over to normal heating mode after approximately five minutes. Only the right-hand indicator lamp remains lit.

Switching off rapid seat heating mode

- ▶ Press switch ① twice.



If one or both of the lamps on the seat heating switch are flashing, there is insufficient voltage available since too many electrical consumers are turned on. The seat heating switches off automatically.

The seat heating will switch back on again automatically as soon as sufficient voltage is available.

Seat ventilation*

The switch is located on the door. Seat ventilation can be activated manually with the ignition switched on. The driver's seat ventilation can be activated automatically by the summer opening feature (▷ page 209).

The blue indicator lamps on the switch show the ventilation level selected:

Level	
3	Three indicator lamps on
2	Two indicator lamps on
1	One indicator lamp on
off	No indicator lamp on



① Seat ventilation switch

▶ Switch on ignition (▷ page 34).

Switching on seat ventilation

▶ Press switch ①.

Three blue indicator lamps above the switch come on.

Continue pressing switch ① until the desired seat ventilation level is reached.

Switching off seat ventilation

▶ Press switch ① repeatedly until all indicator lamps go out.

i

The seat ventilation for the driver's seat is automatically set to the highest level if activated via summer opening feature (▷ page 209).

!

If one or all of the lamps on the seat ventilation switch are flashing, there is insufficient voltage since too many electrical consumers are switched on. The seat ventilation switches off automatically.

The seat ventilation will switch back on again automatically as soon as sufficient voltage is available.

Controls in detail

Memory function



Prior to operating the vehicle, the driver should check and adjust the seat height, seat position fore and aft, and seat backrest angle if necessary, to ensure adequate control, reach, and comfort. The head restraint should also be adjusted for proper height. See also the section on air bags (▷ page 61) for proper seat positioning.

In addition, adjust the steering wheel to ensure adequate control, reach, operation and comfort. Both the inside and outside rear view mirrors should be adjusted for adequate rear vision.

Fasten seat belts. Infants and small children should be seated in a properly secured restraint system that complies with U.S. Federal Motor Vehicle Safety Standards 213 and 225 and Canadian Motor Vehicle Safety Standards 213 and 210.2.

You can store up to three different settings per SmartKey or SmartKey with KEYLESS-GO*.

The following settings are saved for each stored position the driver's door:

- Driver's seat and backrest position
- Settings for the multicontour seat*
- Steering wheel position
- Exterior rear view mirror position
- Automatic climate control

These key-dependent memory settings can be deactivated if desired. For information on key-dependent memory settings, see "Setting key-dependency" (▷ page 169).

The following settings are not key-dependent. They are stored when using the buttons on the front passenger door:

- Front passenger seat, backrest and head restraint position, and settings for multicontour seat*

Warning!



Do not activate the memory function while driving. Activating the memory function while driving could cause the driver to lose control of the vehicle.

Controls in detail

Memory function

The memory button and stored position switch are located on the door.

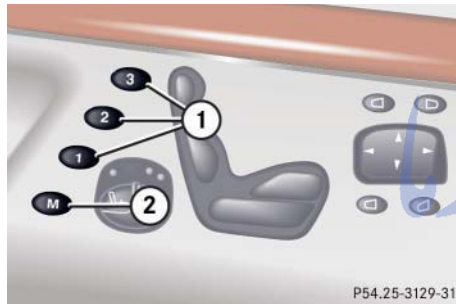

- ① Memory position buttons
- ② Memory button

▶ Switch on ignition (▷ page 34).

or

▶ Open the respective door and insert the SmartKey in the starter switch.

Storing positions into memory

- ▶ Adjust the seats, steering wheel and exterior rear view mirrors to the desired position (▷ page 37).
- ▶ Press memory button ②.
- ▶ Release memory button ② and push one of the position buttons ① within three seconds.

All the settings are stored with the selected position.

Recalling positions from memory

- ▶ Press and hold one of the position buttons ① until the seat, steering wheel and exterior rear view mirrors have fully moved to the stored positions.



Releasing the button immediately stops movement to the stored positions.

Warning!



Do not operate the power seats using the memory button if the seat backrest is in an excessively reclined position. Doing so could cause damage to front or rear seats.

First move seat backrest to an upright position.

Controls in detail

Memory function

Storing exterior rear view mirror parking position

For easier parking, you can adjust the passenger-side exterior rear view mirror so that you can see the right rear wheel as soon as you engage reverse gear **R**.

For information on activating the parking position, see “Setting parking position for exterior rear view mirror” (▷ page 171).



You can store a parking position for the passenger-side exterior rear view mirror for each SmartKey or SmartKey with KEYLESS-GO*.

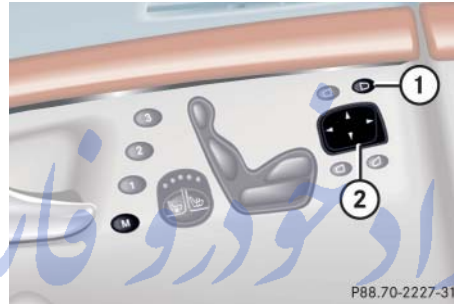

- ① Passenger-side exterior rear view mirror button
- ② Adjustment button
- M** Memory button

- ▶ Stop the vehicle.
- ▶ Switch on ignition (▷ page 34).
- ▶ Press button ①.

The passenger-side exterior rear view mirror is selected.

- ▶ Adjust the passenger-side exterior rear view mirror with button ② so that you see the rear wheel and the road curb.
 - ▶ Press memory button **M**.
 - ▶ Within three seconds, press bottom of adjustment button ② on .
- The parking position is stored if the mirror does not move.



If the mirror does move, repeat the above steps. After the setting is stored, you can move the mirror again.

▼ Lighting

For information on how to switch on the headlamps and use the turn signals, see “Switching on headlamps” (▷ page 50) and “Turn signals” (▷ page 51).



If you drive in countries where vehicles drive on the other side of the road than the country in which the vehicle is registered, you must have the headlamps modified for symmetrical low beams. Relevant information can be obtained at your authorized Mercedes-Benz Center.

Exterior lamp switch

The exterior lamp switch is located on the dashboard to the left of the steering wheel.

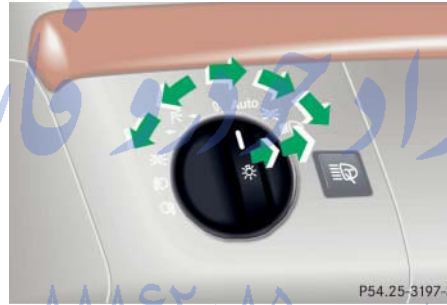

- 0** Off
 - Daytime running lamp mode (▷ page 165)
- AUTO** Automatic headlamp mode
 - Daytime running lamp mode (▷ page 165)
- Parking lamps (also side marker lamps, tail lamps, license plate lamps, instrument panel lamps)
- Low beam headlamps (or high beam headlamps when the combination switch is pushed forward) and parking lamps
- P** → Standing lamps, right (turn left one stop)
- ← P** Standing lamps, left (turn left two stops)
- Indicator lamp for parking lamps
- Indicator lamp for front fog lamps
- Indicator lamp for rear fog lamp

Controls in detail

Lighting



With the SmartKey removed from the starter switch or the engine turned off with KEYLESS-GO* and the driver's door open, a warning sounds if the parking lamps or low beam headlamps are switched on.

The message **TURN OFF LIGHTS** appears in the multifunction display.

Manual headlamp mode

The low beam headlamps and parking lamps can be switched on and off with the exterior lamp switch. For exterior lamp switch, see (▷ page 131).

Automatic headlamp mode

The following lamps switch on and off automatically depending on the brightness of the ambient light:

- Low beam headlamps
- Tail and parking lamps
- License plate lamps
- Side marker lamps.

Warning!



If the exterior lamp switch is set to **AUTO**

- the headlamps may switch off unexpectedly when the system senses bright ambient light, for example light from oncoming traffic.
- the headlamps will not be automatically switched on under foggy conditions.

To minimize risk to you and to others, activate headlamps by turning exterior lamp switch to when driving or when traffic and/or ambient lighting conditions require you to do so.

In low ambient lighting conditions, only switch from position **AUTO** to with the vehicle at a standstill. Switching from **AUTO** to will briefly switch off the headlamps. Doing so while driving in low ambient lighting conditions may result in an accident.

The automatic headlamp feature is only an aid to the driver. The driver is responsible for the operation of the vehicle's lights at all times.



The front fog lamps and rear fog lamp cannot be switched on manually with exterior lamp switch in position **AUTO**. To activate the fog lamps, turn exterior lamp switch to position and pull the exterior lamp switch to first or second stop (▷ page 134).

- ▶ Turn the exterior lamp switch to **AUTO**. With the SmartKey in starter switch position **1** or the KEYLESS-GO* start/stop button pressed once, only the parking lamps will switch on and off automatically.

When the engine is running, the low beam headlamps, the tail and parking lamps, the license plate lamps, and the side marker lamps will switch on and off automatically.

Daytime running lamp mode

- ▶ Turn exterior lamp switch to position **0** or **AUTO**.

When the engine is running, the low beam headlamps are switched on. In low ambient light conditions, the following lamps will switch on additionally:



- tail and parking lamps
- license plate lamps
- side marker lamps

For nighttime driving you should turn the exterior lamp switch to position  to permit activation of the high beam headlamps.

Canada only

The daytime running lamp mode is mandatory and therefore in a constant mode. When the engine is running, and you shift from a driving position to position **N** or **P**, the low beam headlamps will switch off with a three-minute delay.



When the engine is running, and you

- turn the exterior lamp switch to position , the parking lamps switch on additionally.
- turn the exterior lamp switch to position , the manual headlamp mode has priority over the daytime running lamp mode.

The corresponding exterior lamps switch on (▷ page 389).

USA only

By default, the daytime running lamp mode is deactivated. Activate the daytime running lamp mode using the control system, see “Setting daytime running lamp mode (USA only)” (▷ page 165).

When the engine is running, and you turn the exterior lamp switch to position  or , the manual headlamp mode has priority over the daytime running lamp mode.

The corresponding exterior lamps switch on (▷ page 389).

Locator lighting and night security illumination

Locator lighting and night security illumination are described in the control system section under “Setting locator lighting” (▷ page 166) and “Setting night security illumination” (▷ page 166).



Controls in detail

Lighting

Switching on fog lamps

Warning!



In low ambient lighting or foggy conditions, only switch from position **AUTO** to  with the vehicle at a standstill. Switching from **AUTO** to  will briefly switch off the headlamps. Doing so while driving in low ambient lighting conditions may result in an accident.



Fog lamps will operate with the parking lamps and/or the low beam headlamps on. Fog lamps should only be used in conjunction with low beam headlamps. Consult your State or Province Motor Vehicle Regulations regarding permissible lamp operation.



Fog lamps cannot be switched on with exterior lamp switch in position **AUTO**. For switching on the fog lamps, turn exterior lamp switch to position B first.

Switching on front fog lamps

- ▶ Switch on the low beam headlamps (▷ page 50).
- ▶ Pull out exterior lamp switch to first stop.

The front fog lamps are switched on. The green indicator lamp  in the lamp switch comes on (▷ page 131).

- ▶ Push in the exterior lamp switch.

The front fog lamps are switched off. The green indicator lamp  in the lamp switch goes out (▷ page 131).

Switching on rear fog lamp (driver's side only)

- ▶ Switch on the front fog lamps (▷ page 134).
- ▶ Pull out exterior lamp switch to second stop.

The rear fog lamps are switched on.

The yellow indicator lamp  in the lamp switch comes on (▷ page 131).

- ▶ Push in the exterior lamp switch to first stop.

The rear fog lamps are switched off.

The green indicator lamp  in the lamp switch goes out (▷ page 131).

The front fog lamps remain lit.

Combination switch

The combination switch is located on the left side of the steering column.

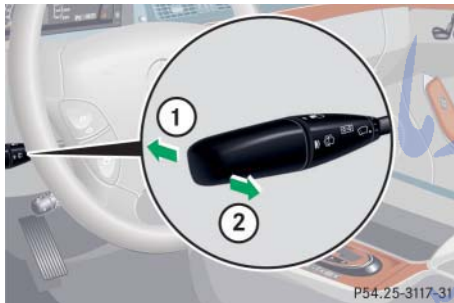

- ① High beam
- ② High beam flasher

Switching on high beams

- ▶ Turn exterior lamp switch to position  or to **AUTO** (▷ page 131).
- ▶ Push the combination switch in direction ①.

The high beam indicator  on the instrument cluster comes on (▷ page 24).

High beam flasher

- ▶ Pull the combination switch briefly in direction ②.

تلفن شبانه روزی: ۰۸۵-۸۸۶۲۰۸۱-۲۱

FarmaSOS.com

Controls in detail

Lighting

Hazard warning flasher

The hazard warning flasher can be switched on at all times, even with the SmartKey removed from the starter switch or with the SmartKey with KEYLESS-GO* removed from the vehicle.

The hazard warning flasher switches on automatically when an airbag deploys.



① Hazard warning flasher switch

Switching on the hazard warning flasher

- ▶ Press hazard warning flasher switch.

All turn signals will flash.



With the hazard warning flasher activated and the combination switch set for either left or right turn, only the respective left or right turn signals will operate when the SmartKey in the starter switch is in position **1** or **2** or the KEYLESS-GO* start/stop button (> page 35) is pressed once or twice.

Switching off the hazard warning flasher

- ▶ Press hazard warning flasher switch again.



If the hazard warning flasher was activated automatically, press switch ① twice.

Interior lighting

The controls are located in the overhead control panel.

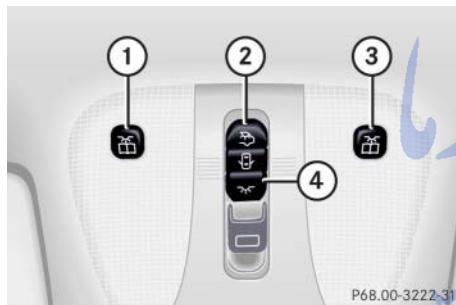

- ① Left reading lamp on/off
- ② Rear interior lamps on/off
- ③ Right reading lamp on/off
- ④ Rocker switch for automatic control on/off



Leaving an interior light switch in the ON position for extended periods of time with the engine turned off could result in a discharged battery.

Automatic control

Activating

- ▶ Press rocker switch ④ to the center position.

The interior lighting switches on in darkness when you:

- unlock the vehicle
- remove the SmartKey from the starter switch
- open a door
- open the trunk

The interior lighting switches off automatically following an adjustable time delay.

For more information, see “Setting interior lighting delayed shut-off” (▶ page 167).



If the door remains open, the interior lighting switches off automatically after approximately five minutes.

Deactivating

- ▶ Press the  symbol on rocker switch ④.

The interior lighting remains switched off in darkness, even when you:

- unlock the vehicle
- remove the SmartKey from the starter switch
- open a door
- open the trunk

Manual control

Front interior lighting

- ▶ Press the  symbol on rocker switch ④.

The front interior lighting switches on.



- ▶ Press the  symbol on rocker switch ④ again.

The front interior lighting switches off. The automatic control function is activated.

Controls in detail

Lighting

Rear interior lighting

- ▶ Press switch ② on the  symbol. The rear compartment lighting switches on.
- ▶ Press switch ② on the  symbol again. The rear compartment lighting switches off.



The setting selected for the interior lighting is used for the trunk lighting as well.

If the trunk lid remains open, the trunk lighting switches off automatically after approximately ten minutes.

Reading lamps in the front

The reading lamps are located in the overhead control panel.

- ▶ Press reading lamp switch ① or ③ to switch on the desired reading lamp.
- ▶ Press reading lamp switch ① or ③ again to switch off the respective reading lamp.

Reading lamps in the rear

The reading lamps are located in the roof lining for the rear seat passengers.

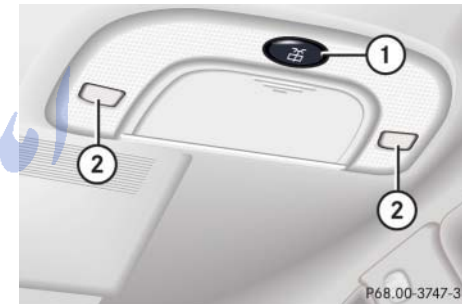

- ① Reading lamps on/off
- ② Reading lamps

- ▶ Press reading lamp switch ① to switch on reading lamps ②.
- ▶ Press reading lamp switch ① to switch off reading lamps ②.

Courtesy lighting

For better orientation in the dark, courtesy lamps will illuminate the interior of your vehicle as follows:

With parking lamps switched on:

- the door handles
- the driver and passenger footwells

With the SmartKey in the starter switch position **1**:

- the door handles
- the center console



If you turn the SmartKey in the starter switch to position **0** and switch off the exterior headlamps, the door handle lamps will remain lit for approximately five minutes.

Door entry lamps

For better orientation in the dark, the corresponding door entry lamps will switch on in darkness when you open a door and the automatic control is activated.

The door entry lamps switch off when the corresponding door is closed.



If you turn the SmartKey in the starter switch to position **0** and switch off the exterior headlamps, the door entry lamps will remain lit for approximately five minutes.

Trunk lighting

The trunk lighting switches on if the trunk lid is opened.

If you leave the trunk open for an extended period of time, the trunk lighting will switch off automatically after approximately ten minutes.

Controls in detail

Instrument cluster

A full view illustration of the instrument cluster can be found in the “At a glance” section of this manual (▷ page 24).



① Reset button R

The instrument cluster is activated when you:

- open a door
- turn on the ignition
- press the reset button R ①
- switch on the exterior lamps

You can change the instrument cluster settings in the instrument cluster submenu of the control system (▷ page 163).

Instrument cluster illumination

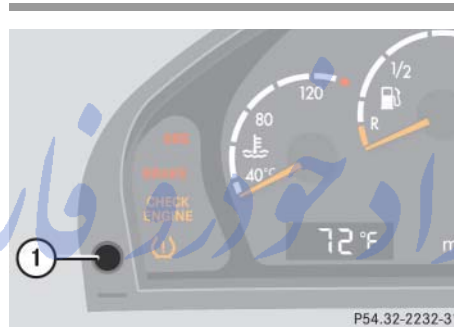

① Knob for adjusting instrument cluster illumination

Use knob ① to adjust the illumination brightness for the instrument cluster.



The instrument cluster illumination is dimmed or brightened automatically to suit ambient light conditions.

The instrument cluster illumination will also be adjusted automatically when you switch on the vehicle's exterior lamps.

► Press knob ①.

The knob will pop out.

To brighten illumination

► Turn knob ① in the instrument cluster clockwise.

The instrument cluster illumination will brighten.

To dim illumination

► Turn knob ① in the instrument cluster counterclockwise.

The instrument cluster illumination will dim.

Coolant temperature gauge

Warning!



- Driving when your engine is badly overheated can cause some fluids which may have leaked into the engine compartment to catch fire. You could be seriously burned.
- Steam from an overheated engine can cause serious burns and can occur just by opening the hood. Stay away from the engine if you see or hear steam coming from it.

Turn off the engine, get out of the vehicle and do not stand near the vehicle until the engine has cooled down.





Excessive coolant temperature triggers a warning in the multifunction display (▷ page 359).

During severe operating conditions, e.g. stop-and-go traffic, the coolant temperature may rise close to 248°F (120°C), i.e. close to the red zone of the temperature gauge.

The engine should not be operated with the coolant temperature above 248°F (120°C), i.e. in the red zone of the coolant temperature gauge. Doing so may cause serious engine damage which is not covered by the Mercedes-Benz Limited Warranty.

Trip odometer

- ▶ Make sure you are viewing the trip odometer display.
- ▶ If it is not displayed, press the  or  button on the multifunction steering wheel repeatedly until the trip odometer appears (▷ page 143).
- ▶ Press and hold reset button  (▷ page 140) until the trip odometer is reset.

Controls in detail

Instrument cluster

Tachometer

The red marking on the tachometer denotes excessive engine speed.



Avoid driving at excessive engine speeds, as it may result in serious engine damage that is not covered by the Mercedes-Benz Limited Warranty.

To help protect the engine, the fuel supply is interrupted if the engine is operated within the red marking.

S 55 AMG

The tachometer of the S 55 AMG does not have a red marking denoting excessive engine speed.

To help protect the engine, the fuel supply is interrupted if the engine is operated at an excessive engine speed.

Outside temperature indicator

Warning!



The outside temperature indicator is not designed to serve as an ice-warning device and is therefore unsuitable for that purpose.

Indicated temperatures just above the freezing point do not guarantee that the road surface is free of ice. The road may still be icy, especially in wooded areas or on bridges.

The outside temperature is displayed in the instrument cluster (▷ page 24). For information on how to select the unit of the displayed temperature, i.e. degrees Celsius (°C) or degrees Fahrenheit (°F), see “Selecting temperature display mode” (▷ page 163).

The temperature sensor is located in the front bumper area. Due to its location, the sensor can be affected by road or engine heat during idling or slow driving. Therefore, the accuracy of the displayed temper-

ature can only be verified by comparison to a thermometer placed next to the sensor, not by comparison to external displays (e.g. bank signs, etc.).

When moving the vehicle into colder ambient temperatures (e.g. when leaving your garage), you will notice a delay before the lower temperature is displayed.

A delay also occurs when ambient temperatures rise. This prevents inaccurate temperature indications caused by heat radiated from the engine during idling or slow driving.

Clock

The time is indicated in the instrument cluster in the tachometer display.

You can adjust the clock using the COMAND system. Refer to separate COMAND operating instructions.

▼ Control system

The control system is activated as soon as the SmartKey in the starter switch is turned to position **1** or as soon as the KEYLESS-GO* start/stop button (▷ page 35) is in position **1**. The control system enables you to:

- call up information about your vehicle
- change vehicle settings

For example, you can use the control system to find out when your vehicle is next due for service, to set the language for messages in the instrument cluster display, and much more.



The displays for the audio systems (radio, CD player) will appear in English, regardless of the language selected.

Warning!



A driver's attention to the road and traffic conditions must always be his/her primary focus when driving.

For your safety and the safety of others, selecting features through the multifunction steering wheel should only be done by the driver when traffic and road conditions permit it to be done safely.

Bear in mind that at a speed of just 30 mph (approximately 50 km/h), your vehicle is covering a distance of 44 feet (approximately 14 m) every second.

The control system relays information to the multifunction display.

Multifunction display

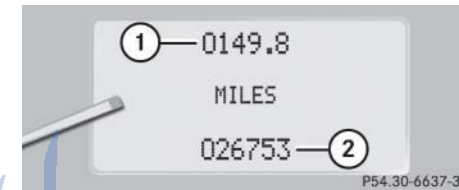

- ① Trip odometer
- ② Main odometer

Controls in detail

Control system

Multifunction steering wheel

The displays in the multifunction display and the settings in the control system are controlled using the buttons on the multifunction steering wheel.



- ① Multifunction display in the speedometer

Operating the control system

- ② Selecting the submenu or setting the volume

+ up/to increase

- down/to decrease

- ③ Telephone*

 to take a call

 to end a call

- ④ Menu systems

 for next menu

 for previous menu

- ⑤ Moving within a menu

 for next display





 for previous display

Pressing any of the buttons on the multifunction steering wheel will alter what is shown in the multifunction display.

The information available in the multifunction display is arranged in menus, each containing a number of functions or submenus.

The individual functions are then found within the relevant menu (radio or CD operations under **AUDIO**, for example). These functions serve to call up relevant information or to customize the settings for your vehicle.

It is helpful to think of the menus, and the functions within each menu, as being arranged in a circular pattern.

- If you press button  or  repeatedly, you will pass through each menu one after the other.
- If you press button  or  repeatedly, you will pass through each function display, one after the other, in the current menu.

In the **SETTINGS** menu, instead of functions you will find a number of submenus for calling up and changing settings. For instructions on using these submenus, see “Settings menu” (▷ page 160).

The number of menus available in the system depends on which optional equipment is installed in your vehicle.

The menus are described on the following pages.

تلفن شبانه روزی: ۰۲۱-۸۸۶۲۰۸۵

FarmaSOS.com

Controls in detail

Control system

Menus

This is what you will see when you scroll through the menus.

The table on the next page provides an overview of the individual menus.

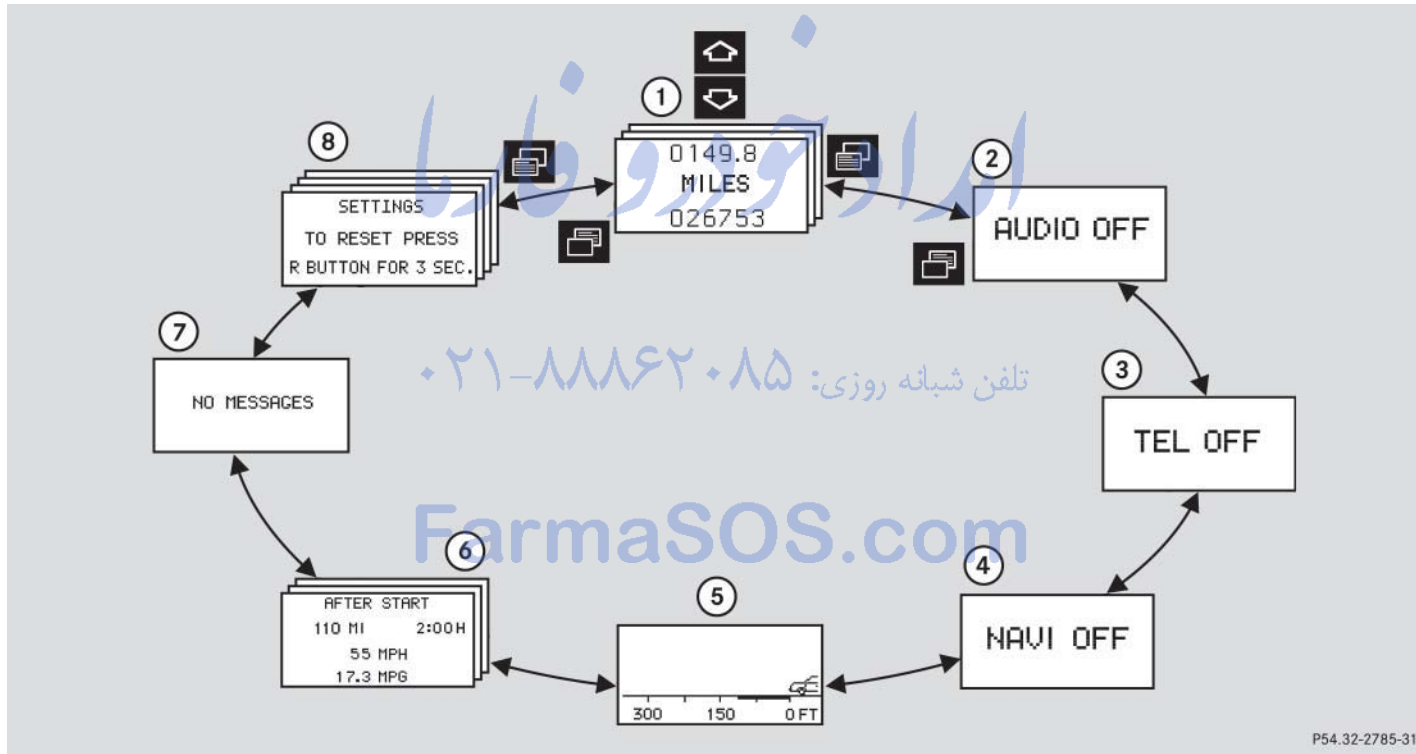

Menus, submenus and functions

	Menu ①	Menu ②	Menu ③	Menu ④	Menu ⑤	Menu ⑥	Menu ⑦	Menu ⑧
	Standard display (▷ page 148)	AUDIO (▷ page 148)	Telephone* (▷ page 153)	NAVI (▷ page 155)	Distronic* (▷ page 156)	Trip computer (▷ page 157)	Vehicle status message memory (▷ page 159)	Settings (▷ page 160)
Commands/submenus	Call up maintenance service display	Select radio station	Load phone book	Activate route guidance	Call up settings	Fuel consumption statistics after start	Call up vehicle malfunction, warning and system status messages stored in memory	Reset to factory settings
	Check tire inflation pressure*	Select satellite radio station* (USA only)	Search for name in phone book			Fuel consumption statistics since the last reset		Instrument cluster submenu
	Check engine oil level	Select CD track	Select number last dialed			Call up range		Lighting submenu
	Digital speedometer	Select MP3-CD track						Vehicle submenu
								Convenience submenu

Controls in detail

Control system



The headings used in the menus table are designed to facilitate navigation within the system and are not necessarily identical to those shown in the control system displays.

The first function displayed in each menu will automatically show you which part of the system you are in.

Standard display menu

You can select the functions in the standard display menu with button or .

The following functions are available:

Function	Page
Call up maintenance service display	329
Check tire inflation pressure*	307
Check engine oil level	288
Call up digital speedometer	148

Display digital speedometer

- ▶ Press the or button repeatedly until you see the digital speedometer appear in the multifunction display.

The current vehicle speed is shown in the multifunction display.

AUDIO menu



The functions in the AUDIO menu operate the audio equipment which you currently have turned on.

If no audio equipment is currently turned on, the message AUDIO OFF is shown in the multifunction display.

The following functions are available:

Function	Page
Select radio station	149
Select satellite radio* station (USA only)	149
Select CD track	150
Select MP3-CD track	150

Select radio station

- ▶ Turn on the radio. Refer to separate COMAND operating instructions.
- ▶ Press button  or  repeatedly until you see the currently tuned station in the multifunction display.



- ① Waveband
- ② Station frequency

- ▶ Press button  or  repeatedly until the desired station is found.





You can only store new stations using the corresponding feature on the radio. Refer to separate COMAND operating instructions.

You can also operate the radio in the usual manner.



Select satellite radio* station (USA only)

The satellite radio is treated as a radio application.

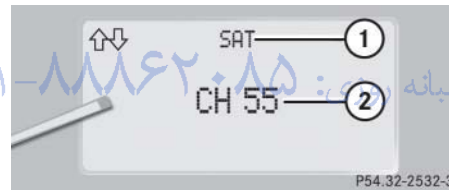
- ▶ Select satellite radio with the corresponding key on the COMAND control panel (SAT).
- ▶ Press button  or  repeatedly until you see the currently tuned station in the multifunction display.



- ① SAT mode and preset number
- ② Channel name or number

- ▶ Press button  or  repeatedly until the desired channel is found.





Additional optional satellite radio equipment and a subscription to satellite radio service provider are required for satellite radio operation. Contact an authorized Mercedes-Benz Center for details and availability for your vehicle.

For more information, refer to separate COMAND operating instructions.

Controls in detail

Control system

Select CD track

- ▶ Turn on COMAND and select CD. Refer to separate COMAND operating instructions.
- ▶ Press button  or  repeatedly until the settings for the CD currently being played appear in the multifunction display.





- ① Current CD
(for CD changer* (▶ page 151))
- ② Current track

- ▶ Press button  or  repeatedly until the desired track is selected.





CD changer*: To select a CD from the magazine, press a number on the COMAND system key pad located in the center dashboard.

Select MP3-CD track

- ▶ Turn on COMAND and select MP3-CD. Refer to separate COMAND operating instructions.
- ▶ Press button  or  repeatedly until the settings for the MP3-CD currently being played appear in the multifunction display.



- ① Current track
- ▶ Press button  or  repeatedly until the desired track is selected.

Controls in detail

Control system

CD changer* operating mode

General notes

Should excessively high temperatures occur while in CD mode, CD TEMP HIGH will appear on the multifunction display and muting will take place. The unit will then switch back to the last operating mode used until the temperature has decreased to a safe operating level.

Should excessively low temperatures occur while in CD mode, CD TEMP LOW will appear on the multifunction display, but the CD will continue to play.

Handle CDs carefully to prevent interference during playback. Avoid fingerprints and dust on CDs. Do not write on CDs or apply any label or other material to them.

Only use original CDs. Using copied CDs may create problems during playback.

Clean CDs from time to time with a commercially available cleaning cloth. No solvents, anti-static sprays, etc. should be used for cleaning. Replace the CD in its case after use. Protect CDs from heat and direct sunlight.



Only use CDs, which bear the label shown and that conform to the compact disc digital audio standard (IEC 60908).

Use of CDs which do not meet this standard may cause damage to the CD changer. Do not play single-CDs (80 mm) with an adapter.



Your CD drive has been designed to play CDs which correspond to the IEC 60908 standard.

If you insert thicker data carriers, e.g. ones that have data on both sides (one side with DVD data, the other side with audio data), they cannot be ejected and will damage the drive.

For information on operating the CD changer, refer to separate COMAND operating instructions.

Controls in detail

Control system

Warning!



The CD changer is a Class 1 laser product. There is a danger of invisible laser radiation if the cover is opened or damaged. Do not remove the cover. The CD changer does not contain any parts which can be serviced by the user. For safety reasons, have any service work which may be necessary performed only by qualified personnel.

Operational readiness of CD changer

If a CD changer has been installed in the system, it can be operated from the COMAND system key pad located in the center dashboard. A loaded magazine must be installed for CD playing.

Loading/unloading the CD magazine

The CD changer is located behind the cover on the left hand side in the trunk.

- ▶ Remove the CD changer cover.
- ▶ Slide the CD changer door to the right and press the eject button
- ▶ The magazine is ejected.

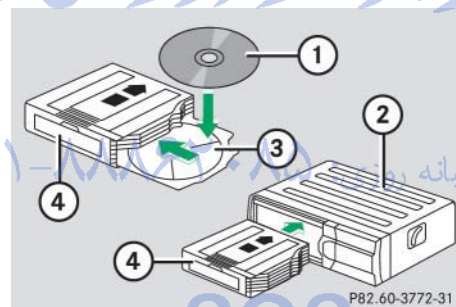

- ① CD
- ② CD changer
- ③ CD tray
- ④ CD magazine

- ▶ Remove the magazine and completely pull out the CD tray.
- ▶ Place the CD in the recess of the tray, label side up.
- ▶ Push the tray into the magazine in the direction shown by the arrow.



CDs which have been inserted improperly or are unreadable will not be played.

- ▶ Push the magazine into the CD changer in the direction shown by the arrow and close the CD changer door.

TEL menu*

Warning!





A driver's attention to the road must always be his/her primary focus when driving. For your safety and the safety of others, we recommend that you pull over to a safe location and stop before placing or taking a telephone call. If you choose to use the telephone while driving, please use the hands-free device and only use the telephone when weather, road and traffic conditions permit.

Some jurisdictions prohibit the driver from using a cellular telephone while driving a vehicle.

Bear in mind that at a speed of just 30 mph (approximately 50 km/h), your vehicle is covering a distance of 44 feet (approximately 14 m) every second.

Never operate radio transmitters equipped with a built-in or attached antenna (i.e. without being connected to an external antenna) from inside the vehicle while the engine is running. Doing so could lead to a malfunction of the vehicle's electronic system, possibly resulting in an accident and/or personal injury.

You can use the functions in the TEL menu to operate your telephone, provided it is connected to a hands-free system and switched on.

- ▶ Switch on the telephone and COMAND.
- ▶ Press button  or  on the steering wheel repeatedly until you see the TEL menu in the multifunction display.

Which messages will appear in the multifunction display field depends on whether your telephone is switched on or off:

- If the telephone is off, the message in the multifunction display is: TEL OFF.
- If the telephone is on:

The telephone will then search for a network. During this time the multifunction display reads NO SERVICE.

As soon as the telephone has found a network, READY is indicated in the multifunction display.

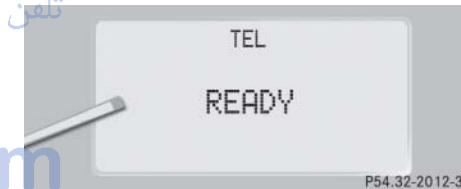

The standby message indicates that your telephone is ready for use and you can operate it using the control system.

Controls in detail

Control system

The following functions are available:

Function	Page
Answering a call	154
Ending a call	154
Dialing a number from the phone book	154
Redialing	155

Answering a call

When your telephone is ready to receive calls, you can answer a call at any time. In the display you will then see the message:



- ▶ Press button .

You have answered the call. In the display you see the duration of the call positioned above the number.



If you do not wish to accept a call, press button .





Ending a call

- ▶ Press button .

You have ended the call. In the display you will again see the standby message.

Dialing a number from the phone book



If your telephone is ready to receive calls, you may select and dial a number from the phone book at any time.

- ▶ Press button  or  repeatedly until you see the TEL menu in the display.
- ▶ Press button  or .

The control system reads the phone book which is stored in the telephone. The call transmission depends on the number of entries in the phone book



and can take up to 60 seconds. In the display you will see the message PLEASE WAIT!.

When the message PLEASE WAIT! disappears, the phone book has been loaded.

- ▶ Press button  or  repeatedly until the desired name appears in the display.

The stored names are displayed in ascending or descending alphabetical order.



If you press and hold  or  for longer than one second, the system scrolls rapidly through the list of names until you release the button again.

Cancel the quick search mode by pressing .

- ▶ Press button .

The system dials the selected phone number.

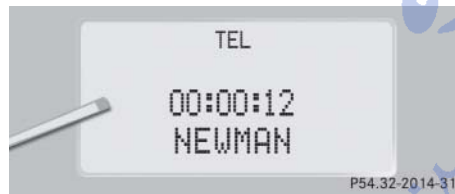

- If the connection is successful, the name of the party you called and the duration of the call will appear in the display.



- If no connection is made, the control system stores the dialed number in the redial memory.



Redialing

The control system stores the most recently dialed phone numbers. This eliminates the need to search through your entire phone book.

- ▶ Press button  or  repeatedly until you see the TEL menu in the display.

- ▶ Press button .

In the display you see the first number in the redial memory.

- ▶ Press button  or  repeatedly until the desired name appears in the display.





If you do not want to use the telephone, press button .

- ▶ Press button .

The control system dials the selected phone number.

NAVI menu

In the NAVI menu, you will see which status the navigation system has.

- ▶ Press button  or  repeatedly until you see the message NAVI in the display.

- If the navigation system is switched off, the message NAVI OFF is shown in the display.

- If the navigation system is on and no destination has been entered, you will see the current direction in which the vehicle is moving and the names of streets in the display.

Please refer to separate COMAND operating instructions on how to activate the route guidance system.



Controls in detail

Control system

Distronic* menu

Use the **DISTRONIC** menu to display the current settings for your DISTRONIC system. What information is shown in the display depends on whether the DISTRONIC system is active or inactive.

Please refer to the “Driving systems” section of this manual (> page 217) for instructions on how to activate DISTRONIC.

- ▶ Press button  or  repeatedly until you see one of the following two pictures in the display.

Distronic deactivated

When DISTRONIC is deactivated you will see the standard display in the display.

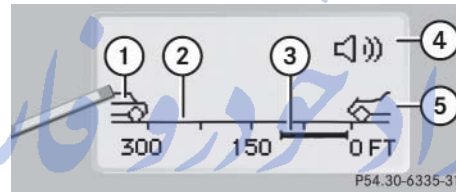

- ① Vehicle ahead, if detected
- ② Actual distance to vehicle ahead
- ③ Preset distance threshold to vehicle ahead
- ④ Symbol for activated distance warning function
- ⑤ Your vehicle

Distronic activated

When you activate DISTRONIC, you will see the set speed for about five seconds in the DISTRONIC display. The following display then appears:

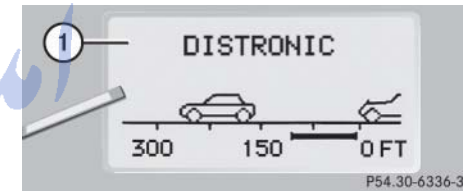





- ① DISTRONIC activated

Trip computer menu

Use the trip computer menu to call up statistical data on your vehicle. The following information is available:

Function	Page
Fuel consumption statistics after start	157
Fuel consumption statistics since last reset	158
Resetting fuel consumption statistics	158
Call up range (distance to empty)	158

Fuel consumption statistics after start

- ▶ Press button  or  repeatedly until you see the first function of the Trip computer menu.
- ▶ Press button  or  repeatedly until you see this message in the left display: AFTER START.



Each time you call up the trip computer, the last function used appears as the first display.

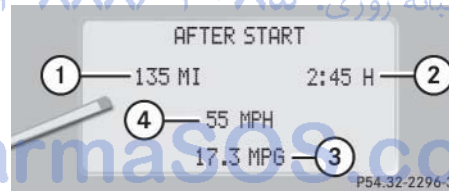

- ① Distance driven since start
- ② Time elapsed since start
- ③ Average fuel consumption since start
- ④ Average speed since start

Incorporating statistics from the previous journey in the consumption statistics

When you restart the engine, the AFTER START display flashes for:

- a distance of approximately 1.25 miles (two kilometers)
- or
- a duration of two minutes

During this period, the data from the previous journey can be incorporated as follows:

- ▶ Press the reset button **R** in the instrument cluster (▷ page 140).

The statistics will be incorporated.







If you do not press the reset button **R**, the consumption statistics will be reset to 0.

Controls in detail

Control system



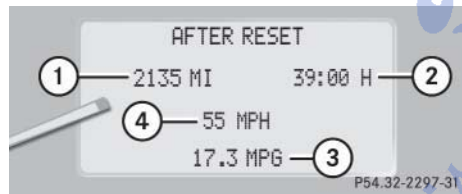

Fuel consumption since last reset

- ▶ Press button  or  repeatedly until you see the first function of the trip computer menu.
- ▶ Press button  or  repeatedly until you see this message in the display: AFTER RESET.







- ① Distance driven since last reset
- ② Time elapsed since last reset
- ③ Average fuel consumption since last reset
- ④ Average speed since last reset

Resetting fuel consumption statistics

- ▶ Press button  or  repeatedly until you see the first function of the Trip computer menu.
- ▶ Press button  or  repeatedly until you see the reading that you want to reset in the display.
- ▶ Press and hold the reset button  in the instrument cluster (> page 140) until the value is reset to 0.

Call up range (distance to empty)

- ▶ Press button  or  repeatedly until you see the first function of the Trip computer menu.
- ▶ Press button  or  repeatedly until you see this message in the display: RANGE.

In the display you will see the calculated range based on the current fuel tank level.





Vehicle status message memory menu

Use the vehicle status message memory menu to scan malfunction and warning messages that may be stored in the system. Such messages appear in the multifunction display and are based on conditions or system status the vehicle's system has recorded.

Warning!



Malfunction and warning messages are only indicated for certain systems and are intentionally not very detailed. The malfunction and warning messages are simply a reminder with respect to the operation of certain systems and do not replace the owner's and/or driver's responsibility to maintain the vehicle's operating safety by having all required maintenance and safety checks performed on the vehicle and by bringing the vehicle to an authorized Mercedes-Benz Center to address the malfunction and warning messages (▷ page 347).

- ▶ Press button  or  repeatedly until the vehicle status message memory appears in the multifunction display.

No vehicle status messages



If no conditions are recorded in the memory, the message in the multifunction display is:
NO MESSAGES

Vehicle status messages have been recorded

If conditions have occurred causing status messages to be recorded, the number of messages appears in the multifunction display:



① Number of messages

- ▶ Press button  or .

The stored messages will now be displayed in the order in which the malfunctions have occurred. See the "Practical hints" section for malfunction and warning messages (▷ page 347).

Should the vehicle's system record any conditions while driving, the number of messages will reappear in the multifunction display when the SmartKey in the starter switch is turned to position **0** or removed from the starter switch. If you press the reset button **R** in the instrument cluster (▷ page 140), the next message will be displayed immediately.





The vehicle status message memory will be cleared when you switch on ignition. You will then only see high-priority messages in the multifunction display. These are highlighted in red color (▷ page 347).

Controls in detail

Control system

Settings menu

In the SETTINGS menu there are two functions:

- The function TO RESET PRESS R BUTTON FOR 3 SEC., with which you can reset all settings to the original factory settings.
 - A collection of submenus with which you can make individual settings for your vehicle.
- ▶ Press button  or  repeatedly until the SETTINGS menu appears in the multifunction display.





The following settings and submenus are available:

Function	Page
Resetting all settings	160
Submenus in the Settings menu	161
Resetting the functions of a submenu	161
Instrument cluster submenu	163
Lighting submenu	164
Vehicle submenu	168
Convenience submenu	169

Resetting all settings

You can reset all the functions of all submenus to the factory settings.

- ▶ Press the reset button  in the instrument cluster (▷ page 140) for approximately three seconds.

In the multifunction display you will see the request to press the reset button  again to confirm.

- ▶ Press the reset button  again.

The functions of all the submenus will reset to factory settings.



The settings you have changed will not be reset unless you confirm the action by pressing the reset button  a second time.

Due to safety reasons, resetting all of the settings while driving will not reset all of the values in the LIGHTING or the VEHICLE menu.

Submenus in the Settings menu



- ▶ Press button  or .



In the multifunction display you see the collection of the submenus.





- ▶ Press button  or .

The selection marker moves to the next submenu.

The submenus are arranged by hierarchy. Scroll down with the  button, scroll up with the  button.

Move within the submenus with the  or  button to the individual functions.

The settings themselves are made with button  or .

Resetting the functions of a submenu

For each submenu you can reset all the functions to the factory settings.

- ▶ Move to a function in the submenu.
- ▶ Press the reset button  in the instrument cluster (▷ page 140) for approximately three seconds.

In the multifunction display you will see the request to press the reset button  again to confirm.

- ▶ Press the reset button  again.

All functions of the submenu will reset to factory settings.

Controls in detail

Control system

The table below shows what settings can be changed within the various menus. Detailed instructions on making individual settings can be found on the following pages.

INSTRUMENT CLUSTER	LIGHTING	VEHICLE	CONVENIENCE
Select temperature display mode	Set daytime running lamp mode (USA only)	Set automatic locking	Set key-dependency
Select multifunction display mode	Set locator lighting	Limiting opening height of trunk lid*	Activate easy-entry/exit feature
Select language	Exterior lamps delayed shut-off		Set parking position for exterior rear view mirror
Select tire inflation pressure unit	Interior lighting delayed shut-off		Set fold-in function for exterior rear view mirrors
			Adjusting the drive-dynamic seat

Instrument cluster submenu

Access the INST. CLUS. submenu via the SETTINGS menu. Use the INST. CLUS. submenu to change the instrument cluster display settings. The following functions are available:

Function	Page
Select temperature display mode	164
Select multifunction display mode	163
Select language	164
Select tire inflation pressure unit	164

Selecting temperature display mode

- ▶ Move the selection marker with the **+** or **-** button to the INST. CLUS. submenu.
- ▶ Press button **↶** or **↷** repeatedly until you see this message in the multifunction display: TEMP. INDICATOR.
The selection marker is on the current setting.

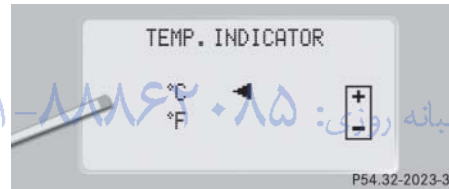

- ▶ Press **+** or **-** to set the temperature unit to degrees Celsius (°C) or degrees Fahrenheit (°F).

Selecting multifunction display mode

- ▶ Move the selection marker with the **+** or **-** button to the INST. CLUS. submenu.
- ▶ Press button **↶** or **↷** repeatedly until you see this message in the multifunction display: DISPLAY VALUES IN.
The selection marker is on the current setting.

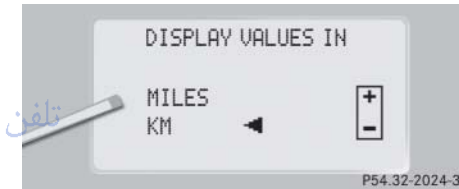

- ▶ Press **+** or **-** to set speedometer unit to MILES or KM.

Controls in detail

Control system

Selecting language

- ▶ Move the selection marker with the **+** or **-** button to the INST. CLUS. submenu.
- ▶ Press button **▲** or **▼** repeatedly until you see this message in the multifunction display: LANGUAGE.

The selection marker is on the current setting.



- ▶ Press **+** or **-** to select the language to be used for the multifunction display messages.

Available languages:

- German
- English
- French
- Italian
- Spanish

Selecting tire inflation pressure unit

Use this function to set the unit for the tire inflation pressure display.

- ▶ Move the selection marker with the **+** or **-** button to the INST. CLUS. submenu.
- ▶ Press button **▲** or **▼** repeatedly until you see this message in the multifunction display: DISPLAY UNIT TIRE PRESSURE.

The selection marker is on the current setting.



- ▶ Press **+** or **-** to select the desired tire inflation pressure unit.

Lighting submenu

Access the LIGHTING submenu via the SETTINGS menu. Use the LIGHTING submenu to change the lamp and lighting settings on your vehicle. The following functions are available:

Function	Page
Set daytime running lamp mode (USA only)	165
Set locator lighting	166
Exterior lamps delayed shut-off	166
Interior lighting delayed shut-off	167

Setting daytime running lamp mode (USA only)



This function is not available in countries where the daytime running lamp mode is mandatory and therefore in a constant mode.

- ▶ Move the selection marker with the **+** or **-** button to the LIGHTING submenu.
- ▶ Press button **↶** or **↷** repeatedly until you see this message in the multifunction display: LIGHTING CIRCUIT HEADLAMP MODE.

The selection marker is on the current setting.



- ▶ Press **+** or **-** to select manual or daytime running lamp (constant) mode. This function is not available in countries where daytime running lamps are mandatory.

With daytime running lamp mode selected and the exterior lamp switch at position **0**, the following lamps will come on automatically when the engine is turned on:

- Parking lamps and low beam headlamps
- License plate lamps (in low ambient light conditions)



If you turn the exterior lamp switch to another position, the corresponding lamp(s) will switch on.

For safety reasons, resetting the LIGHTING submenu to factory settings (▷ page 161) while driving will not reset the daytime running lamp mode.

In the multifunction display you will then see the message: LIGHTING - CANNOT BE COMPLETELY RESET TO FACTORY SETTINGS WHILE DRIVING.

Controls in detail

Control system

Setting locator lighting

During darkness, the following lamps will come on when the exterior lamp switch is in position **AUTO**, the locator lighting feature is activated, and the vehicle is unlocked by remote control:

- Parking lamps
- Tail lamps
- License plate lamps
- Front fog lamps

To activate locator lighting:

- ▶ Make sure the function LOCATOR LIGHTING is set.
- ▶ Turn the exterior lamp switch to position **AUTO**.

The locator lighting switches off when the driver's door is opened. It switches off automatically after a period of approximately 40 seconds.

- ▶ Move the selection marker with the **+** or **-** button to the LIGHTING submenu.
- ▶ Press button **↶** or **↷** repeatedly until you see this message in the multi-function display: LOCATOR LIGHTING.

The selection marker is on the current setting.



- ▶ Press **+** or **-** to select the desired setting.

The locator lighting will be switched ON or OFF.

Setting night security illumination

(Exterior lamps delayed switch-off)

Use the HEADLAMPS DELAYED SWITCH-OFF function to set whether and for how long you would like the exterior lamps to illuminate during darkness after all doors are closed. When the delayed switch-off feature is activated and the exterior lamp switch is in position **AUTO** before the engine is turned off, the following lamps will remain lit after you remove the SmartKey from the starter switch:

- Parking lamps
- Tail lamps
- License plate lamps
- Front fog lamps

Controls in detail

Control system



You can reactivate this function within ten minutes by opening a door.

If you do not open a door after removing the SmartKey, the lamps will automatically switch off after 60 seconds.

To activate night security illumination:

- ▶ Select delayed switch-off period (see below).
- ▶ Turn the exterior lamp switch to position **AUTO** before turning off the engine.

To select delayed switch-off period:

- ▶ Move the selection marker with the **+** or **-** button to the **LIGHTING** submenu.
- ▶ Press button **▲** or **▼** repeatedly until you see this message in the multi-function display: HEADLAMPS DELAYED SWITCH-OFF.

The selection marker is on the current setting.

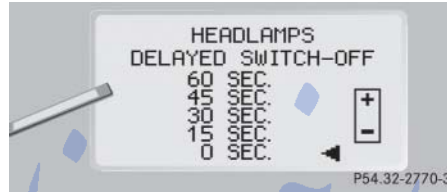

- ▶ Press **+** or **-** to select the desired lamp-on period.

You can select:

- 0 SEC., the delayed switch-off feature is deactivated
- 15 SEC., 30 SEC., 45 SEC., or 60 SEC., the delayed switch-off feature is activated

You can temporarily deactivate the delayed switch-off feature:

- ▶ Before leaving the vehicle, turn the SmartKey in the starter switch to position **0**.

- ▶ Turn the SmartKey in the starter switch to position **2** and back to **0**.

The delayed switch-off feature is deactivated. It will reactivate as soon as you reinsert the SmartKey in the starter switch.

Vehicles with KEYLESS-GO*:

- ▶ Press the KEYLESS-GO start/stop button (▷ page 35) on the gear selector lever.



Interior lighting delayed switch-off

Use this function to set whether and for how long you would like the interior lighting to remain lit during darkness after the SmartKey is removed from the starter switch.

- ▶ Move the selection marker with the **+** or **-** button to the **LIGHTING** submenu. ▷▷



Controls in detail

Control system

- ▷▷ Press button  or  repeatedly until you see this message in the multi-function display: INTERIOR LIGHTING DELAYED SWITCH-OFF.

The selection marker is on the current setting.



- ▶ Press  or  to select the desired lamp-on time period. You can select:
- 0 SEC., the delayed switch-off feature is deactivated.
 - 5 SEC., 10 SEC., 15 SEC., or 20 SEC., the delayed switch-off feature is activated.





Vehicle submenu

Access the VEHICLE submenu via the SETTINGS menu. Use the VEHICLE submenu to make general vehicle settings. The following functions are available:

Function	Page
Setting automatic locking	168
Limiting opening height of trunk lid*	169

Setting automatic locking

Use this function to activate or deactivate the automatic central locking. With the automatic central locking system activated, the vehicle is centrally locked at vehicle speeds of approximately 9 mph (15 km/h).

- ▶ Press button  or  to move the selection marker to the VEHICLE submenu.
- ▶ Press button  or  repeatedly until you see this message in the multi-function display: AUTOMATIC DOOR LOCK. The selection marker is on the current setting.



- ▶ Press  or  to switch AUTOMATIC DOOR LOCK ON or OFF.

Limiting opening height of trunk lid*

This function is available in vehicles with the trunk lid opening/closing system*. Use this function to activate or deactivate the limiting opening height of trunk lid.

- ▶ Move the selection marker with the **+** or **-** button to VEHICLE submenu.
- ▶ Press button **↶** or **↷** repeatedly until you see this message in the multi-function display:

OPENING LIMITER
TRUNK LID

The selection marker is on the current setting.



- ▶ Press button **+** or **-** to switch the opening limiter for trunk lid ON or OFF.

Convenience submenu

Access the CONVENIENCE submenu via the SETTINGS menu. Use the CONVENIENCE submenu to change the settings for a number of convenience features. The following functions are available:

Function	Page
Setting key-dependency	169
Activating easy-entry/exit feature	169
Setting parking position for exterior rear view mirror	171
Setting fold-in function for exterior rear view mirrors	171
Adjusting the drive-dynamic seat	172

Setting key-dependency

Use this function to set whether the memory settings for the seats, the steering wheel, the mirrors, and the automatic climate control should be stored separately for each SmartKey (▷ page 128).

- ▶ Move the selection marker with the **+** or **-** button to the CONVENIENCE submenu.
- ▶ Press button **↶** or **↷** repeatedly until you see this message in the multi-function display: SETTINGS KEY-DEPENDENT.

The selection marker is on the current setting.



- ▶ Press **+** or **-** to set key-dependency to ON or OFF.

Controls in detail

Control system

Activating easy-entry/exit feature

Use this function to activate and deactivate the easy-entry/exit feature (▷ page 114).

Warning!





You must make sure no one can become trapped or injured by the moving steering wheel and driver's seat when the easy-entry/exit feature is activated.

To cancel seat/steering wheel movement, do one of the following:

- Press seat adjustment switch (▷ page 38).
- Move steering column stalk (▷ page 40).
- Press the one of the memory position buttons or the memory button **M** (▷ page 129).

Do not leave children unattended in the vehicle, or with access to an unlocked vehicle. Children could open the driver's door and unintentionally activate the easy-entry/exit feature, which could result in an accident and/or serious personal injury.

- ▶ Move the selection marker with the **+** or **-** button to the **CONVENIENCE** submenu.
- ▶ Press button  or  repeatedly until you see this message in the multi-function display: **EASY-ENTRY FEATURE ACTIVATE**.

The selection marker is on the current setting.

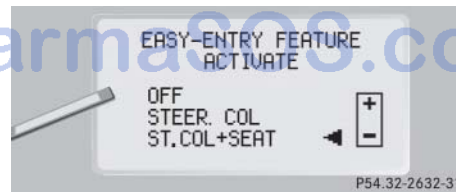

- ▶ Press **+** or **-** to change the easy-entry/exit setting.

The following settings are available for the easy-entry/exit feature:

OFF	The easy-entry/exit feature is deactivated.
STEER. COL	Only the steering column is moved.
ST.COL+SEAT	Both the steering column and the driver's seat are moved.

Controls in detail

Control system

Setting parking position for exterior rear view mirror

Use the MIRROR SETTING WHEN PARKING function to select whether the passenger-side exterior rear view mirror should be turned downward during parking maneuvers when reverse gear **R** is engaged. For additional information, see “Activating exterior rear view mirror parking position” (▷ page 187).

- ▶ Move the selection marker to the CONVENIENCE submenu using the **+** or **-** button.
- ▶ Press button **↶** or **↷** repeatedly until you see this message in the multifunction display: MIRROR SETTING WHEN PARKING.

The selection marker is on the current setting.



- ▶ Press **+** or **-** to switch function ON or OFF.

Setting fold-in function for exterior rear view mirrors

Using this function, you can set the exterior rear view mirrors to be automatically folded in when you lock your vehicle (▷ page 188).

- ▶ Move the selection marker to the CONVENIENCE submenu with the **+** or **-** button.

- ▶ Press button **↶** or **↷** repeatedly until the message FOLD IN MIRRORS WHEN LOCKING appears in the multifunction display.

The selection marker is on the current setting.



- ▶ Press button **+** or **-** to switch the automatic fold-in setting for the mirrors ON or OFF when the vehicle is locked.

Controls in detail

Control system

Adjusting drive-dynamic seats*

Use this function to adjust the settings for the drive-dynamic seat (▷ page 124).

- ▶ Move the selection marker with the **+** or **-** button to the CONVENIENCE submenu.
- ▶ To adjust the drive-dynamic seat press button **↕** or **↕** repeatedly until you see this message in the multifunction display:

DRIV. DYN. SEAT ADJ.
DRIVER
LEVEL 1
LEVEL 2

for the driver seat or

DRIV. DYN. SEAT ADJ.
FRONT PASSENGER
LEVEL 1
LEVEL 2

for the passenger seat.

The selection marker is on the current setting.

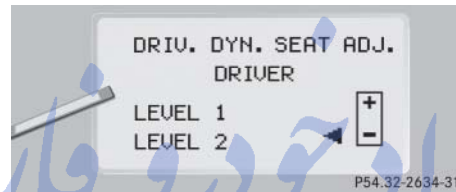

- ▶ Press button **+** or **-** to select the desired setting.

The following settings are available:

LEVEL 1	(Sporty) Strong lateral support and fast air pressure build-up in the air chambers of the backrest side bolsters
LEVEL 2	(Comfort) Less lateral support and slow air pressure build-up in the air chambers of the backrest side bolsters

تلفن شبانه روزی: ۰۲۱-۸۸۶۲۰۸۵

FarmaSOS.com

▼ Automatic transmission

For more information on driving with an automatic transmission, see “Automatic transmission” (▷ page 46).

Your vehicle’s transmission adapts its gear shifting process to your individual driving style by continually adjusting the shift points up or down. These shift point adjustments are performed based on current operating and driving conditions.

If the operating conditions change, the automatic transmission reacts by adjusting its shift program.



During the brief warm-up, transmission upshifting is delayed. This allows the catalytic converter to heat up more quickly to operating temperature.

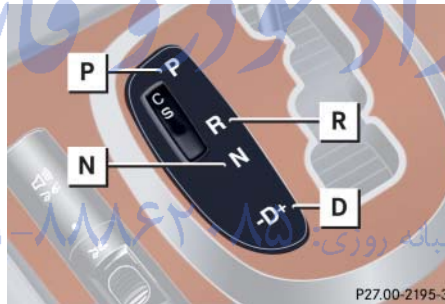

Gearshift pattern for automatic transmission

The automatic transmission selects individual gears automatically, depending on:

- the gear selector lever position **D** (▷ page 177) with gear ranges (▷ page 176)
- the selected program mode: **(C/S)** (▷ page 179) or **(M/C/S)** (S 55 AMG only) (▷ page 183)
- the position of the accelerator pedal (▷ page 180)
- the vehicle speed

Controls in detail

Automatic transmission



- ① Current gear range/gear selector lever position
- ② Current program mode

The current gear range/gear selector lever position and program mode (C/S) or (M/C/S) appear in the tachometer display.

Warning!



It is dangerous to shift the gear selector lever out of **P** or **N** if the engine speed is higher than idle speed. If your foot is not firmly on the brake pedal, the vehicle could accelerate quickly forward or reverse. You could lose control of the vehicle and hit someone or something. Only shift into gear when the engine is idling normally and when your right foot is firmly on the brake pedal.



Allow engine to warm up under low load use. Do not place full load on the engine until the operating temperature has been reached.

Shift into reverse gear **R** or parking position **P** only when the vehicle is stopped.

Avoid spinning of a drive wheel for an extended period when driving off on slippery road surfaces. This may cause serious damage to the drivetrain which is not covered by the Mercedes-Benz Limited Warranty.

When the gear selector lever is in position **D**, you can influence transmission shifting by:

- limiting the gear range
- changing gears manually

One-touch gearshifting

Even with an automatic transmission you can change the gears manually when the gear selector lever is in position **D**.

Downshifting

- ▶ Briefly press the gear selector lever to the left in the **D-** direction.

The transmission will shift from the current gear to the next lower gear as permitted by the shift program. This action simultaneously limits the gear range of the transmission (> page 176).

Warning!



On slippery road surfaces, never downshift in order to obtain braking action. This could result in drive wheel slip and reduced vehicle control. Your vehicle's ABS will not prevent this type of loss of control.



To avoid overrevving the engine when the gear selector lever is moved to the **D-** direction, the transmission will not shift to a lower gear if the engine's max. speed would be exceeded.

Upshifting

- ▶ Briefly press the gear selector lever to the right in the **D+** direction.

The transmission will shift from the current gear to the next higher gear as permitted by the shift program. This action simultaneously extends the gear range of the transmission.

Canceling gear range limit

- ▶ Press and hold the gear selector lever in the **D+** direction until **D** reappears in the tachometer display.

The transmission will shift from the current gear range directly to gear range **D**.

Shifting into optimal gear range

- ▶ Press and hold the gear selector lever in the **D-** direction.

The transmission will automatically select the gear range suited for optimal acceleration and deceleration. This will involve shifting down one or more gears.

Controls in detail

Automatic transmission

Gear ranges

With the gear selector lever in position **D**, you can limit the transmission's gear range by pressing the gear selector lever to the left (**D-**), and reverse the gear range limit by pressing the gear selector lever to the right (**D+**).

The selected gear range appears in the tachometer display (▷ page 174). If you press on the accelerator when the engine has reached its rpm limit, the transmission will upshift beyond any gear range limit selected.

	Effect
6	The transmission shifts through sixth gear only (applies to vehicles with 7-speed automatic transmission only).
5	The transmission shifts through fifth gear only (applies to vehicles with 7-speed automatic transmission only).
4	The transmission shifts through fourth gear only.
3	The transmission shifts through third gear only. With this selection you can use the braking effect of the engine.

	Effect
2	The transmission shifts through second gear only. Allows the use of engine's braking power when driving: <ul style="list-style-type: none">• on steep downgrades• in mountainous regions• under extreme operating conditions
1	The transmission operates in first gear only. For maximum use of engine's braking effect on very steep or lengthy downgrades.

FarmaSOS.com

Controls in detail

Automatic transmission

Gear selector lever position

	Effect
P	Park position Gear selector lever position when the vehicle is parked. Place gear selector lever in position P only when vehicle is stopped. The park position is not intended to serve as a brake when the vehicle is parked. Rather, the driver should always set the parking brake in addition to placing the gear selector lever in position P to secure the vehicle.

	Effect
	The SmartKey can only be removed from the starter switch with the gear selector lever in position P . With the SmartKey removed, the gear selector lever is locked in position P .
R	Reverse gear Place gear selector lever in position R only when vehicle is stopped.

	Effect
N	Neutral No power is transmitted from the engine to the drive axle. When the brakes are released, the vehicle can be moved freely (pushed or towed). To avoid damage to the transmission, never engage N while driving. If the ESP is deactivated or malfunctioning: Move gear selector lever to N only if the vehicle is in danger of skidding, e.g. on icy roads.
D	Drive The transmission shifts automatically. All forward gears are available.

FarmaSOS.com

Controls in detail

Automatic transmission



Coasting the vehicle, or driving for any other reason with gear selector lever in **N** can result in transmission damage that is not covered by the Mercedes-Benz Limited Warranty.

Warning!



Getting out of your vehicle with the gear selector lever not fully engaged in position **P** is dangerous. Also, position **P** alone is not intended to or capable of preventing your vehicle from moving, possibly hitting people or objects.

Always set the parking brake in addition to shifting to position **P** (▷ page 48).

When parked on an incline, turn the front wheels towards the road curb.

Do not park this vehicle in areas where combustible materials such as grass, hay or leaves can come into contact with the hot exhaust system, as these materials could be ignited and cause a vehicle fire.

Warning!



When leaving the vehicle, always remove the SmartKey or SmartKey with KEYLESS-GO* from the starter switch, take it with you, and lock the vehicle. Do not leave children unattended in the vehicle, or with access to an unlocked vehicle. Children could move the gear selector lever from position **P**, which could result in an accident and/or serious personal injury.

Controls in detail

Automatic transmission

Automatic shift program

The program mode selector switch is located on the lower part of the center console.



① Program mode selector switch

C Comfort For comfort driving

S Sport For standard driving

The current gear selector lever position and the selected program mode (C/S) are indicated in the tachometer display (> page 174).



Never change the program mode when the gear selector lever is out of position **P**. This could result in a change of driving characteristics for which you may not be prepared.



The last selected program mode (**C** or **S**) is switched on when the engine is restarted.

- ▶ Press program mode selector switch ① repeatedly until the letter of the desired program mode appears in the tachometer display.

Select **C** for comfort driving:

- The vehicle starts out in second gear (both forward and reverse) for gentler starts. This does not apply if full throttle is applied or gear range **1** is selected.
- Traction and driving stability are improved on icy roads.
- Upshifts occur earlier even when you give more gas. The engine then operates at lower rpms and the wheels are less likely to spin.

Controls in detail

Automatic transmission

Driving tips

Accelerator position

Your driving style influences the transmission's shifting behavior:

Less throttle	Earlier upshifting
More throttle	Later upshifting

Kickdown

Use kickdown when you want maximum acceleration.

- ▶ Press the accelerator past the point of resistance.
The transmission shifts into a lower gear.
- ▶ Ease on the accelerator when you have reached the desired speed.
The transmission shifts up again.

Stopping

When you stop briefly, e.g. at traffic lights:

- ▶ Leave the transmission in gear.
- ▶ Hold the vehicle with the brake.

When you stop longer with the engine idling or on an uphill gradient:

- ▶ Move the gear selector lever to position **P**.
- ▶ Set the parking brake.

Maneuvering

When you maneuver in tight areas, e.g. when pulling into a parking space:

- ▶ Control the vehicle speed by gradually releasing the brakes.
- ▶ Accelerate gently.
- ▶ Never abruptly step on the accelerator.

Working on the vehicle

Warning!



When working on the vehicle, set the parking brake and move gear selector lever to position **P**. Otherwise the vehicle could roll away.

Steering wheel gearshift control (Speedshift) S 55 AMG

When driving in the automatic program modes **C** or **S**, or in the manual program mode **M**, you can change the gears manually on the steering wheel or by using the gear selector lever (▷ page 175).



To avoid overrevving the engine when downshifting with steering wheel gearshift buttons, the transmission will not shift to a lower gear if the engine's max. speed would be exceeded.



Allow engine to warm up under low load use. Do not place full load on the engine until the operating temperature has been reached.

Shift into reverse gear **R** or parking position **P** only when the vehicle is stopped.

Avoid spinning of a drive wheel for an extended period when driving off on slippery road surfaces. This may cause serious damage to the drivetrain which is not covered by the Mercedes-Benz Limited Warranty.

Controls in detail

Automatic transmission

The steering wheel gearshift buttons are located to the left and right of the steering wheel.

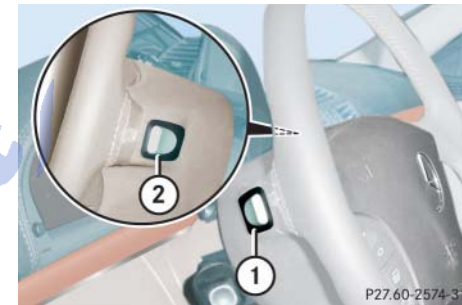

- ① Left button: downshift
- ② Right button: upshift

Controls in detail

Automatic transmission



You cannot shift with the steering wheel gearshift buttons when the gear selector lever is in position **P**, **N** or **R**.

The manual program mode **M** will not be stored. When the engine is turned off with the manual program mode **M** selected, the transmission will go to the automatic program mode (**C** or **S**) when the engine is restarted.

The last selected program mode (**C** or **S**) is switched on when the engine is restarted in the automatic program mode.

Downshifting

Warning!



On slippery road surfaces, never downshift in order to obtain braking action. This could result in drive wheel slip and reduced vehicle control. Your vehicle's ABS will not prevent this type of loss of control.

- ▶ Press button ① on the left side of the steering wheel.

The transmission will shift to the next lower gear as permitted by the shift program. This action simultaneously limits the gear range of the transmission (▷ page 176) when you are driving in the automatic program mode (**C** or **S**).

Upshifting

- ▶ Press button ② on the right side of the steering wheel.

The transmission will shift to the next higher gear as permitted by the shift program. This action simultaneously extends the gear range of the transmission when you are driving in the automatic program mode (**C** or **S**).

Manual shift program S 55 AMG

In the manual program mode **M** you can change the gears manually on the steering wheel (▷ page 181) or by using the gear selector lever (▷ page 175).



Allow engine to warm up under low load use. Do not place full load on the engine until the operating temperature has been reached.

Shift into reverse gear **R** or parking position **P** only when the vehicle is stopped.

Avoid spinning of a drive wheel for an extended period when driving off on slippery road surfaces. This may cause serious damage to the drivetrain which is not covered by the Mercedes-Benz Limited Warranty.

The program mode selector switch is located on the lower part of the center console.



① Program mode selector switch

M Manual For manual gear shifting

C Comfort For comfort driving

S Sport For standard driving

The current gear selector lever position and the selected program mode (M/C/S) are indicated in the tachometer display (▷ page 174).

Activating manual shift program

- ▶ Press program mode selector switch ① repeatedly until the **M** for the manual program mode **M** appears in the tachometer display.

The transmission switches to the manual program mode **M**. Automatic shifting is switched off. The gear range is not limited.

You can change the gears manually when the gear selector lever is in position **D**. You can upshift or downshift through the gears in succession.

Controls in detail

Automatic transmission

Downshifting

Warning!



On slippery road surfaces, never downshift in order to obtain braking action. This could result in drive wheel slip and reduced vehicle control. Your vehicle's ABS will not prevent this type of loss of control.

- ▶ Briefly press the gear selector lever to the left in the **D-** direction (▷ page 175).

or

- ▶ Press button ① on the left side of the steering wheel (▷ page 181).

The transmission shifts to the next lower gear.



When you brake or stop, the transmission shifts down to a gear from which you can easily accelerate or take off.

Upshifting

- ▶ Briefly press the gear selector lever to the right in the **D+** direction (▷ page 175).

or

- ▶ Press button ② on the right side of the steering wheel (▷ page 181).
The transmission shifts to the next higher gear.

Kickdown

The kickdown can also be used for maximum acceleration when driving in the manual program mode **M**.

- ▶ Press the accelerator past the point of resistance.
The transmission shifts to a lower gear.
- ▶ Shift up once the desired speed has been reached.



When driving at full throttle, the transmission shifts to the next higher gear when maximum engine speed has been reached.

Deactivating manual shift program

- ▶ Press the program mode selector switch (▷ page 183) repeatedly until **C** or **S** appears in the tachometer display.

or

- ▶ Restart the engine.

The transmission will go to the automatic program mode (**C** or **S**).

The manual program mode **M** is not stored.

Emergency operation (Limp Home Mode)

If vehicle acceleration worsens or the transmission no longer shifts, the transmission is most likely operating in limp home (emergency operation) mode. In this mode only second gear and reverse gear can be activated.

- ▶ Stop the vehicle.
- ▶ Move gear selector lever to **P**.
- ▶ Turn off the engine.
- ▶ Wait at least ten seconds before restarting.
- ▶ Restart the engine.
- ▶ Move gear selector lever to position **D** (for second gear) or **R**.
- ▶ Have the transmission checked at an authorized Mercedes-Benz Center as soon as possible.

Controls in detail

Good visibility

For information on the windshield wipers, see “Windshield wipers” (▷ page 52).

Headlamp cleaning system* (Standard on S 500, S 600, S 55 AMG)

The switch is located on the left side of the dashboard.

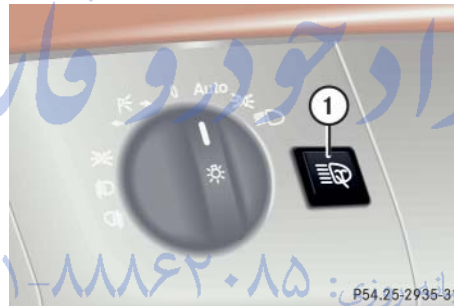

① Headlamp washer switch

- ▶ Switch on ignition (▷ page 34).
- ▶ Press switch ①.

The headlamps are cleaned with a high-pressure water jet.

For information on filling up the washer reservoir, see “Windshield washer system and headlamp cleaning system*” (▷ page 295).

Rear view mirrors

For information on setting the rear view mirrors, see “Mirrors” (▷ page 41).

Auto-dimming rear view mirror

The reflection brightness of the exterior rear view mirror on the driver’s side and the interior rear view mirror will respond automatically to glare when

- the ignition is switched on and
- incoming light from headlamps falls on the sensor in the interior rear view mirror

The interior rear view mirror will not react if

- reverse gear is engaged
- the interior lighting is turned on

Warning!



The auto-dimming function does not react if incoming light is not aimed directly at sensors in the interior rear view mirror.

The interior rear view mirror and the exterior rear view mirror on the driver's side do not react, for example, if the rear window sun shade* is in raised position.

Glare can endanger you and others.

Warning!



In the case of an accident, liquid electrolyte may escape from the mirror housing if the mirror glass breaks.

Electrolyte has an irritating effect. Do not allow the liquid to come into contact with eyes, skin, clothing, or respiratory system. In case it does, immediately flush affected area with water, and seek medical help if necessary.



Electrolyte drops coming into contact with the vehicle paint finish can be completely removed only while in the liquid state by applying plenty of water.

Warning!



Exercise care when using the passenger-side exterior rear view mirror. The mirror surface is convex (outwardly curved surface for a wider field of view). Objects in mirror are closer than they appear. Check your inside rear view mirror or glance over your shoulder before changing lanes.

Activating exterior rear view mirror parking position

Follow these steps to activate the mirror parking position so that the passenger-side exterior rear view mirror will be turned downward to the stored position.

- ▶ Make sure you have stored a parking position for the passenger-side exterior rear view mirror (▷ page 130).
- ▶ Make sure the MIRROR SETTING WHEN PARKING function in the CONVENIENCE submenu of the control system is switched to ON (▷ page 171).
- ▶ Switch on ignition (▷ page 34).

▷▷

Controls in detail

Good visibility

▷▷ Press button ② for the passenger-side exterior rear view mirror.

- ▶ Place the gear selector lever in reverse gear **R**.

The passenger-side exterior rear view mirror will be turned downward to the stored position.



- ① Driver's side exterior rear view mirror button
- ② Passenger-side exterior rear view mirror button

The exterior rear view mirror returns to its previously stored driving position:

- ten seconds after you put the gear selector lever out of position **R**
- immediately once your vehicle exceeds a speed of approximately 6 mph (10 km/h)
- immediately when you press button ① for driver's side mirror.

Electrically folding exterior rear view mirrors



Before driving the vehicle through an automatic car wash, fold the exterior mirrors in. Otherwise they may get damaged.

Folding exterior rear view mirrors in and out automatically

When the corresponding function in the control system is activated (▷ page 171):

- The exterior rear view mirrors automatically fold in as soon as the vehicle is locked from the outside.
- The exterior rear view mirrors automatically fold out as soon as the vehicle is unlocked and the driver's or front passenger door are subsequently opened.



If you are driving at more than approximately 9 mph (15 km/h), you will not be able to fold the exterior mirrors in.

Folding exterior rear view mirrors in and out manually

The exterior rear view mirrors can vibrate if they are not folded out completely.

The buttons are located on the driver's door.



- ① Folds the exterior mirrors out
- ② Folds the exterior mirrors in
- ▶ Switch on ignition (▷ page 34).

Folding in

- ▶ Press button ② briefly.
- Both mirrors fold in.

Folding out

- ▶ Press button ① briefly.
- Both mirrors fold out.



If an exterior rear view mirror housing is forcibly pushed forward (hit from the rear), reposition it manually by applying firm pressure until it snaps back into place.

If an exterior rear view mirror housing is forcibly pushed rearward (hit from the front), press button ② to fold mirrors in, then press button ① to fold mirrors out. Do not force mirrors by hand as this may damage the adjustment mechanism.

Windshield wipers

For more information on the windshield wipers, see “Windshield wipers” (▷ page 52).



Intermittent wiping is interrupted when the vehicle is at a standstill and a front door is opened.

A rain sensor automatically controls the windshield wipers depending on how wet the windshield is.

- ▶ Switch on ignition (▷ page 34).
- ▶ Set wiper switch to position I (▷ page 52).

After the initial wipe, pauses between wipes are automatically controlled by the rain sensor.

Controls in detail

Good visibility



Do not leave windshield wipers in intermittent setting when vehicle is taken to an automatic car wash or during windshield cleaning. Wipers will operate in the presence of water sprayed on the windshield, and wipers may be damaged as a result.

The switch should not be left in intermittent setting as the wipers will wipe the windshield once every time the engine is started. Dust that accumulates on the windshield might scratch the glass and/or damage the wiper blades when wiping occurs on a dry windshield.

Sun visors

The sun visors protect you from sun glare while driving.

Warning!



Do not use the vanity mirror while driving.

Keep the mirrors in the sun visors closed while vehicle is in motion. Reflected glare can endanger you and others.



For information on vanity mirrors (> page 242).

Glare from the front

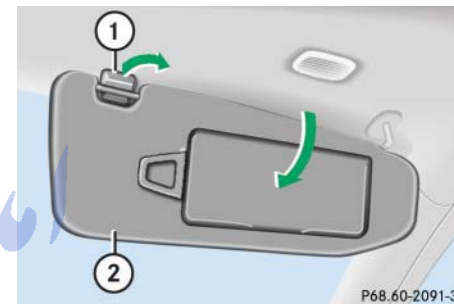

- ① Mounting
- ② Sun visor

► Swing sun visor ② down.

Glare from the front and sides

- Swing sun visor ② down.
- Disengage sun visor ② from mounting ①.
- Pivot sun visor to the side.

Controls in detail

Good visibility

Rear window sunshade*

The switch is located on the upper part of the front center console.



- ① Rear window sunshade switch
- ▶ Switch on ignition (▷ page 34).
- ▶ Press switch ① briefly to raise the sunshade.
- ▶ Press switch ① briefly to lower the sunshade.

Always raise the sunshade fully for its support against the window frame.

Warning!



When operating the rear window sunshade, be sure that there is no danger of anyone being harmed by the raising or lowering procedure.

The raising or lowering procedure can be immediately reversed by pressing switch ①.

Warning!



When leaving the vehicle, always remove the SmartKey or SmartKey with KEYLESS-GO* from the starter switch, take it with you, and lock the vehicle. Do not leave children unattended in the vehicle, or with access to an unlocked vehicle. Unsupervised use of vehicle equipment can cause an accident and/or serious personal injury.

Rear door window sunshade*

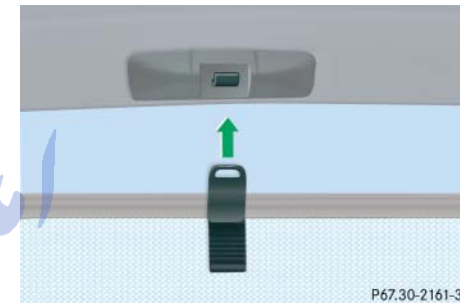

P67.30-2161-31

- ▶ To raise sunshade pull on the tab and engage in holder.
- ▶ To lower sunshade disengage tab and guide retraction.



Always guide the sunshade. Do not let it snap back abruptly, as the retractor could be damaged.

Controls in detail

Automatic climate control



Controls in detail

Automatic climate control

	Item
①	Left center air vent, adjustable
②	Left air vent, fixed
③	Thumbwheel for air volume control for left center air vent
④	Thumbwheel for air temperature control for center air vents
⑤	Thumbwheel for air volume control for right center air vent
⑥	Right air vent, fixed
⑦	Right center air vent, adjustable
⑧	Side defroster vent, fixed
⑨	Side air vent, adjustable
⑩	Thumbwheel for air volume control for side air vents
⑪	Door air vent
⑫	Automatic climate control panel

Warning!



When operating the automatic climate control, the air that enters the passenger compartment through the air vents in the footwell can be very hot or very cold (depending on the set temperature). This may cause burns or frostbite on unprotected skin in the immediate area of the air vents. Always keep sufficient distance between unprotected parts of the body and the footwell air vents. If necessary change the air flow using the air distribution controls to direct the air away from the footwell air vents (▷ page 196).

i

For draft-free ventilation, move the sliders for the center air vents ①, ⑦, ⑨ to the middle position.

Controls in detail

Automatic climate control

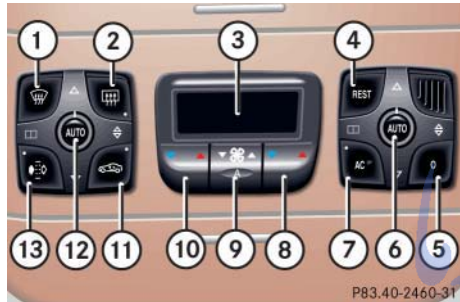

Automatic climate control panel

	Item
①	Windshield defroster
②	Rear window defroster
③	Display
④	Residual engine heat utilization (REST)
⑤	Automatic climate control on/off
⑥	Air distribution, right
⑦	AC cooling on/off
⑧	Right side temperature control
⑨	Air volume (automatic, manual)
⑩	Left side temperature control
⑪	Air recirculation
⑫	Air distribution, left
⑬	Activated charcoal filter

The automatic climate control is operational whenever the engine is running. You can operate the climate control system in either the automatic or manual mode. The system cools or heats the interior depending on the selected interior temperature and the current outside temperature.

Warning!



When operating the automatic climate control, the air that enters the passenger compartment through the air vents in the footwell can be very hot or very cold (depending on the set temperature). This may cause burns or frostbite on unprotected skin in the immediate area of the air vents. Always keep sufficient distance between unprotected parts of the body and the footwell air vents. If necessary change the air flow using the air distribution controls to direct the air away from the footwell air vents (▷ page 196).

Controls in detail

Automatic climate control

Nearly all dust particles, pollutants and odors are filtered out before outside air enters the passenger compartment through the air distribution system.

The air conditioning will not engage (no cooling) if the **AC^{OFF}** mode is selected (▷ page 202).

Warning!



Follow the recommended settings for heating and cooling given on the following pages. Otherwise the windows could fog up, impairing visibility and endangering you and others.



The current climate control settings (ON/OFF, temperature, air volume, activated charcoal filter, etc.) are stored for each SmartKey before it is removed from the starter switch or when the vehicle is locked using the SmartKey with KEYLESS-GO* (▷ page 108).

If the vehicle interior is hot, ventilate the interior before driving off.

Keep the air intake grille in front of the windshield free of snow, leaves, sticks, and any other debris.

Do not obstruct air volume by placing objects on the air volume-through exhaust slots below the rear window.



When operating the climate control system in automatic mode, you will only rarely need to adjust the temperature, air volume and air distribution.

Setting the temperature

Use temperature controls ⑩ and ⑧ (▷ page 194) to separately adjust the air temperature on each side of the passenger compartment. You should raise or lower the temperature setting in small increments, preferably starting at 72°F (22°C).

Increasing/decreasing

▶ Press button ⑩ or ⑧ repeatedly until the display shows the desired temperature.

The automatic climate control system will correspondingly adjust the interior air temperature.

FarmaSOS.com

Controls in detail

Automatic climate control

Adjusting the temperature for center air vents

When outside temperatures are low, you can manually raise the air temperature for the center and side air vents. The thumbwheel ④ is located between the center air vents (▷ page 192).

Automatic temperature control

- ▶ Turn thumbwheel ④ to **A**.
The indicator lamp above the thumbwheel comes on. The temperature is automatically adjusted to the set value.

Turning on warm air

- ▶ Turn thumbwheel ④ in the direction of the white marking.

Warm air will enter from the center air vent.





Turning on cooler air

- ▶ Turn thumbwheel ④ in the direction of the blue marking.

Cooler air will enter from the center air vent.

Adjusting air distribution



Use air distribution controls ⑫ and ⑥ (▷ page 194) to separately adjust the air distribution on each side of the passenger compartment. The following symbols are found on the controls:

Symbol	Function
	Directs air through the center air vents
	Directs air to the windows
	Directs air into the entire vehicle interior
	Directs air to the footwells





Controls in detail

Automatic climate control







Adjusting manually

- ▶ Press left or right button **AUTO**.
The button emerges and the ,  and  symbols become visible.
- ▶ Turn the marking on the regulator to the desired symbol.
The air will be directed to the vents corresponding to this symbol.

Adjusting automatically





- ▶ Press left or right button **AUTO** until it clicks in.
The , ,  and  symbols are no longer visible.
The air distribution is adjusted automatically.

Windows fogged on the inside

- ▶ Press button **AC^{OFF}** to switch on the air conditioning (▷ page 194).
The indicator lamp in the button goes out.
- ▶ Press button  to switch off the air recirculation (▷ page 194).
The indicator lamp on the button goes out.
- ▶ Make sure left and right button **AUTO** emerges.
The , ,  and  symbols become visible.
- ▶ Press left and right  button.
- ▶ Set blower to the maximum speed.

- ▶ Adjust left and right air vents ① and ⑥ upwards (▷ page 192).
- ▶ Increase temperature setting.
- ▶ Open side air vents ⑨ and direct them onto the side windows (▷ page 192).

Windshield fogged on the outside

- ▶ Switch the windshield wipers on (▷ page 52).
- ▶ Press on both **AUTO** buttons until they click in.
The , ,  and  symbols are no longer visible.

Controls in detail

Automatic climate control

Adjusting air volume

Use air volume control ⑨ (▷ page 194) for both automatic and manual air volume adjustment.

Adjusting automatically

- ▶ Press **A** on air volume switch ⑨ (▷ page 194).

The display shows "AUTO." The air volume is adjusted automatically.

Adjusting manually

Reducing air volume

- ▶ Press switch ⑨ down until the desired air volume is reached.

The display shows the current level.

Increasing air volume

- ▶ Press switch ⑨ up until the desired air volume is reached.

The display shows the current level.

Maximum cooling MAXCOOL

If the left and right air distribution controls as well as the air volume control are set to **AUTO** and there is a high need for cooling, the display "AUTO MAXCOOL" appears.

This provides the fastest possible cooling of the vehicle interior (when windows and tilt/sliding sunroof are closed).

تلفن شبانه روزی: ۰۲۱-۸۸۶۲۰۸۵



FarmaSOS.com

Defrosting



These settings should only be selected for a short time.

Activating

- ▶ Press button  (▷ page 194).
The indicator lamp on the button comes on.
- ▶ Switch off air recirculation, if selected.
- ▶ Press button  (▷ page 194).
The indicator lamp on the button goes out.
- ▶ Close center air vents.
- ▶ Adjust side air vents upwards.

Deactivating

- ▶ Press button  (▷ page 194).
The indicator lamp on the button goes out. Defrosting is turned off.

Air recirculation mode

Switch to air recirculation mode to prevent unpleasant odors from entering the vehicle from the outside. This setting cuts off the intake of outside air and recirculates the air in the passenger compartment.

Warning!



When the outside temperature is below 41°F (5°C), only switch to air recirculation mode for short periods to prevent window fogging.

Activating

- ▶ Press button  (▷ page 194).
The indicator lamp on the button comes on.



If you keep button  pressed, the side windows and the tilt/sliding sunroof will close.

Warning!



Never operate the side windows and the tilt/sliding sunroof if there is the possibility of anyone being harmed by the closing procedure.

In the event that the procedure causes potential danger, the closing of the side windows can be immediately halted by pressing the respective window switch. The closing of the tilt/sliding sunroof can be immediately halted by moving the tilt/sliding sunroof switch in the overhead control panel in any direction.

The closing of the side windows and the tilt/sliding sunroof can be reversed by again pressing and holding the  button.

Controls in detail

Automatic climate control



The air recirculation mode is activated automatically:

- at high outside temperatures
- if the concentration of carbon monoxide and nitrogen oxide in the outside air increases beyond a predetermined level, for example in a tunnel.

Please note that the charcoal filter must be activated (▷ page 200) for the air recirculation mode to be activated automatically.

If you have turned off the air conditioning (▷ page 202) or the outside temperature is below 41°F (5°C), the air recirculation mode will not switch on automatically.

Deactivating

- ▶ Press button (▷ page 194).

The indicator lamp on the button goes out.



If you keep button pressed, the side windows and the tilt/sliding sunroof will return to their previous position.

The air recirculation mode is deactivated automatically:

- after five minutes if the outside temperature is below approximately 41°F (5°C)
- after five minutes if the air conditioning is turned off
- after 30 minutes if the outside temperature is above approximately 41°F (5°C)

At outside temperatures above 79°F (26°C) the system will not automatically switch back to outside air. A quantity of outside air is added after approximately 30 minutes.

Charcoal filter

An activated charcoal filter markedly reduces bad odors and removes pollutants from air entering the passenger compartment.

Activating

- ▶ Press button (▷ page 194).

The indicator lamp on the button comes on.



If you keep button pressed, the side windows and the tilt/sliding sunroof will close.

Warning!



Never operate the side windows and the tilt/sliding sunroof if there is the possibility of anyone being harmed by the closing procedure.

In the event that the procedure causes potential danger, the closing of the side windows can be immediately halted by pressing the respective window switch. The closing of the tilt/sliding sunroof can be immediately halted by moving the tilt/sliding sunroof switch in the overhead control panel in any direction.

The closing of the side windows and tilt/sliding sunroof can be reversed by again pressing and holding the  button.

Deactivating

- ▶ Press button  (> page 194).

The indicator lamp on the button goes out.



If you keep button  pressed, the side windows and the tilt/sliding sunroof will return to their previous position.

The system automatically switches to the air recirculation mode if the carbon monoxide (CO) or nitrogen oxide (NO_x) concentration of the outside air increases beyond a predetermined level, for example in a tunnel.

The automatic air recirculation mode does not function if  is selected or if the outside temperature has fallen below 41°F (5°C).

The activated charcoal filter should be switched off when windows fog up on the inside, or if the passenger compartment needs to be quickly heated or cooled down.

Controls in detail

Automatic climate control

Rear window defroster

The rear window defroster uses a large amount of power. To keep battery drain to a minimum, switch off the defroster as soon as the rear window is clear. The defroster is automatically deactivated after approximately 6 to 17 minutes of operation depending on the outside temperature.

Activating

- ▶ Press button  (> page 194).
The indicator lamp on the button comes on.

Deactivating

- ▶ Press button  (> page 194) again.
The indicator lamp on the button goes out.

Controls in detail

Automatic climate control

Warning!



Any accumulation of snow and ice should be removed from the rear window before driving. Visibility could otherwise be impaired, endangering you and others.



If the rear window defroster switches off too soon and the indicator lamp starts flashing, this means that too many electrical consumers are operating simultaneously and there is insufficient voltage in the battery. The system responds automatically by deactivating the rear window defroster.

As soon as the battery has sufficient voltage, the rear window defroster automatically turns itself back on.

Deactivating the climate control system



Deactivating

It is possible to completely deactivate the automatic climate control system.

- ▶ Press button **0** (▷ page 194).
The display shows “0”.

Reactivating

There are several ways to reactivate the automatic climate control system:

- ▶ Press one of the following buttons, **0**, , **AUTO**, a temperature control switch (▷ page 194) or air volume switch  on the automatic climate control panel.

Air conditioning

The air conditioning is operational while the engine is running and cools the interior air to the temperature set by the operator.



Condensation may drip out from underneath the vehicle. This is normal and not an indication of a malfunction.

Deactivating

It is possible to deactivate the air conditioning (cooling) function of the automatic climate control system. The air in the vehicle will then no longer be cooled or dehumidified.

- ▶ Press button **AC^{OFF}** (▷ page 194).

The indicator lamp on the button **AC^{OFF}** comes on.

Activating

Moist air can fog up the windows. You can dehumidify the air with the air conditioning.

- ▶ Press **AC^{OFF}** again (▷ page 194).
The indicator lamp on the **AC^{OFF}** button goes out.

The air conditioning uses the refrigerant R134a. This refrigerant is free of CFCs which are harmful to the ozone layer.



If the **AC^{OFF}** button on the automatic climate control panel starts to flash, this indicates that the air conditioning is losing refrigerant. The compressor has turned itself off. The air conditioning cannot be turned on again.

Have the air conditioning checked at the nearest authorized Mercedes-Benz Center.

Residual heat and ventilation

With the engine switched off, it is possible to continue to heat or ventilate the interior for up to 30 minutes. This feature makes use of the residual heat produced by the engine.

Activating

- ▶ Turn the SmartKey in the starter switch to position **1** or **0**, or remove it from the starter switch.
- ▶ Press button **REST** (▷ page 194).
The indicator lamp on button **REST** comes on.

Deactivating

- ▶ Press button **REST** (▷ page 194).

The indicator lamp on button **REST** goes out.

The residual heat is automatically turned off:

- when the ignition is switched on
- after about 30 minutes
- if the battery voltage drops



How long the system will provide heating depends on the coolant temperature and the temperature set by the operator. The blower will run at speed setting 1 regardless of the air distribution control setting.

Controls in detail

Automatic climate control

Ventilated storage compartment

Depending on vehicle model and configuration, your vehicle is equipped with a storage compartment under the front armrest (▷ page 245) which can be ventilated when the automatic air conditioning is switched on. If so equipped, the switch is located inside the storage compartment in the front. The air temperature is about the same as that of the center air vents.

The air volume is dependent on the setting of:

- Air distribution control
- Air volume control
- Air vents in the dashboard

The air temperature is about the same as that of the dashboard air vents. It cannot be regulated separately.

Switching ventilation on

- ▶ Open the storage compartment in front of the armrest, see “Storage compartment in front of armrest” (▷ page 245).
- ▶ Push upper portion of switch.

Switching ventilation off

- ▶ Open the storage compartment in front of the armrest, see “Storage compartment in front of armrest” (▷ page 245).
- ▶ Push lower portion of switch.



Do not obstruct the air vent in the storage compartment.



The compartment can get very warm due to its confined space. When storing heat sensitive objects in the compartment, close the air vent while heating the passenger compartment.

Rear passenger compartment adjustable air vents

Rear center console air vents

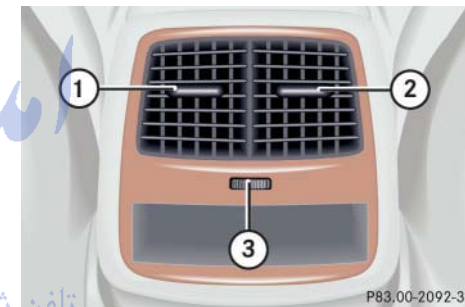

- ① Left center air vent, adjustable
- ② Right center air vent, adjustable
- ③ Thumbwheel for center air vents with adjustable booster blower

Controls in detail

Automatic climate control

To open center air vents and to adjust the booster blower:

- ▶ Turn thumbwheel ③.



The booster blower allows air volume speed to the rear passenger compartment to be increased at four different levels.

The temperature at the air vents for rear passenger compartment ① and ② is the same as at the dashboard center air vents.

Rear side air vents

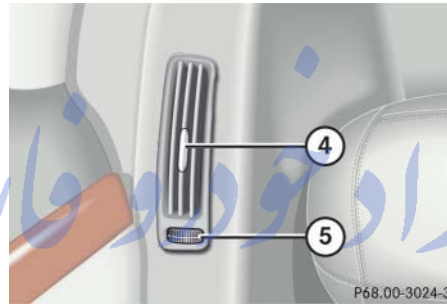

- ④ Rear side air vent, right and left
- ⑤ Air volume control for rear side air vent

To open rear side air vents:

- ▶ Turn thumbwheel ⑤ towards the window.

Rear passenger compartment climate control*

The automatic climate control is operational whenever the engine is running. You can operate the climate control system in either the automatic or manual mode. The system cools or heats the interior depending on the selected interior temperature and the current outside temperature.

The automatic climate control system is adjustable individually for the rear passenger compartment.

The control panel is located in the rear center console.

Nearly all dust particles, pollutants and odors are filtered out before outside air enters the passenger compartment through the air distribution system.

Controls in detail

Automatic climate control



When the rear seats are not occupied (rear seat belts unbuckled) the rear climate control system adopts the settings of the front climate control system.

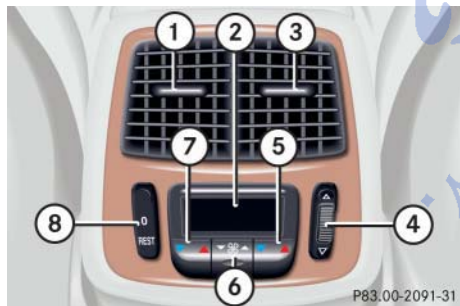

Rear automatic climate control panel

	Item
①	Left center air vent, adjustable
②	Display
③	Right center air vent, adjustable
④	Thumbwheel for air distribution
⑤	Temperature control, right
⑥	Air volume (automatic, manual)
⑦	Temperature control, left
⑧	Rear climate control system on/off Residual engine heat utilization

Warning!



Follow the recommended settings for heating and cooling as given in the instructions for the front automatic climate control (> page 192). Otherwise the windows could fog up, impairing visibility for the driver and endangering you and others.

▼ Power windows

Opening and closing the power windows

The side windows are opened and closed electrically. The switches for all side windows are on the driver's door. The switches for the respective windows are on the front passenger door and the rear doors.

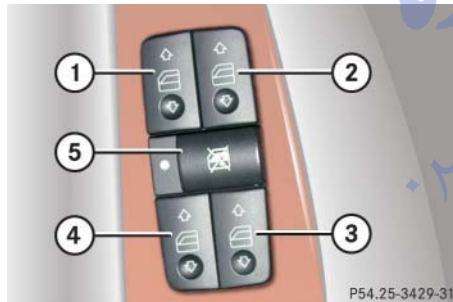

- ① Left front window
- ② Right front window
- ③ Right rear window
- ④ Left rear window
- ⑤ Rear window override switch (▷ page 78)

Warning!



When closing the windows, make sure that there is no danger of anyone being harmed by the closing procedure.

The closing of the door windows can be immediately halted by releasing the switch or, if the switch was pressed past the resistance point and released, by pressing the respective switch.

The door windows are equipped with the express-close and automatic reversal function. If the window encounters an obstruction that blocks its path in a circumstance where you pressed the switch past the resistance point and released it to close the window, the automatic reversal function will stop the window and open it slightly.



If the window encounters an obstruction that blocks its path in a circumstance where you are closing the window by pressing and holding the switch, by pressing and holding button  on the SmartKey, or by pressing and holding the lock button (vehicles

with KEYLESS-GO*) on the door handle, the automatic reversal function will not operate.

When leaving the vehicle, always remove the SmartKey or SmartKey with KEYLESS-GO* from the starter switch, take it with you, and lock the vehicle. Do not leave children unattended in the vehicle, or with access to an unlocked vehicle. Unsupervised use of vehicle equipment may cause an accident and/or serious personal injury.



You can also open or close the windows using the SmartKey, see “Summer opening feature” (▷ page 209) and “Convenience closing feature” (▷ page 210).

You can close and reopen the windows using the air recirculation button  or the charcoal filter button  in the climate control panel (▷ page 194).

Controls in detail

Power windows



Operating the windows from the rear is not possible if you activate the override switch (▷ page 78).



With the SmartKey in starter switch position **0** or removed from the starter switch, the power windows can be operated:

- until you open the driver's or front passenger door
- for at least five minutes.

- ▶ Switch on ignition (▷ page 34).

Opening the windows

- ▶ Press switch ① to ④ at the symbol  to the resistance point.

The corresponding window will move downwards until you release the switch.

Closing the windows

- ▶ Press switch ① to ④ at the symbol  to the resistance point.

The corresponding window will move upwards until you release the switch.

Warning



If you press and hold the switch up when closing the window, and upward movement of the window is blocked by some obstruction including but not limited to arms, hands, fingers, etc., the automatic reversal will not operate.

Fully opening the windows (Express-open)

- ▶ Press switch ① to ④ at the symbol  past the resistance point and release.

The corresponding window opens completely.

Fully closing the windows (Express-close)

- ▶ Press switch ① to ④ at the symbol  past the resistance point and release.

The corresponding window closes completely.

Warning!



Driver's door only:

If within five seconds you again press the switch past the resistance point and release, the automatic reversal will not function.



If the upward movement of the window is blocked during the closing procedure, the window will stop and open slightly. Remove the obstruction, press the respective power window switch at the symbol again past the resistance point and release. If the window still does not close when there is no obstruction, press and hold the respective power window switch at the symbol . The side window will then close without the obstruction sensor function.

Stopping windows during Express-operation

- ▶ Briefly press the respective power window switch again.

Synchronizing the power windows

The power windows must be synchronized

- after the battery has been disconnected
- if the power windows cannot be fully opened (Express-open) or closed (Express-close)

Each power window must be synchronized.

- ▶ Close all doors.
- ▶ Switch on ignition (▷ page 34).
- ▶ Press and hold switch ① to ④ at the symbol until the windows are completely closed.
- ▶ Hold on to switches ① to ④ for approximately one second.
The power windows are synchronized.

Summer opening feature

If the weather is warm, you can ventilate the vehicle before driving off by simultaneously:

- opening the side windows
- opening the tilt/sliding sunroof
- turning on the seat ventilation* for the driver's seat





The seat ventilation* for the driver's seat is automatically set to the highest level if activated via summer opening feature.

Controls in detail



Power windows





- ▶ Aim transmitter eye of the SmartKey or SmartKey with KEYLESS-GO* at the driver's outside door handle.
- ▶ Press and hold button  until the windows and tilt/sliding sunroof have reached the desired position.
- ▶ Release button  to interrupt procedure.

Convenience closing feature

When you lock the vehicle, you can close the windows and tilt/sliding sunroof simultaneously.

- ▶ Aim transmitter eye of the SmartKey or SmartKey with KEYLESS-GO* at the driver's outside door handle (▷ page 210).
- ▶ Press and hold button  until the windows and tilt/sliding sunroof are completely closed.
- ▶ Release button  to interrupt procedure.

Vehicles with KEYLESS-GO*:



- ▶ Press and hold button  or the lock button at the outside door handle (▷ page 58) until the side windows and the tilt/sliding sunroof are completely closed.
- ▶ Release button  or the lock button at the outside door handle to interrupt procedure.

Warning!



When closing the windows and the tilt/sliding sunroof, make sure that there is no danger of anyone being harmed by the closing procedure.

If potential danger exists, proceed as follows:

- Release button  to reverse direction of movement, press button  for opening or button  for closing.

Vehicles with KEYLESS-GO*:

- Pull on the door handle and hold firmly. The side windows and the tilt/sliding sunroof will open for as long as the door handle is held but the door is not opened.

▼ Power tilt/sliding sunroof

Opening and closing the power tilt/sliding sunroof

The tilt/sliding sunroof can be opened and closed electrically. The switch for the tilt/sliding sunroof is on the overhead control panel.



- ① Push up to raise sunroof at rear
- ② Pull down to lower sunroof at rear
- ③ Push forward to slide sunroof closed
- ④ Push back to slide sunroof open

With the sunroof closed or tilted open, a screen can be slid into the roof opening to guard against sun rays. When sliding the sunroof open, the screen will also retract.



Controls in detail

Power tilt/sliding sunroof

Warning!



When closing the tilt/sliding sunroof, make sure that there is no danger of anyone being harmed by the closing procedure.

The closing procedure of the tilt/sliding sunroof can be immediately halted by releasing the switch or, if the switch was moved past the resistance point and released, by moving the switch in any direction.

The tilt/sliding sunroof is made out of glass. In the event of an accident, the glass may shatter. This may result in an opening in the roof.

In a vehicle rollover, occupants not wearing their seat belts or not wearing them properly may be thrown out of the opening. Such an opening also presents a potential for injury for occupants wearing their seat belts properly as entire body parts or portions of them may protrude from the passenger compartment.



Controls in detail

Power tilt/sliding sunroof

▷▷ When leaving the vehicle, always remove the SmartKey or SmartKey with KEYLESS-GO* from the starter switch, take it with you, and lock the vehicle. Do not leave children unattended in the vehicle, or with access to an unlocked vehicle. Unsupervised use of vehicle equipment can cause an accident and/or serious personal injury.





To avoid damaging the seals, do not transport any objects with sharp edges which can stick out of the tilt/sliding sunroof.

Do not open the tilt/sliding sunroof if there is snow or ice on the roof, as this could result in malfunctions.

The tilt/sliding sunroof can be opened or closed manually should an electrical malfunction occur (▷ page 386).



You can also open or close the tilt/sliding sunroof using the SmartKey, see “Summer opening feature” (▷ page 209) and “Convenience closing feature” (▷ page 210).

You can close and reopen the tilt/sliding sunroof using the air recirculation button  or the charcoal filter button  in the climate control panel (▷ page 194).



With the SmartKey in starter switch position **0** or removed from the starter switch, the tilt/sliding sunroof can be operated

- until you open the driver's or passenger door
- for up to approximately five minutes.

- ▶ Switch on ignition (▷ page 34).

Opening and closing the power tilt/sliding sunroof

- ▶ To open, close, raise or lower the tilt/sliding sunroof, move the switch to resistance point in the required direction ① to ④.
- ▶ Release the sunroof switch when the tilt/sliding sunroof has reached the desired position.

Fully opening (Express-open) and closing (Express-close) the power the tilt/sliding sunroof

- ▶ To open, close, raise or lower the tilt/sliding sunroof, move the switch past the resistance point in the required direction ① to ④ and release. The tilt/sliding sunroof opens or closes completely.



The selecting a tilt/sliding sunroof opening position feature is activated for Canada vehicles, but deactivated for U.S. vehicles at the factory. If you wish to have it activated, contact an authorized Mercedes-Benz Center.

To select a tilt/sliding sunroof opening position, press the sunroof switch to the resistance point and release it when the tilt/sliding sunroof has reached the desired position. The tilt/sliding sunroof now opens to the position set when the sunroof switch is pressed past the resistance point in the “open” direction.

Stopping the power tilt/sliding sunroof during Express-operation

- ▶ Move the switch in any direction.



If the movement of the tilt/sliding sunroof is blocked during the closing procedure, the sunroof will stop and reopen slightly.

Synchronizing the power tilt/sliding sunroof

The tilt/sliding sunroof must be synchronized

- after the battery has been disconnected or discharged
- after the tilt/sliding sunroof has been closed manually (▷ page 386)
- the tilt/sliding sunroof does not open smoothly
- after a malfunction

- ▶ Switch on ignition (▷ page 34).
- ▶ Press and hold the sunroof switch in direction of arrow ① until the tilt/sliding sunroof is fully raised at the rear.
Keep holding the sunroof switch in the direction of arrow ① for approximately one second.
- ▶ Check the Express-open feature (▷ page 212).

If the tilt/sliding sunroof opens completely, the sunroof is synchronized. Otherwise repeat the above steps.

Controls in detail

Driving systems

The driving systems of your vehicle are described on the following pages:

- Cruise control and DISTRONIC*, with which the vehicle can maintain a preset speed.
- AIRMATIC adjusts the vehicle suspension characteristics automatically and controls the vehicle level.
- ABC* with vehicle level control system, with which you can change vehicle suspension characteristics.
- PARKTRONIC*, which serves as a parking assistant.

For information on the BAS, ABS, and ESP driving systems, see “Driving safety systems” (> page 80).

Cruise control

Cruise control automatically maintains the speed you set for your vehicle.

Use of cruise control is recommended for driving at a constant speed for extended periods of time. You can set or resume cruise control at any speed over 20 mph (30 km/h).

The cruise control function is operated by means of the cruise control lever.

The cruise control lever is the uppermost lever on the left-hand side of the steering column (> page 22).

Warning!



Cruise control is a convenience system designed to assist the driver during vehicle operation. The driver is and must remain at all times responsible for the vehicle speed and for safe brake operation.

Only use cruise control if the road, traffic and weather conditions make it advisable to travel at a steady speed.

- The use of cruise control can be dangerous on winding roads or in heavy traffic because conditions do not allow safe driving at a steady speed.
- The use of cruise control can be dangerous on slippery roads. Rapid changes in tire traction can result in wheel spin and loss of control.
- Deactivate cruise control when driving in fog.

The “Resume” function should only be operated if the driver is fully aware of the previously set speed and wishes to resume this particular preset speed.

Controls in detail

Driving systems

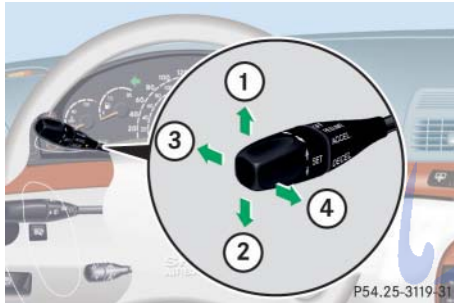

- ① Sets current or higher speed
- ② Sets current or lower speed
- ③ Cancels cruise control
- ④ Resumes at last set speed

Setting current speed

- ▶ Accelerate or decelerate to the desired speed.
- ▶ Briefly lift the cruise control lever in direction of arrow ① or depress in direction of arrow ②.

The current speed is set.

- ▶ Remove your foot from the accelerator pedal.

Cruise control is activated.

The selected speed appears in the multi-function display for approximately five seconds, and the corresponding speedometer segments from the selected speed to the vehicle maximum speed are illuminated.



On uphill or downhill grades, cruise control may not be able to maintain the set speed. Once the grade eases, the set speed will be resumed.

Canceling cruise control

There are several ways to cancel cruise control:

- ▶ Step on the brake pedal.

Cruise control is canceled. The last speed set is stored for later use.

or

- ▶ Briefly push the cruise control lever in direction of arrow ③.

Cruise control is canceled. The last speed set is stored for later use.



Moving the gear selector lever to position **N** while driving also cancels cruise control. However, the gear selector lever should not be moved to position **N** while driving, except to coast when the vehicle is in danger of skidding (e.g. on icy roads).



The last stored speed is canceled when you turn off the engine.

Controls in detail

Driving systems

Setting a higher speed

- ▶ Lift cruise control lever in direction of arrow ① and hold it up until the desired speed is reached.
- ▶ Release cruise control lever.
The new speed is set.



Depressing the accelerator pedal does not deactivate cruise control. After brief acceleration (e.g. for passing), cruise control will resume the last speed set.

Setting a lower speed

- ▶ Depress cruise control lever in direction of arrow ② and hold it down until the desired speed is reached.
- ▶ Release cruise control lever.
The new speed is set.



When you use the cruise control lever to decelerate, the transmission will automatically downshift if the engine's braking power does not brake the vehicle sufficiently.

Fine adjustment in 1 mph (Canada: 1 km/h) increments

Faster

- ▶ Briefly tip cruise control lever in direction of arrow ①.

Slower

- ▶ Briefly tip cruise control lever in direction of arrow ②.

Setting to last stored speed ("Resume" function)

Warning!



The speed stored in memory should only be set again if prevailing road conditions permit. Possible acceleration or deceleration differences arising from returning to the pre-set speed could cause an accident and/or serious injury to you and others.

- ▶ Briefly push cruise control lever in direction of arrow ④.

The cruise control resumes the last set speed.

- ▶ Remove your foot from the accelerator pedal.

The selected speed appears in the multi-function display for approximately five seconds, and the corresponding speedometer segments from the selected speed to the vehicle maximum speed are illuminated.

Distronic*

When activated, the Distronic adaptive cruise control system increases driving convenience afforded by the cruise control during travel on expressways and other major roads.

- If the Distronic distance sensor detects a slower moving vehicle directly ahead, your vehicle speed will be reduced so that you follow that vehicle at a preset distance.
- If there is no vehicle directly ahead of you, Distronic will function in the same way as cruise control (> page 214).

Warning!



Distronic adaptive cruise control is no substitute for active driving involvement. It does not react to stationary objects, nor does it recognize or predict the curvature and lane layout or the movement of vehicles ahead. Distronic can only apply a maximum of 20% of the vehicle's braking power.

It is the driver's responsibility at all times to be attentive to traffic and road conditions and to provide the steering, braking and other driving inputs necessary to retain control of the vehicle.

Warning!



Distronic is a convenience system. Its speed adjustment reduction capability is intended to make cruise control more effective and usable when traffic speeds vary. However, it is not intended to, nor does it, replace the need for extreme care. The responsibility for the vehicle speed and the distance to the vehicle ahead, including most importantly brake operation to assure safe stopping distance, always rests with the driver.

Distronic cannot take street and traffic conditions into account.

Warning!



Distronic requires familiarity with its operational characteristics. We strongly recommend that you review the following information carefully before operating the system.



USA only:

This device complies with Part 15 of the FCC Rules. Operation is subject to the following two conditions:

- This device may not cause harmful interference, and
- this device must accept any interference received, including interference that may cause undesired operation.

Any unauthorized modification to this device could void the user's authority to operate the equipment.

Controls in detail

Driving systems



Canada only:

This device complies with RSS-210 of Industry Canada. Operation is subject to the following two conditions:

- This device may not cause interference, and
- this device must accept any interference received, including interference that may cause undesired operation of the device.

Any unauthorized modification to this device could void the user's authority to operate the equipment.

Warning!



Distronic cannot take street and traffic conditions into account. Only use Distronic if the weather, road, and traffic conditions make it advisable to travel at a steady speed.

Warning!



Use of Distronic can be dangerous on slippery roads. Rapid changes in tire traction can result in wheel spin and loss of control.

Distronic does not act upon adverse sight distance conditions. Do not use Distronic during conditions of fog and heavy rain, snow or sleet.

Warning!



Close attention to road and traffic conditions is imperative at all times, regardless of whether or not Distronic is activated.

Use of Distronic can be dangerous on winding roads or in heavy traffic because conditions do not allow safe driving at a steady speed.

Distronic will not react to stationary objects in the roadway (e.g. a stopped vehicle in a traffic jam or a disabled vehicle). Distronic will also not respond to oncoming vehicles.

Switch off Distronic:

- when changing from the left to the right lane if vehicles are moving more slowly in the left lane
- when entering a turn lane or highway off ramp
- in complex driving situations, such as in highway construction zones

In these situations, Distronic will continue to maintain the set speed unless deactivated.

Distronic is designed and intended only to maintain a set speed and keep a set distance from moving objects in front of it.

Warning!



The "Resume" function should only be operated if the driver is fully aware of the previously set speed and wishes to resume this particular preset speed.

Distronic displays in the speedometer dial



Set speed

If DISTRONIC is activated, one or two segments come on around the set speed.



The vehicle speed displayed on the speedometer can briefly vary from the speed setting on the DISTRONIC system.



Segments

If DISTRONIC detects a vehicle directly ahead, the segments from the speed of the vehicle ahead to the set speed come on.

If DISTRONIC calculates that there is a danger of collision (▷ page 225):

- The red DISTRONIC warning lamp  in the instrument cluster comes on.
- An intermittent warning sounds.

- ▶ Immediately brake the vehicle to avoid a collision.

Under no circumstances should the driver await the intermittent warning sound before braking. See the following warning note.

The intermittent warning sound ceases and the red DISTRONIC warning lamp  goes out when the necessary distance to the vehicle ahead is again established.

Controls in detail

Driving systems

Warning!



An intermittent warning sounds and the Distronic warning lamp  in the instrument cluster is illuminated if the Distronic system calculates that the distance to the vehicle ahead and your vehicle's current speed indicate that Distronic will not be capable of slowing the vehicle sufficiently to maintain the preset following distance, which creates a danger of a collision.

Immediately brake your vehicle to increase the distance between your vehicle and the vehicle in front of you. The warning sound is intended as a final caution that you have not interceded with your own braking inputs to avoid a potentially dangerous situation. Do not wait for the operation of the warning signal to intercede with your own braking, as that will result in potentially dangerous emergency braking which will not always result in an impact being avoided.

Tailgating increases the risk of an accident.

Warning!



Distronic brakes your vehicle with a maximum of 6.5 ft/s^2 (2 m/s^2). This corresponds to about 20% of the maximum deceleration ability of your vehicle.



Distronic brakes the vehicle in an effort to restore the preset distance or to maintain the speed. The brake pedal is automatically applied as this happens which results in the brake pedal moving.

Keep driver's foot area clear at all times, including the area under the brake pedal. Objects stored in this area may impair pedal movement which could interfere with the braking ability of the Distronic system.

Do not place your foot under the brake pedal – your foot could become caught.

Distronic menu in the control system

In the Distronic menu you see the current settings for Distronic. What appears in the display depends on whether Distronic and the distance warning function are turned on or off.

- ▶ Press button  or  repeatedly until you see one of the following displays.

Controls in detail

Driving systems

Distronic deactivated

If DISTRONIC is deactivated, the standard display of DISTRONIC appears in the multifunction display.

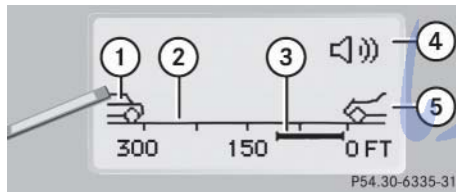

- ① Vehicle ahead, if detected
- ② Actual distance to vehicle ahead
- ③ Preset distance threshold to vehicle ahead
- ④ Symbol for activated distance warning function
- ⑤ Your vehicle

Distronic activated

When you turn DISTRONIC on, you will see the set speed in the multifunction display for about five seconds. You then see the following display in the multifunction display.

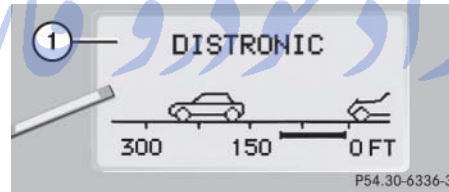

- ① DISTRONIC activated

Cruise control lever

The DISTRONIC system is operated by means of the cruise control lever.

The cruise control lever is the uppermost lever on the left-hand side of the steering column.



- ① Sets current or higher speed
- ② Sets current or lower speed
- ③ Deactivates DISTRONIC
- ④ Resumes at last set speed

Controls in detail

Driving systems

Activating Distronic

You can activate Distronic if:

- you are driving between 25 mph (40 km/h) and 110 mph (180 km/h)
- the ESP is activated (▷ page 82)

If Distronic has not been activated after pressing the cruise control lever you will see the message --- in the multifunction display.

In the following cases you cannot activate Distronic:

- up to two minutes after starting the engine
- when you brake
- if you have set the parking brake
- if the gear selector lever is in position **P**, **R**, or **N**
- if the ESP is switched off

Setting the current speed

- ▶ Accelerate or decelerate to the desired speed.
- ▶ Briefly lift the cruise control lever in direction of arrow ① or depress in direction of arrow ②.

Distronic is activated and the current speed is set.

- ▶ Remove your foot from the accelerator pedal.



If you do not take your foot off of the accelerator completely, the following message will appear in the multifunction display:

DISTRONIC OVERRIDE

Distronic will not work to maintain the distance to a slower moving vehicles in front of you. Your vehicle speed will then be determined only by the accelerator pedal position.

Setting a higher speed

- ▶ Briefly tip the cruise control lever in direction of arrow ① (▷ page 221) to increase vehicle speed in increments of 5 mph (Canada: 10 km/h).

The new speed is set.

The stored speed is displayed in the multifunction display for approximately five seconds (▷ page 221), and one or two segments around the stored speed come on the speedometer (▷ page 219).



Depressing the accelerator pedal does not deactivate Distronic. After brief acceleration (e.g. for passing), the cruise control resumes the last speed set.

Setting a lower speed

- ▶ Briefly tip the cruise control lever in direction of arrow ② (▷ page 221) to decrease vehicle speed in increments of 5 mph (Canada: 10 km/h).

The new speed is set.

The stored speed is displayed in the multifunction display for approximately five seconds (▷ page 221), and one or two segments around the stored speed come on the speedometer (▷ page 219).



When you use the cruise control lever to decelerate, the transmission will automatically downshift if the rate of deceleration is too low.

Fine adjustment in 1 mph (Canada: 1 km/h) increments

Faster

- ▶ Briefly tip the cruise control lever in direction of arrow ④ (▷ page 221).

Setting to last stored speed (“Resume” function)

Warning!



The speed stored in memory should only be set again if prevailing road conditions permit. Possible acceleration or deceleration differences arising from returning to preset speed could cause an accident and/or serious injury you and others.

- ▶ Briefly tip the cruise control lever in direction of arrow ④ (▷ page 221).

Distronic is set to the last stored speed.

- ▶ Remove your foot from the accelerator pedal.

مداد خودرو فارما
تلفن شبانه روزی: ۰۲۱-۸۸۶۲۰۸۵

FarmaSOS.com

Controls in detail

Driving systems

Deactivating DISTRONIC

There are several ways to deactivate the DISTRONIC system:

- ▶ Briefly tip the cruise control lever in direction of arrow ③ (▷ page 221).
- ▶ Step on the brake pedal.

or

DISTRONIC will be deactivated. The last speed set will be stored into memory.



The following message will appear in the multifunction display for approximately five seconds: DISTRONIC OFF.

The last stored speed is deleted when you turn off the engine.

DISTRONIC deactivates automatically when:

- you set the parking brake
- you drive slower than 22 mph (35 km/h)
- the ESP is active (▷ page 82) or you deactivate the ESP
- you move the gear selector lever into position **N**

A signal will sound. The DISTRONIC OFF message appears in the multifunction display for approximately five seconds.

Warning!

DISTRONIC switches off and releases the brakes when the vehicle decelerates below the minimum speed of approximately 22 mph (35 km/h) by operation of the system. At that time the driver must apply the brakes in order to reduce vehicle speed further or bring it to a stop.

Setting the following distance in DISTRONIC

You can set the specified following distance for DISTRONIC by varying the time setting between 1.0 and 2.0 seconds. Using this time setting and the current speed of your vehicle, DISTRONIC calculates and sets the required following distance to the vehicle ahead. The set distance will be shown in the multifunction display field.

Warning!



It is up to the driver to exercise discretion to select the appropriate setting given road conditions, traffic, driver's preferred driving style and applicable laws and driving recommendations for safe following distance.

The distance warning function on/off button and thumbwheel for setting distance are located on the lower part of the front center console.



- ① Distance warning function on/off button
- ② Thumbwheel for setting distance

Increasing distance

Increasing the distance setting causes Distronic to maintain a greater following distance to the vehicle ahead.

- ▶ Turn thumbwheel ② towards

Decreasing distance

Decreasing the distance setting causes Distronic to maintain a shorter following distance to the vehicle ahead.

- ▶ Turn thumbwheel ② towards

Distance warning function

When Distronic is deactivated, this function will continue to warn you when recognizing a stationary obstacle or a slower vehicle moving in the vehicle's path and the danger of a collision exists:

- The distance warning lamp in the instrument cluster comes on.
- An intermittent warning sounds.

If these warnings are issued, you must brake manually to maintain a safe distance and avoid a collision with the vehicle ahead.

When pressing the brake pedal, the warning sound stops. The warning sound also stops when the distance to the vehicle ahead is sufficient again without applying the brake pedal. In this case the distance warning lamp also extinguishes.

Controls in detail

Driving systems

Warning!



If the Distronic warning lamp  in the instrument cluster comes on while driving and/or an intermittent warning sounds, immediate attention on the part of the driver is required. As required by the traffic situation, apply the brakes and navigate around a possible obstacle. However, do not drive by relying on the distance warning function, as this will result in an emergency braking application. Especially depending on road surface conditions and driver reaction, this will not always enable you to avoid a collision.



Complex driving situations are not always fully recognized by Distronic. This could result in wrong or missing distance warnings.

Activating

- ▶ Press button ①.

The indicator lamp on the button comes on. A loudspeaker symbol appears in the multifunction display (▷ page 221).

Deactivating

- ▶ Press button ①.

The indicator lamp on the button goes out.

Driving with Distronic

This section describes a number of driving situations where special precaution is required on the part of the driver. Be prepared to brake in such situations which will deactivate the Distronic system.

Warning!



Distronic works to maintain the speed selected by the driver unless a moving obstacle proceeding directly ahead of it in the same travel direction is detected (e.g. following another vehicle ahead of you at a distance set by Distronic). This means that:

- Your vehicle can pass another vehicle after you change lanes.
- While in a sharp turn or if the vehicle in front is in a sharp turn, Distronic could lose sight of a vehicle traveling in front of it, then your vehicle could accelerate to the previously selected speed.

Controls in detail

Driving systems

Distronic regulates only the distance between your vehicle and those directly ahead of it, but does not register stationary objects in the road, e.g.:

- a stopped vehicle in a traffic jam
- a disabled vehicle
- an oncoming vehicle

The driver must always be on the alert, observe all traffic and intercede as required by steering or braking the vehicle.

Warning!



Distronic should not be used in snowy or icy road conditions.

The most likely cause for a malfunctioning system is a dirty sensor (located behind the hood grille), especially at times of snow and ice or heavy rain. In such a case, Distronic will switch off, and the message **DISTRONIC CURRENTLY UNAVAILABLE SEE OPERATORS MANUAL** appears in the multi-function display.

For cleaning and care of the Distronic sensor, see “Cleaning the Distronic* system sensor cover” (▷ page 333).



If the message **DISTRONIC CURRENTLY UNAVAILABLE SEE OPERATORS MANUAL** disappears during driving and the last speed stored flashes for approximately five seconds, the dirt (e.g. slush) has dissolved; Distronic is again operational.

Turns and bends

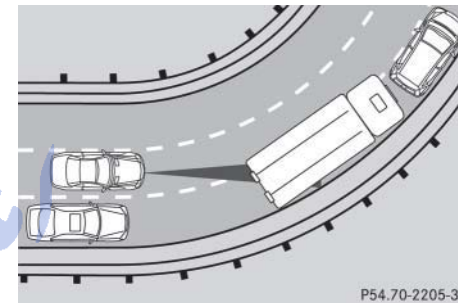

In turns or bends, Distronic may not detect a moving vehicle in front, or it may detect one too soon. This may cause your vehicle to brake late or unexpectedly.

Controls in detail

Driving systems

Offset driving

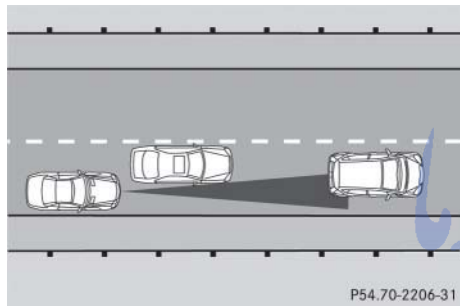

A vehicle traveling in your lane but offset from your direct line of travel may not be detected by Distronic. There will be insufficient distance to the vehicle ahead.

Lane changing

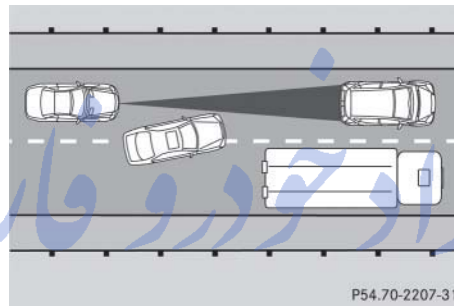

Distronic has not yet detected the vehicle changing lanes. There will be insufficient distance to the lane-changing vehicle.

Narrow vehicles

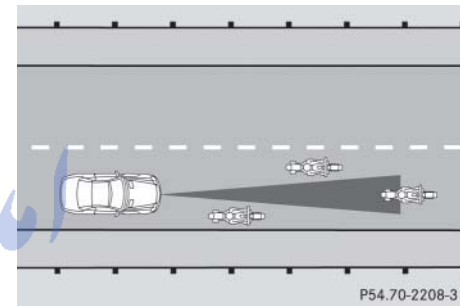

Because of their narrow profile, the vehicles traveling near the outer edge of the lane have not yet been detected by Distronic. There will be insufficient distance to the vehicles ahead.

FarmaSOS.com

Airmatic

Airmatic automatically selects the optimum suspension tuning and ride height for your vehicle. Airmatic consists of two components:

- Adaptive Damping System (ADS)
- Level control system

The ADS automatically selects the optimum damping for the respective driving conditions. At the same time the suspension is set to either sporty or regular.

Suspension tuning

The suspension tuning is set according to:

- Your driving style
- Road surface conditions
- Your choice of suspension style, “sport” or “convenience”, which you select using the damping switch.

The following suspension styles are available:

- Convenience

Both indicator lamps ① are off.

- Sports 1

One indicator lamp ① is on.

- Sports 2

Both indicator lamps ① are on.

Controls in detail

Driving systems



① Indicator lamps

② Damping switch

▶ Start the engine.

▶ Press the damping switch ② until the desired suspension style is set.

i

The selected suspension style is stored in memory, even after the SmartKey is removed from the starter switch.

Controls in detail

Driving systems

Vehicle level control with Airmatic

Your vehicle automatically adjusts its ride height to:

- reduce fuel consumption
- increase vehicle safety

The vehicle chassis ride height is raised or lowered according to the selected level setting and to the vehicle speed:

- With increasing speed, ride height is reduced by up to approximately $\frac{3}{4}$ in (20 mm).
- With decreasing speed, the ride height is again raised to the selected vehicle level.



These height adjustments are so small that you may not notice any change.

The following vehicle level settings can be selected when the vehicle is stationary:

Level	
Normal	For driving on normal roads. The indicator lamp is off.
Raised	For driving on rough roads or with snow chains. The indicator lamp is on.

Select the “Raised” level setting only when required by current driving conditions.

Otherwise:

- Fuel consumption may increase
- Handling may be impaired

Warning!



To help avoid personal injury, keep hands and feet away from wheel housing area, and stay away from under the vehicle when lowering the vehicle chassis.

The switch with the indicator lamps is located on the upper part of the front center console.



- ① Indicator lamp
- ② Vehicle level control switch

- Briefly press switch ② to change from one level setting to the other.

The message:

AIRMATIC
VEHICLE RISING!

appears in the multifunction display when changing from normal level to raised level.

Controls in detail

Driving systems

The indicator lamp is then lit. The display switches off when the vehicle is raised.

- ▶ Press switch ② again to lower the vehicle. The indicator lamp is off.

The selected vehicle level setting remains stored in memory even if the engine is turned off and restarted except when you

- exceed a speed of 75 mph (120 km/h) or
- maintain a speed of between 50 mph (80 km/h) and 75 mph (120 km/h) for more than 5 minutes

The vehicle then lowers to regular level.

The message:

AIRMATIC
LEVELING CANCELLED

appears in the multifunction display and the indicator lamp is off. The display switches off when the vehicle is raised.

Active Body Control (ABC)*

The ABC system automatically selects the optimum suspension tuning and ride height for your vehicle.

Suspension tuning

The suspension tuning is set according to:

- Your driving style
- Road surface conditions
- The vehicle loading
- Your choice of suspension style, “sporty” or “regular”, which you select using the ABC button

The selected suspension style is stored in memory, even after the SmartKey is removed from the starter switch.

The ABC button with the indicator lamps is located on the upper part of the front center console.



- ① Indicator lamp
- ② ABC button

- ▶ Start the engine.

Controls in detail

Driving systems

Suspension for sporty driving style

The setting for sporty driving is selected when indicator lamp ① is illuminated.

- ▶ Press button ②.

Indicator lamp ① comes on.

Suspension for regular driving style

The setting for regular driving is selected when indicator lamp ① is off.

- ▶ Press button ②.

Indicator lamp ① goes out.

Vehicle level control with ABC*

Your vehicle automatically adjusts its ride height to:

- reduce fuel consumption
- increase vehicle safety

The vehicle chassis ride height is raised or lowered according to the selected level setting and to the vehicle speed:

- With increasing speed, ride height is reduced by up to approximately 1.4 in (35 mm).
- With decreasing speed, the ride height is again raised to the selected vehicle level.



These height adjustments are so small that you may not notice any change.

Select the level 1 and 2 settings only when required by current driving conditions.

Otherwise:

- Fuel consumption may increase
- Handling may be impaired

Warning!



To help avoid personal injury, keep hands and feet away from wheel housing area, and stay away from under the vehicle when lowering the vehicle chassis.

The following vehicle level settings can be selected when the vehicle is stationary:

Vehicle level when stationary	Use for	Ride height increase over normal	Automatic lowering	Indicator lamps
Normal	Normal operation	None	Max. approx. 0.6 in (15 mm)	Both lamps off
Raised level 1	Driving with snow chains (▷ page 327)	Max. 0.4 in (10 mm) ¹	Max. approx. 1.0 in (25 mm)	One lamp lit
Raised level 2	Very rough road surface conditions	Max. 0.8 in (20 mm) ¹	Max. approx. 1.4 in (35 mm)	Both lamps lit

¹ Dependent on load

The button with the indicator lamps is located on the upper part of the front center console.



- ① Indicator lamps
- ② Vehicle level control button

► Briefly press button ② to change from one level setting to the next. When vehicle is at level 2, pressing the button will return the vehicle to normal level.

The message:

ACTIVE BODY CONTROL
VEHICLE RISING!

appears in the multifunction display. The display switches off when the vehicle is raised.

Controls in detail

Driving systems



Pressing the button twice in quick succession will cause the vehicle to immediately raise or lower according to the starting level.

The selected vehicle level setting remains stored in memory even if the engine is turned off and restarted.

Normal level (see table)

Speed-dependent lowering of vehicle chassis (approximate values):

- Between 0 mph (0 km/h) and 40 mph (65 km/h) – none
- Between 40 mph (65 km/h) and 87 mph (140 km/h) – lowered progressively by approximately 0.6 in (15 mm).

Raised level 1 (see table)

Speed-dependent lowering of vehicle chassis (approximate values):

- Between 0 mph (0 km/h) and 38 mph (60 km/h) – raised by approximately 0.4 in (10 mm)
- Between 38 mph (60 km/h) and 118 mph (190 km/h) – lowered progressively by approximately 1.0 in (25 mm)

Raised level 2 (see table)

Speed-dependent lowering of vehicle chassis (approximate values):

- Between 0 mph (0 km/h) and 18 mph (30 km/h) – raised by approximately 0.8 in (20 mm)
- Between 18 mph (30 km/h) and 38 mph (60 km/h) – lowered progressively by approximately 0.4 in (10 mm)
- Between 38 mph (60 km/h) and 118 mph (190 km/h) – lowered progressively by additional approximately 1.0 in (25 mm)

Parktronic system* (Parking assist)

Warning!



Parktronic is a supplemental system. It is not intended to, nor does it replace, the need for extreme care. The responsibility during parking and other critical maneuvers always rests with the driver.

Special attention must be paid to objects with smooth surfaces or low silhouettes (e.g. trailer couplings, painted posts, or road curbs). Such objects may not be detected by the system and can damage the vehicle.

The operational function of the Parktronic system can be affected by dirty sensors, especially at times of snow and ice, see "Cleaning the Parktronic* system sensors" (> page 333).

Interference caused by other ultrasonic signals (e.g. working jackhammers, car wash, or the air brakes of trucks) can cause the system to send erratic indications, and should be taken into consideration.

Warning!



Make sure no persons or animals are in the area in which you are maneuvering. You could otherwise injure them.

The Parktronic system is an electronic aid designed to assist the driver during parking maneuvers. It visually and audibly indicates the relative distance between the vehicle and an obstacle.

The Parktronic system is automatically activated when you switch on the ignition and placed the gear selector lever in position **D**, **R**, or **N**.

The Parktronic system deactivates at speeds over approximately 11 mph (18 km/h). At lower speeds the Parktronic system turns on again.

The Parktronic system also deactivates when you place the gear selector lever in position **P**.

The Parktronic system monitors the surroundings of your vehicle with six sensors in the front bumper and four sensors in the rear bumper.

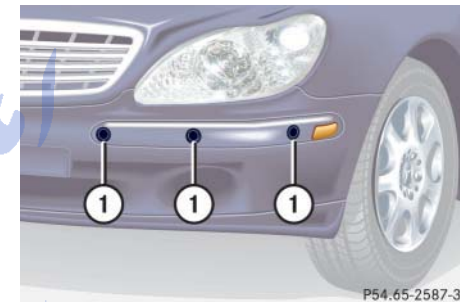

P54.65-2587-31

① Sensors in the front bumper

Controls in detail

Driving systems

Range of the sensors

To function properly, the sensors must be free of dirt, ice, snow and slush. Clean the sensors regularly, being careful not to scratch or damage the sensors see “Cleaning the Parktronic* system sensors” (▷ page 333).

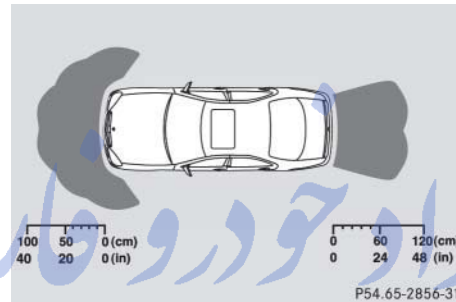
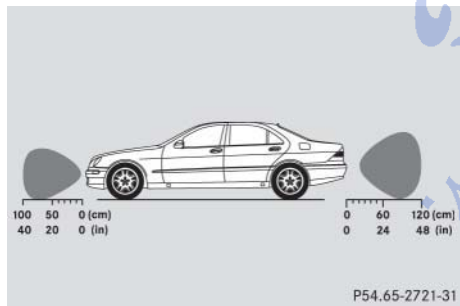

Front sensors

Center	approx. 40 in (100 cm)
Corners	approx. 24 in (60 cm)

Rear sensors

Center	approx. 48 in (120 cm)
Corners	approx. 32 in (80 cm)



During parking maneuvers, pay special attention to objects located above or below the height of the sensors (e.g. planters or trailer hitches). The Parktronic system will not detect such objects at close range and damage to your vehicle or the object may result.

Ultrasonic signals from outside sources (e.g. truck air brakes, car wash, or jackhammers) may impair the operation of the Parktronic system.

Controls in detail

Driving systems

Minimum distance

Center	approx. 8 in (20 cm)
Corners	approx. 6 in (15 cm)

If the system detects an obstacle in this range, all the distance warning segments illuminate and you hear a warning signal. If the obstacle is closer than the minimum distance, the actual distance may no longer be indicated by the system.

Warning indicators

Visual signals indicate to the driver the relative distance between the sensors and an obstacle. The warning indicators for the front area are located above the left air vents and center air vents in the dashboard. The warning indicator for the rear area is integrated in the rear trim.

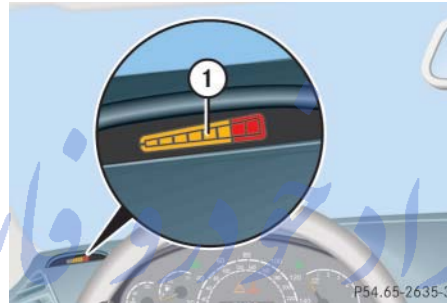

① Left side of the vehicle

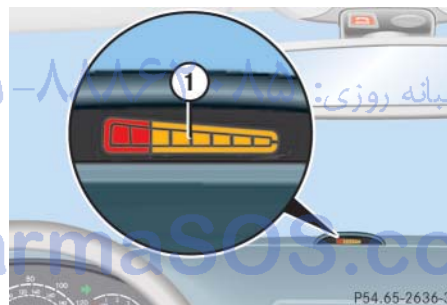

① Right side of the vehicle

Each warning indicator is divided into six yellow and two red distance segments for either side of the vehicle. The Parktronic system is ready when the border around the indicator is illuminated.

The position of the gear selector lever determines which warning indicators will be activated.

Gear selector lever position	Warning indicator
D	Front area activated
R or N	Front and rear area activated
P	Neither activated

Controls in detail

Driving systems

As your vehicle approaches an object, one or more distance segments will illuminate, depending on the distance. When the eighth distance segment illuminates, you have reached the minimum distance.

- Front area: An intermittent acoustic warning will sound as the first red distance segment illuminates and a constant acoustic warning lasting a maximum of two seconds will sound for the second red distance segment. The signal is canceled when the gear selector lever is placed in position **P**.
- Rear area: An intermittent acoustic warning will sound as the first red distance segment illuminates and a constant acoustic warning lasting a maximum of two seconds will sound for the second red distance segment. The signal is canceled when the gear selector lever is placed in position **D** or **P**.

Switching the Parktronic system on/off

The Parktronic system can be switched off manually.

The Parktronic button is located in the upper part of the front center console.



- ① Indicator lamp
- ② Parktronic button

Switching off the Parktronic system

- ▶ Press button ②.
- Indicator lamp ① comes on.

Switching on the Parktronic system

- ▶ Press button ② again.
- Indicator lamp ① goes out.



The Parktronic system is automatically switched on when the ignition is switched on (▷ page 34).

Parktronic system malfunction

If only the red distance segments illuminate and an acoustic warning sounds, there is a malfunction in the Parktronic system. The Parktronic system will automatically switch off after 20 seconds and the indicator lamp in the Parktronic switch comes on.

- ▶ Have the Parktronic system checked by an authorized Mercedes-Benz Center as soon as possible.

If only the red distance segments illuminate and no acoustic warning sounds, the Parktronic system sensors are dirty or there is an interference from other radio or ultrasonic signals. The Parktronic system will automatically switch off after 20 seconds and the indicator lamp in the Parktronic switch comes on.

- ▶ Switch off ignition (▷ page 34).
- ▶ Clean Parktronic system sensors (▷ page 333).
- ▶ Switch on ignition.
- ▶ Check Parktronic system operation at another location to rule out interference from outside radio or ultrasonic signals.

تلفن شبانه روزی: ۰۲۱ ۸۸۶۲۰۸۵ or

FarmaSOS.com

Controls in detail

Loading

Roof rack*

Warning!



Use only roof racks approved by Mercedes-Benz for your vehicle model to avoid damage to the vehicle. Follow manufacturer's installation instructions.



Preparing roof rack installation

- ▶ Open trim at the trim strips in the roof.
- ▶ Secure the roof rack according to manufacturer's instructions for installation.



Load the roof rack in such a way that the vehicle cannot be damaged while driving.

Make sure

- you can fully raise the tilt/sliding sunroof
- you can fully open the trunk

تلفن شبانه روزی: ۰۲۱-۸۸۶۲۰۸۵

FarmaSOS.com

Loading instructions

The total load weight including vehicle occupants and luggage/cargo should not exceed the load limit or vehicle capacity weight as indicated on the corresponding placard located on the driver's door B-pillar.

Warning!



Always fasten items being carried as securely as possible.

In an accident, during hard braking or sudden maneuvers, loose items will be thrown around inside the vehicle and can cause injury to vehicle occupants unless the items are securely fastened in the vehicle.

To help avoid personal injury during a collision or sudden maneuver, exercise care when transporting cargo. Put luggage or cargo in the trunk if possible. Do not pile luggage or cargo higher than the seat backs. Do not place anything on the rear-window shelf.

Never drive vehicle with trunk open. Deadly carbon monoxide (CO) gases may enter vehicle interior resulting in unconsciousness and death.

Cargo tie-down hooks



Six hooks are located in the trunk.

- ▶ Carefully secure cargo by applying even load on all hooks with rope of sufficient strength to hold down the cargo.

Controls in detail

Useful features

Vanity mirrors

Vanity mirror in the sun visor

Warning!



Do not use the vanity mirror while driving.

Keep the mirrors in the sun visors closed while vehicle is in motion. Reflected glare can endanger you and others.

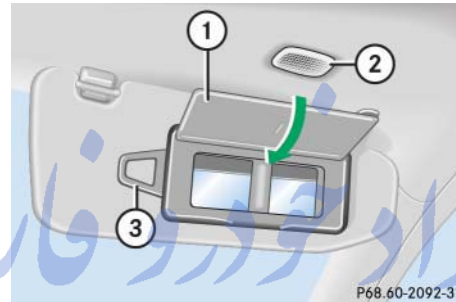

- ① Mirror lamp
- ② Mirror cover
- ③ Document holder

▶ To use mirror, lift up cover ①.
Mirror lamp ② comes on.



If you disengage the sun visor from mounting, mirror lamp ② will switch off (▷ page 190).

Adjusting the vanity mirror

▶ Slide the mirror to the left or to the right.

Images in the mirror appear in normal size or larger, depending on the position of the mirror.

Document holder

You can use the plastic tab of the document holder ③ to hold admission tickets, parking passes, or similar items in place.

Controls in detail

Useful features

Vanity mirror in the rear

The vanity mirrors are located in the roof lining for the rear seat passengers.



Opening the vanity mirror

- ▶ Press the cover of the vanity mirror.
The vanity mirror folds down and the mirror lamp comes on.

Closing the vanity mirror

- ▶ Push the vanity mirror up until it engages in place.



Before tilting a front seat backrest from the reclined position to an upright position, close the respective vanity mirror in the rear. Otherwise the vanity mirror may get damaged.

Storage compartments

Warning!



To help avoid personal injury during a collision or sudden maneuver, exercise care when stowing objects in the vehicle. Put luggage or cargo in the trunk if possible. Do not pile luggage or cargo higher than the seat backs.

Luggage nets cannot secure hard or heavy objects.

Keep compartment lids closed. This will help to prevent stored objects from being thrown about and injuring vehicle occupants during an accident.

Controls in detail

Useful features

Glove box

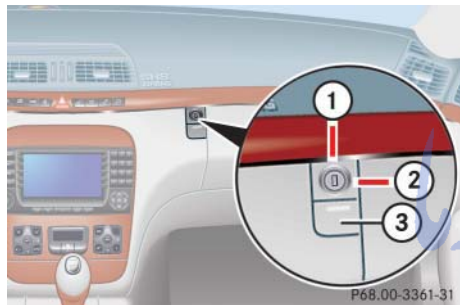

- ① Unlocked
- ② Locked
- ③ Glove box lid release

Locking the glove box

- ▶ Insert mechanical key (▷ page 383) into the glove box lock.
- ▶ Turn the mechanical key to position ②.

Unlocking the glove box

- ▶ Insert mechanical key (▷ page 383) into the glove box lock.
- ▶ Turn the mechanical key to position ①.

Opening the glove box

- ▶ Press glove box lid release ③.
- The glove box lid opens downward.

Closing the glove box

- ▶ Push lid up to close.

Storage compartment in the glove box

A storage compartment is located in the cover of the glove box. It can be used to store check cards, pens, a flashlight, etc.



- ① Storage compartment in glove box
 - ▶ Lightly press the marking on the lid of storage compartment ①.
- The lid opens upward.

Storage compartment in the center console

The storage compartment is located on the lower part of the front center console.



① Storage compartment

Opening

- ▶ Slide the mark on the compartment cover forward.

Closing

- ▶ Lightly press the mark on the compartment cover forward. The cover closes automatically.

Storage compartment in front of armrest

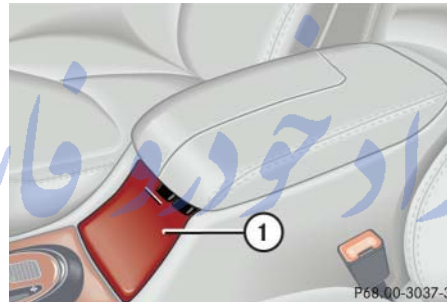

① Storage compartment

Opening

The compartment contains a cup holder (▷ page 248).

- ▶ Lightly touch cover plate ①. The cover opens automatically.

Closing

- ▶ Lightly push cover plate ① up until it engages.

Storage compartment below the front armrest

Depending on vehicle model and configuration, your vehicle is equipped with a storage compartment below the front armrest.

The storage compartment below the front armrest is illuminated with the exterior lamps switched on.

The buttons are located under the cushion of the armrest.

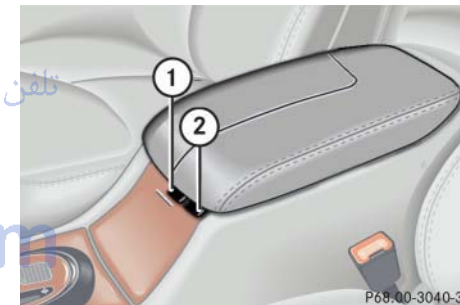

① Button to open storage compartment

② Button to open storage tray

Controls in detail

Useful features

Opening storage compartment

- ▶ Press button ① and lift the armrest lid.



The storage compartment can be heated or cooled.

The compartment can get very warm due to its confined space. When storing heat-sensitive objects in the compartment, close the air vent (> page 204) while heating the passenger compartment.



Do not obstruct the air vent in the storage compartment.

Opening storage tray

The tray contains a coin holder.

- ▶ Press button ② and lift the armrest.



Do not store any objects under the storage tray.

Do not let bank cards, credit cards, or other cards with a magnetic strip come near the storage tray, as a magnet built into the tray could erase or change the information on the card.

Compartment for glasses

The compartment for glasses is located under the armrest in the center console.

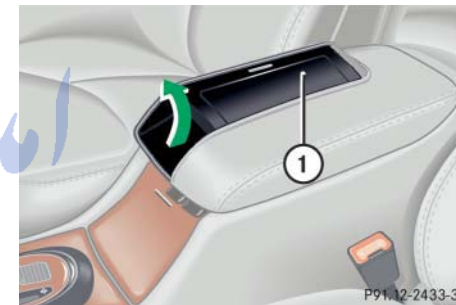

① Compartment for glasses

Opening compartment for glasses

- ▶ Fold the right side of the armrest upwards.

Telephone holder*

The telephone holder is located under the armrest in the center console.



① Telephone holder

Opening telephone holder

- ▶ Fold the right side of the armrest upwards.

Storage compartments in the rear passenger compartment

Armrest with integrated storage compartment

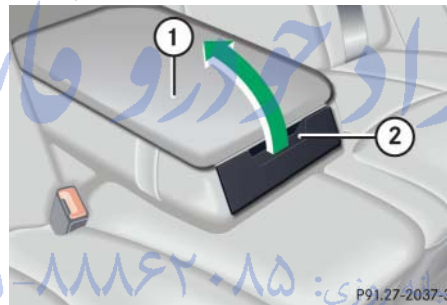

- ① Rear armrest
- ② Lid handle

Opening the storage compartment:

- ▶ Pull down the armrest by its strap.
- ▶ Press handle ② and lift lid.



Before storing the armrest in the backrest, close the storage compartment lid.

Storage compartment between rear seats*

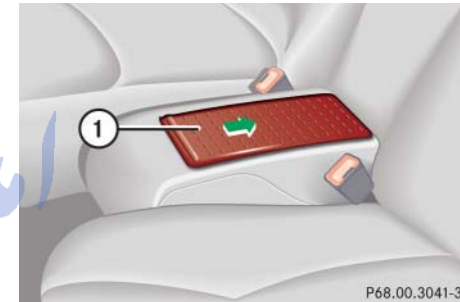

① Cover

Opening

- ▶ Slide cover ① rearward.

Closing

- ▶ Slide cover ① forward.

Controls in detail

Useful features

Storage compartment in rear shelf*

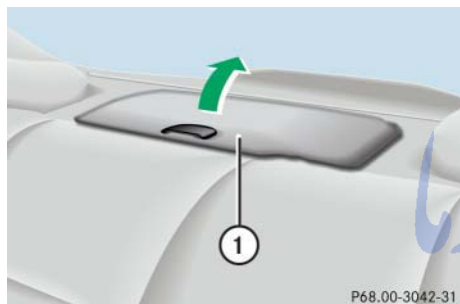

① Rear shelf compartment

Opening

- ▶ Lift the lid using the handle in the front.

Storage compartments under the front seats

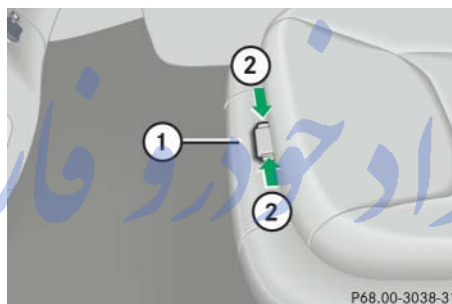

① Lid
② Buttons

Opening

- ▶ Press buttons ② together and fold lid ① down.

Closing

- ▶ Close lid ① until both buttons ② of lock engage.

Cup holder in front of seat armrest

Warning!



In order to help prevent spilling liquids on vehicle occupants, only use containers that fit into the cup holder. Use lids on open containers and do not fill containers to a height where the contents, especially hot liquids, could spill during braking, vehicle maneuvers, or in an accident.

When not in use, keep the cup holder closed. An open cup holder may cause injury to you or others when contacted during braking, vehicle maneuvers, or in an accident.

Keep in mind that objects placed in the cup holder may come loose during braking, vehicle maneuvers, or in an accident and be thrown around in the vehicle interior. Objects thrown around in the vehicle interior may cause an accident and/or serious personal injury.



Only place containers with a maximum diameter of 2 ¾ in (72 mm) in the cup holder. Larger containers could damage the holder arm.

Folding out cup holder

The cup holder is located in the storage compartment in front of the armrest.



- ① Button for folding out the cup holder
- ▶ Open the storage compartment in front of armrest (▷ page 245).
- ▶ Push button ①.
The cup holder opens automatically.

Folding in cup holder

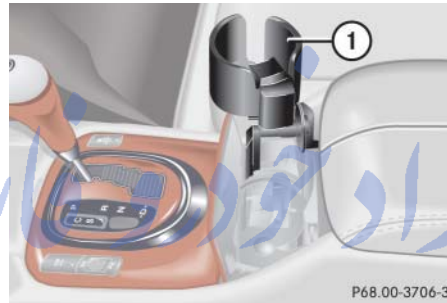

- ① Cup holder
- ▶ Swing cup holder ① back and press it into the storage compartment until it engages.

Cup holder in rear seat armrest

Warning!



In order to help prevent spilling liquids on vehicle occupants, only use containers that fit into the cup holder. Use lids on open containers and do not fill containers to a height where the contents, especially hot liquids, could spill during braking, vehicle maneuvers, or in an accident.

When not in use, keep the cup holder closed. An open cup holder may cause injury to you or others when contacted during braking, vehicle maneuvers, or in an accident.

Keep in mind that objects placed in the cup holder may come loose during braking, vehicle maneuvers, or in an accident and be thrown around in the vehicle interior. Objects thrown around in the vehicle interior may cause an accident and/or serious personal injury.

Controls in detail

Useful features

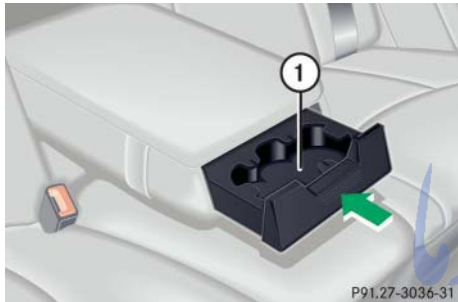

① Compartment for cup holder

Opening cup holder

- ▶ Push front of sliding compartment ①.
The cup holder slides out.

Closing cup holder

- ▶ Push sliding compartment ① back until it engages.

Parcel net in front passenger footwell

A small convenience parcel net is located in the front passenger footwell. It is for small and light items, such as road maps, mail, etc.

Warning!



Do not place heavy or fragile objects, or objects having sharp edges, in the parcel net.

In an accident, during hard braking, or sudden maneuvers they could be thrown around inside the vehicle and cause injury to vehicle occupants.

Parcel net in trunk

You can hang a parcel net in the trunk. The hooks and the parcel net in the trunk can hold a load of up to 29.8 lbs (13.5 kg).

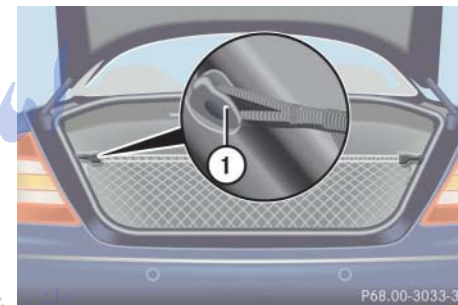

① Hook

- ▶ Hang the parcel net on hooks ① on the left and right sides of the trunk.



The parcel net cannot protect or sufficiently secure goods in the event of an accident.

Ashtrays

Center console ashtray

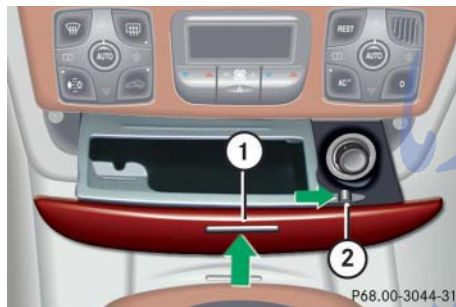

- ① Cover plate
- ② Button for disengaging ashtray

Opening ashtray

- ▶ Briefly touch cover plate ①.
The ashtray opens automatically.

Removing ashtray insert

Warning!



Remove front ashtray only with vehicle standing still. Set the parking brake to secure vehicle from movement. Move gear selector lever to position **N**. With gear selector lever in position **N** turn off the engine.

- ▶ Secure vehicle from movement by setting the parking brake. Move the gear selector lever to position **N**.
Now you have more room to take out the insert.

- ▶ Push sliding button ② to the right.
The ashtray is disengaged and slides out a short way.

- ▶ Remove insert from ashtray frame.

Reinstalling the ashtray insert

- ▶ Install insert by pushing it back into the frame until it engages.

Rear door ashtray

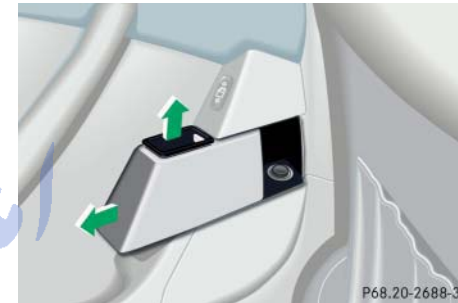

Opening ashtray

- ▶ Lightly touch the back of the ashtray.

Removing ashtray insert

- ▶ Pull the ashtray back slightly and remove the insert (see arrows).

Reinstalling the ashtray insert

- ▶ Position the insert and press down while sliding forward.

Controls in detail

Useful features

Cigarette lighters



① Center console cigarette lighter

- ▶ Make sure the ignition is switched on.
All the lamps in the instrument cluster should come on.
- ▶ Push in cigarette lighter ①.
The lighter will pop out automatically when hot.

Warning!



Never touch the heating element or sides of the lighter; they are extremely hot. Hold the knob only.

When leaving the vehicle, always remove the SmartKey or SmartKey with KEYLESS-GO* from the starter switch, take it with you, and lock the vehicle. Do not leave children unattended in the vehicle, or with access to an unlocked vehicle. Unsupervised use of vehicle equipment may cause an accident and/or serious personal injury.



The lighter socket can be used to accommodate electrical accessories up to a maximum 85 W.

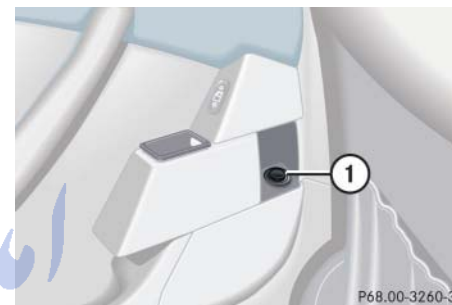

① Rear door lighters

- ▶ Make sure the ignition is switched on.
All the lamps in the instrument cluster should come on.
- ▶ Lightly touch the back of the ashtray to open it (▷ page 251).
- ▶ Push in cigarette lighter ①.
The lighter will pop out automatically when hot.



Operation of the rear door lighters is only possible, if the override switch (▷ page 78) is deactivated.

Warning!



Never touch the heating element or sides of the lighter; they are extremely hot. Hold the knob only.

To avoid possible injury to children sitting in the rear seat, deactivate the operation of the rear door windows, see (▷ page 78). Deactivation of the rear windows also deactivates the lighters.

When leaving the vehicle, always remove the SmartKey or SmartKey with KEYLESS-GO* from the starter switch, take it with you, and lock the vehicle. Do not leave children unattended in the vehicle, or with access to an unlocked vehicle. Unsupervised use of vehicle equipment may cause an accident and/or serious personal injury.

Heated steering wheel*

The steering wheel heating warms up the leather area of the steering wheel.

The stalk with the heated steering wheel switch is on the lower left-hand side of the steering wheel.

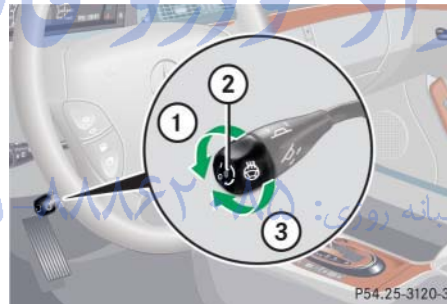

- ① Switching on
- ② Indicator lamp
- ③ Switching off

Switching on

- ▶ Switch on ignition (▷ page 34).

All the lamps in the instrument cluster should come on.

- ▶ Turn switch at the tip of stalk in the direction of arrow ①.

The steering wheel is heated. Indicator lamp ② comes on.

Switching off

- ▶ Turn switch at the tip of stalk in direction of arrow ③.

The steering wheel heating is turned off. Indicator lamp ② goes out.



The steering wheel heating does not turn off automatically.

Controls in detail

Useful features

Telephone*

Warning!



Never operate radio transmitters equipped with a built-in or attached antenna (i.e. without being connected to an external antenna) from inside the vehicle while the engine is running. Doing so could lead to a malfunction of the vehicle's electronic system, possibly resulting in an accident and/or serious personal injury.

Radio transmitters, such as a portable telephone or a citizens band unit, should only be used inside the vehicle if they are connected to an antenna that is installed on the outside of the vehicle.

The external antenna must be approved by Mercedes-Benz. Please contact an authorized Mercedes-Benz Center for information on the installation of an approved external antenna. Refer to the radio transmitter operation instructions regarding use of an external antenna.

Warning!





Please do not forget that your primary responsibility is to drive the vehicle. A driver's attention to the road must always be his/her primary focus when driving. For your safety and the safety of others, we recommend that you pull over to a safe location and stop before placing or taking a telephone call.

If you choose to use the telephone¹ while driving, please use the hands-free device and only use the telephone when road, weather and traffic conditions permit. Some jurisdictions prohibit the driver from using a cellular telephone while driving a vehicle.

Only operate the COMAND (Cockpit Management and Data System)¹ if road, weather and traffic conditions permit.

Bear in mind that at a speed of just 30 mph (approximately 50 km/h), your vehicle is covering a distance of 44 feet (approximately 14 m) every second.

¹ Observe all legal requirements.

You can take and place telephone calls using the  and  buttons on the steering wheel. To carry out other telephone functions, use the control system (▷ page 143).

See separate operating manual for instructions on how to use the telephone.

Tele Aid



The initial activation of the Tele Aid system may only be performed by completing the subscriber agreement and placing an acquaintance call using the Information button . Failure to complete either of these steps will result in a system that is not activated.

If you have any questions regarding activation, please call the Response Center at 1-800-756-9018 (in the USA) or 1-888-923-8367 (in Canada).

The Tele Aid system

(Telematic Alarm Identification on Demand)

The Tele Aid system consists of three types of response:

- automatic and manual emergency
- roadside assistance, and
- information

The Tele Aid system is operational providing that the vehicle's battery is charged, properly connected, not damaged and cellular and GPS coverage is available.

The speaker volume of a Tele Aid call can be adjusted when using the volume control on the multifunction steering wheel. To raise, press button and to lower, press button or use the volume knob on your COMAND headunit.

- ▶ To activate, press the SOS button, the Roadside Assistance button or the Information button , depending on the type of response required.



The SOS button is located above the interior rear view mirror.

The Roadside Assistance button and the Information button are located below the center armrest cover.

Shortly after the completion of your Tele Aid acquaintance call, you will receive a user ID and password. By visiting www.mbusa.com and selecting "Tele Aid" (USA only), you will have access to account information, remote door unlock and more.





The Tele Aid system utilizes the cellular network for communication and the GPS (Global Positioning System) satellites for vehicle location. If either of these signals are unavailable, the Tele Aid system may not function and if this occurs, assistance must be summoned by other means.

Controls in detail

Useful features

System self-check

Initially, after switching on ignition, malfunctions are detected and indicated (the indicator lamps in the SOS button, the indicator lamps in the SOS button, the Roadside Assistance button  and the Information button  stay on longer than ten seconds or do not come on). The message

TELE AID MALFUNCTION
DRIVE TO WORKSHOP!

appears for approximately ten seconds in the multifunction display.



The Tele Aid system utilizes the cellular network for communication and the GPS (Global Positioning System) satellites for vehicle location. If either of these signals are unavailable, the Tele Aid system may not function and if this occurs, assistance must be summoned by other means.

Warning!



If the indicator lamps in the SOS button, in the Roadside Assistance button and/or in the Information button do not come on during the system self-check, or if any of these indicators remain illuminated continuously in red and/or the message

TELE AID MALFUNCTION
DRIVE TO WORKSHOP!

is displayed in the multifunction display after the system self-check, a malfunction in the system has been detected.

If a malfunction is indicated as outlined above, the system may not operate as expected. Have the system checked at the nearest Mercedes-Benz Center as soon as possible.

Emergency calls

An emergency call is initiated automatically following an accident in which the emergency tensioning devices (ETDs) or air bags deploy.

An emergency call can also be initiated manually by opening the cover next to the interior rear view mirror labeled SOS, then briefly pressing the button located under the cover. See (▷ page 257) for instructions on initiating an emergency call manually.

Once the emergency call is in progress, the indicator lamp in the SOS button will begin to flash. The message **CONNECTING CALL** appears in the multifunction display and the audio system is muted. When the connection is established, the message **CALL CONNECTED** appears in the multifunction display. All information relevant to the emergency, such as the location of the vehicle (determined by the GPS satellite location system), vehicle model, identification number and color are generated.

Controls in detail

Useful features

A voice connection between the Response Center and the occupants of the vehicle will be established automatically soon after the emergency call has been initiated. The Response Center will attempt to determine more precisely the nature of the accident provided they can speak to an occupant of the vehicle.

The Tele Aid system is available if

- it has been activated and is operational. Activation requires a subscription for monitoring services, connection, and cellular air time
- the relevant cellular phone network and GPS signals are available and pass the information on to the Response Center



Location of the vehicle on a map is only possible if the vehicle is able to receive signals from the GPS satellite network and pass the information on to the Response Center.

Warning!



If the indicator lamp in the SOS button is flashing continuously and there was no voice connection to the Response Center established, then the Tele Aid system could not initiate an emergency call (e.g. the relevant cellular phone network is not available). The message **CALL FAILED** appears in the multifunction display for approximately ten seconds.

Should this occur, assistance must be summoned by other means.

Initiating an emergency call manually

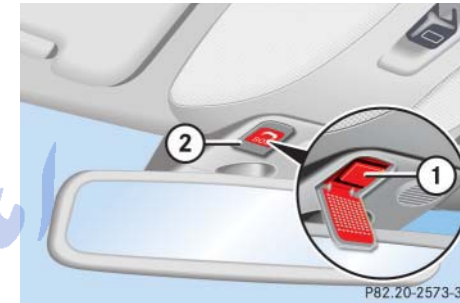

① SOS button

② Cover

► Briefly press on the cover ②.

The cover will open.

► Press SOS button ① briefly.

The indicator lamp in SOS button ① will flash until the emergency call is concluded.



Controls in detail

Useful features



- ▷▷ Wait for a voice connection to the Response Center.
- ▶ Close cover ② after the emergency call is concluded.

Warning!





If you feel at any way in jeopardy when in the vehicle (e.g. smoke or fire in the vehicle, vehicle in a dangerous road location), please do not wait for voice contact after you have pressed the emergency button. Carefully leave the vehicle and move to a safe location. The Response Center will automatically contact local emergency officials with the vehicle's approximate location if they receive an automatic SOS signal and cannot make voice contact with the vehicle occupants.

Roadside Assistance button and Information button

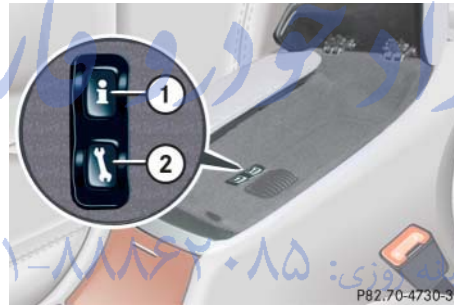
The Roadside Assistance button  and the Information button  are located below the center armrest cover.



- ① Information button 
- ② Roadside Assistance button 

Roadside Assistance button

- ▶ Press and hold the button  (for longer than two seconds).

A call to a Mercedes-Benz Roadside Assistance dispatcher will be initiated. The button will flash while the call is in progress. The message **CONNECTING CALL** will appear in the multifunction display and the audio system is muted.

When the connection is established, the message **CALL CONNECTED** appears in the multifunction display. The Tele Aid system will transmit data generating the vehicle identification number, model, color and location (subject to availability of cellular and GPS signals).

Controls in detail

Useful features



A voice connection between the Roadside Assistance dispatcher and the occupants of the vehicle will be established.

- Describe the nature of the need for assistance.

The Mercedes-Benz Roadside Assistance dispatcher will either dispatch a qualified Mercedes-Benz technician or arrange to tow your vehicle to the nearest authorized Mercedes-Benz Center. For services such as labor and/or towing, charges may apply. Refer to the Roadside Assistance Manual for more information.

Sign and Drive services (only available in the USA): Services such as jump start, a few gallons of fuel or the replacement of a flat tire with the vehicle spare tire are obtainable.



The indicator lamp in the Roadside Assistance button  remains illuminated in red for approximately ten seconds during the system self-check after switching on ignition (together with the SOS button and the Information button ).

See system self-check (> page 256) when the indicator lamp does not come on in red or stays on longer than approximately ten seconds.

If the indicator lamp in the Roadside Assistance button  is flashing continuously and no voice connection to the Response Center was established, the Tele Aid system could not initiate a Roadside Assistance call (e.g. the relevant cellular phone network is not available). The message CALL FAILED appears in the multifunction display.

Roadside Assistance calls can be terminated using the  button on the multifunction steering wheel or the respective button for ending a telephone call on the COMAND headunit.

Controls in detail

Useful features

Information button

The Information button  is located below the center armrest cover.

- ▶ Press and hold the button  (for longer than two seconds).

A call to the Customer Assistance Center will be initiated. The button will flash while the call is in progress. The message `INFO - CONNECTING CALL` will appear in the multifunction display.



When the connection is established, the message `INFO - CALL CONNECTED` appears in the multifunction display. The Tele Aid system will transmit data generating the vehicle identification number, model, color and location (subject to availability of cellular and GPS signals).

A voice connection between the Customer Assistance Center representative and the occupants of the vehicle will be established. When a voice connection is established, the audio system mutes and the message `TELE AID - INFO CALL ACTIVE` appears in the multifunction display.

Information regarding the operation of your vehicle, the nearest authorized Mercedes-Benz Center or Mercedes-Benz USA products and services is available to you.

For more details concerning the Tele Aid system, please visit www.mbusa.com and use your ID and password (sent to you separately) to learn more (USA only).



The indicator lamp on the Information button  remains illuminated in red for approximately ten seconds during the system self-check after switching on ignition (together with the SOS button and the Roadside Assistance button .

See System self-check (▷ page 256) when the indicator lamp does not come on in red or stays on longer than approximately ten seconds.

If the indicator lamp in the Information button  is illuminated continuously and no voice connection to the Response Center was established, then the Tele Aid system could not initiate an Information call (e.g. the relevant cellular phone network is not available). The message `INFO - CALL FAILED` appears in the multifunction display.

Controls in detail

Useful features

Information calls can be terminated using the  button on the multifunction steering wheel or the respective button for ending a telephone call on the COMAND headunit.



If the indicator lamps do not start flashing after pressing one of the buttons or remain illuminated (in red) at any time, the Tele Aid system has detected a fault or the service is not currently active, and may not initiate a call. Visit an Mercedes-Benz Center and have the system checked or contact the Response Center at 1-800-756-9018 (in the USA) or 1-888-923-8367 (in Canada) as soon as possible.

Upgrade scenario

An emergency call is possible even if other services are active.



If the indicator lamp continues to flash or the system does not reset, contact the Response Center at 1-800-756-9018 (in the USA) or 1-888-923-8367 (in Canada), or Mercedes-Benz Customer Assistance at 1-800-FOR-MERCEdes (1-800-367-6372) in the USA or Customer Service at 1-800-387-0100 in Canada.



The indicator lamp in the respective button flashes until the call is concluded. Calls can only be terminated by a Response Center or Customer Assistance Center representative except Roadside Assistance and Information calls, which can also be terminated by pressing button  on the multifunction steering wheel or the respective button for ending a telephone call on the COMAND headunit.

FarmaSOS.com

Controls in detail

Useful features



When a Tele Aid call has been initiated, the audio system or the COMAND* system audio is muted and the selected mode (radio or CD) pauses. The optional cellular phone (if installed) switches off. If you must use this phone, the vehicle must be parked. Disconnect the coiled cord and place the call. The COMAND* navigation system (if engaged) will continue to run. The display in the instrument cluster is available for use, and spoken commands are only available by pressing the RPT button on the COMAND* unit. A pop-up window will appear in the COMAND* display to indicate that a Tele Aid call is in progress.

Remote door unlock

In case you have locked your vehicle unintentionally (e.g. SmartKey inside vehicle), and the reserve SmartKey is not handy:

- ▶ Contact the Mercedes-Benz Response Center at 1-800-756-9018 (in the USA) or 1-888-923-8367 (in Canada).

You will be asked to provide your password which you provided when you completed the subscriber agreement.

- ▶ Then return to your vehicle and press the trunk lid button for a minimum of 20 seconds until the SOS button is flashing.

The message **CALL CONNECTED** appears in the multifunction display.

As an alternative, you may unlock the vehicle via Internet using the ID and password sent to you shortly after the completion of your acquaintance call.

The Response Center will then unlock your vehicle with the remote door unlocking feature.



The remote door unlock feature is available if the relevant cellular phone network is available.

The SOS button will flash and the message **CALL CONNECTED** will appear in the multifunction display to indicate receipt of the door unlock command.

Once the vehicle is unlocked, a Response Center specialist will attempt to establish voice contact with the vehicle occupants.

If the trunk lid button was pressed for more than 20 seconds before door unlock authorization was received by the Response Center, you must wait 15 minutes before pressing the trunk lid button again.

Stolen Vehicle Recovery services

In the event your vehicle was stolen:

- ▶ Report the incident to the police.
The police will issue a numbered incident report.

- ▶ Pass this number on to the Mercedes-Benz Response Center along with your password issued to you when you subscribed to the service.

The Response Center will then attempt to covertly contact the vehicle's Tele Aid system. Once the vehicle is located, the Response Center will contact the local law enforcement and you. The vehicle's location will only be provided to law enforcement.



When the anti-theft alarm or the tow-away alarm stays on for more than 30 seconds, a call is initiated automatically to the Response Center. See anti-theft alarm system (▷ page 87) and tow-away alarm (▷ page 89).

تلفن شبانه روزی: ۰۲۱-۸۸۶۲۰۸۵

FarmaSOS.com

Controls in detail

Useful features

Garage door opener

The built-in remote control is capable of operating up to three separately controlled devices, for example garage door openers, gate openers, or other devices compatible with HomeLink® or some other systems.

You can program the signal transmitter buttons.

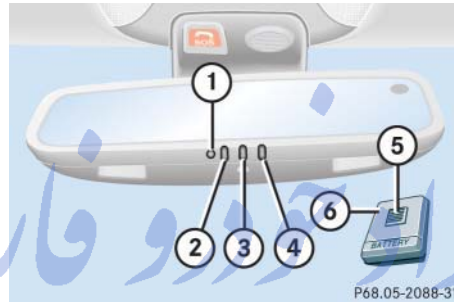

Remote control integrated into the interior rear view mirror

- ① Indicator lamp
- ② ③ ④ Signal transmitter button
- ⑤ Hand-held transmitter button
- ⑥ Hand-held remote control transmitter (not part of the vehicle equipment)

Warning!



Before programming the integrated remote control to a garage door opener or gate operator, make sure people and objects are out of the way of the device to prevent potential harm or damage.

When programming a garage door opener, the door moves up or down. When programming a gate operator, the gate opens or closes.

Do not use the integrated remote control with any garage door opener that lacks safety stop and reverse features as required by U.S. federal safety standards (this includes any garage door opener model manufactured before April 1, 1982). A garage door that cannot detect an object - signaling the door to stop and reverse - does not meet current U.S. federal safety standards.

Controls in detail

Useful features



Certain types of garage door openers are incompatible with the integrated opener. If you should experience difficulties with programming the transmitter, contact an authorized Mercedes-Benz Center, or call Mercedes-Benz Customer Assistance Center (in the USA only) at 1-800-FOR-MERCEdes, or Customer Service (in Canada) at 1-800-387-0100.



USA only:
This device complies with Part 15 of the FCC Rules. Operation is subject to the following two conditions:

- This device may not cause harmful interference, and
- this device must accept any interference received, including interference that may cause undesired operation.

Any unauthorized modification to this device could void the user's authority to operate the equipment.



Canada only:
This device complies with RSS-210 of Industry Canada. Operation is subject to the following two conditions:

- This device may not cause interference, and
- this device must accept any interference received, including interference that may cause undesired operation of the device.

Any unauthorized modification to this device could void the user's authority to operate the equipment.

Controls in detail

Useful features

Programming or reprogramming the integrated remote control

Step 1:

- ▶ Switch on ignition (▷ page 34).

Step 2:

- ▶ If you have previously programmed an integrated signal transmitter button and wish to retain its programming, proceed to step 3. Otherwise, press and hold the two outer signal transmitter buttons ② and ④ and release them only when the indicator lamp ① begins to flash after approximately 20 seconds (do not hold the button for longer than 30 seconds). This procedure erases any previous settings for all three channels and initializes the memory. If you later wish to program a second and/or third hand-held transmitter to the remaining two signal transmitter buttons, do not repeat this step and begin directly with step 3.

Step 3:

- ▶ Hold the end of the hand-held remote control transmitter ⑥ of the device you wish to train approximately 2 to 5 in (5 to 12 cm) away from the surface of the integrated remote control located on the interior rear view mirror, keeping the indicator lamp ① in view.

Step 4:

- ▶ Using both hands, simultaneously press the hand-held transmitter button ⑤ and the desired integrated signal transmitter button (②, ③ or ④). Do not release the buttons until completing step 5.

The indicator lamp ① on the integrated remote control will flash, first slowly and then rapidly.

i

The indicator lamp ① flashes the first time the signal transmitter button is programmed. If this button has already been programmed, the indicator lamp will only start flashing after 20 seconds.

Step 5:

- ▶ When the indicator lamp ① flashes rapidly, release both buttons.

Step 6:

- ▶ Press and hold the just-trained integrated signal transmitter button and observe the indicator lamp ①.

If the indicator lamp ① stays on constantly, programming is complete and your device should activate when the integrated signal transmitter button is pressed and released.



If the indicator lamp ① flashes rapidly for about two seconds and then turns to a constant light, continue with programming steps 8 through 12 as your garage door opener may be equipped with the “rolling code feature”.

Step 7:

- ▶ To program the remaining two buttons, repeat the steps above starting with step 3.

Rolling code programming

To train a garage door opener (or other rolling code devices) with the rolling code feature, follow these instructions after completing the “Programming” portion (steps 1 through 6) of this text. (A second person may make the following training procedures quicker and easier.)

Step 8:

- ▶ Locate “training” button on the garage door opener motor head unit.

Exact location and color of the button may vary by garage door opener brand. Depending on manufacturer, the “training” button may also be referred to as “learn” or “smart” button. If there is difficulty locating the transmitting button, refer to the garage door opener operator’s manual.

Step 9:

- ▶ Press “training” button on the garage door opener motor head unit.

The “training light” is activated.

You have 30 seconds to initiate the following step.

Step 10:

- ▶ Firmly press, hold for two seconds and release the programmed integrated signal transmitter button (②, ③ or ④).

Step 11:

- ▶ Press, hold for two seconds and release same button a second time to complete the training process.

Some garage door openers (or other rolling code equipped devices) may require you to perform this procedure a third time to complete the training. >>

Controls in detail

Useful features

▷▷ Step 12:

- ▶ Confirm the garage door operation by pressing the programmed integrated signal transmitter button (②), (③) or (④).

Step 13:

- ▶ To program the remaining two buttons, repeat the steps above starting with step 3.

Gate operator/Canadian programming

Canadian radio-frequency laws require transmitter signals to “time-out” (or quit) after several seconds of transmission which may not be long enough for the integrated signal transmitter to pick up the signal during programming. Similar to this Canadian law, some U.S. gate operators are designed to “time-out” in the same manner.

If you live in Canada or if you are having difficulties programming a gate operator (regardless of where you live) by using the programming procedures, replace step 4 with the following:

Step 4:

- ▶ Continue to press and hold the integrated signal transmitter button (②), (③) or (④) while you press and re-press (“cycle”) your hand-held remote control transmitter (⑥) every two seconds until the frequency signal has been learned. Upon successful training, the indicator lamp (①) will flash slowly and then rapidly after several seconds.
- ▶ Proceed with programming step 5 and step 6 to complete.

FarmaSOS.com

Operation of integrated remote control

- ▶ Switch on ignition (▷ page 34).
- ▶ Select and press the appropriate integrated signal transmitter button (②, ③ or ④) to activate the remote controlled device.

The integrated remote control transmitter continues to send the signal as long as the button is pressed – up to 20 seconds.

Erasing the integrated remote control memory

- ▶ Switch on ignition (▷ page 34).
- ▶ Simultaneously hold down the signal transmitter buttons ② and ④, for approximately 20 seconds, until the indicator lamp ① flashes rapidly. Do not hold for longer than 30 seconds.

The codes of all three channels are erased.



If you sell your vehicle, erase the codes of all three channels.

Reprogramming a single integrated signal transmitter button

To program a device using a signal transmitter button previously trained, follow these steps:

- ▶ Press and hold the desired signal transmitter button (②, ③ or ④). Do not release the button.
- ▶ The indicator lamp ① will begin to flash after 20 seconds. Without releasing the integrated signal transmitter button, proceed with programming starting with step 3.

Controls in detail

Useful features

Infrared reflecting windshield



- ① Mounting location for electronic toll collection devices (infrared transparent)
- ② Infrared transparent area (pass-through for electronic signals)
- ③ 31.5 in (80 cm)
- ④ 19.0 in (48 cm)
- ⑤ 1.75 in (4.5 cm)

Your vehicle is equipped with infrared reflecting glass which reduces the amount of radiated heat entering the interior through the windows.

The infrared reflecting glass also prevents the transmission of signals through the glass by in-vehicle electronic devices (e.g. electronic toll collection devices).

To allow the use of these devices in the vehicle, two infrared transparent areas (① and ②) are placed in the windshield.

تلفن شبانه روزی: ۰۲۱-۸۸۶۲۰۸۵

FarmaSOS.com

Operation

The first 1000 miles (1500 km)

Driving instructions

At the gas station

Engine compartment

Tires and wheels

Winter driving

Maintenance

Vehicle care

ایراد خودرو فارما

تلفن: ۰۲۱-۸۸۸۶۲۰۸۵

FarmaSOS.com

Operation

The first 1000 miles (1500 km)

In the “Operation” section you will find detailed information on operating, maintaining and caring for your vehicle.

The more cautiously you treat your vehicle during the break-in period, the more satisfied you will be with its performance later on.

- Drive your vehicle during the first 1000 miles (1500 km) at varying but moderate vehicle and engine speeds.
- During this period, avoid heavy loads (full throttle driving) and excessive engine speeds (no more than $\frac{2}{3}$ of maximum rpm in each gear).
- Avoid accelerating by kick-down.
- Do not attempt to slow the vehicle down by shifting to a lower gear using the gear selector lever.
- Select positions **3**, **2** or **1** only when driving at moderate speeds (for hill driving).
- Select **C** as the preferred shift program (▷ page 179) for the first 1000 miles (1500 km).

After 1000 miles (1500 km) you may gradually increase vehicle and engine speeds to the permissible maximum.



Additional instructions for AMG vehicles:

- During the first 1000 miles (1500 km), do not exceed a speed of 85 mph (140 km/h).
- During this period, avoid engine speeds above 4500 rpm in each gear.

All of the above instructions, as may apply to your vehicle type, also apply when driving the first 1000 miles (1500 km) after the engine or the rear differential has been replaced.



Always obey applicable speed limits.

▼ Driving instructions

Drive sensibly – save fuel

Fuel consumption, to a great extent, depends on driving habits and operating conditions.

To save fuel you should:

- Keep tires at the recommended inflation pressures.
- Remove unnecessary loads.
- Remove roof rack when not in use.
- Allow engine to warm up under low load use.
- Avoid frequent acceleration and deceleration.
- Have all maintenance work performed at the intervals specified in the Maintenance Booklet and as required by the Maintenance System (U.S. vehicles) or FSS (Canada vehicles). Contact an authorized Mercedes-Benz Center.

Fuel consumption is also increased by driving in cold weather, in stop-and-go traffic, on short trips, and in hilly area.

Drinking and driving

Warning!



Drinking and driving and/or taking drugs and driving are very dangerous combinations. Even a small amount of alcohol or drugs can affect your reflexes, perceptions and judgement.

The possibility of a serious or even fatal accident are greatly increased when you drink or take drugs and drive.

Do not drink or take drugs and drive or allow anyone to drive who has been drinking or taking drugs.

Pedals

Warning!



Keep driver's foot area clear at all times. Objects stored in this area may impair pedal movement.

Power assistance

Warning!



With the engine not running, there is no power assistance for the brake and steering systems. In this case, it is important to keep in mind that a considerably higher degree of effort is necessary to brake and steer the vehicle.

Operation

Driving instructions

Brakes

Warning!



After driving in heavy rain for some time without applying the brakes or through water deep enough to wet brake components, the first braking action may be somewhat reduced and increased pedal pressure may be necessary to obtain expected braking effect. Maintain a safe distance from vehicles in front.

Resting your foot on the brake pedal will cause excessive and premature wear of the brake pads.

It can also result in the brakes overheating, thereby significantly reducing their effectiveness. It may not be possible to stop the vehicle in sufficient time to avoid an accident.

To help prevent brake disk corrosion after driving on wet road surfaces (particularly salted roads), it is advisable to brake the vehicle with considerable force prior to parking. The heat generated serves to dry the brakes.

If your brake system is normally only subjected to moderate loads, you should occasionally test the effectiveness of the brakes by applying above-normal braking pressure at higher speeds. This will also enhance the grip of the brake pads.



Be very careful not to endanger other road users when you apply the brakes.

Refer to the description of the Brake Assist System (BAS) (▷ page 81).

If the parking brake is released and the brake warning lamp in the instrument cluster stays on, the brake fluid level in the reservoir is too low.

Brake pad wear or a leak in the system may be the reason for low brake fluid in the reservoir.

Have the brake system inspected immediately. Contact an authorized Mercedes-Benz Center.

All checks and service work on the brake system should be carried out by qualified technicians only. Contact an authorized Mercedes-Benz Center.

Only install brake pads and brake fluid recommended by Mercedes-Benz.

Warning!



If other than recommended brake pads are installed, or other than recommended brake fluid is used, the braking properties of the vehicle can be degraded to an extent that safe braking is substantially impaired. This could result in an accident.



When driving down long and steep grades, relieve the load on the brakes by shifting into a lower gear to use the engine's braking power. This helps prevent overheating of the brakes and reduces brake pad wear.

After hard braking, it is advisable to drive on for some time, rather than immediately parking, so that the air stream can cool down the brakes faster.

Driving off

Apply the brakes to test them briefly after driving off. Perform this procedure only when the road is clear of other traffic.

Warm up the engine smoothly. Do not place full load on the engine until the operating temperature has been reached.

When starting off on a slippery surface, do not allow a drive wheel to spin for an extended period with the ESP switched off. Doing so may cause serious damage to the drive train which is not covered by the Mercedes-Benz Limited Warranty.



Simultaneously depressing the accelerator pedal and applying the brake reduces engine performance and causes premature brake and drivetrain wear.

Parking

Warning!



Do not park this vehicle in areas where combustible materials such as grass, hay or leaves can come into contact with the hot exhaust system, as these materials could be ignited and cause a vehicle fire.

To reduce the risk of personal injury as a result of inadvertent vehicle movement, before turning off the engine and leaving the vehicle always:

- Keep right foot on brake pedal.
- Firmly depress parking brake pedal.
- Move the gear selector lever to position **P**.
- Slowly release brake pedal.
- When parked on an incline, turn front wheel towards the road curb.



Operation

Driving instructions



- Turn the SmartKey to starter switch position **0** and remove the SmartKey from the starter switch, or press the KEYLESS-GO* start/stop button (▷ page 35).
- Take the SmartKey or the SmartKey with KEYLESS-GO* with you and lock vehicle when leaving.



Set the parking brake whenever parking or leaving the vehicle. In addition, move gear selector lever to position **P**. When parking on hills, always turn front wheels towards the road curb.

Tires

Warning!



If you feel a sudden significant vibration or ride disturbance, or you suspect that possible damage to your vehicle has occurred, you should turn on the hazard warning flashers, carefully slow down, and drive with caution to an area which is a safe distance from the road.

Inspect the tires and the vehicle underbody for possible damage. If the vehicle or tires appear unsafe, have it towed to the nearest Mercedes-Benz Center or tire dealer for repairs.

Treadwear indicators (TWI) are required by law. These indicators are located in six places on the tread circumference and become visible at a tread depth of approximately $\frac{1}{16}$ in (1.6 mm), at which point the tire is considered worn and should be replaced.

The treadwear indicator appears as a solid band across the tread.

Warning!



Although the applicable federal motor vehicle safety laws consider a tire to be worn when the treadwear indicators (TWI) become visible at approximately $\frac{1}{16}$ in (1.6 mm), we recommend that you do not allow your tires to wear down to that level. As tread depth approaches $\frac{1}{8}$ in (3 mm), the adhesion properties on a wet road are sharply reduced.

Depending upon the weather and/or road surface (conditions), the tire traction varies widely.

Specified tire inflation pressures must be maintained. This applies particularly if the tires are subject to extreme operating conditions (e.g. high speeds, heavy loads, high ambient temperatures).

Warning!

Do not drive with a flat tire. A flat tire affects the ability to steer or brake the vehicle. You may lose control of the vehicle. Continued driving with a flat tire or driving at high speed with a flat tire will cause excessive heat build-up and possibly a fire.

Hydroplaning

Depending on the depth of the water layer on the road, hydroplaning may occur, even at low speeds and with new tires. Reduce vehicle speed, avoid track grooves in the road and apply brakes cautiously in the rain.

Tire traction

The safe speed on a wet, snow covered or icy road is always lower than on a dry road.

You should pay particular attention to the condition of the road whenever the outside temperatures are close to the freezing point.

Warning!

If ice has formed on the road, tire traction will be substantially reduced. Under such weather conditions, drive, steer and brake with extreme caution.

Mercedes-Benz recommends M+S rated radial-ply tires with a minimum tread depth of approximately $\frac{1}{8}$ in (4 mm) on all four wheels for the winter season to ensure normal balanced handling characteristics. On packed snow, they can reduce your stopping distance in compared to summer tires. Stopping distance, however, is still considerably greater than when the road is not covered with snow or ice. Exercise appropriate caution.



Avoid spinning of a drive wheel. This may cause serious damage to the drivetrain which is not covered by the Mercedes-Benz Limited Warranty.

Operation

Driving instructions

Tire speed rating

Regardless of the tire rating, local speed limits should be obeyed. Use prudent driving speeds appropriate to prevailing conditions.

Warning!



Even when permitted by law, never operate a vehicle at speeds greater than the maximum speed rating of the tires.

Exceeding the maximum speed for which tires are rated can lead to sudden tire failure, causing loss of vehicle control and possibly resulting in an accident and/or serious personal injury and possible death, for you and for others.

S 430, S 430 4MATIC, S 500, and S 500 4MATIC

Your vehicle is factory equipped with “H”-rated tires, which have a speed rating of 130 mph (210 km/h).

An electronic speed limiter prevents your vehicle from exceeding a speed of 130 mph (210 km/h).

S 600

Your vehicle is factory equipped with “Y”-rated tires, which have a speed rating of 186 mph (300 km/h).

An electronic speed limiter prevents your vehicle from exceeding a speed of 130 mph (210 km/h).

S 430, S 430 4MATIC, S 500, S 500 4MATIC, and S 600 with Sport Package* or Appearance Package*

Your vehicle is factory equipped with “Y”-rated tires, which have a speed rating of 186 mph (300 km/h).

An electronic speed limiter prevents your vehicle from exceeding a speed of 130 mph (210 km/h).

S 55 AMG

Your vehicle is factory equipped with “Y”-rated tires, which have a speed rating of 186 mph (300 km/h).

An electronic speed limiter prevents your vehicle from exceeding a speed of 155 mph (250 km/h).



For information on speed rating for winter tires, see “Winter tires” (> page 326).

For additional general information on tire speed markings on tire sidewall, see “Tire speed rating” (> page 324).

Winter driving instructions

The most important rule for slippery or icy roads is to drive sensibly and to avoid abrupt acceleration, braking and steering maneuvers. Do not use the cruise control system under such conditions.

When the vehicle is in danger of skidding, move gear selector lever to position **N**. Try to keep the vehicle under control by corrective steering action.



For information on driving with snow chains, see “Snow chains” (▷ page 327).

Warning!



On slippery road surfaces, never downshift in order to obtain braking action. This could result in drive wheel slip and reduced vehicle control. Your vehicle’s ABS will not prevent this type of control loss.

Road salts and chemicals can adversely affect braking efficiency. Increased pedal force may become necessary to produce the normal braking effect.

Depressing the brake pedal periodically when traveling at length on salt-strewn roads can bring road-salt impaired braking efficiency back to normal.

If the vehicle is parked after being driven on salt-treated roads, the braking efficiency should be tested as soon as possible after driving is resumed.

Warning!



Make sure not to endanger any other road users when carrying out these braking maneuvers.

Warning!



If the vehicle becomes stuck in snow, make sure that snow is kept clear of the exhaust pipe and from around the vehicle with the engine running. Otherwise, deadly carbon monoxide (CO) gases may enter vehicle interior resulting in unconsciousness and death.

To assure sufficient fresh air ventilation, open a window slightly on the side of the vehicle not facing the wind.

Warning!



The outside temperature indicator is not designed to serve as an ice-warning device and is therefore unsuitable for that purpose. Indicated temperatures just above the freezing point do not guarantee that the road surface is free of ice.

For more information on winter driving, see “Winter driving” (▷ page 326).

Operation

Driving instructions

Standing water



Do not drive through flooded areas or water of unknown depth. Before driving through water, determine its depth. Never accelerate before driving into water. The bow wave could force water into the engine and auxiliary equipment, thus damaging them.

If you must drive through standing water, drive slowly to prevent water from entering the passenger compartment or the engine compartment. Water in these areas could cause damage to electrical components or wiring of the engine or transmission, or could result in water being ingested by the engine through the air intake causing severe internal engine damage. Any such damage is not covered by the Mercedes-Benz Limited Warranty.

Passenger compartment

Warning!



Always fasten items being carried as securely as possible.

In an accident, during hard braking or sudden maneuvers, loose items will be thrown around inside the vehicle, and cause injury to vehicle occupants unless the items are securely fastened in the vehicle.

The trunk is the preferred place to carry objects.

Driving abroad

Abroad, there is an extensive Mercedes-Benz service network at your disposal. If you plan to drive into areas which are not listed in the index of your Mercedes-Benz Center directory, you should request pertinent information from an authorized Mercedes-Benz Center.

Control and operation of radio transmitters

COMAND*, radio, and telephone*

Warning!



Please do not forget that your primary responsibility is to drive the vehicle safely. Only operate the COMAND (Cockpit Management and Data System), radio, or telephone¹ if road, weather and traffic conditions permit.

Bear in mind that at a speed of just 30 mph (approximately 50 km/h), your vehicle is covering a distance of 44 feet (approximately 14 m) every second.

¹ Observe all legal requirements.

Telephones and two-way radios

Warning!



Never operate radio transmitters equipped with a built-in or attached antenna (i.e. without being connected to an external antenna) from inside the vehicle while the engine is running. Doing so could lead to a malfunction of the vehicle's electronic system, possibly resulting in an accident and/or personal injury.

Radio transmitters, such as a portable telephone or a citizens band unit should only be used inside the vehicle if they are connected to an antenna that is installed on the outside of the vehicle.

Refer to the radio transmitter operation instructions regarding use of an external antenna.

Catalytic converter

Your Mercedes-Benz is equipped with monolithic-type catalytic converters, an important element in conjunction with the oxygen sensors to achieve substantial control of the pollutants in the exhaust emissions. Keep your vehicle in proper operating condition by following our recommended maintenance instructions as outlined in your Maintenance Booklet.



To prevent damage to the catalytic converters, only use premium unleaded gasoline in this vehicle.

Any noticeable irregularities in engine operation should be repaired promptly. Otherwise, excessive unburned fuel may reach the catalytic converter, causing it to overheat and potentially start a fire.

Warning!



As with any vehicle, do not idle, park or operate this vehicle in areas where combustible materials such as grass, hay or leaves can come into contact with the hot exhaust system, as these materials could be ignited and cause a vehicle fire.

Operation

Driving instructions

Emission control

Certain systems of the engine serve to keep the toxic components of the exhaust gases within permissible limits required by law.

These systems, of course, will function properly only when maintained strictly according to factory specifications. Any adjustments on the engine should, therefore, be carried out only by qualified Mercedes-Benz Center authorized technicians.

Engine adjustments should not be altered in any way. Moreover, the specified service jobs must be carried out regularly according to Mercedes-Benz servicing requirements. For details refer to the Maintenance Booklet.

Warning!



Inhalation of exhaust gas is hazardous to your health. All exhaust gas contains carbon monoxide, and inhaling it can cause unconsciousness and lead to death.

Do not run the engine in confined areas (such as a garage) which are not properly ventilated. If you think that exhaust gas fumes are entering the vehicle while driving, have the cause determined and corrected immediately. If you must drive under these conditions, drive only with at least one window fully open at all times.

Coolant temperature

During severe operating conditions, e.g. stop-and-go traffic, the coolant temperature may rise close to approximately 248°F (120°C).

The engine should not be operated with the coolant temperature over 248°F (120°C). Doing so may cause serious engine damage which is not covered by the Mercedes-Benz Limited Warranty.

Warning!



- Driving when your engine is badly overheated can cause some fluids, which may have leaked into the engine compartment, to catch fire. You could be seriously burned.
- Steam from an overheated engine can cause serious burns and can occur just by opening the hood. Stay away from the engine if you see or hear steam coming from it.

Turn off the engine, get out of the vehicle and do not stand near the vehicle until the engine has cooled down.

▼ At the gas station

Refueling

Warning!



Gasoline is highly flammable and poisonous. It burns violently and can cause serious injury. Whenever you are around gasoline, avoid inhaling fumes and skin contact, extinguish all smoking materials. Never allow sparks, flame or smoking materials near gasoline!

The fuel filler flap is located on the right-hand side of the vehicle towards the rear. Locking/unlocking the vehicle with the SmartKey or the SmartKey with KEYLESS-GO* automatically locks/unlocks the fuel filler flap.

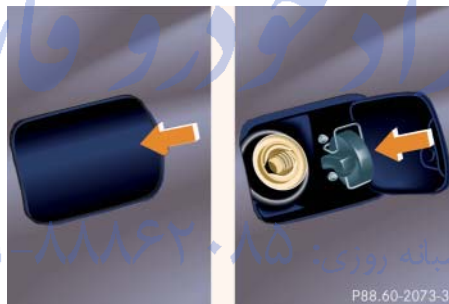

- ▶ Turn the engine off
 - by turning the SmartKey to position **0**. Remove the SmartKey from the starter switch.
 - by pressing the KEYLESS-GO* start/stop button (▷ page 35). Open the driver's door (with the driver's door open, starter switch is

Operation

At the gas station

now in position **0**, same as SmartKey removed from starter switch).

- ▶ Open the fuel filler flap by pushing at the point indicated by the arrow.

The fuel filler flap springs open.

- ▶ Turn the fuel cap to the left and hold on to it until possible pressure is released.
- ▶ Take off the cap and set it in the recess on the fuel filler flap.

To prevent fuel vapors from escaping into open air, fully insert filler nozzle unit.

- ▶ Only fill your tank until the filler nozzle unit cuts out – **do not top up or overfill**.



Operation

At the gas station



Warning!



Overfilling of the fuel tank may create pressure in the system which could cause a gas discharge. This could cause the gas to spray back out when removing the fuel pump nozzle, which could cause personal injury.

- ▶ Replace the fuel cap by turning it to the right.
You will hear when the fuel cap is tightened.
- ▶ Close the fuel filler flap.





Only use premium unleaded gasoline with a minimum Posted Octane Rating of 91 (average of 96 RON/86 MON).

Information on gasoline quality can normally be found on the fuel pump.

More information on gasoline can be found in the Factory Approved Service Products pamphlet.



Leaving the engine running and the fuel cap open can cause the yellow engine malfunction indicator lamp

 (USA only),  (Canada only) to illuminate.

For more information, see the “Practical hints” section (▶ page 341).

Check regularly and before a long trip

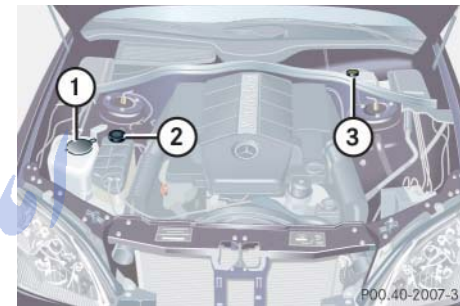

- ① Windshield washer and headlamp cleaning system*
- ② Coolant level
- ③ Brake fluid



Opening the hood, see (▶ page 286).

Windshield washer system and headlamp cleaning system*

For more information on refilling the washer reservoir, see “Windshield washer system and headlamp cleaning system*” (▷ page 295).

Coolant

For more information on coolant, see “Coolant level” (▷ page 292) and see “Fuels, coolants, lubricants, etc.” (▷ page 429).

Brake fluid

If you find that the brake fluid in the brake fluid reservoir has fallen to the minimum mark or below, have the brake system checked for brake pad thickness and leaks immediately.

Notify an authorized Mercedes-Benz Center immediately. Do not add brake fluid as this will not solve the problem. For more information, see “Practical hints” (▷ page 339).

For information on brake fluid, see “Brake fluid” (▷ page 431)

Engine oil level

For more information on engine oil, see “Engine oil” (▷ page 287).

Vehicle lighting

Check function and cleanliness. For more information on replacing light bulbs, see “Replacing bulbs” (▷ page 389).

For more information, see “Switching on headlamps” (▷ page 50).

Tire inflation pressure

For information on tire inflation pressure, see “Checking tire inflation pressure” (▷ page 307).

Operation

Engine compartment

Hood

Warning!



Do not pull the release lever while the vehicle is in motion. Otherwise the hood could be forced open by passing air flow.

Opening

The hood lock release lever is located in the driver's footwell to the left of the parking brake pedal.

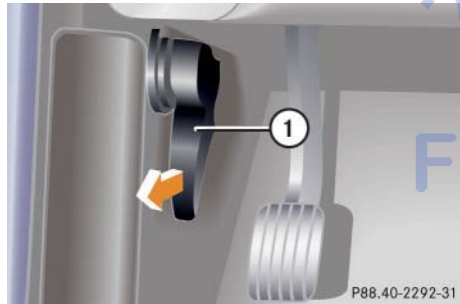

① Release lever

- ▶ Pull release lever ① in direction of arrow.

The hood is unlocked and handle ② will extend out of the radiator grille.



To avoid damage to the windshield wipers or hood, never open the hood if the wiper arms are folded forward away from the windshield.

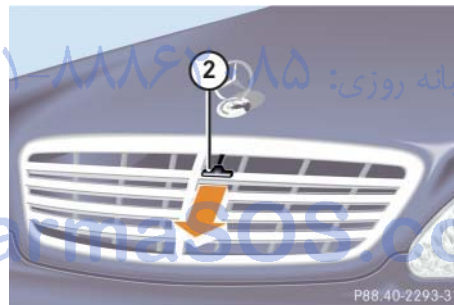

② Handle for opening the hood

- ▶ Pull handle ② to its stop out of radiator grille.

- ▶ Pull up on the hood (do not pull up on the handle) and then release it.

The hood will be automatically held open at shoulder height by gas-filled struts.

Warning!



To help prevent personal injury, stay clear of moving parts when the hood is open and the engine is running. Make sure the hood is properly closed before driving. When closing the hood, use extreme caution not to catch hands or fingers.

The radiator fan may continue to run for approximately 30 seconds or even restart after the engine has been turned off. Stay clear of fan blades.

Warning!



If you see flames or smoke coming from the engine compartment, or if the coolant temperature gauge indicates that the engine is overheated, do not open the hood. Move away from vehicle and do not open the hood until the engine has cooled down. If necessary, call the fire department.

Warning!



The engine is equipped with a transistorized ignition system. Because of the high voltage it is dangerous to touch any components (ignition coils, spark plug sockets, diagnostic socket) of the ignition system

- with the engine running
- while starting the engine
- if ignition is “on” and the engine is cranked manually

Closing

Warning!



Be careful that you do not close the hood on anyone.

- ▶ Let the hood drop from a height of approximately 1 ft. (30 cm).

The hood will lock audibly.

- ▶ Check to make sure the hood is fully closed.

If you can raise the hood at a point above the headlamps, then it is not properly closed. Open it again and let it drop with somewhat greater force.

Engine oil

The amount of oil your engine needs will depend on a number of factors, including driving style. Higher oil consumption can occur when

- the vehicle is new
- the vehicle is driven frequently at higher engine speeds

Engine oil consumption checks should only be made after the vehicle break-in period.



Do not use any special lubricant additives, as these may damage the drive assemblies. Using special additives not approved by Mercedes-Benz may cause damage not covered by the Mercedes-Benz Limited Warranty.

More information on this subject is available at any Mercedes-Benz Center.

Operation

Engine compartment

Checking the engine oil level with the control system



When checking the oil level

- the vehicle must be parked on level ground
- with the engine at operating temperature, the vehicle must have been stationary for at least five minutes with the engine turned off
- with the engine not at operating temperature yet, the vehicle must have been stationary for at least 30 minutes with the engine turned off

To check the engine oil level via the multifunction display, do the following:

- ▶ Switch on ignition (▷ page 34).

The standard display (▷ page 148) should appear in the multifunction display.

- ▶ Press button  or  on the steering wheel until the following message is seen in the multifunction display:

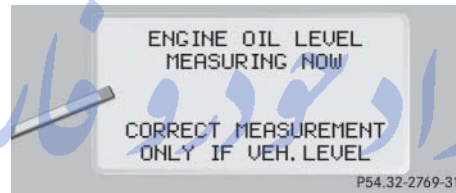

ENGINE OIL LEVEL
MEASURING NOW
CORRECT MEASUREMENT
ONLY IF VEH. LEVEL



One of the following messages will subsequently appear in the indicator:

- ENGINE OIL LEVEL OK
- ADD 1.0 QT. TO REACH MAX. OIL LEVEL
(Canada: 1.0 LITER)
- ADD 1.5 QTS. TO REACH MAX. OIL LEVEL
(Canada: 1.5 LITERS)
- ADD 2.0 QTS. TO REACH MAX. OIL LEVEL
(Canada: 2.0 LITERS)



If you want to interrupt the checking procedure, press the  or  button on the multifunction steering wheel.

- ▶ If necessary, add engine oil.

For adding engine oil see (▷ page 291).

For more information on engine oil, see the "Technical data" section (▷ page 429) and (▷ page 431).

Other display messages

If the SmartKey or KEYLESS-GO* start/stop button (▷ page 35) is not in position **2**, the following message will appear:

FOR ENGINE OIL LEVEL
SWITCH IGNITION ON

- ▶ Switch on ignition (▷ page 34).

If you see the message:

PERF. SERV. ON TIME

- ▶ If engine is at operating temperature, wait five minutes before repeating check procedure.
- ▶ If engine is not at operating temperature yet, wait 30 minutes before repeating check procedure.

If you see the message:

ENGINE OIL LEVEL
NOT WHEN ENGINE ON

- ▶ Turn off the engine.
- ▶ If the engine is at operating temperature, wait five minutes before checking oil.
- ▶ If the engine is not at operating temperature yet, you must wait 30 minutes before checking oil.

If there is excess engine oil with the engine at normal operating temperature, the following message will appear:

ENGINE OIL LEVEL
REDUCE OIL LEVEL

- ▶ Have excess oil siphoned or drained off. Contact an authorized Mercedes-Benz Center.



Excess oil must be siphoned or drained off. It could cause damage to the engine and catalytic converter not covered by the Mercedes-Benz Limited Warranty.



Perform the engine oil level check with the dipstick (S 430, S 500, and S 55 AMG only) if it cannot be completed with the control system.

In this case we recommend that you have the system checked at a Mercedes-Benz Center.

For more information on messages in the multifunction display concerning engine oil, see the “Practical hints” section (▷ page 362).

Operation

Engine compartment

Checking the engine oil level with the oil dipstick (S 430, S 500, and S 55 AMG only)

When checking the oil level

- the vehicle must be parked on level ground
- with the engine at operating temperature, the vehicle must have been stationary for at least five minutes with the engine turned off



The engine oil level can be checked by either the oil dipstick or via the multifunction display in the instrument cluster (▷ page 288). The amount of engine oil needed is shown more precisely in the multifunction display.

To check the engine oil level with the oil dipstick, do the following:

- ▶ Open the hood (▷ page 286).
- ▶ Pull out oil dipstick ① (▷ page 291).
- ▶ Wipe oil dipstick ① clean.

- ▶ Fully insert oil dipstick ① into the dipstick guide tube.
- ▶ Pull out oil dipstick ① again after approximately three seconds to obtain accurate reading.

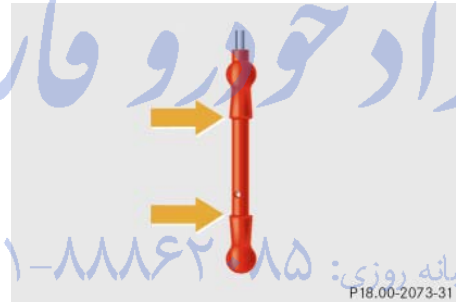

Oil dipstick

The oil level is correct when it is between the lower (min) and upper (max) mark of the oil dipstick.



The filling quantity between the upper and lower marks on the oil dipstick is approximately 2.1 US qt. (2.0 l).

- ▶ If necessary, add engine oil.

For adding engine oil, see (▷ page 291).

For more information on engine, see the “Technical data” section (▷ page 429) and (▷ page 431).

For more information on messages in the multifunction display concerning engine oil, see the “Practical hints” section (▷ page 362).

Adding engine oil



Only use approved engine oils and oil filters required for vehicles with Maintenance System (U.S. vehicles) or FSS (Canada vehicles). For a listing of approved engine oils and oil filters, refer to the Factory Approved Service Products pamphlet in your vehicle literature portfolio, or contact an authorized Mercedes-Benz Center.

Using engine oils and oil filters of specification other than those expressly required for the Maintenance System (U.S. vehicles) or FSS (Canada vehicles), or changing of oil and oil filter at change intervals longer than those called for by the Maintenance System (U.S. vehicles) or FSS (Canada Vehicles) will result in engine damage not covered by the Mercedes-Benz Limited Warranty.

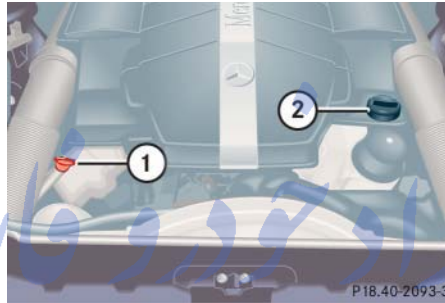

S 430, S 430 4MATIC, S 500, S 500 4MATIC, and S 55 AMG

- ① Oil dipstick (S 430, S 500, and S 55 AMG only)
- ② Filler cap

- ▶ Unscrew filler cap ② from filler neck.
- ▶ Add engine oil as required. Be careful not to overfill with oil.

Be careful not to spill any oil when adding. Avoid environmental damage caused by oil entering the ground or water.

Operation

Engine compartment



Excess oil must be siphoned or drained off. It could cause damage to the engine and catalytic converter not covered by the Mercedes-Benz Limited Warranty.

- ▶ Screw filler cap ② back on filler neck.



S 600

- ① Filler cap

- ▶ Unscrew filler cap ① from filler neck.
- ▶ Add engine oil as required. Be careful not to overfill with oil.



Operation

Engine compartment

- ▷▷ Be careful not to spill any oil when adding. Avoid environmental damage caused by oil entering the ground or water.



Excess oil must be siphoned or drained off. It could cause damage to the engine and catalytic converter not covered by the Mercedes-Benz Limited Warranty.

- ▶ Screw filler cap ① back on filler neck.

For more information on engine, see the “Technical data” section (▷ page 429) and (▷ page 431).

Transmission fluid level

The transmission fluid level does not need to be checked. If you notice transmission fluid loss or gear shifting malfunctions, have an authorized Mercedes-Benz Center check the automatic transmission.

Active Body Control* (ABC*) fluid level

Regular fluid level check is not required. If you notice fluid leaks or malfunction messages in the multifunction display, have an authorized Mercedes-Benz Center check the ABC-system.

Coolant level

The engine coolant is a mixture of water and anticorrosion/antifreeze.

When checking the coolant level,

- the vehicle must be parked on level ground, and
- the engine must be cool.

Warning!



In order to avoid any possibly serious burns:

- Use extreme caution when opening the hood if there are any signs of steam or coolant leaking from the cooling system, or if the coolant temperature gauge indicates that the coolant is overheated.
- Do not remove pressure cap on coolant reservoir if coolant temperature is above 158°F (70°C). Allow engine to cool down before removing cap. The coolant reservoir contains hot fluid and is under pressure.
- Using a rag, slowly open the cap approximately $\frac{1}{2}$ turn to relieve excess pressure. If opened immediately, scalding hot fluid and steam will be blown out under pressure.
- Do not spill antifreeze on hot engine parts. Antifreeze contains ethylene glycol which may burn if it comes into contact with hot engine parts.

The coolant expansion tank is located on the passenger side of the engine compartment.



① Coolant expansion tank

- ▶ Using a rag, turn the cap slowly approximately $\frac{1}{2}$ turn to the left to release any excess pressure.
- ▶ Continue turning the cap to the left and remove it.



S 600:

Only open the cap on coolant expansion tank ①. Never open the cap between the charge-air coolers. Otherwise, the engine could be damaged.

The coolant level is correct if the level

- for cold coolant: reaches the black top part of the reservoir
- for warm coolant: is approximately 0.6 in (1.5 cm) higher

- ▶ Add coolant as required.
- ▶ Replace and tighten cap.

For more information on coolant, see “Coolants” (▷ page 433).

Operation

Engine compartment

Battery

Your vehicle's battery is located on the right side of the trunk floor (▷ page 403).

The battery should always be sufficiently charged in order to achieve its rated service life. Refer to Maintenance Booklet for battery maintenance intervals.

If you use your vehicle mostly for short-distance trips, you will need to have the battery charge checked more frequently.

When replacing the battery, always use batteries approved by Mercedes-Benz.

If you do not intend to operate your vehicle for an extended period of time, consult an authorized Mercedes-Benz Center about steps you need to observe.



Observe all safety instructions and precautions when handling automotive batteries.



Risk of explosion



Keep flames or sparks away from battery. Do not smoke.



Battery acid is caustic. Do not allow it to come into contact with skin, eyes or clothing.

In case it does, immediately flush affected area with clear water and seek medical help if necessary.



Wear eye protection.



Keep children away.



Follow the instructions in this Operator's Manual.

Batteries contain materials that can harm the environment if disposed of improperly. Recycling of batteries is the preferred method of disposal. Many states require sellers of batteries to accept old batteries for recycling.

Windshield washer system and headlamp cleaning system*

The windshield washer reservoir is located in the engine compartment.

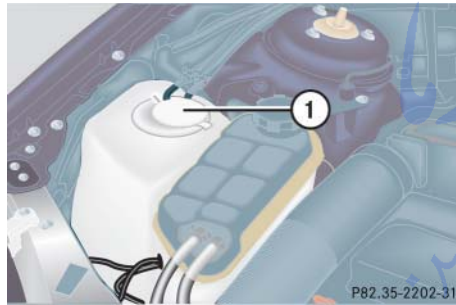

① Washer fluid reservoir

Fluid for the windshield washer system and the headlamp cleaning system is supplied from the windshield washer reservoir. It has a capacity of approximately:

- 3.2 US qt. (3.0 l) in vehicles without headlamp cleaning system
- 7.1 US qt. (6.7 l) in vehicles with headlamp cleaning system or heated reservoir

During all seasons, add MB Windshield Washer Concentrate “S” to water. Premix the windshield washer fluid in a suitable container.

- ▶ Refill the reservoir with MB Windshield Washer Concentrate and water (or commercially available premixed windshield washer solvent/antifreeze, depending on ambient temperatures).

Always use washer solvent/antifreeze where temperatures may fall below freezing point. Failure to do so could result in damage to the washer system/reservoir.



Only use washer fluid which is suitable for plastic lenses. Improper washer fluid can damage the plastic lenses of the headlamps.

For more information, see “Windshield and headlamp washer system” (▷ page 436).

Warning!



Washer solvent/antifreeze is highly flammable. Do not spill washer solvent/antifreeze on hot engine parts, because it may ignite and burn. You could be seriously burned.

Operation

Tires and wheels

See an authorized Mercedes-Benz Center for information on tested and recommended rims and tires for summer and winter operation. They can also offer advice concerning tire service and purchase.

Warning!



Replace rims or tires with the same designation, manufacturer and type as shown on the original part. See an authorized Mercedes-Benz Center for further information. If incorrectly sized rims and tires are mounted:

- The wheel brakes or suspension components can be damaged.
- The operating clearance of the wheels and the tires may no longer be correct.

Warning!



Worn, old tires can cause accidents. If the tire tread is badly worn, or if the tires have sustained damage, replace them.

When replacing rims, only use genuine Mercedes-Benz wheel bolts specified for the particular rim type. Failure to do so can result in the bolts loosening and possibly an accident.

Retreaded tires are not tested or recommended by Mercedes-Benz, since previous damage cannot always be recognized on retreads. The operating safety of the vehicle cannot be assured when such tires are used.

See an authorized Mercedes-Benz Center for information on tested and recommended rims and tires for summer and winter operation.

Important guidelines

- Only use sets of tires and rims of the same type and make.
- Tires must be of the correct size for the rim.
- Break in new tires for approximately 60 miles (100 km) at moderate speeds.
- Regularly check the tires and rims for damage. Dented or bent rims can cause tire inflation pressure loss and damage to the tire beads.
- If vehicle is heavily loaded, check tire inflation pressure and correct as required.
- Do not allow your tires to wear down too far. Adhesion properties on wet roads are sharply reduced at tread depths under $\frac{1}{8}$ in (3 mm).
- When replacing individual tires, you should mount new tires on the front wheels first (on vehicles with same-sized wheels all around).

Tire care and maintenance

Warning!



Regularly check the tires for damage. Damaged tires can cause tire inflation pressure loss. As a result, you could lose control of your vehicle.

Worn, old tires can cause accidents. If the tire tread is badly worn, or if the tires have sustained damage, replace them.

Regularly check your tire inflation pressure at least once a month. For more information on checking tire inflation pressure see “Recommended tire inflation pressure” (> page 305).

Tire inspection

Every time you check your tire inflation pressure, you should also inspect your tires for the following:

- excessive tread wear (> page 298)
- cord or fabric showing through the tire’s rubber
- bumps, bulges, cuts, cracks or splits in the tread or side of the tire

Replace the tire if you find any of the above conditions.

Make sure you also inspect the spare tire periodically for condition and inflation. Spare tires will age and become worn over time even if never used, and thus should be inspected and replaced when necessary.

Life of tire

The service life of a tire is dependent upon varying factors including but not limited to:

- Driving style
- Tire inflation pressure
- Distance driven

Warning!



Tires and spare tire should be replaced after six years, regardless of the remaining tread.

Operation

Tires and wheels

Tread depth

Do not allow your tires to wear down too far. Adhesion properties on wet roads are sharply reduced at tread depths under $\frac{1}{8}$ in (3 mm).

Tread wear indicators (TWI) are required by law. These indicators are located in six places on the tread circumference and become visible at a tread depth of approximately $\frac{1}{16}$ in (1.6 mm), at which point the tire is considered worn and should be replaced.

Recommended minimum tire tread depth:

- Summer tires $\frac{1}{8}$ in (3 mm)
- Winter tires $\frac{1}{6}$ in (4 mm)

Warning!



Although the applicable federal motor safety laws consider a tire to be worn when the tread wear indicators (TWI) become visible at approximately $\frac{1}{16}$ in (1.6 mm), we recommend that you do not allow your tires

to wear down to that level. As tread depth approaches $\frac{1}{8}$ in (3 mm), the adhesion properties on a wet road are sharply reduced.

Depending upon the weather and/or road surface (conditions), the tire traction varies widely.

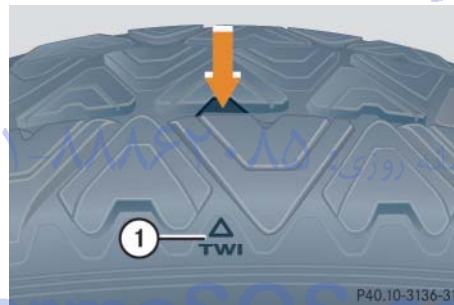

① TWI (Tread Wear Indicator)

The tread wear indicator appears as a solid band across the tread.

Storing tires



Keep unmounted tires in a cool, dry place with as little exposure to light as possible. Protect tires from contact with oil, grease and gasoline.

Cleaning tires



Never use a round nozzle to power wash tires. The intense jet of water can result in damage to the tire.

Always replace a damaged tire.

Direction of rotation

Unidirectional tires offer added advantages, such as better hydroplaning performance. To benefit, however, you must make sure the tires rotate in the direction specified.

An arrow on the sidewall indicates the intended direction of rotation (spinning) of the tire.



Spare wheels may be mounted against the direction of rotation (spinning) even with a unidirectional tire for temporary use only until the regular drive wheel has been repaired or replaced. Always observe and follow applicable temporary use restrictions and speed limitations indicated on the spare wheel.

Loading the vehicle

Two labels on your vehicle show how much weight it may properly carry.

- The Tire and Loading Information placard (Example A) or the Vehicle Tire Information placard (Example B) can be found on the driver's door B-pillar. This placard tells you important information about the number of people that can be in the vehicle and the total weight that can be carried in the vehicle. It also contains information on the proper size and recommended tire inflation pressures for the original equipment tires on your vehicle.

- The Certification label, also found on the driver's door B-pillar tells you about the gross weight capacity of your vehicle, called the Gross Vehicle Weight Rating (GVWR). The GVWR includes the weight of the vehicle, all occupants, fuel and cargo. The Certification label also tells you about the front and rear axle weight capacity, called the Gross Axle Weight Rating (GAWR). The GAWR is the total allowable weight that can be carried by a single axle (front or rear). Never exceed the GVWR or GAWR for either the front axle or rear axle.

Operation

Tires and wheels



① Driver's door B-pillar

Following is a discussion on how to work with the information contained on the two placards with regards to loading your vehicle.

Tire and Loading Information

Warning!



Do not overload the tires by exceeding the specified load limit or vehicle capacity weight as indicated on the placard on the driver's door B-pillar. Overloading the tires can overheat them, possibly causing a blowout. Overloading the tires can also result in handling or steering problems, or brake failure.

Your vehicle is equipped with either the Tire and Loading Information placard (Example A) or the Vehicle Tire Information placard (Example B).



Data shown on placard examples is for illustration purposes only. Load limit data is specific to each vehicle and may vary from data shown in the illustrations below. Refer to placard on vehicle for actual data specific to your vehicle.

Placard (Example A)

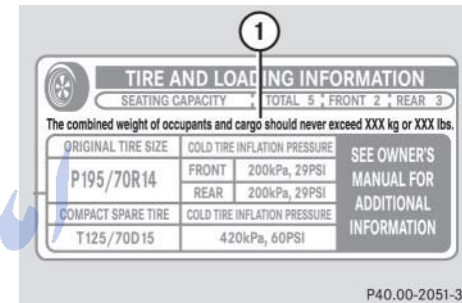

① Load limit information on the Tire and Loading Information placard

The placard showing the load limit information is located on the driver's door B-pillar. If your vehicle is equipped with the Tire and Loading Information placard (Example A), locate the statement "The combined weight of occupants and cargo should never exceed XXX kg or XXX lbs." on this placard. The combined weight of all occupants, cargo / luggage and trailer tongue load (if applicable) should never exceed the weight referenced in that statement.

Placard (Example B)

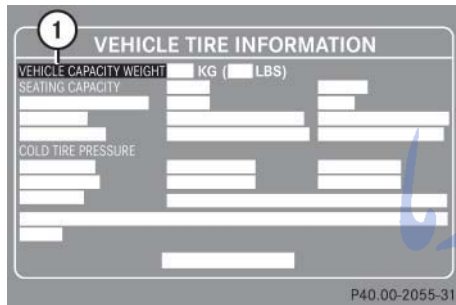

- ① Load limit information on the Vehicle Tire Information placard

The placard showing the load limit information is located on the driver's door B-pillar. If your vehicle is equipped with the Vehicle Tire Information placard (Example B), locate the heading "Vehicle Capacity Weight" on this placard. The combined weight of all occupants, cargo/luggage and trailer tongue (if applicable) should never exceed the weight listed next to vehicle capacity weight.

Seating capacity

The seating capacity gives you important information on the number of occupants that can be in the vehicle. Observe front and rear seating capacity. Your vehicle is equipped with either placard Example A or placard Example B located on the driver's door B-pillar (▷ page 300).



Data shown on placard examples is for illustration purposes only. Seating data is specific to each vehicle and may vary from data shown in the illustrations below. Refer to placard on vehicle for actual data specific to your vehicle.

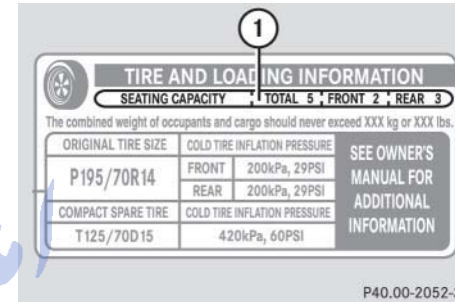

Placard (Example A)

- ① Seating capacity

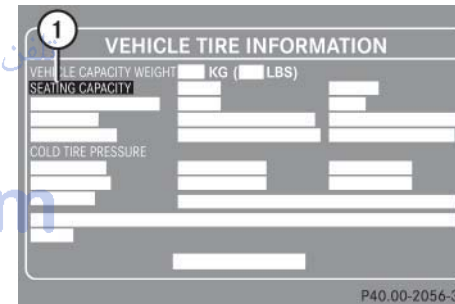

Placard (Example B)

- ① Seating capacity

Operation

Tires and wheels

Steps for determining correct load limit

The following steps have been developed as required of all manufacturers under Title 49, Code of U.S. Federal Regulations, Part 575 pursuant to the “National Traffic and Motor Vehicle Safety Act of 1966”.

Step 1 (Vehicles equipped with placard Example A)

- ▶ Locate the statement “The combined weight of occupants and cargo should never exceed XXX kg or XXX lbs.” on your vehicle’s placard.

Step 1 (Vehicles equipped with placard Example B)

- ▶ Locate the heading “Vehicle Capacity Weight” on your vehicle’s placard.

Step 2

- ▶ Determine the combined weight of the driver and passengers that will be riding in your vehicle.

Step 3

- ▶ Subtract the combined weight of the driver and passengers from XXX kilograms or XXX lbs.

Step 4

- ▶ The resulting figure equals the available amount of cargo and luggage load capacity. For example, if the “XXX” amount equals 1400 lbs. and there will be five 150 lbs. passengers in your vehicle, the amount of available cargo and luggage load capacity is 650 lbs. $(1400 - 750 (5 \times 150) = 650 \text{ lbs.})$

Step 5

- ▶ Determine the combined weight of luggage and cargo being loaded on the vehicle. That weight may not safely exceed the available cargo and luggage load capacity calculated in step 4.

Step 6 (if applicable)

- ▶ If your vehicle will be towing a trailer, load from your trailer will be transferred to your vehicle. Consult this manual to determine how this reduces the available cargo and luggage load capacity of your vehicle (▷ page 304).

The following table shows examples on how to calculate total and cargo load capacities with varying seating configurations and number and size of occupants. The following examples use a load limit of 1500 lbs. **This is for illustration purposes only.** Make sure you are using the actual load limit for your vehicle stated on the vehicle’s placard (▷ page 300).

Example	Combined weight limit of occupants and cargo from placard	Number of occupants (driver and passengers)	Seating configuration	Occupants weight	Combined weight of all occupants	Available cargo/luggage and trailer tongue weight (total load limit or vehicle capacity weight from placard minus combined weight of all occupants)
1	1500 lbs	5	front: 2 rear: 3	Occupant 1: 150 lbs Occupant 2: 180 lbs Occupant 3: 160 lbs Occupant 4: 140 lbs Occupant 5: 120 lbs	750 lbs	1500 lbs - 750 lbs = 750 lbs
2	1500 lbs	3	front: 1 rear: 2	Occupant 1: 200 lbs Occupant 2: 190 lbs Occupant 3: 150 lbs	540 lbs	1500 lbs - 540 lbs = 960 lbs
3	1500 lbs	1	front:1	Occupant 1: 150 lbs	150 lbs	1500 lbs - 150 lbs = 1350 lbs

The higher the weight of all occupants, the less cargo and luggage load capacity is available.

For more information, see “Trailer tongue load” (> page 304).

Operation

Tires and wheels

Certification label

Even after careful determination of the combined weight of all occupants, cargo and the trailer tongue load (if applicable) (▷ page 304) as to not exceed the permissible load limit, you must make sure that your vehicle never exceeds the Gross Vehicle Weight Rating (GVWR) and the Gross Axle Weight Rating (GAWR) for either the front or rear axle. You can obtain the GVWR and GAWR from the Certification label. The Certification Label can be found on the driver's door B-pillar, see "Technical data" (▷ page 418).

Gross Vehicle Weight Rating (GVWR): The total weight of the vehicle, all occupants, all cargo, and the trailer tongue load (▷ page 304) must never exceed the GVWR.

Gross Axle Weight Rating (GAWR): The total allowable weight that can be carried by a single axle (front or rear).

To assure that your vehicle does not exceed the maximum permissible weight limits (GVWR and GAWR for front and rear axle), have the loaded vehicle (including driver, passengers and all cargo and, if applicable, trailer fully loaded) weighed on a suitable commercial scale.

Trailer tongue load

The tongue load of any trailer is an important weight to measure because it affects the load you can carry in your vehicle. If a trailer is towed, the tongue load must be added to the weight of all occupants riding and any cargo you are carrying in the vehicle. The tongue load typically is ten percent of the trailer weight and everything loaded in it.

Your Mercedes-Benz has been designed primarily to carry passengers and their cargo. Mercedes-Benz does not recommend trailer towing with your vehicle.

Recommended tire inflation pressure

Warning!



Follow recommended tire inflation pressures.

Do not underinflate tires. Underinflated tires wear excessively and /or unevenly, adversely affect handling and fuel economy, and are more likely to fail from being overheated.

Do not overinflate tires. Overinflated tires can adversely affect handling and ride comfort, wear unevenly, increase stopping distance, and result in sudden deflation (blowout) because they are more likely to become punctured or damaged by road debris, potholes etc.

Your vehicle is equipped with either the Tire and Loading Information placard (Example A) or the Vehicle Tire Information placard (Example B) located on the driver's door B-pillar (> page 300).

The tire inflation pressure should be checked regularly and should only be adjusted on cold tires. The tires can be considered cold if the vehicle has been parked for at least three hours or driven less than one mile (1.6 km).

Follow recommended cold tire inflation pressures listed on placard.

Keeping the tires properly inflated provides the best handling, tread life and riding comfort.

In addition to the tire placard on the driver's door B-pillar, also consult the fuel filler flap for any additional information pertaining to special driving situations. For more information, see "Important notes on tire inflation pressure" (> page 306).



Data shown on placard examples is for illustration purposes only. Tire data is specific to each vehicle and may vary from data shown in the illustrations below. Refer to placard on vehicle for actual data specific to your vehicle.

Placard (Example A)

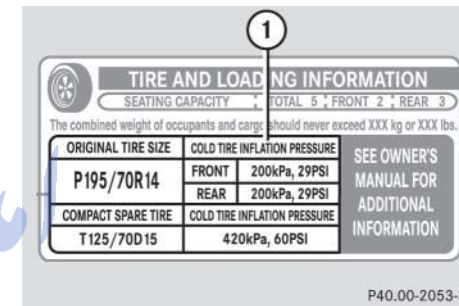

① Tire and Loading Information placard with recommended cold tire inflation pressures

Placard (Example A) lists the recommended cold tire inflation pressures for maximum loaded vehicle weight. The tire inflation pressures listed apply to the tires installed as original equipment.

Operation

Tires and wheels

Placard (Example B)

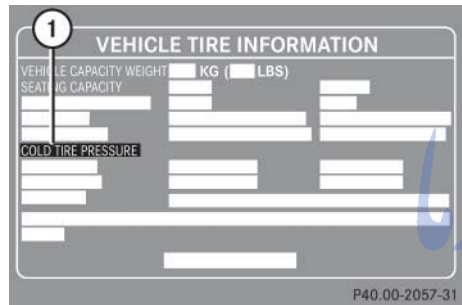

- ① Vehicle Tire Information placard with recommended cold tire inflation pressures

Placard (Example B) lists the recommended cold tire inflation pressures for maximum loaded vehicle weight. The tire inflation pressures listed apply to the tires installed as original equipment.



Placard (Example B) may list recommended cold tire inflation pressures for different vehicle loads.

Important notes on tire inflation pressure

Warning!



If the tire inflation pressure repeatedly drops:

- Check the tires for punctures from foreign objects.
- Check to see whether air is leaking from the valves or from around the rim.

Tire temperature and tire inflation pressure are also increased while driving, depending on the driving speed and the tire load.

If you will be driving your vehicle at high speeds of 100 mph (160 km/h) or higher, where it is legal and conditions allow, consult the placard on the inside of the fuel filler flap on how to adjust the cold tire inflation pressure. If you do not adjust the tire inflation pressure, excessive heat can build up and result in sudden tire failure.

Be sure to readjust the tire inflation pressure for normal driving speeds. You should wait until the tires are cold before adjusting the tire inflation pressure.

Some vehicles may have supplemental tire pressure information for vehicle loads less than the maximum loaded vehicle condition. If such information is provided, it can be found on the placard located on the inside of the fuel filler flap.

Tire inflation pressure changes by approximately 1.5 psi (0.1 bar) per 18°F (10°C) of air temperature change. Keep this in mind when checking tire inflation pressure where the temperature is different from the outside temperature.

Checking tire inflation pressure

Regularly check your tire inflation pressure at least once a month.

Check and adjust the tire inflation pressure when the tires are cold. The tires can be considered cold if the vehicle has been parked for at least three hours or driven less than one mile (1.6 km).

If you check the tire inflation pressure when the tires are warm (the vehicle has been driven for several miles or sitting less than three hours), the reading will be approximately 4 psi (0.3 bar) higher than the cold reading. This is normal. Do not let air out to match the specified cold tire inflation pressure. Otherwise, the tire will be underinflated.

Checking tire inflation pressure manually

Follow the steps below to achieve correct tire inflation pressure:

- ▶ Remove the cap from the valve on one tire.
- ▶ Firmly press a tire gauge onto the valve.
- ▶ Read tire inflation pressure on tire gauge and check against the recommended tire inflation pressure on the placard on the driver's door B-pillar (▶ page 305). If necessary, add air to achieve the recommended tire inflation pressure.



If you have overfilled the tire, release tire inflation pressure by pushing the metal stem of the valve with e.g. a tip of a pen. Then recheck the tire inflation pressure with the tire gauge.

- ▶ Install the valve cap.
- ▶ Repeat this procedure for each tire.

Checking tire inflation pressure electronically*

The tire inflation pressure monitor only functions on wheels that are equipped with the proper electronic sensors. It monitors the tire inflation pressure, as selected by the driver, in all four tires. A warning is issued to alert you to a decrease in tire inflation pressure in one or more of the tires.

You can call up the tire inflation pressure monitoring display using the control system (▶ page 143).

Operation

Tires and wheels



After you have reactivated the tire inflation pressure monitor, the current tire inflation pressures will only be shown after a few minutes' driving time.

During this time, you will see the following message in the multifunction display:

TIRE PRES. DISPLAY
APPEARS AFTER
DRIVING A FEW
MINUTES



Possible differences between the readings of a tire inflation pressure gauge of an air hose, e.g. gas station equipment, and the vehicle's control system can occur. The readings issued by the control system are more precise.

- ▶ Press button or on the multifunction steering wheel repeatedly until the standard display menu appears in the multifunction display (▷ page 143).
- ▶ Press button or repeatedly until the current tire inflation pressures for each tire appear in the multifunction display.

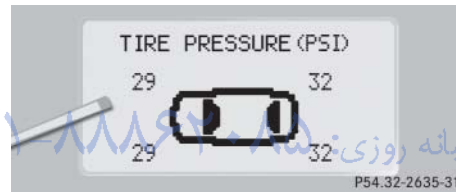

You can select the unit of measure (Bar/Psi) used for the tire inflation pressure by changing the setting in the control system (▷ page 164).

- ▶ Switch on the ignition (▷ page 34).

Warning!



When the tire inflation pressure monitoring system warning light is lit, one or more of your tires is significantly under-inflated. You should stop and check your tires as soon as possible, and inflate them to the proper tire inflation pressure as indicated on the vehicle's tire information placard. Driving on a significantly under-inflated tire causes the tire to overheat and can lead to tire failure. Under-inflation also reduces fuel efficiency and tire tread life, and may affect the vehicle's handling and stopping ability. Each tire, including the spare, should be checked monthly when cold and set to the recommended tire inflation pressure as specified in the vehicle placard and owner's manual.



The recommended tire inflation pressures for your vehicle can be found on the tire placard located on the driver's door B-pillar. The tire inflation pressures are not listed in the owner's manual.



Operating radio transmission equipment (e.g. wireless headsets, two-way radios) in or near the vehicle could cause the tire inflation pressure monitor to malfunction.

Warning!



The tire inflation pressure monitor does not indicate a warning for wrongly selected tire inflation pressures. Always adjust tire inflation pressure according to the placard on the driver's door B-pillar or, if available, the inside of the fuel filler flap.

The tire inflation pressure monitor is not able to issue a warning due to a sudden dramatic loss of tire inflation pressure (e.g. tire blowout caused by a foreign object). In this case bring the vehicle to a halt by carefully applying the brakes and avoiding abrupt steering maneuvers.

Operation

Tires and wheels

Warning!



Follow recommend tire inflation pressures.

Do not overinflate tires. Overinflating tires can result in sudden deflation (blowout) because they are more likely to become punctured or damaged by road debris, potholes, etc.

Do not underinflate tires. Underinflated tires wear unevenly, adversely affect handling and fuel economy, and are more likely to fail from being overheated.



Do not overload the tires by exceeding the specified load limit or vehicle capacity weight as indicated on the placard on the driver's door B-pillar. Overloading the tires can overheat them, possibly causing a blowout.

Operation

Tires and wheels

Reactivating the tire inflation pressure monitor

The tire inflation pressure monitor must be reactivated in the following situations:

- If you have changed the tire inflation pressure
 - If you have replaced the wheels or tires
 - If you have installed new wheels or tires
- Using the tire placard on the driver's door B-pillar or, if available, the inside of the fuel filler flap, make sure the tire inflation pressure of all four tires is correct.
- Press button  or  repeatedly until you see the current tire inflation pressures for each tire appear in the multifunction display or the following message appears in the multifunction display:
- TIRE PRES. DISPLAY
APPEARS AFTER
DRIVING A FEW
MINUTES



If you are transporting a deflated tire in the vehicle, do not activate the tire inflation pressure monitor until

- the deflated tire is no longer in the vehicle
- you have inflated the tire to the correct tire inflation pressure

- Press the reset button  on the instrument cluster (► page 140).

The following message will appear in the multifunction display:

MONITOR CURRENT
TIRE
PRESSURES?

- Press the  button.

The following message will appear in the multifunction display:

TIRE PRES. MONITOR
REACTIVATED

The tire inflation pressure monitor will now monitor the tire inflation pressure values of all four tires.

The following message will appear in the multifunction display field:

TIRE PRES. DISPLAY
APPEARS AFTER
DRIVING A FEW
MINUTES

This display appears until the individual tire inflation pressure values are matched with the tires. The individual values are then displayed (► page 308).

If you wish to cancel activation:

- ▶ Press the  button.

If one of the following messages appears in the multifunction display:

- TIRE PRES. MONITOR REACTIVATE AFTER CORRECTING PRESSURE
- TIRE PRESSURE PLEASE CORRECT
- ▶ Check the tire inflation pressures and correct them if necessary.
- ▶ Reactivate the tire inflation pressure monitor.

Potential problems associated with underinflated and overinflated tires

Underinflated tire inflation pressure

Underinflated tires can:

- cause excessive and uneven tire wear
- adversely affect fuel economy
- lead to tire failure from being overheated
- adversely affect handling characteristics

Warning!

Follow recommended tire inflation pressures.

Do not underinflate tires. Underinflated tires wear excessively and / or unevenly, adversely affect handling and fuel economy, and are more likely to fail from being overheated.

Overinflated tire inflation pressure

Overinflated tires can:

- adversely affect handling characteristics
- cause uneven tire wear
- be more prone to damage from road hazards
- adversely affect ride comfort
- increase stopping distance

Warning!



Follow recommended tire inflation pressures.

Do not overinflate tires. Overinflated tires can adversely affect handling and ride comfort, wear unevenly, increase stopping distance, and result in sudden deflation (blowout) because they are more likely to become punctured or damaged by road debris, potholes etc.

Operation

Tires and wheels

Tire labeling

Besides tire name (sales designation) and manufacturer name, a number of markings can be found on a tire.

Following are some explanations for the markings on your vehicle's tires:

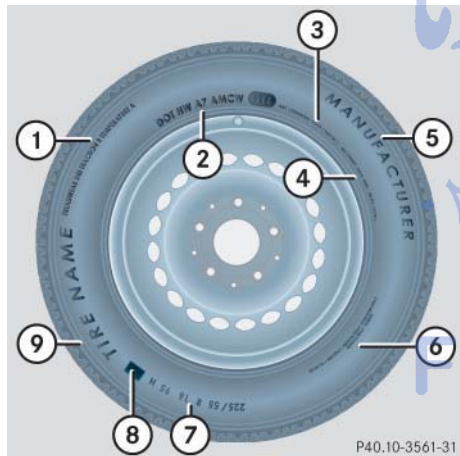

- ① Uniform Quality Grading Standards (▷ page 319)
- ② DOT, Tire Identification Number (TIN) (▷ page 317)
- ③ Maximum tire load (▷ page 318)
- ④ Maximum tire inflation pressure (▷ page 319)
- ⑤ Manufacturer
- ⑥ Tire ply material (▷ page 321)
- ⑦ Tire size designation, load and speed rating (▷ page 312)
- ⑧ Load identification (▷ page 316)
- ⑨ Tire name

i For illustration purposes only. Actual data on tires is specific to each vehicle and may vary from data shown in above illustration.

For more information, see "Rims and tires" (▷ page 422).

Tire size designation, load and speed rating

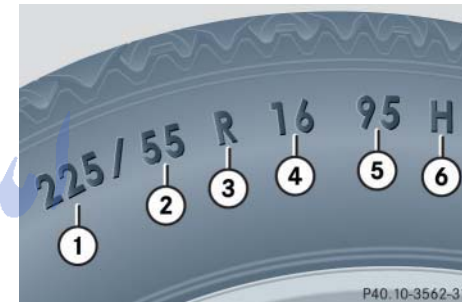

- ① Tire width
- ② Aspect ratio in %
- ③ Radial tire code
- ④ Rim diameter
- ⑤ Tire load rating
- ⑥ Tire speed rating



For illustration purposes only. Actual data on tires is specific to each vehicle and may vary from data shown in above illustration.

General:

Depending on the design standards used, the tire size molded into the sidewall may have no letter or a letter preceding the tire size designation.

No letter preceding the size designation (as illustrated above): Passenger car tire based on European design standards.

Letter “P” preceding the size designation: Passenger car tire based on U.S. design standards.

Letter “LT” preceding the size designation: Light Truck tire based on U.S. design standards.

Letter “T” preceding the size designation: Temporary spare tires which are high pressure compact spares designed for temporary emergency use only.

Tire width

The tire width ① (▷ page 312) indicates the nominal tire width in mm.

Aspect ratio

The aspect ratio ② (▷ page 312) is the dimensional relationship between tire section height and section width and is expressed in percentage. The aspect ratio is arrived at by dividing section height by section width.

Tire code

The tire code ③ (▷ page 312) indicates the tire construction type. The “R” stands for radial tire type. Letter “D” means diagonal or bias ply construction; letter “B” means belted-bias ply construction.

At the tire manufacturer's option, any tire with a speed capability above 149 mph (240 km/h) can include a “ZR” in the size designation (for example: 245/40 ZR 18). For additional information, see “Tire speed rating” (▷ page 314).

Rim diameter

The rim diameter ④ (▷ page 312) is the diameter of the bead seat, not the diameter of the rim edge. Rim diameter is indicated in inches (in).

Tire load rating

The tire load rating ⑤ (▷ page 312) is a numerical code associated with the maximum load a tire can support.

For example, a load rating of 91 corresponds to a maximum load of 1356 lbs (615 kg) the tire is designed to support. See also “Maximum tire load” (▷ page 318) where the maximum load associated with the load index is indicated in kilograms and lbs.

Operation

Tires and wheels

Warning



The tire load rating must always be at least half of the GAWR (▷ page 322) of your vehicle. Otherwise, tire failure may be the result which may cause an accident and/or serious personal injury to you or others.

Always replace rims and tires with the same designation, manufacturer and type as shown on the original part.

Warning!



Do not overload the tires by exceeding the specified load limit or vehicle capacity weight as indicated on the placard located on the driver's door B-pillar. Overloading the tires can overheat them, possibly causing a blowout. Overloading the tires can also result in handling or steering problems, or brake failure.

For additional information on tire load rating, see “Load identification” (▷ page 316).



Tire load rating ⑤ (▷ page 312) and Tire speed rating ⑥ (▷ page 312) are also referred to as “service description”.

Tire speed rating

The tire speed rating ⑥ (▷ page 312) indicates the approved maximum speed for the tire.

Warning!



Even when permitted by law, never operate a vehicle at speeds greater than the maximum speed rating of the tires.

Exceeding the maximum speed for which tires are rated can lead to sudden tire failure, causing loss of vehicle control and possibly resulting in an accident and/or personal injury and possible death, for you and for others.



Tire load rating ⑤ (▷ page 312) and Tire speed rating ⑥ (▷ page 312) are also referred to as “service description”.

Summer tires

Index	Speed rating
Q	up to 100 mph (160 km/h)
R	up to 106 mph (170 km/h)
S	up to 112 mph (180 km/h)
T	up to 118 mph (190 km/h)
H	up to 130 mph (210 km/h)
V	up to 149 mph (240 km/h)
W	up to 168 mph (270 km/h)
Y	up to 186 mph (300 km/h)
(Y)	above 186 mph (300 km/h)
ZR	above 149 mph (240 km/h)

- At the tire manufacturer's option, any tire with a speed capability above 149 mph (240 km/h) can include a "ZR" in the size designation (for example: 245/40 ZR18). To determine the maximum speed capability of the tire, the service description for the tire must be referred to. The service description

is comprised of the tire load rating ⑤ (▷ page 312) and the tire speed rating ⑥ (▷ page 312).

If your tire includes "ZR" in the size designation and no service description ⑤ and ⑥ (▷ page 312) is given, the tire manufacturer must be consulted for the maximum speed capability.

If a service description ⑤ and ⑥ (▷ page 312) is given, the speed capability is limited by the speed symbol in the service description.

Example: 245/40 ZR18 97Y. تلفن شبانه روزی ۰۲۱-۸۸۸۸۸۸۸۸

In this example, "97Y" is the service description. The letter "Y" designates the speed rating and the speed capability of the tire is limited to 186 mph (300 km/h).

- Any tire with a speed capability above 186 mph (300 km/h) must include a "ZR" in the size designation AND the service description must be placed in parenthesis. Example: 275/40 ZR 18 (99Y). The "(Y)" speed rating in parenthesis designates the maximum speed capability of the tire as being above 186 mph (300 km/h). Consult the tire manufacturer for the actual maximum permissible speed of the tire.

Operation

Tires and wheels

All-season and winter tires

Index	Speed rating
Q M+S	up to 100 mph (160 km/h)
T M+S	up to 118 mph (190 km/h)
H M+S	up to 130 mph (210 km/h)
V M+S	up to 149 mph (240 km/h)



The marking “M+S” next to the service description designates tires with mud and snow capabilities.

Load identification



① Load identification



For illustration purposes only. Actual data on tires is specific to each vehicle and may vary from data shown in above illustration.

In addition to tire load rating, special load information may be molded into the tire sidewall following the letter designating the tire speed rating ① (▷ page 316).

No specification given: absence of any text (like in above example) indicates a standard load (SL) tire.

XL (Extra Load): designates an extra load (or reinforced) tire.

Light Load: designates a light load tire.

C, D, E: designates load range associated with the maximum load a tire can carry at a specified pressure.

DOT, Tire Identification Number (TIN)

U.S. tire regulations require each new tire manufacturer or tire retreader to mold a TIN into or onto a sidewall of each tire produced.

The TIN is a unique identifier which facilitates efforts by tire manufacturers to notify purchasers in recall situations or other safety matters concerning tires and gives purchasers the means to easily identify such tires.

The TIN is comprised of “Manufacturer’s identification mark”, “Tire size”, “Tire type code” and “Date of manufacture”.



- ① DOT
- ② Manufacturer’s identification mark
- ③ Tire size
- ④ Tire type code (at the option of the tire manufacturer)
- ⑤ Date of manufacture



For illustration purposes only. Actual data on tires is specific to each vehicle and may vary from data shown in above illustration.

DOT (Department of Transportation)

A tire branding symbol ① (▷ page 317) which denotes the tire meets requirements of the U.S. Department of Transportation.

Manufacturer’s identification mark

The manufacturer’s identification mark ② (▷ page 317) denotes the tire manufacturer.

New tires have a mark with two symbols.

Retreaded tires have a mark with four symbols. For more information on retreaded tires, see (▷ page 296).

Tire size

The code ③ (▷ page 317) indicates the tire size.

Operation

Tires and wheels

Tire type code

The code ④ (▷ page 317) may, at the option of the manufacturer, be used as a descriptive code for identifying significant characteristics of the tire.

Date of manufacture

The date of manufacture ⑤ (▷ page 317) identifies the week and year of manufacture.

The first two figures identify the week, starting with "01" to represent the first full week of the calendar year. The second two figures represent the year.

For example, "3202" represents the 32nd week of 2002.

Maximum tire load

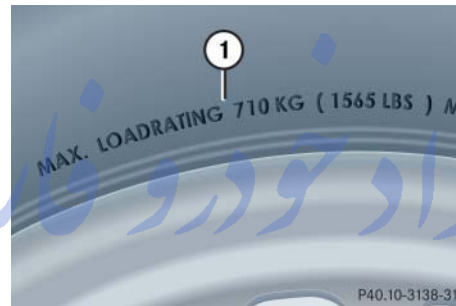

① Maximum tire load rating

For illustration purposes only. Actual data on tires is specific to each vehicle and may vary from data shown in above illustration.

The maximum tire load is the maximum weight the tires are designed to support.

Warning!



Do not overload the tires by exceeding the specified load limit or vehicle capacity weight as indicated on the placard located on the driver's door B-pillar. Overloading the tires can overheat them, possibly causing a blowout. Overloading the tires can also result in handling or steering problems, or brake failure.

For more information on tire load rating (▷ page 313).

For information on calculating total and cargo load capacities (▷ page 302).

Maximum tire inflation pressure

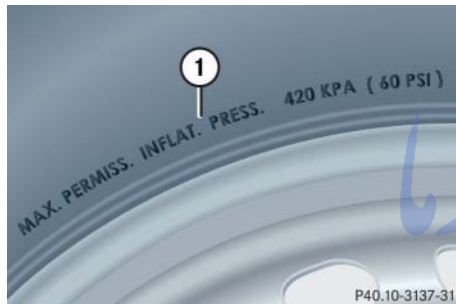

- ① Maximum permissible tire inflation pressure



For illustration purposes only. Actual data on tires is specific to each vehicle and may vary from data shown in above illustration.

This is the maximum permissible tire inflation pressure for the tire.

Always follow the recommended tire inflation pressure (▷ page 305) for proper tire inflation.

Warning!



Never exceed the max. tire inflation pressure. Follow recommended tire inflation pressures.

Do not underinflate tires. Underinflated tires wear excessively and / or unevenly, adversely affect handling and fuel economy, and are more likely to fail from being overheated.

Do not overinflate tires. Overinflated tires can adversely affect handling and ride comfort, wear unevenly, increase stopping distance, and result in sudden deflation (blowout) because they are more likely to become punctured or damaged by road debris, potholes etc.

Uniform Tire Quality Grading Standards (U.S. vehicles)

Tire manufacturers are required to grade tires based on three performance factors: treadwear, traction and temperature resistance.

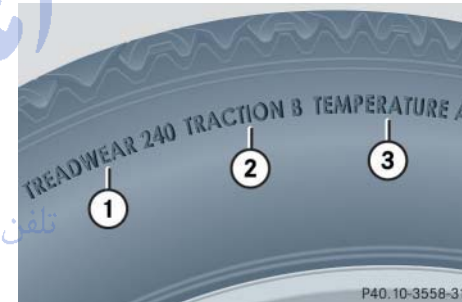

- ① Treadwear
- ② Traction
- ③ Temperature resistance



For illustration purposes only. Actual data on tires is specific to each vehicle and may vary from data shown in above illustration.

Operation

Tires and wheels

Quality grades can be found, where applicable, on the tire sidewall between tread shoulder and maximum section width. For example:

Treadwear	Traction	Temperature
200	AA	A

All passenger car tires must conform to federal safety requirements in addition to these grades.

Treadwear

The treadwear grade is a comparative rating based on the wear rate of the tire when tested under controlled conditions on a specified government test course. For example, a tire graded 150 would wear one and one-half ($1\frac{1}{2}$) times as well on the government course as a tire graded 100. The relative performance of tires depends upon the actual conditions of their use, however, and may depart significantly from the norm due to variations in driving habits, service practices and differences in road characteristics and climate.

Traction

The traction grades, from highest to lowest, are AA, A, B, and C. Those grades represent the tire's ability to stop on wet pavement as measured under controlled conditions on specified government test surfaces of asphalt and concrete. A tire marked C may have poor traction performance.

Warning!



The traction grade assigned to this tire is based on straight-ahead braking traction tests, and does not include acceleration, cornering, hydroplaning, or peak traction characteristics.

FarmaSOS.com

Temperature

The temperature grades are A (the highest), B, and C, representing the tire's resistance to the generation of heat and its ability to dissipate heat when tested under controlled conditions on a specified indoor laboratory test wheel. Sustained high temperature can cause the material of the tire to degenerate and reduce tire life, and excessive temperature can lead to sudden tire failure. The grade C corresponds to a level of performance which all passenger car tires must meet under the Federal Motor Vehicle Safety Standard No. 109. Grades B and A represent higher levels of performance on the laboratory test wheel than the minimum required by law.

Warning!



The temperature grade for this tire is established for a tire that is properly inflated and not overloaded. Excessive speed, underinflation, or excessive loading, either separately or in combination, can cause excessive heat build-up and possible tire failure.

Tire ply material

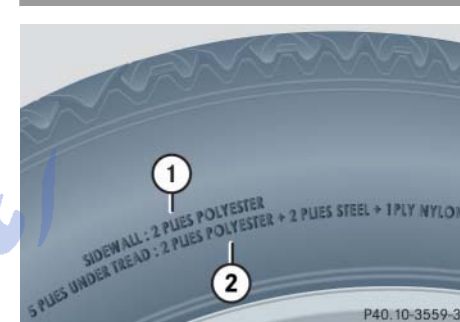

- ① Plies in sidewall
- ② Plies under tread



For illustration purposes only. Actual data on tires is specific to each vehicle and may vary from data shown in above illustration.

This marking tells you about the type of cord and number of plies in the sidewall and under the tread.

Operation

Tires and wheels

Tire and loading terminology

Accessory weight

The combined weight (in excess of those standard items which may be replaced) of automatic transmission, power steering, power brakes, power windows, power seats, radio, and heater, to the extent that these items are available as factory-installed equipment (whether installed or not).

Air pressure

The amount of air inside the tire pressing outward on each square inch of the tire. Air pressure is expressed in pounds per square inch (psi), or kilopascal (kPa) or bars.

Aspect ratio

Dimensional relationship between tire section height and section width expressed in percentage.

Bar

Another metric unit for air pressure. There are 14.5038 pounds per square inch (psi) to 1 bar; there are 100 kilopascals (kPa) to 1 bar.

Bead

The tire bead contains steel wires wrapped by steel cords that hold the tire onto the rim.

Cold tire inflation pressure

Tire inflation pressure when your vehicle has been sitting for at least three hours or driven no more than one mile (1.6 km).

Curb weight

The weight of a motor vehicle with standard equipment including the maximum capacity of fuel, oil, and coolant, and, if so equipped, air conditioning and additional optional equipment, but without passengers and cargo.

DOT (Department of Transportation)

A tire branding symbol which denotes the tire meets requirements of the U.S. Department of Transportation.

GAWR (Gross Axle Weight Rating)

The GAWR is the maximum permissible axle weight. The gross vehicle weight on each axle must never exceed the GAWR for the front and rear axle indicated on the Certification label located on the driver's door B-pillar.

GVW (Gross Vehicle Weight)

The GVW comprises the weight of the vehicle including fuel, tools, spare wheel, installed accessories, passengers and cargo and, if applicable, trailer tongue load. The GVW must never exceed the GVWR indicated on the Certification label located on the driver's door B-pillar.

GVWR (Gross Vehicle Weight Rating)

This is the maximum permissible vehicle weight of the fully loaded vehicle (weight of the vehicle including all options, passengers, fuel, and cargo and, if applicable, trailer tongue load). It is indicated on Certification label located on the driver's door B-pillar.

Kilopascal (kPa)

The metric unit for air pressure. There are 6.9 kPa to one psi; another metric unit for air pressure is bars. There are 100 kilopascals (kPa) to one bar.

Maximum load rating

The maximum load in kilograms and pounds that can be carried by the tire.

Maximum loaded vehicle weight

The sum of curb weight, accessory weight, vehicle capacity weight and production options weight.

Maximum tire inflation pressure

This number is the greatest amount of air pressure that should ever be put in the tire under normal driving conditions.

Normal occupant weight

The number of occupants the vehicle is designed to seat, multiplied by 68 kilograms (150 lbs).

Occupant distribution

The distribution of occupants in a vehicle at their designated seating positions.

Production options weight

The combined weight of those installed regular production options weighing over 5 lbs (2.3 kilograms) in excess of those standard items which they replace, not previously considered in curb weight or accessory weight, including heavy duty brakes, ride levelers, roof rack, heavy duty battery, and special trim.

PSI (Pounds per square inch)

A standard unit of measure for air pressure -> bar, kilopascal (kPa).

Recommended tire inflation pressure

Recommended tire inflation pressure listed on placard located on driver's door B-pillar for normal driving conditions. Provides best handling, tread life and riding comfort.

Rim

A metal support for a tire or a tire and tube assembly upon which the tire beads are seated.

Sidewall

The portion of a tire between the tread and the bead.

Operation

Tires and wheels

TIN (Tire Identification Number)

Unique identifier which facilitates efforts by tire manufacturers to notify purchasers in recall situations or other safety matters concerning tires and gives purchasers the means to easily identify such tires. The TIN is comprised of "Manufacturer's identification mark", "Tire size", "Tire type code" and "Date of manufacture".

Tire load rating

Numerical code associated with the maximum load a tire can support.

Tire ply composition and material used

This indicates the number of plies or the number of layers of rubber-coated fabric in the tire tread and sidewall. Tire manufacturers also must indicate the ply materials in the tire and sidewall, which include steel, nylon, polyester, and others.

Tire speed rating

Part of tire designation; indicates the speed range for which a tire is approved.

Traction

Force exerted by the vehicle on the road via the tires. The amount of grip provided.

Tread

The portion of a tire that comes into contact with the road.

Treadwear indicators

Narrow bands, sometimes called "wear bars" that show across the tread of a tire when only $\frac{1}{6}$ in (1.6 mm) of tread remains.

Uniform Tire Quality Grading Standards

A tire information system that provides consumers with ratings for a tire's traction, temperature and treadwear. Ratings are determined by tire manufacturers using government testing procedures. The ratings are molded into the sidewall of the tire.

Vehicle capacity weight

Rated cargo and luggage load plus 68 kilograms (150 lbs) times the vehicle's designated seating capacity.

Vehicle maximum load on the tire

Load on an individual tire that is determined by distributing to each axle its share of the maximum loaded vehicle weight and dividing it by two.

Rotating tires

Warning!



Rotate front and rear wheels only if the tires are of the same dimension.

If your vehicle is equipped with mixed-size tires (different tire dimensions front vs. rear), tire rotation is not possible.

Tire rotation can be performed on vehicles with tires of the same dimension all around. If your vehicle is equipped with tires of the same dimension all around, tires can be rotated, observing a front-to-rear rotation pattern that will maintain the intended rotation (spinning) direction of the tire (▷ page 299).

In some cases, such as when your vehicle is equipped with mixed-size tires (different tire dimension front vs. rear), tire rotation is not possible.

If applicable to your vehicle's tire configuration, tires can be rotated according to the tire manufacturer's recommended intervals in the tire manufacturer's warranty pamphlet located in your vehicle literature portfolio. If none is available, tires should be rotated every 3000 to 6000 miles (5000 to 10000 km), or sooner if necessary, according to the degree of tire wear. The same rotation (spinning) direction must be maintained (▷ page 299).

Rotate tires before the characteristic tire wear pattern becomes visible (shoulder wear on front tires and tread center wear on rear tires).

Thoroughly clean the mounting face of wheels and brake disks, i.e. the inner side of the wheels/tires, during each rotation. Check for and ensure proper tire inflation pressure.

Warning!



Have the tightening torque checked after changing a wheel. Wheels could become loose if not tightened with a torque of 110 lb-ft (150 Nm).

Only use genuine Mercedes-Benz wheel bolts specified for your vehicle's rims.

For information on wheel change, see the "Practical hints" section (▷ page 398).

Operation

Winter driving

Before the onset of winter, have your vehicle winterized at an authorized Mercedes-Benz Center. This service includes:

- Check of anticorrosion and antifreeze concentration.
- Addition of cleaning concentrate to the water of the windshield and headlamp cleaning system. Add MB Concentrate "S" to a premixed windshield washer solvent/antifreeze which is formulated for below freezing temperatures (▷ page 434).
- Battery test. Battery capacity drops with decreasing ambient temperature. A well charged battery helps to make sure that the engine can be started, even at low ambient temperatures.
- Tire change. Mercedes-Benz recommends M+S rated radial-ply tires with a minimum tread depth of approximately $\frac{1}{6}$ in (4 mm) on all four wheels for the winter season.

Winter tires

Always use winter tires at temperatures below 45°F (7°C) and whenever wintry road conditions prevail. Use of winter tires is the only way to achieve the maximum effectiveness of the ABS, ESP and 4MATIC in winter operation.

For safe handling, make sure that all mounted winter tires are of the same make and have the same tread design.

Warning!



Winter tires with a tread depth under $\frac{1}{6}$ in (4 mm) must be replaced. They are no longer suitable for winter operation.

Always observe the speed rating of the winter tires installed on your vehicle. If the maximum speed for which your tires are rated is below the speed rating of your vehicle, you must place a notice to this effect where it will be seen by the driver. Such notices are available from your tire dealer or from any authorized Mercedes-Benz Center.

Warning!



If you use your spare tire when winter tires are fitted on the other wheels, be aware that the difference in tire characteristics may very well impair turning stability and that overall driving stability may be reduced. Adapt your driving style accordingly.

Have the spare tire replaced with a winter tire at the nearest authorized Mercedes-Benz Center.

Block heater (Canada only)

The engine is equipped with a block heater.

The electrical cable may be installed at an authorized Mercedes-Benz Center.

Snow chains

Snow chains should only be driven on snow-covered roads at speeds not to exceed 30 mph (50 km/h). Remove chains as soon as possible when driving on roads without snow.



When driving with snow chains, you may wish to deactivate the ESP (▷ page 83) before setting the vehicle in motion. This will improve the vehicle's traction.

Please observe the following guidelines when using snow chains:

- Use of snow chains is not permissible with all wheel/tire combinations.
- Snow chains should only be used on the rear wheels. Follow the manufacturer's mounting instructions.
- Only use snow chains that are approved by Mercedes-Benz. Your authorized Mercedes-Benz Center will be glad to advise you on this subject.
- Use of snow chains may be prohibited depending on location. Always check local and state laws before installing snow chains.



Even on vehicles with all-wheel-drive use snow chains on rear tires only.

Use of snow chains is not permissible with tire sizes:

- 245/45 R18 100V XL (Extra Load) M+S on 8¹/₂ x 18 rims
- 245/45 R18 96H M+S on 8¹/₂ x 18 rims
- 245/45 R18 100Y XL (Extra Load) on 8¹/₂ x 18 rims
- 245/45 R18 96Y on 8¹/₂ x 18 rims
- 265/40 R18 101Y XL (Extra Load)
- 265/40 R18 97Y

Operation

Maintenance

We strongly recommend that you have your vehicle serviced by an authorized Mercedes-Benz Center, in accordance with the Maintenance Booklet at the times called for by the maintenance service indicator display.

Failure to have the vehicle maintained in accordance with the Maintenance Booklet and maintenance service indicator at the designated times /mileage will result in vehicle damage not covered by the Mercedes-Benz Limited Warranty.

The maintenance service indicator will notify you when your next maintenance service is due.

Starting approximately one month before your next maintenance service is due, one of the following messages will appear in the multifunction display while you are driving or when you switch on the ignition (example service A):

'A' SERVICE IN XXXXX MILES (KM)
'A' SERVICE IN XXX DAYS
'A' SERVICE IN X DAY
'A' SERVICE DUE NOW



The type of maintenance service due is indicated in the multifunction display:



Basic service (A)



Extended service (B)



Vehicles equipped with FSS (Flexible Service System) only (Canada vehicles):

The interval between services depends on your driving habits. A gentle driving style, moderate engine speeds and the avoidance of short-distance trips will lengthen the interval between services.

Clearing the maintenance service indicator

The maintenance service indicator is automatically cleared after 30 seconds when you switch on the ignition or when reaching the maintenance service threshold while driving. You can also clear it yourself.

▶ Press the reset button **R** in the instrument cluster (▷ page 140).

Maintenance service term exceeded

If you have exceeded the suggested maintenance service term, you will see the following message in the multifunction display:

'A' SERVICE EXCEEDED
BY XXXX MILES (KM)
'A' SERVICE EXCEEDED BY XXX DAYS
'A' SERVICE EXCEEDED BY X DAY





In addition, a signal sounds when the message appears.

Any authorized Mercedes-Benz Center will reset the maintenance service indicator following a completed maintenance service.

Calling up the maintenance service indicator

- ▶ Switch on ignition.

The standard display of the control system appears (▷ page 148).

- ▶ Press button  or  on the multifunction steering wheel until the maintenance service indicator with the service symbol  or  and the service deadline appears in the multifunction display.

 If the battery is disconnected, the days of disconnection will not be included in the count shown by the maintenance service indicator. To arrive at the true maintenance service deadline, you will need to subtract these days from the days shown in the maintenance service indicator.

Do not confuse the maintenance service indicator with the engine oil level indicator .

Resetting the maintenance service indicator

In the event that the maintenance service on your vehicle is not carried out by an authorized Mercedes-Benz Center, you can

have the maintenance service indicator reset. The automotive maintenance facility carrying out the maintenance service will find the information for resetting the maintenance service indicator in the maintenance-relevant information for your vehicle. Such information is available from either your authorized Mercedes-Benz Center or directly from Mercedes-Benz USA, LLC.

 If the maintenance service indicator was inadvertently reset, have an authorized Mercedes-Benz Center correct it.

Only reset if the proper maintenance service has been performed. Resetting the system without performing the proper service as called for by the maintenance service indicator will result in engine damage and/or other vehicle damage not covered by the Mercedes-Benz Limited Warranty.

Operation

Vehicle care

Cleaning and care of vehicle

Warning!



Many cleaning products can be hazardous. Some are poisonous, others are flammable. Always follow the instructions on the particular container. Always open your vehicle's doors or windows when cleaning the inside.

Never use fluids or solvents that are not designed for cleaning your vehicle.

In operation, even while parked, your vehicle is subjected to varying external influences which, if gone unchecked, can attack the paintwork as well as the underbody and cause lasting damage.

Such damage is caused not only by extreme and varying climatic conditions, but also by:

- Air pollution
- Road salt
- Tar
- Gravel and stone chipping

To avoid paint damage, you should immediately remove:

- Grease and oil
- Fuel
- Coolant
- Brake fluid
- Bird droppings
- Insects
- Tree resins, etc.

Frequent washing reduces and/or eliminates the aggressiveness and potency of the above adverse influences.

More frequent washings are necessary to deal with unfavorable conditions:

- near the ocean
- in industrial areas (smoke, exhaust emissions)
- during winter operation

You should check your vehicle from time to time for stone chipping or other damage. Any damage should be repaired as soon as possible to prevent corrosion.

In doing so, do not neglect the underbody of the vehicle. A prerequisite for a thorough check is a washing of the underbody followed by a thorough inspection. Damaged areas need to be re-undercoated. Your vehicle has been treated at the factory with a wax-base rustproofing in the body cavities which will last for the lifetime of the vehicle. Post-production treatment is neither necessary nor recommended by Mercedes-Benz because of the possibility of incompatibility between materials used in the production process and others applied later.

We have selected car-care products and compiled recommendations which are specially matched to our vehicles and which always reflect the latest technology. You can obtain Mercedes-Benz approved car-care products at an authorized Mercedes-Benz Center.

Scratches, corrosive deposits, corrosion or damage due to negligent or incorrect care cannot always be removed or repaired with the car-care products recommended here. In such cases it is best to seek aid at an authorized Mercedes-Benz Center.

The following topics deal with the cleaning and care of your vehicle and give important “how-to” information as well as references to Mercedes-Benz approved car-care products.

Power-wash

When using a power-wash for cleaning the vehicle, always observe the manufacturer's operating instructions.



Vehicles with KEYLESS-GO*:

If a door handle is hit by a strong jet of water, and a SmartKey with KEYLESS-GO* is in close proximity, i.e. within approx. 3 ft. (approx. 1 m), the vehicle could be inadvertently locked or unlocked.



Never use a round nozzle to power-wash tires. The intense jet of water can result in damage to the tire. Always replace a damaged tire.

Always keep the jet of water moving across the surface. Do not aim directly at electrical parts, electrical connectors, seals, or other rubber parts.

Tar stains

Quickly remove tar stains before they dry and become more difficult to remove. A tar remover is recommended.

Paintwork, painted body components

Mercedes-Benz approved Paint Care should be applied when water drops on the paint surface do not “bead up”, normally every three to five months, depending on climate and washing detergent used.

Mercedes-Benz approved Paint Cleaner should be applied if the paint surface shows signs of embedded dirt (i.e. loss of gloss).

Do not apply any of these products or wax if your vehicle is parked in the sun or if the hood is still hot.

Use the appropriate MB-Touch-Up Stick for quick and provisional repairs of minor paint damage (i.e. chips from stones, vehicle doors, etc.).

Operation

Vehicle care

Engine cleaning

Prior to cleaning the engine compartment make sure to protect electrical components and connectors from the intrusion of water and cleaning agents.

Corrosion protection, such as MB Anticorrosion Wax should be applied to the engine compartment after every engine cleaning. Before applying, all control linkage bushings and joints should be lubricated. The poly-V-belt and all pulleys should be protected from any wax.

Vehicle washing

Do not use hot water or wash your vehicle in direct sunlight. Only use a mild car wash detergent, such as Mercedes-Benz approved Car Shampoo.

Thoroughly spray the vehicle with a diffused jet of water. Direct only a very weak spray towards the ventilation intake. Use plenty of water and rinse the sponge and chamois frequently.

Rinse with clear water and thoroughly dry with a chamois. Do not allow cleaning agents to dry on the finish.

Due to the width of the vehicle, fold in exterior rear view mirrors prior to running the vehicle through an automatic car wash to prevent damage to the mirrors.

In the winter, thoroughly remove all traces of road salt as soon as possible.

When washing the underbody, do not forget to clean the inner sides of the wheels.



Vehicles with KEYLESS-GO*:

If a door handle is hit by a strong jet of water, and a SmartKey with KEYLESS-GO* is in close proximity, i.e. within approx. 3 ft. (approx. 1 m), the vehicle could be inadvertently locked or unlocked.

Ornamental moldings

For regular cleaning and care of very dirty chrome-plated parts, use a chrome cleaner.

Headlamps, tail lamps, side markers, turn signal lenses

▶ Use a mild car wash detergent, such as Mercedes-Benz approved Car Shampoo, with plenty of water.

To prevent scratches, never apply strong force and use only a soft, non-scratchy cloth when cleaning the lenses. Do not attempt to wipe dirty lenses with a dry cloth or sponge.

Cleaning the DISTRONIC* system sensor cover



① DISTRONIC system sensor cover

- ▶ Use a mild car wash detergent, such as Mercedes-Benz approved Car Shampoo, with plenty of water to clean sensor cover ①.

To prevent scratches, never apply strong force and use only a soft, non-scratchy cloth when cleaning the sensor cover. Do not attempt to wipe dirty sensors with a dry cloth or sponge.

Cleaning the Parktronic* system sensors

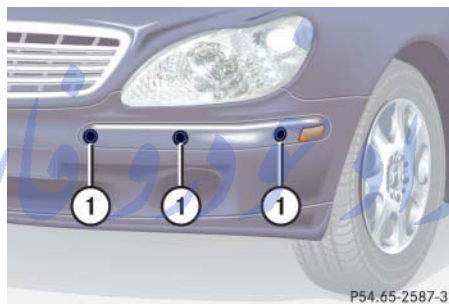

① Parktronic system sensors

- ▶ Clean the sensors ① on the bumpers using a mild car wash detergent, such as Mercedes-Benz approved Car Shampoo, with plenty of water and a soft, non-scratchy cloth.

When using a steam cleaner or power washer, aim nozzle only briefly from a minimum distance of 12 in (30 cm) at sensors ①.

Do not apply strong pressure to the sensor cover, applying strong pressure may damage the sensor cover.

To prevent scratches, never apply strong force and only use a soft, non-scratchy cloth when cleaning the sensor. Do not attempt to wipe dirty sensors with a dry cloth or sponge.

Wiper blades



The windshield wipers must be in a vertical position before folding them away from the windshield. They could otherwise damage the hood.

- ▶ Turn on the wipers and place it in a vertical position.

For information on placing the wipers to a vertical position, see "Replacing wiper blades" (▷ page 396).

Operation

Vehicle care

Warning!



For safety reasons, switch off wipers and remove SmartKey from starter switch (vehicles with KEYLESS-GO*): Make sure the vehicle's on-board electronics have status **0** before cleaning the wiper blades. Otherwise, the wiper motor could suddenly turn on and cause injury.

- ▶ Clean the wiper blade inserts with a clean cloth and detergent solution.



Fold the windshield wiper arms back onto the windshield before turning the SmartKey in the starter switch.

Hold on to the wiper when folding the wiper arm back. If released, the force of the impact from the tensioning spring could crack the windshield.

Window cleaning



The windshield wipers must be in a vertical position before folding them away from the windshield. They could otherwise damage the hood.

- ▶ Turn on the wipers and place it in a vertical position.

For information how to place the wipers in a vertical position, see "Replacing wiper blades" (▶ page 396).

Warning!



For safety reasons, switch off wipers and remove SmartKey from starter switch (vehicles with KEYLESS-GO*): Make sure the vehicle's on-board electronics have status **0** before cleaning the wiper blades. Otherwise, the wiper motor could suddenly turn on and cause injury.

- ▶ Use a window cleaning solution on all glass surfaces.

An automotive glass cleaner is recommended.



Fold the windshield wiper arms back onto the windshield before turning the SmartKey in the starter switch.

Hold on to the wiper when folding the wiper arm back. If released, the force of the impact from the tensioning spring could crack the windshield.

Light alloy wheels

Mercedes-Benz approved Wheel Care should be used for regular cleaning of the light alloy wheels.

If possible, clean wheels once a week with Mercedes-Benz approved Wheel Care, using a soft bristle brush and a strong spray of water.

Follow the instructions on container.



Only use acid-free cleaning materials. Acid may cause corrosion or damage the clear coat.

Instrument cluster

Use a gentle dishwashing detergent or mild detergent for delicate fabrics as a washing solution. Wipe with a cloth moistened in lukewarm solution. Do not use scouring agents.

Steering wheel and gear selector lever

Wipe with a damp cloth and dry thoroughly or clean with Mercedes-Benz approved Leather Care.

Cup holder

Use a gentle dishwashing detergent or mild detergent for delicate fabrics as a washing solution. Wipe with a cloth moistened in lukewarm solution. Do not use scouring agents.

Hard plastic trim items

Pour Mercedes-Benz approved Interior Care onto soft lint-free cloth and apply with light pressure.

Headliner and shelf below rear window

Clean with soft bristle brush, or use a dry-shampoo cleaner in case of excessive dirt.

Seat belts

The webbing must not be treated with chemical cleaning agents. Only use clear, lukewarm water and soap. Do not dry the webbing at temperatures above 176°F (80°C) or in direct sunlight.

Warning!



Do not bleach or dye seat belts as this may severely weaken them. In a crash they may not be able to provide adequate protection.

Operation

Vehicle care

Upholstery

Using aftermarket seat covers or wearing clothing that have the tendency to give off coloring (e.g. when wet, etc.) may cause the upholstery to become permanently discolored. By lining the seats with a proper intermediate cover, contact-discoloration will be prevented.

Leather upholstery

Wipe leather upholstery with a damp cloth and dry thoroughly or clean with Mercedes-Benz approved Leather Care. Exercise particular care when cleaning perforated leather as its underside should not become wet.

Nubuck leather upholstery (S 55 AMG)

The nubuck leather upholstery is treated with a protective coating. Wipe nubuck leather upholstery with damp microfiber cloth to remove dust and other light stains. Carefully dab nubuck leather upholstery with a dry microfiber cloth to remove oil stains.



Do not use Mercedes-Benz approved Leather Care or any solvents to clean nubuck leather upholstery.

Avoid hard scrubbing on nubuck leather upholstery.

Plastic and rubber parts

Do not use oil or wax on these parts.

Wood trims

Dampen cloth using water and use damp cloth to clean wood trims in your vehicle. Do not use solvents like tar remover or wheel cleaner nor polishes or waxes as these may be abrasive.

FarmaSOS.com

Practical hints

What to do if ...?

Where will I find ...?

Unlocking/locking in an emergency

Opening/closing in an emergency

Replacing SmartKey batteries

Replacing bulbs

Replacing wiper blades

Flat tire

Battery

Jump starting

Towing the vehicle

Fuses

امداد خودرو فارما



FarmaSOS.com

تلفن شبانه روزی: ۰۲۱-۸۸۶۲۰۸۵

Practical hints

What to do if ...?

Lamps in instrument cluster

General information:

If any of the following lamps in the instrument cluster fails to come on during the bulb self-check when switching on the

ignition, have the respective bulb checked and replaced if necessary.

Problem	Possible cause	Suggested solution
 The yellow ABS malfunction indicator lamp comes on while driving.	<p>The ABS has detected a malfunction and has switched off. The BAS and the ESP are also switched off (see messages in multifunction display).</p> <p>The brake system is still functioning normally but without the ABS available.</p> <p>If the ABS control unit is malfunctioning, other systems such as Parktronic*, Distronic*, and the automatic transmission may also be malfunctioning.</p> <p>The charging voltage has fallen below 10 volts and the ABS has switched off. The battery may not be charged sufficiently.</p>	<ul style="list-style-type: none"> ▶ Continue driving with added caution. Wheels may lock during hard braking, reducing steering capability. ▶ Read and observe messages in the multifunction display (▷ page 347). ▶ Have the system checked at an authorized Mercedes-Benz Center as soon as possible. <p>Failure to follow these instructions increases the risk of an accident.</p> <ul style="list-style-type: none"> ▶ Switch off electrical consumers that are currently not needed, e.g. seat heating*. ▶ If necessary, have the generator (alternator) and battery checked. <p>When the voltage is above this value again, the ABS is operational again.</p>

Practical hints

What to do if ...?

Problem	Possible cause	Suggested solution
BRAKE (USA only)  (Canada only)	The red brake warning lamp comes on while driving and you hear a warning sound.	You are driving with the parking brake set. ▶ Release the parking brake (> page 48).
	The red brake warning lamp comes on while driving.	There is insufficient brake fluid in the reservoir. Risk of accident! ▶ Carefully stop the vehicle and notify an authorized Mercedes-Benz Center. Do not add brake fluid! This will not solve the problem.

Warning!



Driving with the brake warning lamp illuminated can result in an accident. Have your brake system checked immediately if the brake warning lamp stays on. Do not add brake fluid before checking the brake system. Overfilling the brake fluid reservoir can result in spilling brake fluid on hot engine parts and the brake fluid catching fire. You can be seriously burned.



If you find that the brake fluid in the brake fluid reservoir has fallen to the minimum mark or below, have the brake system checked for brake pad thickness and leaks.

FarmaSOS.com



Practical hints

What to do if ...?

Problem	Possible cause	Suggested solution
<p>CHECK ENGINE (USA only)</p>  <p>(Canada only)</p> <p>The yellow engine malfunction indicator lamp comes on while driving.</p>	<p>There is a malfunction in:</p> <ul style="list-style-type: none"> • The fuel management system • The ignition system • The emission control system • Systems which affect emissions <p>Such malfunctions may result in excessive emissions values and may switch the engine to its limp-home (emergency operation) mode.</p>	<p>► Have the vehicle checked as soon as possible by an authorized Mercedes-Benz Center. An on-board diagnostic connector is used by the service station to link the vehicle to the shop diagnostics system. It allows the accurate identification of system malfunctions through the read-out of diagnostic trouble codes. It is located in the front left area of the footwell next to the parking brake pedal.</p> <p>► After refuelling, start, turn off, and restart the engine three or four times in succession.</p> <p>The limp-home mode is canceled. You do not need to have your vehicle checked.</p>
	<p>Your fuel tank is empty.</p>	

Practical hints

What to do if ...?



Problem	Possible cause	Suggested solution
 (USA only)  (Canada only)	The yellow engine malfunction indicator lamp comes on while driving.	A loss of pressure has been detected in the fuel system. The fuel cap may not be closed properly or the fuel system may be leaky.
The yellow fuel tank reserve warning lamp comes on while driving.	The fuel level has gone below the reserve mark.	

تلفن شبانه روزی: ۰۲۱-۸۸۶۲۰۸۵

FarmaSOS.com



Practical hints

What to do if ...?

Problem	Possible cause	Suggested solution
 Only vehicles with DISTRONIC*: The red distance warning lamp comes on while driving.	You are too close to the vehicle in front of you to maintain selected speed.	<ul style="list-style-type: none"> ▶ Apply the brakes immediately to increase the following distance.
 Only vehicles with DISTRONIC*: The red distance warning lamp comes on while driving and you hear a warning sound.	<ul style="list-style-type: none"> • You are gaining too rapidly on the vehicle ahead of you. • The distance warning system has recognized a stationary obstacle on your probable line of travel. 	<ul style="list-style-type: none"> ▶ Apply the brakes immediately. ▶ Carefully observe the traffic situation. You may need to brake or maneuver to avoid hitting an obstacle.
 The yellow ESP warning lamp flashes while driving.	The ESP or traction control has come into operation because of detected traction loss in at least one tire. DISTRONIC* is deactivated.	<ul style="list-style-type: none"> ▶ When driving off, apply as little throttle as possible. ▶ While driving, ease up on the accelerator. ▶ Adapt your speed and driving to the prevailing road and weather conditions. ▶ Do not deactivate the ESP. Exceptions: (▷ page 83). <p>Failure to follow these instructions increases the risk of an accident.</p>

Practical hints

What to do if ...?

Problem	Possible cause	Suggested solution
 The yellow ESP warning lamp comes on while driving.	The ESP is deactivated.	Risk of accident! ▶ Switch the ESP back on (▷ page 84). ▶ Adapt your speed and driving to the prevailing road and weather conditions. If the ESP cannot be switched back on, have the system checked at an authorized Mercedes-Benz Center as soon as possible.
 The red seat belt telltale illuminates briefly after starting the engine.	The driver or the front passenger has not fastened his or her seat belt.	▶ Fasten your seat belt. The warning lamp goes out.

تلفن شبانه روزی: ۰۲۱-۸۸۸۶۲۰۸۵

FarmaSOS.com

Practical hints

What to do if ...?

Problem	Possible cause	Suggested solution
 The yellow warning lamp for the tire inflation pressure monitor comes on.	The tire inflation pressure monitor detects a loss of pressure in at least one tire.	<ul style="list-style-type: none">▶ Bring the vehicle to a halt, avoiding abrupt steering and braking maneuvers. Observe the traffic situation around you.▶ Take note of the messages in the multi-function display. <p>The warning lamp goes out once the tire inflation pressure monitor has been reactivated after the tire inflation pressures have been corrected.</p>

Warning!



When the tire inflation pressure monitoring system warning light is lit, one or more of your tires is significantly under-inflated. You should stop and check your tires as soon as possible, and inflate them to the proper pressure as indicated on the vehicle's tire information placard. Driving on a significantly under-inflated tire causes the tire to overheat and can lead to tire failure.

Under-inflation also reduces fuel efficiency and tire tread life, and may affect the vehicle's handling and stopping ability. Each tire, including the spare, should be checked monthly when cold and set to the recommended inflation pressure as specified in the vehicle placard and owner's manual.



The recommended tire inflation pressures for your vehicle can be found on the tire placard on the driver's door B-pillar or, if available, the inside of the fuel filler flap, not in the owner's manual.

Practical hints

What to do if ...?

Problem	Possible cause	Suggested solution
SRS The red SRS indicator lamp comes on while driving.	There is a malfunction in the restraint systems. The air bags or emergency tensioning devices (ETDs) could deploy unexpectedly or fail to activate in an accident.	► Drive with added caution to the nearest authorized Mercedes-Benz Center.

Warning!



In the event a malfunction of the SRS is indicated as outlined above, the SRS may not be operational. For your safety, we strongly recommend that you visit an authorized Mercedes-Benz Center immediately to have the system checked; otherwise the SRS may not be activated when needed in an accident, which could result in serious or fatal injury, or it might deploy unexpectedly and unnecessarily which could result in an accident and/or injury to you or to others.

امداد خودرو فارسیا

تلفن شبانه روزی: ۰۸۵ ۸۸۶۲۰۲۱

FarmaSOS.com

Practical hints

What to do if ...?

Lamp in center console

Lamp	Problem	Possible cause	Suggested solution
	The indicator lamp comes on.	A BabySmart ^{TM1} child seat is installed on the front passenger seat. Therefore the passenger front air bag is switched off.	
	The indicator lamp comes on if there is no BabySmart TM child seat installed on the front passenger seat.	The system is malfunctioning.	▶ Have the system checked as soon as possible by an authorized Mercedes-Benz Center.
	The indicator lamp does not come on with a BabySmart TM child seat properly installed on the front passenger seat.	The system is malfunctioning.	▶ Make sure there is nothing between seat cushion and child seat and check installation of the child seat. ▶ If the front passenger front air bag off indicator lamp remains out, have the system checked as soon as possible by an authorized Mercedes-Benz Center. ▶ Do not use the BabySmart TM restraint to transport children on the front passenger seat until the system has been repaired.

¹ BabySmartTM is a trademark of Siemens Automotive Corp.

Vehicle status messages in the multifunction display





Warning and malfunction messages appear in the multifunction display located in the instrument cluster.





Certain warning and malfunction messages are accompanied by an audible signal.

Address these messages accordingly and follow the additional instructions given in this Operator's Manual.

Selecting the vehicle status message memory menu in the control system (▷ page 143) displays both cleared and uncleared messages.

High-priority messages appear in the multifunction display in red color.

Certain messages of high priority cannot be cleared from the multifunction display using the reset button  (▷ page 140) or button , , , or  on the multifunction steering wheel (▷ page 144).

Other messages of high priority and messages of less immediate priority can be cleared from the multifunction display using the reset button  or button , , , or  on the multifunction steering wheel. They are then stored in the vehicle status message memory (▷ page 159). Remember that clearing a message will only make the message disappear. Clearing a message will not correct the condition that caused the message to appear.

Practical hints

What to do if ...?

Warning!



All categories of messages contain important information which should be taken note of and, where a malfunction is indicated, addressed as soon as possible at an authorized Mercedes-Benz Center.

Failure to repair condition noted may cause damage not covered by the Mercedes-Benz Limited Warranty, or result in property damage or personal injury.

Warning!



No messages will be displayed if either the instrument cluster or the multifunction display is inoperative. Contact your nearest authorized Mercedes-Benz Center.

Practical hints

What to do if ...?



Switching on the ignition causes all instrument cluster lamps (except high beam headlamp indicator lamp and turn signal indicator lamps unless activated) as well as the multifunction display to come on. Make sure the lamps and multifunction display are in working order before starting your journey.

On the pages that follow, you will find a compilation of the most important warning and malfunction messages that may appear in the malfunction display.

For your convenience the messages are divided into two sections:

- Text messages (▷ page 349)
- Symbol messages (▷ page 354)

تلفن شبانه روزی: ۰۲۱-۸۸۶۲۰۸۵

FarmaSOS.com

Text messages

Display	Possible cause	Possible solution
ABC ACTIVE BODY CONTROL DRIVE CAREFULLY!	The capability of the ABC system is restricted. This can impair the handling.	<ul style="list-style-type: none"> ▶ Do not exceed a speed of 50 mph (80 km/h). ▶ Visit an authorized Mercedes-Benz center as soon as possible.
	The vehicle is losing oil.	<ul style="list-style-type: none"> ▶ Stop your vehicle as soon as it is safe to do so.
ACTIVE BODY CONTROL STOP, CAR TOO LOW	The vehicle is parked on an extremely uneven surface.	<ul style="list-style-type: none"> ▶ Press the vehicle level control button to select level 2 (▷ page 232).
	ABC is malfunctioning.	<ul style="list-style-type: none"> ▶ Stop and press the vehicle level control button to select a higher vehicle level (▷ page 232). ▶ Do not turn steering wheel too far to avoid damaging the front fenders. ▶ Listen for scraping noises. ▶ Do not exceed a speed of 50 mph (80 km/h). ▶ Visit an authorized Mercedes-Benz center as soon as possible.
DISPLAY DEFECTIVE VISIT WORKSHOP	The display for ABC or the ABC system itself is malfunctioning.	<ul style="list-style-type: none"> ▶ Visit an authorized Mercedes-Benz Center as soon as possible.

Practical hints

What to do if ...?

Display	Possible cause	Possible solution
ABC ACTIVE BODY CONTROL VISIT WORKSHOP	The capability of the ABC system is restricted.	<ul style="list-style-type: none"> ▶ Do not exceed a speed of 50 mph (80 km/h). ▶ Visit an authorized Mercedes-Benz center as soon as possible.
ABS MALFUNCTION VISIT WORKSHOP	<p>The ABS has detected a malfunction and has switched off. The ESP and the BAS are also deactivated.</p> <p>The brake system is still functioning normally but without the ABS available.</p>	<ul style="list-style-type: none"> ▶ Continue driving with added caution. Wheels may lock during hard braking, reducing steering capability. ▶ Have the system checked at an authorized Mercedes-Benz Center as soon as possible. <p>Failure to follow these instructions increases the risk of an accident.</p>
DISPLAY DEFECTIVE VISIT WORKSHOP	The ABS or the ABS display is malfunctioning.	<ul style="list-style-type: none"> ▶ Continue driving with added caution. Wheels may lock during hard braking, reducing steering capability. ▶ Have the system checked at an authorized Mercedes-Benz Center as soon as possible. <p>Failure to follow these instructions increases the risk of an accident.</p>
AIR CLEANER CHANGE CARTRIDGE VISIT WORKSHOP	The air filter is clogged.	<ul style="list-style-type: none"> ▶ Have the air filter checked by an authorized Mercedes-Benz Center.

Practical hints

What to do if ...?

Display	Possible cause	Possible solution
DISTRONIC EXTERNAL MALFUNCTION REACTIVATE	DISTRONIC* is switched off and is temporarily unavailable.	▶ Try activating DISTRONIC* again later.
DISTRONIC CURRENTLY UNAVAILABLE SEE OPERATORS MANUAL	DISTRONIC* is switched off because the DISTRONIC* cover in the radiator grille is dirty.	▶ Clean the DISTRONIC* cover in the radiator grille (▷ page 333). ▶ Restart the vehicle.
DISTRONIC DRIVE TO WORKSHOP	DISTRONIC* is malfunctioning or the display is malfunctioning.	▶ Visit an authorized Mercedes-Benz Center as soon as possible.
ESP MALFUNCTION VISIT WORKSHOP	The ESP has detected a malfunction and switched off. The ABS may still be operational.	▶ Continue driving with added caution. ▶ Have the system checked at an authorized Mercedes-Benz Center as soon as possible. Failure to follow these instructions increases the risk of an accident.
DISPLAY DEFECTIVE VISIT WORKSHOP	The ESP or the ESP display is malfunctioning.	▶ Continue driving with added caution. ▶ Have the system checked at an authorized Mercedes-Benz Center as soon as possible. Failure to follow these instructions increases the risk of an accident.

Practical hints

What to do if ...?

Display	Possible cause	Possible solution
ESP UNAVAILABLE SEE OPERATORS MANUAL	The ESP was deactivated the power supply has been interrupted. The ABS is still operational.	<ul style="list-style-type: none">▶ Synchronize the ESP. With the vehicle stationary and the engine running, turn the steering wheel completely to the left and then to the right to synchronize the ESP. If the ESP message does not go out: <ul style="list-style-type: none">▶ Continue driving with added caution.▶ Have the system checked at an authorized Mercedes-Benz Center as soon as possible. Failure to follow these instructions increases the risk of an accident.



When synchronizing the ESP, make sure you can turn the steering wheel in both directions as far as it will go without the wheel hitting any objects, e.g. a road curb.

Practical hints

What to do if ...?

Display	Possible cause	Possible solution
MOVE SELECTOR LEVER TO PARK	You have tried to turn off the engine with the KEYLESS-GO* start/stop button (▷ page 35) with the gear selector lever not in P .	▶ Place the gear selector lever in position P .
PRE-SAFE INACTIVE SEE OPERATORS MANUAL	If BAS or ESP malfunction messages are displayed simultaneously, PRE-SAFE has been deactivated as a result of these malfunctions. All other occupant safety systems, such as the air bags, are still available.	▶ Visit an authorized Mercedes-Benz Center as soon as possible.
	PRE-SAFE itself has failed. All other occupant safety systems, such as the air bags, are still available.	▶ Visit an authorized Mercedes-Benz Center as soon as possible.

FarmaSOS.com

Practical hints

What to do if ...?

Symbol messages

Display	Possible cause	Possible solution
 AIRMATIC STOP, CAR TOO LOW	The vehicle is parked on an extremely uneven surface. The vehicle level control is malfunctioning.	<ul style="list-style-type: none"> ▶ Press the vehicle level control button to select the raised vehicle level (▷ page 230). ▶ Stop and press the vehicle level control button to select a higher vehicle level (▷ page 230). ▶ Do not turn steering wheel too far to avoid damaging the front fenders. ▶ Listen for scraping noises. ▶ Do not exceed a speed of 50 mph (80 km/h). ▶ Visit an authorized Mercedes-Benz center as soon as possible.
AIRMATIC DRIVE CAREFULLY!	The capability of the Airmatic system is restricted.	<ul style="list-style-type: none"> ▶ Do not exceed a speed of 50 mph (80 km/h). ▶ Visit an authorized Mercedes-Benz center as soon as possible.

Practical hints

What to do if ...?



Display	Possible cause	Possible solution
 DISPLAY DEFECTIVE VISIT WORKSHOP	The display for Airmatic or the Airmatic system itself is malfunctioning.	▶ Visit an authorized Mercedes-Benz Center as soon as possible.
AIRMATIC LEVELING CANCELLED	<ul style="list-style-type: none">• You have exceeded a speed of 75 mph (120 km/h).or• You have maintained a speed of between 50 mph (80 km/h) and 75 mph (120 km/h) for more than 5 minutes.	▶ Press the vehicle level control button to adjust the vehicle level (▷ page 230).

تلفن شبانه روزی: ۰۲۱-۸۸۶۲۰۸۵

FarmaSOS.com



Practical hints

What to do if ...?

Display	Possible cause	Possible solution
 BATTERY CHARGE VISIT WORKSHOP	<p>The battery is no longer charging. Possible causes:</p> <ul style="list-style-type: none"> • alternator malfunctioning • broken poly-V-belt <p>Do not forget that the brake system requires electrical energy and may be operating with restricted capability. Considerably greater brake pedal force is required and the stopping distance is longer.</p>	<p>► Stop immediately and check the poly-V-belt.</p> <p>If it is broken:</p> <p>► Do not continue to drive. Otherwise the engine will overheat due to an inoperative water pump which may result in damage to the engine. Notify an authorized Mercedes-Benz Center.</p> <p>If it is intact:</p> <p>► Drive immediately to the nearest authorized Mercedes-Benz Center. Adjust driving to be consistent with reduced braking responsiveness.</p>
BRAKE (USA only)  (Canada only)	RELEASE PARKING BRAKE	<p>You are driving with the parking brake engaged.</p> <p>► Release the parking brake (▷ page 48).</p>

Practical hints

What to do if ...?

Display	Possible cause	Possible solution
 BRAKE PAD WEAR VISIT WORKSHOP	The brake pads have reached their wear limit.	▶ Have the brake pads replaced as soon as possible.
 BRAKE (USA only)  (Canada only)	BRAKE FLUID VISIT WORKSHOP There is insufficient brake fluid in the reservoir.	▶ Risk of accident! Stop the vehicle and notify an authorized Mercedes-Benz Center. Do not add brake fluid! This will not solve the problem. Failure to follow these instructions increases the risk of accident.

Warning!



Driving with this message displayed can result in an accident. Have your brake system checked immediately. Don't add brake fluid before checking the brake system. Overfilling the brake fluid reservoir can result in spilling brake fluid on hot engine parts and the brake fluid catching fire. You can be seriously burned.





If you find that the brake fluid in the brake fluid reservoir has fallen to the minimum mark or below, have the brake system checked for brake pad thickness and leaks.



Brake pad thickness must be visually checked by a qualified technician at the intervals specified in the Maintenance Booklet.

Practical hints

What to do if ...?

Display	Possible cause	Possible solution
 VISIT WORKSHOP	There may be a malfunction in the: <ul style="list-style-type: none">• Fuel injection system• Ignition system• Exhaust system• Fuel system	▶ Visit an authorized Mercedes-Benz Center as soon as possible.
 COOLANT CHECK LEVEL!	The coolant level is too low.	▶ Add coolant (▷ page 292). ▶ If you have to add coolant frequently, have the cooling system checked by an authorized Mercedes-Benz Center.

Warning!



Do not spill antifreeze on hot engine parts. Antifreeze contains ethylene glycol which may burn if it comes into contact with hot engine parts. You can be seriously burned.



Do not ignore the low engine coolant level warning. Extended driving with the message and symbol displayed may cause serious engine damage not covered by the Mercedes-Benz Limited Warranty.

Do not drive without a sufficient amount of coolant in the cooling system. The engine will overheat, causing major engine damage.

Practical hints

What to do if ...?

Display	Possible cause	Possible solution
 COOLANT STOP, ENGINE OFF	The coolant is too hot.	<ul style="list-style-type: none">▶ Stop the vehicle and turn off the engine.▶ Only start the engine again after the message disappears. You could otherwise damage the engine.

Warning!



Driving when your engine is badly overheated can cause some fluids which may have leaked into the engine compartment to catch fire. You could be seriously burned.

Steam from an overheated engine can cause serious burns and can occur just by opening the engine hood. Stay away from the engine if you see or hear steam coming from it.

Turn off the engine, get out of the vehicle and do not stand near the vehicle until the engine has cooled down.

During severe operating conditions, e.g. stop-and-go traffic, the coolant temperature may rise close to 248°F (120°C).



The engine should not be operated with the coolant temperature above 248°F (120°C). Doing so may cause serious engine damage which is not covered by the Mercedes-Benz Limited Warranty.

FarmaSOS.com





Practical hints

What to do if ...?

Display	Possible cause	Possible solution
 COOLANT STOP, ENGINE OFF	The poly-V-belt could be broken.	<ul style="list-style-type: none">▶ Stop immediately and check the poly-V-belt. If it is broken: <ul style="list-style-type: none">▶ Do not continue to drive. Otherwise the engine will overheat due to an inoperative water pump which may result in damage to the engine.▶ Notify an authorized Mercedes-Benz Center. If it is intact: <ul style="list-style-type: none">▶ Restart the engine only after the message disappears from the multifunction display. Doing so could result in serious engine damage that is not covered by the Mercedes-Benz Limited Warranty.▶ Observe the coolant temperature gauge (▷ page 141).▶ Drive immediately to the nearest authorized Mercedes-Benz Center. Adjust driving to be consistent with reduced braking responsiveness.

Practical hints

What to do if ...?

Display	Possible cause	Possible solution
 COOLANT VISIT WORKSHOP	The cooling fan for the coolant is malfunctioning.	<ul style="list-style-type: none"> ▶ Observe the coolant temperature display. ▶ Have the fan replaced as soon as possible.
 CRUISE CONTROL DRIVE TO WORKSHOP	Cruise control or DISTRONIC* is malfunctioning.	<ul style="list-style-type: none"> ▶ Have cruise control or DISTRONIC* checked by an authorized Mercedes-Benz Center.
 DISPLAY DEFECTIVE VISIT WORKSHOP	The instrument cluster display is malfunctioning.	<ul style="list-style-type: none"> ▶ Continue driving with added caution. ▶ Visit an authorized Mercedes-Benz Center as soon as possible.
 DISPLAY DEFECTIVE VISIT WORKSHOP	Certain electronic systems are unable to relay information to the control system. The following systems may have failed: <ul style="list-style-type: none"> • Coolant temperature display • Tachometer • Cruise control display 	<ul style="list-style-type: none"> ▶ Have the electronic systems checked by an authorized Mercedes-Benz Center.
 DOOR OPEN	You are attempting to drive with one or more doors open.	<ul style="list-style-type: none"> ▶ Close the doors.

Practical hints

What to do if ...?

Display	Possible cause	Possible solution
 <p>USA only: ADD 1.0 QT. ENGINE OIL AT FILLING STATION</p> <p>Canada only: ADD 1.0 LITER ENGINE OIL AT FILLING STATION</p>	The engine oil level is too low.	<ul style="list-style-type: none"> ▶ Add engine oil (▷ page 291) and check the engine oil level (▷ page 288).
<p>ENGINE OIL LEVEL STOP, ENGINE OFF!</p>	There is no oil in the engine.	<p>There is a danger of engine damage.</p> <ul style="list-style-type: none"> ▶ Carefully bring the vehicle to a halt as soon as possible. ▶ Turn off the engine. ▶ Add engine oil (▷ page 291) and check the engine oil level (▷ page 288).
<p>ENGINE OIL LEVEL REDUCE OIL LEVEL</p>	<p>You have added too much engine oil.</p> <p>There is a risk of damaging the engine or the catalytic converter.</p>	<ul style="list-style-type: none"> ▶ Have excess oil siphoned or drained off. ▶ Observe all legal requirements with respect to its disposal.

Practical hints

What to do if ...?

Display	Possible cause	Possible solution
 ENGINE OIL VISIT WORKSHOP	It may be that there is water in the engine oil.	▶ Have the engine oil level checked (▷ page 288).
ENGINE OIL LEVEL VISIT WORKSHOP	The engine oil has dropped to a critical level.	▶ Check the engine oil level (▷ page 288) and add engine oil as required (▷ page 291). ▶ If you must add engine oil frequently, have the engine checked for possible leaks.
ENGINE OIL SENSOR VISIT WORKSHOP	The measuring system is malfunctioning.	▶ Have the measuring system checked by an authorized Mercedes-Benz Center.

When the message ADD 1.0 QT. ENGINE OIL AT FILLING STATION (Canada: 1 Liter) appears while the engine is running and at operating temperature, the engine oil level has dropped to approximately the minimum level.

When this occurs, the warning will first come on intermittently and then stay on if the oil level drops further.



Visually check for oil leaks. If no obvious oil leaks are noted, drive to the nearest service station where the engine oil should be topped to the required level with an approved oil specified in the Factory Approved Service Products pamphlet.



The engine oil level warnings should not be ignored. Extended driving with the symbol displayed could result in serious engine damage that is not covered by the Mercedes-Benz Limited Warranty.



Practical hints

What to do if ...?

Display	Possible cause	Possible solution
 ENTRY POSITION DO NOT DRIVE	Seat, exterior mirrors and steering wheel have not yet moved to their preset driving positions.	► Wait until the seat, exterior mirrors and steering wheel have moved to their driving positions. The message will disappear.
 HOOD OPEN!	You are driving with the hood open.	► Close the hood (▷ page 287).
 REMOVE KEY!	You have forgotten to remove the SmartKey.	► Remove the SmartKey from the ignition.
REPLACE KEY! DRIVE TO WORKSHOP	The SmartKey is malfunctioning.	► Visit an authorized Mercedes-Benz Center as soon as possible.
AUTOMATIC LIGHT ON REMOVE KEY!	SmartKey in starter switch position 1 or 2.	► Remove the SmartKey from the starter switch.
KEY CHECK BATTERY	The battery in the KEYLESS-GO* key is discharged.	► Replace the battery (▷ page 387).
KEY NOT RECOGNIZED	SmartKey with KEYLESS-GO* is not recognized while the engine is running because <ul style="list-style-type: none"> • the SmartKey is not in the vehicle • there is strong radio-frequency interference 	► Stop the vehicle as soon as it is safe to do so. ► Search for the SmartKey. Otherwise the vehicle cannot be centrally locked nor can the engine be started again after it has been stopped.

Practical hints

What to do if ...?

Display	Possible cause	Possible solution
	KEY NOT RECOGNIZED	<ul style="list-style-type: none"> ▶ Change the position of the SmartKey with KEYLESS-GO* in the vehicle. ▶ Operate the vehicle with the SmartKey in the starter switch if necessary.
	KEY STILL IN VEHICLE	<ul style="list-style-type: none"> ▶ Take the SmartKey with KEYLESS-GO* out of the vehicle.
	KEY DRIVE TO WORKSHOP	<ul style="list-style-type: none"> ▶ Visit an authorized Mercedes-Benz Center as soon as possible.
	3RD BRAKE LIGHT CHECK LIGHT	<ul style="list-style-type: none"> ▶ Visit an authorized Mercedes-Benz Center as soon as possible.
	STOP LIGHT VISIT WORKSHOP	<ul style="list-style-type: none"> ▶ Visit an authorized Mercedes-Benz Center as soon as possible.
	BRAKE LIGHT LEFT CHECK LIGHT SUBSTITUTE LAMP ON!	<ul style="list-style-type: none"> ▶ Visit an authorized Mercedes-Benz Center as soon as possible.
	BRAKE LIGHT RIGHT CHECK LIGHT SUBSTITUTE LAMP ON!	<ul style="list-style-type: none"> ▶ Visit an authorized Mercedes-Benz Center as soon as possible.
	DISPLAY DEFECTIVE VISIT WORKSHOP	<ul style="list-style-type: none"> ▶ Visit an authorized Mercedes-Benz Center as soon as possible.

Practical hints

What to do if ...?

Display	Possible cause	Possible solution
 FRONT FOGLAMP, LEFT CHECK LIGHT	The left front fog lamp is malfunctioning.	▶ Visit an authorized Mercedes-Benz Center as soon as possible.
FRONT FOGLAMP, RIGHT CHECK LIGHT	The right front fog lamp is malfunctioning.	▶ Visit an authorized Mercedes-Benz Center as soon as possible.
HIGH BEAM, LEFT CHECK LIGHT	The left high beam lamp is malfunctioning.	▶ Replace the bulb as soon as possible.
HIGH BEAM, RIGHT CHECK LIGHT	The right high beam lamp is malfunctioning.	▶ Replace the bulb as soon as possible.
LICENSE PLATE L, L CHECK LIGHT	The left license plate lamp is malfunctioning.	▶ Replace the bulb as soon as possible.
LICENSE PLATE L, R CHECK LIGHT	The right license plate lamp is malfunctioning.	▶ Replace the bulb as soon as possible.
LIGHT SENSOR DRIVE TO WORKSHOP	The lamp sensor is malfunctioning. The headlamps switch on automatically.	▶ In the control system, set lamp operation to manual (▷ page 163). ▶ Switch on headlamps using the exterior lamp switch. ▶ Visit an authorized Mercedes-Benz Center as soon as possible.

Practical hints

What to do if ...?

Display	Possible cause	Possible solution
 LOW BEAM, LEFT CHECK LIGHT	The left low beam lamp is malfunctioning.	Halogen headlamp: ▶ Replace the bulb as soon as possible. Bi-Xenon* headlamp: ▶ Visit an authorized Mercedes-Benz Center as soon as possible.
LOW BEAM, RIGHT CHECK LIGHT	The right low beam lamp is malfunctioning.	Halogen headlamp: ▶ Replace the bulb as soon as possible. Bi-Xenon* headlamp: ▶ Visit an authorized Mercedes-Benz Center as soon as possible.
MARKER LIGHT, FL CHECK LIGHT	The front left side marker lamp is malfunctioning.	▶ Replace the bulb as soon as possible.
MARKER LIGHT, FR CHECK LIGHT	The front right side marker lamp is malfunctioning.	▶ Replace the bulb as soon as possible.
REAR FOGLIGHT CHECK LIGHT	The rear fog lamp is malfunctioning.	▶ Replace the bulb as soon as possible.
REVERSE LIGHT, LEFT CHECK LIGHT	The left reverse lamp is malfunctioning.	▶ Replace the bulb as soon as possible.
REVERSE LIGHT, RIGHT CHECK LIGHT	The right reverse lamp is malfunctioning.	▶ Replace the bulb as soon as possible.

Practical hints

What to do if ...?

Display	Possible cause	Possible solution
 STANDING LIGHT, L CHECK LIGHT	The left front parking lamp is malfunctioning.	▶ Replace the bulb as soon as possible.
STANDING LIGHT, R CHECK LIGHT	The right front parking signal lamp is malfunctioning.	▶ Replace the bulb as soon as possible.
STANDING LIGHT, L CHECK LIGHT SUBSTITUTE LAMP ON!	The left rear parking signal lamp is malfunctioning. A substitute bulb is being used.	▶ Replace the bulb as soon as possible.
STANDING LIGHT, R CHECK LIGHT SUBSTITUTE LAMP ON!	The right rear parking signal lamp is malfunctioning. A substitute bulb is being used.	▶ Replace the bulb as soon as possible.
TAIL LIGHT, LEFT CHECK LIGHT SUBSTITUTE LAMP ON!	The left tail lamp is malfunctioning. A substitute bulb is being used.	▶ Replace the bulb as soon as possible.
TAIL LIGHT, RIGHT CHECK LIGHT SUBSTITUTE LAMP ON!	The right tail lamp is malfunctioning. A substitute bulb is being used.	▶ Replace the bulb as soon as possible.
TURN OFF LIGHTS	Lamps have been turned on although the SmartKey in the ignition is in position 0.	▶ Turn the exterior lamp switch to 0 (▷ page 50).







Practical hints

What to do if ...?

Display	Possible cause	Possible solution
 FRONT TURN SIGNAL, L CHECK LIGHT	The left front turn signal lamp is malfunctioning.	▶ Replace the bulb as soon as possible.
FRONT TURN SIGNAL, R CHECK LIGHT	The right front turn signal lamp is malfunctioning.	▶ Replace the bulb as soon as possible.
REAR TURN SIGNAL, L CHECK LIGHT SUBSTITUTE LAMP ON!	The left rear turn signal lamp is malfunctioning. A substitute bulb is being used.	▶ Replace the bulb as soon as possible.
REAR TURN SIGNAL, R CHECK LIGHT SUBSTITUTE LAMP ON!	The right rear turn signal lamp is malfunctioning. A substitute bulb is being used.	▶ Replace the bulb as soon as possible.
MIRROR TURN SIG., L CHECK LIGHT	The left turn signal in the side mirror is malfunctioning. This message will only appear if all light emitting diodes have stopped working.	▶ Visit an authorized Mercedes-Benz Center as soon as possible.
MIRROR TURN SIG., R CHECK LIGHT	The right turn signal in the side mirror is malfunctioning. This message will only appear if all light emitting diodes have stopped working.	▶ Visit an authorized Mercedes-Benz Center as soon as possible.



Practical hints

What to do if ...?

Display	Possible cause	Possible solution
 SEAT BELT SYSTEM DRIVE TO WORKSHOP	The seat belt system is malfunctioning.	▶ Visit an authorized Mercedes-Benz Center as soon as possible.
 CLOSE SUNROOF!	You have opened the driver's door with the SmartKey removed from the starter switch and the tilt/sliding sunroof open.	▶ Close the tilt/sliding sunroof (▷ page 211).
 CLOSE SUNROOF!	You have opened the driver's door with the SmartKey removed from the starter switch and the tilt/sliding sunroof open.	▶ Close the tilt/sliding sunroof (▷ page 211).
 TELE AID DRIVE TO WORKSHOP	One or more main functions of the Tele Aid system are malfunctioning.	▶ Have the Tele Aid system checked by an authorized Mercedes-Benz Center.
TELE AID BATTERY DRIVE TO WORKSHOP	The emergency power battery for the Tele Aid system is malfunctioning. If the vehicle battery is also discharged, Tele Aid will not be operational.	▶ Have the Tele Aid system checked by an authorized Mercedes-Benz Center.
 FUNCTION UNAVAILABLE	This display appears if button  or  on the multifunction steering wheel is pressed and the vehicle is not equipped with a telephone.	

Practical hints

What to do if ...?

Display	Possible cause	Possible solution
 TANK OPEN! CHECK FILLER CAP!	A loss of pressure has been detected in the fuel system. The fuel cap may not be closed properly or the fuel system may be leaky.	<ul style="list-style-type: none">▶ Check the fuel cap (▷ page 283). If it is not closed properly: <ul style="list-style-type: none">▶ Close the fuel cap. If it is closed properly: <ul style="list-style-type: none">▶ Have the fuel system checked by an authorized Mercedes-Benz Center.
 TRUNK OPEN	This message will appear whenever the trunk lid is open.	<ul style="list-style-type: none">▶ Close the trunk lid.
 WASHER FLUID CHECK LEVEL!	The fluid level has dropped to about $\frac{1}{3}$ of total reservoir capacity.	<ul style="list-style-type: none">▶ Add washer fluid (▷ page 295).

FarmaSOS.com

Practical hints

What to do if ...?

Tire inflation pressure monitor messages

Display	Possible cause	Possible solution
 TIRE PRES. CAUTION, TIRE PRES. TIRE PRES. CHECK TIRES!	One or more tires are deflating. The pressure has fallen significantly in one or more tires.	<ul style="list-style-type: none">▶ Carefully bring the vehicle to a halt, avoiding abrupt steering and braking maneuvers. Observe the traffic situation around you.▶ Change the damaged wheel (▷ page 398).▶ Have the damaged wheel repaired or replaced at an authorized Mercedes-Benz Center.
TIRE PRESSURE PLEASE CORRECT	The pressure is too low in one or more tires.	<ul style="list-style-type: none">▶ Check and correct tire inflation pressure as required (▷ page 307).

Warning!



Do not drive with a flat tire. A flat tire affects the ability to steer or brake the vehicle.

You may lose control of the vehicle. Continued driving with a flat tire will cause excessive heat build-up and possibly a fire.

Practical hints

What to do if ...?

Display	Possible cause	Possible solution
 TIRE PRES., LF CAUTION, TIRE PRES.	The left front tire is deflating.	<ul style="list-style-type: none"> ▶ Bring the vehicle to a halt, avoiding abrupt braking maneuvers. Observe the traffic situation around you. ▶ Change the wheel (▷ page 398). ▶ Have the damaged wheel repaired or replaced at an authorized Mercedes-Benz Center.
TIRE PRES., LF CHECK TIRES!	The left front tire inflation pressure is low.	<ul style="list-style-type: none"> ▶ Carefully bring the vehicle to a halt. ▶ Check and correct the tire inflation pressure (▷ page 307). ▶ If necessary, change the wheel (▷ page 398). ▶ Have the damaged wheel repaired or replaced at an authorized Mercedes-Benz Center.

Warning!



Do not drive with a flat tire. A flat tire affects the ability to steer or brake the vehicle.

You may lose control of the vehicle. Continued driving with a flat tire will cause excessive heat build-up and possibly a fire.

Practical hints

What to do if ...?

Display	Possible cause	Possible solution
 TIRE PRES., RF CAUTION, TIRE PRES.	The right front tire is deflating.	<ul style="list-style-type: none"> ▶ Bring the vehicle to a halt, avoiding abrupt braking maneuvers. Observe the traffic situation around you. ▶ Change the wheel (▷ page 398). ▶ Have the damaged wheel repaired or replaced at an authorized Mercedes-Benz Center.
TIRE PRES., RF CHECK TIRES!	The right front tire inflation pressure is low.	<ul style="list-style-type: none"> ▶ Carefully bring the vehicle to a halt. ▶ Check and correct the tire inflation pressure (▷ page 307). ▶ If necessary, change the wheel (▷ page 398). ▶ Have the damaged wheel repaired or replaced at an authorized Mercedes-Benz Center.

Warning!



Do not drive with a flat tire. A flat tire affects the ability to steer or brake the vehicle.

You may lose control of the vehicle. Continued driving with a flat tire will cause excessive heat build-up and possibly a fire.

Practical hints

What to do if ...?

Display	Possible cause	Possible solution
 TIRE PRES., LR CAUTION, TIRE PRES.	The left rear tire is deflating.	<ul style="list-style-type: none">▶ Bring the vehicle to a halt, avoiding abrupt braking maneuvers. Observe the traffic situation around you.▶ Change the wheel (▷ page 398).▶ Have the damaged wheel repaired or replaced at an authorized Mercedes-Benz Center.
TIRE PRES., LR CHECK TIRES!	The left rear tire inflation pressure is low.	<ul style="list-style-type: none">▶ Carefully bring the vehicle to a halt.▶ Check and correct the tire inflation pressure (▷ page 307).▶ If necessary, change the wheel (▷ page 398).▶ Have the damaged wheel repaired or replaced at an authorized Mercedes-Benz Center.

Warning!



Do not drive with a flat tire. A flat tire affects the ability to steer or brake the vehicle.

You may lose control of the vehicle. Continued driving with a flat tire will cause excessive heat build-up and possibly a fire.

Practical hints

What to do if ...?

Display	Possible cause	Possible solution
 TIRE PRES., RR CAUTION, TIRE PRES.	The right rear tire is deflating.	<ul style="list-style-type: none"> ▶ Bring the vehicle to a halt, avoiding abrupt braking maneuvers. Observe the traffic situation around you. ▶ Change the wheel (▷ page 398). ▶ Have the damaged wheel repaired or replaced at an authorized Mercedes-Benz Center.
TIRE PRES., RR CHECK TIRES!	The right rear tire inflation pressure is low.	<ul style="list-style-type: none"> ▶ Carefully bring the vehicle to a halt. ▶ Check and correct the tire inflation pressure (▷ page 307). ▶ If necessary, change the wheel (▷ page 398). ▶ Have the damaged wheel repaired or replaced at an authorized Mercedes-Benz Center.

Warning!



Do not drive with a flat tire. A flat tire affects the ability to steer or brake the vehicle.

You may lose control of the vehicle. Continued driving with a flat tire will cause excessive heat build-up and possibly a fire.

Practical hints

What to do if ...?

Display	Possible cause	Possible solution
TIRE PRES. MONITOR REACTIVE AFTER CORRECTING PRESSURE	<p>There was a tire inflation pressure warning message.</p> <p>The yellow warning lamp for the tire inflation pressure monitor comes on and you have not reactivated the system since the last tire inflation pressure check.</p>	▶ Activate the tire inflation pressure monitor after correcting the tire inflation pressure values (▷ page 307).
TIRE PRES. MONITOR REACTIVATED	The tire inflation pressure monitor is using the current pressure values as the basis for monitoring.	

Warning!



Do not drive with a flat tire. A flat tire affects the ability to steer or brake the vehicle.

You may lose control of the vehicle. Continued driving with a flat tire will cause excessive heat build-up and possibly a fire.

FarmaSOS.com

Practical hints

What to do if ...?

Display	Possible cause	Possible solution
TIRE PRES. MONITOR CURRENTLY UNAVAILABLE	<p>The tire inflation pressure monitor* is unable to monitor the tire inflation pressure due to:</p> <ul style="list-style-type: none"> • the presence of several wheel sensors in the vehicle • excessive wheel sensor temperatures • a nearby radio interference source • unrecognized wheel sensors installed 	<p>► Remove any extra wheel sensors from the vehicle.</p> <p>As soon as the causes of the malfunction have been removed, the tire inflation pressure monitor automatically becomes active again.</p>
TIRE PRES. MONITOR NOT OPERATIONAL DRIVE TO WORKSHOP	<p>The tire inflation pressure monitor or a wheel sensor is malfunctioning.</p> <p>A wheel without proper sensor was installed.</p>	<p>► Have the tire inflation pressure monitor checked by an authorized Mercedes-Benz Center.</p> <p>► Have the wheels checked.</p>

Warning!



Do not drive with a flat tire. A flat tire affects the ability to steer or brake the vehicle.

You may lose control of the vehicle. Continued driving with a flat tire will cause excessive heat build-up and possibly a fire.

▼ Where will I find ...?

First aid kit

The first aid kit is located in the storage compartments under the front passenger seat.

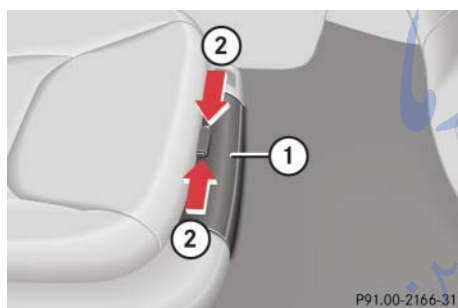

- ① Lid
- ② Buttons

Removing the first aid kit

- ▶ Press buttons ② together and fold lid ① down.
Remove first aid kit.

Storing the first aid kit

- ▶ Place first aid kit in the storage compartments.
- ▶ Close lid ① until both buttons ② of lock engage.



Check expiration dates and contents for completeness at least once a year and replace missing/expired items.

Practical hints

Where will I find ...?

Vehicle jack, vehicle tool kit, luggage bowl, spare wheel

The spare wheel, the vehicle tools, and the luggage bowl are stored in the compartment underneath the trunk floor.

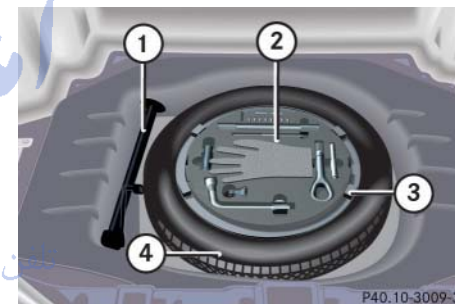

- ① Jack
- ② Storage tray with vehicle tool kit
- ③ Luggage bowl
- ④ Spare wheel

- ▶ Lift up trunk floor cover and engage trunk floor handle in upper edge of trunk.

You can now remove the tools and accessories. >>

Practical hints

Where will I find ...?



To prevent damage, always disengage trunk floor handle from trunk lid and lower trunk floor before closing the trunk lid.

The vehicle tool kit includes:

- One interchangeable slot/Phillips screwdriver
- One towing eye bolt
- One wheel bolt wrench with socket wrench
- One alignment bolt
- One pair of gloves
- One fuse extractor
- One fuse chart for the main fuse box
- Spare fuses

Vehicle jack

To prepare the vehicle jack for use

- ▶ Remove the vehicle jack from the spare wheel well under the trunk floor.
- ▶ Push the crank handle up.
- ▶ Turn the crank handle clockwise until it engages (operational position).



Storing the vehicle jack in the trunk

- ▶ Retract the vehicle jack arm to the base of the vehicle jack.
- ▶ Push the crank handle up.
- ▶ Turn the crank handle counterclockwise to the end of the stop (storage position).

Warning!



The jack is designed exclusively for jacking up the vehicle at the jack take-up brackets built into both sides of the vehicle. To help avoid personal injury, use the jack only to lift the vehicle during a wheel change. Never get beneath the vehicle while it is supported by the jack. Keep hands and feet away from the area under the lifted vehicle. Always firmly set parking brake and block wheels before raising vehicle with jack.

Do not disengage parking brake while the vehicle is raised. Be certain that the jack is always vertical (plumb line) when in use, especially on hills. Always try to use the jack on level surface. Make sure the jack arm is fully seated in the jack take-up bracket. Always lower the vehicle onto sufficient capacity jackstands before working under the vehicle.

Spare wheel

Removing the spare wheel

- ▶ Take out the vehicle tool kit tray ②.
- ▶ Loosen the luggage bowl ③. To do so, turn the luggage bowl counterclockwise.
- ▶ Remove the spare wheel ④.

Storing the spare wheel

- ▶ Place spare wheel ④ in wheel well.
- ▶ Secure the spare wheel. To do so, turn the luggage bowl ③ clockwise to its stop.
- ▶ Place vehicle tool kit tray ② in luggage bowl.

Spare wheel S 430, S 500 and S 600 (except Sport Package*)

The spare wheel rim is mounted with a full sized tire of the same type as on the vehicle, and it is fully functional.

Practical hints

Where will I find ...?

However, that spare wheel rim is weight optimized and has a limited service life of 12 000 miles (20 000 km) use before a standard wheel rim must replace it.

In case of flat tire, you may temporarily use the spare wheel.

Do not operate vehicle with more than one spare wheel mounted.

Warning!



Never operate the vehicle with more than one spare wheel mounted.

The spare wheel rim is for temporary use only. Use for over a total of 12 000 miles (20 000 km) (aggregate of all uses) may cause wheel rim failure leading to an accident and possible injuries.

The spare wheel should only be used temporarily and replaced with a regular road wheel as quickly as possible.

For more information, see “Rims and tires” (▷ page 422).

Practical hints

Where will I find ...?

Spare wheel S 55 AMG and Sport Package*

In case of a flat tire, you may temporarily use the spare wheel when observing the following restrictions:

- Do not exceed a vehicle speed of 50 mph (80 km/h).
- Drive to the nearest tire repair facility to have the flat tire repaired or replaced as appropriate.
- Do not operate vehicle with more than one spare wheel mounted.

Warning!



The dimensions of the spare wheel are different from those of the road wheels. As a result, the vehicle handling characteristics change when driving with a mounted spare wheel. Adapt your driving style accordingly.

Never operate the vehicle with more than one spare wheel mounted.

The spare wheel is for temporary use only. When driving with spare wheel mounted, ensure proper tire inflation pressure and do not exceed vehicle speed of 50 mph (80 km).

The spare wheel rim is for temporary use only. Use for over a total of 12 000 miles (20 000 km) (aggregate of all uses) may cause wheel rim failure leading to an accident and possible injuries.

The spare wheel should only be used temporarily and replaced with a regular road wheel as quickly as possible.

For more information, see “Rims and tires” (▷ page 422).

▼ **Unlocking/locking in an emergency**

Unlocking the vehicle

If you are unable to unlock the vehicle with the SmartKey or KEYLESS-GO*, open the driver's door and the trunk using the mechanical key.



Unlocking the driver's door and/or the trunk with the mechanical key will trigger the anti-theft alarm system.

To cancel the alarm, insert the SmartKey or SmartKey with KEYLESS-GO* in the starter switch.

Removing the mechanical key

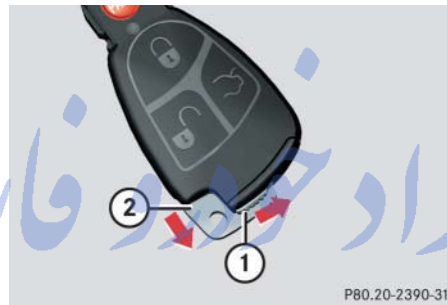

- ① Mechanical key locking tab
- ② Mechanical key
- ▶ Move locking tab ① in direction of arrow.
- ▶ Slide the mechanical key ② out of the housing.

Unlocking the driver's door

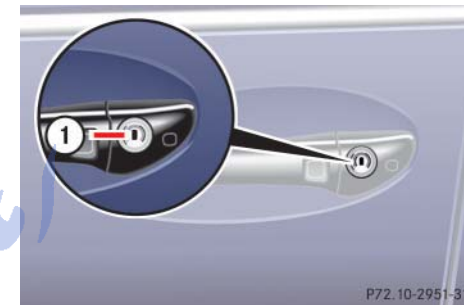

- ① Unlocking
 - ▶ Insert the mechanical key into the driver's door lock until it stops.
 - ▶ Turn the mechanical key counterclockwise to position ①.
- The driver's door is unlocked.

Practical hints

Unlocking/locking in an emergency

Unlocking the trunk

A minimum height clearance of 6 ft. (1.85 m) is required to open the trunk lid.

The trunk lid lock is located next to the handle above the rear license plate recess.

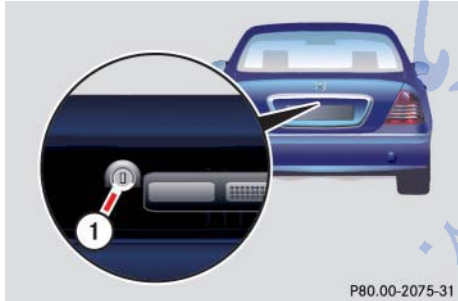

① Unlocking and opening

- ▶ Insert the mechanical key into the trunk lid lock until it stops.

- ▶ Turn the mechanical key counterclockwise to position ①.

The trunk unlocks and opens.



The trunk lid swings open upwards automatically. Always make sure that there is sufficient overhead clearance.

Locking the vehicle

If you are unable to lock the vehicle with the SmartKey or the SmartKey with KEYLESS-GO*, do the following:

- ▶ Close the passenger doors and the trunk lid.
- ▶ Press the central locking switch in the center console (▷ page 113).
- ▶ Check to see whether the locking knobs on the passenger doors have moved down.
- ▶ If necessary push them down manually.

Except for the driver's door, the vehicle should now be locked.

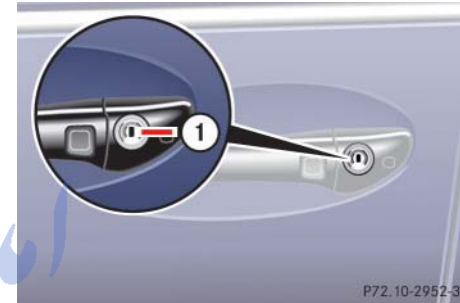

① Unlocking

- ▶ Remove the mechanical key out of the SmartKey (▷ page 383).
- ▶ Insert the mechanical key into the driver's door lock until it stops.
- ▶ Turn the mechanical key clockwise to position ①.

The driver's door is locked.

Fuel filler flap

In case the central locking system does not release the fuel filler flap, you can open it manually.

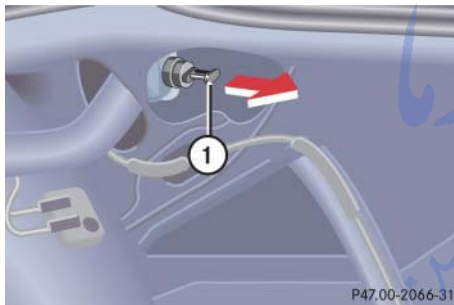

- ① Release knob
- ▶ Open the trunk.
- ▶ Remove the trim inside the trunk on the right-hand side.
- ▶ Pull release knob ① in the direction of arrow.

The fuel filler flap can be opened.

Practical hints

Opening/closing in an emergency

Tilt/sliding sunroof

You can open or close the tilt/sliding sunroof manually should an electrical malfunction occur.

The tilt/sliding sunroof drive is located behind the lens of the interior overhead light.



① Lens

- ▶ Pry off lens ① using a flat blade screwdriver (▷ page 379).
- ▶ Switch on ignition (▷ page 34).
- ▶ Take crank the crank from the operator's manual pouch.



② Crank

- ▶ Insert crank ② through hole.
- ▶ Turn crank ② clockwise to:
 - slide sunroof closed
 - raise roof at the rear
- ▶ Turn crank ② counterclockwise to:
 - slide sunroof open
 - lower roof at the rear

i

Turn crank ② slowly and smoothly.

The tilt/sliding sunroof must be synchronized after being operated manually (▷ page 213).

FarmaSOS.com

▼ Replacing SmartKey batteries

If the batteries in the SmartKey or the SmartKey with KEYLESS-GO* are discharged, the vehicle can no longer be locked or unlocked. It is recommended to have the batteries replaced at an authorized Mercedes-Benz Center.

Warning!



Batteries contain poisonous and corrosive substances. Therefore keep the batteries out of reach of children.

If a battery is swallowed, seek medical help immediately.

Batteries contain materials that can harm the environment if disposed of improperly. Recycling of batteries is the preferred method of disposal. Many states require sellers of batteries to accept old batteries for recycling.

SmartKey



When inserting the batteries, make sure they are clean and free of lint.



When changing batteries, always replace both batteries.

The required replacement batteries are available at any authorized Mercedes-Benz Center.

- ▶ Remove mechanical key out of the SmartKey (▷ page 383).

Practical hints

Replacing SmartKey batteries

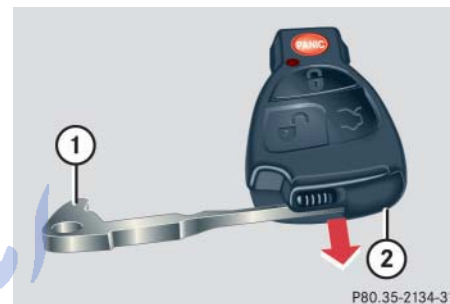

- ① Mechanical key
- ② Battery compartment

Replacement batteries: Lithium, type CR.2025 or equivalent.

- ▶ Insert the mechanical key ① in side opening and push gray slide.

The battery compartment ② is unlatched.

- ▶ Pull battery compartment ② out of the housing in direction of arrow.
- ▶ Remove the batteries.

Practical hints

Replacing SmartKey batteries

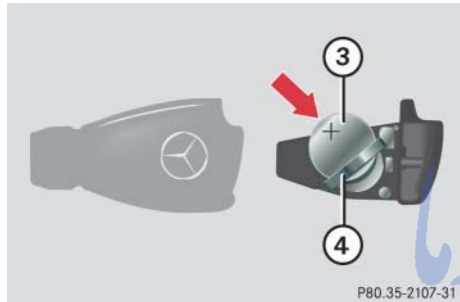

- ③ Battery
- ④ Contact spring

- ▶ Using a lint-free cloth, insert new batteries ③ under the contact spring ④ with the plus (+) side facing up.
- ▶ Return battery compartment ② into housing until it locks into place.
- ▶ Slide mechanical key ① back into the SmartKey.
- ▶ Check the operation of the SmartKey.

SmartKey with KEYLESS-GO*

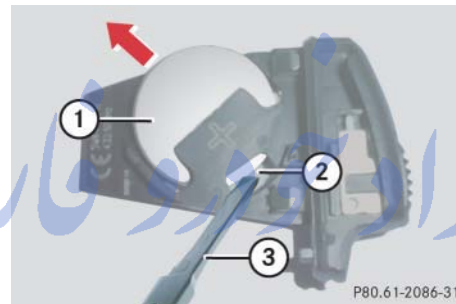

- ① Battery
- ② Tilt battery up
- ③ Mechanical key



When inserting the battery, make sure they are clean and free of lint.



The required replacement battery is available at any authorized Mercedes-Benz Center.

- ▶ Remove mechanical key out of the SmartKey (▷ page 383).

Replacement battery: Lithium, type CR 2025 or equivalent.

- ▶ Insert the mechanical key ③ in side opening and push gray slide. The battery compartment is unlatched.
- ▶ Pull the battery compartment out of the SmartKey housing.
- ▶ Using mechanical key ③, apply pressure to position ②. Battery ① tilts up slightly.
- ▶ Pull out battery ① in direction of arrow.
- ▶ Using a lint-free cloth, insert the new battery with the plus (+) side facing up.
- ▶ Return battery compartment into housing until it locks into place.
- ▶ Slide mechanical key ① back into the SmartKey.
- ▶ Check the operation of KEYLESS-GO*.

Practical hints

Replacing bulbs

▼ Replacing bulbs

Safe vehicle operation depends on proper exterior lighting and signaling. It is therefore essential that all bulbs and lamp assemblies are in good working order at all times.

Correct headlamp adjustment is extremely important. Have headlamps checked and readjusted at regular intervals and when a bulb has been replaced. See an authorized Mercedes-Benz Center for headlamp adjustment.



If the headlamps or front fog lamps are fogged up on the inside as a result of high humidity, driving the vehicle a distance with the lights on should clear up the fogging.



Substitute bulbs will be brought into use when the following lamps malfunction:

- Brake lamps
- Rear parking lamps
- Rear turn signal lamps
- Tail lamps

Observe the messages in the multi-function display (▷ page 365).

تلفن شبانه روزی: ۰۲۱-۸۸۶۲۰۸۵

FarmaSOS.com

Practical hints

Replacing bulbs

Bulbs

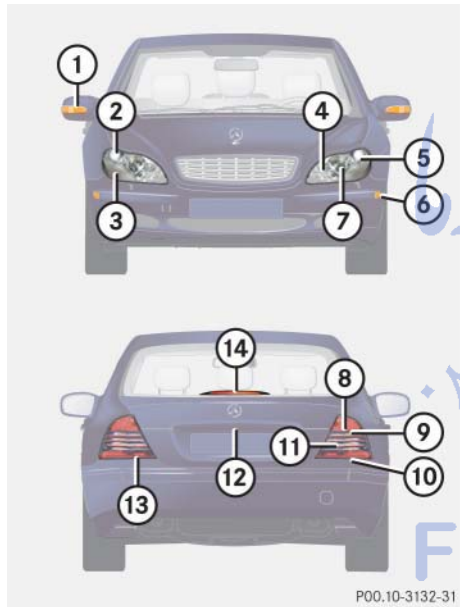

Front lamps

Lamp	Type
① Additional turn signal lamp	LED
② Halogen headlamp: Low beam	H7-55 W
Bi-Xenon* headlamp: Low and high beam ¹	D2S-35 W
③ Turn signal lamp	2357 A
④ Fog lamp	H7-55 W
⑤ Parking and standing lamp	W 5 W
⑥ Side marker lamp	W 5 W
⑦ Halogen headlamp: High beam/high beam flasher lamp	H7-55 W
Bi-Xenon* headlamp: High beam flasher	H7-55 W

Rear lamps

Lamp	Type
⑧ Brake lamp	LED
⑨ Turn signal lamp	PY 21 W
⑩ Tail and standing lamp, side marker	P 21/4 W
⑪ Backup lamp	P 21 W
⑫ License plate lamp	C 5 W
⑬ Tail lamp, rear fog lamp (driver's side only)	P 21/4 W
⑭ High mounted brake lamp	LED

¹ Vehicles with Bi-Xenon headlamps*: Low beam and high beam use the same D2S-35W lamp. Do not replace the Bi-Xenon bulbs yourself. See an authorized Mercedes-Benz Center.

Practical hints

Replacing bulbs

Notes on bulb replacement

Warning!



Keep bulbs out of reach of children.

Bulbs and bulb sockets can be very hot. Allow the lamp to cool down before changing a bulb.

Halogen lamps contain pressurized gas. A bulb can explode if you:

- touch or move it when hot
- drop the bulb
- scratch the bulb

Wear eye and hand protection.

Because of high voltage in Xenon lamps, it is dangerous to replace the bulb or repair the lamp and its components. We recommend that you have such work done by a qualified technician.

- Only use 12 volt bulbs of the same type and with the specified watt rating.
- Switch lights off before changing a bulb to prevent short circuits.
- Always use a clean lint-free cloth when handling bulbs.
- Your hands should be dry and free of oil and grease.
- If the newly installed bulb does not come on, visit an authorized Mercedes-Benz Center.

Have the LEDs and bulbs for the following lamps replaced by an authorized Mercedes-Benz Center.

- Additional turn signal lamps in the exterior rear view mirrors
- Bi-Xenon lamps*
- High mounted brake lamp
- Brake lamps
- Rear side marker lamps
- Rear parking lamps



Have the headlamp adjustment checked regularly.

تلفن شبانه روزی: ۰۲۱-۸۸۶۲۰۸۵

ArmaSOS.com

Practical hints

Replacing bulbs

Replacing bulbs for front lamps

Before you start to replace a bulb for a front lamp, do the following first:

- ▶ Turn the exterior lamp switch to **0** (▷ page 50).
- ▶ Open the hood (▷ page 286) (except for side marker lamps).

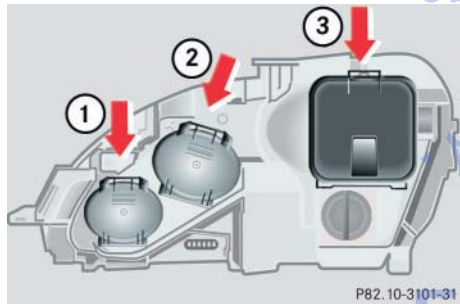

- ① Headlamp cover for fog lamp
- ② Headlamp cover for high beam halogen headlamp bulb, parking and standing lamp
- ③ Headlamp cover for Bi-Xenon* (low and high beam) or halogen (low beam) headlamp bulb

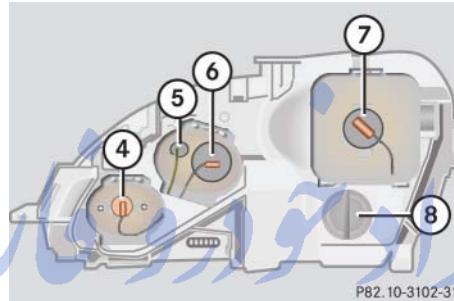

- ④ Bulb socket for fog lamp
- ⑤ Bulb socket for parking and standing lamp
- ⑥ Electrical connector for high beam halogen headlamp bulb
- ⑦ Electrical connector for low beam headlamp bulb
- ⑧ Bulb socket for turn signal lamp

Replacing low beam bulbs

Bi-Xenon* headlamp

Warning!



Do not remove the cover for the Bi-Xenon headlamp. Because of high voltage in Xenon lamps, it is dangerous to replace the bulb or repair the lamp and its components. We recommend that you have such work done by a qualified technician.

Practical hints

Replacing bulbs

Halogen headlamp

- ▶ Press the tab on cover ③ and remove cover.
- ▶ Pull connector ⑦ off of the lamp.
- ▶ Release the retaining springs and take out the bulb.
- ▶ Insert the new bulb in the socket so that the base is in the recess on the lower left.
- ▶ Attach the retaining springs.
- ▶ Insert connector ⑦ into the bulb.
- ▶ Press cover ③ onto the housing until the tab engages.

Replacing halogen high beam bulbs

- ▶ Press the tab on cover ② and remove cover.
- ▶ Pull connector ⑥ off of the bulb.
- ▶ Apply pressure on the bulb contacts from above until the bulb releases from the retaining springs.
- ▶ Remove bulb.
- ▶ Insert the new bulb in the socket with the marking facing upward.
- ▶ Press the bulb upward on the contacts until it engages in the retaining springs.
- ▶ Insert connector ⑥ onto the bulb.
- ▶ Press cover ② onto the housing until the tab engages.

Front turn signal lamp bulb

- ▶ Turn bulb socket ⑧ counterclockwise and pull out.
- ▶ Gently push bulb into socket, turn counterclockwise and remove.
- ▶ Insert new bulb in socket, push in and twist clockwise.
- ▶ Reinstall bulb socket in lamp and twist clockwise until it engages.

Practical hints

Replacing bulbs

Parking and standing lamp bulb

- ▶ Press the tab on cover ② and remove cover.
- ▶ Pull out the bulb socket ⑤ with the bulb.
- ▶ Pull the bulb out of the bulb socket ⑤.
- ▶ Insert a new bulb in the bulb socket ⑤.
- ▶ Reinstall the bulb socket ⑤.
- ▶ Press cover ② onto the housing until the tab engages.

Side marker lamp bulb

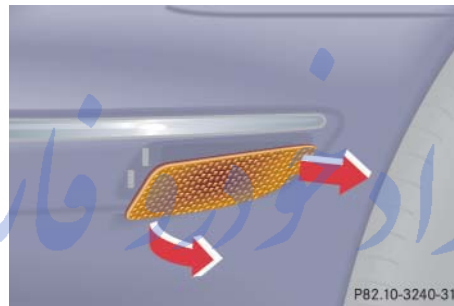

- ▶ Carefully slide lamp towards rear.
- ▶ Remove front end first.
- ▶ Twist bulb socket counterclockwise and pull out.

- ▶ Pull bulb out of the bulb socket.
- ▶ Insert new bulb in socket.
- ▶ Reinstall bulb socket, push in and twist clockwise.
- ▶ To reinstall lamp, set rear end in bumper and let front end snap into place.

Replacing bulbs for rear lamps

Before you start to replace a bulb for a rear lamp, do the following first:

- ▶ Turn the exterior lamp switch to **0** (▷ page 50).
- ▶ Open the trunk (▷ page 103).

Practical hints

Replacing bulbs

Tail lamp unit

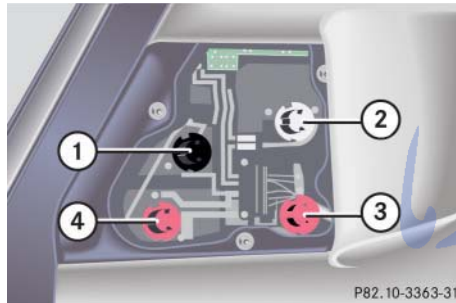

- ① Black socket:
Backup lamp
- ② White socket:
Turn signal lamp
- ③ Red socket:
Tail, standing and parking lamp
- ④ Red socket:
Driver's side: tail, parking and rear fog lamp
Passenger's side: tail and parking lamp

- ▶ Turn the catch, and move the trim to the side.
- ▶ Turn bulb socket counterclockwise and pull out.
- ▶ Gently twist bulb counterclockwise and pull out of bulb holder.
- ▶ Insert new bulb into the holder and turn it clockwise.
- ▶ Reinstall bulb socket.
The bulb socket should audibly click.
- ▶ Replace trim and secure with lock.

License plate lamp

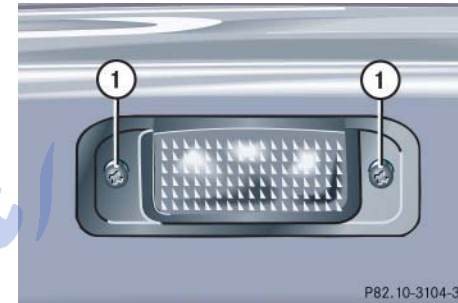

- ① Screws
- ▶ Loosen both screws ①.
- ▶ Remove the license plate lamp.
- ▶ Replace the bulb.
- ▶ Reinstall the license plate lamp.
- ▶ Retighten screws ①.

تلفن شبانه روزی: ۰۲۱-۸۸۶۲۰۸۵

FarmaSOS.com

Practical hints

Replacing wiper blades



To avoid damage to the hood, the wiper arms should only be folded forward when in the vertical position.



Wiper blades in vertical position

Removing wiper blades

- ▶ Turn SmartKey in starter switch position **1**.
- ▶ Turn combination switch to wiper setting II (> page 52).
- ▶ With wiper arm in vertical position, turn SmartKey in starter switch to position **0**.

Warning!



For safety reasons, switch off wipers and remove SmartKey from starter switch (vehicles with KEYLESS-GO*: Make sure the vehicle's on-board electronics have status **0**) before replacing a wiper blade. Otherwise, the wiper motor could suddenly turn on and cause injury.

- ▶ Fold the wiper arm forward until it snaps into place.

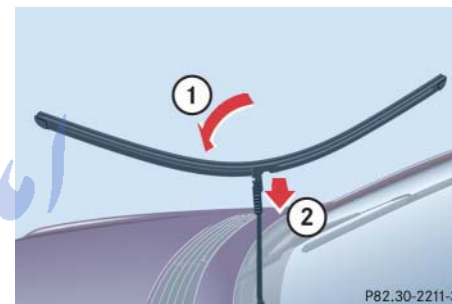

- ▶ Turn the wiper blade at a right angle to wiper arm (arrow ①).
- ▶ Slide the wiper blade sideways out of the retainer in the direction of arrow ②.

Installing wiper blades

- ▶ Slide the wiper blade onto wiper arm until it locks in place
- ▶ Rotate the wiper blade into position parallel to wiper arm.
- ▶ Fold the wiper arm backward to rest on the windshield. Make sure you hold onto the wiper when folding the wiper arm back.



Never open the hood when the wiper arm is folded forward.

Hold on to the wiper when folding the wiper arm back. If released, the force of the impact from the tensioning spring could crack the windshield.

Do not allow the wiper arms to contact the windshield glass without a wiper blade inserted.

Make certain that the wiper blades are properly installed. Improperly installed wiper blades may cause windshield damage.

For your convenience, we recommend that you have this work carried out by an authorized Mercedes-Benz Center.

Practical hints

Flat tire

Preparing the vehicle

- ▶ Park the vehicle as far as possible from moving traffic on a hard surface.
- ▶ Turn on the hazard warning flashers.
- ▶ Turn the steering wheel so that the front wheels are in a straight ahead position.
- ▶ Set the parking brake.
- ▶ Move the gear selector lever to **P**.

Vehicles with SmartKey:

- ▶ Turn off the engine (▷ page 57).
- ▶ Remove the SmartKey from the starter switch.

Vehicles with SmartKey with KEYLESS-GO*:

- ▶ Turn off the engine by pressing the KEYLESS-GO* button on the gear selector lever once (▷ page 57).
- ▶ Open the driver's door (this puts the starter switch in position **0**, same as with the SmartKey removed from the starter switch). The driver's door then can be closed again.



Open the door only when conditions are safe to do so.

- ▶ Have any passenger exit the vehicle at a safe distance from the roadway.

Mounting the spare wheel

Warning!



Never operate the vehicle with more than one spare wheel mounted.

The spare wheel rim is for temporary use only. Use for over a total of 12 000 miles (20 000 km) (aggregate of all uses) may cause wheel rim failure leading to an accident and possible injuries.

The spare wheel should only be used temporarily and replaced with a regular road wheel as quickly as possible.

S 55 AMG and Sport Package* only:

The spare wheel is for temporary use only. When driving with spare wheel mounted, ensure proper tire inflation pressure and do not exceed vehicle speed of 50 mph (80 km/h).

The dimensions of the spare wheel are different from those of the road wheels. As a result, the vehicle handling characteristics change when driving with a mounted spare wheel. Adapt your driving style accordingly.

Preparing the vehicle

- ▶ Take vehicle tool kit tray and vehicle jack out of trunk.
- ▶ Take the spare wheel out of wheel well (▷ page 379).

Lifting the vehicle

- ▶ Prevent the vehicle from rolling away by blocking wheels with wheel chocks (not included) or other sizable objects.

When changing wheel on a level surface:

- ▶ Place one chock in front of and one behind the wheel that is diagonally opposite to the wheel being changed.

When changing wheel on a hill:

- ▶ Place chocks behind the downhill sides of both wheels of the axle not being worked on.

Warning!



The jack is designed exclusively for jacking up the vehicle at the jack tubes built both sides of the vehicle. To help avoid personal injury, use the jack only to lift the vehicle during a wheel change. Never get beneath the vehicle while it is supported by the jack. Keep hands and feet away from the area under the lifted vehicle. Always firmly set parking brake and block wheels before raising vehicle with jack.

Do not disengage parking brake while the vehicle is raised. Be certain that the jack is always vertical (plumb line) when in use, especially on hills. Always try to use the jack on level surface. Make sure the jack arm is fully inserted in the jack tube. Always lower the vehicle onto sufficient capacity jack-stands before working under the vehicle.

Practical hints

Flat tire



P40.10-2799-31

- ▶ Take the two-piece wheel wrench out of the vehicle tool kit tray. Assemble wheel wrench.
- ▶ On wheel to be changed, loosen but do not yet remove the wheel bolts (approximately one full turn with wrench).

The tube openings are located directly behind the front wheel housings and in front of the rear wheel housings.

Practical hints

Flat tire

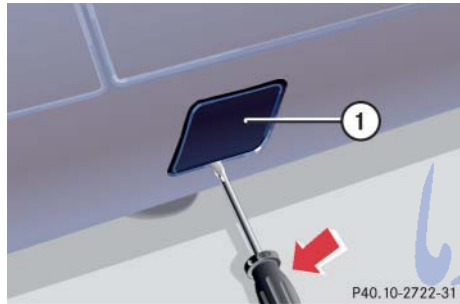

- ① Jack support tube cover
- ▶ Move cover ① toward rear by pressing at point indicated by arrow.
 - ▶ Remove cover ① carefully to avoid damage to the locking tabs.

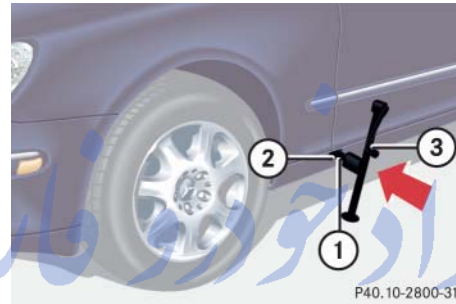

- ① Jack support tube hole
② Jack arm
③ Crank
- ▶ Insert jack arm ② fully into tube hole ① up to the stop.

Warning!



Insert the jack arm fully into the jack support tube hole up to the stop. Otherwise the vehicle may fall from the jack and cause personal injury or damage to the vehicle.

- ▶ Keeping jack in this position, turn crank ③ clockwise until the jack base meets the ground. Make sure the jack is vertical (plumb line).
- ▶ Continue to turn the crank until the tire is a maximum of 1.2 in (3 cm) from the ground.

Warning!



The jack is intended only for lifting the vehicle briefly for wheel changes. It is not suited for performing maintenance work under the vehicle.

- Never start the engine when the vehicle is raised.
- Never lie down under the raised vehicle.

Practical hints

Flat tire

Removing the wheel

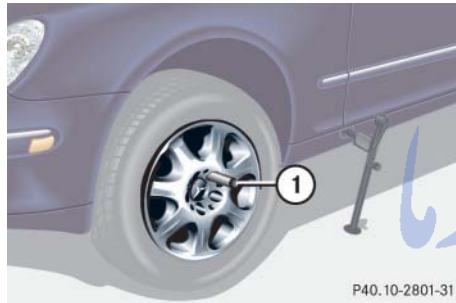

① Alignment bolt

- ▶ Unscrew upper-most wheel bolt and remove.
- ▶ Replace this wheel bolt with alignment bolt ① supplied in the tool kit.
- ▶ Remove the remaining bolts.



Do not place wheel bolts in sand or dirt. This could result in damage to the bolt and wheel hub threads.

- ▶ Remove the wheel.

Mounting the new wheel

- ▶ Clean contact surfaces of wheel and wheel hub.



To avoid paint damage, place wheel flat against hub and hold it there while installing first wheel bolt.

Warning!



Always replace wheel bolts that are damaged or rusted.

Never apply oil or grease to wheel bolts.

Damaged wheel hub threads should be repaired immediately. Do not continue to drive under these circumstances! Contact an authorized Mercedes-Benz Center or call Roadside Assistance.

Incorrect wheel bolts or improperly tightened wheel bolts can cause the wheel to come off. This could cause an accident.

Make sure you are using the correct wheel bolts.

- ▶ Guide the spare wheel onto the alignment bolt and push it on.
- ▶ Insert wheel bolts and tighten them slightly.
- ▶ Unscrew the alignment bolt, install last wheel bolt and tighten slightly.

Warning!



Use only genuine equipment Mercedes-Benz wheel bolts. Other wheel bolts may come loose.

Do not tighten the wheel bolts when the vehicle is raised. Otherwise the vehicle could tip over.

Practical hints

Flat tire

Lowering the vehicle

- ▶ Lower vehicle by turning crank counterclockwise until vehicle is resting fully on its own weight.
- ▶ Remove the jack.

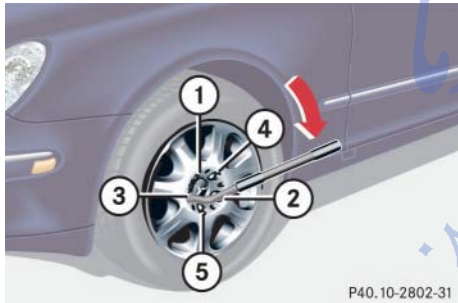

① - ⑤ Wheel bolts

- ▶ Tighten the five wheel bolts evenly, following the diagonal sequence illustrated (① to ⑤), until all bolts are tight. Observe a tightening torque of 110 lb-ft (150 Nm).

Warning!



Have the tightening torque checked after changing a wheel. The wheels could come loose if they are not tightened to a torque of 110 lb-ft (150 Nm).

- ▶ Before storing the jack in the trunk, it should be fully collapsed, with handle folded in.
- ▶ Place the wheel bolt wrench, alignment bolt and jack back in the vehicle tool kit in the trunk and close the covering lid.

Replacing jack support tube cover

- ▶ Slide tongue of cover under the upper edge of the tube opening.
- ▶ Applying even pressure, press cover until it snaps into place. Be careful not to damage the locking tabs or clamp the plastic retaining strap.



You can also screw the faulty wheel down into the spare wheel well in the trunk.

Do not activate the tire inflation pressure monitor* until the depressurized tire is no longer in the vehicle.

▼ Battery

Warning!



Failure to follow these instructions can result in severe injury or death.

Never lean over batteries while connecting, you might get injured.

Battery fluid contains sulfuric acid. Do not allow this fluid to come in contact with eyes, skin or clothing. In case it does, immediately flush affected area with water and seek medical help if necessary.

A battery will also produce hydrogen gas, which is flammable and explosive. Keep flames or sparks away from battery, avoid improper connection of jumper cables, smoking, etc.

Warning!



Do not place metal objects on the battery as this could result in a short circuit.

Use leak-proof battery only to avoid the risk of acid burns in the event of an accident.



Never loosen or detach battery terminal clamps while the engine is running or the SmartKey is in the starter switch. Otherwise the alternator and other electronic components could be severely damaged.

Have the battery checked regularly by an authorized Mercedes-Benz Center. Refer to Maintenance Booklet for maintenance intervals or contact an authorized Mercedes-Benz Center for further information.

Practical hints

Battery

Warning!



With a disconnected battery

- you will no longer be able to turn the SmartKey in the starter switch and pressing the KEYLESS-GO* start/stop button (▷ page 35) on the gear selector lever will have no effect
- the gear selector lever will remain locked in position **P**

The battery is located on the right side of the trunk under the battery cover.

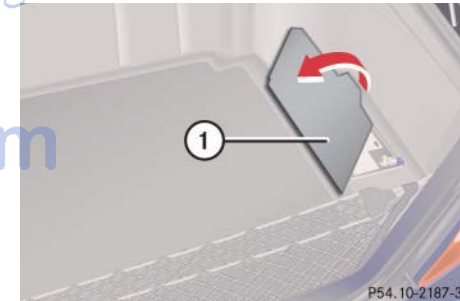

① Battery cover

Practical hints

Battery

- ▶ Pull on the outer, right-hand side of cover ① and remove it in the direction of the arrow.

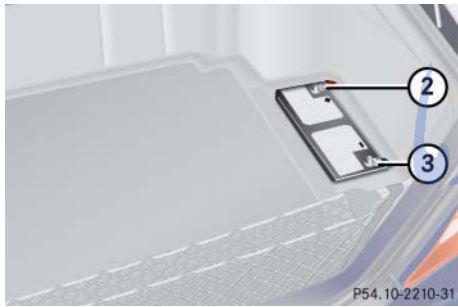

- ② Positive terminal
- ③ Negative terminal

Disconnecting the battery

- ▶ Turn off all electrical consumers.
- ▶ Open the trunk lid (▷ page 103).
- ▶ Remove the battery cover ①.
- ▶ Use a 10 mm open-end wrench to disconnect the battery negative lead ③.
- ▶ Remove cover from the positive terminal ②.
- ▶ Disconnect the battery positive lead ②.

Removing the battery

- ▶ Remove the screw securing the battery.
- ▶ Remove the battery support and bracket.
- ▶ Take out the battery.

Charging and reinstalling the battery

- ▶ Charge battery in accordance with the instructions of the battery charger manufacturer.
- ▶ Reinstall the charged battery. Follow the previously described steps in reverse order.

Warning!



Never charge a battery while still installed in the vehicle. Gases may escape during charging and cause explosions that may result in paint damage, corrosion or personal injury.

Reconnecting the battery

- ▶ Turn off all electrical consumers.
- ▶ Connect the positive lead and fasten its cover ②.
- ▶ Connect negative lead ③.



Never invert the terminal connections.



The battery, its filler caps and the vent tube must always be securely installed when the vehicle is in operation.



The following procedures must be carried out following any interruption of battery power (e.g. due to reconnecting):

- Set the clock (see COMAND operator's manual).
- Synchronize the ESP (▷ page 352).
- Synchronize side windows (▷ page 209).
- Synchronize tilt/sliding sunroof (▷ page 213).

Batteries contain materials that can harm the environment if disposed of improperly. Large 12-volt storage batteries contain lead. Recycling of batteries is the preferred method of disposal. Many states require sellers of batteries to accept old batteries for recycling.

Practical hints

Jump starting

Warning!



Failure to follow these directions will cause damage to the electronic components, and can lead to a battery explosion and severe injury or death.

Never lean over batteries while connecting or jump starting, you might get injured.

Battery fluid contains sulfuric acid. Do not allow this fluid to come in contact with eyes, skin or clothing. In case it does, immediately flush affected area with water, and seek medical help if necessary.

A battery will also produce hydrogen gas, which is flammable and very explosive. Keep flames or sparks away from battery, avoid improper connection of jumper cables, smoking, etc.

Attempting to jump start a frozen battery can result in it exploding, causing personal injury.

Read all instructions before proceeding.

If the battery is discharged, the engine can be started with jumper cables and the battery of another vehicle. Observe the following:

- Jump starting should only be performed when the engine and catalytic converter are cold.
- Do not start the engine if the battery is frozen. Let the battery thaw out first.
- Only use 12 volt battery to jump start your vehicle. Jump starting with a more powerful battery could damage the vehicle's electrical system, which will not be covered by the Mercedes-Benz Limited Warranty.
- Only use jumper cables with sufficient cross-section and insulated terminal clamps.
- Always make sure that the jumper cables are not on or near pulleys, fans or other parts that move when an engine is started or running.



Avoid repeated and lengthy starting attempts.

Do not attempt to start the engine using a battery quick charge unit.

If engine does not run after several unsuccessful starting attempts, have it checked at the nearest authorized Mercedes-Benz Center.

Excessive unburned fuel generated by repeated failed starting attempts may damage the catalytic converter and may present a fire risk.

Make sure the jumper cables do not have loose or missing insulation.

Make sure the cable clamps do not touch any other metal part while the other end is still attached to a battery.



Do not tow-start the vehicle.

Warning!



Keep flames or sparks away from battery.
Do not smoke.

Observe all safety instructions and precautions when handling automotive batteries (▷ page 403).

The battery is located on the right side of the trunk under the battery cover (▷ page 403).

- ▶ Make sure the two vehicles do not touch.
- ▶ Turn off all electrical consumers.
- ▶ Apply parking brake.
- ▶ Shift gear selector lever to position **P**.
- ▶ Open the trunk lid.
- ▶ Remove battery cover (▷ page 403).
- ▶ Remove red cover from positive terminal ①.

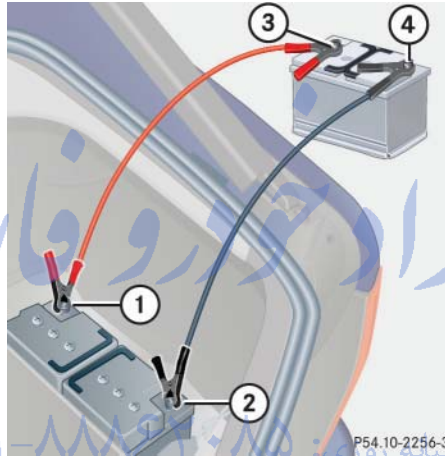

- ① Positive terminal of discharged battery
 - ② Negative terminal of discharged battery
 - ③ Positive terminal of charged battery
 - ④ Negative terminal of charged battery
- ▶ Connect positive terminals ① and ③ of the batteries with the jumper cable. Clamp cable to charged battery ③ first.

Practical hints

Jump starting



Never invert the terminal connections.

- ▶ Start engine of the vehicle with the charged battery and run at idle speed.
- ▶ Connect negative terminals ② and ④ of the batteries with the jumper cable. Clamp cable to charged battery ④ first.
- ▶ Start the engine of the disabled vehicle.

Now you can again turn on the electrical consumers. Do not turn on the lights under any circumstances.

- ▶ Remove the jumper cables first from negative terminals ② and ④ and then from positive terminals ① and ③.

You can now turn on the lights.

- ▶ Have the battery checked at the nearest authorized Mercedes-Benz Center.

Practical hints

Towing the vehicle

Mercedes-Benz recommends that the vehicle be transported with all wheels off the ground using flatbed or appropriate wheel lift/dolly equipment. This method is preferable to other types of towing.



Use flatbed or wheel lift/dolly equipment with SmartKey in starter switch turned to position **0**.

Do not tow with sling-type equipment. Towing with sling-type equipment over bumpy roads will damage radiator and supports.

To prevent damage during transport, do not tie down vehicle by its chassis or suspension parts.

Switch off the tow-away alarm (▷ page 89) and the automatic central locking (▷ page 112).

Do not tow-start the vehicle.

When circumstances do not permit the recommended towing methods, the vehicle may be towed with all wheels on the ground or front wheels raised (except vehicles with 4MATIC) only so far as necessary to have the vehicle moved to a safe location where the recommended towing methods can be employed.



Vehicles with 4MATIC:

Do not tow with one axle raised. Doing so could damage the transfer case, which is not covered by the Mercedes-Benz Limited Warranty.

All wheels must be on or off the ground. Observe instructions for towing the vehicle with all wheels on the ground.



If the vehicle is towed with the front axle raised (not permissible for vehicles with 4MATIC), the engine must be shut off (SmartKey in starter switch position **0** or **1**). Otherwise the ESP will immediately be engaged and will apply the rear wheel brakes.

When towing the vehicle with all wheels on the ground, the selector lever must be in position **N** and the SmartKey must be in starter switch position **2**.

When towing the vehicle with all wheels on the ground or the front axle raised, the vehicle may be towed only for distances up to 30 miles (50 km) and at a speed not to exceed 30 mph (50 km/h).

Practical hints

Towing the vehicle



To be certain to avoid a possibility of damage to the drive train, however, we recommend the drive shaft be disconnected at the rear axle drive flange (vehicles with 4MATIC: disconnected at the front and rear axle drive flanges) for any towing beyond a short tow to a nearby garage.

Warning!



If circumstances require towing the vehicle with all wheels on the ground, always tow with a tow bar if:

- the engine will not run
- there is a malfunction in the power supply or in the vehicle's electrical system as that will be necessary to adequately control the towed vehicle.

Prior to towing the vehicle with all wheels on the ground, make sure the SmartKey is in starter switch position **2**.

If the SmartKey is left in starter switch position **0** for an extended period of time, it can no longer be turned in the switch. In this case, the steering is locked. To unlock, remove SmartKey from starter switch and reinsert.

Warning!



With the engine not running, there is no power assistance for the brake and steering systems. In this case, it is important to keep in mind that a considerably higher degree of effort is necessary to brake and steer the vehicle. Adapt your driving accordingly.



The gear selector lever will remain locked in position **P** and the SmartKey will not turn in the starter switch if the battery is disconnected or discharged. See information on the battery (▷ page 403) or on jump starting (▷ page 406).



To signal turns while being towed with the hazard warning flasher in use, turn SmartKey in starter switch to position **2** and activate the combination switch for the left or right turn signal in the usual manner – only the selected turn signal will operate.

Upon canceling the turn signal, the hazard warning flasher will operate again.

Practical hints

Towing the vehicle



When towing the vehicle with all wheels on the ground, please note the following:

With the automatic central locking activated and the SmartKey in starter switch position **2**, or KEYLESS-GO* start/stop button (▷ page 35) in position **2**, the vehicle doors lock if the left front wheel as well as the right rear wheel are turning at vehicle speeds of approximately 9 mph (15 km/h) or more.

Switch off the tow-away alarm (▷ page 89).

To prevent the vehicle doors from locking, deactivate the automatic central locking (▷ page 112).

Towing of the vehicle should only be done using the properly installed towing eye bolt. Never attach tow cable, tow rope or tow rod to vehicle chassis, frame or suspension parts.

Installing towing eye bolt



① Cover on right side of front bumper

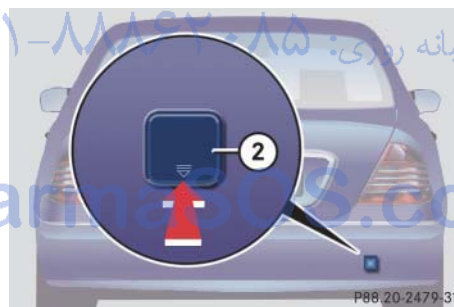

② Cover on right side of rear bumper

Removing cover

- ▶ Press mark on cover in direction of arrow.
- ▶ Lift cover off to reveal threaded hole for towing eye bolt.

Installing towing eye bolt

- ▶ Take towing eye bolt and wheel wrench out of trunk (▷ page 379).
- ▶ Screw towing eye bolt clockwise into its stop and tighten with wheel wrench.

Removing towing eye bolt

- ▶ Loosen towing eye bolt counterclockwise with wheel wrench.
- ▶ Unscrew towing eye bolt.
- ▶ Store towing eye bolt and wheel wrench in trunk.

Installing cover

- ▶ Fit cover and snap into place.

▼ Fuses

Fuses are designed to protect the electrical circuits in your vehicle from a short circuit. If a fuse is blown, the component(s) and systems controlled by that fuse will stop working.

The following aids are available to help you replace fuses (▷ page 411):

- Fuse chart
- Spare fuses
- Special fuse extractor

Warning!



Only use fuses approved by Mercedes-Benz and which have the specified amperage. Using other fuses may cause an overload and lead to a fire, or cause damage to electrical components and/or systems.



Never attempt to repair or bridge a blown fuse. Have the cause determined and remedied by an authorized Mercedes-Benz Center.

Your vehicle's electrical fuses are located in various fuse boxes:

- In the dashboard on the passenger side (▷ page 412)
- In the rear passenger compartment under the right rear seat (▷ page 412)
- In the engine compartment on the driver's side (▷ page 413)
- In the engine compartment on the passenger side (▷ page 413)

Aids for replacing fuses

Fuse chart

A chart explaining fuse allocation and fuse amperages can be found in the vehicle tool kit in the trunk (▷ page 379).

Spare fuses

Spare Fuses are found in the vehicle tool kit in the trunk (▷ page 379).

Fuse extractor

The fuse extractor is found in the vehicle tool kit in the trunk (▷ page 379).

Practical hints

Fuses

Fuse boxes in passenger compartment

There are two fuse boxes. One fuse box is located in the dashboard on the front passenger side. An additional fuse box is located under the right rear seat.

Fuse box in dashboard

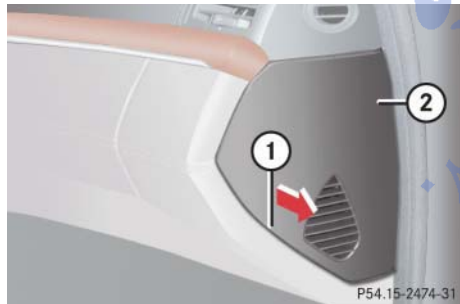

- ① Recess in the cover
- ② Cover



Do not use sharp objects such as a screw driver to open the fuse box cover ② in the dashboard, as this could damage it.

Opening

- ▶ Open the front passenger door.
- ▶ Insert flat, blunt object as a lever in recess ① on the edge of cover ②.
- ▶ Loosen cover ② from the dashboard using lever.
- ▶ Using your hands, pull cover ② in the direction of the arrow and remove.

Closing

- ▶ Hook cover ② into the opening at the front.
- ▶ Press cover ② back on until it engages.

Fuse box in the rear passenger compartment

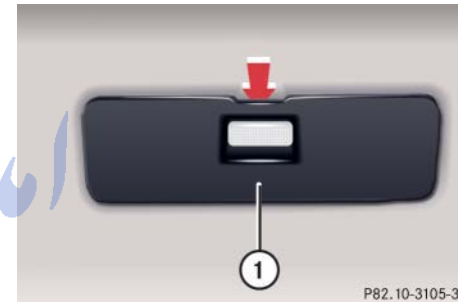

- ① Cover

Opening

- ▶ Pull cover ① away from fuse box in direction of arrow.
- ▶ Remove cover rearward.

Closing

- ▶ Press cover back on until it engages.

Practical hints

Fuses

Fuse boxes in engine compartment

There are fuse boxes located in the engine compartment on the driver's and front passenger side in front of the firewall (dividing wall between engine compartment and passenger compartment).

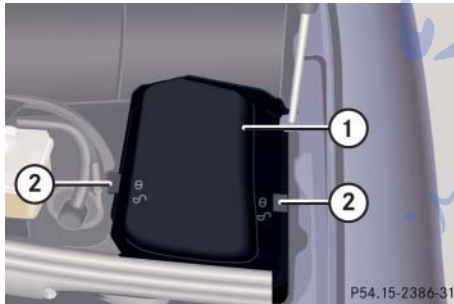

- ① Fuse box cover, driver's side
- ② Slide

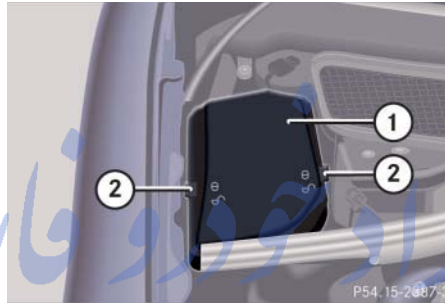

- ① Fuse box cover, passenger side
- ② Slide

Opening

- ▶ Push both slides ② to the  symbol.
- ▶ Remove cover ①.

Closing

- ▶ Replace cover ① and press it down by hand.
- ▶ Push both slides ② to the  symbol.



The cover must fit properly and the slide must be positioned at the  symbol, as moisture or dirt may impair the functionality of the fuses.

FarmaSOS.com



امداد خودرو فارما

تلفن شبانه روزی: ۰۲۱-۸۸۸۶۲۰۸۵

FarmaSOS.com



Technical data

Parts service

Warranty coverage

Identification labels

Layout of poly-V-belt drive

Engine

Rims and tires

Electrical system

Main dimensions and weights

Fuels, coolants, lubricants, etc.

Technical data

Parts service

The “Technical data” section provides the necessary technical data for your vehicle.

All authorized Mercedes-Benz Centers maintain a stock of genuine Mercedes-Benz parts required for maintenance and repair work. In addition, strategically located parts distribution centers provide quick and reliable parts service.

More than 300 000 different parts for Mercedes-Benz models are available.

Genuine Mercedes-Benz parts are subjected to stringent quality inspections. Each part has been specifically developed, manufactured or selected for and adapted to Mercedes-Benz vehicles.

Therefore, genuine Mercedes-Benz parts should be installed.



The use of non-genuine Mercedes-Benz parts and accessories not authorized by Mercedes-Benz could damage the vehicle, which is not covered by the Mercedes-Benz Limited Warranty, or could compromise the vehicle's durability or safety.

FarmaSOS.com

▼ **Warranty coverage**

Your vehicle is covered under the terms of the warranties printed in the Service and Warranty Information booklet. Your authorized Mercedes-Benz Center will exchange or repair any defective parts originally installed on the vehicle in accordance with the terms of the following warranties:

- New Vehicle Limited Warranty
- Emission System Warranty
- Emission Performance Warranty
- California, Maine, Massachusetts, and Vermont Emission Control Systems Warranty

Replacement parts and accessories are covered by the Mercedes-Benz Parts and Accessories warranties, copies of which are available at any authorized Mercedes-Benz Center.

Loss of Service and Warranty Information Booklet

Should you lose your Service and Warranty Information booklet, have an authorized Mercedes-Benz Center arrange for a replacement. It will be mailed to you.

امداد خودرو فارما

تلفن شبانه روزی: ۰۲۱-۸۸۶۲۰۸۵

FarmaSOS.com

Technical data

Identification labels



① Certification label (below driver's door latch)

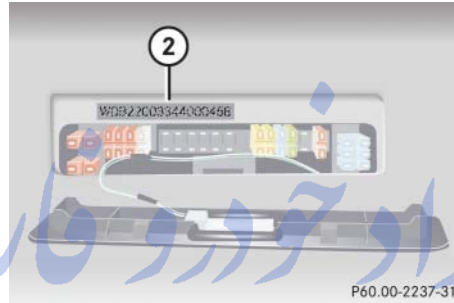

② Vehicle Identification Number (VIN) (below right rear passenger seat)

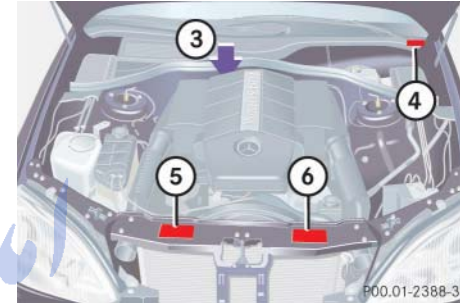

- ③ Engine number (engraved on engine)
- ④ VIN, visible (lower edge of windshield)
- ⑤ Emission control information label, includes both federal and California certification exhaust emission standards
- ⑥ Vacuum line routing diagram label

When ordering parts, please specify vehicle identification and engine numbers.

تلفن شبانه روزی: ۰۲۱-۸۸۶۲۰۸۵

FarmaSOS.com

▼ Layout of poly-V-belt drive

S 430/S 500 (all models)

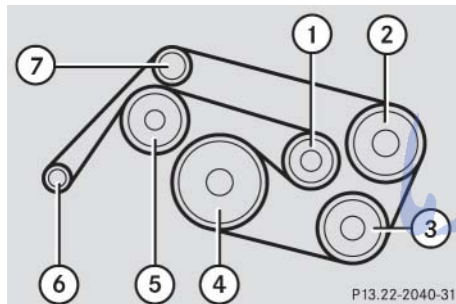

- ① Automatic belt tensioner
- ② ABC tandem pump (pump for power-steering assistance and ABC chassis)
- ③ Air conditioning compressor
- ④ Crankshaft
- ⑤ Coolant pump
- ⑥ Generator (alternator)
- ⑦ Idler pulley

S 55 AMG

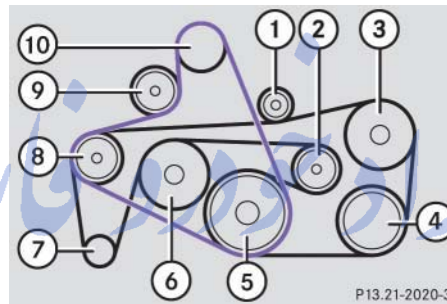

The S 55 AMG has two poly-V-belts (belt one shown in purple/belt two shown in black).

- ① Idler pulley
- ② Automatic belt tensioner
- ③ ABC tandem pump (pump for power-steering assistance and ABC chassis)
- ④ Air conditioning compressor
- ⑤ Crankshaft
- ⑥ Coolant pump
- ⑦ Generator (alternator)
- ⑧ Idler pulley
- ⑨ Automatic belt tensioner
- ⑩ Supercharger

S 600

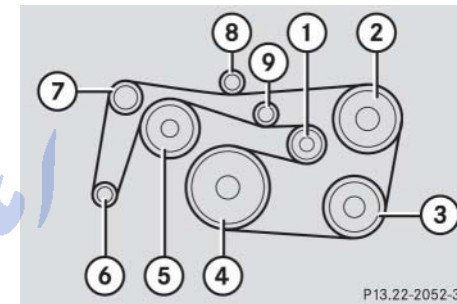

- ① Automatic belt tensioner
- ② ABC tandem pump (pump for power-steering assistance and ABC chassis)
- ③ Air conditioning compressor
- ④ Crankshaft
- ⑤ Coolant pump
- ⑥ Generator (alternator)
- ⑦ Idler pulley
- ⑧ Idler pulley
- ⑨ Idler pulley

Technical data

Engine

Model	S 430 (220.070, 220.170) ¹ S 430 4MATIC (220.183) ¹	S 500 (220.175) ¹ S 500 4MATIC (220.184) ¹
Engine	113	113
Mode of operation	4-stroke engine, gasoline injection	4-stroke engine, gasoline injection
No. of cylinders	8	8
Bore	3.54 in (89.90 mm)	3.82 in (97.00 mm)
Stroke	3.31 in (84.00 mm)	3.31 in (84.00 mm)
Total piston displacement	260.3 cu in (4266 cm ³)	303.0 cu in (4966 cm ³)
Compression ratio	10:1	10:1
Output acc. to SAE J 1349	275 hp/5750 rpm ² (205 kW/5750 rpm)	302 hp/5600 rpm ² (225 kW/5600 rpm)
Maximum torque acc. to SAE J 1349	295 lb-ft/3000 - 4400 rpm (400 Nm/3000 - 4400 rpm)	339 lb-ft/2700 - 4250 rpm (460 Nm/2700 - 4250 rpm)
Maximum engine speed	6000 rpm	6000 rpm
Firing order	1-5-4-2-6-3-7-8	1-5-4-2-6-3-7-8
Poly-V-belt	2380 mm	2380 mm

¹ The quoted data apply only to the standard vehicle. See an authorized Mercedes-Benz Center for the corresponding data of all special bodies and special equipment.

² Premium fuel required. Performance may vary with fuel octane rating.

Technical data

Engine

Model	S 55 AMG (220.174) ¹	S 600 (220.176) ¹
Engine	113	275
Mode of operation	4-stroke engine, gasoline injection	4-stroke engine, gasoline injection
No. of cylinders	8	12
Bore	3.82 in (97.00 mm)	3.23 in (82.00 mm)
Stroke	3.62 in (92.00 mm)	3.43 in (87.00 mm)
Total piston displacement	331.8 cu in (5439 cm ³)	336.4 cu in (5513 cm ³)
Compression ratio	9:1	9:1
Output acc. to SAE J 1349	493 hp/6100 rpm ² (368 kW/6100 rpm)	493 hp/5000 rpm ² (368 kW/5000 rpm)
Maximum torque acc. to SAE J 1349	516 lb-ft/2750 - 4000 rpm (700 Nm/2750 - 4000 rpm)	590 lb-ft/1800 - 3500 rpm (800 Nm/1800 - 3500 rpm)
Maximum engine speed	6500 rpm	5950 rpm
Firing order	1-5-4-2-6-3-7-8	1-12-5-8-3-10-6-7-2-11-4-9
Poly-V-belt	Belt one: 1289 mm Belt two: 2462 mm	2335 mm

¹ The quoted data apply only to the standard vehicle. See an authorized Mercedes-Benz Center for the corresponding data of all special bodies and special equipment.

² Premium fuel required. Performance may vary with fuel octane rating.

Technical data

Rims and tires

Use only tires and rims which have been specifically developed for your vehicle and tested and approved by Mercedes-Benz. Other tires and rims can have detrimental effects, such as:

- Poor handling characteristics
- Increased noise
- Increased fuel consumption



Moreover, tires and rims not approved by Mercedes-Benz may, under load, exhibit dimensional variations and different tire deformation characteristics that could cause them to come into contact with the vehicle body or axle parts. Damage to the tires or the vehicle may be the result.



Further information on tires and rims is available at any authorized Mercedes-Benz Center. A placard with the recommended tire inflation pressures is located on the driver's door B-pillar. Some vehicles may have supplemental tire pressure information for driving at high speeds (> page 306) or for vehicle loads less than the maximum loaded vehicle condition. If such information is provided, it can be found on the placard located on the inside of the fuel filler flap. The tire pressure should be checked regularly and should only be adjusted on cold tires. Follow tire manufacturer's maintenance recommendation included with vehicle.

تلفن شبانه روزی: ۰۲۱-۸۸۶۲۰۸۵

FarmaSOS.com

Technical data

Rims and tires

Same size tires

	S 430, S 430 4MATIC S 500, S 500 4MATIC (except Sport Package* and except Appearance Package*)	S 600 (except Sport Package* and except Appearance Package*)	S 430, S 430 4MATIC, S 500, S 500 4MATIC, S 600 (Appearance Package*)
Rims (light alloy)	7 ¹ / ₂ J x17 H2	8 J x18 H2 ¹	8 J x18 H2 ¹
Wheel offset	1.81 in (46 mm)	1.73 in (44 mm)	1.73 in (44 mm)
Summer tires (radial-ply tires)	-	245/45 R18 96Y ¹	245/45 R18 96Y ¹
All-season tires (radial-ply tires)	225/55 R17 97H M+S	-	-
Winter tires (radial-ply tires)	225/55 R17 97H M+S	245/45 R18 100V XL (Extra Load) M+S ¹ or 245/45 R18 96H M+S ¹	245/45 R18 100V XL (Extra Load) M+S ¹ or 245/45 R18 96H M+S ¹

¹ For use with snow chains contact an authorized Mercedes-Benz Center

Technical data

Rims and tires

	S 430, S 500, S 600 (Sport Package*) S 55 AMG	S 430 4MATIC, S 500 4MATIC (Sport Package*)
Rims (light alloy)	8 J x18 H2 ^{1,2} or 8 ¹ / ₂ J x18 EH2 ³	8 J x18 H2d ^{1,2} or 8 ¹ / ₂ J x18 EH2 ³
Wheel offset	1.73 in (44 mm)	1.73 in (44 mm)
Summer tires (radial-ply tires)	-	245/45 R18 100Y XL (Extra Load)
All-season tires (radial-ply tires)	-	-
Winter tires (radial-ply tires)	245/45 R18 100V XL (Extra Load) M+S ² or 245/45 R18 96H M+S ²	245/45 R18 100V XL (Extra Load) M+S ² or 245/45 R18 96H M+S ²

¹ For use with winter tires only

² For use with snow chains contact an authorized Mercedes-Benz Center

³ Must not be used with snow chains

تلفن شبانه روزی: ۰۲۱-۸۸۶۲۰۸۵
FarmaSOS.com

Technical data

Rims and tires

Mixed size tires

		S 430, S 500, S 600 (Sport Package*)	S 55 AMG
Front axle:	AMG light alloy rims	8 ¹ / ₂ J x 18 EH2 ¹	8 ¹ / ₂ J x 18 EH2 ¹
	Wheel offset	1.73 in (44 mm)	1.73 in (44 mm)
	Summer tires (radial-ply tires)	245/45 R18 100Y XL (Extra Load) or 245/45 R18 96Y	245/45 R18 100Y XL (Extra Load)
Rear axle:	AMG light alloy rims	9 J x 18 EH2 ¹	9 J x 18 EH2 ¹
	Wheel offset	1.73 in (44 mm)	1.73 in (44 mm)
	Summer tires (radial-ply tires)	265/40 R18 101Y XL (Extra Load) ¹ or 265/40 R18 97Y ¹	265/40 R18 101Y XL (Extra Load) ¹

¹ Must not be used with snow chains

FarmaSOS.com

Technical data

Rims and tires

Spare wheel

	S 430, S 430 4MATIC, S 500, S 500 4MATIC (except Sport Package* and except Appearance Package*)	S 430, S 430 4MATIC, S 500, S 500 4MATIC (Sport Package* and Appearance Package*) S 600, S 55 AMG
Rims (light alloy)	7 ¹ / ₂ J x 17 H2	8 J x 18 H2
Wheel offset	2.0 in (51 mm)	1.73 in (44 mm)
Summer tires (radial-ply tires)	-	245/45 R18 96Y
All-season tires (radial-ply tires)	225/55 R17 97H M+S	-

تلفن شبانه روزی: ۰۲۱-۸۸۶۲۰۸۵

FarmaSOS.com

Technical data

Electrical system

▼ Electrical system

Model	S 430, S 500	S 55 AMG	S 600
Generator (alternator)	14 V/150 A	14 V/180 A	14 V/220 A
Starter motor	12 V/1.7 kW	12 V/1.7 kW	12 V/1.7 kW
Battery	12 V/95 Ah	12 V/95 Ah	12 V/95 Ah
Spark plugs	Bosch F 8 DPP 332 NGK PFR 5 R-11	NGK IL FR 6 A	NGK IFR 6Q-G
Electrode gap	0.039 in (1.0 mm)	0.031 in (0.8 mm)	0.028 in (0.7 mm)
Tightening torque	15 - 22 lb-ft (20 - 30 Nm)	18 - 22 lb-ft (25 - 30 Nm)	15 - 22 lb-ft (20 - 30 Nm)

تلفن شبانه روزی: ۰۲۱-۸۸۶۲۰۸۵

FarmaSOS.com

Technical data

Main dimensions and weights

Main dimensions

Model	S 430 (220.070)	S 430 (220.170) S 430 4MATIC (220.183) S 500 (220.175) S 500 4MATIC (220.184)	S 55 AMG (220.174)	S 600 (220.176)
Overall vehicle length	198.3 in (5038 mm)	203.1 in (5158 mm)	203.1 in (5158 mm)	203.1 in (5158 mm)
Overall vehicle width	73.0 in (1855 mm)	73.0 in (1855 mm)	73.0 in (1855 mm)	73.0 in (1855 mm)
Overall vehicle height	57.2 in (1454 mm)	57.2 in (1454 mm)	57.2 in (1454 mm)	57.4 in (1457 mm)
Wheelbase	116.7 in (2965 mm)	121.5 in (3085 mm)	121.5 in (3085 mm)	121.5 in (3085 mm)
Track, front	62.0 in (1574 mm)	62.0 in (1574 mm)	62.1 in (1578 mm)	62.0 in (1574 mm)
Track, rear	62.0 in (1574 mm)	62.0 in (1574 mm)	62.1 in (1578 mm)	62.0 in (1574 mm)

Weights

Max. roof load	220 lbs (100 kg)
Max. trunk load	220 lbs (100 kg)

Technical data

Fuels, coolants, lubricants, etc.

▼ Fuels, coolants, lubricants, etc.

Capacities

Vehicle components and their respective lubricants must match. Therefore use only brands tested and approved by us.

Please refer to the Factory Approved Service Products pamphlet, or inquire at your Mercedes-Benz Center.

	Model	Capacity	Fuels, coolants, lubricants, etc.
Engine with oil filter	S 430	8.5 US qt. (8.0 l)	Approved engine oils
	S 500	8.5 US qt. (8.0 l)	
	S 55 AMG	7.9 US qt. (7.5 l)	
	S 600	9.5 US qt. (9.0 l)	
Automatic transmission	S 600	9.1 US qt. (8.6 l)	MB Automatic Transmission Fluid
		8.1 US qt. (7.7 l)	
Rear axle	S 55 AMG S 600	1.7 US qt. (1.6 l)	Hypoid gear oil SAE 85 W 90
		2.1 US qt. (2.0 l)	
		2.1 US qt. (2.0 l)	
Front axle	S 430 4MATIC	0.63 US qt. (0.6 l)	Hypoid gear oil SAE 85 W 90
	S 500 4MATIC		
Transfer case	S 430 4MATIC	0.62 US qt. (0.585 l)	MB Transfer Case Oil
	S 500 4MATIC		
Hydraulic system for ADS or ABC		4.2 US qt. (4.0 l)	MB Hydraulic Fluids
Power steering		approx. 1.1 US qt. (1.0 l)	MB Power Steering Fluid (Pentosin CHF 11S)

Technical data

Fuels, coolants, lubricants, etc.

	Model	Capacity	Fuels, coolants, lubricants, etc.
Front wheel hubs		approx. 3.5 oz. (100 g) each	High-temperature roller bearing grease
Brake system		0.7 US qt. (0.7 l)	MB Brake Fluid (DOT 4+)
Cooling system	S 430, S 500 S 55 AMG S 600	approx. 12.1 US qt. (11.5 l) approx. 14.3 US qt. (13.5 l) approx. 15.85 US qt. (15 l)	MB 325.0 Anticorrosion/Antifreeze
Low temperature cooling system	S 600	2.3 US qt. (2.2 l)	MB 325.0 Anticorrosion/Antifreeze
Fuel tank		23.2 US gal (88.0 l)	Premium unleaded gasoline:
including a reserve of	S 430, S 500, S 600	2.9 US gal (11.0 l)	Minimum Posted Octane 91
including a reserve of	S 55 AMG	3.7 US gal (14.0 l)	(Avg. of 96 RON/86 MON)
Air conditioning system			R-134a refrigerant and special PAG lubricant oil (never R-12)
Windshield washer		3.2 US qt. (3.0 l)	MB Windshield Washer Concentrate ¹
Windshield washer and headlamp cleaning system		7.1 US qt. (6.7 l)	MB Windshield Washer Concentrate ¹

¹ Use MB Windshield Washer Concentrate "S" and water for temperatures above freezing or MB Windshield Washer Concentrate "S" and commercially available pre-mixed windshield washer solvent/antifreeze for temperatures below freezing point. Follow suggested mixing ratios (▷ page 436).

Technical data

Fuels, coolants, lubricants, etc.

Engine oils

Engine oils are specifically tested for their suitability in our engines and durability for our service intervals. Therefore, only use approved engine oils and oil filters required for vehicles with Maintenance System (U.S. vehicles) or FSS (Canada vehicles). For a listing of approved engine oils and oil filters, refer to the Factory Approved Service Products pamphlet, or contact an authorized Mercedes-Benz Center.

Using engine oils and oil filters of specification other than those expressly required for the Maintenance System (U.S. vehicles) or FSS (Canada vehicles), or changing of oil and oil filter at change intervals longer than those called for by the Maintenance System (U.S. vehicles) or FSS (Canada Vehicles) will result in engine damage not covered by the Mercedes-Benz Limited Warranty.

Please follow Maintenance System (U.S. vehicles) or FSS (Canada vehicles) recommendations for scheduled oil changes. Failure to do so will result in engine damage not covered by the Mercedes-Benz Limited Warranty.

Engine oil additives

Do not blend oil additives with engine oil. They may damage the engine. Damage or malfunctions resulting from blending oil additives are not covered by the Mercedes-Benz Limited Warranty.

Air conditioning refrigerant

R-134a (HFC) refrigerant and special PAG lubricating oil is used in the air conditioning system. Never use R-12 (CFC) or mineral-based lubricating oil. Otherwise damage to the system will occur.

Brake fluid

During vehicle operation, the boiling point of the brake fluid is continuously reduced through the absorption of moisture from the atmosphere. Under extremely strenuous operating conditions, this moisture content can lead to the formation of bubbles in the system, thus reducing the system's efficiency. Therefore, the brake fluid must be replaced every two years, preferably in the spring. Only brake fluid approved by Mercedes-Benz is recommended. Your authorized Mercedes-Benz Center will provide you with additional information.

Technical data

Fuels, coolants, lubricants, etc.

Premium unleaded gasoline



To maintain the engine's durability and performance, premium unleaded gasoline must be used. If premium unleaded gasoline is not available and low octane fuel is used, follow these precautions:

- Have the fuel tank only partially filled with unleaded regular and fill up with premium unleaded as soon as possible.
- Avoid full throttle driving and abrupt acceleration.
- Do not exceed an engine speed of 3000 rpm if the vehicle is loaded with a light load such as two persons and no luggage.
- Do not exceed 2/3 of maximum accelerator pedal position if the vehicle is fully loaded or operating in mountainous terrain.

Fuel requirements

Use only premium unleaded fuel:

- The octane number (posted at the pump) must be 91 min. It is an average of both the Research (R) octane number and the Motor (M) octane number: $(R+M)/2$. This is also known as the ANTI-KNOCK INDEX.

Unleaded gasoline containing oxygenates such as Ethanol, IPA, IBA and TBA can be used provided the ratio of any one of these oxygenates to gasoline does not exceed 10%; MTBE must not exceed 15%.

The ratio of Methanol to gasoline must not exceed 3% plus additional co-solvents.

Using mixtures of Ethanol and Methanol is not allowed. Gasohol, which contains 10% Ethanol and 90% unleaded gasoline, can be used.

These blends must also meet all other fuel requirements, such as resistance to spark knock, boiling range, vapor pressure, etc.

Gasoline additives

A major concern among engine manufacturers is carbon build-up caused by gasoline. Mercedes-Benz recommends only the use of quality gasoline containing additives that prevent the build-up of carbon deposits.

After an extended period of using fuels without such additives, carbon deposits can build up especially on the intake valves and in the combustion area, leading to engine performance problems such as:

- Warm-up hesitation
- Unstable idle
- Knocking/pinging
- Misfire
- Power loss

In areas where carbon deposits may be encountered due to lack of availability of gasolines which contain these additives, Mercedes-Benz recommends the use of additives approved by us for use on Mercedes-Benz vehicles. Refer to Factory Approved Service Products Pamphlet for a listing of approved product(s). Follow directions on product label.

Do not blend any specific fuel additives with fuel. This only results in unnecessary cost and may be harmful to the engine operation.

Damage or malfunction resulting from poor fuel quality or from blending additional fuel additives other than those tested and approved by us for use on Mercedes-Benz vehicles listed in the Factory Approved Service Products Pamphlet are not covered by the Mercedes-Benz Limited Warranty.

Coolants

The engine coolant is a mixture of water and anticorrosion/antifreeze, which provides:

- Corrosion protection
- Freeze protection
- Boiling protection (by increasing the boiling point)

The cooling system was filled at the factory with a coolant providing freeze protection to approximately -22°F (-30°C) and corrosion protection.

If the antifreeze mixture is effective to -22°F (-30°C), the boiling point of the coolant in the pressurized cooling system is reached at approximately 266°F (130°C).

The coolant solution must be used year-round to provide the necessary corrosion protection and increase boil-over protection. Refer to Maintenance Booklet for replacement interval.

Coolant system design and coolant used determine the replacement interval. The replacement interval published in the Maintenance Booklet is only applicable if MB 325.0 Anticorrosion/Antifreeze solution or other Mercedes-Benz approved products of equal specification (see Factory Approved Service Products pamphlet) are used to renew the coolant concentration or bring it back up to the proper level.

To provide important corrosion protection, the solution must be at least 45% anticorrosion/antifreeze [equivalent to freeze protection to approximately -22°F (-30°C)]. If you use a solution that is more than 55% anticorrosion/antifreeze [freeze protection to approximately -49°F (-45°C)], the engine temperature will increase due to the lower heat transfer capa-

Technical data

Fuels, coolants, lubricants, etc.

bility of the solution. Therefore, do not use more than this amount of anticorrosion/antifreeze.

If the coolant level is low, water and MB 325.0 Anticorrosion/Antifreeze should be used to bring it up to the proper level (have cooling system checked for signs of leakage).

The water in the cooling system must meet minimum requirements, which are usually satisfied by normal drinking water. If you are not sure about the water quality, consult an authorized Mercedes-Benz Center.

Anticorrosion/antifreeze

Your vehicle contains a number of aluminum parts. The use of aluminum components in motor vehicle engines necessitates that anticorrosion/antifreeze coolant used in such engines be specifically formulated to protect the aluminum parts. (Failure to use such anticorrosion/antifreeze coolant will result in a significantly shortened service life.)

Therefore, the following product is strongly recommended for use in your vehicle: Mercedes-Benz 325.0 Anticorrosion/Antifreeze Agent.

Before the start of the winter season (or once a year in hot southern regions), you should have the anticorrosion/antifreeze concentration checked. The coolant is also regularly checked each time you bring your vehicle to an authorized Mercedes-Benz Center for service.

تلفن شبانه روزی: ۰۲۱-۸۸۶۲۰۸۵

FarmaSOS.com

Technical data

Fuels, coolants, lubricants, etc.

Anticorrosion/antifreeze quantity

Model	Approx. freeze protection	
	- 35°F (- 37°C)	- 49°F (- 45°C)
S 430, S 500	6.1 US qt. (5.75 l)	6.7 US qt. (6.3 l)
S 600 (main cooling system)	7.9 US qt. (7.5 l)	8.7 US qt. (8.25 l)
S 600 (low temperature cooling system)	1.2 US qt. (1.1 l)	1.3 US qt. (1.2 l)
S 55 AMG	7.1 US qt. (6.75 l)	7.8 US qt. (7.4 l)

تلفن شبانه روزی: ۰۲۱-۸۸۶۲۰۸۵

FarmaSOS.com

Technical data

Fuels, coolants, lubricants, etc.

Windshield and headlamp washer system

Both the windshield and headlamp washer systems are supplied from the windshield washer fluid reservoir.

The washer fluid reservoir has a capacity of approximately:

- 3.2 US qt. (3.0 l) in vehicles without headlamp cleaning system*
- 7.4 US qt. (7.0 l) in vehicles with headlamp cleaning system* or heated reservoir

- ▶ Refill the reservoir with MB Windshield Washer Concentrate and water (or concentrate and commercially available premixed windshield washer solvent/antifreeze, depending on ambient temperatures).

Warning

Washer solvent/antifreeze is highly flammable. Do not spill washer solvent/antifreeze on hot engine parts, because it may ignite and burn. You could be seriously burned.



Windshield and headlamp washer fluid mixing ratio

For temperatures above freezing point, use MB Windshield Washer Concentrate "S" and water:

- 1 part "S" to 100 parts water [40 ml "S" to 1 gallon (4 liters) water].

For temperatures below freezing point, use MB Windshield Washer Concentrate "S" and commercially available premixed windshield washer solvent/antifreeze:

- 1 part "S" to 100 parts solvent [40 ml "S" to 1 gallon (4 liters) solvent].

FarmaSOS.com

ABC

(Active Body Control)
Active, computer-controlled system that hydraulically adjusts the suspension at all four wheels in response to various driving situations.

ABS

(Antilock Brake System)
Prevents the wheels from locking up during braking so that the vehicle can continue to be steered.

ADS

(Adaptive Damping System)
Automatically adapts the optimum suspension damping to prevailing driving conditions.

Airmatic

Automatically selects the optimum suspension tuning and ride height for your vehicle. Airmatic consists of two components:

- Adaptive Damping System
- Vehicle level control

Alignment bolt

Metal pin with thread. The centering pin is an aid used when changing a tire to align the wheel with the wheel hub.

BabySmart™ air bag deactivation system

This system detects if a special system compatible child restraint seat is installed on the front passenger seat. The system will automatically deactivate the passenger front air bag when such a seat is properly installed (the  indicator lamp in the center console comes on). See an authorized Mercedes-Benz Center for availability.

BabySmart™ compatible child seats

Special restraint system for children. The sensor system for the passenger seat prevents deployment of the passenger front air bag if a BabySmart™ compatible child seat is installed. See an authorized Mercedes-Benz Center for availability.

BAS

(Brake Assist System)
System for potentially reducing braking distances in emergency braking situations. The system is activated when it senses an emergency based on how fast the brake is applied.

Bi-xenon headlamps

Headlamps which use an electric arc as the light source and produce a more intense light than filament headlamps. Bi-xenon headlamps produce low beam and high beam.

CAC

(Customer Assistance Center)
Mercedes-Benz customer service center, which can help you with any questions about your vehicle and provide assistance in the event of a breakdown.

Technical terms

CAN system

(Controller Area Network)
Data bus network serving to control vehicle functions such as door locking or windshield wiping.

Cockpit

All instruments, switches, buttons and indicator/warning lamps in the passenger compartment needed for vehicle operation and monitoring.

COMAND

(Cockpit Management and Data System)
Information and operating center for vehicle sound and communications systems, including the radio and navigation system, as well as other optional equipment (CD changer, telephone, etc.).

Control system

The control system is used to call up vehicle information and to change component settings. Information and messages appear in the multifunction display. The driver uses the buttons on the multifunction steering wheel to navigate through the system and to adjust settings.

Cruise control

Driving convenience system that automatically maintains the vehicle speed set by the driver.

Distronic*

A driving convenience cruise control system which helps the driver maintain a pre-selected speed:

- If there is no vehicle directly ahead, the system operates in the same way as conventional ->cruise control.
- If a slower moving vehicle is ahead, Distronic will reduce your vehicle speed to the extent permitted by reduced throttle and up to 20% braking power to maintain the preset minimum following distance.

Engine number

The number set by the manufacturer and stamped on the cylinder block to uniquely identify each engine produced.

Engine oil viscosity

Measurement for the inner friction (viscosity) of the oil at different temperatures. The higher the temperature an oil can tolerate without becoming thin, or the lower the temperature it can tolerate without becoming viscous, the better the viscosity.

ESP

(Electronic Stability Program)
Improves vehicle handling and directional stability.

ETD

(Emergency Tensioning Device)
Device which deploys in certain frontal and rear collisions exceeding the system's threshold to tighten the seat belts.

->SRS

FSS (Canada vehicles)

(Flexible Service System)
Maintenance service indicator in the multifunction display that informs the driver when the next vehicle maintenance service is due. FSS evaluates engine temperature, oil level, vehicle speed, engine speed, distance driven and the time elapsed since your last maintenance service, and calls for the next maintenance service accordingly.

Gear range

Number of gears which are available to the automatic transmission for shifting. The automatic gear shifting process can be adapted to specific operating conditions using the selector lever.

GPS

(Global Positioning System)
Satellite-based system for relaying geographic location information to and from vehicles equipped with special receivers. Employs DVD digital maps for navigation.

Instrument cluster

The displays and indicator/warning lamps in the driver's field of vision, including the tachometer, speedometer, engine temperature and fuel gauge.

KEYLESS-GO*

System for entering and operating the vehicle without the use of a SmartKey.

Kickdown

Depressing the accelerator past the point of resistance shifts the transmission down to the lowest possible gear. This very quickly accelerates the vehicle and should not be used for normal acceleration needs.

Technical terms

Line of fall

The direct line that an object moves downhill when influenced by the force of gravity alone.

Lock button

Button on the door which indicates whether the door is locked or unlocked. Pushing the lock button down on an individual door from inside will lock that door.

Maintenance System (U.S. vehicles)

Maintenance service indicator in the multifunction display that informs the driver when the next vehicle maintenance service is due. The Maintenance System in your vehicle tracks distance driven and the time elapsed since your last maintenance service, and calls for the next maintenance service accordingly.

Memory function

Used to store three individual seat, steering wheel and exterior mirror positions for each SmartKey or SmartKey with KEYLESS-GO*.

MON

(Motor Octane Number)

The Motor Octane Number for gasoline as determined by a standardized method. It is an indication of a gasoline's ability to resist undesired detonation (knocking). The average of both the MON (Motor Octane Number) and →RON (Research Octane Number) is posted at the pump, also known as ANTI-KNOCK INDEX.

Multifunction display

Display field in the speedometer used to present information provided by the control system.

Multifunction steering wheel

Steering wheel with buttons for operating the control system.

Overspeed range

Engine speeds within the red marking of the tachometer dial. Avoid this engine speed range, as it may result in serious engine damage that is not covered by the Mercedes-Benz Limited Warranty.

Parktronic system (Parking assist)*

System which uses visual and acoustic signals to assist the driver during parking maneuvers.

Poly-V-belt drive

Drives engine components (alternator, AC compressor, etc.) from the engine.

Power train

Collective term designating all components used to generate and transmit motive power to the drive axles, including:

- Engine
- Clutch/torque converter
- Transmission
- Transfer case
- Drive shaft
- Differential
- Axle shafts/axles

Program mode selector switch

Used to switch the automatic transmission between standard operation **S** and comfort operation **C**.

S 55 AMG with steering wheel gearshift control and manual shift program: in addition to **S** and **C** (see above), you can use **M** for manual operation.

REST

(Residual engine heat utilization)
Feature that uses the engine heat stored in the coolant to heat the vehicle interior for a short time after the engine has been turned off.

Restraint systems

Seat belts, belt tensioners, air bags and child restraint systems. As independent systems, their protective functions complement one another.

RON

(Research Octane Number)
The Research Octane Number for gasoline as determined by a standardized method. It is an indication of a gasoline's ability to resist undesired detonation (knocking). The average of both the →MON (Motor Octane Number) and RON (Research Octane Number) is posted at the pump, also known as ANTI-KNOCK INDEX.

Shift lock

When the vehicle is parked, this lock prevents the transmission selector lever from being inadvertently moved out of position **P** without the SmartKey turned and the brake pedal depressed.

SRS

(Supplemental Restraint System)
Seat belts, emergency tensioning device and air bags. Though independent systems, they are closely interfaced to provide effective occupant protection.

Technical terms

Tele Aid System

(Telematic Alarm Identification on Demand)

The Tele Aid system consists of three types of response: automatic and manual emergency, Roadside Assistance and information. Tele Aid is initially activated by completing a subscriber agreement and placing an acquaintance call.

The Tele Aid system is operational provided that the vehicle's battery is charged, properly connected, not damaged and cellular and GPS coverage is available.

Telematics*

A combination of the terms "telecommunications" and "informatics."

Tightening torque

Force times lever arm (e.g. a lug wrench) with which threaded fasteners such as wheel bolts are tightened.

Tire speed rating

Part of a tire designation; indicates the speed range for which a tire is approved.

Traction

Force exerted by the vehicle on the road via the tires.

VIN

(Vehicle Identification Number)

The number set by the manufacturer and stamped on the body to uniquely identify each vehicle produced.

Voice control system*

Voice control system for car phones, portable cell phones and audio systems (radio, CD, etc.).

A

- ABC 231, 437
 - Messages in display 349, 354
 - Setting vehicle level 230, 232
- ABS 25, 80, 437
 - Malfunction indicator lamp 338
 - Messages in display 350
 - Warning lamp 338
- Accelerator position, automatic transmission 180
- Accessory weight 322
- Accident
 - In case of 54
- Activating
 - Air conditioner (cooling) 203
 - Air conditioning 202
 - Air recirculation mode 199
 - Anti-theft alarm system 87
 - Central locking (control system) 168
 - Charcoal filter 200
 - Distance warning function* 226
 - DISTRONIC* 222
 - Easy-entry/exit feature 170
 - ESP 84
 - Exterior lamps 132
 - Exterior rear view mirror parking position 187
 - Front and rear fog lamp 132, 134
 - Hazard warning flasher 136
 - Headlamps 50
 - High beams 135
 - Ignition 34
 - Ignition with KEYLESS-GO* start/stop button 36
 - Immobilizer 57, 86
 - Limiting opening height of trunk lid* 169
 - Manual shift program S 55 AMG 183
 - Rear window defroster 201
 - Residual heat 203
 - Seat heater 125, 126
 - Seat ventilation* 127
 - Tow-away alarm 89
 - Windshield wipers 52
- Adaptive Damping System (ADS) 229, 437
- Adding
 - Coolant 293
 - Engine oil 291
- Additional turn signals 390
- Adjustable air vents, rear passenger compartment 204
- Adjusting 37
 - Air distribution 196
 - Air volume 198
 - Backrest tilt 38
 - Drive-dynamic seat* 172
 - Exterior rear view mirror 41
 - Head restraint height 39
 - Head restraint tilt 39
 - Instrument cluster illumination 140
 - Interior rear view mirror 41
 - Lumbar support 122
 - Mirrors 41
 - Multicontour backrest* 122
 - Power seat bench* 117
 - Seat cushion depth 38, 123

Index

- Seat cushion tilt 38
- Seat fore and aft adjustment 38
- Seat height 38
- Seat in the lumbar region 123
- Seat in the shoulder region 123
- Seats 37
- Steering column height 40
- Steering column in or out 40
- Steering column up or down 40
- Steering wheel 40
- ADS 229, 437
- Air bags 61
 - BabySmart™ air bag deactivation system 73, 437
 - Children 62
 - Front 65
 - Passenger 65
 - Safety guidelines 64
 - Side impact 65
 - Window curtain 66
- Air bag off indicator lamp 346
- Air conditioning
 - Turning off 202
 - Turning on 202
- Air pressure 322
- Air pressure see Tire inflation pressure
- Air recirculation mode 199
 - Activating 199
 - Deactivating 200
- Air vents, rear passenger compartment
 - Adjustable 204
- Air volume
 - Adjusting 198
- AIRMATIC 229
- Airmatic 229, 437
- Alarm
 - Audible 79, 88
 - Canceling 88
 - Visual 87
- Alarm system
 - Anti-theft 87
 - Anti-theft alarm system indicator lamp 27
- Alignment bolt (vehicle tool kit) 380, 401, 437
- Antiglare
 - Automatic 186
- Antilock brake system (ABS) 437
- Antilock Brake System see ABS 25
- Anti-theft alarm system
 - Arming 87
 - Canceling alarm 88
 - Disarming 88
- Anti-theft systems 86
 - Anti-theft alarm system 87
 - Anti-theft alarm system indicator lamp 27
 - Immobilizer 86
 - Tow-away alarm 89
- Aquaplaning see Hydroplaning 277

- Armrest
 Storage compartment in front of 245, 246, 247
 Ashtray 251
 Aspect ratio 322
 At the gas station 283
 ATF (Automatic Transmission Fluid) 292
 AUDIO menu 148
 Selecting CD track 150
 Selecting MP3-CD track 150
 Selecting radio station 149
 Selecting satellite radio* station (USA only) 149
 Audio system
 CD mode 151
 Auto-dimming for rear view mirror 186
 Automatic central locking
 Activating/deactivating (control system) 168
 Automatic climate control 192
 Air recirculation mode 199
 Defrosting 199
 Rear window defroster 201
 Setting the temperature 195
 Automatic headlamp mode 132
 Automatic lighting control
 Activating 137
 Deactivating 137
 Automatic locking when driving 112
 Automatic shift program
 Automatic transmission 179
 Automatic transmission 173
 Accelerator position 180
 Automatic shift program 179
 Emergency operation (Limp Home Mode) 185
 Fluid level 292
 Gear ranges 176
 Gear selector lever position 173, 177
 Gear shifting malfunctions 185
 Kickdown 180
 Kickdown, manual shift program S 55 AMG 184
 Manual shift program S 55 AMG 183
 Manual shifting 175
 One-touch gearshifting 175
 Starting the engine 46
 Steering wheel gearshift control S 55 AMG 181
 Transmission fluid 292
 Auxiliary fuse box 412
- B**
- BabySmart™
 Air bag deactivation system 73
 Compatible child seats 73, 437
 Self-test 74
 BabySmart™ airbag deactivation system 437
 Backrest supports
 Lumbar region 123
 Shoulder region 123
 Backup lamps 390, 395
 Bulbs 390
 Bar 322
 BAS 81, 437
 Messages in display 351
 Batteries, SmartKey
 Check lamp 95
 Checking 95
 Replacing 387
 Batteries, SmartKey with KEYLESS-GO*
 Checking 101
 Battery discharged
 Jump starting 406

Index

- Battery, SmartKey with KEYLESS-GO*
 - Check lamp 101
 - Replacing 388
- Battery, vehicle 294, 403
 - Charging 404
 - Disconnecting 404
 - Reconnecting 405
 - Reinstalling 404
 - Removing 404
- Bead 322
- Bi-Xenon headlamps 437
- Block heater (Canada only) 327
- Blocking
 - Rear window operation 78
- Brake assist system (BAS) 437
- Brake fluid 284, 431
- Brake lamp bulbs 390
- Brake lamp, high mounted 390
- Brake pads
 - Message in display 357
- Brakes 274
 - Warning lamp 339
- Break-in period 272
- Bulbs, replacing 389
 - Additional turn signals 390
 - Backup lamps 390
 - Brake lamps 390
 - Fog lamps 390
 - Front lamps 390
 - High beam 390
 - High mounted brake lamp 390
 - License plate lamps 390, 395
 - Low beam 390
 - Parking and standing lamps 390
 - Parking lamps 390, 394
 - Rear fog lamp 390, 395
 - Rear fog lamps 394
 - Side marker lamps 390, 394
 - Standing lamps 390, 394
 - Tail lamp assemblies 390
 - Tail lamp unit 395
 - Turn signal lamps 390
- C**
 - CAC (Customer Assistance Center) 437
 - Calling up
 - Distronic* settings 156
 - Maintenance service indicator 329
 - Range (distance to empty) 158
 - CAN system 438
 - Canceling
 - Cruise control 215
 - Cargo tie-down hooks 241
 - Catalytic converter 281
 - CD changer* 151
 - CD mode 151
 - CD operation
 - Selecting tracks 150
 - Center console 27
 - Air bag off indicator lamp 346
 - Front passenger front air bag off indicator lamp 346

- Centigrade (°C)
 Setting temperature units 163
- Central locking
 Automatic 112
 From inside 113
 Switch 113
 Switching on/off (control system) 168
 Unlocking from inside 113
- Change of address or ownership 12
- Changing
 CDs 151
 SmartKey setting 169
 Vehicle level 230, 233
- Charcoal filter 200
 Activating 200
 Deactivating 201
- Charging
 Vehicle battery 404
- Checking
 Brake fluid 284
 Coolant level 292
 Oil level 285, 287
 Oil level via control system 288
 Tire inflate pressure 285
 Vehicle lighting 285
- Child safety 71
 Air bags 62
 Infant and child restraint systems 66, 71
 LATCH child seat anchors 76
- Cigarette lighter 252
- Cleaning
 Cup holder 335
 Distronic* system sensor cover 333
 Gear selector lever 335
- Hard plastic trim items 335
 Headlamps 186
 Headliner and shelf below rear window 335
 Instrument cluster 335
 Leather upholstery 336
 Light alloy wheels 335
 Nubuck leather upholstery 336
 Parktronic* system sensor 333
 Plastic and rubber parts 336
 Seat belts 335
 Steering wheel 335
 Upholstery 336
 Windows 334
 Windshield 53
 Wiper blades 333
 Wood trims 336
- Cleaning tires 298

FarmaSOS.com

Index

- Clock 25
- Closing 58
 - Cup holder 250
 - Glove box 244
 - Hood 287
 - Power tilt/sliding sunroof 211
 - Power windows 207, 208
 - Side windows 208
 - Trunk 105
- Closing from the inside automatically*
 - Trunk 105
- Closing in an emergency
 - Power tilt/sliding sunroof 386
- Cockpit 22, 438
- Cockpit management and data system (COMAND) 438
- Cold tire inflation pressure 322
- COMAND 438
- COMAND* see separate operating instructions
- Combination switch 135
 - High beam 50
 - High beam flasher 135
 - Turn signals 51
 - Windshield wipers 52
- Control and operation of radio transmitters 280
- Control system 143, 438
 - AUDIO menu 148
 - Checking oil level 288
 - Convenience submenu 169
 - Display digital speedometer 148
 - Distronic* menu 156
 - Functions 145, 147
 - Instrument cluster submenu 163
 - Lighting submenu 164
 - Menus 146, 147
 - Multifunction display 143
 - Multifunction steering wheel 144
 - NAVI menu 155
 - Settings menu 160
 - Standard display menu 148
 - Submenus 145, 147
 - TEL* menu 153
 - Trip computer menu 157
 - Vehicle status message memory menu 159
 - Vehicle submenu 168
- Convenience submenu 169
 - Activating easy-entry/exit feature 170
 - Adjusting drive-dynamic seat* 172
 - Setting Key-dependency 169
 - Setting parking position for exterior rear view mirror 171
- Coolant 292
 - Adding 293
 - Checking level 292
 - Messages in display 358, 359
 - Temperature 282
 - Temperature gauge 141
 - Warning lamp 359
- Coolant level
 - Checking 292
- Coolant temperature gauge 25
- Courtesy lighting 139

- Cruise control 214, 438
 Canceling 215
 Driving downhill 215
 Driving uphill 215
 Fine adjustment 216
 Lever 221
 Setting current speed 215
 Setting to last stored speed (“Resume” function) 216
 Cruise control lever 214
 Cup holder
 Cleaning 335
 Closing 250
 In front seat armrest 248
 In rear seat armrest 249
 Opening 250
 Curb weight 322
 Customer Assistance Center (CAC) 437
- D**
- Daytime running lamp mode 133
 Setting 165
 Deactivating
 Air conditioner (cooling) 202
 Air recirculation mode 200
 Alarm 88
 Anti-theft alarm system 88
- Automatic climate control 202
 Central locking (control system) 168
 Charcoal filter 201
 Defrost 199
 Distance warning function* 226
 Distronic* 224
 Engine with the SmartKey 57
 ESP 83
 Exterior lamps 132
 Hazard warning flasher 136
 Headlamps 57
 Immobilizer 86
 Interior illumination delayed
 switch-off 167
 Limiting opening height of trunk
 lid* 169
 Manual shift program S 55 AMG 185
 Rear window defroster 201
 Residual heat 203
 Seat heater 125, 126
 Seat ventilation* 127
 Tow-away alarm 89
- Deceleration
 With Distronic* 220
 Deep water see Standing water 280
 Defrosting 199
- Delayed switch-off
 Interior illumination 167
 Department of Transportation see DOT
 Dialing
 A number (telephone) 154
 Difficulties
 While driving see Problems while driving 54
 Digital clock 25
 Digital speedometer 148
 Direction of rotation (tires) 299
 Discharged battery
 Jump starting 406
 Disconnecting
 Vehicle battery 404
 Displays
 Digital speedometer 148
 Distronic* 219
 Messages 289
 Service indicator 328
 Showing malfunctions 159
 Vehicle status messages 347

Index

- Distance
 - Decreasing in DISTRONIC* 225
 - Increasing in DISTRONIC* 225
 - Setting in DISTRONIC* 224
 - Warning function 225
- Distance to empty (range)
 - Calling up 157
- Distance warning function* 225
 - Activating 226
 - Deactivating 226
 - Distance warning lamp 225
 - Intermittent warning sound 225
 - Symbol in multifunction display 156
- DISTRONIC* 217, 438
 - Activated 221
 - Activating 222
 - Calling up settings 156, 220
 - Cleaning system sensor 333
 - Cruise control lever 221
 - Deactivated 221
 - Deactivating 224
 - Deceleration 220
 - Decreasing distance 225
 - Decreasing time interval 224
 - Displays in the speedometer dial 219
 - Distance warning function 225
- Driving hints 226
 - Fine adjustment 223
 - Increasing distance 225
 - Increasing time interval 224
 - Intermittent signal tone 219
 - Menu 220
 - Messages in display 351
 - Sensor cover 333
 - Setting a higher speed 222
 - Setting a slower speed 223
 - Setting following distance 224
 - Setting the current speed 222
 - Setting to last stored speed ("Resume" function) 223
 - Warning and indicator lamps 219
- Document holder 242
- Door control panel 30
- Door entry lamps 139
- Door unlock
 - With Tele Aid 262
- Doors
 - Message in display 361
 - Opening from inside vehicle 102
 - Opening from outside 94, 99
- DOT 322
- Downhill driving
 - Cruise control 215
- Downshifting 175
- Drink holder see Cup holder 248
- Drinking and driving 273
- Drive-dynamic seat* 124
 - Adjusting 172
- Driving
 - Abroad 280
 - General instructions 43, 273
 - Hydroplaning 277
 - In winter 279
 - Problems 54
 - Safety systems 80
 - Through standing water 280
 - With DISTRONIC* 226
- Driving abroad 280
- Driving instructions 273
- Driving off 275
- Driving safety systems
 - 4MATIC 85
 - ABS 80
 - BAS 81
 - ESP 82

- Driving systems 214
 ABC 231
 AIRMATIC 229
 Airmatic 229
 Cruise control 214
 Distronic* 217
 Driving safety systems 80
 Parktronic system* 235
 Vehicle level control 230, 232
- E**
- Easy-entry/exit feature 114
 Activating 170
- Electrical fuses 411
- Electrical system 427
- Electrically folding exterior rear view mirrors 188
- Electronic Stability Program see ESP 82, 439
- Emergency call system* 255
- Emergency calls
 Initiating an emergency call 257
 With Tele Aid 256
- Emergency operation (Limp Home Mode) 185
- Emergency operations
 Closing the power tilt/sliding sunroof 386
 Locking the vehicle 384
 Opening the power tilt/sliding sunroof 386
 Remote door unlock 262
 Unlocking the vehicle 383
- Emergency tensioning device see ETD 69, 439
- Emission control 282
- Emission control information label 418
- Ending
 A call (telephone) 154
- Engine 420
 Compartment 286
 Message in display 340, 341
 Starting 46
 Starting with KEYLESS-GO* 47
 Starting with the SmartKey 46
 Turning off with the SmartKey or the SmartKey with KEYLESS-GO* 57
- Engine cleaning 332
- Engine compartment 286
 Fuse box in 413
 Hood 286
- Engine malfunction indicator lamp 340, 341
- Engine number 418, 439
- Engine oil 287
 Adding 291
 Additives 431
 Checking level 287
 Consumption 287
 Display messages 362
 Filler neck 291
 Messages in display 289, 362
 Viscosity 439
- Engine oil level see Oil level 285
- Entry position
 Messages in display 364
- ESP 82, 439
 Four wheel electronic traction system with ESP 85
 Switching off 83
 Switching on 84
 Synchronizing 352
 Warning lamp 342, 343
- ETD 439
 Safety guidelines 64
- ETD (Emergency tensioning device) 69
- Exterior lamp switch 131

Index

- Exterior rear view mirror
 Auto-dimming on the driver's side 186
- Exterior rear view mirrors
 Adjusting 41
 Folding electrically 188
 Parking position for 171
- F**
- Fahrenheit (°F)
 Setting temperature units 163
- Fastening the seat belts 43
- Fine adjustment
 Cruise control 216
 Distronic* 223
- First aid kit 379
- Flat tire 398
 Lowering the vehicle 402
 Mounting the spare wheel 398
 Preparing the vehicle 398
- Flexible Service System (FSS) 328
- Flexible Service System see FSS
- Fog lamp, rear 134, 390
 Replacing bulb 395
- Fog lamps
 Replacing bulbs 390
- Fog lamps, front
 Messages in display 366
 Switching on 134
- Folding electrically
 Exterior rear view mirrors 188
- Four wheel electronic traction system (4MATIC)
 with ESP 85
- 4MATIC 85
- Front air bags 65
- Front lamps
 Messages in display 366–369
 Replacing bulbs 390, 392
 Switching on 131
- Front passenger front air bag off indicator lamp 346
- Front seat head restraints
 Installing 116
 Power seat 116
 Removing 116
- FSS (Flexible Service System) 328
- FSS (Flexible Service System) (Canada vehicles) 439
- Fuel 284
 Fuel reserve warning lamp 341
 Premium unleaded gasoline 284
 Reserve warning lamp 25
- Fuel consumption statistics
 After start 157
 Since last reset 158
- Fuel filler flap 283
 Locking 283
 Opening 385
 Unlocking 283
- Fuel tank
 Filler flap 283
- Fuels, coolants, lubricants etc. 429
- Functions (control system) 145, 147
 Resetting 161
- Fuse box 412, 413
- Fuse chart 380
- Fuses 411
 Auxiliary fuse box in trunk 412
 Fuse box in engine compartment 413
 Fuse box in passenger compartment 412
 Fuse chart 380
 Fuse extractor 380
 Spare fuses 380

G

- Garage door opener 264
 - Erasing in remote control 269
 - Integrated remote control 266
 - Rolling code programming 267
- Gasoline see Fuel 284
- GAWR 322
- Gear range 439
 - Automatic transmission 176
 - Limiting 176
 - Shifting into optimal 175
- Gear range limit
 - Canceling 175
- Gear selector lever
 - Cleaning 335
 - Position (Automatic transmission) 177
 - Position (automatic transmission) 173
- Glasses
 - Storage compartment in front of armrest 246

Global

- Locking 94
- Unlocking 94
- Global Positioning System (GPS) 439
- Glove box 244
 - Closing 244
 - Locking 244
 - Opening 244
 - Unlocking 244
- Gloves (vehicle tool kit) 380
- Good visibility 186
- GPS 255, 439
- Gross Axle Weight Rating see GAWR
- Gross Vehicle Weight Rating see GVWR
- Gross Vehicle Weight see GVW
- GVW 322
- GVWR 323

H

- Hand-held transmitter
 - Programming integrated remote control 266
- Hands-free microphone 29

Hard plastic trim items

- Cleaning 335
- Hazard warning flasher 136
 - Switching off 136
 - Switching on 136
- Head restraints 116
- Headlamp cleaning system* 295
- Headlamps
 - Automatic control 132
 - Bi-Xenon 437
 - Cleaning 332
 - Cleaning system* 186, 295
 - Refilling washer fluid 295
 - Switching off 57
 - Switching on 50
- Headliner
 - Cleaning 335
- Heated steering wheel* 253
- Height adjustment
- Head restraints 39
- Steering wheel 40

Index

- Height adjustments
 - Vehicle level 230, 232
- High beam 50
 - Replacing bulbs 390
- High beam flasher 135
- High beam headlamps
 - Messages in display 366
 - Switching on 135
- High mounted brake lamp 390
- Hood 286
 - Closing 287
 - Message in display 364
 - Opening 286
- Hydroplaning 277
- I**
- Identification labels 418
 - Emission control information label 418
 - Vacuum line routing diagram label 418
- Ignition 34, 36
 - Switching on 34, 46, 47
- Immobilizer 86
 - Activating 86
 - Deactivating 86
- Indicator lamps see Lamps, indicator and warning
- Individual seats* 117
 - Head restraint height 118
- Infant and child restraint systems 71
 - Installing 75
 - LATCH child seat anchors 76
- Information
 - About service and warranty 10
 - Button for Tele Aid* 260
- Infrared reflecting windshield 270
- Inside rear view mirror
 - Auto-dimming 186
- Installing
 - Infant and child restraint systems 75
 - Towing eye bolt 410
 - Wiper blades 397
- Instrument cluster 24, 140, 439
 - Cleaning 335
 - Coolant temperature gauge 141
 - Illumination 140
 - Multifunction display 143
 - Outside temperature indicator 142
 - Selecting language 164
- Integrated remote control
 - Canadian programming 268
 - Erasing memory 269
 - Hand-held transmitter 266
 - Operating 269
 - Rolling code programming 267
- Interior illumination
 - Delayed switch-off 167
- Interior lighting 137
 - Activating automatic control 137
 - Deactivating automatic control 137
 - Manual operation 137
 - Reading lamps in the front 138
 - Reading lamps in the rear 138
- Interior rear view mirror
 - Adjusting 41

J

Jump starting 406

K

Key see SmartKey 57, 58

Key, mechanical 383

Key, SmartKey

Checking the batteries 95

Locking 58

Key-dependency memory

Settings 169

KEYLESS-GO* 439

Activating ignition with 36

Locking 58

Locking the vehicle 101

Loss of SmartKey with

KEYLESS-GO 102

Messages in display 364

Starting the engine 47

Turning off engine 57

Kickdown 180, 439

Kilometers/miles in speedometer 163

Kilopascal 323

Km/h or mph in speedometer 163

L

Lamp bulbs, exterior 389

Lamps, exterior

Front 390

Light sensor 366

Messages in display 367

Rear 390

Lamps, indicator and warning

ABS 338

Air bag Off 65

Battery (SmartKey with

KEYLESS-GO*) 100

Battery (SmartKey) 94

Brakes 339

Coolant 358

Distronic* 219

Engine diagnostics 340, 341

Engine malfunction indicator

lamp 340, 341

ESP 342, 343

Front passenger front air bag off 346

Fuel reserve 341

Instrument cluster 338–345

Seat belts telltale 343

Service indicator 328

SRS 61

Language

Multifunction display 164

Setting 164

LATCH child seat anchors 76

Layout of poly-V-belt drive 419

Leather upholstery

Cleaning 336

Lever

For cruise control 221

License plate lamps

Replacing bulbs 390, 395

Index

- Light alloy wheels
 - Cleaning 335
- Light sensor 366
- Lighter see Cigarette lighter 252
- Lighting 131
 - Automatic headlamp mode 132
 - Combination switch 135
 - Courtesy lighting 139
 - Daytime running lamp mode 133
 - Door entry lamps 139
 - Exterior lamp switch 131
 - Front fog lamps 134
 - High beam flasher 135
 - High beams 135
 - Instrument cluster illumination 140
 - Interior 137
 - Locator lighting 133
 - Low beam 131
 - Manual headlamp mode 132
 - Night security illumination 133
 - Parking lamps 131
 - Rear fog lamp 134
 - Settings (control system) 164
 - Trunk 138, 139
- Limiting opening height of trunk lid* 105
- Limiting the gear range 176
- Limp Home Mode 185
- Line of fall 440
- Loading 240
 - Cargo tie-down hooks 241
 - Instructions 241
 - Roof rack 240
- Loading terminology 322
- Loading the vehicle 299
- Locator lighting 133
 - Setting 166
- Lock button 440
 - Door handle (KEYLESS-GO*) 58
 - SmartKey 92
 - SmartKey with KEYLESS-GO* 96
- Locking 55, 58, 92
 - Fuel filler flap 283
 - Global (SmartKey with KEYLESS-GO*) 99
 - Global, SmartKey 94
 - Glove box 244
 - Vehicle in an emergency 384
 - Vehicle with KEYLESS-GO* 101
 - with the KEYLESS-GO* 58
 - with the SmartKey 58
 - Loss of SmartKey 96
 - Loss of Smartkey with KEYLESS-GO* 102
 - Low beam headlamps
 - Messages in display 366, 367
 - Replacing bulbs 390
 - Lowering
 - Vehicle 402
 - Lumbar support adjustment 122

M

- Main 428
- Main Dimensions 428
- Maintenance 12, 328
- Maintenance service
 - Calling up the maintenance service indicator 329
 - Overdue 329
- Maintenance service indicator
 - Calling up 329
 - Clearing 328
 - Resetting 329
- Maintenance System (U.S. vehicles) 440
- Manual headlamp mode 132
- Manual operations
 - Closing the power tilt/sliding sunroof 386
 - Fuel filler flap 385
 - Interior lighting control 137
 - Locking the vehicle 384
 - Opening the power tilt/sliding sunroof 386
 - Power tilt/sliding sunroof 386
 - Unlocking the driver's door 383
- Manual shift program S 55 AMG
 - Activating 183
 - Automatic transmission 183
 - Deactivating 185
- Massage function 123
- MAXCOOL
 - Maximum cooling 198
- Maximum inflation pressure 323
- Maximum load rating 323
- Maximum loaded vehicle weight 323
- Mechanical key 383
- Memory function 128, 440
 - Recalling positions from memory 129
 - Storing exterior rear view mirror parking positions 130
 - Storing key dependent settings 129
- Menus 145
 - AUDIO 148
 - Distronic* 156, 220
 - In control system 146, 147
 - NAVI 155
 - Settings menu 160
- Standard display 148
- Submenus 145
- TEL* 153
- Trip computer 157
- Vehicle status message memory 159
- Microphone
 - Hands-free microphone 29
- Miles/kilometers in speedometer
 - Setting 163
- Mirrors
 - Activating exterior rear view mirror parking position 187
 - Adjusting 41
 - Auto-dimming for rear view mirror 186
 - Exterior rear view mirror 41
 - Exterior rear view mirror parking position 171
 - Interior rear view mirror 41
 - Storing exterior rear view mirror parking position 130
- MON 284
- MON (Motor Octane Number) 440

Index

- MP3-CD operation
 Selecting tracks 150
- Mph or km/h in speedometer 163
- Multicontour backrest* 122
- Multifunction display 143, 440
 Selecting language 164
 Standard display 147
- Multifunction display messages
 ABC 349, 354
 ABS 350
 BAS 351
 Brake fluid 357
 Brake pads 357
 Check engine 340, 341
 Coolant 359
 Coolant level 358
 Distronic* 351
 Doors 361
 Engine 340, 341
 Engine oil level 362
 Entry position 364
- Hood 364
- Lamps 367
- Parking brake 356
- Selector lever 353
- SmartKey 364
- SmartKey with KEYLESS-GO* 364
- TeleAid 370
- Telephone* 370
- Tires 372-378
- Trunk 371
- Washer fluid 371
- Multifunction steering wheel 26, 144, 440
 Buttons 144
- N**
- Navigation system
 Operating 155
 See separate COMAND* operating instructions
- Night security illumination 133
- Normal occupant weight 323
- Nubuck leather upholstery
 Cleaning 336
- O**
- Occupant distribution 323
- Occupant safety 60
 Air bags 61
 Children and air bags 62
 Children in the vehicle 71
 Fastening the seat belt 43
 Infant and child restraint systems 71
 LATCH child seat anchors 76
 Seat belts 43, 64
- Oil
 Adding 291
 Consumption 287
 Dipstick 287
 Filler neck 291
 Viscosity 439
- Oil level
 Checking 285
- Oil level via control system
 Checking 288

- One-touch gearshifting 175
 Canceling gear range limit 175
 Downshifting 175
 Upshifting 175
- Opening
 Ashtray 251
 Cup holder 250
 Doors from the inside 102
 Fuel filler flap 283
 Fuel filler flap manually 385
 Glove box 244
 Hood 286
 Power tilt/sliding sunroof 211
 Power windows 207
 Side windows 208
 Storage compartment in the center console 245
 Storage compartments in the armrest 246
 Storage compartments in the center console 246, 247
 Trunk 103
 Trunk lid from the inside 104
 Trunk with SmartKey 95
- Opening in an emergency
 Power tilt/sliding sunroof 386
- Operating
 COMAND* see separate operating instructions
 Garage door opener 269
 Integrated remote control 269
 Navigation system 155
 Radio 149
 Radio transmitters 280
 Telephone* 153
 Vehicle outside the USA and Canada 13
- Operating safety 16
 Operator's Manual 10
- Ornamental moldings 332
 Outside temperature indicator 142
 Overdue maintenance service 329
 Overhead control panel 29
 Garage door opener 29
 Reading lamp 29
 Rear view mirror 29
 Tele Aid button 29
- Override switch see Blocking of rear window operation 78
 Overspeed range 440
- P**
 Paintwork 331
 Panic alarm 79
 Panic button on SmartKey 79
 Parcel net in front passenger footwell 250
 Parcel net in trunk 250
 Parking 55, 275
 Parking and standing lamps
 Replacing bulbs 390
 Parking assist
 Parktronic system* 235
 Parking brake 48, 56
 Engaging 56
 Message in display 356
 Releasing 48
 Warning sound 49
 Parking lamps
 Replacing bulbs 390, 394
 Switching on 131

Index

- Parking position
Exterior rear view mirrors 130, 171, 187
- Parktronic system* 235, 440
- Parktronic*
Cleaning sensors 333
Malfunctioning 239
Warning indicators 237
- Parts service 416
- Passenger compartment 280
Fuse box in 412
Interior lighting 137
Interior rear view mirror 41
Parcel net in front passenger footwell 250
- Passenger safety see Occupant safety 60
- Passenger seat fore and aft adjustment 119
- Passenger seat head restraint height 119
- Passenger seat height 119
- Pedals 273
- Phone book*
Loading 154
Quick search 154
- Phone number*
Dialing 154
Redialing 155
- Plastic and rubber parts
Cleaning 336
- Poly-V-belt drive 440
- Positions (Memory function)
Recalling from memory 129
- Positions (Memory function*)
Storing into memory 129
- Potential problems associated with under-inflated and overinflated tires 311
- Power assistance 273
- Power closing assist for doors and trunk lid 112
- Power seat
Adjusting backrest tilt 38
Adjusting head restraint height 39
Adjusting head restraint tilt 39
Adjusting seat cushion depth 38
Adjusting seat cushion tilt 38
Adjusting seat height 38
Front seat head restraints 116
Seat fore and aft adjustment 38
- Power seat bench* 117
Head restraint height 117
- Power tilt/sliding sunroof 211
Closing 211
Closing in an emergency 386
Messages in display 370
Opening 211
Opening in an emergency 386
- Power train 441
- Power windows 207
Blocking of rear window operation 78
Closing 207, 208
Opening 207
Side windows 207
Synchronizing 209
- Power-wash 331
- Practical hints
First aid kit 379
Fuses 411
Lamp in center console 346
Lamps in instrument cluster 338
Towing the vehicle 408
Vehicle status messages in the multi-function display 347
Vehicle tool kit 379

- PRE-SAFE see Preventive occupant safety 70
- Preventive occupant safety (PRE-SAFE) 70
- Problems
- While driving 54
 - With vehicle 17
- Product information 9
- Production options weight 323
- Program mode selector switch 441
- Proper use of the vehicle 16
- PSI 323
- PULSE function (Massage function) 123
- Q**
- Quick search
- Phone book* 154
- R**
- Radio
- Selecting satellite radio* stations 149
 - Selecting stations 149
- Radio transmitters, control and operation 280
- Range (distance to empty)
- Calling up 158
- Reading lamps in the front 138
- Reading lamps in the rear 138
- Rear fog lamp 390
- Bulb 390
 - Switching on 134
- Rear lamp bulbs
- Replacing 394
- Rear lamps see Tail lamps
- Rear passenger compartment
- Adjustable air vents 204
- Rear seat head restraints
- Folding back with switch 120
 - Placing upright 121
 - Rear seats 120
 - Rear seats 117
 - Fore and aft adjustment 118
 - Head restraint height* 117, 118
 - Individual seats* 117
 - Passenger seat fore and aft adjustment 119
 - Passenger seat head restraint height 119
 - Passenger seat height 119
 - Rear seat head restraints 120
- Seat height 118
- Setting front passenger seat position from rear* 118
- Rear view mirror 29
- Rear view mirror auto-dimming 186
- Rear view mirrors see Mirrors
- Rear window
- Blocking operation 78
 - Rear window defroster 201
 - Activating 201
 - Deactivating 201
 - Rear window sunshade* 191
- Recommended inflation pressure 323
- Reconnecting
- Vehicle battery 405
- Recovery services
- For stolen vehicle 263
- Refueling 283
- Regular checks 284
- Regular driving style 232
- Reinstalling vehicle battery 404
- Remote control
- SmartKey 92
 - SmartKey with KEYLESS-GO* 96

Index

- Remote controls
 - Integrated 266
 - Remote door unlock
 - With Tele Aid 262
 - Removing
 - Vehicle battery 404
 - Wheel 401
 - Wiper blades 396
 - Replacing
 - Backup lamp bulbs 394
 - Battery (SmartKey with KEYLESS-GO*) 388
 - Brake fluid 431
 - Brake lamp bulbs 394
 - Bulbs 389
 - Front lamp bulbs 392
 - License plate lamp bulbs 395
 - Parking lamp bulbs 394
 - Rear fog lamp bulbs 394, 395
 - Rear lamp bulbs 390, 394
 - Rear turn signal bulbs 394
 - Side marker lamp bulbs 394
 - Standing lamp bulbs 394
 - Wiper blades 396
 - Reporting
 - Safety defects 18
 - Reset button in the instrument cluster 160
 - Resetting
 - All functions (control system) 160
 - All functions of a submenu 161
 - Fuel consumption 158
 - Maintenance service indicator 329
 - Trip odometer 141
 - Residual heat utilization 203, 441
 - Residual ventilation 203
 - REST (Residual engine heat utilization) 441
 - Restraint system see Infant and child restraint systems 71, 75
 - Rim 323
 - Rims and Tires 422
 - Roadside assistance 12
 - Tele Aid* 258
 - Rolling code programming 267
 - RON (Research Octane Number) 284, 441
 - Roof rack 240
 - Rubber parts
 - Cleaning 336
- ## S
- Safety
 - Occupant 60
 - Safety belts see Seat belts 43
 - Safety defects
 - Reporting 18
 - Safety systems
 - Driving 80
 - Screwdriver (vehicle tool kit) 380
 - Seat belt force limiter 69
 - Seat belts 66
 - Cleaning 335
 - Fastening 43
 - Proper use of 45, 68
 - Safety guidelines 64
 - Telltale 343
 - Seat cushion depth
 - Adjusting 123
 - Seat for and aft adjustment 118
 - Seat heater
 - Switching off 125
 - Switching on 125
 - Seat height 118
 - Seat ventilation*
 - Switching off 127
 - Switching on 127

- Seating capacity 301
- Seats 114
- Adjusting 37
 - Adjusting lumbar support 123
 - Adjusting shoulder support 123
 - Easy entry/exit feature 114
 - Heater 125
 - Massage function 123
 - Multicontour backrest* 122
 - Rear power seat bench* 117
 - Rear seats 117
- Securing cargo
- Cargo tie-down hooks 241
- Selector lever
- Lock 46, 173
 - Message in display 353
- Self-test
- BabySmart™ air bag deactivation system 74
 - Tele Aid 256
- Service
- Major service (Service B) 328
 - Minor service (Service A) 328
 - When due 328
- Service (maintenance) 328
- Service and warranty information 10
- Service indicator 328
- Service life (tires) 297
- Service System see FSS 328
- Setting
- Convenience functions 169
 - Cruise control 215
 - Daytime running lamp mode 165
 - Digital clock 25
 - Distrionic* time interval 224
 - Following distance in Distrionic* 224
 - Higher speed in cruise control 216
 - Higher speed in Distrionic* 222
 - Individual vehicle settings 160
 - Interior illumination delayed switch-off 167
 - Lamps and lighting (control system) 164
 - Language, multifunction display 164
 - Locator lighting 166
 - Lower speed in cruise control 216
 - Lower speed in Distrionic* 223
 - Miles/kilometers in speedometer 163
- Parking position for exterior rear view mirrors 171
- Slower speed in cruise control 216
- Slower speed in Distrionic* 223
- SmartKey dependent memory 169
- Speed in Distrionic* 222
- Speedometer display mode 163
- Suspension tuning 231
- Temperature (interior) 195
- Temperature indicator 163
- Tire inflation pressure units 164
- To last stored speed (“Resume” function) in cruise control 216
- To last stored speed in Distrionic* (“Resume” function) 223
- Units
- Speedometer 163
 - Temperature 163
 - Tire inflation pressure 164
 - Vehicle level control 230, 232
- Setting current speed 215
- Setting front passenger seat position from rear* 118

Index

- Settings
 - Calling up DISTRONIC* 156, 220
 - Convenience functions 169
 - Factory, SmartKey 94
 - Individual (SmartKey) 169
 - Lighting (control system) 164
 - Menus and submenus 145
 - Resetting all (control system) 160
 - Resetting in the submenu 161
 - Selective 94, 100
- Settings menu
 - Functions in 160
 - Individual vehicle settings 160
 - Submenus 161
- Shift lock 441
- Shifting
 - Gear selector lever positions 177
 - Into optimal gear range (automatic transmission) 175
- Shoulder support
 - Seat adjustment 123
- Side impact air bags 65
- Side marker lamps
 - Replacing bulbs 390, 394
- Side windows
 - Automatic closing 208
 - Automatic opening 208
 - Cleaning 334
 - Closing fully (Express-close) 208
 - Opening 208
 - Opening fully (Express-open) 208
 - Stopping 209
 - Synchronizing power windows 209
- Sidewall 323
- Simultaneous wiping and washing
 - Windshield wipers 53
- Single wipe 53
- SmartKey 92
 - Battery check lamp 94, 100
 - Factory setting 94
 - Global locking 94
 - Global locking and unlocking 94
 - Global unlocking 94
 - Lock button 92
 - Locking 58
 - Locking and unlocking 92
 - Loss of 96
- Remote control 92
- Replacing the batteries 387
- Replacing the battery 387
- Restoring to factory setting 95
- Selective setting 94
- Starting the engine 46
- Turning off the engine 57
- Unlock button 92
- Unlocking 32
- SmartKey with KEYLESS-GO* 96
 - Checking the battery 101
 - Factory setting 99
 - Global locking 99
 - Global unlocking 100
 - Lock button 96
 - Locking the vehicle 101
 - Loss of 102
 - Messages in display 364
 - Remote control 96
 - Replacing the battery 387, 388
 - Selective setting 100
 - Unlock button 96
 - Unlocking 33, 96

- Snow chains 327
- Spare fuses 380
- Spare wheel
 - Mounting 398
- Speed
 - Setting current 215
 - Setting to last stored speed in Distronic* ("Resume" function) 223
- Speed settings
 - Cruise control 216
 - Distronic* 222, 223
 - To last stored speed ("Resume" function) in Cruise control 216
- Speedometer
 - Displays 219
 - Settings units 163
- Speedometer display mode
 - Selecting 163
- Sporty driving style 232
- SRS 68, 441
 - Indicator lamp 345
- SRS indicator lamp 60
- Standing lamps 131
 - Replacing bulbs 390, 394
- Standing water
 - Driving instructions 280
- Starting difficulties 47
- Starting the engine 46
- Steering column
 - Height adjustment 40
 - Length adjustment 40
- Steering wheel
 - Adjusting 40
 - Adjustment 40
 - Cleaning 335
 - Heated steering wheel* 253
- Steering wheel adjustment 40
- Steering wheel gearshift control S 55 AMG
 - Automatic transmission 181
- Stolen vehicle
 - Recovery services 263
- Stopping
 - Tilt/sliding sunroof 213
- Windows 209
- Storage compartments 243
 - Armrest 245, 246, 247
 - Cup holder 248, 250
 - Glove box 244
 - In front of armrest 247
 - Parcel net 250
 - Storage compartment in front of armrest 245
 - Storage tray 245, 246, 247
 - Under the front seats 248
- Storing (Memory function*)
 - Positions into memory 129
- Storing tires 298
- Submenus
 - Convenience 169
 - For settings 145
 - In control system 147
 - Instrument cluster 163
 - Lighting 164
 - Resetting functions in Control system 161
 - Selecting 161
 - Settings menu 161
 - Vehicle 168

Index

- Sun visors 190
- Supplemental Restraint System (SRS) 441
- Suspension tuning
 - For regular driving style 232
 - For sporty driving style 232
 - Setting 231
- Switching off
 - Automatic central locking (control system) 168
 - Engine 57
 - ESP 83
 - Hazard warning flasher 136
 - Headlamps 57
- Switching on
 - Automatic central locking (control system) 168
 - ESP 84
 - Front fog lamps 134
 - Front lamps 131
 - Hazard warning flasher 136
 - Headlamps 50
 - High beams 135
 - Parking lamps 131
 - Rear fog lamp 134
 - Windshield wipers 52
- Symbol (Distronic*)
 - Distance warning function* 156
- Synchronizing
 - ESP 352
 - Power windows 209
 - Tilt/sliding sunroof 213
- T**
- Tachometer 142
 - Overspeed range 142
- Tachometer display
 - Displaying gear range 176
- Tail lamps
 - Cleaning 332
 - Replacing bulbs 390, 395
- Tar stains 331
- Tele Aid 255
 - Emergency calls 256
 - Information 260
 - Initiating an emergency call manually 257
 - Messages in display 370
 - Remote door unlock 262
 - Roadside assistance 258
 - Stolen Vehicle Recovery services 263
 - System self-check 256
- Tele Aid System 255
 - Upgrade scenario 261
- Tele Aid button 29
- Tele Aid System 442
- TeleAid
 - Messages in display 370
- Telematics* 442
- Telephone holder*
 - Storage compartment in front of armrest 247
- Telephone* 254
 - Answering a call 154
 - Dialing a number from the phone book 154
 - Ending a call 154
 - Hands-free microphone 29
 - Loading phone book* 154
 - Messages in display 370
 - Operating 153
 - Redialing 155
- Temperature
 - Display mode 163
 - Setting units in display 163
 - Tires 306
- Tie-down hooks (Trunk) 241
- Tightening torque 442

- Tightening torque (Wheel bolts) 402
- Tilt/sliding sunroof
Stopping 213
Synchronizing 213
- TIN 324
- Tire
Vehicle maximum load on 324
- Tire and Loading Information 300
- Tire and loading terminology 322
- Tire care and maintenance 297
- Tire Identification Number see TIN
- Tire inflation pressure
Checking 285, 305, 307
Setting units 164
- Tire inflation pressure see the placard on the fuel filler flap
- Tire inspection 297
- Tire load rating 324
- Tire ply composition and material used 324
- Tire speed rating 278, 314, 324, 442
- Tire terminology 322
- Tire traction 277
- Tires 296
Direction of rotation 299
Driving instructions 276
Messages in display 372-378
Retreads 296
Rotating 325
Service life 297
Temperature 306, 321
Tire inflation pressure monitor warning lamp 344
Tread depth 298, 326
Wear pattern 325
Winter 326
- Tools 379
- Tow-away alarm 89
Arming 89
Disarming 89
Disarming for transport 89
- Towing eye bolt (vehicle tool kit) 380
Installing 410
- Towing the vehicle 408
- Traction 179, 324, 442
- Transmission see Automatic transmission 292
- Tread 324
- Tread depth 298
- Tread depth (tires) 326
- Treadwear indicators 324
- Trip computer 157
- Trip odometer
Resetting 141
- Trunk
Auxiliary fuse box 412
Closing 105
Closing from the inside automatically* 105
Lighting 138, 139
Lock button, KEYLESS-GO* 101
Message in display 371
Opening 103
Opening from inside vehicle 104
Opening with SmartKey 95
Parcel net 250
Tie-down hooks 241
Trunk lid 103, 105
Trunk lock 384
Unlocking with SmartKey 95
Unlocking with SmartKey with KEYLESS-GO* 102
- Trunk lid
Limiting opening height* 105
Trunk lid emergency release 111

Index

- Trunk lid opening/closing system* 105, 107, 108
- Turn signal lamps
- Replacing bulbs 390
- Turn signals 51
- Additional in mirrors 390
 - Cleaning lenses 332
 - Front bulbs 390, 393
 - Rear bulbs 390, 395
- Turning off
- Engine 57
- Turning off the engine 57
- U**
- Uniform Tire Quality Grading Standards 324
- Units
- Setting speedometer units 163
 - Setting temperature units 163
- Unlock button
- SmartKey 92
 - SmartKey with KEYLESS-GO* 96
 - Trunk lid 96
- Unlocking 32, 92
- Driver's door in an emergency 383
 - Fuel filler flap 283
 - Global 94
 - Global (SmartKey with KEYLESS-GO*) 99
 - Glove box 244
 - In an emergency 383
 - Selective settings 94, 100
 - Trunk lid 96
 - Trunk lid with SmartKey 95
 - Trunk lid with SmartKey with KEYLESS-GO* 102
 - Vehicle in an emergency 262
 - With the SmartKey 32
 - With the SmartKey with KEYLESS-GO* 33, 96
- Upgrade scenario
- Tele Aid* 261
- Uphill driving
- Cruise control 215
- Upholstery
- Cleaning 336
- Upshifting 175
- Useful features 242
- Ashtrays 251
 - Cigarette lighter 252
 - Document holder 242
 - Garage door opener 264
 - Heated steering wheel* 253
 - Storage compartments 243
 - Tele Aid 255
 - Telephone* 254
 - Vanity mirror in the rear 243
 - Vanity mirror in the sun visor 242
- V**
- Vacuum line routing diagram label 418
- Vanity mirror in the rear 243
- Vanity mirror in the sun visor 242
- Vehicle
- Individual settings 160, 162
 - Locking in an emergency 384
 - Lowering 402
 - Service battery 403
 - Towing 408
 - Unlocking in an emergency 383
- Vehicle battery 403
- Vehicle capacity weight 324

- Vehicle care 330
 - Cup holder 335
 - Distronic* system sensor cover 333
 - Engine cleaning 332
 - Gear selector lever 335
 - Hard plastic trim items 335
 - Headlamps 332
 - Instrument cluster 335
 - Leather upholstery 336
 - Light alloy wheels 335
 - Nubuck leather upholstery 336
 - Ornamental moldings 332
 - Paintwork 331
 - Parktronic* system sensor 333
 - Plastic and rubber parts 336
 - Power-wash 331
 - Seat belts 335
 - Side markers 332
 - Steering wheel 335
 - Tail lamps 332
 - Tar stains 331
 - Turn signals 332
 - Upholstery 336
 - Vehicle washing 332
 - Window cleaning 334
 - Wiper blades 333
 - Wood trims 336
 - Vehicle data recording 19
 - Vehicle level 230, 232
 - Changing 230, 233
 - Setting 230, 233
 - Automatic 230, 233
 - Manual 230, 233
 - Vehicle lighting
 - Checking 285
 - Vehicle loading terminology 322
 - Vehicle maximum load on the tire 324
 - Vehicle status message memory 159
 - Calling up 159
 - Displaying 159
 - Vehicle submenu
 - Limiting opening height of trunk lid* (Control system) 169
 - Vehicle tool kit 379, 380
 - Alignment bolt 380
 - Fuse chart 380
 - Fuse extractor 380
 - Gloves 380
 - Screwdriver 380
 - Spare fuses 380
 - Wheel wrench 380
 - Vehicle washing 332
 - Ventilated storage compartment 204
 - Ventilation
 - Storage compartment 204
 - VIN (Vehicle Identification Number) 442
 - Voice control system* 442
 - Hands-free microphone 29
- W**
- Warning indicators
 - Parktronic* 237
 - Warning lamps see Lamps, indicator and warning
 - Warning sounds
 - Distance warning function* 225
 - Distronic* 219
 - Drivers seat belts 66
 - Parking brake 49
 - Warranty coverage 417
 - Washing the vehicle 330
 - Wear pattern (tires) 325
 - Weights 428
 - Wheel change
 - Tightening torque 402
 - Wheels
 - Tires and wheels 296
 - Window curtain air bags 66

Index

Windows see Side windows
Windshield
 Refilling washer fluid 295
 Replacing wiper blades 396
 Washer fluid 295
Windshield washer fluid
 Message in display 371
 Refilling 295
 Wiping with 53
Windshield wipers 52, 189
 Fast wiper speed 52
 Intermittent wiping 52
 Replacing wiper blades 396
 Single wipe 53
 Switching on 52
 Wiping with windshield washer
 fluid 53
Winter driving 326
 Block heater (Canada only) 327
 Snow chains 327
 Tires 326
Winter driving instructions 279
Winter tires 326

Wiper blades
 Cleaning 333
 Installing 397
 Removing 396
 Replacing 396
Wiping
 And washing simultaneously 53
 Interval 52
 With windshield washer fluid 53
Wood trims
 Cleaning 336
Wrench, wheel (vehicle tool kit) 380
X
Xenon headlamps
 Bi-Xenon 437

امداد خودروسازان
تلفن شبانه روزی: ۰۲۱۸۸۴۲۰۸۵

FarmaSOS.com

Service and Literature

Your authorized Mercedes-Benz Center has trained technicians and original Mercedes-Benz parts to service your vehicle properly.
For expert advice and quality service, see an authorized Mercedes-Benz Center.

If you are interested in obtaining service literature for your vehicle, please contact an authorized Mercedes-Benz Center.
We consider this the best way for you to obtain accurate information for your vehicle.

For further information you can find us on the Mercedes-Benz web-site www.mbusa.com or www.mercedes-benz.ca.

Warning



To help avoid personal injury, be extremely careful when performing any service work or repairs. Improper or incomplete service or the use of incorrect or inappropriate parts or materials may damage the vehicle or its equipment, which may in turn result in personal injury.

If you have any questions about carrying out any type of service, turn to the advice of an authorized Mercedes-Benz Center.

We reserve the right to modify the technical details of the vehicle as given in the data and illustrations of this Operator's Manual.
Reprinting, translation and copying, even of excerpts, is not permitted without our prior authorization in writing.

Title illustration no. P00.01-2396-31

Press time May 07, 2004

GSP/TIP

Printed in Germany

امداد خودرو فارما

تلفن شبانه روزی: ۰۲۱-۸۸۸۶۲۰۸۵

FarmaSOS.com