



تلفن سیستم روزی: ۰۲۱-۸۸۸۶۲۰۸۵

[FarmaSOS.com](http://FarmaSOS.com)

Mercedes-Benz

S-Class

Operator's Manual

## Symbols

Trademarks:

- Bluetooth® is a registered trademark of Bluetooth SIG Inc.
- DTS is a registered trademark of DTS, Inc.
- Dolby and MLP are registered trademarks of Dolby Laboratories.
- PRE-SAFE® is a registered trademarks of Daimler.
- HomeLink® is a registered trademark of Prince, a Johnson Controls Company.
- iPod® and iTunes® are registered trademarks of Apple Inc., registered in the U.S.A. and other countries.
- Logic7® is a registered trademark of Harman International Industries, Incorporated.
- Microsoft® is a registered trademark of Microsoft Corporation in the U.S.A. and other countries.
- SIRIUS and related marks are trademarks of SIRIUS XM Radio Inc.
- HD Radio and related marks are trademarks of iBiquity Digital Corporation.
- Windows media® is a registered trademark of Microsoft Corporation in the U.S.A. and other countries.
- Gracenote® is a registered trademark of Gracenote, Inc.
- ZagatSurvey® and related marks are trademarks of Zagat.

The following symbols are found in this Operator's Manual:

### **Warning!**

Warning notices draw your attention to hazards that may endanger your health or life, or the health or life of others.

- ! Highlights hazards that may result in damage to your vehicle.

 Helpful hints or further information you may find useful.

- ▶ This symbol points to instructions for you to follow.
- ▶ A number of these symbols appearing in succession indicates a multiple-step procedure.
- ▷ page This symbol tells you where to look for further information on a topic.
- ▷▷ This continuation symbol marks a warning or procedure which is continued on the next page.
- Display Text in displays, such as the control system, are printed in the type shown here.

امداد خودرو فارما

تلفن شبانه روزی: ۰۸۵ ۲۱۱۷۱۴۲

PharmasOS.com

Our company and staff congratulate you on the purchase of your new Mercedes-Benz.

Your selection of our product is a demonstration of your trust in our company name. Furthermore, it exemplifies your desire to own an automobile that will be as easy as possible to operate and will provide years of service.

Your Mercedes-Benz represents the efforts of many skilled engineers and craftsmen. To help assure your driving pleasure, and also the safety of you and your passengers, we ask you to make a small investment of time:

- Please read this manual carefully, then return it to your vehicle where it will be handy for your reference.
- Please follow the recommendations contained in this manual. They are designed to acquaint you with the operation of your Mercedes-Benz.
- Please pay attention to the warnings and cautions contained in this manual. They are designed to help improve the safety of the vehicle operator and occupants.

We extend our best wishes for many miles of safe, pleasurable driving.

Mercedes-Benz USA, LLC

A Daimler Company

امداد خودرو فارما

تلفن شبانه روزی: ۰۸۵-۲۲۶۲۰۰۰۰

FarmaSOS.com

# امداد خودرو فارما

تلفن شبانه روزی: ۰۲۱-۸۸۸۶۲۰۸۵

**FarmaSOS.com**



<b>Index</b> .....	<b>4</b>	<b>At a glance</b> .....	<b>27</b>
<b>Introduction</b> .....	<b>21</b>	<b>Safety and security</b> .....	<b>39</b>
		<b>Control systems</b> .....	<b>75</b>
		<b>Controls in detail</b> .....	<b>273</b>
		<b>Operation</b> .....	<b>401</b>
		<b>Practical hints</b> .....	<b>449</b>
		<b>Technical data</b> .....	<b>523</b>

امداد خودرو فارما

تلفن شبانه روزی: ۰۲۱-۸۸۸۶۲۰۸۵

FarmaSOS.com

- 1, 2, 3 ...
- 4-ETS**  
see ETS/4-ETS
- 4MATIC**  
see All-wheel drive (4MATIC)
- 911 emergency call** ..... 150
- A**
- ABC (Active Body Control)** ..... 345  
Messages in the multifunction display ..... 457
- ABS (Antilock Brake System)** ..... 63  
Indicator lamp ..... 490  
Messages in the multifunction display ..... 467, 468
- Accessory weight** ..... 430
- Accidents** ..... 314  
Air bags ..... 41  
Emergency calls (Tele Aid) ..... 390  
Emergency calls (Telephone) ..... 150  
NECK-PRO active front head restraints ..... 55
- Active Bi-Xenon headlamps**  
see Headlamps
- Active Body Control**  
see ABC
- Adaptive Brake** ..... 65
- Adaptive Brake Lights** ..... 66
- Adaptive Damping System**  
see ADS
- Adaptive Highbeam Assist** ..... 301  
Setting ..... 235
- Additives**  
Engine oil ..... 540  
Gasoline ..... 541
- Address book** ..... 159
- Address change** ..... 22
- ADS (Adaptive Damping System)** .... 343
- Advanced Parking Guidance**  
Messages in the multifunction display ..... 461
- Advanced Tire Pressure Monitoring System (Advanced TPMS)** ..... 414  
Messages in the multifunction display ..... 464
- Air bags** ..... 41  
Emergency call upon deployment .. 390  
Front, driver and passenger ..... 44  
Front passenger front air bag off indicator lamp ..... 46, 498  
Messages in the multifunction display ..... 455  
OCS (Occupant Classification System) ..... 46  
Safety guidelines ..... 43  
Side impact ..... 45  
Window curtain ..... 45
- Air conditioning refrigerant and lubricant** ..... 540
- Air distribution** ..... 370
- AIRMATIC**  
ADS (Adaptive Damping System) ... 343  
Introduction ..... 343  
Messages in the multifunction display ..... 476  
Vehicle level control ..... 344
- Air pressure**  
see Tire inflation pressure
- Air pressure (tires)** ..... 430
- Air recirculation mode** ..... 371
- Air volume** ..... 370
- Alarm system**  
see Anti-theft systems
- Alignment bolt (vehicle tool kit)** ..... 450, 511
- All-wheel drive (4MATIC)** ..... 347
- Alternator**  
Messages in the multifunction display ..... 463, 482
- Alternator (Technical data)**  
see Vehicle specification
- AMG menu** ..... 227
- Anticorrosion/antifreeze** ..... 543
- Antilock Brake System**  
see ABS
- Anti-theft systems** ..... 71  
Anti-theft alarm system ..... 72  
Immobilizer ..... 71
- Aquaplaning**  
see Hydroplaning
- Armrest, front**  
Storage compartment ..... 382

- Armrest, rear**  
 Control panel ..... 80, 293  
 Cup holder ..... 385  
 Storage compartment ..... 383
- Ashtrays** ..... 387
- Aspect ratio (tires)** ..... 430
- Assistance menu** ..... 231
- ATTENTION ASSIST** ..... 355  
 Messages in the multifunction display ..... 476  
 Switching on or off ..... 232
- Audio Aux** ..... 186
- Audio menu** ..... 226
- Auto-dimming rear view mirrors** .... 295
- Automatic central locking** ..... 278
- Automatic headlamp mode** ..... 299
- Automatic interior lighting control** .. 304
- Automatic shift program** ..... 322
- Automatic transmission** ..... 317  
 Automatic shift program ..... 322  
 Gear range indicator ..... 321  
 Gear ranges ..... 321  
 Gear selector lever ..... 317  
 Hill-start assist system ..... 341  
 Kickdown ..... 321  
 Kickdown (manual shift program) .. 325  
 Manual shift program ..... 324  
 One-touch gearshifting ..... 323  
 Program mode indicator ..... 322  
 Program mode selector switch (automatic shift program) ..... 322  
 Program mode selector switch (manual shift program) ..... 324  
 Shifting procedure ..... 319  
 Steering wheel gearshift control .... 323  
 Transmission position indicator ..... 320  
 Transmission positions ..... 320
- AUX**  
 Audio ..... 186  
 Media interface ..... 200  
 Sockets ..... 187  
 Video ..... 186
- Axle oils** ..... 538
- B**
- Backrest**  
 see Seats
- Backup lamps**  
 Messages in the multifunction display ..... 485
- Bar (air pressure unit)** ..... 430
- BAS (Brake Assist System)** ..... 64
- BAS PLUS (Brake Assist System PLUS)** ..... 64
- Batteries, replacing**  
 Headphone ..... 502  
 Remote control (Rear Seat Entertainment System) ..... 502  
 Remote control (SPLITVIEW) ..... 502  
 SmartKey ..... 502
- Batteries, SmartKey**  
 Checking condition ..... 277
- Battery, Vehicle** ..... 512  
 Charging ..... 514  
 Jump starting ..... 514  
 Messages in the multifunction display ..... 463, 482
- Bead (tire)** ..... 430
- Beverage holders**  
 see Cup holders
- Blind Spot Assist** ..... 359  
 Messages in the multifunction display ..... 460  
 Switching on or off ..... 233
- Bluetooth® interface** ..... 151
- Brake Assist System**  
 see BAS
- Brake Assist System PLUS**  
 see BAS PLUS
- Brake fluid**  
 Checking level ..... 409  
 Messages in the multifunction display ..... 472
- Brake lamps**  
 Cleaning lenses ..... 443
- Brake pads**  
 Messages in the multifunction display ..... 466
- Brakes** ..... 435  
 High-performance brake system .... 437  
 Warning lamp ..... 490

- Break-in period** ..... 402
- Bulbs**  
see Replacing bulbs
- C**
- CAC (Customer Assistance Center)** ... 24
- California retail buyers and lessees, important notice for** ..... 22
- Calls (phone)** ..... 148, 230
- Can holders**  
see Cup holders
- Capacities and recommended fuel/lubricants** ..... 537
- Carpets, cleaning** ..... 446
- CD player** ..... 176
- Central locking**  
Automatic ..... 278  
KEYLESS-GO ..... 275  
Locking/unlocking from inside ..... 279  
SmartKey ..... 274
- Central locking/unlocking switch** ... 279
- Certification label** ..... 524
- Children in the vehicle**  
Air bags ..... 41  
Child safety locks (rear doors) ..... 61  
Child seat anchors – LATCH-type (ISOFIX) ..... 60  
Indicator lamp, front passenger front air bag off ..... 46  
Infant and child restraint systems .... 57  
ISOFIX (Child seat anchors – LATCH-type) ..... 60  
OCS (Occupant Classification System) ..... 46  
Override switch ..... 61  
Safety notes ..... 56  
Tether anchorage points ..... 59  
Top tether ..... 59
- Child safety**  
see Children in the vehicle
- Child seat anchors – LATCH-type (ISOFIX)**  
see Children in the vehicle
- Chrome-plated exhaust tip, cleaning** ..... 447
- Cigarette lighters** ..... 387
- Climate control system** ..... 363  
Air conditioning ..... 366  
Air conditioning refrigerant ..... 540  
Air distribution ..... 370  
Air recirculation mode ..... 371  
Air volume ..... 370  
Automatic mode ..... 366  
Deactivating system ..... 366  
Front defroster ..... 370  
Maximum cooling MAX COOL ..... 371  
Residual heat and ventilation ..... 372  
Temperature ..... 367
- Coat hooks** ..... 380
- Cockpit** ..... 30
- Cold tire inflation pressure** ..... 430
- Collapsible wheel chock** ..... 450
- COMAND** ..... 76  
Address book ..... 159  
Audio playback ..... 176  
AUX sockets ..... 186  
Components ..... 77  
Controller ..... 79  
FM/AM Radio ..... 165  
Gracenote® Media Database ..... 185  
HD Radio™ ..... 167  
Headphone ..... 82  
Inserting/ejecting CDs and DVDs . 179  
Introduction ..... 76  
iPod® ..... 200  
Media interface ..... 200  
Music Register ..... 196  
Navigation ..... 95  
Operating ..... 84  
Phone book ..... 159  
Rear Seat Entertainment System ... 189  
Remote control (Rear Seat Entertainment System) ..... 81  
Remote control (SPLITVIEW) ..... 81  
Reset to factory settings ..... 95  
Satellite radio ..... 170  
SD card ..... 180  
Shortcut buttons ..... 77  
SPLITVIEW ..... 90  
Switching on or off ..... 77  
System settings ..... 91  
Telephone ..... 148  
Telephone keypad ..... 79

- Upload/Download of Data ..... 95
  - USB socket ..... 80
  - Vehicle settings ..... 206
  - Video DVD ..... 191
  - Voice Control System ..... 237
  - Combination switch** ..... 301
  - Controller (COMAND)** ..... 79
  - Control system** ..... 220
    - Multifunction display ..... 222
    - Multifunction steering wheel ..... 221
  - Control system menus** ..... 222
    - AMG ..... 227
    - Assistance ..... 231
    - Audio ..... 226
    - Navi ..... 225
    - Service ..... 233
    - Settings ..... 234
    - Telephone ..... 230
    - Trip ..... 223
  - Coolant**
    - Anticorrosion/antifreeze ..... 543
    - Capacities ..... 538, 539
    - Checking level ..... 408
    - Messages in the multifunction display ..... 480
    - Temperature gauge ..... 327
  - Corner-illuminating lamps** ..... 303
  - Cruise control** ..... 328
    - Activating ..... 328
    - Canceling ..... 329
    - Changing the set speed ..... 329
    - Last stored speed ..... 330
    - Lever ..... 328
    - Messages in the multifunction display ..... 458
    - Resume function ..... 330
    - Setting current speed ..... 329
  - Cup holders** ..... 384
  - Curb weight** ..... 430
  - Customer Assistance Center (CAC)** ... 24
  - Customer Relations Department** ..... 24
- D**
- Dashboard**
    - see Instrument cluster
  - Data recording** ..... 25
  - Daytime running lamp mode** ..... 299
    - Switching on or off ..... 234
  - Deep water**
    - see Standing water
  - Defogging (windshield)** ..... 371
  - Defroster**
    - Front (Climate control system) ..... 370
    - Rear window ..... 372
  - Department of Transportation**
    - see DOT
  - Difficulties**
    - While driving ..... 314
    - With starting ..... 312
  - Digital speedometer**
    - Additional speedometer ..... 235
  - Dimensions (vehicle)**
    - see Vehicle specification
  - Direction of rotation (tires)** ..... 422
  - Displays**
    - COMAND display ..... 78
    - DISTRONIC PLUS ..... 333
    - Maintenance service indicator ..... 439
    - Messages in the multifunction display ..... 452
    - Multifunction display ..... 222
    - Symbol messages ..... 466
    - Text messages ..... 454
    - Trip computer ..... 223
    - Vehicle status message memory ... 233
  - Display settings (COMAND)** ..... 92
  - DISTRONIC PLUS** ..... 330
    - Cleaning system sensors ..... 443
    - Displaying the distance graphic .... 334
    - Displays in the multifunction display ..... 333
    - Distance warning lamp ..... 333, 496
    - Driving ..... 336
    - Driving with ..... 339
    - Lever ..... 335
    - Messages in the multifunction display ..... 459
    - Resume function ..... 338
    - Sensor cover ..... 443
    - Speed settings ..... 337
    - Stopping ..... 337
  - Doors**
    - Child safety locks ..... 61
    - Locking/unlocking (KEYLESS-GO) . 275

- Locking/unlocking (SmartKey) ..... 274  
 Messages in the multifunction display ..... 478  
 Opening from inside ..... 278  
 Remote door lock (Tele Aid) ..... 394  
 Remote door unlock (Tele Aid) ..... 394  
 Unlocking (Mechanical key) ..... 499
- DOT (Department of Transportation)** ..... 430
- Drinking and driving** ..... 434
- Drive-dynamic multicontour seats** .. 219
- Driving**
- Abroad ..... 438
  - Hydroplaning ..... 437
  - Instructions ..... 311, 434
  - In winter ..... 433
  - Problems ..... 314
  - Safety systems ..... 63
  - Systems ..... 327
  - Through standing water ..... 437
  - With DISTRONIC PLUS ..... 339
- Driving and parking**
- Safety notes ..... 311
- Driving off** ..... 313, 437
- Driving safety systems** ..... 63
- ABS ..... 63
  - Adaptive Brake ..... 65
  - Adaptive Brake Lights ..... 66
  - BAS ..... 64
  - BAS PLUS ..... 64
  - EBP ..... 66
  - ESC ..... 66
  - ETS/4-ETS ..... 67
  - PRE-SAFE® Brake ..... 69
- Driving systems**
- Active Body Control (ABC) ..... 345
  - AIRMATIC ..... 343
  - All-wheel drive (4MATIC) ..... 347
  - ATTENTION ASSIST ..... 355
  - Blind Spot Assist ..... 359
  - Cruise control ..... 328
  - DISTRONIC PLUS ..... 330
  - Hill-start assist system ..... 341
  - HOLD function ..... 342
  - Lane Keeping Assist ..... 362
  - Night View Assist Plus ..... 356
  - Parking Guidance ..... 350
  - Parktronic system ..... 347
  - Rear view camera ..... 354
- Driving tips, automatic transmission** ..... 321
- DVD, audio** ..... 176
- DVD, video** ..... 191
- E**
- EBP (Electronic Brake Proportioning)** ..... 66
- Electrical system**
- Improper work on or modifications ..... 23
  - Power outlets ..... 388
- Electrical system (Technical data)**  
 see Vehicle specification
- Electronic parking brake** ..... 315
- Electronic Stability Control**  
 see ESC
- Electronic Traction System**  
 see ETS/4-ETS
- Emergency, in case of**
- First aid kit ..... 450
  - Flat tire ..... 508
  - Hazard warning flasher ..... 302
  - Roadside Assistance ..... 22, 391
  - Towing the vehicle ..... 516
- Emergency calls**
- Tele Aid ..... 390
  - Telephone ..... 150
- Emergency engine shutdown** ..... 521
- Emergency operations**
- Remote door lock (Tele Aid) ..... 394
  - Remote door unlock (Tele Aid) ..... 394
  - Trunk lid, emergency release ..... 282
- Emergency Tensioning Device**  
 see ETD
- Emission control** ..... 438
- Information label ..... 525
  - System warranties ..... 21
- Engine**
- Break-in recommendations ..... 402
  - Cleaning ..... 442
  - Compartment ..... 404
  - Malfunction indicator lamp ..... 496
  - Messages in the multifunction display ..... 480

- Number ..... 525  
 Starting ..... 311  
 Turning off ..... 316
- Engine (Technical data)**  
 see Vehicle specification
- Engine coolant**  
 see Coolant
- Engine oil**  
 Adding ..... 407  
 Additives ..... 540  
 Checking level ..... 405  
 Consumption ..... 405  
 Messages in the multifunction  
 display ..... 483  
 Oil dipstick ..... 406  
 Recommended engine oils and oil  
 filter ..... 539
- ESC (Electronic Stability Control)** ..... 66  
 ETS/4-ETS ..... 67  
 Messages in the multifunction  
 display ..... 467, 468, 473  
 Warning lamp ..... 495
- ETD (Emergency Tensioning  
 Device)** ..... 53  
 Safety guidelines ..... 43
- ETS/4-ETS (Electronic Traction  
 System)** ..... 67
- Express operation**  
 Panorama roof ..... 377  
 Power windows ..... 307  
 Tilt/sliding sunroof ..... 373
- Exterior lamp switch** ..... 298
- Exterior rear view mirrors** ..... 295  
 Fold-in function ..... 296  
 Parking position ..... 295  
 Power-folding ..... 296
- Exterior view of vehicle** ..... 28
- F**
- Fastening the seat belts** ..... 51
- First aid kit** ..... 450
- Flat tire** ..... 508  
 Lowering the vehicle ..... 512  
 Mounting the spare wheel ..... 509  
 Preparing the vehicle ..... 508  
 Spare wheel ..... 508, 536
- Floormats** ..... 399
- Fluids**  
 ABC fluid ..... 408, 538  
 Automatic transmission fluid ..... 538  
 Brake fluid ..... 538  
 Capacities ..... 537  
 Engine coolant ..... 538, 539  
 Engine oil ..... 537  
 Power steering fluid ..... 538  
 Washer and headlamp cleaning  
 system ..... 539
- Fog lamps** ..... 300  
 Messages in the multifunction  
 display ..... 485, 487
- Fold-in function for exterior rear  
 view mirrors** ..... 296
- Four-wheel drive**  
 see All-wheel drive (4MATIC)
- Front air bags**  
 see Air bags
- Front lamps**  
 see Headlamps
- Front passenger front air bag** ..... 44  
 Messages in the multifunction  
 display ..... 455
- Front passenger front air bag off  
 indicator lamp** ..... 46, 498
- Fuel** ..... 402  
 Additives ..... 541  
 Capacity, fuel tank ..... 539  
 Drive sensibly-safe fuel ..... 434  
 Fuel consumption statistics ..... 223  
 Fuel filler flap and cap ..... 403  
 Fuel tank reserve warning lamp ..... 496  
 Premium unleaded gasoline ..... 541  
 Refueling ..... 402  
 Requirements ..... 541
- Fuel filler flap** ..... 403
- Fuel gauge** ..... 327
- Fuels, coolants, lubricants etc.** ..... 537
- Fuel tank**  
 Capacity ..... 539  
 Fuel filler flap and cap ..... 403  
 Refueling ..... 402
- Fuses** ..... 519

## G

<b>Garage door opener</b> .....	395
<b>Gasoline</b>	
see Fuel	
<b>GAWR (Gross Axle Weight Rating)</b> ...	431
<b>Gear range</b> .....	321
Indicator .....	321
Limiting .....	323
Shifting into optimal .....	324
<b>Gear selector lever</b> .....	317
Cleaning .....	446
Gearshift pattern .....	317
Shifting procedure .....	319
Transmission position indicator .....	320
Transmission positions .....	320
<b>Generator</b>	
see Alternator	
<b>Global locking/unlocking</b>	
see Key, SmartKey	
<b>Glove box</b> .....	381
<b>Gracenote® Media Database</b> .....	185
<b>Gross Axle Weight Rating</b>	
see GAWR	
<b>Gross Vehicle Weight</b>	
see GVW	
<b>Gross Vehicle Weight Rating</b>	
see GVWR	
<b>GVW (Gross Vehicle Weight)</b> .....	431
<b>GVWR (Gross Vehicle Weight Rating)</b> .....	431

## H

<b>Hard plastic trim items, cleaning</b> ....	446
<b>Hazard warning flasher</b> .....	302
<b>HD Radio™</b> .....	167
<b>Headlamp cleaning system</b> .....	303
<b>Headlamps</b>	
Active Bi-Xenon headlamps .....	298
Adaptive Highbeam Assist .....	301
Automatic headlamp mode .....	299
Bi-Xenon .....	298, 505
Cleaning lenses .....	443
Cleaning system .....	303
Daytime running lamp mode .....	299
High-beam flasher .....	302
High-beam headlamps .....	301

Low-beam headlamps .....	299
Messages in the multifunction display .....	485
Replacing bulbs .....	504
Switch .....	298

<b>Headliner and shelf below rear window, cleaning and care of</b> .....	446
--	-----

<b>Headphone</b> .....	82
Replacing batteries .....	502

<b>Head restraints</b> .....	286
Adjustment .....	286, 289
Comfort head restraint .....	289
Folding back .....	290
NECK-PRO active front head restraints .....	55
Rear seat head restraints .....	290

<b>Heated steering wheel</b> .....	294
------------------------------------	-----

<b>Height adjustment</b>	
Seat belt outlet .....	52
Seats .....	286
Vehicle level control .....	344

<b>High-beam flasher</b> .....	302
--------------------------------	-----

<b>High-beam headlamps</b> .....	301, 505
Adaptive Highbeam Assist .....	301
Indicator lamp .....	32

<b>High-performance brake system</b> ....	437
---	-----

<b>Hill-start assist system</b> .....	341
---------------------------------------	-----

<b>HOLD function</b> .....	342
----------------------------	-----

<b>Hood</b> .....	404
Messages in the multifunction display .....	478

<b>Horn</b> .....	30
-------------------	----

<b>Hydroplaning</b> .....	437
---------------------------	-----

## I

<b>Identification labels</b> .....	524
------------------------------------	-----

<b>Identification number, vehicle (VIN)</b> .....	525
---	-----

<b>Ignition</b> .....	284, 311
-----------------------	----------

<b>Immobilizer</b> .....	71
--------------------------	----

<b>Indicator lamps</b>	
see Lamps, indicator and warning	

<b>Infant and child restraint systems</b>	
see Children in the vehicle	

<b>Inflation pressure</b>	
see Tires, Inflation pressure	

<b>Infrared reflecting windshield</b> .....	399
---	-----



- Inside door handle** ..... 38, 278
- Instrument cluster** ..... 32, 326
- Illumination ..... 326
  - Lamps ..... 489
  - Multifunction display ..... 222
- Instrument lighting**  
see Instrument cluster, Illumination
- Instrument panel**  
see Instrument cluster
- Instruments and controls**  
see Cockpit
- Interior lighting**
- Emergency lighting ..... 304
  - Front ..... 304
  - Front reading lamps ..... 304
  - Rear ..... 304
  - Rear reading lamps ..... 304
- Interior rear view mirror** ..... 294
- Auto-dimming rear view mirrors .... 295
- Interior storage spaces**  
see Storage compartments
- Intermittent wiping** ..... 306
- Rain sensor ..... 306
- iPod® (media interface)** ..... 200
- ISOFIX (Child seat anchors – LATCH-type)**  
see Children in the vehicle
- J**
- Jack** ..... 451
- Jump starting** ..... 514
- K**
- Key, Mechanical**
- Loss of ..... 277
  - Replacing ..... 278
  - Unlocking/locking manually ..... 499
  - Valet locking ..... 283
- Key, SmartKey**
- Battery check lamp ..... 277
  - Checking batteries ..... 277
  - Factory setting ..... 275, 277
  - Global locking (KEYLESS-GO) ..... 277
  - Global locking (SmartKey) ..... 275
- Global unlocking (KEYLESS-GO) ..... 277
  - Global unlocking (SmartKey) ..... 275
  - Important notes on KEYLESS-GO ... 276
  - Locking/unlocking ..... 274
  - Loss of ..... 277
  - Messages in the multifunction display ..... 478
  - Opening, trunk ..... 279
  - Opening and closing the power tilt/sliding sunroof or the panorama roof ..... 309
  - Opening and closing the windows . 309
  - Remote control ..... 274
  - Replacing ..... 278
  - Replacing batteries ..... 502
  - Restoring to factory setting ... 275, 277
  - Selective setting ..... 275, 277
  - Starter switch positions ..... 284
- KEYLESS-GO**
- Starter switch positions ..... 284
- Keypad (COMAND)** ..... 79
- Kickdown** ..... 321
- Kickdown (manual shift program)** ... 325
- Kilopascal (air pressure unit)** ..... 431
- L**
- Labels**
- Certification ..... 524
  - Emission control information ..... 525
  - Tire and Loading Information placard ..... 418
  - Tire inflation pressure ..... 412
- Lamps, exterior**
- Exterior lamp switch ..... 298
  - Front ..... 505
  - Messages in the multifunction display ..... 485
  - Switching on/off ..... 298
- Lamps, indicator and warning**
- ABS ..... 32, 490
  - Adaptive Highbeam Assist ..... 301
  - Brakes ..... 490
  - Distance warning lamp ..... 333, 496
  - Engine malfunction ..... 496
  - ESC ..... 32, 495

ESC OFF .....	495
Fog lamps .....	300
Front passenger front air bag off .....	46, 498
Fuel tank reserve .....	496
High-beam headlamps .....	32, 301
Instrument cluster .....	489
Low-beam headlamps .....	299
Low tire pressure/TPMS malfunction telltale .....	497
Seat belt telltale .....	32, 52, 493
SRS .....	40, 494
Turn signals .....	32
<b>Lane Keeping Assist</b> .....	362
Messages in the multifunction display .....	462
Switching on or off .....	233
<b>Language settings</b> .....	94
<b>LATCH-type child seat anchors (ISOFIX)</b> see Children in the vehicle	
<b>License plate lamps</b> Messages in the multifunction display .....	486
<b>Light alloy wheels, cleaning</b> .....	445
<b>Lighters</b> see Cigarette lighters	
<b>Lighting</b> .....	298
Daytime running lamp mode .....	299
Exterior .....	298
Interior .....	304
<b>Limp-home mode</b> .....	325
<b>Load index (tires)</b> .....	426, 431
<b>Loading</b> see Vehicle loading	
<b>Locking the vehicle</b> KEYLESS-GO .....	275
Manually .....	500
SmartKey .....	274
<b>Loss of</b> Key .....	277
Service and Warranty Information booklet .....	524
<b>Low-beam headlamps</b> .....	299
Exterior lamp switch .....	298
Switching on .....	299
<b>Lubricants</b> .....	537

## M

<b>Maintenance</b> .....	22
<b>Maintenance Call, automatic (Tele Aid)</b> .....	395
<b>Maintenance System</b> Service indicator display .....	439
Service indicator message .....	439
Service term exceeded .....	439
<b>Manual headlamp mode (Low- beam headlamps)</b> .....	299
<b>Manual shift program</b> .....	324
<b>Maximum engine speed</b> see Vehicle specification	
<b>Maximum loaded vehicle weight</b> ....	431
<b>Maximum load rating (tires)</b> .....	431
<b>Maximum permissible tire inflation pressure</b> .....	431
<b>Mechanical key</b> see Key, Mechanical	
<b>Media interface</b> .....	200
<b>Memory function</b> .....	297
<b>Menus</b> see Control system menus	
<b>Minispare wheel</b> see Spare wheel	
<b>Mirrors</b> .....	294
Auto-dimming rear view mirrors ....	295
Exterior rear view mirror parking position .....	295
Exterior rear view mirrors .....	295
Front vanity mirrors .....	386
Interior rear view mirror .....	294
Memory function .....	297
Power-folding exterior rear view mirrors .....	296
Rear vanity mirrors .....	386
<b>MON (Motor Octane Number)</b> .....	541
<b>Motor Octane Number</b> see MON	
<b>MP3</b> .....	176
<b>Multicontour seats, front</b> .....	218
<b>Multicontour seats, rear</b> .....	293
<b>Multifunction display</b> .....	222
Symbol messages .....	466
Text messages .....	454
Vehicle status messages .....	452

**Multifunction display messages**

ABC (Active Body Control) .....	457
ABS .....	467, 468
Active headlamps .....	485
Advanced Parking Guidance .....	461
Advanced TPMS .....	464
Air bags .....	455
AIRMATIC .....	476
Alternator .....	463, 482
ATTENTION ASSIST .....	476
Automatic transmission .....	462, 463
Battery .....	463, 482
Blind Spot Assist .....	460
Brake fluid .....	472
Brake pads .....	466
Coolant .....	480
Corner-illuminating lamps .....	488
Cruise control .....	458
DISTRONIC PLUS .....	459
Doors .....	478
EBP .....	468
Engine oil .....	483
ESC .....	467, 468, 473
Fog lamps .....	485, 487
Front passenger front air bag .....	455
Gas cap .....	484
High-beam lamps .....	486
Hood .....	478
Lane Keeping Assist .....	462
License plate lamps .....	486
Light sensor .....	487
Low-beam lamps .....	487
Night View Assist Plus .....	477
Parking lamps .....	486
PRE-SAFE® .....	454
Radar sensors .....	461
Reserve fuel .....	484
Reverse lamp .....	485
Side marker lamps .....	485
SmartKey .....	478
SmartKey with KEYLESS-GO .....	478
SRS .....	474
Tele Aid .....	474
Tire inflation pressure .....	464, 489
Tire pressure monitor .....	464
Tires .....	464, 489

Trunk .....	478
Turn signals .....	488

**Multifunction steering wheel**

Adjustment .....	293
Buttons .....	221
Cleaning .....	446
Gearshift control .....	323
Heating .....	294
Memory function .....	297

**Music Register** ..... 196**N**

<b>Navigation</b> .....	95
Alternative route .....	138
Compass .....	137
Destination memory .....	145
Entering a destination .....	106
Entering a stopover .....	122
Introduction .....	95
Lane recommendation .....	131
Last destinations .....	147
Map software version .....	96
Points of interest (POI) .....	124
Route guidance .....	129
Traffic messages .....	138
Zagat® Rating Service .....	128
“Where am I?” function .....	136
<b>Navi menu</b> .....	225
<b>NECK-PRO active front head restraints</b> .....	55
Resetting .....	501
<b>Nets, parcel</b> .....	380
<b>Night security illumination</b> .....	208
<b>Night View Assist Plus</b> .....	356
Cleaning the windshield in front of the camera .....	444
Messages in the multifunction display .....	477
<b>Normal occupant weight</b> .....	431
<b>Number, vehicle identification (VIN)</b> .....	525

## O

**Occupant Classification System**

see OCS (Occupant Classification System)

**Occupant distribution** ..... 431

**Occupant safety**

Air bags ..... 41  
 Children and air bags ..... 41  
 Children in the vehicle ..... 56  
 Child seat anchors – LATCH-type (ISOFIX) ..... 60  
 Fastening the seat belts ..... 51  
 Front passenger front air bag off indicator lamp ..... 46, 498  
 Infant and child restraint systems .... 57  
 Introduction ..... 40  
 ISOFIX (Child seat anchors – LATCH-type) ..... 60  
 OCS (Occupant Classification System) ..... 46  
 PRE-SAFE® ..... 54  
 Seat belts ..... 43, 49

**OCS (Occupant Classification System)**

Self-test ..... 49

**Odometer** ..... 223

**Oil, oil level**

see Engine oil

**On-board computer**

see Control system

**One-touch gearshifting** ..... 323

**Operating safety** ..... 23

**Ornamental moldings, cleaning** ..... 443

**Overhead control panel** ..... 37

## P

**Paintwork, cleaning** ..... 441

**Paintwork code** ..... 525

**Panic alarm** ..... 62

**Panorama roof with power tilt/sliding panel** ..... 377

Cleaning ..... 445

Operation ..... 377

Roller sunblinds ..... 375

Synchronizing ..... 378

**Parcel nets** ..... 380

**Parking** ..... 314

Parking Guidance ..... 350, 352

Parktronic system ..... 347

**Parking Guidance** ..... 350

Canceling ..... 354

Detecting a parking space ..... 351

Parking ..... 352

**Parking position**

Exterior rear view mirrors ..... 295

Transmission position ..... 320

**Parktronic system**

Cleaning system sensors ..... 443

Malfunction ..... 350

Minimum distance ..... 348

Sensor range ..... 348

Switching on/off ..... 349

System sensors ..... 348

Warning indicators ..... 349

**Parts service** ..... 524

**PASS AIR BAG OFF indicator lamp**

see Front passenger front air bag off indicator lamp

**Passenger safety**

see Occupant safety

**Pedals** ..... 434

**Phone**

see Telephone

**Phone book** ..... 159

**Plastic parts, cleaning** ..... 446

**Power assistance** ..... 435

**Power closing assist for doors and trunk lid** ..... 283

**Power outlets** ..... 388

**Power seats**

see Seats

**Power tilt/sliding sunroof**

Operation ..... 373

Synchronizing ..... 375

**Power washer** ..... 441

**Power windows** ..... 307

Cleaning ..... 445

Operation ..... 307

Rear door window, override switch ..... 61

Rear door window sunshades ..... 308

Synchronizing ..... 308

**Practical hints** ..... 450

- PRE-SAFE®** ..... 54  
 Messages in the multifunction display ..... 454
- PRE-SAFE® Brake** ..... 69  
 Activating/deactivating ..... 232  
 Messages in the multifunction display ..... 454
- Problems**  
 While driving ..... 314  
 With vehicle ..... 24  
 With wipers ..... 306
- Product information** ..... 21
- Production options weight** ..... 431
- Program mode selector switch**  
 Automatic shift program ..... 322  
 Manual shift program ..... 324
- Proximity key**  
 see Key, SmartKey
- PSI (air pressure unit)** ..... 431
- R**
- RACETIMER** ..... 228
- Radar sensors**  
 Messages in the multifunction display ..... 461  
 Switching on or off ..... 236
- Radio** ..... 165  
 HD Radio™ ..... 167  
 Satellite radio ..... 170  
 Selecting stations ..... 226
- Radio transmitters** ..... 438
- Rain sensor**  
 see Intermittent wiping
- Rear axle oil** ..... 538
- Rear door ashtray**  
 see Ashtrays
- Rear doors**  
 Child safety locks ..... 61
- Rear door window**  
 Override switch ..... 61  
 Sunshades ..... 308
- Rear fog lamp**  
 see Fog lamps
- Rear Seat Entertainment System** .... 189  
 AUX sockets ..... 187  
 CD/DVD drive ..... 180
- Headphone ..... 82  
 Remote control ..... 81
- Rear seat head restraints**  
 see Head restraints
- Rear view camera** ..... 354  
 Cleaning the camera lens ..... 444
- Rear window defroster** ..... 372
- Recommended tire inflation pressure** ..... 411, 431
- Refrigerant, air conditioning** ..... 540
- Refueling** ..... 402
- Regular checks** ..... 403
- Reminder, Seat belt**  
 see Seat belts, Telltale
- Remote control**  
 see Key, SmartKey
- Remote control (Rear Seat Entertainment System)** ..... 81  
 Replacing batteries ..... 502
- Remote control (SPLITVIEW)** ..... 81  
 Replacing batteries ..... 502
- Remote door lock (Tele Aid)** ..... 394
- Remote door unlock (Tele Aid)** ..... 394
- Replacing**  
 Key ..... 278
- Replacing bulbs** ..... 504
- Reporting safety defects** ..... 24
- Research Octane Number**  
 see RON
- Reserve fuel**  
 Messages in the multifunction display ..... 484
- Reset tool (NECK-PRO active front head restraints)** ..... 501
- Restraint systems**  
 see Occupant safety
- Retaining hook** ..... 381
- Rims** ..... 431, 532
- Roadside Assistance** ..... 22, 391
- Roller sunblinds** ..... 375
- RON (Research Octane Number)** ..... 541
- Roof rack** ..... 380
- Rubber parts, cleaning** ..... 446

## S

**Safety**

- Driving safety systems ..... 63
- Occupant safety ..... 40
- Reporting defects ..... 24

**Safety belts**

see Seat belts

**Satellite radio** ..... 170**SD card** ..... 180**Seat belt force limiter** ..... 53**Seat belts** ..... 49

- Adjustment function ..... 52
- Automatic comfort-fit feature ..... 54
- Children in the vehicle ..... 56
- Cleaning ..... 446
- Fastening ..... 51
- Height adjustment ..... 52
- Proper use of ..... 50
- Safety guidelines ..... 43
- Safety notes ..... 49
- Telltale ..... 32, 493

**Seat heating** ..... 292**Seating capacity** ..... 419**Seats** ..... 286

- Adjustment ..... 286
- Drive-dynamic ..... 219
- Heating ..... 292
- Memory function ..... 297
- Multicontour, front ..... 218
- Multicontour, rear ..... 293
- Ventilation ..... 292

**Securing cargo**

- Cargo tie-down hooks ..... 381

**Selective setting**

see Key, SmartKey

**Selector lever**

see Gear selector lever

**Self-test**

- OCS (Occupant Classification System) ..... 49
- Tele Aid ..... 389

**Service**

see Maintenance

**Service, parts** ..... 524**Service and warranty information** ..... 21**Service intervals**

see Maintenance System, Service indicator message

**Service life (tires)** ..... 423**Service menu** ..... 233**Settings**

- Automatic locking ..... 210
- Automatic mirror folding ..... 209
- Display settings (COMAND) ..... 92
- Easy-entry/exit feature ..... 208
- Factory setting (KEYLESS-GO) ..... 277
- Factory setting (SmartKey) ..... 275
- Individual (vehicle) ..... 234
- Interior ambient lighting ..... 209
- Language ..... 94
- Locator lighting ..... 210
- Memory function ..... 297
- Night security illumination ..... 208
- Rear window sunshade ..... 207
- Seat belt adjustment function ..... 236
- Selective setting (KEYLESS-GO) ..... 277
- Selective setting (SmartKey) ..... 275
- Time ..... 92
- Trunk opening-height restriction ..... 210
- Voice Control System ..... 93

**Shelf below rear window, cleaning** .. 446**Shortcut buttons** ..... 77**Side impact air bags** ..... 45**Side marker lamps**

- Cleaning lenses ..... 443
- Messages in the multifunction display ..... 485

**Sidewall (tires)** ..... 432**SmartKey**

see Key, SmartKey

**SmartKey with KEYLESS-GO**

see Key, SmartKey

**Snow chains** ..... 433**Snow tires**

see Winter tires

**Spare wheel** ..... 532

- Mounting ..... 509
- Storage location ..... 451

**Speedometer** ..... 32

- Speed settings**  
 Cruise control ..... 329  
 DISTRONIC PLUS ..... 337  
 Resume function ..... 330, 338
- SPLITVIEW** ..... 90  
 Headphone ..... 82  
 Remote control ..... 81
- SRS**  
 Indicator lamp ..... 32
- SRS (Supplemental Restraint System)**  
 Indicator lamp ..... 40, 494  
 Messages in the multifunction display ..... 474
- Standing water, driving through** ..... 437
- Starter switch positions**  
 KEYLESS-GO ..... 284  
 SmartKey ..... 284
- Starting difficulties (engine)** ..... 312
- Starting the engine** ..... 311
- Steering column**  
 see Multifunction steering wheel, Adjustment
- Steering wheel**  
 see Multifunction steering wheel
- Steering wheel gearshift control** ..... 323
- Stolen Vehicle Recovery Services** ... 395
- Storage compartments** ..... 381
- Storing tires** ..... 424
- Sunroof**  
 see Power tilt/sliding sunroof
- Sunshade**  
 Rear door window ..... 308  
 Rear window ..... 386
- Sun visors** ..... 386
- Suspension tuning**  
 see AIRMATIC
- T**
- Tachometer** ..... 33, 327  
 Overspeed range ..... 327
- Tail lamps**  
 Cleaning lenses ..... 443
- Tar stains** ..... 441
- Technical data**  
 Air conditioning refrigerant .... 539, 540  
 Brake fluid ..... 538, 540  
 Capacities fuels, coolants, lubricants etc. .... 537  
 Coolant ..... 538, 542  
 Engine oil additives ..... 540  
 Engine oils ..... 537, 539  
 Fuel requirements ..... 541  
 Gasoline additives ..... 541  
 Identification labels ..... 524  
 Premium unleaded gasoline ..... 541  
 Rims and tires ..... 532  
 Spare wheel ..... 536  
 Vehicle specification  
 S 450 4MATIC ..... 527  
 Vehicle specification S 550 ..... 527  
 Vehicle specification  
 S 550 4MATIC ..... 528  
 Vehicle specification S 600 ..... 529  
 Vehicle specification S 63 AMG .... 530  
 Vehicle specification S 65 AMG .... 531  
 Washer and headlamp cleaning system ..... 539, 544
- Technical data (dimensions)**  
 see Vehicle specification
- Technical data (electrical system)**
- Technical data (engine)**  
 see Vehicle specification
- Technical data (weights)**  
 see Vehicle specification
- Tele Aid** ..... 389  
 Automatic Maintenance Call ..... 395  
 Emergency calls ..... 390  
 Information button ..... 392  
 Initiating an emergency call manually ..... 391  
 Messages in the multifunction display ..... 474  
 Remote door lock ..... 394  
 Remote door unlock ..... 394  
 Roadside Assistance button ..... 391  
 Search & Send ..... 393  
 SOS button ..... 391  
 Stolen Vehicle Recovery Services .. 395  
 System self-test ..... 389
- Telephone** ..... 148  
 Answering/ending a call ..... 230  
 Bluetooth® interface ..... 151  
 Call lists ..... 163

- Call waiting, call holding, and conference ..... 158
- Emergency call “911” ..... 150
- Functions during a single party call ..... 157
- Making calls ..... 156
- Menu ..... 230
- Operation ..... 230
- Phone book ..... 159, 231
- Redialing ..... 231
- Telephone keypad** ..... 79
- Temperature**
  - Coolant ..... 327
  - Interior temperature ..... 367
  - Outside ..... 327
- Tether anchorage points**
  - see Children in the vehicle
- Tie-down hooks** ..... 381
- Tightening torque**
  - Wheels ..... 512
- Time settings** ..... 92
- TIN (Tire Identification Number)** ..... 432
- Tire and Loading Information placard** ..... 418
- Tire and loading terminology** ..... 430
- Tire Identification Number**
  - see TIN
- Tire inflation pressure**
  - Checking ..... 413
  - Important notes on ..... 412
  - Label on the inside of fuel filler flap ..... 412
  - Placard on driver’s door B-pillar ..... 418
- Tire labeling** ..... 426
- Tire load rating** ..... 431
- Tire ply composition and material used** ..... 432
- Tires** ..... 410, 532
  - Advanced Tire Pressure Monitoring System (Advanced TPMS) ..... 414
  - Air pressure ..... 411
  - Care and maintenance ..... 423
  - Cleaning ..... 424
  - Direction of rotation, spinning ..... 422
  - Important notes on tire inflation pressure ..... 412
  - Inflation pressure ..... 413
  - Information placard ..... 418
  - Inspection ..... 423
  - Labeling ..... 426
  - Load index ..... 426, 431
  - Load rating ..... 431
  - Messages in the multifunction display ..... 464, 489
  - Ply composition and material used ..... 432
  - Problems under-/overinflation ..... 413
  - Retreads ..... 410
  - Rims and tires (technical data) ..... 532
  - Rotation ..... 425
  - Service life ..... 423
  - Sizes ..... 532
  - Snow chains ..... 433
  - Speed rating ..... 427, 432
  - Storing ..... 424
  - Temperature ..... 412, 425
  - Terminology ..... 430
  - Tire Identification Number ..... 432
  - TPMS low tire pressure/malfunction telltale ..... 497
  - Traction ..... 424, 432
  - Tread ..... 432
  - Tread depth ..... 423, 432
  - Treadwear ..... 424
  - Treadwear indicators ..... 423, 432
  - Vehicle maximum load on ..... 432
  - Wear pattern ..... 425
  - Winter tires ..... 432, 532
- Tire speed rating** ..... 427, 432
- Top tether**
  - see Children in the vehicle
- Total load limit** ..... 432
- Towing**
  - Towing eye bolt ..... 517
  - Vehicle ..... 516
- Towing eye bolt** ..... 517
- Traction** ..... 424, 432
- Traffic messages** ..... 138
- Transfer case** ..... 325
- Transmission**
  - see Automatic transmission
- Transmission fluid level** ..... 408
- Transmission gear selector lever**
  - see Gear selector lever



- Transmission positions** ..... 320
- Traveling abroad** ..... 438
- Tread (tires)** ..... 432
- Tread depth (tires)** ..... 423, 432
- Treadwear** ..... 424
- Treadwear indicators (tires)** .... 423, 432
- Trip menu** ..... 223
- Trunk**
- Closing ..... 280
  - Messages in the multifunction display ..... 478
  - Opening ..... 279
  - Opening/closing system ..... 281
  - Opening-height restriction ..... 210
  - Tie-down hooks ..... 381
  - Trunk lid emergency release ..... 282
  - Unlocking manually ..... 500
  - Valet locking ..... 283
- Turning off the engine** ..... 316
- Turn signals** ..... 301
- Cleaning lenses ..... 443
  - Indicator lamps ..... 32
  - Messages in the multifunction display ..... 488
- U**
- Uniform Tire Quality Grading Standards** ..... 424, 432
- Units**
- Selecting speedometer display mode ..... 235
- Unleaded gasoline, premium** ..... 541
- Unlocking the vehicle**
- KEYLESS-GO ..... 275
  - Manually ..... 499
  - SmartKey ..... 274
- Upholstery, cleaning** ..... 446
- USB devices (media interface)** ..... 200
- USB socket** ..... 80
- Useful features** ..... 384
- V**
- Valet locking** ..... 283
- Vehicle**
- Battery ..... 512
  - Care ..... 440
  - Control system ..... 220
  - Identification Number (VIN) ..... 524
  - Individual settings ..... 234
  - Locking/unlocking ..... 274
  - Lowering (wheel change) ..... 512
  - Modifications and alterations, Operating safety ..... 23
  - Towing ..... 516
  - Unlocking/locking manually ..... 499
- Vehicle dimensions**  
see Vehicle specification
- Vehicle Identification Number (VIN)** ..... 524
- Vehicle jack**  
see Jack
- Vehicle level control**  
♦ see AIRMATIC
- Vehicle lighting** ..... 298
- Vehicle loading**
- Instructions ..... 379
  - Load limit ..... 419
  - Roof rack ..... 380
  - Terminology ..... 430
- Vehicle maximum load on the tire** ... 432
- Vehicle specification**
- S 450 4MATIC ..... 527
  - S 550 ..... 527
  - S 550 4MATIC ..... 528
  - S 600 ..... 529
  - S 63 AMG ..... 530
  - S 65 AMG ..... 531
- Vehicle status message memory** .... 233
- Vehicle tool kit** ..... 450
- Vehicle washing**  
see Vehicle care
- Vehicle weights**  
see Vehicle specification
- Video** ..... 191
- Video Aux** ..... 186
- Voice Control System**
- Address book ..... 249
  - CD/DVD changer/MP3 ..... 255
  - Command list ..... 257
  - External devices ..... 257
  - Individualization ..... 271
  - Introduction ..... 237
  - Navigation ..... 240

Radio .....	252
Settings .....	93
Telephone .....	245
Troubleshooting .....	267

<b>Wood trims, cleaning</b> .....	447
-----------------------------------	-----

## Z

<b>ZAGAT® Rating Service</b> .....	128
------------------------------------	-----

## W

### Warning sounds

DISTRONIC PLUS .....	333
Driver's or passenger's seat belt .....	52
Electronic parking brake .....	469
Parking Guidance .....	352
Parktronic system .....	350
Seat belt telltale .....	493

<b>Warranty coverage</b> .....	524
--------------------------------	-----

### Washer and headlamp cleaning

<b>system</b> .....	544
---------------------	-----

### Washer fluid

Mixing ratio .....	544
Refilling .....	409

<b>Washing the vehicle</b> .....	440
----------------------------------	-----

<b>Wear pattern (tires)</b> .....	425
-----------------------------------	-----

### Weights (vehicle)

see Vehicle specification

### Wheel

Changing .....	508
Removing .....	511
Spare .....	508
Tightening torque .....	512

<b>Wheels, sizes</b> .....	532
----------------------------	-----

<b>Wheels, Tires and</b> .....	410
--------------------------------	-----

<b>Window curtain air bags</b> .....	45
--------------------------------------	----

### Windows

see Power windows

<b>Windows, cleaning</b> .....	445
--------------------------------	-----

### Windshield

Cleaning wiper blades .....	445
Defogging .....	371
Infrared reflecting .....	399
Washer fluid .....	544
Wipers .....	305

### Windshield wipers

Replacing wiper blades .....	507
------------------------------	-----

### Winter driving

Instructions .....	433
Snow chains .....	433
Tires .....	432

<b>Winter tires</b> .....	432, 532
---------------------------	----------

امداد خود پارنا  
 تلفن شبانه روزی: ۰۲۱-۸۸۶۲۰۸۵  
 FarmSOS.com

## Product Information

Please observe the following in your own best interest:

We recommend using Genuine Mercedes-Benz Parts as well as conversion parts and accessories explicitly approved by us for your vehicle model.

We have tested these parts to determine their reliability, safety and special suitability for Mercedes-Benz vehicles.

We are unable to make an assessment for other products and therefore cannot be held responsible for them, even if in individual cases an official approval or authorization by governmental or other agencies should exist. Use of such parts and accessories could adversely affect the safety, performance or reliability of your vehicle. Please do not use them.

Genuine Mercedes-Benz Parts and pre-approved conversion parts and accessories are available at any authorized Mercedes-Benz Center. In addition, you will receive comprehensive information on permissible technical modifications and expert installations.

## Operator's Manual

### Notes

This Operator's Manual contains a great deal of useful information. We urge you to read it carefully and familiarize yourself with the vehicle before driving.

For your own safety and longer service life of the vehicle, we urge you to follow the instructions and warnings contained in this Operator's Manual. Ignoring them could result in damage to the vehicle or personal injury to you or others. Vehicle damage caused by failure to follow instructions is not covered by the Mercedes-Benz Limited Warranty.

We continuously strive to improve our product and ask for your understanding that we reserve the right to make changes in design and equipment. Therefore, information, illustrations, and descriptions in this Operator's Manual might differ from your vehicle.

## Vehicle equipment

Your vehicle may have some or all of the equipment described in this manual. Therefore, you may find explanations for optional equipment not installed in your vehicle. If you have any questions about operating particular equipment, any authorized Mercedes-Benz Center will be glad to demonstrate the proper procedures.

Optional equipment is also described in this manual, including operating instructions wherever necessary. Since they are special-order items, the descriptions and illustrations herein may vary slightly from the actual equipment of your vehicle.

If there are any equipment details that are not shown or described in this Operator's Manual, any authorized Mercedes-Benz Center will be glad to inform you of correct care and operating procedures. The Operator's Manual and Maintenance Booklet are important documents and should be kept with the vehicle.

## Service and warranty information

The Service and Warranty Information booklet contains detailed information about the warranties covering your Mercedes-Benz, including:

- New Vehicle Limited Warranty
- Emission System Warranty
- Emission Performance Warranty
- California, Connecticut, Maine, Massachusetts, New York, Pennsylvania,

Rhode Island, and Vermont Emission Control System Warranty

- State Warranty Enforcement Laws (Lemon Laws)

### Important notice for California retail buyers and lessees of Mercedes-Benz automobiles

Under California law you may be entitled to a replacement of your vehicle or a refund of the purchase price or lease price, if after a reasonable number of repair attempts Mercedes-Benz USA, LLC and/or its authorized repair or service facilities fail to fix one or more substantial defects or malfunctions in the vehicle that are covered by its express warranty. During the period of 18 months from original delivery of the vehicle or the accumulation of 18 000 miles (approximately 29 000 km) on the odometer of the vehicle, whichever occurs first, a reasonable number of repair attempts is presumed for a retail buyer or lessee if one or more of the following occurs:

- (1) the same substantial defect or malfunction results in a condition that is likely to cause death or serious bodily injury if the vehicle is driven, that defect or malfunction has been subject to repair two or more times, and you have directly notified Mercedes-Benz USA, LLC in writing of the need for its repair,
- (2) the same substantial defect or malfunction of a less serious nature than category (1) has been subject to repair four or more times and you have directly notified us in writing of the need for its repair, or
- (3) the vehicle is out of service by reason of repair of the same or different substantial defects or malfunctions for a cumulative total of more than 30 calendar days.

Written notification should not be sent to a dealer, it should be addressed to

Mercedes-Benz USA, LLC  
Customer Assistance Center  
One Mercedes Drive  
Montvale, NJ 07645-0350

### Maintenance

The Maintenance Booklet describes all the necessary maintenance work which should be performed at regular intervals.

Always have the Maintenance Booklet with you when you take the vehicle to an authorized Mercedes-Benz Center for service. The service advisor will record each service in the booklet for you.

### Roadside Assistance

The Mercedes-Benz Roadside Assistance Program provides factory-trained technical help in the event of a breakdown. Calls to the toll-free Roadside Assistance number

**1-800-FOR-MERCEdes (1-800-367-6372)**  
**(in the USA) 1-800-387-0100 (in Canada)**

will be answered by Mercedes-Benz Customer Assistance Representatives 24 hours a day, 365 days a year.

For additional information refer to the Mercedes-Benz Roadside Assistance Program brochure (in the USA) or the Roadside Assistance section of the Service and Warranty Information Booklet (in Canada) in your vehicle literature portfolio.

### Change of address or ownership

If you change your address, be sure to send in the "Change of Address Notice" found in the Service and Warranty Information Booklet, or simply call the Mercedes-Benz Customer Assistance Center (in the USA) at 1-800-FOR-MERCEdes (1-800-367-6372), or Customer Service (in Canada) at 1-800-387-0100. This will assist us in

contacting you in a timely manner should the need arise.

If you sell your Mercedes, please leave all literature with the vehicle to make it available to the next operator.

If you bought this vehicle used, be sure to send in the “Notice of Purchase of Used Car” found in the Service and Warranty Information Booklet, or call the Mercedes-Benz Customer Assistance Center (in the USA) at 1-800-FOR-MERcedes (1-800-367-6372), or Customer Service (in Canada) at 1-800-387-0100.

### Operating your vehicle outside the USA or Canada

If you plan to operate your vehicle in foreign countries, please be aware that:

- Service facilities or replacement parts may not be readily available.
- Unleaded gasoline for vehicles with catalytic converters may not be available; the use of leaded fuels will damage the catalysts.
- Gasoline may have a considerably lower octane rating, and improper fuel can cause engine damage.

Certain Mercedes-Benz models are available for delivery in Europe under our European Delivery Program. For details, consult an authorized Mercedes-Benz Center or write to:

#### In the USA:

Mercedes-Benz USA, LLC  
European Delivery Department  
One Mercedes Drive  
Montvale, NJ 07645-0350

#### In Canada:

Mercedes-Benz Canada, Inc.  
European Delivery Department  
98 Vanderhoof Avenue  
Toronto, Ontario M4G 4C9

## Operating safety

### Warning!

Work improperly carried out on electronic components and associated software could cause them to cease functioning. Because the vehicle’s electronic components are interconnected, any modifications made may produce an undesired effect on other systems. Electronic malfunctions could seriously impair the operating safety of your vehicle.

Contact an authorized Mercedes-Benz Center for repairs or modifications to electronic components.

Other improper work or modifications on the vehicle could also have a negative impact on the operating safety of the vehicle.

Some safety systems only function while the engine is running. You should therefore never turn off the engine while driving.

### Warning!

Heavy blows against the vehicle underbody or tires/wheels may cause serious damage and impair the operating safety of your vehicle.

Such blows can be caused, for example, by running over an obstacle, road debris or a pothole. If you feel a sudden significant vibration or ride disturbance, or you suspect that damage to your vehicle as occurred:

- turn on your hazard warning flashers
- slow down carefully
- drive with caution to an area which is a safe distance from the road

Inspect the vehicle underbody and tires/wheels for possible damage. If the vehicle appears unsafe, have it towed to the nearest authorized Mercedes-Benz Center or other qualified maintenance or repair facility for further inspection or repairs.

### Proper use of the vehicle

Proper use of the vehicle requires that you are familiar with the following information and rules:

- the safety precautions in this manual
- the “Technical data” section in this manual
- traffic rules and regulations
- motor vehicle laws and safety standards

#### Warning!

Various warning labels are attached to your vehicle. These warning labels are intended to make you and others aware of various risks. Do not remove any of these warning labels unless explicitly instructed to do so by information on the label itself. Removing warning labels may cause you and others to be unaware of certain risks which may result in an accident and/or personal injury.

#### Warning!

HYBRID vehicles: It is imperative that you read the HYBRID Supplemental Operating Instructions included in your vehicle literature portfolio. You may otherwise not receive all necessary safety information and warning for the operation of your vehicle.

### Problems with your vehicle

If you should experience a problem with your vehicle, particularly one that you believe may affect its safe operation, we urge you to contact an authorized Mercedes-Benz Center immediately to have the problem diagnosed and corrected if required. If the matter is not handled to your satisfaction, please discuss the problem with the Mercedes-Benz Center management or, if necessary, contact us at one of the following addresses:

#### In the USA:

Customer Assistance Center  
Mercedes-Benz USA, LLC  
One Mercedes Drive

Montvale, NJ 07645-0350

#### In Canada:

Customer Relations Department  
Mercedes-Benz Canada, Inc.  
98 Vanderhoof Avenue  
Toronto, Ontario M4G 4C9

### Reporting safety defects

For the USA only:

The following text is published as required of manufacturers under Title 49, Code of U.S. Federal Regulations, Part 575 pursuant to the “National Traffic and Motor Vehicle Safety Act of 1966”.

### Reporting safety defects

If you believe that your vehicle has a defect which could cause a crash or could cause injury or death, you should immediately inform the National Highway Traffic Safety Administration (NHTSA) in addition to notifying Mercedes-Benz USA, LLC.

If NHTSA receives similar complaints, it may open an investigation, and if it finds that a safety defect exists in a group of vehicles, it may order a recall and remedy campaign. However, NHTSA cannot become involved in individual problems between you, your dealer, or Mercedes-Benz USA, LLC.

To contact NHTSA, you may call the Vehicle Safety Hotline toll-free at 1-888-327-4236 (TTY: 1-800-424-9153); go to **www.safercar.gov**; or write to: Administrator, NHTSA Headquarters, 1200 New Jersey Avenue, SE, West Building, Washington, DC 20590.

You can also obtain other information about motor vehicle safety from **www.safercar.gov**.

## Vehicle data recording

### Information regarding electronic recording devices

(Including notice pursuant to California Code § 9951)

Please note that your vehicle is equipped with devices that can record vehicle systems data and, if equipped with the Tele Aid system, may transmit some data in certain accidents.

This information helps, for example, to diagnose vehicle systems after a collision and to continuously improve vehicle safety.

Daimler may access the information and share it with others

- for safety research or vehicle diagnosis purposes
- with the consent of the vehicle owner or lessee
- in response to an official request by law enforcement or other government agency
- for use in dispute resolution involving Daimler, its affiliates or sales/service organization and/or
- as otherwise required or permitted by law

Please check the Tele Aid subscription service agreement for details regarding the information that may be recorded or transmitted via that system.

امداد خودرو فارما

تلفن شبانه روزی: ۰۸۵/۲۰۸۵

FarmaSOS.com

# امداد خودرو فارما

تلفن شبانه روزی: ۰۲۱-۸۸۸۶۲۰۸۵

**FarmaSOS.com**



Exterior view .....	28
Rear passenger compartment .....	29
Cockpit .....	30
Instrument cluster .....	32
Control systems .....	34
Center console .....	36
Overhead control panel .....	37
Driver's door control panel .....	38
Rear door control panel .....	38

# امداد خودرو فارما

تلفن شبانه روزی: ۰۲۱-۸۸۸۶۲۰۸۵

[FarmaSOS.com](http://FarmaSOS.com)



## Exterior view

At a glance

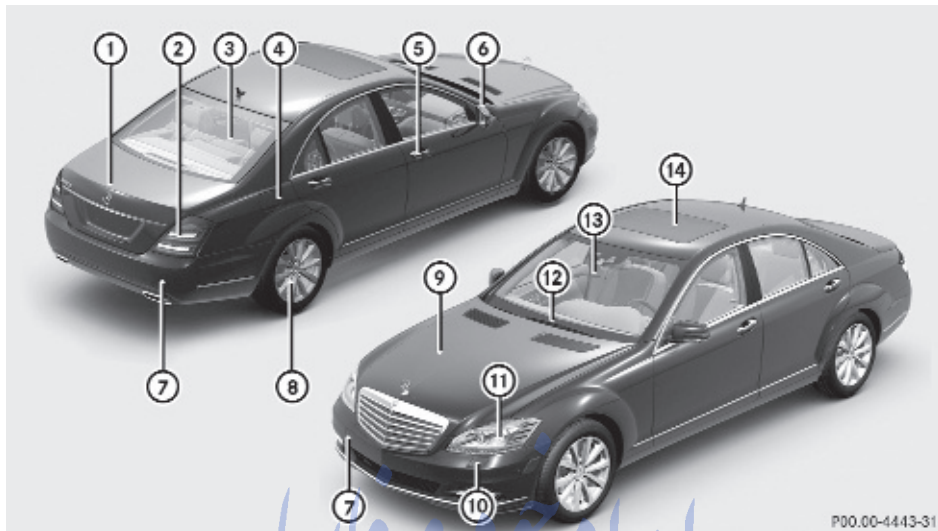

P00.00-4443-31

**i** This Operator's Manual describes all features, standard or optional, potentially available for your vehicle at the time of purchase. Please be aware that your vehicle might not be equipped with all features described in this manual.

	Function	Page	Function	Page
①	Trunk: Locking and unlocking Opening and closing Valet locking	274 279, 280 283	Rims and tires	532
②	Rear lamps	504	⑨ Hood	404
③	Rear window defroster	372	⑩ Headlamp cleaning system	303
④	Fuel filler flap	402	⑪ Front lamps	504
⑤	Doors: Locking and unlocking	274, 499	⑫ Wipers Wiper blades, replacing Wiper blades, cleaning	305 507 445
⑥	Exterior rear view mirrors Parking position Power-folding	295 295 296	⑬ Windshield: Wiping with washer fluid Cleaning	305 445
⑦	Towing eyes	517	⑭ Roof: Power tilt/sliding sunroof Panorama roof with power tilt/sliding panel	373 375
⑧	Tires and wheels	410		

## Rear passenger compartment

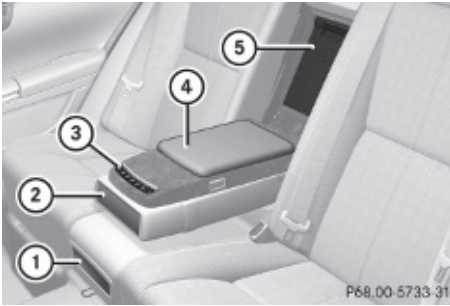

	Function	Page
①	Cupholder under the rear center armrest	384
②	Cupholder in the rear center armrest	384
③	Control panel for rear multicontour seats	293
④	Armrest with integrated storage compartment	383
⑤	Rear storage box	383

امداد خودرو فارما  
 تلفن شبانه روزی: ۰۲۱-۸۸۶۳۰۸۵  
 FarmaSOS.com

## Cockpit

At a glance

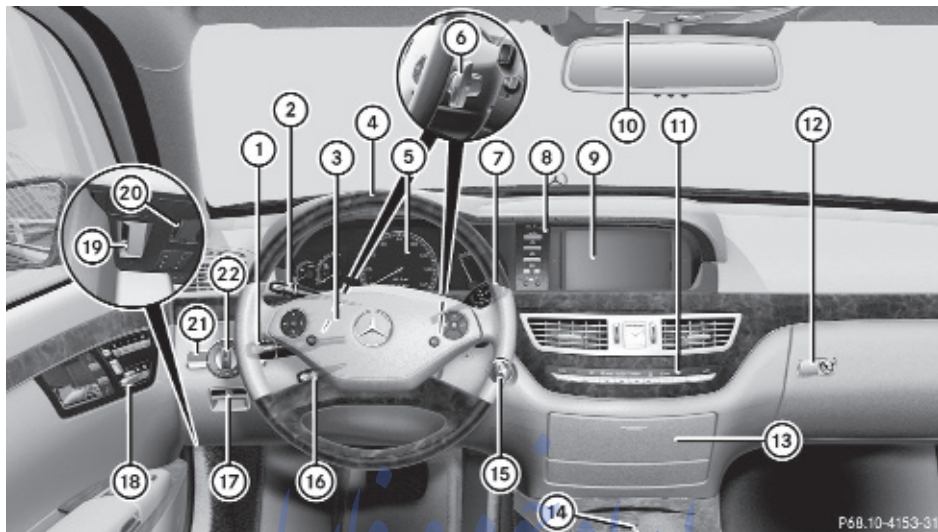

	Function	Page	Function	Page
①	Combination switch: Turn signals Wipers High beam	301 305 301	Suspension tuning switch	343, 346
②	Cruise control lever: Cruise control DISTRONIC PLUS	328 330	Parktronic/Parking Guidance deactivation switch	347, 350
③	Horn		Swiveling COMAND display	78
④	Multifunction steering wheel	221	COMAND display illumination	78
⑤	Instrument cluster	326	Instrument cluster display illumination	326
⑥	Steering wheel gearshift control	323	⑨ COMAND display	78
⑦	Gear selector lever	317	⑩ Overhead control panel	37
⑧	Control panel with: Front passenger front air bag off indicator lamp Vehicle level control switch	46 344, 345	⑪ Climate control Center console	363 36
			⑫ Glove box lock	381
			⑬ CD/DVD changer SD card slot	179 180
			⑭ Control systems controls	34
			⑮ Starter switch	284

	Function	Page
	KEYLESS-GO start/stop button	284
⑩⑥	Steering wheel adjustment stalk	294
	Heated steering wheel	294
⑩⑦	Electronic parking brake	315
⑩⑧	Door control panel	38

	Function	Page
⑩⑨	Hood lock release	404
⑩⑩	On-board diagnostics (OBD) socket	
⑩⑪	Night View Assist Plus	356
⑩⑫	Exterior lamp switch	298

# امداد خودرو فارما

تلفن شبانه روزی: ۰۲۱-۸۸۸۶۲۰۸۵

[FarmaSOS.com](http://FarmaSOS.com)





## Instrument cluster







P54.32-7706-31

Function	Page	Function	Page
① Coolant temperature gauge	327	Ⓟ Electronic parking brake warning or indicator lamps, Canada only	492
② Fuel gauge with:		Ⓛ BRAKE Brake warning lamp, USA only	492
Fuel tank reserve warning lamp	496	Ⓛ Brake warning lamp, Canada only	492
Ⓛ High-beam headlamp indicator lamp	301	Ⓛ Seat belt telltale	493
Ⓛ Antilock Brake System (ABS) indicator lamp	490	Ⓛ Combination low tire pressure/TPMS malfunction telltale, USA only	414, 497
Ⓛ Supplemental Restraint System (SRS) indicator lamp	494	Ⓛ Low tire pressure telltale, Canada only	414, 497
③ Parktronic/Parking Guidance warning indicator for left front area	349	Ⓛ Left turn signal indicator lamp	
④ Multifunction display with:		Ⓛ Right turn signal indicator lamp	
Speedometer		Ⓛ ESC warning lamp	473
Ⓛ Electronic parking brake warning or indicator lamps, USA only	492	Ⓛ Distance warning lamp <sup>1</sup>	496

1 Vehicles without DISTRONIC PLUS: Warning lamp without function. It illuminates when the ignition is on. It should go out when the engine is running.

	Function	Page
	 ESC OFF warning lamp	473
	 Parking space indicator lamp	350
	 Recuperative Brake System (RBS) warning lamp, S 400 HYBRID only <sup>2</sup>	
	Green or yellow READY indicator lamp for the HYBRID system, S 400 HYBRID only <sup>2</sup>	
⑤	Parktronic/Parking Guidance warning indicator for right front area	349
⑥	Transmission position/range indicator	321
⑦	Tachometer with:  Engine malfunction indicator lamp	496

	Function	Page
⑧	Program mode indicator	322
⑨	Main menus for instrument cluster control system	222
⑩	Outside temperature	327
⑪	Display with:	
	Additional speedometer	235
	 Adaptive Highbeam Assist indicator lamp	301
	 Lane Keeping Assistance indicator lamp	362
	 Attention Assist indicator lamp	355
	 PRE-SAFE <sup>®</sup> Brake indicator lamp	232
	or	
	HOLD function indicator lamp	342

تلفن شبانه روزی: ۰۲۱-۸۸۸۶۲۰۸۵







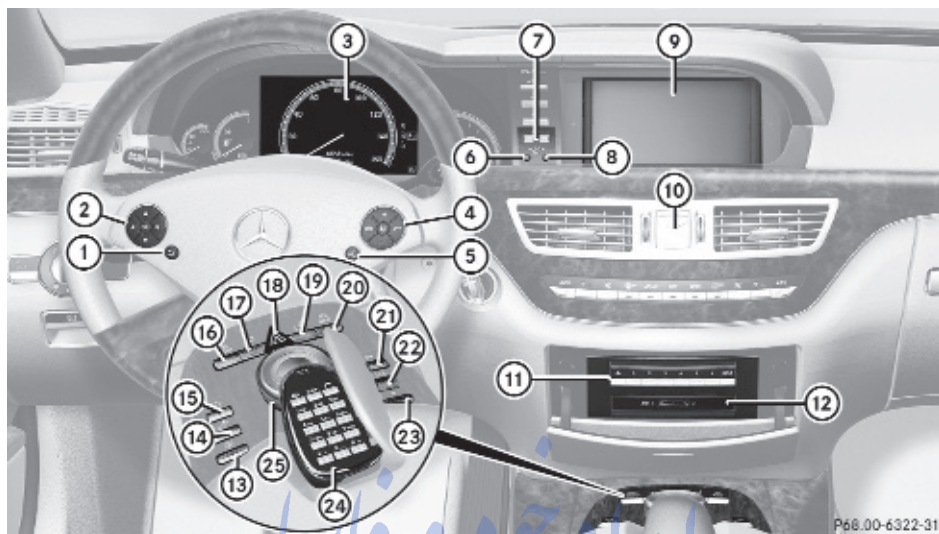





FarmaSOS.com

<sup>2</sup> See separate HYBRID Supplemental Operating Instructions.



## Control systems



P66.00-6322-31

	Function	Page	Function	Page
①	<p>Press button  briefly to cancel Voice Control System, back, confirm messages.</p> <p>Press and hold button  to select the standard display.</p>		<p>Press and hold button  or : within Audio to select previous or next station in station list or wave band within Telephone menu to start the quick search in the phone book</p> <p>Press button  to confirm selection or messages.</p>	
②	<p>Press button  or  to select menus.</p> <p>Press button  or  briefly:</p> <p>to select function or scroll through lists</p> <p>within Audio menu to select previous or next track, scene or stored station</p> <p>within Telephone menu to switch to the phone book and select a name or number</p>		<p>③ Multifunction display</p> <p>④ Press button :</p> <p>to end a call</p> <p>to reject an incoming call</p> <p>Press button :</p> <p>to answer a call</p> <p>to dial</p> <p>to redial</p> <p>Press button  to mute.</p>	<p>222</p> <p>158</p> <p>156</p> <p>156</p> <p>156</p> <p>157</p>



	Function	Page		Function	Page
	Press button  or  : to set the volume to operate the RACETIMER <sup>3</sup>		⑳	COMAND on/off button	77
⑤	Press button  : to activate Voice Control System to accept a call	239 156	㉑	Volume control	88
⑥	Instrument cluster illumination	326	㉒	Favorite button	94
⑦	Swiveling COMAND display	78	㉓	Telephone keypad	150
⑧	COMAND display illumination	78	㉔	COMAND controller	79
⑨	COMAND display	78			
⑩	Clock	92			
⑪	CD/DVD changer	179			
⑫	SD card slot	180			
⑬	Rear window sunshade switch	386			
⑭	Head restraint release switch	291			
⑮	Program mode selector switch for automatic transmission	322			
⑯	Shortcut button for: CD/DVD/SD card Radio	181 166			
⑰	Back button	87			
⑱	Hazard warning flasher switch	302			
㉑	Seat menu button	216			
㉒	Shortcut button for: Telephone Navigation	150 101			

<sup>3</sup> AMG vehicles only

## Center console

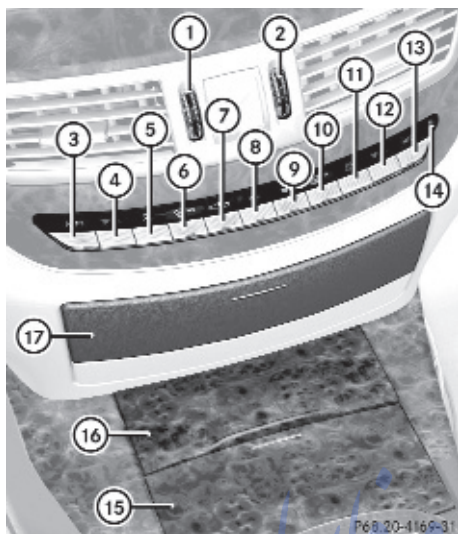

	Function	Page
①	Thumbwheel for air volume control for left center air vent	368
②	Thumbwheel for air volume control for right center air vent	368
③	Air distribution and air volume, driver's side (automatic mode)	366
④	Temperature control, driver's side	367
⑤	Manual fan speed adjustment, driver's side	370
⑥	Front defroster	370
⑦	Air recirculation	371
⑧	Climate control on/off	366
⑨	Residual engine heat and ventilation (REST)	372
⑩	Rear window defroster	372

	Function	Page
⑪	Manual fan speed adjustment, passenger side	370
⑫	Temperature control, passenger side	367
⑬	Air distribution and air volume, passenger side (automatic mode)	366
⑭	Alarm system indicator lamp	72
⑮	Cup holder	384
⑯	Ashtray	387
	◆ Cigarette lighter	387
⑰	CD/DVD changer	179
	SD card slot	180

تلفن شبانه روزی: ۰۸۵-۱۸۸۶۲۰۲۱

FarmaSOS.com

## Overhead control panel

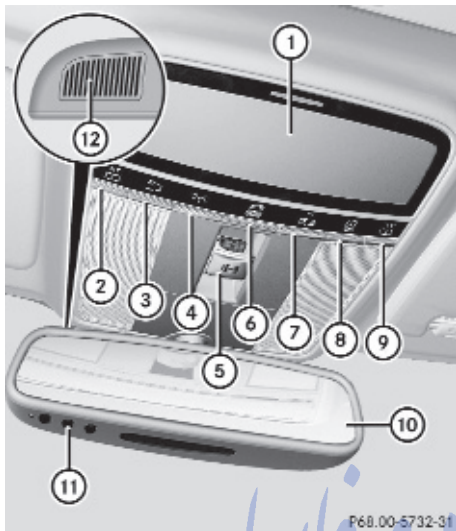

P68.00-5732-31

	Function	Page
①	Eyeglasses compartment	38 1
②	Left reading lamp on/off	304
③	Rear interior lighting on/off	304
④	Front interior lighting on/off	304
⑤	Power tilt/sliding sunroof switch or panorama roof with power tilt/sliding panel switch	373, 375
⑥	SOS button (Tele Aid system)	389
⑦	Automatic interior lighting control	304
⑧	Opening/closing rear roller sunblinds	376
⑨	Right reading lamp on/off	304
⑩	Interior rear view mirror	294
⑪	Garage door opener	395
⑫	Hands-free microphone for:	

Function	Page
Tele Aid (emergency call system)	389
Telephone	148
Voice Control System	237

امداد خود فارما

تلفن شبانه روزی: ۰۸۸۶۰۰۸۵

FarmaSOS.com

## Driver's door control panel

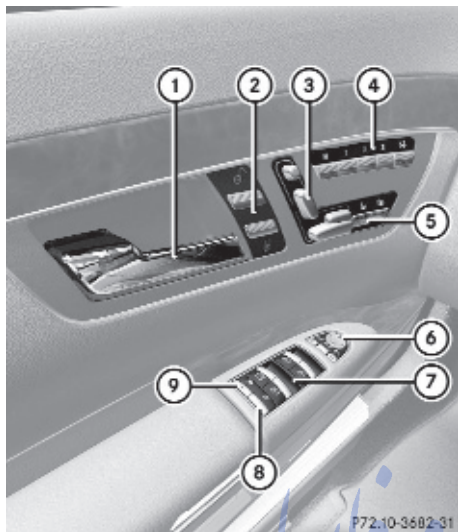

P72.10-3682-31

	Function	Page
①	Inside door handle	278
②	Central unlocking switch Central locking switch	279 279
③	Seat adjustment switch	287
④	Memory function Selector button for front passenger seat	297 288
⑤	Seat heating switch Seat ventilation switch	292 292
⑥	Exterior rear view mirror adjustment Power-folding exterior rear view mirrors	295 296
⑦	Switches for opening/ closing front and rear door windows	307
⑧	Remote trunk opening/ closing switch	279
⑨	Override switch	61

## Rear door control panel

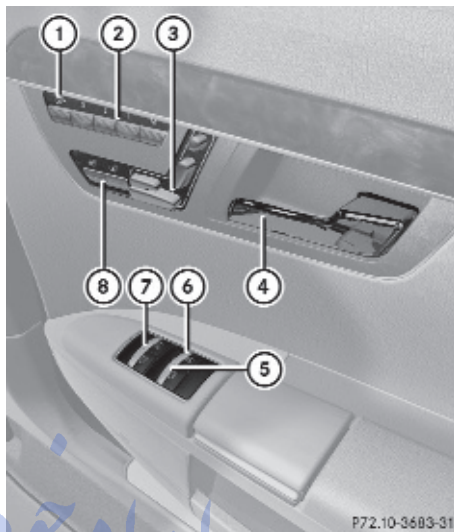

P72.10-3683-31

	Function	Page
①	Selector button for front passenger seat adjustment, on the right rear door only	288
②	Memory function, Canada only	297
③	Seat adjustment switch	287
④	Inside door handle	278
⑤	Switch for extending/ retracting rear window sunshade	386
⑥	Button for extending/ retracting panorama roof sunblind	375
⑦	Switches for opening/ closing door windows Switches for opening/ closing rear side window sunshades	307 308
⑧	Seat heating switch Seat ventilation switch	292 292

Vehicle equipment .....	40
Occupant safety .....	40
Panic alarm .....	62
Driving safety systems .....	63
Anti-theft systems .....	71

# امداد خودرو فارما

تلفن شبانه روزی: ۰۲۱-۸۸۸۶۲۰۸۵

[FarmaSOS.com](http://FarmaSOS.com)



## Vehicle equipment

**i** This Operator's Manual describes all features, standard or optional, potentially available for your vehicle at the time of purchase. Please be aware that your vehicle might not be equipped with all features described in this manual.

## Occupant safety

### Introduction

In this section you will learn the most important facts about the restraint system components of the vehicle.

The restraint systems are:

- Seat belts
- Child restraints
- Lower Anchors and Iethers for Children (LATCH) also known as ISOFIX

Additional protection potential is provided by:

- Supplemental Restraint System (SRS) with
  - Air bags
  - Air bag control unit (with crash sensors)
  - Emergency Tensioning Device (ETD) for seat belts
  - Seat belt force limiter
- NECK-PRO active front head restraints
- Preventive occupant safety (PRE-SAFE®)
- Air bag system components with
  - Front passenger front air bag off indicator lamp
  - Front passenger seat with Occupant Classification System (OCS)

Although the systems are independent, their protective functions work in conjunction with each other.

### Warning!

Modifications to or work improperly conducted on restraint system components or their wiring, as well as tampering with interconnected electronic systems, can lead to the restraint systems no longer functioning as intended.

Air bags or Emergency Tensioning Devices (ETDs), for example, could deploy inadvertently or fail to deploy in accidents although the deceleration threshold for air bag deployment is exceeded. Therefore, never modify the restraint systems. Do not tamper with electronic components or their software.

- i** See “Children in the vehicle” (▷ page 56) for information on
- infants and children traveling with you in the vehicle
  - restraint systems for infants and children

### SRS indicator lamp

The SRS system conducts a self-test when the ignition is switched on and in regular intervals while the engine is running. This facilitates detection of system malfunctions.

The SRS indicator lamp  in the instrument cluster comes on when the ignition is switched on. It goes out no later than a few seconds after the engine has been started.

The SRS components are in operational readiness when the SRS indicator lamp  is not lit while the engine is running.

 **Warning!**

The SRS self-check has detected a malfunction when the SRS indicator lamp



- does not come on at all
- fails to go out after approximately 4 seconds after the engine was started
- comes on after the engine was started or while driving

For your safety, we strongly recommend that you contact an authorized Mercedes-Benz Center immediately to have the system checked. Otherwise the SRS may not be activated when needed in an accident, which could result in serious or fatal injury. The SRS might also deploy unexpectedly and unnecessarily which could also result in injury as well.

In addition, improper work on the SRS creates a risk of rendering the SRS inoperative or causing unintended air bag deployment. Work on the SRS must therefore only be performed by qualified technicians. Contact an authorized Mercedes-Benz Center.

If it is necessary to modify an air bag system to accommodate a person with disabilities, contact an authorized Mercedes-Benz Center. USA only: Call our Customer Assistance Center at 1-800-FOR-MERCEdes (1-800-367-6372) for details.

**Air bags** **Warning!**

Air bags are designed to reduce the potential of injury and fatality in certain

- frontal impacts (front air bags)
- side impacts (side impact air bags and window curtain air bags)
- rollovers (window curtain air bags)

However, no system available today can completely eliminate injuries and fatalities.

Deployment of the air bags temporarily releases a small amount of dust from the air bags. This dust, however, is neither harmful to your health, nor does it indicate a fire in the vehicle. The dust might cause some temporary breathing difficulty for people with asthma or other breathing trouble. To avoid this, you may wish to get out of the vehicle as soon as it is safe to do so. If you have any breathing difficulty but cannot get out of the vehicle after the air bag inflates, then get fresh air by opening a window or door.

 **Warning!**

To reduce the risk of injury when the front air bags inflate, it is very important for the driver and front passenger to always be in a properly seated position and to wear their respective seat belt.

For maximum protection in the event of a collision always be in normal seated position with your back against the seat backrest. Fasten your seat belt and make sure it is properly positioned on your body.

Since the air bag inflates with considerable speed and force, a proper seating position and correct positioning of the hands on the steering wheel will help to keep you at a safe distance from the air bag. Occupants who are not wearing their seat belt, are not seated properly or are too close to the air bag can be seriously injured or killed by an air bag as it inflates with great force instantaneously:

- Sit with the seat belt properly fastened in a position that is as upright as possible with your back against the seat backrest.
- Move the driver's seat as far back as possible, still permitting proper operation of vehicle controls. The distance from the center of the driver's chest to the center of the air bag cover on the steering wheel must be at least 10 inches (25 cm) or more. You should be able to accomplish this by adjusting the seat and steering wheel. If

you have any difficulties, please contact an authorized Mercedes-Benz Center.

- Do not lean your head or chest close to the steering wheel or dashboard.
- Keep hands on the outside of the steering wheel rim. Placing hands and arms inside the rim can increase the risk and potential severity of hand/arm injury when the driver front air bag inflates.
- Adjust the front passenger seat as far as possible rearward from the dashboard when the seat is occupied.
- Occupants, especially children, should never place their bodies or lean their heads in the area of the door where the side impact air bag inflates. This could result in serious injuries or death should the side impact air bag be deployed. Always sit as upright as possible, wear the seat belt properly and use an appropriately sized infant restraint, toddler restraint, or booster seat recommended for the size and weight of the child.

Failure to follow these instructions can result in severe injuries to you or other occupants.

If you sell your vehicle, it is important that you make the buyer aware of this safety information. Be sure to give the buyer this Operator's Manual.

### **Warning!**

Accident research shows that the safest place for children in an automobile is in a rear seat. There is a possibility for a side impact air bag-related injury if occupants, especially children, are not properly seated or restrained when next to a side impact air bag which needs to deploy rapidly in a side impact in order to do its job.

To help avoid the possibility of injury, please follow these guidelines:

- (1) Occupants, especially children, should never place their bodies or lean their heads in the area of the

door where the side impact air bag inflates. This could result in serious injuries or death should the side impact air bag be deployed.

- (2) Always sit as upright as possible, wear the seat belt properly and use an appropriately sized infant restraint, toddler restraint, or booster seat recommended for the size and weight of the child. and for children 12 years old and under, use an appropriately sized infant restraint, toddler restraint, or booster seat recommended for the size and weight of the child.
- (3) Always wear seat belts properly.

If you believe that, even with the use of these guidelines, it would be safer for your rear seat occupants to have the rear mounted side impact air bags deactivated, then deactivation can be carried out upon your written request at an authorized Mercedes-Benz Center at an additional cost.

Please contact an authorized Mercedes-Benz Center or call the Customer Assistance Center (in the USA) at 1-800-FOR-MERCEdes (1-800-367-6372), or Customer Service (in Canada) at 1-800-387-0100 for details.

Air bags are designed to deploy only in certain

- frontal impacts (front air bags)
- side impacts (side impact and window curtain air bags) if the system determines the need for air bag deployment
- rollovers (window curtain air bags)

Only in the event of such a situation will they provide their supplemental protection.

The driver and passengers should always wear their seat belts. Otherwise it is not possible for the air bags to provide their supplemental protection.

In case of other types of impacts and impacts below air bag deployment thresholds, air bags will not deploy. The driver and



passengers will then be protected to the extent possible by a properly fastened seat belt. A properly fastened seat belt is also needed to provide the best possible protection in a rollover.

Air bags are not a substitute for seat belts. Always wear your seat belt, regardless of whether or not your vehicle is equipped with air bags.

It is important to your safety and that of your passengers to have deployed air bags replaced and to have any malfunctioning air bags repaired. This will help to make sure the air bags will continue to provide supplemental crash protection for occupants.

### Safety guidelines for the seat belt, Emergency Tensioning Device (ETD) and air bag

#### Warning!

- Damaged seat belts or seat belts that have been subjected to stress in an accident must be replaced. Their anchoring points must also be checked. Only use seat belts installed or supplied by an authorized Mercedes-Benz Center.
- Air bags and pyrotechnic Emergency Tensioning Devices (ETDs) contain perchlorate material, which may require special handling and regard for the environment. Check with your local government's disposal guidelines. California residents, see [www.dtsc.ca.gov/HazardousWaste/Perchlorate/index.cfm](http://www.dtsc.ca.gov/HazardousWaste/Perchlorate/index.cfm).
- Air bags and ETDs are designed to function on a one-time-only basis. An air bag or ETD that has deployed must be replaced. PRE-SAFE® has electrically operated reversible pre-tensioners in addition to the pyrotechnic ETDs.
- Do not pass seat belts over sharp edges. They could tear.
- Do not make any modification that could change the effectiveness of the seat belts.
- Do not bleach or dye seat belts as this may severely weaken them. In a crash they may not be able to provide adequate protection.
- No modifications of any kind may be made to any components or wiring of the SRS.
- Do not change or remove any component or part of the SRS.
- Do not install additional trim material, seat covers, badges, etc. over the steering wheel hub, front passenger front air bag cover, outboard sides of the seat backrests, door trim panels, or door frame trims.
- Do not install additional electrical/ electronic equipment on or near SRS components and wiring.
- Keep area between air bags and occupants free of objects (e.g. packages, purses, umbrellas, etc.).
- Do not hang items such as coat hangers from the coat hooks or handles over the door. These items may be thrown around in the vehicle and cause head and other injuries when the window curtain air bag is deployed.
- Air bag system components will be hot after an air bag has inflated. Do not touch them.
- Never place your feet on the instrument panel, dashboard, or on the seat. Always keep both feet on the floor in front of the seat.
- Improper repair work on the SRS creates a risk of rendering the SRS inoperative or causing unintended air bag deployment. Work on the SRS must therefore only be performed by qualified technicians. Contact an authorized Mercedes-Benz Center.
- For your protection and the protection of others, when scrapping the air bag unit or ETD, our safety instructions must be

followed. These instructions are available from any authorized Mercedes-Benz Center.

- Given the considerable deployment speed, required inflation volume, and the material of the air bags, there is the possibility of abrasions or other, potentially more serious injuries resulting from air bag deployment.

If you sell your vehicle, we strongly recommend that you inform the subsequent owner that the vehicle is equipped with SRS. Also refer them to the applicable section in the Operator's Manual.

### Front air bags

 **Observe Safety notes, see page 41.**



Driver's front air bag ① and front passenger front air bag ② are designed to provide increased protection for the driver and front passenger against the risk of injuries to the head and thorax.

Driver and front passenger front air bags are deployed

- in the event of certain frontal impacts
- if the system determines that air bag deployment can offer additional protection to that provided by the seat belt
- depending on whether the respective seat belt is in use
- independently of the side impact air bags and/or the window curtain air bags

The front air bags in this vehicle have been designed to inflate in two stages. This allows the air bags to have different rates of inflation. The rate of inflation is based on the vehicle deceleration rate as assessed by the air bag control unit.

The front passenger front air bag deployment is additionally influenced by the passenger's weight category as identified by the Occupant Classification System (OCS) (▷ page 46).

The lighter the front passenger-side occupant, the higher the vehicle deceleration rate required for second stage inflation of the front passenger front air bag.

The air bags will not deploy in impacts which do not exceed the system's preset deployment thresholds. You will then be protected by the fastened seat belts.

The front air bags will not deploy in the event of a rollover unless the vehicle's rate of longitudinal deceleration or acceleration exceeds the preset deployment threshold for the front air bags.

The front passenger front air bag will only be deployed if

- the system, based on OCS weight sensor readings, detects that the front passenger seat is occupied
- the  **PASS AIR BAG OFF** indicator lamp in the center console is not lit (▷ page 46)
- the impact exceeds a preset deployment threshold

## Side impact air bags

 **Observe Safety notes, see page 41.**

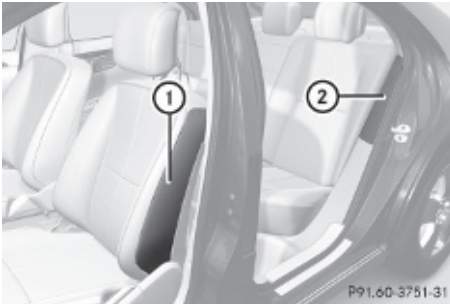

Front side impact air bags ① and rear side impact air bags ② are designed to provide increased protection for the thorax but not the head, neck and arms.

The side impact air bags are deployed

- on the impacted side of the vehicle
- in instances with a high rate of lateral vehicle deceleration or acceleration
- regardless of whether the seat belts on the impacted side of the vehicle are in use
- independently of the front air bags
- independently of the ETDs

The front passenger side impact air bag will not deploy if the OCS senses that the front passenger seat is empty and the front passenger seat belt is not fastened. With the front passenger seat empty and the seat belt fastened, the front passenger side impact air bag will deploy independently of the empty seat. Whether a seat belt is recognized as fastened depends on whether or not the latch plate is properly inserted into the buckle.

The side impact air bags are not deployed in side impacts which do not exceed the system's deployment threshold.

The side impact air bags will not deploy in the event of a rollover unless the vehicle's rate of lateral deceleration or acceleration exceeds the preset deployment threshold for the side impact air bags.

### **Warning!**

Only use seat covers which have been tested and approved by Mercedes-Benz for your vehicle model. Using other seat covers may interfere with or prevent the deployment of the side impact air bags. Contact an authorized Mercedes-Benz Center for availability.

## Window curtain air bags

 **Observe Safety notes, see page 41.**

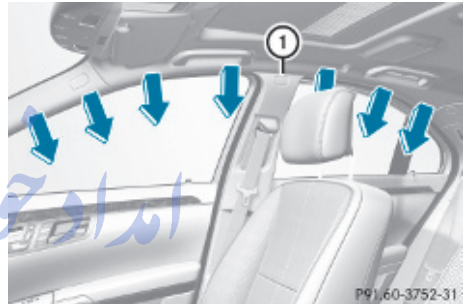

Window curtain air bags ① are designed to provide increased protection for the head but not the chest or arms.

Window curtain air bags ① are deployed

- on the impacted side of the vehicle
- in instances with a high rate of lateral vehicle deceleration or acceleration
- independently of the front air bags
- regardless of whether the front passenger seat is occupied
- regardless of whether the seat belt on the impacted side of the vehicle is in use
- in certain vehicle rollovers, if the system determines that air bag deployment can offer additional protection to that provided by the seat belt

Window curtain air bags ① are not deployed in impacts which do not exceed the system's deployment threshold.

Window curtain air bags ① deploy in the area indicated by the arrows.

## Occupant Classification System

The Occupant Classification System (OCS) activates or deactivates the front passenger front air bag automatically. The respective status is based on the classified occupant weight category determined by weight sensor readings from the front passenger seat.

The system does not deactivate

- the front passenger side impact air bag
- the window curtain air bag
- the Emergency Tensioning Devices (ETDs)

To be classified correctly, the front passenger must sit

- with the seat belt properly fastened
- in a position that is as upright as possible with the back against the seat backrest
- with the feet on the floor



If the occupant's weight is transferred to another object in the vehicle (e.g. by leaning on armrests), the OCS may not be able to properly approximate the occupant's weight category.

If your seat, including the trim cover and cushion, needs to be serviced in any way, take the vehicle to an authorized Mercedes-Benz Center.

Only seat accessories approved by Mercedes-Benz may be used.

Both the driver and the front passenger should always use the  **PASS AIR BAG OFF** indicator lamp as an indication of whether or not the front passenger is properly positioned.

### Warning!



If the  **PASS AIR BAG OFF** indicator lamp illuminates when an adult or someone larger than a small individual is in the front passenger seat, have the front passenger reposition himself or herself in the seat until the  **PASS AIR BAG OFF** indicator lamp goes out.

In the event of a collision, the air bag control unit will not allow front passenger front air bag deployment when the OCS has classified the front passenger seat occupant as weighting as much as or less than a typical 12-month-old child in a standard child restraint or if the front passenger seat is classified as being empty.

When the OCS senses that the front passenger seat occupant is classified as being up to or less than the weight of a typical 12-month-old child in a standard child restraint, the  **PASS AIR BAG OFF** indicator lamp will illuminate when the engine is started and remain illuminated, indicating that the front passenger front air bag is deactivated.

When the OCS senses that the front passenger seat is classified as being empty, the  **PASS AIR BAG OFF** indicator lamp will illuminate when the engine is started and remain illuminated, indicating that the front passenger front air bag is deactivated.

When the OCS senses that the front passenger seat occupant is classified as being heavier than the weight of a typical 12-month-old child seated in a standard child restraint or as being a small individual (such as a young teenager or a small adult), the  **PASS AIR BAG OFF** indicator lamp will illuminate for approximately 6 seconds when the engine is started and then, depending on occupant weight sensor readings from the seat, remain illuminated or go out. With the

 **PASS AIR BAG OFF** indicator lamp illuminated, the front passenger front air bag is deactivated. With the  **PASS AIR BAG OFF** indicator lamp out, the front passenger front air bag is activated.

When the OCS senses that the front passenger seat occupant is classified as an adult or someone larger than a small individual, the  **PASS AIR BAG OFF** indicator lamp will illuminate for approximately 6 seconds when the engine is started and then goes out, indicating that the front passenger front air bag is activated.

If the  **PASS AIR BAG OFF** indicator lamp is illuminated, the front passenger front air bag is deactivated and will not be deployed.

If the  **PASS AIR BAG OFF** indicator lamp is not illuminated, the front passenger front air bag is activated and will be deployed

- in the event of certain frontal impacts
- if impact exceeds a preset deployment threshold
- independently of the side impact air bags

If the front passenger front air bag is deployed, the rate of inflation will be influenced by

- the rate of relevant vehicle deceleration as assessed by the air bag control unit
- the front passenger's weight category as identified by the OCS

For more information on air bag display messages in the multifunction display, see (> page 455).

### **Warning!**

According to accident statistics, children are safer when properly restrained in the rear seating positions than in the front seating position. Thus, we strongly recommend that children be placed in the rear seats whenever possible. Regardless of seating position, children 12 years old and under must be seated and properly secured in an appropriate infant restraint, toddler restraint, or booster seat recommended for the size and weight of the child.

The infant or child restraint must be properly secured with the vehicle's seat belt, the seat belt and top tether strap, or lower anchors and top tether strap, fully in accordance with the child seat manufacturer's instructions.

Occupants, especially children, should always sit as upright as possible, wear the seat belt properly and use an appropriately sized infant restraint, toddler restraint, or booster seat

recommended for the size and weight of the child.

Children can be killed or seriously injured by an inflating air bag. Note the following important information when circumstances require you to place a child in the front passenger seat:

- Your vehicle is equipped with air bag technology designed to deactivate the front passenger front air bag in your vehicle when the system senses the weight of a typical 12-month-old child or less along with the weight of a standard appropriate child restraint on the front passenger seat.
- A child in a rear-facing child restraint on the front passenger seat will be seriously injured or even killed if the front passenger front air bag inflates in a collision which could occur under some circumstances, even with the air bag technology installed in your vehicle. The only means to completely eliminate this risk is to never place a child in a rear-facing child restraint in the front seat. We therefore strongly recommend that you always place a child in a rear-facing child restraint in a backseat.

If you must install a rear-facing child restraint on the front passenger seat because circumstances require you to do so, make sure the  **PASS AIR BAG OFF**

indicator lamp is illuminated, indicating that the front passenger front air bag is deactivated. Should the  **PASS AIR BAG OFF**

indicator lamp not illuminate or go out while the restraint is installed, please check installation. Periodically check the

 **PASS AIR BAG OFF** indicator lamp while

driving to make sure the  **PASS AIR BAG OFF**

indicator lamp is illuminated. If the

 **PASS AIR BAG OFF** indicator lamp goes out or

remains out, do not transport a child on the front passenger seat until the system has been repaired.

A child in a rear-facing child restraint on the front passenger seat will be seriously

injured or even killed if the front passenger front air bag inflates.

- If you have to place a child in a forward-facing child restraint on the front passenger seat, move the seat as far back as possible, use the proper child restraint recommended for the age, size and weight of the child, and secure child restraint with the vehicle's seat belt according to the child seat manufacturer's instructions. For children larger than the typical 12-month-old child, the front passenger front air bag may or may not be activated.

Deployment of the driver front air bag does not mean that the front passenger front air bag also should have deployed.

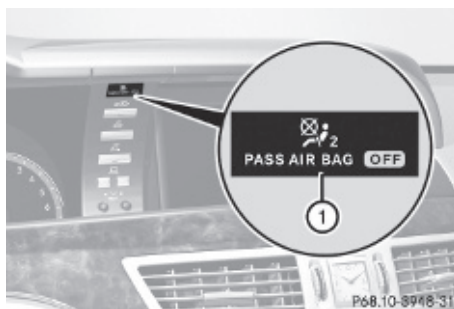

The OCS may have determined

- that the seat was empty or occupied by the weight up to or less than that of a typical 12-month-old child seated in a standard child restraint – both of which are instances where the system suppresses deployment of the front passenger front air bag even though the impact met the criteria and was of sufficient severity to deploy the driver front air bag
- that the seat was occupied by a small individual (such as a young teenager or a small adult) or a child who weighs more than the weight of a typical 12-month-old child in a standard child restraint – both of which are instances where the system may suppress deployment of the front passenger front air bag even though the impact met the criteria and was of sufficient severity to deploy the driver front air bag



 **PASS AIR BAG OFF** indicator lamp ① will be illuminated, except with the SmartKey removed from the starter switch or with the starter switch in position **0**.

### **Warning!**

If the red SRS indicator lamp  in the instrument cluster and the  **PASS AIR BAG OFF** indicator lamp are lit at the same time, there is a malfunction in the OCS. The front passenger front air bag will be deactivated in this case. Have the system checked by qualified technicians as soon as possible. Contact an authorized Mercedes-Benz Center.



Only have the seat repaired or replaced at an authorized Mercedes-Benz Center.

In order to ensure proper operation of the air bag system and OCS:

- Sit with the seat belt properly fastened in a position that is as upright as possible with your back against the seat backrest.
- While seated, an occupant should not position him/herself in such a way as to cause the occupant's weight to be lifted from the seat bottom as this may result in the OCS being unable to correctly approximate the occupant's weight category.
- Read and observe all warnings in this chapter.



## OCS Self-test

After turning the SmartKey in the starter switch to position **1** or **2** or pressing the KEYLESS-GO start/stop button once or twice, the  **PASS AIR BAG OFF** indicator lamp illuminates. If an adult occupant is properly sitting on the front passenger seat and the system classifies the occupant as an adult, the  **PASS AIR BAG OFF** indicator lamp will illuminate and go out after approximately 6 seconds.

If the seat is not occupied and the system classifies the front passenger seat as being empty, the  **PASS AIR BAG OFF** indicator lamp will illuminate and not go out.

### **Warning!**

If the  **PASS AIR BAG OFF** indicator lamp does not illuminate, the system is not functioning. You must contact an authorized Mercedes-Benz Center before seating any child on the front passenger seat.

For more information, see the “Practical hints” section (▷ page 498).

### **Warning!**

Never place anything between seat cushion and child seat (e.g. pillow), since it reduces the effectiveness of the OCS. The bottom and back of the child seat must make full contact with the passenger seat cushion and backrest.

If necessary, adjust the tilt of the passenger seat backrest.

An incorrectly mounted child seat could cause injuries to the child in case of an accident, instead of increasing protection for the child.

Follow the manufacturer’s instructions for installation of child seats.

## Seat belts

### Safety notes

The use of seat belts and infant and child restraint systems is required by law in all 50 states, the District of Columbia, the U.S. territories and all Canadian provinces.

Even where this is not the case, all vehicle occupants should have their seat belts fastened whenever the vehicle is in motion.

-  See “Children in the vehicle” (▷ page 56) for information on
  - infants and children traveling with you in the vehicle
  - restraint systems for infants and children

### **Warning!**

Always fasten your seat belt before driving off. Always make sure all of your passengers are properly restrained. You and your passengers should always wear seat belts.

Failure to wear and properly fasten and position your seat belt greatly increases your risk of injuries and their likely severity in an accident.

If you are ever in an accident, your injuries can be considerably more severe without your seat belt properly buckled. Without your seat belt buckled, you are much more likely to hit the interior of the vehicle or be ejected from it. You can be seriously injured or killed.

In the same crash, the possibility of injury or death is lessened if you are properly wearing your seat belt. The air bags can only protect as intended if the occupants are properly wearing their seat belts.

### **Warning!**

Never ride in a moving vehicle with the seat backrest in an excessively reclined position as this can be dangerous. You could slide under the seat belt in a collision. If you slide under it, the seat belt would apply force at the abdomen or neck. That could cause serious or even fatal injuries. The seat backrest and

seat belt provide the best restraint when the wearer is in a position that is as upright as possible and the seat belt is properly positioned on the body.

#### **Warning!**

Never let more people ride in the vehicle than there are seat belts available. Make sure everyone riding in the vehicle is correctly restrained with a separate seat belt. Never use a seat belt for more than one person at a time.

#### **Warning!**

Damaged seat belts or seat belts that have been subjected to stress in an accident must be replaced. Also, the seat belt anchoring points must be checked.

Only use seat belts which have been approved by Mercedes-Benz.

Do not make any modifications to the seat belts. This can lead to unintended activation of the ETDs or to their failure to activate when necessary.

Do not bleach or dye seat belts as this may severely weaken them. In a crash they may not be able to provide adequate protection.

Have all work carried out only by qualified technicians. Contact an authorized Mercedes-Benz Center.

### Proper use of seat belts

#### **Warning!**

USE SEAT BELTS PROPERLY

- Seat belts can only protect when used properly. Never wear seat belts in any other way than as described in this section, as that could result in serious injuries in case of an accident.
- Each occupant should wear their seat belt at all times, because seat belts help reduce the likelihood of and potential severity of injuries in accidents, including rollovers. The integrated restraint system includes

SRS (driver front air bag, front passenger front air bag, side impact air bags, window curtain air bags for door windows), Emergency Tensioning Devices (ETDs), seat belt force limiters, and front seat knee bolsters.

The system is designed to enhance the protection offered to properly belted occupants in certain frontal (front air bags and ETDs) and side (side impact air bags, window curtain air bags, and ETDs) impacts which exceed preset deployment thresholds and in certain rollovers (window curtain air bags and ETDs).

- Never wear the shoulder belt under your arm, against your neck or off your shoulder. In a frontal crash, your body would move too far forward. That would increase the chance of head and neck injuries. The seat belt would also apply too much force to the ribs or abdomen, which could severely injure internal organs such as your liver or spleen.
- Adjust the seat belt so that the shoulder section is located as close as possible to the middle of the shoulder. It should not touch the neck. Never pass the shoulder portion of the seat belt under your arm. For this purpose, you can adjust the height of the seat belt outlet.
- Position the lap belt as low as possible on your hips and not across the abdomen. If the lap belt is positioned across your abdomen, it could cause serious injuries in a crash.
- Never wear seat belts over rigid or breakable objects in or on your clothing, such as eyeglasses, pens, keys etc., as these might cause injuries.
- Make sure the seat belt is always fitted snugly. Take special care of this when wearing loose clothing.
- Never use a seat belt for more than one person at a time. Do not fasten a seat belt



around a person and another person or other objects at the same time.

- Seat belts should not be worn twisted. In a crash, you would not have the full width of the seat belt to distribute impact forces. The twisted seat belt against your body could cause injuries.
- Pregnant women should also always use a lap/shoulder belt. The lap belt portion should be positioned as low as possible on the hips to avoid any possible pressure on the abdomen.
- Place the seat backrest in a position that is as upright as possible.
- Check your seat belt during travel to make sure it is properly positioned.
- Never place your feet on the instrument panel, dashboard, or on the seat. Always keep both feet on the floor in front of the seat.
- When using a seat belt to secure infant restraints, toddler restraints, or children in booster seats, always follow the child seat manufacturer's instructions.

#### **Warning!**

Do not pass seat belts over sharp edges. They could tear.

Do not allow the seat belt to get caught in the door or in the seat adjustment mechanism. This could damage the seat belt.

Never attempt to make modifications to seat belts. This could impair the effectiveness of the seat belts.

### Fastening the seat belts

#### **Warning!**

According to accident statistics, children are safer when properly restrained in the rear seating positions than in the front seating position. Thus, we strongly recommend that children be placed in the rear seats whenever possible. Regardless of seating position,

children 12 years old and under must be seated and properly secured in an appropriately sized infant restraint, toddler restraint, or booster seat recommended for the size and weight of the child. For additional information, see "Children in the vehicle". A child's risk of serious or fatal injuries is significantly increased if the child restraints are not properly secured in the vehicle and/or the child is not properly secured in the child restraint.

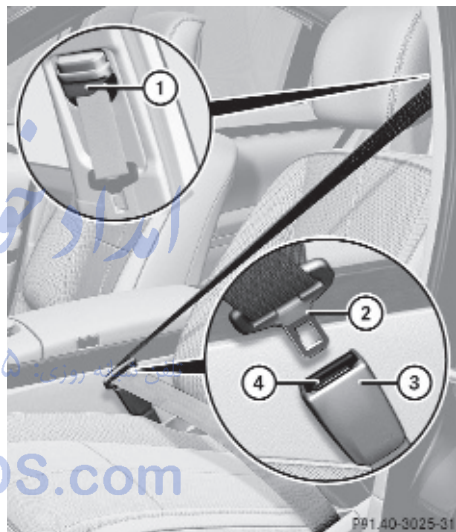

- ▶ With a smooth motion, pull the seat belt out of seat belt outlet ①.
- ▶ Place the shoulder portion of the seat belt across the top of your shoulder and the lap portion across your hips.
- ▶ Push latch plate ② into buckle ③ until it clicks.  
Seat belt adjustment function: The seat belts on both front seats adjust to the upper body automatically as necessary (▷ page 52).
- ▶ If necessary, adjust the seat belt to the correct height (▷ page 52).
- ▶ If necessary, tighten the lap portion to a snug fit by pulling shoulder portion up.

All lap/shoulder belts except the driver's seat belt have special seat belt retractors to secure child restraints properly. For more information on special seat belt retractors, see "Infant and child restraint systems" (▷ page 57).

To release the seat belt with seat belt release button ④, see (▷ page 52).

### Seat belt outlet height adjustment

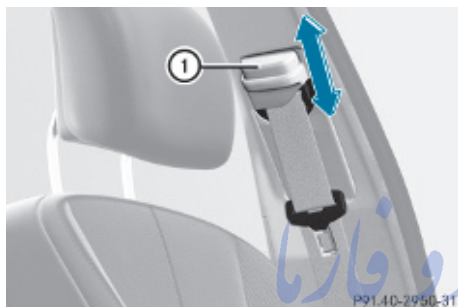

- ▶ **Raising:** Slide the seat belt outlet height adjuster upward. The seat belt outlet height adjuster engages in different positions.
- ▶ **Lowering:** Press and hold release button ①.
- ▶ Slide the seat belt outlet height adjuster downward.
- ▶ Release release button ① and make sure the seat belt outlet height adjuster engages into place.

The seat belts for the rear outer seats are adjusted automatically.

### Seat belt adjustment function

Depending on vehicle production date, your vehicle may be equipped with this function.

The seat belt adjustment function adjusts the seat belts on both front seats to the upper body of the respective vehicle occupant. The seat belt will be pulled slightly tighter for that purpose when

- you engage the latch plate into the buckle and then turn the SmartKey in the starter switch to position **2**
- the SmartKey in the starter switch is in position **2** and you then engage the latch plate in the buckle

The seat belt adjustment function takes place with a certain amount of retracting force when the system senses slack between the vehicle occupant and the seat belt. Do not retain the seat belt during this procedure. You can activate or deactivate the seat belt adjustment function via the control system (▷ page 236).

### Releasing the seat belts



- ▶ Press seat belt release button ④ (▷ page 51). Allow the retractor to completely rewind the seat belt by guiding latch plate ② (▷ page 51).
- ⚠ Make sure the seat belt retracts completely. Otherwise the seat belt and/or latch plate could get caught or pinched in the door or in the seat mechanism. This can damage the seat belt and impair its effectiveness, and/or cause damage to the door and/or door trim panel. Such damage is not covered by the Mercedes-Benz Limited Warranty. Damaged seat belts must be replaced. Contact an authorized Mercedes-Benz Center.

### Enhanced seat belt reminder system

When the engine is started, the seat belt telltale  will always illuminate for 6 seconds to remind you and your passengers to fasten your seat belts.

If the driver's seat belt is not fastened when the engine is started, an additional warning chime will sound. The warning chime goes out after approximately 6 seconds or once the driver's seat belt is fastened.

If after these 6 seconds the driver's or the front passenger's seat belt (with the front passenger seat occupied) is not fastened with front doors closed,

- the seat belt telltale  remains illuminated for as long as either the driver's or front passenger's seat belt is not fastened.
- and if the vehicle speed once exceeds 15 mph (25 km/h), the seat belt telltale  starts flashing and a warning chime sounds with increasing intensity for a maximum of 60 seconds or until the driver's and front passenger's seat belt are fastened.

If you and/or your passenger release the seat belt during driving, the seat belt telltale  starts flashing and the warning chime sounds as described before.

If the driver's or the front passenger's seat belt remains unfastened after 60 seconds, the warning chime stops sounding, the seat belt telltale  stops flashing but continues to be illuminated.

After a vehicle standstill, the warning chime is reactivated and the seat belt telltale  is flashing again if the vehicle speed once exceeds 15 mph (25 km/h).

The seat belt telltale  will only go out if both the driver's and the front passenger's seat belt (with the front passenger seat occupied) are fastened, or the vehicle is standing still and a front door is opened. For more information, see "Practical hints" (> page 493).

## Emergency Tensioning Device (ETD), seat belt force limiter

The seat belts for the front seats and rear outer seats are equipped with ETDs and seat belt force limiters.

The ETDs are designed to activate in the following cases:

- in frontal or rear-end impacts exceeding the system's preset deployment threshold
- in side impacts exceeding the system's preset deployment threshold on the far side of the impact
- in certain vehicle rollovers
- if the restraint systems are operational and functioning correctly, see "SRS indicator lamp" (> page 40)

The ETDs for the front seats will only activate if the front seat belts are fastened (latch plate properly inserted into buckle).

The ETDs for the rear outer seats will activate with or without the respective seat belts fastened.

In an impact, the ETDs remove slack from the seat belts in such a way that the seat belts fit more snugly against the body. Seat belt force limiters, when activated, are employed to help reduce the peak force exerted by the seat belts on occupants during a crash.

- ❗ The ETDs do not correct an incorrect seat position or incorrectly worn seat belts. The ETDs do not pull occupants back toward the seat backrest.

### Warning!

Pyrotechnic ETDs that were activated must be replaced.

For your safety, when disposing of the pyrotechnic ETDs always follow our safety instructions. These are available at any authorized Mercedes-Benz Center.

The PRE-SAFE® system has electrically operated reversible pre-tensioners that do not require replacement after activation.

### Automatic comfort-fit feature seat belt

The automatic comfort-fit feature reduces the retracting force of the seat belts when they are in normal use. It is available for the front seats and for the rear outer seats (only for vehicles with rear power seats).

#### Preventive occupant safety (PRE-SAFE®)

##### Warning!

The PRE-SAFE® system is intended to reduce the effects of an accident on vehicle occupants who are wearing their seat belt properly. Despite your vehicle being equipped with the PRE-SAFE® system, the possibility of personal injuries occurring as a result of an accident cannot be eliminated. Therefore, always drive carefully and adjust your driving to the prevailing road, weather, and traffic conditions.

The PRE-SAFE® system takes preventive measures to better protect the occupants from the possibility of personal injuries in the following hazardous situations:

- emergency braking situations, e.g. if the Brake Assist System (BAS) (▷ page 64) is activated or when vehicles with DISTRONIC PLUS: the BAS PLUS (▷ page 64) or the PRE-SAFE® Brake (▷ page 69) is strongly engaging
- when the radar sensors recognize the immediate risk of collision in certain situations (vehicles with DISTRONIC PLUS)
- critical dynamic driving situations, e.g. when the vehicle has been caused to understeer or oversteer because it has exceeded its physical limitations or in case of evasive steering maneuvers at speeds above approximately 85 mph (140 km/h)

The PRE-SAFE® system takes the following measures when it is activated:

- The front seat belts are pre-tensioned automatically.
- If the front passenger seat is in an unfavorable position, the seat will be adjusted to a position that seeks to better protect the occupant.
- If a rear outer power seat (if so equipped) is in an unfavorable position, the seat will be adjusted to a position that seeks to better protect the occupant.
- The system increases the air pressure in the air pockets (on the sides of the seat cushion and backrest) of the multicontour and/or drive-dynamic multicontour front seats.
- If the vehicle is equipped with multicontour rear seats, the system increases the air pressure in the air pockets (on the sides of the seat backrest) of the multicontour rear outer seats.
- If the vehicle is in a critical dynamic driving situation, the door windows and the tilt/sliding sunroof or panorama roof with tilt/sliding panel also closes, except for a minimal gap that remains open.

If the closing procedure of any of these elements is blocked, it will stop and open slightly.

Once the hazardous situation no longer exists and an accident has been avoided, the PRE-SAFE® system loosens the seat belt pre-tension and decreases the air pressure in the air pockets of the multicontour and/or drive-dynamic multicontour seats. All of the PRE-SAFE® system settings can be re-adjusted following the critical driving event.

If the seat belts do not release:

- ▶ Adjust the seat backrest to the rear until the seat belt tension is reduced. The locking mechanism releases.

**!** When adjusting the seat backrests, make sure there are no items behind the seats. Otherwise, you could damage the seats and/or the items.

For information on the seat belt adjustment function as an integrated comfort feature of the PRE-SAFE® system, see (▷ page 52).

### NECK-PRO active front head restraints

The NECK-PRO active front head restraints are intended to offer the driver and front passenger increased protection from whiplash-type injuries. In the event of a rear-end collision, the NECK-PRO active front head restraints on the front seats are designed to move forward in the direction of travel. They thus provide the head with increased support earlier on in the collision sequence. The NECK-PRO active front head restraints will move forward whether the seats are occupied or not.

#### Warning!

Do not attach any objects (e.g. hangers) to the head restraint posts. Otherwise, the NECK-PRO active front head restraints may not be able to function properly or offer the intended degree of protection they were designed for in the event of a rear-end collision.

#### Warning!

Only use seat or head restraint covers which have been tested and approved by Mercedes-Benz for your vehicle model.

Using other seat or head restraint covers may interfere with or prevent the activation of the NECK-PRO active front head restraints and/or the deployment of the front side impact air bags.

Contact an authorized Mercedes-Benz Center for availability.

When the NECK-PRO active front head restraints have been triggered in an accident, the NECK-PRO active front head restraints

must be reset. Otherwise, the NECK-PRO active front head restraints cannot offer any additional protection in the event of another rear-end collision.

For information on resetting the activated NECK-PRO active front head restraints, see “Resetting activated head restraints” (▷ page 501).

You cannot remove the NECK-PRO active front head restraints.

#### Warning!

For your protection, drive only with properly positioned head restraints.

Adjust the head restraint so that it is as close to the head as possible and the center of the head restraint supports the back of the head at eye level. This will reduce the potential for injury to the head and neck in the event of an accident or similar situation.

For information on head restraint adjustment, see “Head restraint height” (▷ page 287), or see “Head restraint fore and aft adjustment” (▷ page 289).

### Correct driver seat adjustment

#### Warning!

In order to avoid possible loss of vehicle control the following must be done before the vehicle is put into motion:

- seat adjustment
- head restraint adjustment
- steering wheel adjustment
- rear view mirror adjustment
- fastening of seat belts



### Steering wheel

**⚠ Observe Safety notes, see page 293.**

- Position steering wheel ① properly (▷ page 294).

Make sure:

- You can reach the steering wheel with your arms slightly bent at the elbows.
- You can move your legs freely.
- All displays (including malfunction and indicator lamps) on the instrument cluster are clearly visible.

### Seat belt

**⚠ Observe Safety notes, see page 49.**

- Fasten and position your seat belt ② correctly (▷ page 51).

Make sure:

- The seat belt is always fitted snugly.
- Adjust the seat belt so that the shoulder section is located as close as possible to the middle of the shoulder.
- Place the lap portion of the seat belt as low as possible on your hips.

### Seat and head restraint

**⚠ Observe Safety notes, see page 286.**

- Position seat ③ and head restraint properly. See (▷ page 287) for seat and head restraint adjustment.

Observe the following points:

- Always be in a properly seated position.
- The position should be as far rearward from the front air bag in the steering wheel as possible, while still permitting proper operation of vehicle controls.
- Adjust the seat to a comfortable seating position that still allows you to reach the accelerator/brake pedal safely.
- The seat must be adjusted so that you can correctly fasten and position your seat belt.
- The seat backrest must be in a position that is as nearly upright as possible.
- Adjust the seat cushion so that the front edge of the seat cushion lightly supports your legs.
- Adjust the head restraint so that it is as close to the head as possible and the center of the head restraint supports the back of the head at eye level.
- Never place hands under the seat or near any moving parts while the seat is being adjusted.

### Children in the vehicle

#### Safety notes

If an infant or child is traveling with you in the vehicle:

- Secure the child using an infant or child restraint appropriate to the age and size of the child.
- Make sure the infant or child is properly secured at all times while the vehicle is in motion.



**⚠ Warning!**

When leaving the vehicle, always remove the SmartKey from the starter switch. Always take the SmartKey with you and lock the vehicle. Do not leave children unattended in the vehicle, even if they are secured in a child restraint system, or with access to an unlocked vehicle. A child's unsupervised access to a vehicle could result in an accident and/or serious personal injury. The children could

- injure themselves on parts of the vehicle
- be seriously or fatally injured through excessive exposure to extreme heat or cold
- injure themselves or cause an accident with vehicle equipment that can be operated even if the SmartKey is removed from the starter switch or removed from the vehicle, such as seat adjustment, steering wheel adjustment, or the memory function

If children open a door, they could injure other persons or get out of the vehicle and injure themselves or be injured by following traffic. Do not expose the child restraint system to direct sunlight. The child restraint system's metal parts, for example, could become very hot, and the child could be burned by these parts.

**⚠ Warning!**

Do not carry heavy or hard objects in the passenger compartment unless they are firmly secured in place.

Unsecured or improperly positioned cargo increases a child's risk of injury in the event of

- strong braking maneuvers
- sudden changes of direction
- an accident

**Infant and child restraint systems****⚠ Observe Safety notes, see page 56.**

We recommend all infants and children be properly restrained at all times while the vehicle is in motion.

All lap/shoulder belts except the driver's seat belt have special seat belt retractors for secure fastening of child restraints.

To fasten a child restraint, follow the child restraint manufacturer's instructions for mounting.

To activate the special seat belt retractor:

- ▶ Pull the shoulder belt out completely and let it retract.

During seat belt retraction, a ratcheting sound can be heard to indicate that the special seat belt retractor is activated.

The seat belt is now locked.

- ▶ Push down on child restraint to take up any slack.

To deactivate the special seat belt retractor:

- ▶ Release the seat belt buckle and let the seat belt retract completely.

The seat belt can then again be used in the usual manner.

To deactivate the special seat belt retractor for the front passenger seat, the front passenger seat must be in the most backward position.

**⚠ Warning!**

Never release the seat belt buckle while the vehicle is in motion, since the special seat belt retractor will be deactivated.

- i** Information on child seats with mounting fittings for tether anchorages (▷ page 59).

For information on LATCH-type (ISOFIX) child seat anchors (▷ page 60).

The use of infant or child restraints is required by law in all 50 states, the District of Columbia, the U.S. territories and all Canadian provinces.

Infants and small children should be seated in an appropriate infant or child restraint system. They must be properly secured in accordance with the manufacturer's instructions for the child restraint. All infant or child restraint systems must comply with U.S. Federal Motor Vehicle Safety Standards 213 and 225 and Canadian Motor Vehicle Safety Standards 213 and 210.2.

A statement by the child restraint manufacturer of compliance with these standards can be found on the instruction label on the restraint and in the instruction manual provided with the restraint.

When using any infant restraint, toddler restraint, or booster seat, make sure to carefully read and follow all manufacturer's instructions for installation and use.

Please read and observe warning labels affixed to the inside of the vehicle and to infant or child restraints.

#### **Warning!**





According to accident statistics, children are safer when properly restrained in the rear seating positions than in the front seating position. Thus, we strongly recommend that children be placed in the rear seats whenever possible. Regardless of seating position, children 12 years old and under must be seated and properly secured in an appropriate infant restraint, toddler restraint, or booster seat recommended for the size and weight of the child.

The infant or child restraint must be properly secured with the vehicle's seat belt, the seat belt and top tether strap, or lower anchors and top tether strap, fully in accordance with the child seat manufacturer's instructions.

Occupants, especially children, should always sit as upright as possible, wear the seat belt properly and use an appropriately sized infant restraint, toddler restraint, or booster seat recommended for the size and weight of the child.

Children can be killed or seriously injured by an inflating air bag. Note the following important information when circumstances require you to place a child in the front passenger seat:

- Your vehicle is equipped with air bag technology designed to deactivate the front passenger front air bag in your vehicle when the system senses the weight of a typical 12-month-old child or less along with the weight of a standard appropriate child restraint on the front passenger seat.
- A child in a rear-facing child restraint on the front passenger seat will be seriously injured or even killed if the front passenger front air bag inflates in a collision which could occur under some circumstances, even with the air bag technology installed in your vehicle. The only means to completely eliminate this risk is to never place a child in a rear-facing child restraint in the front seat. We therefore strongly recommend that you always place a child in a rear-facing child restraint in a backseat.
- If you must install a rear-facing child restraint on the front passenger seat because circumstances require you to do so, make sure the  **PASS AIR BAG OFF**

indicator lamp is illuminated, indicating that the front passenger front air bag is deactivated. Should the  **PASS AIR BAG OFF** indicator lamp not illuminate or go out while the restraint is installed, please check installation. Periodically check the  **PASS AIR BAG OFF** indicator lamp while driving to make sure the  **PASS AIR BAG OFF** indicator lamp is illuminated. If the  **PASS AIR BAG OFF** indicator lamp goes out or remains out, do not transport a child on the front passenger seat until the system has been repaired.

A child in a rear-facing child restraint on the front passenger seat will be seriously



injured or even killed if the front passenger front air bag inflates.

- If you have to place a child in a forward-facing child restraint on the front passenger seat, move the seat as far back as possible, use the proper child restraint recommended for the age, size and weight of the child, and secure child restraint with the vehicle's seat belt according to the child seat manufacturer's instructions. For children larger than the typical 12-month-old child, the front passenger front air bag may or may not be activated.

### **Warning!**

Infants and small children should never share a seat belt with another occupant. During an accident, they could be crushed between the occupant and seat belt.

A child's risk of serious or fatal injuries is significantly increased if the child restraints are not properly secured in the vehicle and/or the child is not properly secured in the child restraint.

Children too big for a toddler restraint must ride in seats using regular seat belts. Position shoulder belt across chest and shoulder, not face or neck. A booster seat may be necessary to achieve proper seat belt positioning for children over 41 lb (18 kg) until they reach a height where a lap/shoulder belt fits properly without a booster.

When the child restraint is not in use, remove it from the vehicle or secure it with the seat belt to prevent the child restraint from becoming a projectile in the event of an accident.

## Installation of infant and child restraint systems

### **Observe Safety notes, see page 56.**

This vehicle is equipped with tether anchorages for a top tether strap at each of the rear seating positions.

Top tether straps enable an additional connection to be made between child restraint systems secured with LATCH-type (ISOFIX) anchors and rear seats. This can further reduce the risk of injury.



- ▶ Vehicles with rear power seats: Bring the rear power seat backrest to a fully upright position (> page 287).
- ▶ Remove anchorage ring cover ① from the anchorage ring of the seat on which a child seat is to be installed.
- ▶ Store anchorage ring cover ① in a convenient place (e.g. glove box).

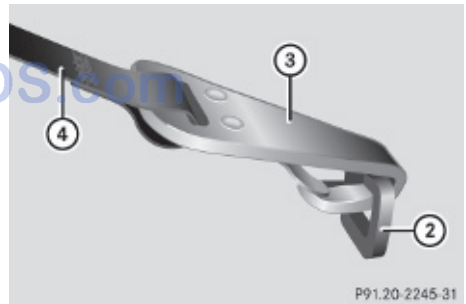

- ▶ Guide top tether strap ④ between the head restraint and top of the seat backrest. The head restraint must be positioned such that top tether strap ④ can pass freely between the head restraint and top of the seat backrest.
- ▶ Make sure top tether strap ④ is not twisted.

- ▶ Securely fasten hook (3), which is part of top tether strap (4), to anchorage ring (2).
- ▶ For safety, make sure hook (3) is attached to anchorage ring (2) beyond the safety catch, as illustrated.

Once hook (3) is attached, the child restraint itself can be secured.

- ▶ Install the child restraint system and tighten top tether strap (4) according to the child restraint manufacturer's instructions.

After removing the child restraint system and top tether strap (4):

- ▶ Reinstall anchorage ring cover (1).

#### **Warning!**

Vehicles with rear power seats:

Never change the rear seat position after installing the child restraint. This could

- damage the child restraint
- introduce undesirable slack or tension into the seat belt
- loosen the child restraint
- misposition the child restraint

All of the above will lessen the effectiveness of the child restraint and thus increase the chance or severity of injury in an accident.

### Child seat anchors – LATCH-type (ISOFIX)

 **Observe Safety notes, see page 56.**

#### **Warning!**

Children too big for a toddler restraint must ride in seats using regular seat belts. Position shoulder belt across chest and shoulder, not face or neck.

A booster seat may be necessary to achieve proper seat belt positioning for children over 41 lb (18 kg) until they reach a height where a lap/shoulder belt fits properly without a booster.

Install child seat according to manufacturer's instructions.

The child seat must be firmly attached to both anchors.

An incorrectly mounted child seat may come loose during an accident which could result in serious injury or death to the child.

Damaged or impact damaged child seats or child seat mounting fittings must be replaced.

Each rear outer seat has two LATCH-type (ISOFIX) anchors for the installation of a LATCH-type (ISOFIX) child seat with matching mounting fittings.

Non-LATCH-type (ISOFIX) child seats may also be used and can be installed using the vehicle's seat belt system. Install child seat according to the manufacturer's instructions.

The LATCH-type (ISOFIX) anchors are covered with upholstery blends.

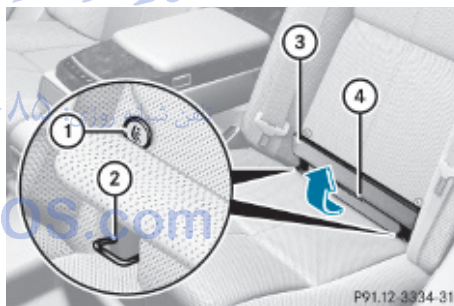

Information sign (1) indicates the position of anchor (2).

- ▶ Bring the rear power seat backrest to a fully upright position (> page 287).
- ▶ Fold upholstery blend (3) upward to access anchors (2).
- ▶ Turn installation device (4) to a vertical position so that upholstery blend (3) does not fold down.
- ▶ Install a LATCH-type (ISOFIX) child seat according to the manufacturer's instructions.

A rigid connection between the child seat and the body of the vehicle is established.

- ▶ Vehicles with rear center seat: Make sure that the seat belt for the rear center seat can operate freely with a child seat installed.

### **Warning!**

Vehicles with rear power seats:

Never change the rear seat position after installing the child restraint. This could

- damage the child restraint
- introduce undesirable slack or tension into the seat belt
- loosen the child restraint
- misposition the child restraint

All of the above will lessen the effectiveness of the child restraint and thus increase the chance or severity of injury in an accident.



- ▶ **Securing:** Press the lever up in direction of arrow ①.
- ▶ Check to make sure the child safety locks are working properly.
- ▶ **Releasing:** Press the lever down in direction of arrow ②.

### **Override switch**

- ▶  **Observe Safety notes, see page 56.**

You can disable select functions in the rear passenger compartment for added safety. This can be useful, for instance, when you have children riding in the rear passenger compartment.

You can disable the following functions:

- rear door window operation
- adjustment of front passenger seat from the rear
- rear center console lighter
- rear roller sunblind for panorama roof
- rear window sunshade and rear door window sunshades

### **Warning!**

Activate the override switch when children are riding in the back seats of the vehicle. The children may otherwise injure themselves, e.g. by becoming trapped in the rear door window opening.

## **Child safety**

### **Child safety locks**

- ▶  **Observe Safety notes, see page 56.**

### **Warning!**

Children could open a rear door from the inside. This may cause serious personal injury or an accident. Therefore, secure the rear doors with the child safety locks whenever children are riding in the back seats of the vehicle.

The child safety locks on the rear doors enable you to secure each rear door individually. You cannot open a secured rear door from the inside. You can open the rear door from the outside when the vehicle is unlocked.

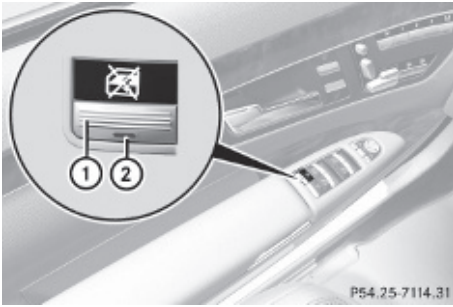

- ▶ **Activating:** Press override switch ①. Indicator lamp ② comes on.

The functions in the rear are disabled.

You can still operate the rear door windows using the switches located on the door control panel of the driver's door.

- ▶ **Deactivating:** Press override switch ① again. Indicator lamp ② goes out.

The functions in the rear are enabled again.

For more information on power windows, see the "Controls in detail" section (> page 307).

- ▶ **Activating:** Press and hold **PANIC** button ① for at least 1 second. An audible alarm and flashing exterior lamps will operate.
  - ▶ **Deactivating:** Press **PANIC** button ① again.
- or
- ▶ Insert the SmartKey into the starter switch.
- or
- ▶ Press the KEYLESS-GO start/stop button. The SmartKey with KEYLESS-GO must be inside the vehicle.

**i** USA only:

This device complies with Part 15 of the FCC Rules. Operation is subject to the following two conditions:

1. This device may not cause harmful interference, and
2. this device must accept any interference received, including interference that may cause undesired operation.

Any unauthorized modification to this device could void the user's authority to operate the equipment.

## Panic alarm



Example illustration: SmartKey with KEYLESS-GO

**i** Canada only:

This device complies with RSS-210 of Industry Canada. Operation is subject to the following two conditions:

1. This device may not cause interference, and
2. this device must accept any interference received, including interference that may cause undesired operation of the device.

Any unauthorized modification to this device could void the user's authority to operate the equipment.

## Driving safety systems

### Introduction

This section contains information about the following driving safety systems:

- ABS (Antilock Brake System)
- Adaptive Brake
- Adaptive Brake Lights
- BAS (Brake Assist System)
- BAS PLUS (Brake Assist System PLUS)
- EBP (Electronic Brake Proportioning)
- ESC (Electronic Stability Control)
- PRE-SAFE® Brake (Preventive Occupant Safety System Brake)

- i** In winter operation, the maximum effectiveness of most of the driving systems described in this section is only achieved with winter tires, or snow chains as required.

### Safety notes

#### **Warning!**

The following factors increase the risk of accidents:

- Excessive speed, especially in turns
- Wet and slippery road surfaces
- Following another vehicle too closely

The driving safety systems described in this section cannot reduce these risks or prevent the natural laws of physics from acting on the vehicle. They cannot increase braking or steering efficiency beyond that afforded by the condition of the vehicle brakes and tires or the traction afforded.

Only a safe, attentive, and skillful driver can prevent accidents.

The capabilities of a vehicle equipped with the driving safety systems described in this section must never be exploited in a reckless

or dangerous manner which could jeopardize the user's safety or the safety of others.

Always adjust your driving style to the prevailing road and weather conditions and keep a safe distance to other road users and objects on the street.

If a driving system malfunctions, other driving safety systems may also switch off. Observe indicator and warning lamps that may come on as well as messages in the multifunction display that may appear.

#### **Warning!**

HYBRID vehicles: It is imperative that you read the HYBRID Supplemental Operating Instructions included in your vehicle literature portfolio. You may otherwise not receive all necessary safety information and warning for the operation of your vehicle.

### ABS

#### **Observe Safety notes, see page 63.**

#### **Warning!**

Do not pump the brake pedal. Use firm, steady brake pedal pressure instead. Pumping the brake pedal defeats the purpose of the ABS and significantly reduces braking effectiveness.

The Antilock Brake System (ABS) regulates the brake pressure so that the wheels do not lock during braking. This allows you to maintain the ability to steer your vehicle.

The ABS is functional above a speed of approximately 5 mph (8 km/h) independent of road surface conditions.

On slippery road surfaces, the ABS will respond even to light brake pressure.

The ABS indicator lamp  in the instrument cluster comes on when you switch on the ignition. It goes out when the engine is running.

## Braking

At the instant one of the wheels is about to lock up, a slight pulsation can be felt in the brake pedal. The pulsation indicates that the ABS is in the regulating mode.

- ▶ Keep firm and steady pressure on the brake pedal while you feel the pulsation.

Continuous, steady brake pedal pressure yields the advantages provided by the ABS, namely braking power and the ability to steer the vehicle.

The pulsating brake pedal can be an indication of hazardous road conditions and functions as a reminder to take extra care while driving.

## Emergency brake maneuver

- ▶ Keep continuous full pressure on the brake pedal.

### Warning!

If the ABS malfunctions, other driving safety systems such as the BAS or the ESC are also switched off. Observe indicator and warning lamps that may come on as well as messages in the multifunction display that may appear.

If the ABS malfunctions, the wheels may lock during hard braking, reducing steering capability and extending the braking distance.

## BAS

### Observe Safety notes, see page 63.

The Brake Assist System (BAS) operates in emergency situations. If you apply the brakes very quickly, the BAS provides full brake boost automatically, thereby potentially reducing the braking distance.

- ▶ Apply continuous full braking pressure until the emergency braking situation is over. The ABS will prevent the wheels from locking.

When you release the brake pedal, the brakes function again as normal. The BAS is then deactivated.

### Warning!

If the BAS malfunctions, the brake system still functions, but without the additional brake boost available that the BAS would normally provide in an emergency braking maneuver. Therefore, the braking distance may increase.

## BAS PLUS

The Brake Assist System PLUS (BAS PLUS) operates in emergency braking situations and uses radar sensors to assess the traffic situation. BAS PLUS assists you in braking at speeds above approximately 20 mph (30 km/h).

When traveling in Canada in a vehicle not registered in Canada, you must switch off the radar sensor system (▷ page 236). Canadian law does not permit the use of the radar sensor system for vehicles from outside of Canada. تلفن شماره روز.

When you switch off the radar system, the following functions are deactivated:

- BAS PLUS
- PRE-SAFE® Brake (▷ page 69)
- DISTRONIC PLUS (▷ page 330)
- Blind Spot Assist (▷ page 359)

### Warning!

BAS PLUS is a convenience system designed to assist the driver during vehicle operation. The responsibility for the vehicle speed and the distance to the vehicle ahead, including most importantly brake operation to assure safe stopping distance, always remains with the driver.

Always pay attention to traffic conditions even while BAS PLUS is switched on. Otherwise, you may not be able to recognize dangerous situations until it is too late and



could cause an accident. Personal or fatal injury to you or others may be the result.

**i** This device has been approved by the FCC as a “Vehicular Radar System”. The radar sensor is intended for use in an automotive radar system only. Removal, tampering, or altering of the device will void any warranties, and is not permitted by the FCC. Do not tamper with, alter, or use in any non-approved way.

Any unauthorized modification to this device could void the user’s authority to operate the equipment.

BAS PLUS detects obstacles that are in your driving path for a sufficient period of time to permit the system to recognize these obstacles. If you approach the detected obstacle quickly, BAS PLUS calculates the level of brake power boost appropriate for the circumstance to supply when the driver applies the brakes.

When you step quickly on the brake pedal in an emergency braking situation, BAS PLUS automatically regulates the brake power boost to a level that is suitable for the traffic situation.

If BAS PLUS requires a particularly high brake power boost, PRE-SAFE® is activated at the same time.

► Keep constant pressure on the brake pedal until the emergency braking situation is over. During this process, the ABS prevents the wheels from locking up.

The brakes will resume normal operation after

- the brake pedal is released
- no obstacles are detected in your path
- the system no longer senses a risk of a collision

BAS PLUS is then deactivated.

BAS PLUS can react to stationary obstacles such as standing or parked vehicles at road

speeds of up to approximately 40 mph (70 km/h).

BAS PLUS can only assist you when the radar sensors are switched on and functional. You can check whether the sensors are active by switching on DISTRONIC PLUS (▷ page 330) or using the Radar sensors function (▷ page 236) in the instrument cluster control system.

#### **Warning!**

BAS PLUS will only respond with brake assistance if it has clearly detected an object. Detection can be impeded by

- dirty or covered sensors
- snowfall or heavy rain
- disturbance from other radar sources
- strong radar reflection such as in parking garages

BAS PLUS uses radar signals that are not reflected well by narrow objects and absorptive materials. For this reason BAS PLUS will not react to persons, animals, and approaching traffic or cross-traffic.

BAS PLUS may not detect narrow vehicles driving in front of you, such as motorcycles and vehicles driving offset from your vehicle center.

After a hard collision or damage to the front of the vehicle from an accident, have the adjustment and operation of the radar sensors checked by an authorized Mercedes-Benz Center.

If BAS PLUS is not available due to a radar sensor malfunction, the braking system will continue to function normally with full brake boost and full standard BAS function.

#### **Adaptive Brake**

Adaptive Brake provides a high level of braking safety as well as increased braking comfort. Adaptive Brake takes driver and

vehicle characteristics into consideration, thus achieving an optimal braking effect.

In addition, Adaptive Brake provides the HOLD function (▷ page 342) and the hill-start assist system (▷ page 341).

For more information on the brake system, see (▷ page 435).

### Adaptive Brake Lights

- ❗ This function is only available for the S 600 and the S 65 AMG (USA only).

The brake lamps flash in quick intervals

- while you are braking hard at a speed of more than 30 mph (50 km/h)
- when you are braking with the aid of BAS
- when you are braking with the aid of BAS PLUS.

This helps to alert drivers behind you.

If you bring the car to a complete stop by hard braking at a speed of more than 40 mph (70 km/h), the hazard warning flasher comes on automatically as soon as the vehicle is at a standstill. While the vehicle is stationary, the brake lamps are continuously lit up. Once you drive faster than 6 mph (10 km/h) afterward, the hazard warning flasher goes out.

### EBP

#### ⚠ Observe Safety notes, see page 63.

The Electronic Brake Proportioning (EBP) enhances braking effectiveness by allowing the rear brakes to supply a greater proportion of the braking effort in straight-line braking without a loss of vehicle stability.

#### ⚠ Warning!

If the EBP malfunctions, the brake system will still function with full brake boost. However, the rear wheels could lock up during emergency braking situations, for example.

You could lose control of the vehicle and cause an accident.

Adapt your driving style to the changed driving characteristics.

### ESC

#### ⚠ Observe Safety notes, see page 63.

The Electronic Stability Control (ESC) is operational as soon as the engine is running. It monitors the vehicle's traction (force of adhesive friction between the tires and the road surface) and handling.

The ESC recognizes that the vehicle deviates from the direction of travel as intended by the driver. By applying brakes to individual wheels and by limiting the engine output, the ESC works to stabilize the vehicle. The ESC is especially useful while driving off and on wet or slippery road surfaces. The ESC also stabilizes the vehicle during braking and steering maneuvers.

The ESC warning lamp  in the instrument cluster comes on when you switch on the ignition. It goes out when the engine is running.

#### ⚠ Warning!

Never switch off the ESC when you see the ESC warning lamp  flashing in the instrument cluster. In this case proceed as follows:

- When driving off, apply as little throttle as possible.
- While driving, ease up on the accelerator pedal.
- Adapt your speed and driving style to the prevailing road conditions.

Failure to observe these guidelines could cause the vehicle to skid. The ESC cannot prevent accidents resulting from excessive speed.

❗ Vehicles with 4MATIC:



Because the ESC operates automatically, the engine and ignition must be shut off (SmartKey in starter switch position **0** or **1** or KEYLESS-GO start/stop button in position **0** or **1**) when the electronic parking brake is being tested on a brake test dynamometer.

Active braking action through the ESC may otherwise seriously damage the brake system which is not covered by the Mercedes-Benz Limited Warranty.

### ! Vehicles without 4MATIC:

Because the ESC operates automatically, the engine and ignition must be shut off (SmartKey in starter switch position **0** or **1** or KEYLESS-GO start/stop button in position **0** or **1**) when the electronic parking brake is being tested on a brake test dynamometer or when the vehicle is being towed with one axle raised.

Active braking action through the ESC may otherwise seriously damage the brake system which is not covered by the Mercedes-Benz Limited Warranty.

### ! The ESC will only function properly if you use wheels of the recommended tire size as specified in the “Technical data” section of this Operator’s Manual.

**i** The DISTRONIC PLUS and cruise control switch off automatically when the ESC engages.

## Electronic Traction System (ETS/4-ETS)

### Observe Safety notes, see page 63.

The ETS (Electronic Traction System) and 4-ETS (four-wheel Electronic Traction System, vehicles with 4MATIC only) are components of the ESC. The ETS/4-ETS improves the vehicle’s ability to utilize available traction, especially under slippery road conditions by applying the brakes to a spinning wheel. Vehicles with 4MATIC also

transfer more power to the wheel(s) with traction.

When you switch off the ESC, the ETS/4-ETS is still enabled.

## Switching off the ESC

### Switching off the ESC (except S 63 AMG)

#### Warning!

The ESC should not be switched off during normal driving other than in the circumstances described below. Disabling the system will reduce vehicle stability in driving maneuvers.

Do not switch off the ESC when a spare wheel is mounted.

To improve the vehicle’s traction, switch off the ESC. This allows the drive wheels to spin and thus cut into surfaces for better grip, for example

- when driving with snow chains
- in deep snow
- in sand or gravel

#### Warning!

Switch on the ESC immediately if the aforementioned circumstances do not apply anymore. Otherwise the ESC will not stabilize the vehicle when it is starting to skid or a wheel is spinning.

When you switch off the ESC,

- the ESC does not stabilize the vehicle
- the engine output is not limited, which allows the drive wheels to spin and thus cut into surfaces for better grip
- the ETS/4-ETS will still apply the brakes to a spinning wheel
- the ESC continues to operate when you are braking



- the cruise control or the DISTRONIC PLUS cannot be activated
- the cruise control or the DISTRONIC PLUS switch off if activated

**i** When the ESC is switched off and one or more drive wheels are spinning, the ESC warning lamp  in the instrument cluster flashes. However, the ESC will then not stabilize the vehicle.

- ▶ With the engine running, switch off the ESC via the control system (▷ page 231).

#### **Warning!**

When the ESC OFF warning lamp  is on, the ESC is switched off.

When the ESC warning lamp  and the ESC OFF warning lamp  are on continuously, the ESC is not operational due to a malfunction.

When the ESC is switched off or not operational, vehicle stability in standard driving maneuvers is reduced.

Adapt your speed and driving to the prevailing road conditions and to the non-operating status of the ESC.

- !** Avoid spinning of a drive wheel for an extended period with the ESC switched off. This may cause serious damage to the drivetrain which is not covered by the Mercedes-Benz Limited Warranty.

### Switching off the ESC (S 63 AMG only)

#### **Warning!**

The ESC should not be switched off during normal driving.

Disabling of the system will result in the following:

- no restriction to engine torque
- loss of system-supported traction control

“ESC OFF” is designed for driving on closed tracks when the vehicle’s natural oversteer and understeer characteristics are desired

and requires a highly skilled and experienced driver able to handle these critical driving situations.

You could lose control of your vehicle and cause an accident.

Please be aware of these limits when you switch off the ESC.

Do not switch off the ESC when a spare wheel is mounted.

When you switch off the ESC,



- the ESC does not stabilize the vehicle
- the engine output is not limited, which allows the drive wheels to spin
- the ETS will still apply the brakes to a spinning wheel
- the ESC operates while you are braking
- the cruise control or the DISTRONIC PLUS cannot be activated
- the cruise control or the DISTRONIC PLUS switch off if activated

**i** When the ESC is switched off and one or more drive wheels are spinning, the ESC warning lamp  in the instrument cluster flashes. However, the ESC will then not stabilize the vehicle.

- ▶ With the engine running, switch off the ESC via the control system (▷ page 231).

#### **Warning!**

When the ESC OFF warning lamp  is on, the ESC is switched off.

When the ESC warning lamp  and the ESC OFF warning lamp  are on continuously, the ESC is not operational due to a malfunction.

When the ESC is switched off or not operational, vehicle stability in standard driving maneuvers is reduced.

Adapt your speed and driving to the prevailing road conditions and to the non-operating status of the ESC.

- ❗ Avoid spinning of a drive wheel for an extended period with the ESC switched off. This may cause serious damage to the drivetrain which is not covered by the Mercedes-Benz Limited Warranty.

### Switching on the ESC

- ▶ Switch on the ESC via the control system (▷ page 231).

### PRE-SAFE® Brake

The PRE-SAFE® Brake is available in vehicles equipped with DISTRONIC PLUS. The PRE-SAFE® Brake can assist you in minimizing the risk of a rear-end collision with a vehicle in front of you. The PRE-SAFE® Brake may also reduce the severity of an accident. At speeds above approximately 20 mph (30 km/h) it will issue a warning when your vehicle is approaching the preceding vehicle very quickly. An intermittent acoustic warning sounds and the distance warning lamp  in the instrument cluster comes on.

When the driver and front passenger have fastened their seat belts, the PRE-SAFE® Brake can also

- brake the vehicle within a speed range of up to 112 mph (180 km/h) automatically
- activate preventative occupant safety measures (PRE-SAFE®) (▷ page 54)

#### Warning!

An intermittent warning sounds and the distance warning lamp  in the instrument cluster is illuminated if the PRE-SAFE® Brake calculates that the distance to the vehicle ahead and your vehicle's current speed indicate that the PRE-SAFE® Brake will not be capable of slowing the vehicle sufficiently to maintain the preset following distance, which creates a danger of a collision.

Immediately brake your vehicle to increase the distance between your vehicle and the

vehicle driving in front of you. The warning sound is intended as a final caution that you have not interceded with your own braking inputs to avoid a potentially dangerous situation. Do not wait for the operation of the warning signal to intercede with your own braking, as that will result in potentially dangerous emergency braking which will not always result in an impact being avoided. Tailgating increases the risk of an accident.

#### Warning!

The PRE-SAFE® Brake is a convenience system designed to assist the driver during vehicle operation. The responsibility for the vehicle speed and the distance to the vehicle ahead, including most importantly brake operation to assure safe stopping distance, always remains with the driver.

Always pay attention to traffic conditions even while the PRE-SAFE® Brake is switched on. Otherwise, you may not be able to recognize dangerous situations until it is too late and could cause an accident resulting in personal or fatal injury to you or others.

#### USA only:

This device has been approved by the FCC as a "Vehicular Radar System". The radar sensor is intended for use in an automotive radar system only. Removal, tampering, or altering of the device will void any warranties, and is not permitted by the FCC. Do not tamper with, alter, or use in any non-approved way.

Any unauthorized modification to this device could void the user's authority to operate the equipment.

**i** Canada only:

This device complies with RSS-210 of Industry Canada. Operation is subject to the following two conditions:

1. This device may not cause interference, and
2. this device must accept any interference received, including interference that may cause undesired operation of the device.

Removal, tampering, or altering of the device will void any warranties, and is not permitted. Do not tamper with, alter, or use in any non-approved way.

Any unauthorized modification to this device could void the user's authority to operate the equipment.

Using the radar sensors, the PRE-SAFE® Brake detects obstacles that are in your driving path for a sufficient period of time for the system to recognize it. If you approach a vehicle and the PRE-SAFE® Brake has established that the distance to the vehicle ahead at your current speed is so close that the PRE-SAFE® Brake will not be capable of slowing the vehicle sufficiently, the system will initially warn you visually and acoustically. If you do not apply the brakes yourself or maneuver around a sensed obstacle, the vehicle will brake lightly automatically. The PRE-SAFE® system (▷ page 54) is activated when the distance to the vehicle ahead at your current speed is so close that the PRE-SAFE® Brake will not be capable of slowing the vehicle sufficiently.

When the danger of a collision still persists and you do not brake or accelerate significantly, the PRE-SAFE® Brake may initiate full application of the brakes automatically.

**Warning!**

The PRE-SAFE® Brake will only respond with brake assistance if it has clearly detected an object. Detection can be impeded by

- dirty or covered sensors
- snowfall or heavy rain
- disturbance from other radar sources
- strong radar reflection such as in parking garages

The PRE-SAFE® Brake uses radar signals that are not reflected well by narrow objects and absorptive materials. For this reason the PRE-SAFE® Brake will not react to persons, animals, and approaching traffic or cross-traffic.

The PRE-SAFE® Brake may not detect narrow vehicles driving in front of you, such as motorcycles and vehicles driving offset from your vehicle center.

**Warning!**

Depending on the vehicle speed, the PRE-SAFE® Brake brakes your vehicle with a maximum of 13 ft/s<sup>2</sup> (4 m/s<sup>2</sup>) before a possible hard stop. This corresponds to about 40% of the maximum deceleration ability of your vehicle. The driver must apply the brakes additionally in order to prevent a collision. The self-acting hard stop will be initiated when the imminent danger of a collision exists, e.g. when an evasive driving maneuver cannot avoid an accident.

The PRE-SAFE® Brake applies the brake pedal automatically which results in the brake pedal moving. Therefore keep driver's foot area clear at all times, including the area under the brake pedal. Objects stored in this area may impair pedal movement which could interfere with the braking ability of the PRE-SAFE® Brake.

Do not place your foot under the brake pedal – your foot could become caught.

To maintain the proper distance to the vehicle in front of you and thus prevent a rear-end collision, you must apply the brakes yourself.

- Brake the vehicle immediately to avoid a collision.

Under no circumstances should the driver await the intermittent warning sound before braking. Observe the following warning note.

The intermittent warning sound ceases and the distance warning lamp  goes out when the necessary distance to the vehicle ahead is again established.

The PRE-SAFE® Brake can react to stationary obstacles such as standing or parked vehicles at road speeds of up to approximately 40 mph (70 km/h).

#### Warning!

If you do not receive visual or acoustic warning signals, the PRE-SAFE® Brake may

- not have recognized the collision risk
- have been deactivated
- be malfunctioning

Apply the brakes yourself to avoid a collision.

The PRE-SAFE® Brake does not always clearly interpret complex traffic situations. If a visual and/or acoustic warning is issued in an uncritical driving situation, or if the vehicle brakes lightly, you can interrupt the PRE-SAFE® Brake maneuver by pressing down all the way on the accelerator pedal, using kickdown, or releasing the brake pedal.

The PRE-SAFE® Brake maneuver is terminated immediately when

- you avoid the obstacle by evasive steering
- you drive less than 9 mph (15 km/h)
- an obstacle can no longer be identified ahead of you
- the system no longer senses the risk of a collision

- ❗ The PRE-SAFE® Brake will remain passive while DISTRONIC PLUS is switched on (▷ page 330).



After a hard collision or damage to the front of the vehicle from an accident, have the settings and operation of the radar sensors checked by an authorized Mercedes-Benz Center.

When traveling in Canada in a vehicle not registered in Canada, you must switch off the radar sensor system (▷ page 236). Canadian law does not permit the use of the radar sensor system for vehicles from outside of Canada.

When you switch off the radar system, the following functions are deactivated:

- PRE-SAFE® Brake
- BAS PLUS (▷ page 64)
- DISTRONIC PLUS (▷ page 330)
- Blind Spot Assist (▷ page 359)

- **Activating and deactivating:** Activate or deactivate the PRE-SAFE® Brake using the instrument cluster control system (▷ page 232).

After the function has been activated, the PRE-SAFE® Brake indicator  appears in the instrument cluster. When the HOLD function is switched on, the PRE-SAFE® Brake indicator  will not appear.

## Anti-theft systems

### Immobilizer

The immobilizer prevents unauthorized persons from starting your vehicle.

When leaving the vehicle, always take the SmartKey with you and lock the vehicle. The engine can be started by anyone with a valid SmartKey that is left inside the vehicle.

## Activating

- ▶ **With SmartKey:** Remove the SmartKey from the starter switch.
- ▶ **With KEYLESS-GO:** Turn off the engine and open the driver's door.

## Deactivating

- ▶ Switch on the ignition.
- i** Starting the engine will also deactivate the immobilizer.
- In the event that the engine cannot be started (yet the vehicle's battery is charged), the system is not operational. Contact an authorized Mercedes-Benz Center or call 1-800-FOR-MERCEdes (in the USA) or 1-800-387-0100 (in Canada).

## Anti-theft alarm system

Once the alarm system has been armed, a visual and audible alarm is triggered when someone opens

- a door
- the trunk
- the hood

The alarm will stay on even if the activating element, a door, for example, is closed immediately.

The alarm system will also be triggered when

- the vehicle is opened with the mechanical key
- a door is opened from the inside

To cancel the alarm after it has been triggered, see "Canceling the alarm" (> page 73).

- i** If the alarm stays on for more than 30 seconds, the Tele Aid system initiates a call to the Customer Assistance Center automatically. The Tele Aid system will initiate the call provided that

- you have subscribed to the Tele Aid service
- the Tele Aid service has been activated properly
- the necessary mobile phone, power supply and GPS coverage are available

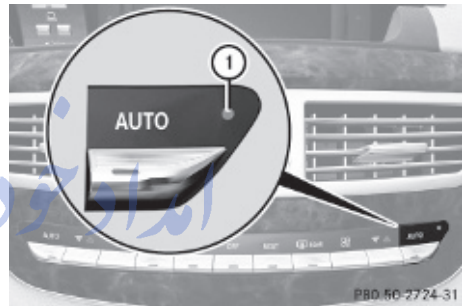

- ▶ **Arming:** Lock the vehicle with the SmartKey or with KEYLESS-GO. The turn signal lamps flash three times and an acoustic warning sounds three times to indicate that the vehicle is locked. Indicator lamp ① flashes to indicate that the alarm system is armed.

- i** If the turn signal lamps do not flash three times and the acoustic warning does not sound three times, a door or the trunk may not be properly closed.



Close the respective element.

- ▶ **Disarming:** Unlock the vehicle with the SmartKey or with KEYLESS-GO. The turn signal lamps flash once and an acoustic warning sounds once to indicate that the alarm system is disarmed.

- i** Unless you open a door or the trunk within approximately 40 seconds after unlocking the vehicle:
- The vehicle will be locked again.
  - The anti-theft alarm system will be rearmed.

### Canceling the alarm

To cancel the alarm, do one of the following:

- ▶ Insert the SmartKey into the starter switch.
- ▶ Press button  or  on the SmartKey.

In vehicles with KEYLESS-GO:

- ▶ Grasp an outside door handle.  
The SmartKey must be within 3 ft (1 m) of the vehicle.
- ▶ Press the KEYLESS-GO start/stop button.  
The SmartKey must be inside the vehicle.

تلفن شبانه روزی: ۰۲۱-۸۸۸۶۲۰۸۵

FarmaSOS.com

# امداد خودرو فارما

تلفن شبانه روزی: ۰۲۱-۸۸۸۶۲۰۸۵

**FarmaSOS.com**



Vehicle equipment .....	76	COMAND video DVD .....	191
COMAND introduction .....	76	Music Register .....	196
COMAND system settings .....	91	Media Interface .....	200
COMAND navigation (introduction) ...	95	COMAND vehicle menu .....	206
COMAND navigation system (entering a destination) .....	106	COMAND automatic climate control	211
COMAND navigation system (Point of interest entry) .....	124	COMAND seats .....	216
COMAND navigation system (route guidance) .....	129	Instrument cluster control system .	220
COMAND navigation system (dur- ing route guidance) .....	135	Voice Control System introduction .	237
COMAND navigation system (real- time traffic) .....	138	Voice Control System navigation ....	240
COMAND navigation system (des- tination memory) .....	143	Voice Control System telephone .....	245
COMAND navigation system (last destinations) .....	147	Voice Control System address book	249
COMAND telephone .....	148	Voice Control System radio .....	252
COMAND FM/AM radio .....	165	Voice Control System CD/DVD changer/MP3 .....	255
COMAND satellite radio .....	170	Voice Control System external devices .....	257
COMAND audio CD/audio DVD/ MP3 .....	176	Voice Control System command list	257
Audio AUX and video AUX .....	186	Voice Control System trouble- shooting .....	267
Rear Seat Entertainment System ....	189	Voice Control System individuali- zation .....	271



## Vehicle equipment

**i** This Operator's Manual describes all features, standard or optional, potentially available for your vehicle at the time of purchase. Please be aware that your vehicle might not be equipped with all features described in this manual.

## COMAND introduction

### COMAND operating safety

COMAND (Cockpit Management and Data System) is an information and operating center for vehicle sound and communications systems. It includes the radio and navigation system, as well as other optional equipment (satellite radio, telephone, etc.).

#### **Warning!**

Any alteration of electronic components or software can cause malfunctions.

Radio, satellite radio, amplifier, CD/DVD changer, navigation module, telephone and Voice Control Systems are interconnected. Therefore, if one of the components is not operational, or has not been removed/replaced properly, the function of other components could be impaired.

Such conditions might seriously impair the operating safety of your vehicle.

We recommend to have any service work on electronic components carried out by an authorized Mercedes-Benz Center.

#### **Warning!**

In order to avoid distraction which could lead to an accident, the driver should enter system settings while the vehicle is at a standstill, and operate the system only when permitted by road, weather and traffic conditions.

Bear in mind that at a speed of just 30 mph (approximately 50 km/h), your vehicle is covering a distance of 44 feet (approximately 14 m) every second.

COMAND supplies you with information to help you select your route more easily and guide you conveniently and safely to your destination. For safety reasons, we encourage the driver to stop the vehicle in a safe place before answering or placing a call, or consulting the COMAND screen to read navigational maps, instructions, or downloaded information.

#### **Warning!**

While the navigation system provides directional assistance, the driver must remain focused on safe driving behavior, especially attention to traffic and street signs, and should utilize the system's audio cues while driving.

The navigation system does not supply any information on stop signs, yield signs, traffic regulations or traffic safety rules. Their observance always remains in the driver's personal responsibility. Maps do not cover all areas nor all routes within an area.

#### **Warning!** تلفن

HYBRID vehicles: It is imperative that you read the HYBRID Supplemental Operating Instructions included in your vehicle literature portfolio. You may otherwise not receive all necessary safety information and warning for the operation of your vehicle.

### Availability of functions while the vehicle is in motion

For safety reasons, certain COMAND functions are not available while the vehicle is in motion or they are only available to a limited extent. You will notice this, for example, by the fact that certain menu items cannot be selected or that the COMAND display shows a corresponding message.

### Switching COMAND on or off

- ▶ Press shortcut button **ON** in the center console (▷ page 77).  
COMAND calls up the last selected menu.
- i** When you switch off COMAND, you also switch off the currently playing audio source. During a telephone call, you cannot switch off COMAND.

### COMAND components

COMAND can be used to operate:

- Audio functions
- Navigation system
- Telephone
- External audio and video sources
- Video DVD
- Various vehicle settings

COMAND consists of the following:

- COMAND shortcut buttons
- COMAND display (with SPLITVIEW, if so equipped)
- Telephone keypad
- COMAND controller
- Built-in USB socket to connect USB storage devices
- Optional media interface in the glove box to connect external devices via iPod® cable, jack plug, or USB cable

The Rear Seat Entertainment System consists of the following:

- two remote controls
- two wireless headphones
- two screens in rear passenger compartment
- one CD/DVD drive in rear passenger compartment

- Audio and video sockets on each screen
- Audio and video sockets on CD/DVD drive

The Rear Seat Entertainment System contains the following functions:

- Disc playback (CD audio, MP3, DVD audio and DVD video)
- AUX playback
- System settings

SPLITVIEW contains the following:

- one remote control for the front passenger
- one wireless headphone for the front passenger
- one 3.5 mm socket in the front passenger footwell for SPLITVIEW wired headphones



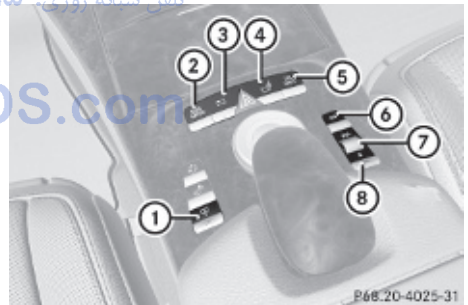

- i** For information about cleaning and care of displays, see (▷ page 446).

### COMAND shortcut buttons

Use the COMAND shortcut buttons to select main functions directly.



	Function
①	Shortcut button for rear window sunshade (▷ page 386)
②	<div style="display: inline-block; border: 1px solid black; padding: 2px; margin-right: 5px;">DISC RADIO</div> Shortcut button for: <ul style="list-style-type: none"> <li>• CD/DVD/SD card (▷ page 181)</li> <li>• Radio (▷ page 166)</li> </ul>
③	<div style="display: inline-block; border: 1px solid black; padding: 2px; margin-right: 5px;">←</div> Back button (▷ page 87)

	Function
④	 Seat menu button (▷ page 216)
⑤	 Shortcut button for: <ul style="list-style-type: none"> <li>• Telephone (▷ page 148)</li> <li>• Navigation (▷ page 95)</li> </ul>
⑥	 COMAND on/off button (▷ page 77)
⑦	 Volume control (▷ page 88)
⑧	 Favorite button (▷ page 94)

## COMAND display

In the COMAND display, you will find the function currently selected and the corresponding menus. The COMAND display is divided into several areas.



- ① Status line
- ② Main functions
- ③ Main area
- ④ Submenus
- ⑤ Climate control settings

The currently selected main function is highlighted.

Once you have selected a main function, main area ③ is active.

- i** The layout of the menus may vary depending on your vehicle's equipment. This manual shows the menus for a fully equipped vehicle.

## Adjusting COMAND display illumination

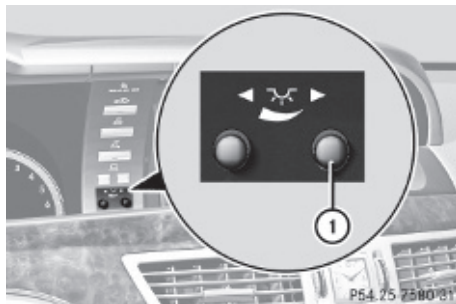

- ▶ **Increasing the illumination:** Turn knob ① clockwise.
- ▶ **Dimming the illumination:** Turn knob ① counterclockwise.

## Swiveling COMAND display

- i** This function is not available in vehicles with SPLITVIEW.

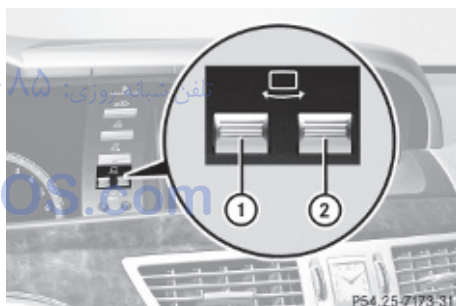

With button ① or ② you can swivel the COMAND display to the left or right.

## Instrument cluster multifunction display

This section describes features and controls via the COMAND controller, display and shortcut buttons only.

Related COMAND features are described in the "Instrument cluster control system" section (▷ page 220). It contains function descriptions and operation of the instrument cluster multifunction display and the multifunction steering wheel buttons.

## Telephone keypad

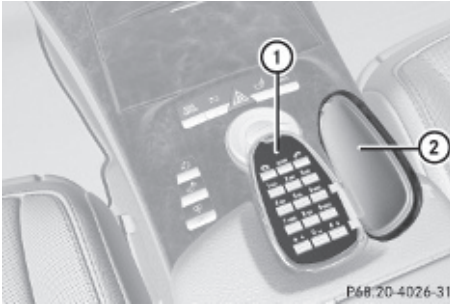

► Flip up cover ②.

With telephone keypad ① you can

- enter and clear numbers and special characters
- reject, answer, connect and end calls (▷ page 148)
- select preset radio stations and enter the frequency manually (▷ page 168)
- select preset satellite radio stations and enter the channel number (▷ page 174)
- select a storage medium from the DVD changer (▷ page 183)
- select a track directly in CD mode, DVD audio mode or MP3 mode (▷ page 183), or from a device connected to the media interface (▷ page 204)
- select a scene/chapter from a video DVD (▷ page 194)
- select a street in the navigation entry (▷ page 115)

## COMAND controller

Use the COMAND controller to select menu functions shown on the COMAND display.

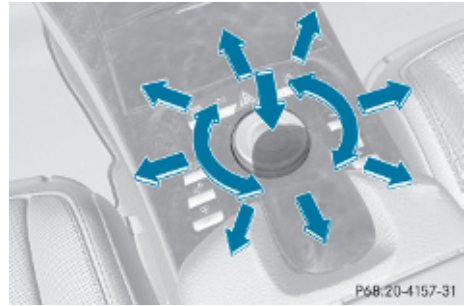

Operating COMAND controller

You can operate the COMAND controller as follows:

- press briefly or press and hold
- rotate to the left or right
- slide to the left, right, up, down or diagonally

In this way, you can move through the menus, select menu items or exit menus.

Symbol	How to use the COMAND controller
	<p>► Press briefly</p> <ul style="list-style-type: none"> <li>• to confirm the selection of a menu item or list entry</li> <li>• to exit full-screen image when using navigation or video functions</li> </ul>
	<p>► Press and hold until the selected action has been carried out</p> <ul style="list-style-type: none"> <li>• to save a station</li> <li>• to accept a destination for navigation</li> </ul>
	<p>► Rotate</p> <ul style="list-style-type: none"> <li>• to move through vertical or horizontal menus</li> <li>• to move through text</li> <li>• to select program settings</li> </ul>

Symbol	How to use the COMAND controller
↑⊙↓	<ul style="list-style-type: none"> <li>▶ Slide               <ul style="list-style-type: none"> <li>• to move through vertical menus</li> <li>• to exit horizontal menus</li> </ul> </li> <li>▶ Slide and hold               <ul style="list-style-type: none"> <li>• to move through a navigation map</li> </ul> </li> </ul>
←⊙→	<ul style="list-style-type: none"> <li>▶ Slide               <ul style="list-style-type: none"> <li>• to move through horizontal menus</li> <li>• to exit vertical menus</li> </ul> </li> <li>▶ Slide and hold               <ul style="list-style-type: none"> <li>• for fast forward or reverse for audio CD or audio DVD playback</li> <li>• to move through a navigation map</li> </ul> </li> </ul>
⊙↔	<ul style="list-style-type: none"> <li>▶ Slide and hold               <ul style="list-style-type: none"> <li>• to move through a navigation map</li> </ul> </li> </ul>

## USB socket



Connect USB storage device to the built-in USB socket ① in the glove box to transfer data (> page 95) or to playback audio tracks (> page 176).

- ❗ Do not use USB extensions or adapters. They could impair functionality. The initialization of large USB storage devices that contain a large number of files may take several minutes.

## Supported USB storage devices

The following USB storage devices are supported:

- USB flash drives
- USB hard drives (1", 1.8", and 2.5") with a starting/steady current not to exceed 800 mA (separate power supply may be necessary)

- ❗ The USB socket supports USB storage devices of "USB Device Subclass 6". Information on "USB Device Subclass 6" is available from the manufacturer of the respective device.

## Media interface

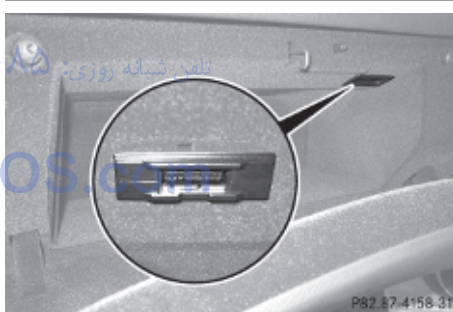

The media interface is located in the glove box. For information about using the media interface, see (> page 200).

## Control panel on rear armrest

Occupants in the rear can adjust the volume of the active audio source. They can also select the next or previous track, scene or station.

- ❗ This function is only available in vehicles with rear multicontour seats.



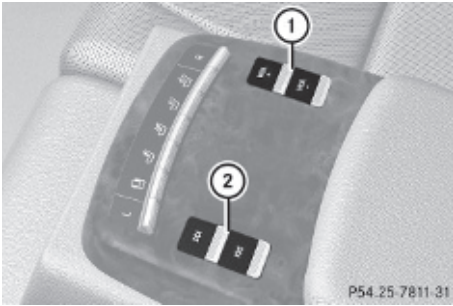

Rear armrest

- ① Adjusting volume
- ② Selecting next/previous track, scene or station

### Remote control for Rear Seat Entertainment System and/or SPLITVIEW

 **Observe Safety notes, see page 76.**

SPLITVIEW includes one remote control for the front passenger.

The Rear Seat Entertainment System includes two remote controls for the rear passenger compartment.

If your vehicle is equipped with Rear Seat Entertainment System and SPLITVIEW, the remote controls are interchangeable.

For information on using SPLITVIEW, see (> page 90).

For information on using the Rear Seat Entertainment System, see (> page 189).

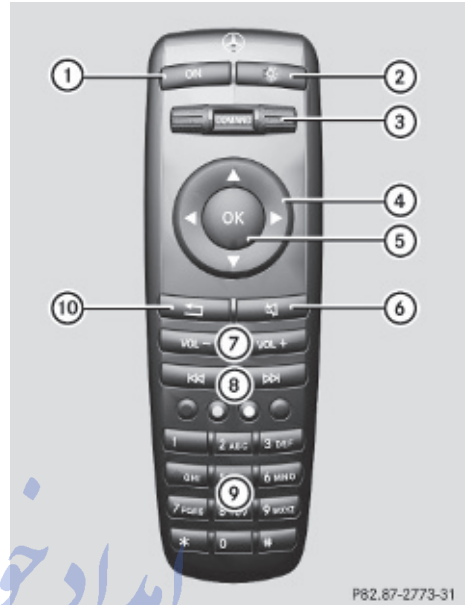

- ① Switching on/off
  - ② Switching button backlight on/off
  - ③ Selecting remote control mode
  - ④ Selecting menu or menu item<sup>4</sup>
  - ⑤ Confirming selection or setting<sup>5</sup>
  - ⑥ Mute on/off (with wired headphones)
  - ⑦ Volume (with wired headphones)
  - ⑧ Skip, fast forward, fast rewind
  - ⑨ Track/scene direct selection
  - ⑩ Back button, leaving menus
- i** Replace the batteries of the remote control when they are low (> page 502).

#### Selecting remote control mode

- Turn thumb wheel ③ to the desired setting.

COMAND COMAND display (driver)

SPLITVIEW COMAND display (front passenger)<sup>6</sup>

<sup>4</sup> Corresponds with sliding of the COMAND controller.

<sup>5</sup> Corresponds with pressing the COMAND controller.

<sup>6</sup> This function is only available in vehicles with SPLITVIEW

REAR L Left screen<sup>7</sup>  
 REAR R Right screen<sup>7</sup>

- i** In position COMAND, you can operate various COMAND functions via remote control buttons ④ and ⑤.

### Switching SPLITVIEW or rear screens on/off

- i** When the SmartKey is in starter switch position **0** or **1** or removed from the starter switch, the rear screens switch off after 30 minutes automatically. A corresponding message appears on the screens prior to switching off.

You can switch the screens back on. Keep in mind however that this will drain the vehicle battery.

- ▶ **Switching on with the COMAND system already on:** Aim the remote control on the screen.
- ▶ Press button ①.
- ▶ **Switching off:** Aim the remote control on the screen.
- ▶ Press button ①.

### Switching button backlight on/off

- ▶ Press button ②.
- i** When you do not use the remote control for approximately 15 seconds, the button backlight switches off automatically.

### Mute on/off (for wired headphones or COMAND)

- ▶ Press button ⑥.

### Selecting menu or menu item and confirming selection

- ▶ **Selecting menu or menu item:** Press arrow buttons ④.
- ▶ **Confirming selection:** Press button ⑤.

### Headphone

#### **Warning!**

The driver should not wear a headphone while operating the vehicle under any circumstances. The use of a headphone while driving the vehicle could drastically impair the ability to react to audible traffic conditions (e.g. emergency sirens from police/fire/ambulance, another car's horn, etc.).

#### **Warning!**

When not in use, headphones or external video sources should be stored in a safe location (e.g. one of the vehicle's storage compartments) so that they are not loose within the passenger compartment during braking, vehicle maneuvers or a traffic accident. Objects moving within the passenger compartment could cause serious personal injury to vehicle occupants.

#### **Warning!**

Due to a potential choking hazard, wired headphone usage by children should only occur with adult supervision.

For information on using SPLITVIEW, see (▷ page 90).

For information on using the Rear Seat Entertainment System, see (▷ page 189).

<sup>7</sup> This function is only available in vehicles with Rear Seat Entertainment System



## Wireless headphone for Rear Seat Entertainment System or SPLITVIEW



- ① Volume
- ② Selecting screen<sup>8</sup>
- ③ Battery compartment cover
- ④ Switching wireless headphone on/off
- ⑤ Indicator lamp, showing various conditions

**i** Replace the batteries of the headphone when they are low (> page 502).

The indicator lamp shows the following conditions:

- Green The headphone is on and the batteries are charged.
- Red The headphone is on and the batteries are low.
- Off The headphone is switched off and the batteries are either low or not inserted at all.

► **Adjusting headphone:** Unfold both sides of the headphone and adjust to a

comfortable fit by pulling the overhead headband in direction of arrows.

► **Switching headphone on/off:** Press button ④.

The headphones will switch off automatically when they do not receive an infrared signal within approximately 3 minutes in order to preserve the batteries.

► **Adjusting volume:** Turn volume thumb wheel ① to the desired volume.

► **Selecting screen:** Press switch ② to **L** (left screen) or **R** (right screen).

Music and voice are transmitted via infrared signal. The headphone and the display must have visual contact. This provides best possible transmission of the infrared signal to the headphone. Please note that the

<sup>8</sup> Headphones for Rear Seat Entertainment System only.

headphone has a left and right side and must be used accordingly.

The Rear Seat Entertainment System and SPLITVIEW headphones are not interchangeable.



The SPLITVIEW wireless headphone can be identified by SPLITVIEW symbol ①.

### Wired headphones for Rear Seat Entertainment System

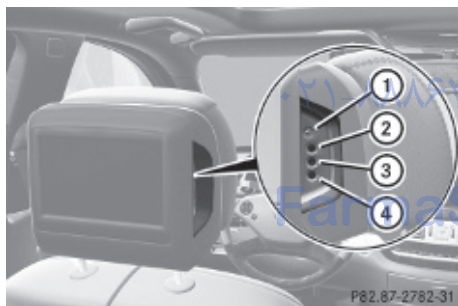

- ① Socket for wired headphone
- ② V Video input

- ③ L left audio input
- ④ R right audio input

An additional wired headphone can be connected to each rear screen. The socket is designed for headphones with a 3.5 mm stereo jack plug and an impedance of 32 ohm.

- ① Press buttons ⑦ on the remote control (▷ page 81) to adjust the volume of a wired headphone connected to a rear screen.

### Wired headphone for SPLITVIEW



A wired headphone for use with SPLITVIEW can be connected to socket ① in the front passenger footwell. The socket is designed for headphones with a 3.5 mm stereo jack plug and an impedance of 32 ohm.

## Operating COMAND

### Main function menu overview

Each of the main functions Navi, Audio, Telephone, Video and Vehicle has a main menu that consists of menus or functions.

Example: The main function Video contains the menus DVD-Video, AUX and the function Video Off.

Navi	Audio	Telephone	Video	Vehicle
Mode	FM/AM Radio		Video DVD	Multi-function Contour Seat Settings/ Lumbar Settings
Map Orientation	Sat. Radio		AUX	Rear Window Sunshade
POI Symbols On Map	Disc		Video OFF	Easy Entry/Exit
Traffic Symbols on Map	Memory Card			Exterior Lighting Delayed Shut-off
Text Information on Map	Music Register			Interior Lighting Delayed Shut-off
<input type="checkbox"/> Topographical Map	Media Interface			Ambient Lighting
<input type="checkbox"/> City (3D)	USB			<input type="checkbox"/> Automatic Mirror Folding
<input type="checkbox"/> Highway Information	Rear			<input type="checkbox"/> Locator Lighting
<input type="checkbox"/> Audio Fadeout	AUX			<input type="checkbox"/> Automatic Locking
SIRIUS Service	Audio OFF			<input type="checkbox"/> Trunk Opening-height Restriction
Map Version				

### Calling up the main menu

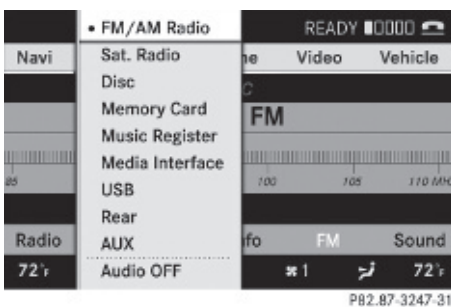

Example illustration: Audio main menu

You can call up the main menu of a main function in the following manner:

- ▶ **Moving to the main function line:** Slide  $\uparrow \odot$ .
- ▶ **Selecting a main function:** Slide  $\leftarrow \odot \rightarrow$  or rotate  $\left[ \odot \right]$ .
- ▶ **Confirming selection:** Press  $\odot$ .

**i** When a main function (e.g. Navi) is open and you want to open the menu of the Audio function for example, the main function Audio must be selected twice. Upon selecting the first time, the COMAND system selects the main function Audio.

When selecting that main function once more, the Audio main menu opens.

## Vertical menus

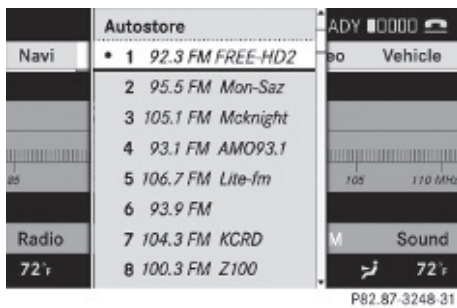

P82.87-3248-31

- ▶ **Moving through the menu:** Slide  $\uparrow$   $\downarrow$  or rotate  $\left\{ \begin{array}{c} \odot \\ \odot \end{array} \right\}$ .
- ▶ **Selecting a menu item:** Press  $\odot$ .
- ▶ **Exiting a menu without making a selection:** Slide  $\leftarrow$   $\rightarrow$  in a horizontal direction.

or

- ▶ Press back button  $\leftarrow$  ( $\triangleright$  page 87).

## Horizontal menus



P82.87-3249-31

- ▶ **Moving through the menu:** Slide  $\leftarrow$   $\rightarrow$  or rotate  $\left\{ \begin{array}{c} \odot \\ \odot \end{array} \right\}$ .
- ▶ **Selecting a menu item:** Press  $\odot$ .
- ▶ **Exiting a menu without making a selection:** Slide  $\uparrow$   $\downarrow$  in a vertical direction.

or

- ▶ Press back button  $\leftarrow$ .

## Entering characters



Example illustration: Entering a navigation destination

## Selecting characters

- ▶ Slide  $\leftarrow$   $\rightarrow$  or rotate  $\left\{ \begin{array}{c} \odot \\ \odot \end{array} \right\}$ .
- ▶ **Confirming selection:** Press  $\odot$ .

## Deleting individual characters

- ▶ Select  $\left[ \text{c} \right]$  in the bottom line and press  $\odot$  once for each character you wish to delete

## Deleting entire words or numbers

- ▶ Select  $\left[ \text{c} \right]$  in the bottom line. Press and hold  $\odot$  until the word or number is deleted.

## Exiting character entry

- ▶ Select  $\left[ \leftarrow \right]$  in the bottom line and press  $\odot$ .

or

- ▶ Press back button  $\leftarrow$ .

## Switching to the list

- ▶ Slide  $\uparrow$   $\downarrow$ .

or

- ▶ Select  $\left[ \text{ok} \right]$  in the second line from the bottom and press  $\odot$ .

- ▶ **Exiting list:** Slide  $\leftarrow$   $\rightarrow$  to select Back and press  $\odot$ .



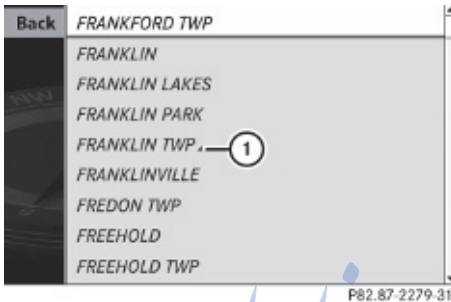

## Accepting first entry

- ▶ Press  until you exit the character entry window.  
COMAND completes your entry as soon as it can be clearly identified. In this case, you do not need to switch to the list.

## Selecting list item



Example illustration: List of cities for navigation

- ① Symbol for other selection options (e.g. county)
- ▶ **Selecting a line:** Slide   or rotate  .
- ▶ **Confirming selection:** Press .  
Additional selection options are available for list entries featuring symbol ①. For example, cities marked with symbol ① indicate that the selected country has more than one city featuring that name. Confirming such a list entry opens a submenu.

## Back button



## ▶ Switching to the next higher menu:

Press back button  briefly.

COMAND switches to the next higher menu level within the currently active operating mode.

## ▶ Switching to the main menu:

Press and hold back button .

COMAND switches to the main menu of the currently active operating mode.

## Basic functions

- ① The components and operating principles of COMAND can be found on (▶ page 76).

## Sound

- ▶ **Muting:** Press button  on the multifunction steering wheel (▶ page 221).

The sound of the current audio source is switched on or is muted.

- ① When the sound is muted, symbol  appears in the status line. When you change the audio source, the sound is switched on automatically. Navigation announcements will be audible even when the sound is muted.

## Switching navigation announcements off

- ▶ Press button  on the multifunction steering wheel during an announcement.

- ① The announcements remain switched off even when you start a new route guidance or switch COMAND off/on with the  button. When you switch COMAND off by removing the SmartKey from the starter switch and then switch the ignition back on after more than 3 minutes, the announcements are switched back on automatically.

- ▶ **Switching navigation announcements back on manually:** Select Navi → RPT (▶ page 135).

## Adjusting volume



► **Adjusting:** Turn thumbwheel .

or

► Press button  or  on the multifunction steering wheel.

**i** Vehicles with rear multicontour seats: Occupants in the rear can also adjust the volume using the buttons on the rear armrest (► page 80).

## Volume of navigation announcements

You can adjust the volume of navigation announcements independently of the respective audio source volume.

During a navigation announcement:

► Turn thumbwheel .

or

► Press button  or  on the multifunction steering wheel.

You can recall a navigation announcement manually.

► Select Navi → RPT.

## Adjusting volume for telephone calls

In hands-free mode, you can adjust the volume of a telephone call while the call is active.

During a telephone call:

► Turn thumbwheel .

or

► Press button  or  on the multifunction steering wheel.

## Selecting sound settings

You can select different bass and treble settings for the individual audio and video sources. The respective sound menu can be found via the submenu for which you wish to make settings.

Example: Audio → FM/AM Radio → Sound

## Adjusting treble or bass

► Select Sound → Treble or Bass.

The setting last selected is indicated by an outlined bar.

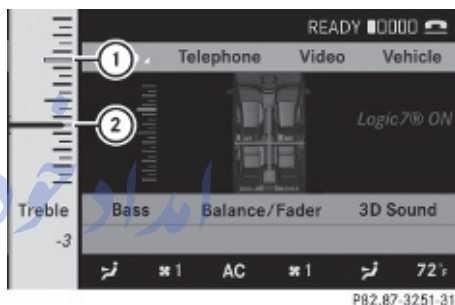

① Last selected setting

② Current setting

► **Changing setting:** Slide  or  or rotate  until desired treble or bass setting is reached.

► **Saving setting:** Slide  or  or press  or back button .

The setting is stored and the menu is exited.

## Adjusting balance or fader

Balance is used to shift the sound focus toward the driver's side or the passenger's side.

Fader is used to shift the sound focus to the front or to the rear of the vehicle.

► Select Sound → Balance/Fader.

The setting last selected is indicated by an outlined bar.

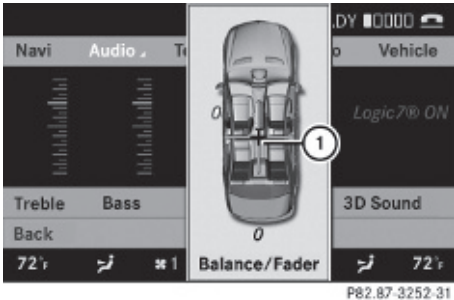

① Current setting indicated by orange cross hair symbol

► **Changing setting:** Slide  $\uparrow \odot \downarrow$  or  $\leftarrow \odot \rightarrow$  until desired balance/fader setting is reached.

► **Saving setting:** Press  $\odot$  or back button  $\leftarrow$ .

The setting is stored and the menu is exited.

### 3-D sound

With 3-D sound, you can choose between Logic7® ON and Logic7® OFF.

harman/kardon Logic7® 3-D sound is available for the following operating modes:

- Audio DVD (MLP™, DTS™, PCM, and Dolby Digital® audio formats)
- Video DVD (DTS™, PCM, and Dolby Digital® audio formats)
- Audio CD
- MP3
- Radio (FM only, HD Radio™, SIRIUS Satellite Radio)
- SD
- USB
- AUX
- Music Register
- Media interface

① Since some DVDs contain stereo as well as multi-channel audio formats, it may be

necessary to adapt the audio format (▷ page 185).

① By selecting Logic7® OFF, all compatible formats are played back as they are present on the medium. Due to the design of the passenger compartment, an optimum audio experience cannot be guaranteed for all passengers.

### Adjusting 3-D sound

With 3-D sound, you can choose between Logic7® ON and Logic7® OFF.

► Select Sound → 3D Sound.

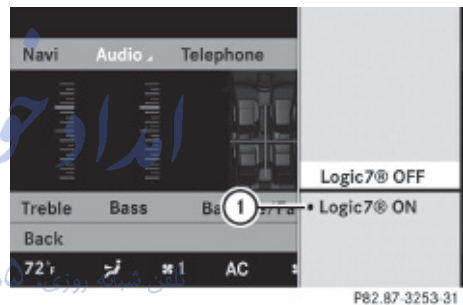

① Current setting

► **Selecting a setting:** Slide  $\uparrow \odot \downarrow$  or rotate  $\leftarrow \odot \rightarrow$ .

► **Saving setting:** Press  $\odot$ .

The setting is saved and the menu is closed.

► **Exiting menu without saving changes:** Press back button  $\leftarrow$  or slide  $\leftarrow \odot \rightarrow$ .

① Please note the following:

- For an ideal sound experience in all seats, the balance and fader should be adjusted to the center of the passenger compartment with Logic7® switched on.
- The best sound results are achieved by playing high-quality audio and video DVDs.
- For MP3 tracks, the bit rate should be at least 128 kbit/s.



- 3-D sound does not work for mono-signal sources, such as on analog AM radio or in Weather Band.
- In the event of poor radio reception quality, e.g. inside a tunnel, you should switch off Logic 7<sup>®</sup>, as a dynamic switch from Stereo to Mono could occur, resulting in temporary sound distortion.
- With some stereo recordings, the resulting sound may deviate from conventional stereo playback.

### Switching the audio/video source off/on

- i** When you load a CD or DVD, the audio or video source is activated automatically.

#### Active audio source

- ▶ **Switching off:** Select Audio → Audio OFF.  
Playback is paused and the audio source is switched off; Audio OFF appears in the COMAND display.
- ▶ **Switching on:** Select Audio, then the desired audio source.

or

- ▶ Load a CD/DVD (▷ page 179) or an SD card (▷ page 180).

or

- ▶ Connect a USB storage device (▷ page 80) or media interface device (▷ page 200) to COMAND.

#### Active video source

- ▶ **Switching off:** Select Video → Video OFF.  
The audio source is switched off; Video OFF appears in the COMAND display.
- ▶ **Switching on:** Select Video, then the desired video source.

or

- ▶ Load a DVD (▷ page 179).

### SPLITVIEW

SPLITVIEW enables the driver and front passenger to use separate COMAND functions at the same time. Two different displays appear in the COMAND screen. For example, a Navigation display is only viewable from the driver's seat while a DVD Video display is only viewable from the front passenger's seat.

COMAND is operated via SPLITVIEW from the front passenger seat using the SPLITVIEW remote control and the special wireless, infrared headphone. You may also use a wired headphone via the 3.5 mm socket in the front passenger footwell.

For information about using the remote control, see (▷ page 81).

For information about using the headphone, see (▷ page 82).

Depending on the production date of your vehicle, it may be equipped with SPLITVIEW. At the time of this printing, the use of SPLITVIEW is NOT allowed in the following US states (AL, AZ, CO, IL, LA, MA, MD, NH, PA, VA, VT, WA, WI, and WV) or Canadian provinces (Manitoba, Newfoundland, New Brunswick, and Prince Edward Island). SPLITVIEW must NOT be operated in these states or provinces. The driver is responsible for observing ALL local statutory provisions. If your vehicle is registered in a non-approved state or province, then the feature will need to be deactivated. Contact your authorized Mercedes-Benz dealer to verify if SPLITVIEW is allowed in your state or province.

### Notes

- The audio volume of the wireless headphone for the front passenger side must be adjusted on the headphone directly. The audio volume of a wired headphone can be adjusted via the remote



control. Make sure the volume is not set too high before putting on a headphone.

- The DVD changer can playback only one media source at a time. Example: if the driver is playing an audio CD, the front passenger can not play a different medium (e.g. DVD video) from the DVD changer. However, it is possible for the front passenger to play media from radio, memory card, MUSIC REGISTER, media interface, USB, AUX or Rear Seat Entertainment System.
- When driver and front passenger are using the same medium, each can select individual settings for that medium.
- COMAND transmits music and voice to the wireless headphone for the front passenger side via infrared signal. The headphone and the display must have visual contact. This provides best possible transmission of the infrared signal to the headphone. Please note that the headphone has a left and right side and must be used accordingly.
- When SPLITVIEW is on, the front passenger can operate audio or video functions only.
- The multifunction steering wheel lets you operate functions for the driver's side only.

### Switching SPLITVIEW on/off

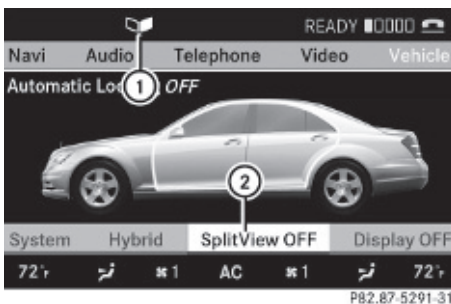

► **Switching on:** Select Vehicle → SplitView ON.

or

► Press the SPLITVIEW remote control ON button.

The SPLITVIEW symbol ① appears and status ② changes to SplitView OFF.

► **Switching off:** Select Vehicle → SplitView OFF.

or

► Press the SPLITVIEW remote control ON button.

Status ② changes to SplitView ON.

The SPLITVIEW screen remains on for approximately 30 minutes after switching off the ignition. After these 30 minutes or once the SmartKey is removed from the starter switch, the settings for the front passenger side remain stored for approximately another 30 minutes.

## COMAND system settings

### System settings submenu overview

**i** The components and operating principles of COMAND can be found on (> page 76).

System settings can be made in the following submenus:

- Display → Day Mode, Night Mode, Automatic
- Time → Time, Date, Format, Time Zone
- Text Reader → Speed → Fast, Medium or Slow:  
Adjusts the reading speed of the Voice Control System.
- Voice Control → Help Window, Start New Individualization, Delete Individualization
- Language: Selecting system language
- Favorites Button \*: Assigning the favorite button

- Bluetooth → Search for Bluetooth Devices, Bluetooth activated. For information on the Bluetooth® interface see (▷ page 151).
- Upload/Download Data → Copy Data to Storage Medium, Import Data from Storage Medium (▷ page 95)
- Reset: Resetting the COMAND system to factory settings

### Display settings

#### Switching the display on or off

- ▶ **Switching off:** Select Vehicle → Display OFF.
- ▶ **Switching back on:** Rotate or slide or press .
- or
- ▶ Press button .

#### Setting the display design

- ▶ Select Vehicle → System → Display.

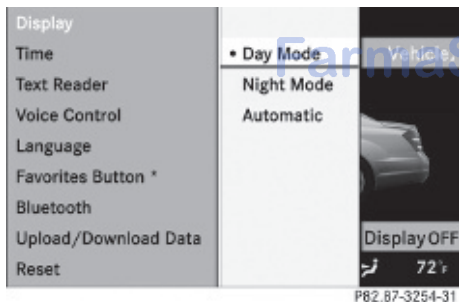

- ▶ Select Day Mode, Night Mode or Automatic.
- i** In the Automatic setting, COMAND sets the display design automatically. The setting depends on the information retrieved from the vehicle's light sensor.

### Time settings

The time of day is set automatically according to the GPS signal and the selected time zone. All time information always applies to the local time at the current vehicle position. Time information changes when entering a different time zone.

- i** The correct time zone, daylight savings time/standard time and the time itself must be set for the following navigation system functions to operate correctly:
  - Route guidance on routes with time-dependent traffic guidance
  - Calculation of estimated arrival time

The settings are adopted for the analog clock in the dashboard.

Change the settings in the following order:

1. Time zone
2. Daylight savings time/standard time
3. Time lag (only necessary in exceptional cases)

#### Setting the time zone and switching between daylight savings time and standard time

- ▶ **Setting time zone:** Select Vehicle → System → Time → Time Zone. The country list appears. The dot • in front of a list entry indicates the current setting.
- ▶ Select the country in which you are. A time zone list may also be displayed, depending on the selected country.
- ▶ Select the desired time zone.

Subsequent operation depends on

- whether your navigation system has GPS reception
- which country you have set previously

You may either switch between Daylight Savings Time (Summer) and Standard Time.

- ▶ Select Daylight Savings Time (Summer) or Standard Time.  
The dot • in front of a list entry indicates the current setting.
- ▶ **Saving setting and exit the menu:** Slide ←○→.

### Adjusting time lags

- ▶ **i** In some exceptional cases, e.g. where time zones border, the displayed time and the local time may show a time lag.  
This time lag can be adjusted in steps of 30 minutes.
- ▶ Select Vehicle → System → Time → Time.
- ▶ **Selecting hour or minutes:** Slide ←○→.
- ▶ **Setting value:** Rotate (○) or slide ↑○↓.
- ▶ **Saving setting:** Press (○).

### Setting the date

- ▶ Select Vehicle → System → Time → Date.
- ▶ **Selecting month, day, or year:** Slide ←○→.
- ▶ **Setting value:** Rotate (○) or slide ↑○↓.
- ▶ **Saving setting:** Press (○).
- ▶ **i** Setting the date is only necessary or even possible if the COMAND system does not receive a GPS signal.

### Setting the time/date format

- ▶ Select Vehicle → System → Time → Format.  
The format list appears. The dots • in front of the list entries indicate the current setting.
- ▶ **Changing format setting:** Select desired format.
- ▶ **Saving setting and exit the menu:** Slide ←○→.

### Voice Control System settings

#### Switching help window on or off

- ▶ Select Vehicle → System → Voice Control.
- ▶ Select Help Window.  
A checkmark appears when the help window is switched on.

#### Individualization

Using individualization, you can fine-tune the Voice Control System to your own voice and thus improve voice recognition. The ability of the system to recognize the commands of other users does not deteriorate as a result. Individualization consists of two parts. You train the system to recognize digits in the first part and specific commands in the second part.

#### Starting new individualization

- ▶ **i** The vehicle must be stationary to start individualization. After starting the session, acoustic instructions will guide you through the individualization.
- ▶ Select Vehicle → System → Voice Control → Start New Individualization.  
A prompt appears asking whether you would like further information.
- ▶ Select Yes or No.  
If you select No, the first part of individualization begins.  
If you select Yes, an information display will be shown with audio instruction.
- ▶ **Closing display:** Select OK.  
The first part of individualization begins.  
At the end of the first part, you will see a prompt asking whether you want to begin the second part.
- ▶ Select Yes or No.  
If you select No, individualization will be canceled. The data from the first part is saved automatically.

If you select Yes, the second part begins. Individualization is completed at the end of the second part. You will see a message to this effect. The data from the second part is saved automatically.

### Canceling during the first or second part of individualization

- ▶ Select **Cancel**.  
A prompt appears asking whether you really do want to cancel.
- ▶ Select **Yes** or **No**.  
If you select Yes, individualization will be canceled. The data from the part at which you exited is not saved.  
If you select No, the part at which you stopped begins again.

### Deleting existing individualization data

- ▶ Select **Vehicle** → **System** → **Voice Control** → **Delete Individualization**.  
A prompt appears asking whether you really do want to delete.
- ▶ Select **Yes** or **No**.  
The individualization data will either be deleted or not, depending on your selection.

### Setting the system language

- ▶ Select **Vehicle** → **System** → **Language**.  
The language list appears. A dot • indicates the current setting.
- ▶ **Changing setting:** Select the desired language.  
The language is set.

**i** For some system languages, the navigation announcements are made in English (▷ page 135).

### Assigning the favorite button



You can assign the following predefined functions to favorite button \*:

- **Driver's Seat Massage** (▷ page 219)  
You can switch the massage function for the driver's seat on or off.
- **Front Passenger Seat Massage** (▷ page 219)  
You can switch the massage function for the passenger seat on or off.
- **Driver and Front Passenger Seat Massage** (▷ page 219)  
You can switch the massage function for the driver's and passenger seat on or off.
- **Display OFF** (▷ page 92)  
You can use the favorite button to switch the COMAND display on or off.
- **Repeat Navigation Command** (▷ page 135)  
When route guidance is activated, you can use the favorite button to generate or call up a current navigation announcement.
- ▶ Select **Vehicle** → **System** → **Favorites Button** \*.  
The list of predefined functions appears. The dot • in front of the list entry indicates the current setting.
- ▶ **Changing setting:** Rotate **⏪** and select desired function.
- ▶ **Saving setting and exiting the menu:** Press **⏩**.

## Upload/Download of Data

This function lets you transfer COMAND data to a memory card or a USB storage device and vice versa.

The following COMAND data can be transferred:

- Navigation destination memory and last destination
  - Address book entries
  - Audio/Video presets memory
  - System settings
- i** You can use this function, for example, to save your COMAND data and transfer them to another vehicle.
- ▶ Insert an SD card into the SD card slot (> page 180) or connect a USB storage device to the built-in USB socket in the glove box (> page 80). The USB jack of the optional media interface is not intended for this purpose.
  - ▶ Select Vehicle → System → Upload/Download Data.
  - ▶ **Download:** Select Copy Data to Storage Medium → On the Memory Card or On USB.
  - ▶ Select Start Copying.
  - ▶ **Upload:** Select Import Data from Storage Medium → From Memory Card or From USB.
  - ▶ Select Start Data Import.
  - ▶ **Exiting menu without data transfer:** Select Back.

## Reset

- i** You can reset COMAND back to its factory settings.

Among other things, all personal data are deleted, for example

- the address book entries
- the entries in the destination memory
- the list of last destinations of the navigation system

- ▶ Select Vehicle → System → Reset. A prompt appears asking whether you really want to reset.
- ▶ Select Yes or No. If you select Yes another prompt will appear asking whether you really want to reset.
- ▶ Select Yes or No. If you select Yes, COMAND will be reset and restarted.

## COMAND navigation (introduction)

### Safety notes

#### Warning!

For safety reasons, only enter a destination when the vehicle is stationary. When the vehicle is in motion, a passenger should enter the destination. Study manual and select route before driving.

Bear in mind that at a speed of just 30 mph (approximately 50 km/h), your vehicle is covering a distance of 44 feet (approximately 14 m) every second.

COMAND calculates the route to the destination without taking account of the following, for example:

- Traffic lights
- Stop and right-of-way signs
- Parking or stopping in prohibited areas
- Lane merging
- Other road and traffic rules and regulations
- Narrow bridges

COMAND may give incorrect navigation commands if the data in the digital map does not correspond with the actual road or traffic situation. Maps do not cover all areas nor all routes within an area. For example, if the traffic routing has been changed or the direction of a one-way road has been reversed.

For this reason, you must always observe applicable road and traffic rules and regulations during your journey. Road and traffic rules and regulations always have priority over the navigation commands generated by the system.

### **Warning!**

Navigation announcements are intended to direct you while driving without diverting your attention from the road and driving.

Please always use navigation announcements instead of consulting the map display for directions. Consulting the symbols or map display for directions may cause you to divert your attention from driving and increase your risk of an accident.

### **Map software**

The digital maps generated by the map software become outdated in the same way as conventional road maps. Optimum route guidance can only be provided by the navigation system in conjunction with the latest map software. Information about new map software versions can be obtained from an authorized Mercedes-Benz Center.

### **Displaying installed map version**

► Navi → Map Version

The installed map version is displayed.

For information on installing new map software see (► page 96).

### **Installing the map software**

Your vehicle is factory-equipped with map software for the USA (including Alaska and Hawaii), Canada, the U.S. Virgin Islands, and Puerto Rico.

You can install new map software from one or more DVDs, depending on the size of the map software.

### **Copy protection of map software**

COMAND map software is subject to charges. The map software requires an activation code. The map software can be used for one individual vehicle only and is non-transferrable. The six-digit activation code is available at any authorized Mercedes-Benz Center. Contact an authorized Mercedes-Benz Center in case you have lost your activation code or when the COMAND system does not accept the activation code you have received.

When reinstalling a map software that has been installed in that vehicle already, an activation code is not required.

### **Installation process**

 The installation process can take between 10 and 120 minutes, depending on the size of the map software. If the radio is switched on when you start the installation process, you can still adjust the volume. During the installation process, some COMAND functions are suspended. Still available are the COMAND functions for automatic air conditioning operation and canceling the installation process.

If possible, carry out the installation when the vehicle is stationary. When the vehicle is stationary, the reading rate of the DVD drive is higher than in a moving vehicle and the installation process requires less time.

 **Observe Safety notes, see page 76.**

 COMAND may switch off during the installation process automatically in order

to protect the battery. This may happen when the engine is switched off and the vehicle battery has insufficient power. If this occurs, restart the installation with the engine running. Similarly, if the SmartKey position is unintentionally switched to **0**, restart the installation.

### **Warning!**

Inhalation of exhaust gas is hazardous to your health. All exhaust gas contains carbon monoxide (CO), and inhaling it can cause unconsciousness and lead to death. Do not run the engine in confined areas (such as a garage) which are not properly ventilated.

## Installing

Notes about handling DVDs (▷ page 179).

- ▶ Load the map software DVD into the DVD changer (▷ page 179).  
The COMAND system verifies the DVD and a respective message appears in the COMAND display.

### **Map software incompatible with navigation system**

A message indicates that installation of the map software is not possible.

- ▶ **Confirming message:** Press .  
The DVD is ejected.
- ▶ Remove the DVD from the slot.
- ▶ Insert a DVD that is compatible with the navigation system of the vehicle.

### **Map software incompatible with the current system software**

A message indicates that the system software and the map software are incompatible.

- ▶ **Confirming message:** Press .  
The DVD is ejected.

- ▶ Remove the DVD from the slot.

- ▶ Have the system software updated at an authorized Mercedes-Benz Center.

The system software must be updated before you can install the map software.

### **Map software compatible with navigation software and current system software**

The COMAND system verifies whether the map data on the DVD have been installed already.

#### **Map data installed already**

A message that indicates that the map data have been installed already appears. Also, you are being asked if you would like to install the map software anyhow.

- ▶ Select Yes or No.  
When you select Yes, the current map data will be overwritten.  
When you select No, the DVD will be ejected automatically and the installation process is cancelled.
- ▶ Remove the DVD from the slot.

#### **Map data not installed yet**

The versions of the map software on the DVD and of the installed map software appear in the COMAND display. You are then asked if you want to install the map software.

- ▶ Select Yes or No.  
When you select Yes, the map data will be installed.  
When you select No, the DVD will be ejected automatically and the installation process is cancelled.
  - ▶ Remove the DVD from the slot.
- When an activation code is required, you will be prompted to enter it.





- ▶ Enter the activation code and confirm by pressing **ok**.

Installation of the map software starts.

When you enter an invalid activation code, you are prompted to reenter the activation code. After entering an invalid activation code for the third time, the prompt for reentering the activation code will be delayed. The delay increases by 5 minutes each time an invalid activation code is entered to a maximum delay of 5 hours.

### Map software installation

Immediately before installation, the COMAND system reboots.

A corresponding message and a progress bar appear during the installation process.

#### ▶ **Canceling installation on the DVD**

**changer:** Press the respective magazine tray button.

- ▶ Remove the DVD from the slot.

**i** When you cancel the installation, the navigation system will be inoperative. You can resume a canceled installation at a later time.

#### ▶ **Installation of multiple DVD map**

**software:** After installation of the first DVD, a message appears that prompts you

to insert the next DVD. Follow the instructions on the COMAND display.

- ▶ **Continue installation without canceling:** Let the installation continue without pressing any buttons. When the installation has been completed, a corresponding message appears.

- ▶ **Confirming message:** Press . The DVD is ejected.

- ▶ Remove the DVD from the slot. The installation is finished.

When the installation has been completed successfully, a corresponding message appears.

- ▶ **Confirming message:** Press . The DVD is ejected.

- ▶ Remove the DVD from the slot.

If the installation was unsuccessful:

- The DVD is dirty or scratched.
  - ▶ Clean the DVD (▷ page 179).
  - ▶ Start the installation of the map software once more.
- The system may be overheated due to excessive temperature in the vehicle interior.
  - ▶ Wait until the vehicle interior has cooled.
  - ▶ Start the installation of the map software once more.
- If these measures do not solve the problem:
  - ▶ Contact an authorized Mercedes-Benz Center.

### General notes

#### Operational readiness of the navigation system following a system software update by an authorized Mercedes-Benz Center

After a system software update by an authorized Mercedes-Benz Center, the installed map software may no longer be



compatible. If this is the case, the navigation system will not be operational.

You will know if this is the case, when the following message will appear when you switch to navigation mode: The system software has been updated. The map software must be updated now. Please insert the DVD with the map software.

► **Updating map software:** Proceed as described in the “Updating the map software” section (► page 96). Use map software which is compatible with the system software.

**i** Please note that the update must be allowed to run to the end in this case. If you interrupt it, the navigation system will continue to be non-operational.

### **Initial use or use following a system software update**

In both these cases, the navigation system must determine the position of the vehicle. You may have to drive for a while before precise route guidance is possible.

### **GPS reception**

The Navigation system relies on a number of factors to function correctly. GPS reception is very important.

In certain situations GPS may be impaired, for example:

- in tunnels
- in parking garages
- due to snow on the GPS antenna

If there is snow on the GPS antenna, you should remove it. The GPS antenna is at the back of the vehicle roof.

A roof cargo container may also impair GPS coverage.

### **Route guidance after transporting the vehicle or exiting a parking garage**

COMAND has to redetermine the position of the vehicle if the vehicle has been transported (e.g. by ferry, by train or after towing).

COMAND may also have to redetermine the vehicle position when leaving a parking garage.

The proper position of the vehicle will even be found if you are driving with COMAND switched off. The duration of the positioning recalculation will vary case by case.

During positioning, route guidance may be inaccurate and may show the following:

- Navigation announcements, route guidance displays and displayed street names are not consistent with the actual location of the vehicle.
- COMAND does not generate navigation announcements.
- Instead of the route guidance displays, you see the Off Road display and a direction arrow. The direction arrow shows the compass heading to the destination.

After the vehicle position has been redetermined, route guidance with navigation announcements and route guidance display is available again.

### **Interrupting the journey during route guidance**

The following applies if you interrupt the journey during route guidance and continue the journey later:

- COMAND resumes route guidance automatically if you continue the journey within 2 hours.
- Route guidance is canceled if you continue the journey after more than 2 hours. It will be necessary to resume the canceled route guidance manually (► page 135).

**i** The journey is interrupted if you park the vehicle and switch off COMAND. The

journey is continued when you switch COMAND back on and start driving.

### Hard disk errors

COMAND has an integrated hard disk on which the map software is stored.

If the message Navigation Unavailable. Please refer to the operating instructions. appears:

- ▶ Switch the COMAND off.
  - ▶ Switch the COMAND back on.
- i** If the message appears again, contact an authorized Mercedes-Benz Center.

### Units of measurement

The units of measurement in navigation mode are identical to those set in the instrument cluster (▷ page 235). The units of

measurement can only be changed via the instrument cluster control system.

### Input restrictions

There is an input restriction for vehicles in certain countries.

The restriction is active for vehicle speeds above approximately 3 mph (5 km/h). The restriction is deactivated as soon as the speed falls below approximately 2 mph (3 km/h).

Certain entries cannot be made when the restriction is active.

This is indicated by the fact that certain menu items cannot be selected, e.g. entering a destination via map.

### Navigation submenu overview

- i** The components and operating principles of COMAND can be found on (▷ page 76).

Info (only with route guidance active)	Traffic	Route	Position	RPT (only with route guidance active)	Destination
Information about the active route guidance	Calling up real-time traffic messages	<ul style="list-style-type: none"> <li>• Displaying detour function</li> <li>• Displaying alternative route</li> <li>• Displaying symbol information</li> <li>• Displaying route information</li> </ul>	<ul style="list-style-type: none"> <li>• Saving vehicle position</li> <li>• Calling up "Where am I?" function</li> <li>• Centering map on vehicle position</li> <li>• Centering map on destination</li> <li>• Centering map on stopover</li> <li>• Displaying compass</li> </ul>	Calling up a current navigation announcement	<ul style="list-style-type: none"> <li>• Entering destination or stopover</li> <li>• Saving destination</li> <li>• Suspending or continuing route guidance</li> </ul>

FarmaSOS.com

### Calling up the map display and switching to navigation mode

- ▶ In the main function line, select **Navi**.
- or
- ▶ Press shortcut button  once or twice.

**i** The number of times you have to press shortcut button  depends on the operating mode currently selected. Both of these actions will call up the map display. You will see the map with the menu system either shown or hidden.



Example illustration: Map with route guidance inactive and with the menu system shown

- ① Current vehicle position



Example illustration: Map with route guidance inactive and with the menu system hidden (full screen map display)

- ① Current vehicle position
- ② Map orientation (▷ page 103)
- ③ Map scale (▷ page 102)

### Hiding or showing the menu system

- ▶ **Hiding:** Slide . The Full Screen menu item appears in the main area of the display.
- ▶ Press . or
- ▶ Press and hold back button in the center console (▷ page 87). The menu system is hidden. The map can be seen in the full screen.
- ▶ **Showing:** Press in the full-screen map display.

### Adjusting the map scale

- ❗ It is only possible to adjust the map scale with the menu system hidden (full-screen map display).
- ▶ Rotate until the desired map scale is set.



- ① Currently set map scale as number
- ② Scale
- ③ Pointer indicating the currently set map scale
- ④ Previously set value (only visible when the setting has been changed)

As soon as you rotate , scale ② appears. Rotating clockwise zooms out, rotating counterclockwise zooms in.

### Saving current vehicle position as destination in last destinations list

- ▶ **Showing menu system, if necessary:** Press .
- ▶ **Saving:** Select Position → Store Vehicle Position. COMAND saves the current vehicle position as a destination in the last destinations (▷ page 147).
- ❗ The cross hair may not be visible when using this function. Otherwise the position of the cross hair will be stored.

### Moving the map

- ❗ It is only possible to move the map with the menu system hidden (full-screen map display).
- ▶ Slide , or . A cross hair appears on the map.



- ① Cross hair
  - ② Details of the cross hair position
  - ③ Map scale
- i** Display ② may be the name of a road or a road icon, for example, provided the digital map contains the necessary data. If no data is available, display ② shows:
- the coordinates of the cross hair if the Geo Coordinates display is switched on (▷ page 105) and the GPS signal is strong enough
  - no display if the Geo Coordinates display is switched off (▷ page 105)

### Saving cross hair position as destination in last destinations list

- ▶ **Showing menu system, if necessary:** Press .
- ▶ **Saving:** Select Position → Save Crosshair Position. COMAND saves the cross hair position as a destination in the last destinations list (▷ page 147).

### Hiding the cross hair

- ▶ Press back button  in the center console (▷ page 87). The cross hair disappears and the map is centered on the vehicle position.
- or
- ▶ Set the map to the vehicle or destination position, see the explanation below.

### Centering the map on the vehicle, destination or stopover position

**i** If you have moved the map, you can use this function to rapidly return the map to the position of the vehicle or destination. It is only possible to center the map on the destination position when route guidance is active.

- ▶ **Centering on the vehicle's position:** Select Navi → Position → Vehicle Position Map.
- or
- ▶ Press back button  when the cross hair is displayed.
  - ▶ **Centering on the destination:** Select Navi → Position → Destination Map.
  - ▶ **Centering on a stopover:** Select Navi → Position → Stopover Map.

### Basic settings

**i** You can make the following settings regardless of whether route guidance is active or inactive.

### Map orientation



The following orientations are available:

- North Up: Map display ① is oriented to the North; the North is always at the top of the map.
- Heading Up: Map display ② is oriented in the direction into which you are heading; the direction into which you are heading is always at the top of the map; the orange tip of the symbol points to the North.

- Bird's-eye View: Map display ① is oriented in the direction into which you are heading; the orange tip of the symbol points to the North.
- 3-D Map: Certain buildings in selected cities are displayed in detail as a 3-D (three-dimensional) model. The map displays mountains and valleys three-dimensionally. The 3-D map is country-specific and is connected with the function City (3D) (▷ page 105).
- ▶ **Selecting map orientation:** Select Navi → Map Orientation. The list of available map orientations appears. The dot ● indicates the currently selected map orientation.
- ▶ Select North Up, Heading Up, Bird's-eye View, or 3-D Map and press ⏺.
- ▶ **Exiting menu:** Slide ←⊙→.
- ▶ **Adjusting:** Select Navi → POI Symbols on Map. The map display list appears. A dot ● indicates the current setting.
- ▶ Select Standard symbols, Personal symbols or No symbols. If you select Personal symbols, the list of POIs appears.
- ▶ **Switching POI symbol display on or off:** Select the desired POI. The corresponding symbol displays are switched on or off, depending on the previous status. A checkmark indicates which status is active. You can switch on the symbol displays for more than one POI.

**i** The list shows all symbols that are contained in the digital map across all states (USA) and provinces (Canada). Not all POIs in all states (USA) or in all provinces (Canada) are available, however. Certain POI symbols may not be displayed on the map, even if the symbol display is switched on. You can use this list as a map legend. The map legend also contains, in addition to the POI symbols, the names of the POI categories.

### Setting POI symbols

You can set which points of interest (POIs) should be displayed as symbols in the map. POIs are parking facilities, hotels, restaurants or movie theaters, for example.

- i** Depending on the map scale, POI symbols may not be visible although their display is activated. In addition, POI symbols may be covered by other POIs or names displayed on the map.

The following settings are possible:

- Standard symbols (factory setting)
- Personal symbols (you can select the desired POIs)
- No symbols

- ▶ **Exiting menu:** Slide ←⊙→ or press back button  in the center console (▷ page 87).

### Selecting traffic symbols on the map

You can select what kind of traffic information is displayed on the map (▷ page 139).

### Selecting text information on the map

COMAND can display various text information below the map:

- Time of arrival and distance to destination
- Current street
- Geo coordinates
- None

- ▶ **Calling up menu:** Select Navi → Text Information on Map.  
The list of available text information appears. The dot ● indicates the currently selected setting.
- ▶ **Exiting menu:** Slide ←⊙→.

### Time of arrival and distance

- ▶ Select Arrival Time/Distance.  
The time of arrival and the distance for the main destination are displayed by setting the dot to Arrival Time/Distance.

### Current street

- ▶ Select Current Street.  
The street you are currently on is displayed by setting the dot to Current Street.

### Geo coordinates

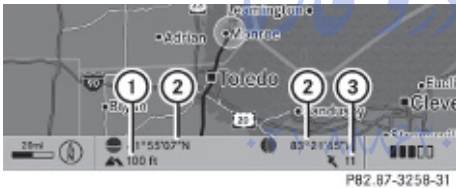

- ① Altitude
- ② Geo coordinates
- ③ Number of receivable GPS satellites

- ❗ GPS reception must be sufficient in order to display ①, ② and ③. The displayed altitude ① may differ from the actual altitude as the navigation system uses the GPS signals to compute the value.

### Display options with geo coordinates selected

When the map shows the cross hair (map has been moved manually), only geo coordinates ② are displayed. In this case, the geo coordinates of the cross hair or other data for the cross hair position such as a street name are displayed. Such data can only be displayed when the digital map contains that particular data.

- ❗ When the map does not show the cross hair, ①, ② and ③ are displayed. Geo coordinates ② will then indicate the current vehicle position.

- ▶ Select Geo Coordinates.  
The geo coordinates are displayed by setting the dot to Geo Coordinates.

### None

- ▶ Select None.  
The text information below the map is hidden by setting the dot to None.

### Topographical map

The map can be displayed as a topographical map. Varying terrain levels can be recognized by the different shades of colors. The color shades are available for map scales of 10 mi - 500 mi (10 km - 500 km).

- ▶ Select Navi.
- ▶ Check the check box for menu item Topographical Map.

### City model

You can display selected cities three-dimensionally when the map orientation is set to 3-D map (▷ page 103).

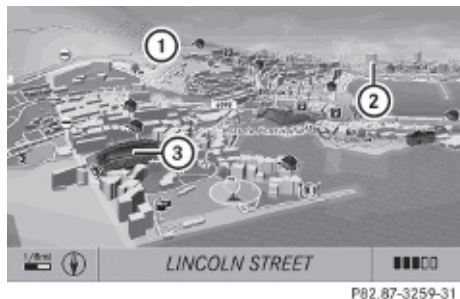

- ① Mountains
- ② Buildings
- ③ Landmark buildings



- ▶ Select Navi.
- ▶ Check the check box for menu item City (3D).

### Setting route type

You can set the following route types:

- **Fast Route:** COMAND calculates a route with minimized driving time.
  - **Dynamic Route:** COMAND calculates a route with minimized driving time and takes into account traffic messages received along the route. Thus, the navigation system can dynamically recalculate the route. Roads that are blocked will be avoided whenever possible. For information on traffic messages see (▷ page 138).
  - **Short Route:** COMAND calculates a route with minimized route length.
- ▶ Select Navi → Mode.  
The list of available route types appears. The dot • indicates the currently selected setting.
  - ▶ **Select route type:** Fast Route, Dynamic Route or Short Route.
  - ▶ **Exit menu:** Slide ←⊙→.

**i** If you change the route type setting during active route guidance, COMAND calculates a new route. If you change the setting when route guidance is inactive, COMAND uses the new setting for the next route guidance.

### Setting route mode

With this function you can select the following options for route calculation:

- Minimize Highways
- Minimize Toll Roads
- Minimize Tunnels
- Minimize Ferries
- Minimize Motorail Trains

- ▶ Select Navi → Mode.  
The mode list appears.
- ▶ **Switching mode on or off:** Select desired modes.  
Depending on the previous status, the mode is switched on or off. A checkmark indicates that the mode is switched on. It is possible to switch on more than one mode.
- ▶ **Exiting menu:** Slide ←⊙→ or press back button  in the center console (▷ page 87).  
COMAND will verify whether it can incorporate the modes if you select them with route guidance active.  
If possible, COMAND calculates a new route considering the selected options.  
If the route cannot be recalculated with the selected options, a message appears and an announcement is made. COMAND calculates a new route. Only options that are possible will be considered.

### Displaying highway information

When this function is enabled, highway information ahead will display automatically (▷ page 137).

### Audio fadeout

- ▶ Select Navi → Audio Fadeout.  
When the check box is checked  the volume of the current audio source fades during a navigation announcement.

## COMAND navigation system (entering a destination)

### Introduction

#### **Warning!**

For safety reasons, only enter a new destination when the vehicle is stationary.



- i** It is possible to enter a destination regardless of whether route guidance is active or not.

The following destination entry options are available:

- By address
- From the destination memory
- From a list of last destinations
- From a point on the map
- A stopover
- A POI

### Entering a destination by address

#### Introduction

- i** It is not possible to enter an address when the vehicle has exceeded a certain speed. As soon as the vehicle speed drops below a certain value, the function is available again.
- i** If Russian or Chinese is set as the system language, the address must be entered using Latin characters. Setting the system language (> page 94).

To enter an address you may proceed as follows:

- Enter state (USA) or province (Canada), street and city
- Enter state (USA) or province (Canada), city and street
- Enter state (USA) or province (Canada), city and city center
- Enter state (USA) or province (Canada), zip code/postal code and city center
- Enter state (USA) or province (Canada), zip code/postal code and street
- i** As additional information to the street entry, you can enter either a house number or an intersection.

A zip code/postal code entry replaces the city entry.

#### Calling up the address input menu

- ▶ Select Navi → Destination → Address Entry.

The address input menu appears. It shows a state (USA) or a province (Canada), the vehicle is currently located at.



- ① State (USA) or province (Canada)

#### Menu items in the address input menu

Some menu items may not or not yet be available, depending on the sequence in which you enter the address and the data version.

Example: If you have not made any entries, menu items No., Center, Intersection, POI, Start and Save will not yet be available.

#### Entering a state (USA)

- ▶ In the address input menu, select State/Prov. → States (U.S.).  
A list of states appears with the predictive speller.

## List of states with predictive speller

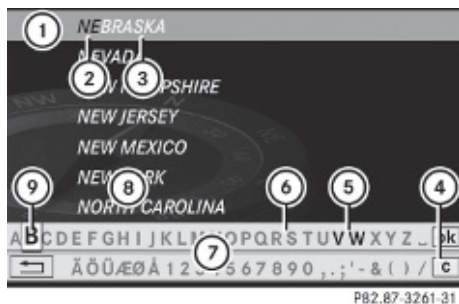

- ① Top list entry based on the input data up to that point
- ② Characters entered by the user
- ③ Characters automatically added by the system
- ④ Clear last character entry
- ⑤ Currently selectable characters
- ⑥ Currently non-selectable characters
- ⑦ Predictive speller
- ⑧ List of states
- ⑨ Currently selected character

**i** In the predictive speller ⑦, you can only select currently selectable characters. Which characters are included depends on the sequence in which you have entered your destination and the digital map.

While the numbers are being selected as described below, the top list entry ① always shows the state which best matches to the input data as it has been entered up to that point.

At the same time, COMAND automatically adds matching characters ③ to the characters ② already entered by the user.

- ▶ **Selecting characters:** Slide ←→ or rotate [⊙].
- ▶ **Confirming character selection:** Press ⊙.

- ▶ **Deleting individual characters:** Select [c] in the bottom line and press ⊙.
  - ▶ **Deleting an entire entry:** Select [c] in the bottom line and press ⊙ and hold until the entire entry is deleted.
  - ▶ **Canceling an entry:** Select [↩] in the bottom line and press ⊙.
- or
- ▶ Press back button [↩] in the center console (▷ page 87).

As soon as COMAND can clearly attribute the characters entered to a state, predictive speller ⑦ disappears automatically. You see the list of states without the predictive speller. Here you can confirm the current entry or make another selection.

During character entry, you can also manually switch to the list of states without the predictive speller at any time.

- ▶ **Switching manually to list of states without predictive speller:** Slide ↑⊙.

- or
- ▶ Select [ok] in the second line from the bottom and press ⊙.

## List of states without predictive speller

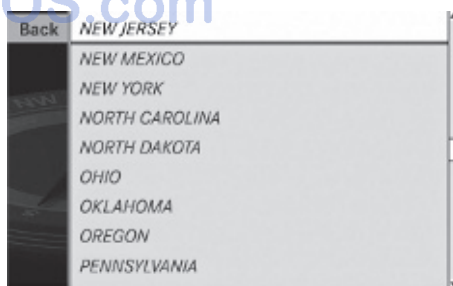

P82.87-2295-31

► **Selecting a state:** Slide or rotate .

► **Canceling selection:** Select Back by sliding and press .

or

► Press back button in the center console (▷ page 87).

► **Confirming selection:** Press .

The address input menu appears again. It shows the abbreviation for the selected state.

The following menu items are now available:

- Map: Entering a destination from the map (▷ page 122)
  - State/Prov.: Change state (USA) or province (Canada)
  - City: Entering a city (▷ page 111) within the selected state
  - Street: Entering a street (▷ page 114) within the selected state
  - Zip Code: Entering the zip code (▷ page 109) within the selected state
- **Continuing destination entry:** Select one of the menu items mentioned above.

### Entering a province (Canada)

► In the address input menu, select State/Prov. → Provinces (Canada).

A list of provinces appears.

► Select desired province.

The address input menu appears again. It shows the abbreviation for the selected province.

The following menu items are now available:

- Map: Entering a destination from the map (▷ page 122)
- State/Prov.: Change state (USA) or province (Canada)
- City: Entering a city (▷ page 111) within the selected province

• Street: Entering a street (▷ page 114) within the selected province

• Zip Code: Entering the postal code (▷ page 109) within the selected province

► **Continuing destination entry:** Select one of the menu items mentioned above.

### Quick access to most recently entered states (USA) or provinces (CDN)

► In the address input menu, select State/Prov. → Last States/Provinces.

The list of most recently entered states (USA) or provinces (Canada) appears. The last entry is at the top of the list.

► Select desired state (USA) or desired province (Canada).

The address input menu appears again. It shows the abbreviation for the selected state (USA) or province (Canada).

The following menu items are now available:

- Map: Entering a destination from the map (▷ page 122)
- State/Prov.: Change state (USA) or province (Canada)
- City: Entering a city within the selected state (USA) province (Canada) (▷ page 111)

• Street: Entering a street within the selected state (USA)/province (Canada) (▷ page 114)

• Zip Code: Entering the zip code/postal code within the selected state (USA)/province (Canada) (▷ page 109)

► **Continuing destination entry:** Select one of the menu items mentioned above.

### Entering the zip code/postal code

**i** It is not possible to enter a zip code/postal code if you have already entered other address data aside from the state (USA) or province (Canada).

You can only enter those zip codes/postal codes which are saved on the digital map. The available zip codes/postal codes depend on the state (USA) or province (Canada) currently entered.

- ▶ In the address input menu, select Zip Code. A list of zip codes/postal codes appears with the predictive speller.

#### List of zip codes/postal codes with predictive speller

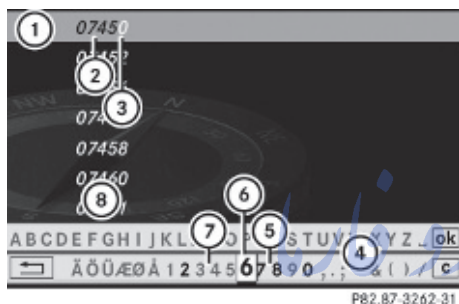

- ① Top list entry based on the input data up to that point
- ② Digits entered by the user
- ③ Digit automatically added by the system
- ④ Predictive speller
- ⑤ Currently selectable digits
- ⑥ Currently selected digit
- ⑦ Currently non-selectable digits
- ⑧ List of zip codes/postal codes

- i** In predictive speller ④, you can only select digits which can be currently entered. Which characters are included depends on the sequence in which you have entered your destination and the digital map.

While the digits are being selected as described below, the top list entry ① always shows the zip code/postal code which best matches to the input data as it has been entered up to that point.

At the same time, COMAND automatically adds digits ③ to the digits ② already entered by the user.

- ▶ **Selecting digits:** Slide  $\leftarrow \odot \rightarrow$  or rotate  $\left[ \odot \right]$ .

or

- ▶ Enter digits with the telephone keypad using buttons  $\left[ 0 \right]$  -  $\left[ 9WXYZ \right]$  (> page 79).

- ▶ **Confirming digit selection:** Press  $\odot$ .

- ▶ **Deleting individual digits:** Select  $\left[ c \right]$  in the bottom line and press  $\odot$ .

- ▶ **Deleting an entire entry:** Select  $\left[ c \right]$  in the bottom line and press  $\odot$  and hold until the entire entry is deleted.

- ▶ **Canceling an entry:** Select  $\left[ \leftarrow \right]$  in the bottom line and press  $\odot$ .

or

- ▶ Press back button  $\left[ \leftarrow \right]$  in the center console (> page 87).

As soon as COMAND can clearly attribute the digits entered to a zip code/postal code, predictive speller ④ disappears automatically. You see the list of zip codes/postal codes without the predictive speller. Here you can confirm the current entry or make another selection.

During character entry, you can also manually switch to the list of zip codes/postal codes without predictive speller at any time.

- ▶ **Switching manually to list of zip codes/postal codes without predictive speller:** Slide  $\uparrow \odot$ .

or

- ▶ Select  $\left[ ok \right]$  in the second line from the bottom and press  $\odot$ .

### List of zip codes/postal codes without predictive speller

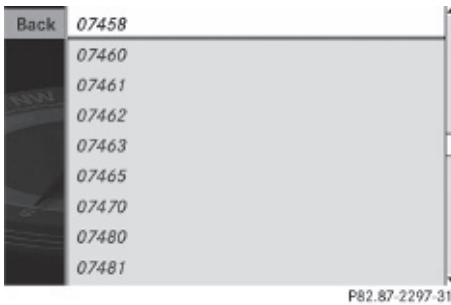

► **Selecting a zip code/postal code:** Slide  $\uparrow$   $\downarrow$  or rotate  $\left\{ \begin{array}{l} \odot \\ \ominus \end{array} \right\}$ .

► **Canceling selection:** Select Back and press  $\odot$ .

or

► Press back button  $\leftarrow$  in the center console (► page 87).

► **Confirming selection:** Press  $\odot$ .

You will see the address input menu again.

It shows one of the following items of information:

- City, state (USA) or province (Canada) and zip code/postal code
- State (USA) or province (Canada) and zip code/postal code

Which of the following menu items are now available depends on the already entered destination information and the digital map. The menu items which are not available cannot be selected.

- Map: Using the map to enter a destination (► page 122)

**i** In this case, using the map for destination entry is based on the city seen in the address input menu.

- Street: Entering a street (► page 114) within the selected state (USA)/province (Canada) and zip coder area

- Center: Entering a center (► page 116) within the selected state (USA)/province (Canada) and zip coder area

- POI: Entering a point of interest (► page 124) within the selected state (USA)/province (Canada) and zip coder area

**i** In this case, entering a POI is based on the city seen in the address input menu.

- Save: Saving a destination in the destination memory (► page 145)

- Start: Starting the route calculation (► page 120)

► **Continuing or completing destination entry:** Select one of the menu items mentioned above.

### Entering a city

**i** You can only enter cities which are available on the digital map.

It is not possible to enter a city when you have already entered a street which is available in one city only. In that case, COMAND takes this city automatically. If a street is available within several cities, COMAND offers a list of those cities. If you start your destination entry with the city, all cities within the selected state (USA)/province (Canada) are available.

► In the address input menu, select City. The list of cities appears.

## List of cities with predictive speller

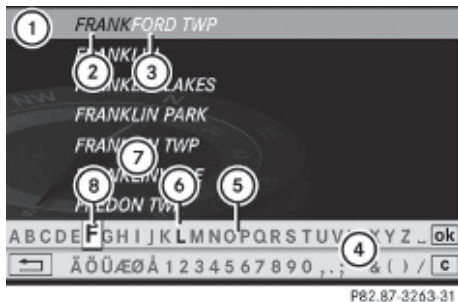

- ① Top list entry based on the input data up to that point
- ② Characters entered by the user
- ③ Characters automatically added by the system
- ④ Predictive speller
- ⑤ Currently non-selectable characters
- ⑥ Currently selectable character
- ⑦ List of cities
- ⑧ Currently selected character

**i** In predictive speller ④, you can only select currently selectable characters. Which characters are included depends on the sequence in which you have entered your destination and the digital map.

The top list entry ① at first shows either the city in which the vehicle is currently located or the city which best corresponds to the input data as it has been entered up to that point.

**i** The current city is shown as first list entry if you have accepted the state or province the vehicle is currently located in.

As soon as you enter a character from predictive speller ④, the top list entry ① shows the city that best matches to the input data as it has been entered up to that point. At the same time, COMAND automatically adds matching characters ③ to characters ② already entered by the user.

► **Selecting characters:** Slide ←○→ or rotate [○].

► **Confirming character selection:** Press [OK].

► **Deleting individual characters:** Select [C] in the bottom line and press [OK].

► **Deleting an entire entry:** Select [C] in the bottom line and press [OK] and hold until the entire entry is deleted.

► **Canceled an entry:** Select [↩] in the bottom line and press [OK].

or

► Press back button [↩] in the center console (> page 87).

As soon as COMAND can clearly attribute the characters entered to a city, predictive speller ④ disappears automatically. You see the list of cities without the predictive speller. Here you can confirm the current entry or make another selection.

During character entry, you can also manually switch to the list of cities without predictive speller at any time.

► **Switching manually to the list of cities without predictive speller:** Slide ↑○.

or

► Select [OK] in the second line from the bottom and press [OK].

## List of cities without predictive speller

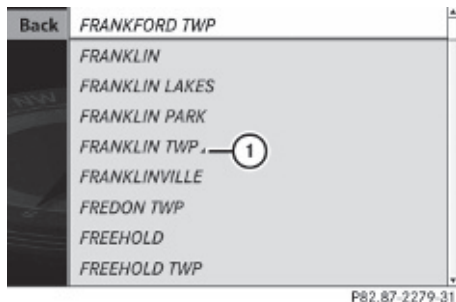

① Symbol for more selection options

► **Selecting a city:** Slide or rotate .

► **Canceling selection:** Select Back and press .

or

► Press back button in the center console (▷ page 87).

► **Confirming selection:** Press .

Cities with symbol are available more than once within the selected state (USA) or province (Canada). Confirming one of these cities will take you to a further sub-selection.

Select one of the available cities or select ALL. For more information, see “Multiple hits for city name” (▷ page 113).

If there are no other selection options, the address input menu appears again.

It shows one of the following items of information:

- City and state (USA) or province (Canada)
- Street, city and state (USA) or province (Canada)

The street is visible if you have entered it before entering the city.

Which of the following menu items are now available depends on the situation, or may depend on the digital map. The menu items which are not available cannot be selected.

- Map: Using the map to enter a destination (▷ page 122)
- In this case, using the map for destination entry is based on the city seen in the address input menu.
- Street: Entering the street (▷ page 114)
- No.: Entering the house number (▷ page 117)
- Center: Entering the center (▷ page 116)
- Intersection: Entering the intersection (▷ page 118)

• POI: Entering a point of interest (▷ page 124)

In this case, entering a POI is based on the city seen in the address input menu.

• Save: Saving a destination in the destination memory (▷ page 145)

• Start: Starting the route calculation (▷ page 120)

► **Continuing or completing destination entry:** Select one of the menu items mentioned above.

### Selecting the current city

The entry “City” in the “Address” menu is always empty at first because you can enter the street before entering a city (▷ page 115). You can modify the last entered destination such as selecting another street in the last city.

- Destination → From Last Destinations
- Select the last destination.
- Select Change and press .

### Multiple hits for city name

When there are multiple cities with the same name, you can enter or select a street name in addition. COMAND will then select the city in which the entered street name exists.

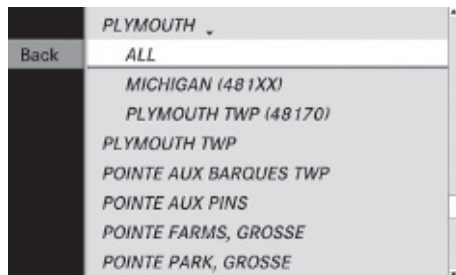

P82.87.3657-31

- Enter a city (▷ page 111).
- Select ALL.
- Enter or select the street name.
- Select the desired city.



## Entering a street

- i** It is not possible to enter a street if you have already entered a city center.
- i** You can only enter streets which are available on the digital map. If you have not entered a city before entering the street, only those streets within the state (USA) or province (Canada) previously entered are available. If you have already entered a city, streets within that city are available. If you have entered a zip code before entering the street, only those streets within the zip code area are available.

- ▶ In the address input menu, select Street. The list of streets appears either with or without the predictive speller (> page 115). Whether or not the predictive speller appears depends on how many streets are available for the selected city.

### Street list with predictive speller

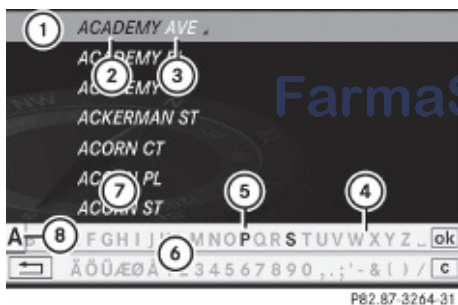

- ① Top list entry based on the input data up to that point
- ② Characters entered by the user
- ③ Characters automatically added by the system
- ④ Currently non-selectable characters
- ⑤ Currently selectable character
- ⑥ Predictive speller
- ⑦ Street list
- ⑧ Currently selected character

- i** In predictive speller ⑥, you can only select currently selectable characters. Which characters are included depends on the sequence in which you have entered your destination and the digital map.

The top list entry ① first shows the street first alphabetically and best corresponds to the input data as it has been entered up to that point.

As soon as you enter a character from predictive speller ⑥, the top list entry ① shows the street which best matches to the input data as it has been entered up to that point.

At the same time, COMAND automatically adds matching characters ③ to characters ② already entered by the user.

- ▶ **Selecting characters:** Slide ←→ or rotate ⌚.
- ▶ **Confirming character selection:** Press ⌚.
- ▶ **Deleting individual characters:** Select **[c]** in the bottom line and press ⌚.
- ▶ **Deleting an entire entry:** Select **[c]** in the bottom line and press ⌚ and hold until the entire entry is deleted.
- ▶ **Canceling an entry:** Select **[↩]** in the bottom line and press ⌚.

or

- ▶ Press back button **[↩]** in the center console (> page 87).

As soon as COMAND can clearly attribute the characters entered to a street, predictive speller ⑥ disappears. You see the street list without the predictive speller. Here you can confirm the current entry or make another selection.

During character entry, you can also manually switch to the street list without predictive speller at any time.



► **Switching manually to the street list without predictive speller:** Slide .

or

► Select in the second line from the bottom and press .

**Street list without predictive speller**

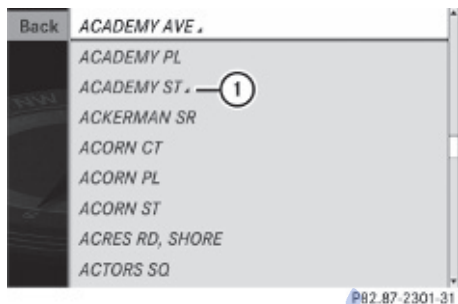

① Symbol for more selection options

► **Selecting a street:** Slide or rotate .

or

► Enter a street number with the telephone keypad using buttons - (▷ page 79).

**i** Example: Pressing button jumps to the 2nd Avenue.

► **Canceling selection:** Select Back and press .

or

► Press back button in the center console (▷ page 87).

► **Confirming selection:** Press .

Streets with symbol ① run through several suburbs. Confirming one of these streets takes you to a further sub-selection.

If there are no other selection options, the address input menu appears again after the confirmation.

It shows one of the following items of information:

- Street and state (USA) or province (Canada)
- Street, city and state (USA) or province (Canada)

**i** The city is visible if you have entered it before entering the street, or if COMAND can clearly attribute the street entered to a city.

Which of the following menu items are now available depends on the situation, or may depend on the digital map. The menu items which are not available cannot be selected.

- Map: Using the map to enter a destination (▷ page 122)

**i** In this case, using the map for destination entry is based on the city seen in the address input menu.

- No. : Entering the house number (▷ page 117)
- Intersection: Entering the intersection (▷ page 118)

**i** Entering an intersection is restricted to streets within the vicinity of the street entered.

- POI: Entering a point of interest (▷ page 124)

**i** In this case, entering a POI is based on the city seen in the address input menu.

- Save: Saving a destination in the destination memory (▷ page 145)
- Start: Starting the route calculation (▷ page 120)

► **Continuing or completing destination entry:** Select one of the menu items mentioned above.

**Entering street name before city name**

You can enter the street name directly before entering the name of the city. This is useful especially when entering an address with an

uncommon street name. COMAND will then search for cities in which a street with that name exists.

- ▶ Select or enter a state (USA) (▷ page 107) or province (Canada) (▷ page 109).
- ▶ Select or enter the street name.

## Entering a city center

**i** It is not possible to enter a city center if

- you have not yet entered a city
- you have already entered a street

You can only enter city centers which are available on the digital map.

Depending on the previous entry, city centers are available either for the city entered or the zip code area entered.

- ▶ In the address input menu, select Center. The list of city centers appears either with or without the predictive speller (▷ page 117).

## List of city centers with predictive speller

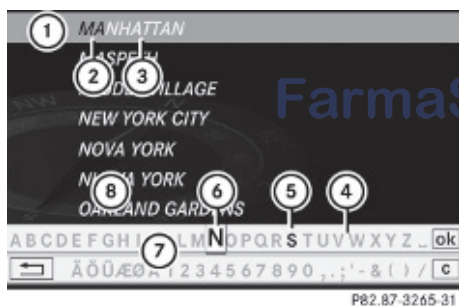

- ① Top list entry based on the input data up to that point
- ② Characters entered by the user
- ③ Characters automatically added by the system
- ④ Currently non-selectable characters
- ⑤ Currently selectable character
- ⑥ Currently selected character
- ⑦ Predictive speller
- ⑧ List of city centers

**i** In predictive speller ⑦, you can only select currently selectable characters. Which characters are included depends on the sequence in which you have entered your destination and the digital map.

While the characters are being selected as described below, top list entry ① always shows the city center which best matches to the input data as it has been entered up to that point.

At the same time, COMAND automatically adds matching characters ③ to characters ② already entered by the user.

▶ **Selecting characters:** Slide ←→ or rotate [↻].

▶ **Confirming character selection:** Press [✓].

▶ **Deleting individual characters:** Select [C] in the bottom line and press [✓].

▶ **Deleting an entire entry:** Select [C] in the bottom line and press [✓] and hold until the entire entry is deleted.

▶ **Canceling an entry:** Select [↩] in the bottom line and press [✓].

or

▶ Press back button [↩] in the center console (▷ page 87).

As soon as COMAND can clearly attribute the characters entered to a city center, predictive speller ⑦ disappears. You see the list of city centers without the predictive speller. Here you can confirm the current entry or make another selection.

During character entry, you can also manually switch to the list of city centers without predictive speller at any time.

▶ **Switching manually to the list of city centers without predictive speller:** Slide [↕].

or

▶ Select [ok] in the second line from the bottom and press [✓].

### List of city centers without predictive speller



▶ **Selecting a city center:** Slide  $\uparrow$   $\odot$   $\downarrow$  or rotate  $\left[ \odot \right]$ .

▶ **Canceling selection:** Select Back and press  $\odot$ .

or

▶ Press back button  $\left[ \leftarrow \right]$  in the center console (▷ page 87).

▶ **Confirming selection:** Press  $\odot$ .

After the confirmation, the address input menu appears again. It shows the city center, city and state (USA) or province (Canada).

Which of the following menu items are now available may depend on the digital map. The menu items which are not available cannot be selected.

• Map: Using the map to enter a destination (▷ page 122)

**i** In this case, using the map for destination entry is based on the city center seen in the address input menu.

• POI: Entering a point of interest (▷ page 124)

**i** In this case, entering a point of interest is based on the city center seen in the address input menu.

• Save: Saving a destination in the destination memory (▷ page 145)

• Start: Starting the route calculation (▷ page 120)

▶ **Continuing or completing destination entry:** Select one of the menu items mentioned above.

### Entering a house number

**i** The house number can only be entered after the street has been entered. You can only enter house numbers which are available on the digital map. The digital map does not contain all house numbers for all streets.

How the house number is entered depends on whether you have already entered just the street or both the street and the city.

#### With only the street entered previously:

Always the house number input screen appears. You can enter a house number immediately.

#### With the street and city entered previously:

▶ In the address input menu, select No. . . The house number input screen appears. Now you can enter a house number.

### Enter a house number

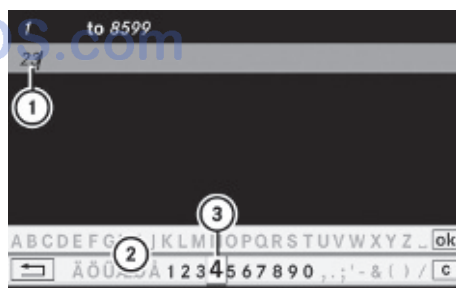

① Numbers entered by the user

② Predictive speller

③ Currently selected number

► **Selecting numbers:** Slide  $\leftarrow \odot \rightarrow$  or rotate  $\left\{ \odot \right\}$ .

► **Confirming number selection:** Press  $\odot$ .  
or

► Entering a number with the telephone keypad using buttons  $\boxed{0-9}$  -  $\boxed{wxyz}$  (▷ page 79).

► **Deleting individual numbers:** Select  $\boxed{c}$  in the bottom line and press  $\odot$ .

► **Deleting an entire entry:** Select  $\boxed{c}$  in the bottom line and press  $\odot$  and hold until the entire entry is deleted.

► **Canceling an entry:** Select  $\boxed{\leftarrow}$  in the bottom line and press  $\odot$ .

or

► Press back button  $\boxed{\leftarrow}$  in the center console (▷ page 87).

► **Confirming entry:** Select  $\boxed{ok}$  in the second line from the bottom and press  $\odot$ . If COMAND cannot clearly attribute the house number to a city, the city input menu appears.

**Entering city:** Proceed as described in the “Entering a city” section (▷ page 111).

After the city has been entered, the address input menu appears again.

If COMAND can clearly attribute the house number to a city, the address input menu also appears.

In both cases, the address input menu shows the house number, street, city and state (USA) or province (Canada).

Which of the following menu items are now available may depend on the data version of the digital map. The menu items which are not available cannot be selected.

• Map: Using the map to enter a destination (▷ page 122)

❗ In this case, using the map for destination entry is based on the city seen in the address input menu.

• POI: Entering a point of interest (▷ page 124)

❗ In this case, entering a POI is based on the city seen in the address input menu.

• Save: Saving a destination in the destination memory (▷ page 145)

• Start: Starting the route calculation (▷ page 120)

► **Continuing or completing destination entry:** Select one of the menu items mentioned above.

## Entering an intersection

❗ The intersection can only be entered after the street has been entered. You can only enter intersections which are available on the digital map.

► In the address input menu, select Intersection.

The list of intersections appears either with or without the predictive speller (▷ page 119). Whether or not the predictive speller appears depends on how many intersections are available for the selected street.

## List of intersections with predictive speller



P82.87-3268-31

① Top list entry based on the input data up to that point

② Characters entered by the user

③ Characters automatically added by the system

④ Predictive speller

⑤ Currently non-selectable characters

- ⑥ Currently selectable character
- ⑦ List of intersections
- ⑧ Currently selected character

**i** In predictive speller ④, you can only select currently selectable characters. Which characters are included depends on the sequence in which you have entered your destination and the digital map.

While the characters are being selected as described below, the top list entry ① always shows the intersection which best corresponds to the input data as it has been entered up to that point.

At the same time, COMAND automatically adds matching characters ③ to characters ② already entered by the user.

- ▶ **Selecting characters:** Slide ←→ or rotate [⊖].
- ▶ **Confirming character selection:** Press [⊙].
- ▶ **Deleting individual characters:** Select [c] in the bottom line and press [⊙].
- ▶ **Deleting an entire entry:** Select [c] in the bottom line and press [⊙] and hold until the entire entry is deleted.
- ▶ **Canceling character entry:** Select [←] in the bottom line and press [⊙].

or

- ▶ Press back button [←] in the center console (▷ page 87).

As soon as COMAND can clearly attribute the characters entered to an intersection, predictive speller ④ disappears. You see the list of intersections without the predictive speller. Here you can confirm the current entry or make another selection.

During character entry, you can also manually switch to the list of intersections without predictive speller at any time.

- ▶ Slide ↑⊙.

or

- ▶ Select [ok] in the second line from the bottom and press [⊙].

### List of intersections without predictive speller

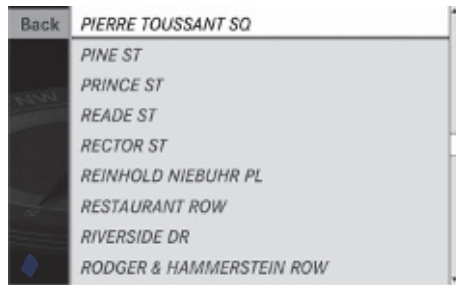

- ▶ **Selecting an intersection:** Slide ↑⊙↓ or rotate [⊖].

- ▶ **Confirming selection:** Press [⊙].

Either the address input menu appears again, or the city input menu.

- i** The city input menu appears if the intersection entered cannot be clearly attributed to a city.

- ▶ **Canceling selection:** Select Back and press [⊙].

or

- ▶ Press back button [←] in the center console (▷ page 87).

- ▶ **If the city input menu appears:** Enter a city.

- i** A detailed description of how to enter a city can be found in the “Entering a city” section (▷ page 111).

After the city has been entered, the address input menu appears again.

Which of the following menu items are now available may depend on the digital map. The menu items which are not available cannot be selected.

• Map: Using the map to enter a destination (▷ page 122)

**i** In this case, using the map for destination entry is based on the city seen in the address input menu.

• POI: Entering a point of interest (▷ page 124)

**i** In this case, entering a POI is based on the city seen in the address input menu.

• Save: Saving a destination in the destination memory (▷ page 145)

• Start: Starting the route calculation (▷ page 120)

#### ► Continuing or completing destination

**entry:** Select one of the menu items mentioned above.

#### Starting the route calculation

**i** You cannot start the route calculation until all the necessary address data has been entered.

► After entering the destination, select Start.

The route calculation will start if route guidance has not already been activated.

If route guidance has already been activated, a prompt will appear asking whether you want to end the current route guidance.

► Select Yes or No.

If you select Yes, COMAND will stop the route guidance and start the route calculation for the new destination.

If you select No, COMAND will continue with the active route guidance.

The new destination is discarded.

During the route calculation, an arrow will indicate the direction to the destination.

Below this, you will see the message The route is being calculated....

Once the route has been calculated, route guidance begins (▷ page 129).

**i** Route calculation requires time. The time depends on factors such as the distance from the destination.

COMAND calculates the route using the digital map data. The calculated route may differ from the actual road situation, e.g. due to road construction or incomplete map data. Please make sure that you observe the notes about the digital map (▷ page 96).

**i** Routes to destinations that do not have road or ferry access to the current position. This applies, for example, to routes from the mainland to Hawaii.

#### Entering a destination from the destination memory

► Select Navi → Destination → From Memory.

The destination memory list appears either with or without the predictive speller (▷ page 121). Whether the predictive speller appears depends on the number of entries in the destination memory.

**i** The destination memory always contains an entry called My Address. You can save your home address, for example, under this entry (▷ page 143).

#### Destination memory list with predictive speller

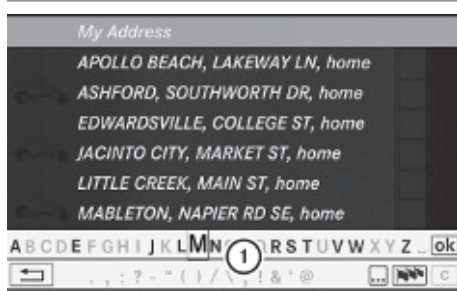

P82.87 3278 31

- i** In predictive speller ①, you can only select currently selectable characters. Which characters are included depends on the sequence in which you have entered your destination and the content of the destination memory.

While the characters are being selected as described below, the top list entry always shows the destination which best matches to the input data as it has been entered up to that point.

At the same time, COMAND automatically adds matching characters to characters already entered by the user.

- ▶ **Changing language for the predictive speller:** Select .



- ▶ Select desired language.



- ▶ **Changing character set for the predictive speller:** Select .

Depending on the previous setting, you will change to letters with special characters or to numbers with special characters.

- ▶ **Selecting characters:** Slide  or rotate .

- ▶ **Confirming character selection:** Press .

- ▶ **Deleting individual characters:** Select  in the bottom line and press .

- ▶ **Deleting an entire entry:** Select  in the bottom line and press  and hold until the entire entry is deleted.

- ▶ **Canceling an entry:** Select  in the bottom line and press .

or

- ▶ Press back button  in the center console (▷ page 87).



As soon as COMAND can clearly attribute the characters entered to a destination, predictive speller ① disappears. You see the destination memory list without predictive speller. Here you can confirm the current entry or make another selection.

You can also manually switch to the destination memory list without predictive speller at any time.

- ▶ **Switching manually to the destination memory list without predictive speller:**



Slide .

or

- ▶ Select  in the second line from the bottom and press .

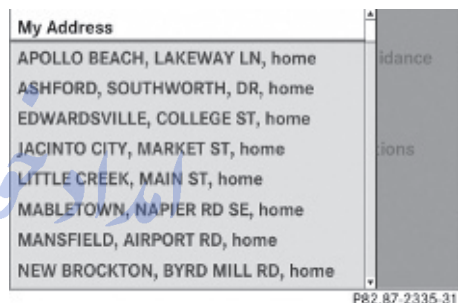
### Destination memory list without predictive speller



- ▶ **Selecting a destination:** Slide  or rotate .

- ▶ **Canceling selection:** Press back button  in the center console (▷ page 87).

or

- ▶ Select Back and press .

- i** The Back menu item is only present if this list was called up from the list with predictive speller.

- ▶ **Confirming selection:** Press .

- ▶ **Starting route calculation:** Select Start, see also (▷ page 120).



### Entering a destination from the list of last destinations

- ▶ Select Navi → Destination → From Last Destinations.  
The list of last destinations appears. The most recent destination is at the top of the list.
- ▶ Select desired destination.
- ▶ **Starting route calculation:** Select Start, see also (▷ page 120).

### Entering a destination from the map

- ❶ Depending on the factory settings of the vehicle, it may not be possible to enter a destination while the vehicle exceeds a preset speed. As soon as the vehicles speed drops to below the preset speed, the function is available again.

### Calling up the map

- ▶ In the address input menu, select Map (▷ page 107).  
You will see the map with a cross hair. The map is set to the address set in the address input menu.
- or
- ▶ Select Navi → Destination → Via Map.  
You will see the map with a cross hair.



- ❶ Cross hair
- ❷ Details of the cross hair position
- ❸ Map scale

- ❶ Display ❷ may be the name of a road, for example, provided the digital map contains the necessary data.

If no data is available, display ❷ shows:

- the coordinates if the Geo Coordinates display is switched on (▷ page 105)
- no display if the Geo Coordinates display is switched off (▷ page 105)

### Moving the map and selecting the destination

- ▶ **Moving map:** Slide ↑⊙↓, ←⊙→ or ↺⊙↻.
- ▶ **Adjusting map scale:** Rotate [⊙].  
Rotating clockwise enlarges the map, rotating counterclockwise reduces it.
- ▶ **Selecting a destination:** Press ⊙.  
If the cross hair is located off the edge of the digital map, a route cannot be calculated to this destination and you will see the message The destination is located off the map..
- ▶ Select OK.
- ▶ Move the map and select a destination again.  
If the destination can be attributed, you will see the address of the destination. If not, you will see the display Destination from map.
- ▶ **Starting route calculation:** Select Start, see also (▷ page 120).

### Entering a stopover

When route guidance is active, you can enter a stopover. Stopovers can be predefined destinations from the following predefined categories:

- Mercedes-Benz Service Center
- Hospital
- Gas Station
- Parking Lot



- Restaurant
- Other

With the option **Other** you can enter stopover destinations from the destination memory, last selected destinations, POIs, or via the address (▷ page 123).

You can enter stopover destinations on the route or in the vicinity of the route.

You can use the stopover function to influence the route guidance calculation to the main destination. When you have reached your stopover, COMAND automatically calculates the route to the main destination.

### Entering predefined destinations

- ▶ Select Navi → Destination → Stopover.  
If a stopover has already been entered, you can change it.

**Changing:** Select Change Stopover.  
You can now select a category.

- ▶ **Selecting a category:** Select category, e.g. Gas station.

COMAND first looks for destinations along the vehicle's route and within the immediate vicinity of the vehicle. If there are no destinations available there, COMAND searches for destinations in an area around the vehicle position.

If COMAND does not find any destinations, you will see a message to this effect.

- ▶ Select OK.

You can now select a different category.

If COMAND finds destinations, you will see a list of the destinations and details of how far away they are in the right-hand side of the display. The information about how far away the destinations are can take a few seconds to be displayed.

The left-hand part of the display shows the destinations on the map. The destination marked in the list is highlighted in the map.

- ▶ **Selecting a destination:** Select the desired destination from list.  
The address of the destination appears.
- ▶ **Starting route calculation:** Select Start, see also (▷ page 120).

### Entering another destination as a stopover

- ▶ Select Navi → Destination → Stopover.
- ▶ **Entering:** Select Other.  
You can select between the following menu items:

- Address Entry
- From Memory
- From Last Destinations
- From POIs

- ▶ Select a menu item.

Subsequent destination entries may differ, depending on your selection:

- Address Entry selection:
  - ▶ Enter a destination by address (▷ page 107).
- From Memory selection:
  - ▶ Enter a destination from the destination memory (▷ page 120).
- From Last Destinations selection:
  - ▶ Enter a destination from the list of last destinations (▷ page 122).
- From POIs selection:
  - ▶ Enter a point of interest (POI) (▷ page 124).

- ▶ **Starting route calculation:** After entering a destination, select Start (▷ page 120).

### Changing a stopover

If a stopover has already been entered, you can change it.

- ▶ Select Navi → Destination → Stopover → Change Stopover.
- ▶ Enter another destination as a stopover.

### Deleting the stopover

If a stopover has already been entered, you can delete it.

- ▶ Select Navi → Destination → Stopover → Delete Stopover. COMAND deletes the stopover and calculates the route to the main destination.

### Displaying stopovers on the map

- ▶ Enter a stopover (▷ page 122).

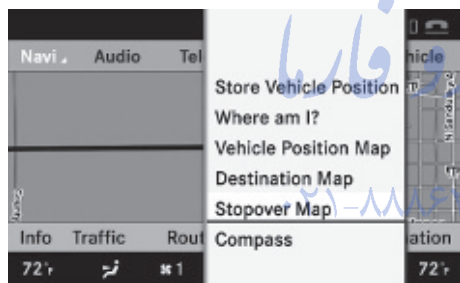

- ▶ Select the stopover.
- ▶ Select Position → Stopover Map. The stopover is displayed on the map.

### Calling stopover destinations or POIs

This function is only available when a mobile phone is connected to the COMAND and a phone number for the stopover destination or POI is stored in the navigation system database.

- ▶ Enter a stopover destination (▷ page 122) or a POI (▷ page 124).
- ▶ Select the stopover destination or POI.



- ▶ Select Call.

### COMAND navigation system (Point of interest entry)

#### Entering a POI in the surrounding area

- ▶ In the map view while the menu system is displayed (▷ page 102), select Destination → From POIs → Current Position.
- ▶ The list of POIs appears. The available POIs in the area of your position are displayed.

#### Entering a POI within the city limits of a given city

- ▶ With the menu system displayed (▷ page 102), select Destination → From POIs → Other City.
- ▶ Select a different state (USA) or province (Canada) if necessary (▷ page 107).
- ▶ **Entering city:** Select City. The address input menu appears.
- ▶ Proceed as described in the section “Entering a city” (▷ page 111).

#### Entering a POI in the destination area

With this function you have quick access to POIs in the vicinity of the selected destination.

- ▶ With the menu system displayed (▷ page 102), select Destination → From POIs → Destination area. The list of POIs appears. The available POIs in the vicinity of destination are displayed.

### Entering a POI by name

With this function you can enter or select POIs by the name of the POI.

- ▶ With the menu system displayed (▷ page 102), select Destination → From POIs → By Name → All POIs. When selecting All POIs all POIs in the navigation database are displayed sorted by name.

You can also search for POIs in the vicinity of your current position or a particular city.

- ▶ With the menu system displayed (▷ page 102), select Destination → From POIs → By Name → Current Position or Other City.

### Entering a POI by telephone number

With this function you can enter or select POIs by the telephone number of the POI.

- ▶ With the menu system displayed (▷ page 102), select Destination → From POIs → By Telephone Number. The telephone numbers of all POIs that are stored in the navigation database are displayed.

### Choosing a POI category and selecting a POI

The available categories or POIs depend on the selected search method.

- POI in the surrounding area:

categories sorted alphabetically and POIs sorted by distance around the vehicle position are available.

- POI within the city limits of a given city: If you have only entered the state (USA) or province (Canada) and the city, alphabetically sorted categories and alphabetically sorted POIs within the city are available.

If you have entered more than the state (USA) or province (Canada) and the city, alphabetically sorted categories and POIs sorted by distance around the address entered are available.

- POI in the destination area: categories sorted alphabetically and POIs sorted by distance around the destination area are available.
- POIs via name search: Alphabetically sorted POIs are available.
- POIs via phone number: Numerically sorted POIs are available.

Some search methods display a list of available main categories. After selecting a main category and, if available, a subcategory a list of POIs appears.

- ❗ The main categories can have up to three subcategories.

Other search methods provide a list of POIs immediately.

## Choosing a main category

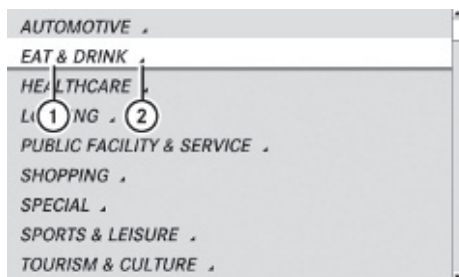

P82.87.3911.31

Example illustration: Main category list for POIs in the surrounding area

- ① Main category
- ② Symbol for available POIs or other available subcategories

► **Selecting a main category:** Slide  $\uparrow \odot \downarrow$  or rotate  $\left\{ \odot \right\}$ .

► **Canceling selection:** Press back button  $\left[ \leftarrow \right]$  in the center console (▷ page 87).

► **Confirming selection:** Press  $\odot$ .

Main categories with symbol ② contain either POIs or subcategories. Further operation depends on whether the selected main category contains subcategories or only POIs.

Selected main category contains subcategories:

Selecting such a main category opens a list of subcategories.

## Choosing a subcategory

The following illustration shows an example of the subcategory RESTAURANT ① as part of the main category EAT & DRINK as well as more subcategories ④.



P82.87.3912.31

- ① First subcategory
- ② To show all POIs for all subcategories under category ①
- ③ Symbol for available POIs or further subcategories
- ④ Further subcategories

► **Selecting a subcategory:** Slide  $\uparrow \odot \downarrow$  or rotate  $\left\{ \odot \right\}$ .

► **Canceling selection:** Press back button  $\left[ \leftarrow \right]$  in the center console (▷ page 87).

► **Confirming selection:** Press  $\odot$ .

After selecting a subcategory, a list of POIs appears. It contains the POIs available within the search radius of the subcategory.

- ① If you have selected list item ②, the POI list contains all POIs for all subcategories within the search radius of main category ①.

Selected main category contains no subcategories, but only POIs:

Selecting such a main category immediately opens a list of POIs. The POI list contains the available POIs within the search radius of the main category.

## POI list

Depending on the situation, COMAND first shows the following list or the POI list with predictive speller.

The illustration below shows by way of example the POI list for the BISTRO subcategory within the surrounding area.



P82.87-3913-31

- ① Compass heading to the destination
- ② Linear distance to the destination
- ③ Selected destination

**i** Compass ① and linear distance ② are not displayed with all search methods. Displays ① and ② are static; they do not change while you are driving.

In the POI list, you can either select a POI or enter the name of the POI.

### Selecting a POI

- ▶ Select desired POI.  
The POI list disappears and the address of the POI appears.
- ▶ **Back to POI list:** Press back button  in the center console (> page 87).
- ▶ **Starting route calculation:** Select Start, see also (> page 120).

### POI list with predictive speller













P82.87-3914-31

- ① Top list entry based on the input data up to that point
- ② Characters entered by the user

- ③ Characters automatically added by the system
- ④ Predictive speller
- ⑤ Currently selectable character
- ⑥ Currently non-selectable characters
- ⑦ POI list
- ⑧ Currently selected character

**i** In predictive speller ④, you can only select currently selectable characters. Which characters are included depends on the sequence in which you have entered your destination and the digital map.

While the characters are being selected as described below, the top list entry ① always shows the POI that best matches to the input data as it has been entered up to that point. At the same time, COMAND automatically adds matching characters ③ to characters ② already entered by the user.

- ▶ **Selecting characters:** Slide   or rotate .
- ▶ **Confirming character selection:** Press .
- ▶ **Deleting individual characters:** Select  in the bottom line and press .
- ▶ **Deleting an entire entry:** Select  in the bottom line and press  until the entire entry is deleted.
- ▶ **Canceling an entry:** Select  in the bottom line and press .

or

- ▶ Press back button  in the center console (> page 87).

As soon as COMAND can clearly attribute the characters entered to a POI, predictive speller ④ disappears.

You see the POI list without predictive speller. Here you can confirm the current entry or make another selection.

You can also manually switch to the POI list without predictive speller at any time.

- ▶ **Switching manually to the POI list without predictive speller:** Slide  $\uparrow \odot$ .

or

- ▶ Select  $\square$  in the second line from the bottom and press  $\odot$ .

### POI list without predictive speller



- ▶ **Selecting a POI:** Slide  $\uparrow \odot \downarrow$  or rotate  $\{\odot\}$ .
- ▶ **Canceling selection:** Press back button  $\square$  in the center console ( $\triangleright$  page 87).
- ▶ **Confirming selection:** Press  $\odot$ .
- ▶ **Starting route calculation:** Select Start, see also ( $\triangleright$  page 120).

### Showing details

#### Symbol Info

With the function Symbol Info you can call up information on POIs that are close by.

- ▶ In the map view while the menu system is displayed, select Route  $\rightarrow$  Symbol Info. The nearest POI is highlighted in the map and indicated in the map header.

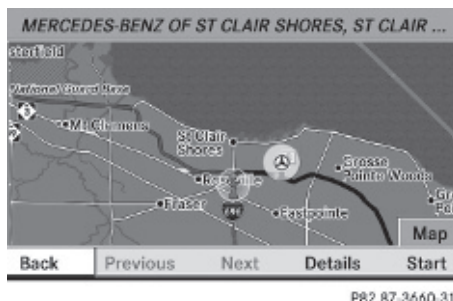

Example illustration: Mercedes-Benz Center is highlighted

- ▶ **Selecting map view:** Select Map.
- ▶ **Exiting:** Select Back.
- ▶ **Switching to a different POI:** Select Previous or Next.
- ▶ **Displaying information for the POI:** Select Details. A window that contains additional information appears. Slide  $\leftarrow \odot \rightarrow$  or press  $\odot$  to close the window.
- ▶ **Accepting POI as destination or stopover destination:** Select Start. When you confirm by selecting Yes, the route to the POI will be calculated.

### Additional information by ZagatSurvey®

ZagatSurvey® provides additional information by displaying rating symbols or text for selected POIs.

Additional information is available for:

- Hotels
- Restaurants
- Golf courses



Symbol ① indicates POIs for which additional information is available.

▶ Select a POI and press



Example illustration: Hotel with additional information available

- ① Open late (hours vary by section)
- ② No credit cards accepted
- ③ Closed on Sundays
- ④ Key aspects
- ⑤ Ratings
- ⑥ Cost

All ratings throughout this guide function are on the Zagat 0 to 30 scale as follows:

Ratings	
0 - 9	poor to fair
10 - 15	fair to good
16 - 19	good to very good

Ratings	
20 - 25	very good to excellent
26 - 30	extraordinary to perfection

Ratings apply to the key aspects of each category covered, for example, Dining, Facility, Room and Service in the Hotel category. See Ratings and Symbols in each section.

Cost is covered differently in each category, as noted in the Ratings and Symbols keys.

Select Details for a brief description of the respective POI. Surveyor comments are shown in quotation marks within reviews.

### Calling a POI

▶ Calling a POI (▶ page 124).

## COMAND navigation system (route guidance)

### Route guidance

Observe Safety notes, see page 95.

COMAND guides you to the destination using navigation commands in the form of audible navigation announcements and route guidance displays.

The route guidance displays can only be seen if the display is switched to navigation mode.

If, for any reason, you do not follow the navigation commands or if you leave the calculated route, COMAND automatically calculates a new route to the destination. If the map data contains the relevant information, COMAND tries to avoid roads that only have limited access, e.g. roads closed to through-traffic and non-residents.



### Examples of displays and announcements for a driving maneuver

Driving maneuvers have three phases:

- Preparation phase
- Announcement phase
- Maneuver phase

#### Preparation phase

COMAND prepares you for the upcoming driving maneuver. Based on the example display below, the driving maneuver is announced with the Prepare to turn left message. The display is not split and shows the map over the full screen.



- ① Point at which the driving maneuver takes place (light blue dot)
- ② Route (highlighted blue)
- ③ Current vehicle position; the triangle points in the vehicle's direction of travel

#### Announcement phase

COMAND announces the next driving maneuver. Based on the example display below, the driving maneuver is announced 700 feet in advance with the Turn left in 700 feet to your destination message. The display is divided in two. In the left half, you see the normal map view. In the right half, there is either an enlarged view of the area surrounding the intersection (intersection zoom) or simply a symbol for the next driving maneuver.

The following example illustration shows the intersection zoom in the right half.

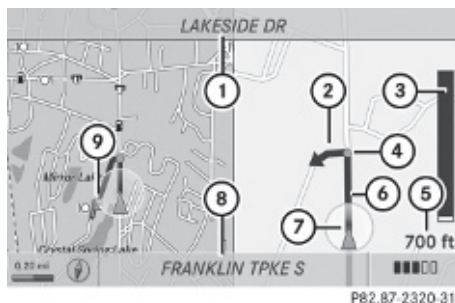

- ① Next road
  - ② Driving maneuver (turn left)
  - ③ Graphical representation of the distance to the driving maneuver
  - ④ Point at which the driving maneuver takes place (light blue dot, shown in both the left and right displays)
  - ⑤ Information about distance to the next driving maneuver
  - ⑥ Route (highlighted in blue; shown in both the left and right displays)
  - ⑦ Current vehicle position; the triangle indicates the vehicle's direction of travel (shown in both the left and right displays)
  - ⑧ Street on which you are currently driving, if included on the digital map
  - ⑨ Destination flag
- i** The filled-in section of distance graphic ③ gets shorter the nearer you get to the announced driving maneuver.

#### Maneuver phase

COMAND announces the next driving maneuver. Based on the example display below, the driving maneuver is announced 150 feet in advance with the Now turn left message. The display is also split into two halves, as for the announcement phase.

- i** Once the maneuver is completed, COMAND automatically switches back to the non-split screen.



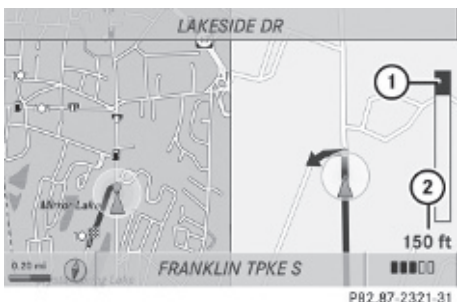

- ① Graphical representation of the distance to the next driving maneuver
- ② Information about distance to the next driving maneuver

**Lane recommendations**

COMAND can display lane recommendations for upcoming driving maneuvers when driving on selected multilane streets. The respective data must be available on the digital map.

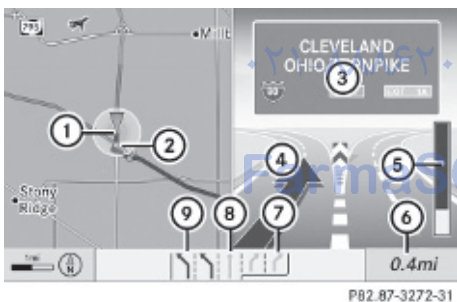

- ① Current vehicle position; the triangle indicates the driving direction
- ② Location of next driving maneuver
- ③ Information on direction, intersection, exit number etc.
- ④ Next driving maneuver: Turn left here
- ⑤ Distance bar representing the distance to the next driving maneuver
- ⑥ Distance to the next driving maneuver
- ⑦ Lane not recommended
- ⑧ Possible lane
- ⑨ Recommended lane

COMAND displays the lane recommendations ⑦, ⑧ and ⑨ with regard to the next two driving maneuvers.

**i** The instrument cluster also provides lane recommendations but shows recommended lanes only.

**Explanation of lane recommendations**

- Recommended lane ⑨: This lane can be used to perform the next two driving maneuvers without changing lanes.
- Possible lane ⑧: This lane can be used to perform only the next driving maneuver without changing lanes.
- Lane not recommended ⑦: This lane cannot be used to perform the next driving maneuver without changing lanes.

**Display of lane recommendation**

Additional lanes that open during a driving maneuver are displayed different from each other:

Display	Meaning
With limiting line below (lane ⑦)	New lane that opened during a driving maneuver
Without limiting line below (lane ⑧ or ⑨)	Through lane

The color of the lane recommendation varies depending on whether the COMAND display design is set to day or night:

Day mode	Night mode
Recommended lane ⑨ = deep blue	Recommended lane ⑨ = light blue
Possible lane ⑧ = light blue	Possible lane ⑧ = deep blue
Lane not recommended ⑦: = grey	Lane not recommended ⑦: = grey

### Example of a display without driving maneuvers

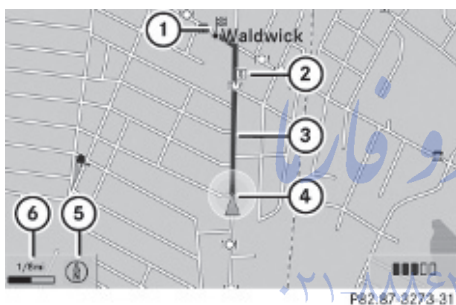

- ① Main destination
- ② Stopover (only visible if a stopover has been entered)
- ③ Route (highlighted blue)
- ④ Current vehicle position; the triangle indicates the vehicle's direction of travel
- ⑤ Set map orientation – for an explanation and settings, see (▷ page 103)
- ⑥ Set scale – for an explanation and settings, see (▷ page 102)

### Destination or destination area reached

Once you have reached your destination, you will hear the announcement You have reached the destination. For certain POIs (airports or highway junctions), you will hear the announcement You have reached the destination area. In addition, you will

see a corresponding display and route guidance is automatically ended.

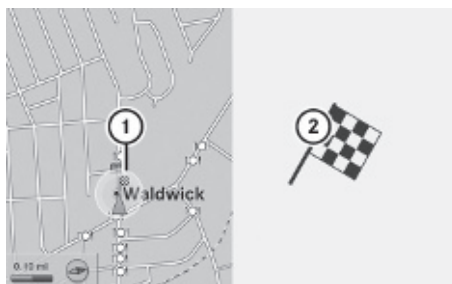

- ① Destination on the map
- ② Destination flag

**i** An additional announcement may sound for some destinations, for example selected POIs or destination entries that include the house number, telling you whether the destination is on the left or right side of the street.

### Partially digitized areas

**i** The digital map may contain areas that are only partially attributed.

#### **Warning!**

Due to incomplete digitization, the route shown on the map may differ from the actual road/traffic situation.

If you follow the route shown on the map, for example, it is possible that you could drive the wrong way down a one-way street or that a street cannot be driven on.

When using route guidance in a partially attributed area, you must therefore be sure to observe all relevant traffic regulations and the course of the road.

All relevant traffic regulations and the course of the road always take priority over the route shown on the map.

### If the destination is within a partially digitized area

COMAND guides you through fully digitized areas for as long as possible. Route guidance is conducted in the usual manner, e.g. with navigation announcements and route guidance displays.

Before the vehicle reaches a partially digitized area, COMAND notifies you of this with the following announcements:

- Be prepared to enter an area where turn by turn guidance cannot be provided.
- In 700 feet you will enter an area where turn by turn guidance cannot be provided.

**i** The indicated distance can be seen here by way of example. In reality, it may be different.

- You are about to enter an area where turn by turn guidance cannot be provided.

**i** When you call up the route info to this type of destination, (▷ page 136) the following data shown there may differ from the actual situation:

- Distance to the destination
- Estimated driving time to the destination
- Estimated arrival time

### Route guidance within a partially digitized area

If you start route guidance in this type of area, you will hear the following announcement: You are currently in an area where turn by turn guidance cannot be provided.

Route guidance is provided by means of a direction arrow showing the compass heading to the destination. COMAND will not generate automatic navigation announcements.

If you try to call up an announcement manually, (▷ page 135) you will hear the announcement You are currently in an area where turn by turn guidance cannot be provided.

During route guidance, the display is divided.

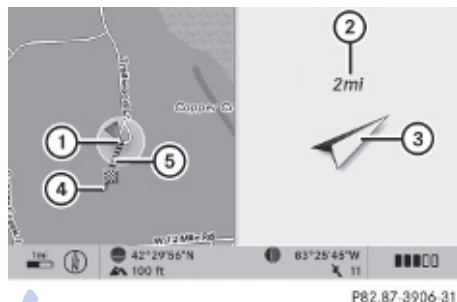

- ① Current vehicle position
- ② Distance to destination (linear distance)
- ③ Direction to destination (compass heading)
- ④ Destination
- ⑤ Suggested route

On the right-hand side you will see direction arrow (3) showing the compass heading to destination (4).

On the left-hand side of the display you will see the map with the suggested route. Suggested route (5) is indicated with a dashed blue line. However, it may not be possible to follow the suggested route (5) because, for example, the road is closed or not open for car traffic.

If, during route guidance, COMAND leads you back into a fully digitalized area, route guidance will simply continue in the usual manner.

## Off-road and off-map

### Route guidance to an off-road destination

#### Warning!

The COMAND navigation system may direct you to off-road routes that your vehicle may not be capable of traversing through without damaging your tires, wheels or vehicle. It is the driver's sole responsibility to determine the suitability of the route. Off-road routes may be of varying conditions and their appropriateness for use may be affected by various factors such as time of day, time of year and immediate weather conditions that cannot be judged or taken into consideration by the COMAND system.

COMAND can guide you to destinations within the area covered by the digital map, even if a destination is not located at a road known to the system.

These destinations are shown as off-road destinations, which you can enter using the map, for example. In these cases, COMAND guides you for as long as possible with navigation announcements and displays on roads known to the system. Shortly before you reach the last known point to leave the digitized road network, you will hear the announcement The destination is nearby. Follow the arrow on the display.

You will then see an arrow that indicates the direction to the off-road destination. When the off-road destination is close to the road, Area of dest. reached appears in addition below the arrow.

The section of the route from the last known point on the map to the off-road destination is indicated with a dashed line after a certain length. It simply shows the direction to the off-road destination without taking account of any type of obstacles in the way.

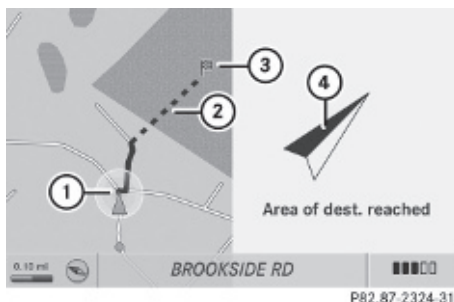

- ① Current vehicle position; the triangle indicates the vehicle's direction of travel
- ② Off-road section of the route
- ③ Off-road destination
- ④ Direction arrow, shows compass heading to destination

On the off-road section of the route, direction arrows showing the compass heading to the destination guide you. You will also see the Direction to destination display.

### Route guidance from an off-road location to a destination

If there is no road available on map at current position of the car, vehicle is off road. COMAND is also able to guide you to a destination from such a location.

At the start of the route guidance, you will see the Off Road message and a direction arrow. The direction arrow shows the compass heading to the actual destination.

The route is highlighted blue from the nearest road known to the system.

As soon as the vehicle is back on a road known to the system, route guidance continues in the usual way.

### Off-road during route guidance

The road geometry may differ from the data on the digital map, due to road construction, for example.

In such cases, the system cannot allocate the vehicle position to the digital map and the vehicle is therefore in an off-road position.

The Off Road message and an arrow showing the compass heading to the destination appear on the display.

As soon as the system can allocate the vehicle position to the map again, route guidance continues in the usual way.

### Navigation announcements

#### Warning!

Navigation announcements are intended to direct you while driving without diverting your attention from the road and driving.

Please always use navigation announcements instead of consulting the map display for directions. Consulting the symbols or map display for directions may cause you to divert your attention from driving and increase your risk of an accident.

- i** If Chinese is set as the system language, the navigation announcements are in English. For information on how to set the system language see (▷ page 94).

Navigation announcements are muted during telephone calls. You can, however, call up a current announcement at any time. You can also call up a current announcement at any time if you have missed an announcement.

Route guidance is active already.

#### ► **Calling up a current announcement:**

Select Navi → RPT.

or

- Press favorite button  if the button has been programmed with this function (▷ page 94).

#### ► **Switching off navigation messages:**

Press button  during an announcement.

You will see the message The driving instructions have been muted. for a short while.

- i** The announcements remain switched off even if you start a new route guidance or if COMAND is switched off/on with button .

If you switch COMAND off by removing the SmartKey from the starter switch and then switch the ignition back on after more than 3 minutes, the announcements are automatically switched back on.

#### ► **Switching navigation announcements back on manually:** Select Navi → RPT.

#### ► **Adjusting volume of the messages:**

Adjust the volume during an automatic announcement (▷ page 87).

or

- Call up an announcement manually using Navi → RPT and adjust the volume (▷ page 87).

- i** You can use the function Audio Fadeout (▷ page 106) to reduce the volume of audio sources during navigation announcements.

### COMAND navigation system (during route guidance)

#### Cancel route guidance

- Select Destination → Cancel Route Guidance in map view with the menu system displayed (▷ page 102).

#### Continuing canceled route guidance

- Select Destination → Continue Route Guidance in map view with the menu system displayed (▷ page 102). COMAND calculates the route.

### Displaying info

- ▶ Select **Info** in map view with the menu system displayed (▷ page 102). The route information appears.

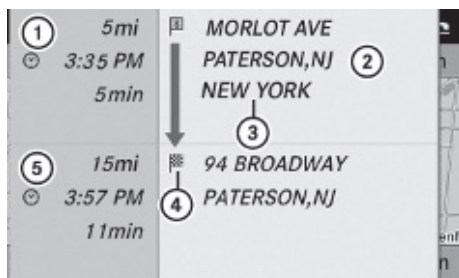

P82.87-2127-31

Example illustration: Display with main destination and stopover

- ① Distance/estimated time of arrival/estimated journey time to the stopover destination
- ② Stopover destination
- ③ Street, city and state/province
- ④ Main destination
- ⑤ Distance/estimated time of arrival/estimated journey time to the main destination

- i** COMAND uses the time set in COMAND as the basis for calculating the estimated arrival time. The clock must be set correctly in COMAND (▷ page 92). The arrival time is displayed in local vehicle time, based on the time zone set in the vehicle.

The following data cannot be seen until the route calculation has been completed:

- Distance to destination
- Estimated arrival time
- Estimated remaining travel time

If the destination is located within a partially digitized area, the following data may differ from the facts:

- Distance to destination
- Estimated arrival time
- Estimated remaining travel time

### Displaying route information

- ▶ Select **Route** → **Route Info** in map view with the menu system displayed (▷ page 102). The route information appears.



P82.87-3907-31

- ① Information for highlighted portion of route
- ② Highlighted portion of route
- ③ Next portion of route

- ▶ **Closing route info:** Select **Back** and press or press back button in the center console (▷ page 87).
- ▶ **Displaying next or previous route section:** Select **Next** or **Previous**.
- ▶ **Zooming into or out of route:** Select or .

### Where am I?

You can display your current position while route guidance is active as well as when route guidance has been canceled.



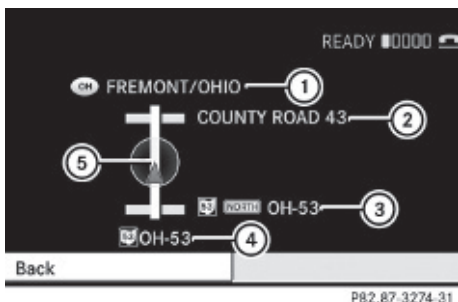

- ① Current position (city and state/province)
  - ② Next intersection or exit ahead
  - ③ Previous intersection or exit
  - ④ Current street
  - ⑤ Current position
- Select Navi → Position → Where am I?.

### Compass

You can have the current cardinal direction into which the front of the vehicle points displayed.

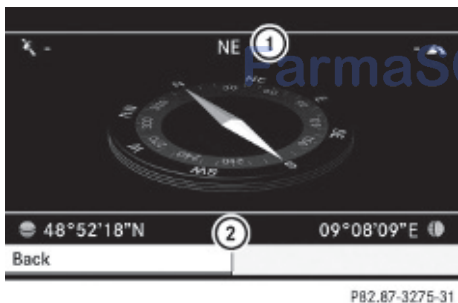

- ① Current cardinal direction
  - ② Geo coordinates
- Select Navi → Position → Compass.

### Displaying highway information

When this function is enabled, highway information ahead will display automatically.

Symbols indicate POIs in the area of the respective highway exit.



- **Showing/hiding highway information:** Select Navi.
- Check or uncheck the Highway information check box.

### Detour function

- ① The detour function blocks a section of the route ahead of you. You can set the length of the blockage. If possible, COMAND calculates a detour route.
- Select Route → Detour in map view with the menu system displayed (> page 102). The detour function display appears.
- **Setting length of the blockage:** Select More or Less until the desired length is set.



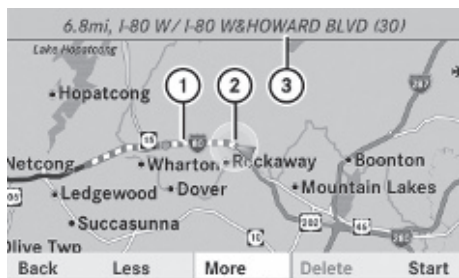

P82.87-2328-31

- ① Blocked route section
- ② Current vehicle position; the triangle indicates the vehicle's direction of travel
- ③ Information about the blocked route section

**i** Blocked route section ① is always highlighted in red/white. The information about blocked route section ③ shows which section of the route is blocked and the length of the blocked section.

- ▶ **Starting route calculation:** Select Start, see also (▷ page 120).
- ▶ **Deleting blockage:** Select Navi → Route → Detour → Delete.

### Alternative Route

You can calculate and display alternative routes in addition to the route that COMAND displays automatically. The original route is displayed in light blue while the alternative route is dark blue.

- ▶ With the menu system displayed (▷ page 102), select Route → Alternative Route.



P82.87-3277-31

- ① Route distance, time, and time of arrival for the currently selected alternative route marked in deep blue
  - ② On the Route: Symbols indicate special parts, such as tunnels, ferries or toll roads, on the displayed alternative route.
  - ③ Mode: Current settings for the displayed alternative route  
Avoid: Symbols of route parts to avoid, for example tunnels, ferries or toll roads
- ▶ **Displaying/selecting other alternative routes:** Select Previous or Next.
  - ▶ **Accepting the currently selected, deep blue route for route guidance:** Select Start.

### COMAND navigation system (real-time traffic)

#### Traffic messages

- i** A subscription to SIRIUS XM Satellite Radio service provider is required for the satellite radio reception referred to here. You can find more information on satellite radio in chapter "Satellite Radio" (▷ page 170).

COMAND can receive and incorporate traffic messages via satellite radio into the navigation system. Traffic report messages and map symbols can then be viewed in the COMAND display.

## Display settings

You can select what kind of traffic information is displayed on the map.

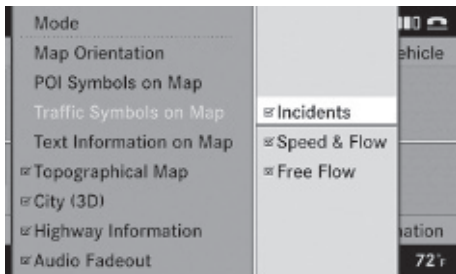

P82.87-3661-31

- ▶ Select Navi → Traffic Symbols on Map
- ▶ **Displaying traffic incidents:** Select Incidents.  
Road sections for which traffic incidents are reported are indicated by yellow symbols and arrows.
- ▶ **Displaying traffic speed and flow:** Select Speed & Flow.  
Road sections for which traffic obstructions are reported are indicated by yellow or red vehicle symbols.
- ▶ **Displaying normal traffic flow:** Select Free Flow.  
Road sections with reported free flowing traffic are indicated as green lines.

## Real-time traffic notifications in the map

COMAND can display certain traffic events in the map. The notifications are shown in the map scale range from  $1/16$  mi to 20 mi.

Free Flow traffic messages are only displayed with a map scale of  $1/16$  miles to 5 miles.

- ▶ Set the required map scale (▶ page 102).











P82.87-3662-31

- ①, ② Marker symbols for the extension of the affected route section
- ③ Symbol for event on the route
- ④ Current vehicle position and direction of travel
- ⑤ Map scale

## Real-time traffic notification symbols

- ❶ Red and yellow cars and green and yellow lines appear on the map when Speed & Flow, Free Flow, or Incident are selected via Navi → Traffic Symbols on Map.  
The diamond shaped icons appear when Traffic → Traffic Symbol Info is selected from the map submenu.

Symbol	Description	Traffic notifications in map display	Traffic report lists	Traffic report message
	Free-flowing traffic	No obstacles for traffic flow. Appears on the free-flow side (direction) of the road.	No entry	No message
	Incidents	Possible obstacles for traffic flow (e.g. road work). Appears on the affected side (direction) of the road.	No entry	No message
	Warning (red)	Indicates a location for which a warning message has been issued. Red arrow indicate the driving direction to which the warning message applies.	Appears with warning entry type	Appears with warning entry type
	Incident (yellow)	Indicates a location for which a message has been issued. Yellow arrow indicate the driving direction to which the message applies.	Appears with incident entry type	Appears with incident entry type
	Traffic jam on route (stop-and-go)	Appears at the beginning of traffic congestion from the driver's point of view if route guidance is active and route goes through congested area. Yellow car symbols could appear in combination with this symbol.	Appears with traffic jam on route (stop-and-go) entry type	Appears with traffic jam on route (stop-and-go) entry type
	Traffic jam on route	Appears at the beginning of traffic congestion from the driver's point of view if route guidance is active and route goes through congested area. Red car symbols - could appear in combination with this symbol.	Appears with traffic jam on route entry type	Appears with traffic jam on route entry type
	Blocked section on route	Appears at the beginning of a blocked area from the driver's point of view if route guidance is active and route goes through blocked area. XX XX symbols could appear in combination with this symbol.	Appears with blocked section entry type	Appears with blocked section entry type
	Traffic jam (stop-and-go) (yellow car)	Traffic congestion, average speed 25 – 45 mph (40 – 72 km/h). Could appear repeatedly to indicate length of traffic congestion.	(Not possible)	(Not possible)

Symbol	Description	Traffic notifications in map display	Traffic report lists	Traffic report message
	Traffic jam (red car)	Traffic congestion, average speed 5 – 20 mph (8 – 32 km/h). Could appear repeatedly to indicate length of traffic congestion.	(Not possible)	(Not possible)
XXXX	Blocked section	Road impassable. Could appear repeatedly to indicate length of blocked area	(Not possible)	(Not possible)

### Displaying real-time traffic reports

- ▶ If necessary, switch to navigation mode and show the menu system (▷ page 102).
- ▶ Select Traffic.  
COMAND searches for satellite radio channels sending traffic messages.

The message No traffic reports are currently available for this area. may appear for the following reasons:

- Messages were not yet received.
  - There are no messages available.
- ▶ **Cancelling the search:** Select Cancel.
  - ▶ **Closing the message:** Select OK.

If there are traffic reports, you will see a list or a submenu, depending on whether route guidance is active or not.

- ▶ **i** A traffic message may also concern an area or region rather than a road, e.g. impaired visibility due to fog.

#### List when route guidance is not active

The list shows all the roads, areas or regions for which messages are available.

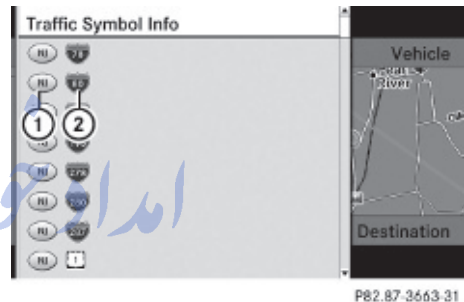

- ① Country, state or province indicator (optional)
- ② Road concerned

- ▶ **Displaying a traffic message:** Select an item from the list.  
The traffic message appears, see “Example of a traffic message” (▷ page 142).
- ▶ **Closing the list:** Slide ←⊙→ once or repeatedly.
- ▶ **Displaying traffic symbol information:** Select Traffic Symbol Info (▷ page 142).

List when route guidance is active

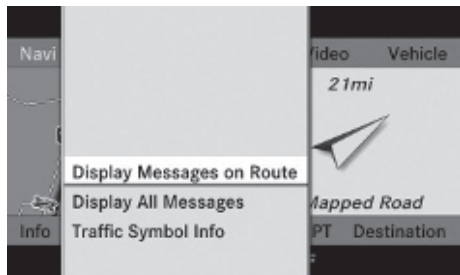

P82.87-3664-31

Submenu with route guidance active

- ▶ **Displaying a list with traffic messages on the current route:** Select Display Messages on Route.
- ▶ **Displaying a list with all traffic messages:** Select Display All Messages.
- ▶ **Displaying traffic symbol information:** Select Traffic Symbol Info (▷ page 142).

After selecting Display Messages on Route or Display All Messages a list with traffic messages appears.

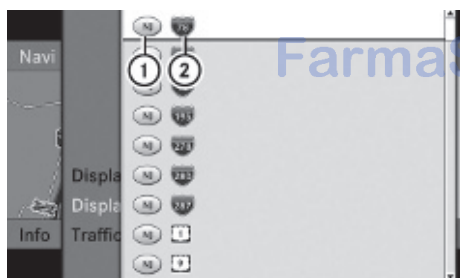

P82.87-3665-31

- ① Country, state or province indicator (optional)
- ② Road concerned

- ▶ **Displaying a traffic message:** Select an item from the list. The traffic message appears, see "Example of a traffic message" (▷ page 142).
- ▶ **Closing the list:** Slide ←→ once or repeatedly.

Example of a traffic message

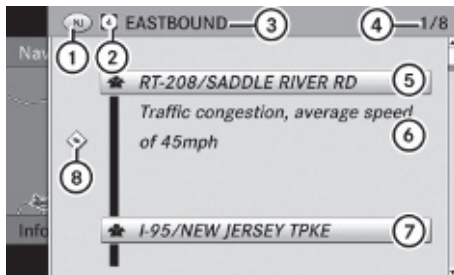

P82.87-4446-31

- ① Area designation
- ② Affected road
- ③ Affected driving direction
- ④ Message 1 of 8 for the road affected
- ⑤ Turnoff, crossroads or junction before the affected road section
- ⑥ Text of traffic message
- ⑦ Turnoff, crossroads or junction after the affected road section
- ⑧ Traffic symbol

▶ **Scrolling within the message or to the next message:** Turn [⏪] or slide ↑⇄↓.

▶ **Returning to the message list:** Slide ←⇄→.

Traffic symbol information

▶ **Displaying traffic symbol information:** Select Traffic Symbol Info.

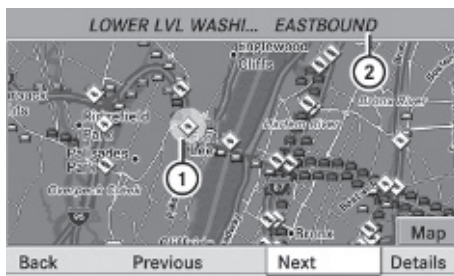

P82.87-3666-31

- ① Selected traffic message
- ② Affected driving direction

- ▶ **Back to list:** Select Back.
- ▶ **Displaying previous or next traffic message:** Select Previous or Next.
- ▶ **Displaying details for selected traffic message:** Select Details.
- ▶ **Switching to map view:** Select Map.

## COMAND navigation system (destination memory)

### My address

- ① The destination memory always contains an entry called My Address. You can save your home address, for example, under this entry.

### Assigning your address for the first time or changing your own address

#### Assigning and/or changing your own address

- ▶ Select Navi → Destination → From Memory.  
Depending on the number of entries in the destination memory, you will see the destination memory list with or without predictive speller.



Example illustration: Destination memory list without predictive speller

In the destination memory list without predictive speller, the My Address entry is automatically highlighted.

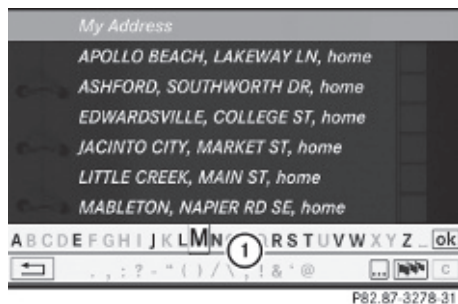

Example illustration: Destination memory list with predictive speller ①

In the destination memory list with predictive speller ①, the predictive speller is automatically activated.

- ▶ **Destination memory list without predictive speller:** Press immediately.

- ▶ **Destination memory list with predictive speller:** Slide repeatedly until the predictive speller disappears. The list entry My Address is automatically highlighted as long as you have not entered any characters using the predictive speller.

**If you have entered characters from the predictive speller:** Rotate or slide repeatedly until the list entry My Address is highlighted.

- ▶ Press .

Further operation depends on whether you want to enter the address manually or use an address book entry as your own address.

#### Entering an address manually

- ▶ **If you want to assign your own address for the first time:** Select Create New Entry.

or

- ▶ **If you want to change your own address:** Select Change → Create New Entry.

In both cases, the address input menu appears.

- ▶ Enter the address. Proceed as described for destination entry in the “Entering a destination by address” section (▷ page 107).
- ▶ Select **Save** after entering the address. Your address is saved.

### Using the address book entry as your own address

- ▶ **If you want to assign your own address for the first time:** Select **Assign Address Book Entry**.

or

- ▶ **If you want to change your own address:** Select **Change** → **Assign Address Book Entry** → **Home or Work**.

In both cases, the menu appears for searching for an address book entry.

- ▶ Select desired address book entry. Proceed as described in the “Searching for an address book entry” section (▷ page 160).

Once the address data is complete and if it matches the digital map data, COMAND saves the entry as your own address in the destination memory.

If address data is still missing or if it cannot be found on the digital map, a message appears indicating that the address is incomplete.

- ▶ **Closing message:** Select **OK**.

**i** In the address book entry, the city and street must be spelled in the same way as the destination entry so that the data matches the digital map data.

In order for the state (USA) or province (Canada) to match the map data, you may either enter the entire name or the abbreviation in the address book.

Examples:

- Florida or FL
- Colorado or CO

- Alberta or AB
- Ontario or ON

Depending on which data is missing or cannot be found on the digital map, you must now either:

- select a state (USA) or province (Canada)
- or enter a city
- or enter a street
- or enter a house number

### ▶ **Selecting a state (USA) or province (Canada):**

Select desired state (USA) or province (Canada) from the list.

- ▶ **Entering a city:** Proceed as described for destination entry in the “Entering a city” section (▷ page 111).

- ▶ **Entering a street:** Proceed as described for destination entry in the “Entering a street” section (▷ page 114).

- ▶ **Entering a house number:** Proceed as described for destination entry in the “Entering a house number” section (▷ page 117).

If all data is available and matches the digital map data, you can save the address.

- ▶ **Saving:** Select **Save**.

### Selecting your own address for route guidance

- ▶ Select **Navi** → **Destination** → **From Memory**.

The destination memory list appears either with or without the predictive speller.

Whether the predictive speller appears depends on the number of entries in the destination memory.



### Destination memory list without predictive speller

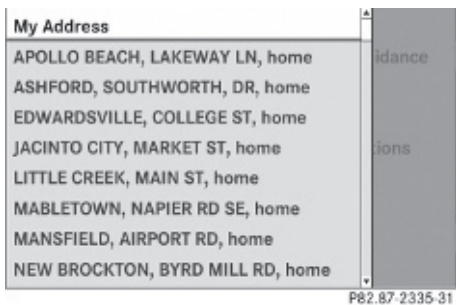

In the destination memory list without predictive speller, the My Address entry is automatically highlighted.

- ▶ Press .

If your own address has already been assigned, you will see the menu for starting route guidance with your own address data.

- ▶ **Starting route calculation/guidance:**

Select Start and press .

or

- ▶ **Exiting menu:** Select .

### Destination memory list with predictive speller

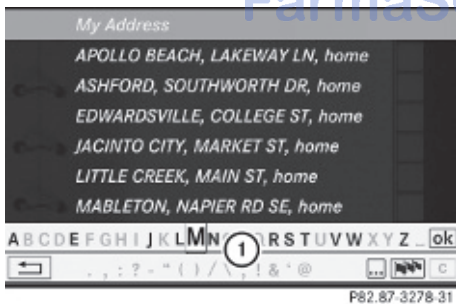

In the destination memory list with predictive speller , the predictive speller is automatically activated.

- ▶ Slide repeatedly until the predictive speller disappears.

The list entry My Address is automatically highlighted as long as you have not entered any characters using the predictive speller.

**If you have entered characters from the predictive speller:** Rotate or slide repeatedly until the list entry My Address is highlighted.

- ▶ Press .

If your own address has already been assigned, you will see the menu for starting route guidance with your own address data.

- ▶ **Starting route calculation/guidance:**

Select Start and press .

or

- ▶ **Exiting menu:** Select .

### Saving a destination in the destination memory

This function also saves the destination in the address book. There COMAND creates an address book entry containing complete, navigable address data. You can then select this entry in the address book and start navigation to the address.

For information on how to enter a destination from the destination memory, see [\(> page 120\)](#).

### Saving after the address has been entered

- ▶ Select Save after entering the address [\(> page 107\)](#). You can now select save options.

### Saving during route guidance

- ▶ Select Destination → Save Destination during route guidance. You can now select save options.

FarmaSOS.com

### Saving a destination from the list of last destinations

- ▶ Select Navi → Destination → From Last Destinations.  
The list of last destinations appears.
- ▶ Select desired destination.  
The address of the destination is displayed.
- ▶ Select Save.  
You can now select save options.

### Selecting save options

#### Saving a destination without a name

- ▶ Select Save without Name.  
COMAND saves the destination in the destination memory and uses the address as the destination name.

or

- ▶ Select Save as "My Address".  
COMAND saves the destination in the destination memory as your own address.

#### Saving a destination with a name

- ▶ Select Save with Name.
- ▶ Select desired category, e.g. Home or Work.  
The input menu appears with the data fields and the predictive speller.

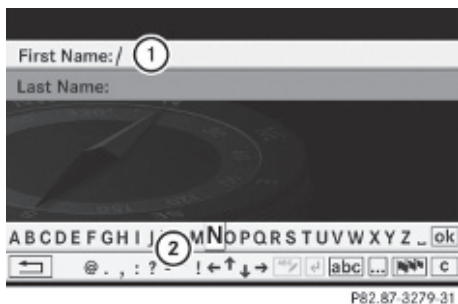

- ① Selected data field with input mark (cursor)
- ② Predictive speller

- ▶ **Entering data:** Proceed as described in the "Changing the data field" operating step in

the "Creating a new address book entry" section (▶ page 161).

### Assigning a destination to an address book entry

**i** This function assigns the complete, navigable address data to an already existing address book entry. You can then select this entry in the address book and start navigation to the address from there.

- ▶ Select Assign Address Book Entry.
- ▶ Select desired category, e.g. Home or Work.  
The menu appears for searching for an address book entry.
- ▶ Select desired address book entry.  
Proceed as described in the "Searching for an address book entry" section (▶ page 160).  
If the selected address book entry does not yet contain any navigable address data, COMAND saves the data.  
If the selected address book entry already contains navigable address data, you will see a question asking you if the previous data should be overwritten.
- ▶ Select Yes or No.  
If you select Yes, COMAND saves the data.

### Deleting a destination from the destination memory

- ▶ Select Navi → Destination → From Memory.  
Depending on the number of entries in the destination memory, you will see the destination memory list with or without predictive speller.

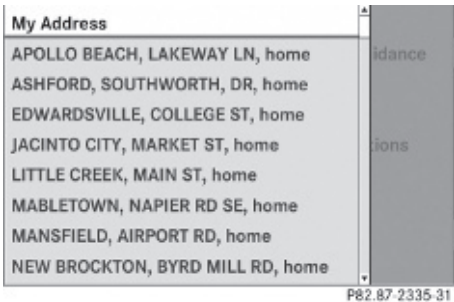

Example illustration: Destination memory list without predictive speller

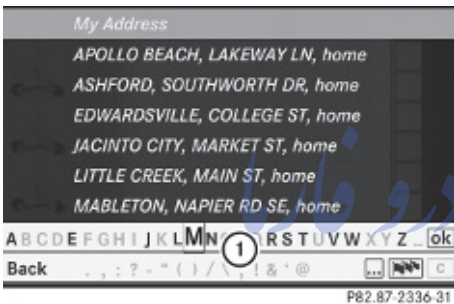

Example illustration: Destination memory list with predictive speller ①

- ▶ Select desired destination. Proceed as described for destination entry in the “Entering a destination from the destination memory” section (> page 120).
  - ▶ Select Delete after selecting the destination to be deleted. A prompt appears asking whether you want to delete the destination.
  - ▶ Select Yes or No. If you select Yes, COMAND deletes the destination.
- i** If the navigable address data of the destination to be deleted has also been assigned to an address book entry, COMAND deletes the data there as well. If the corresponding address book entry does not contain any further data, such as telephone numbers, COMAND deletes the entire address book entry.

## COMAND navigation system (last destinations)

- i** COMAND automatically saves the last destinations for which the route calculation was launched. It is stored in the “last destinations” memory. If this memory is full, COMAND deletes the oldest destination. You can also save one destination from the list of last destinations in the destination memory. It will be saved there permanently.

### Saving a destination permanently in the destination memory

- ▶ Proceed as described in the “Saving a destination from the list of last destinations” section (> page 146).

### Saving the vehicle position in the list of last destinations

- ▶ **Centering map on the vehicle’s position:** Select Navi → Position → Vehicle Position Map.
- ▶ **Saving:** Select Navi → Position → Store Vehicle Position.

### Saving the cross hair position in the list of last destinations

- i** If you have manually moved the map, you will see a cross hair on the map (> page 102). You can save the cross hair position as a destination in the list of last destinations.
- ▶ **Showing menu system, if necessary:** Press .
  - ▶ Select Position → Save Crosshair Position.

### Deleting one of the last destinations

- ▶ Select Navi → Destination → From Last Destinations.  
The list of last destinations appears.
- ▶ Select desired destination.  
The address of the destination appears.
- ▶ Select Delete.
- ▶ Select Yes or No.

### COMAND telephone

#### Safety notes

##### Warning!

Some jurisdictions prohibit the driver from using a cellular telephone while driving. Whether or not prohibited by law, for safety reasons, the driver should not use the cellular telephone while the vehicle is in motion. Stop the vehicle in a safe location before placing or answering a call.

If you nonetheless choose to use the mobile phone<sup>9</sup> while driving, please use the handsfree feature and be sure to pay attention to the traffic situation at all times. Use the mobile phone only when road, weather and traffic conditions permit. Otherwise, you may not be able to observe traffic conditions and could endanger yourself and others.

Bear in mind that at a speed of just 30 mph (approximately 50 km/h), your vehicle is covering a distance of 44 feet (approximately 14 m) every second.

### General notes

#### USA only:

This device complies with Part 15 of the FCC Rules. Operation is subject to the following two conditions:

1. This device may not cause harmful interference, and
2. this device must accept any interference received, including interference that may cause undesired operation.

Any unauthorized modification to this device could void the user's authority to operate the equipment.

#### Canada only:

This device complies with RSS-210 of Industry Canada. Operation is subject to the following two conditions:

1. This device may not cause interference, and
2. this device must accept any interference received, including interference that may cause undesired operation of the device.

Any unauthorized modification to this device could void the user's authority to operate the equipment.

<sup>9</sup> Observe all legal requirements

## Using the Bluetooth® interface

COMAND provides telephony via the Bluetooth® interface by connecting a Bluetooth®-compatible mobile phone. The following functions can be used when a suitable mobile phone is connected to the Bluetooth® interface:

- Hands-free phone operation
- Phone book
- Reception of electronic business cards (vCards<sup>10</sup>)

**i** For further information on suitable mobile phones and connecting Bluetooth®-enabled mobile phones to COMAND

- visit [www.mbusa-mobile.com](http://www.mbusa-mobile.com)
- call the Mercedes-Benz Customer Assistance Center at 1-800-FOR-MERCEdes (1-800-367-6372) (in the USA)
- call Customer Service at 1-800-387-0100 (in Canada)

## Calls disconnected while the vehicle is in motion

A call may be disconnected if

- there is insufficient network coverage
- you move from one transmitter/receiver area (cell) into another and no channels are free or the cell is full

## Operating options

**i** The components and operating principles of COMAND can be found on (▷ page 76).

You can operate the mobile phone using the following:

- the keys on the mobile phone
- the COMAND telephone keypad in the center console

- the COMAND controller
- the multifunction steering wheel
- the Voice Control System (▷ page 237)

Unless otherwise specified, the descriptions and illustrations in this section apply to COMAND or the telephone keypad in the center console. Thus, in order to use the described functions you always have to call up the Telephone menu. The fastest way to get to the Telephone menu is pressing shortcut button .

You can control other functions of the mobile phone via the COMAND, instrument cluster control system (▷ page 230) or Voice Control System (▷ page 237).

## Caller ID

COMAND can display the telephone number and the name of the caller, e.g. for an incoming call and also in other menus or displays.

For the telephone number to be displayed, the caller must transmit his telephone number.

This is also the case for name displays. For this, the telephone number and the name of the caller must also be saved in the mobile phone book.

## Functional restrictions

You will not be able to use the telephone, or you may have to wait a while, in the following situations:

- If the Bluetooth function in COMAND or on the mobile phone is switched off.
- If the telephone has not yet logged into the network.

The telephone tries to log into a network automatically. If no network is available, you will also not be able to make a “911” emergency call. If you attempt to make an

<sup>10</sup> vCards are electronic business cards used by e-mail applications, mobile phones, PDAs, etc. to exchange contact information.

outgoing call, the No Service message will appear for a short while.

- The SIM card is not inserted in GSM type phone.
- When you remove the SmartKey from the starter switch during a call in hand-free mode, the call will be maintained for up to 30 minutes. It will then be terminated. Switch to "Private Mode" on the mobile phone before switching off COMAND to maintain the call beyond that time limit. Refer to the operating instructions of your mobile phone.
- When you want to switch off COMAND during a call in hands-free mode, the message You cannot shut off COMAND until you have finished your telephone call. appears.

### Activating telephone mode

- ▶ Select Telephone.
- or
- ▶ Press button  on telephone keypad.
- or
- ▶ Press shortcut button  once or twice.

**i** The number of times you have to press shortcut button  depends on the operating mode currently selected.

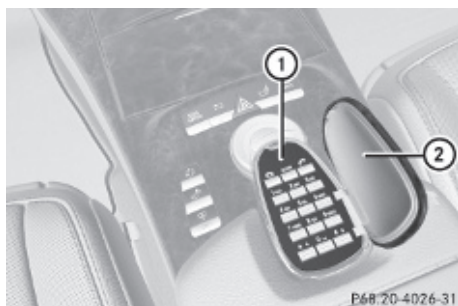

### Telephone keypad





With the telephone keypad ① you can:

- Enter and clear numbers and special characters.
- Reject, answer, connect and end calls.

▶ **Entering characters:** Flip up cover ②.

▶ Enter characters using buttons  - .

**i** You can enter the \* character by pressing button  once. Pressing button  again within 1.5 seconds enters the + character.

▶ **Deleting individual characters:** Press button .

▶ **Deleting an entire word or number:** Press and hold button  until the word or number is deleted.

### "911" emergency call

**i** The "911" emergency call system is a public service. Using it without due cause is a criminal offense.

**i** This function places a call to the local "911" provider. It does not initiate a Tele Aid call.

The following describes how to dial a "911" emergency call using the COMAND head unit when a Mercedes-Benz specified mobile phone is connected via the Bluetooth® interface to COMAND. Unless otherwise specified, the descriptions refer to the COMAND head unit.



Consult the separate mobile phone operating instructions that came with your mobile phone for information on how to place a "911" emergency call on the mobile phone.

The following conditions must be met for a “911” emergency call via COMAND:



- Mobile phone must be switched on.
  - The corresponding mobile communications network must be available.
- i** Emergency calls may not be possible with all telephone networks or if certain network services and/or telephone functions are active. Check with your local service providers.

If you cannot make an emergency call, you will have to initiate rescue measures yourself.

### Placing a “911” emergency call using COMAND with the mobile phone unlocked

- ▶ Press button  to switch to telephone mode.
- ▶ Enter 911 using the telephone keypad in the center console.
- ▶ Press button  on the telephone keypad in the center console.

or

- ▶ Select  in the COMAND display and press  for dialing to begin. Connecting call... appears in the COMAND display while the mobile phone establishes the connection.
- ▶ Wait until the emergency call center answers, then describe the emergency.

- i** Depending on the phone type, if no SIM card is inserted in a GSM mobile phone or if there is no service on a CDMA mobile phone, NO SERVICE may appear in the COMAND display. In that case, you only can make an emergency call on the mobile phone itself, without the use of COMAND.

### Placing a “911” emergency call with the mobile phone locked

- i** If the mobile phone is locked, you only can make an emergency call on the mobile phone itself, without the use of COMAND.

### Bluetooth interface

Bluetooth® is a technology for wireless exchange of data over short distances of up to approximately 33 feet (10 m). You can connect your mobile phone to COMAND or exchange vCards using Bluetooth®.

### Activating and deactivating Bluetooth®

- ▶ Select Vehicle → System → Bluetooth → Bluetooth activated.

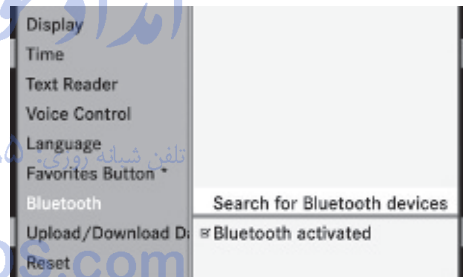

P82.87-3280-31

Bluetooth® is activated when the check box is checked.

### Mobile phone prerequisites

A Bluetooth®-compatible mobile phone is required for telephony via the COMAND using the Bluetooth® interface.

- i** For further information on suitable mobile phones and connecting Bluetooth®-enabled mobile phones to COMAND
- visit **www.mbusa-mobile.com**
  - call the Mercedes-Benz Customer Assistance Center at



1-800-FOR-MERCEdes  
(1-800-367-6372) (in the USA)

- call Customer Service at  
1-800-387-0100 (in Canada)

The battery of the mobile phone should always be charged sufficiently to avoid malfunctions.

You should check the following on your mobile phone (see your mobile phone operating instructions) to prepare for telephony via the Bluetooth® interface:

- Hands-Free Profile (HFP)

The mobile phone must support Hands-Free Profile 1.0 or higher.

**i** Some displays, such as the signal strength, appear depending on the supported Hands-Free Profile version.

- Bluetooth® visibility

With certain mobile phones, the Bluetooth® function must be activated but also made "visible" to other devices.

- Bluetooth® device name

Each Bluetooth® device has a Bluetooth® device name. The device name is arbitrary, but it may be identical for all devices of a single mobile phone manufacturer. You should therefore assign an individual and unique device name to your mobile phone.

## Connecting the mobile phone

- ▶ Switch on the mobile phone and enter the PIN. Refer to the mobile phone operating instructions for details.
- ▶ Activate the Bluetooth® functionality on the mobile phone. Refer to mobile phone operating instructions for detail.

Bluetooth® is activated in the COMAND by default. If the Bluetooth function in the COMAND is not activated, the message Bluetooth not activated in system

settings. appears. Activate Bluetooth® in the COMAND manually (▷ page 151).

## Authorizing the mobile phone

The mobile phone must be registered, e.g. authorized, before you can use it in connection with COMAND for the first time.

You can authorize several mobile phones. COMAND will always connect to the last connected mobile phone within range.

**i** If the connection to the last connected mobile phone fails, COMAND searches for the mobile phone that was connected before that.

When authorizing a new mobile phone, it will be connected automatically<sup>11</sup>.

- ▶ Select Data/Connections → Bluetooth Telephones → Update.

The COMAND searches for Bluetooth® devices within range and lists them in the Bluetooth® phone list.

The duration of the search depends on the number of Bluetooth® devices within range and the characteristics of the mobile phone, such as Hands-Free Profile version and possibly required visibility.

<sup>11</sup> Function available if supported by the mobile phone.

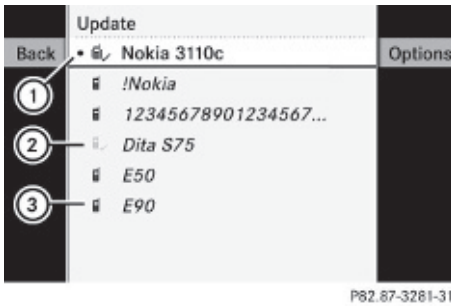

Example illustration: Bluetooth® phone list

- ① Currently connected • and authorized mobile phone
  - ② Mobile phone already authorized but not within range (• appears in grey)
  - ③ New recognized mobile phone within range, not authorized yet
- i** When the Bluetooth® phone list is full, you will be prompted to deauthorize a Bluetooth® device (> page 154). If COMAND cannot find your mobile phone, an external authorization (> page 154) may be necessary.

- ▶ **Authorizing:** Choose a mobile phone that is not authorized yet ③ from the Bluetooth® phone list and select Options → Authorize.

The prompt to enter the passkey appears.

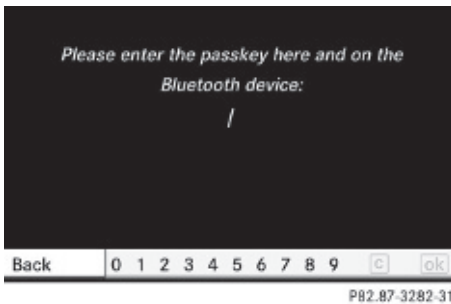

The passkey is an arbitrary string of 1 to 16 digits. You have to enter the same passkey for COMAND and the Bluetooth® device that you want to authorize. Refer to the operating instructions of your mobile phone for details.

The passkey should have at least four digits in order to establish a secure Bluetooth® connection.

### Entering a passkey in COMAND

You can enter the passkey into COMAND via the digits in the menu bar or the telephone keypad.

- ▶ **Entering via the menu bar:** Select the respective digits with the COMAND controller and confirm the selection.
- or
- ▶ **Entering via the telephone keypad:** Press the respective digits on the telephone keypad.
- ▶ **Confirming:** Select **OK** in the menu bar.
- or
- ▶ Press **#** or **[Phone Icon]** on the telephone keypad.
- ▶ **Deleting entry:** Select **C** in the menu bar and press **[Phone Icon]**.
- or
- ▶ Press **CLEAR** on the telephone keypad.

### Entering a passkey into the mobile phone

You will be prompted to enter the passkey (identification, code) into your mobile phone after the Bluetooth® connection was successful. Refer to the operating instructions of your mobile phone for details.

- ▶ Enter the same passkey that you have entered into the COMAND.
- i** You might have to confirm the passkey on your mobile phone. Check your mobile phone display.

When the message **Error** during authorization process. appears on your COMAND display, you have either exceeded the time limit or the passkey was incorrect. Repeat the process.

The mobile phone is connected with the COMAND (authorized). You can now make phone calls via the hands-free function of the COMAND.

### External authorization

Certain security settings in your mobile phone may prevent COMAND from finding your mobile phone. In this case, you might want to check if your mobile phone can recognize the COMAND. The Bluetooth® device name of COMAND is MB Bluetooth.

- ▶ Select Data/Connections → Bluetooth Telephones.
- ▶ Go to Update and select Options → External Authorization.
- ▶ Activate the Bluetooth® search on the mobile phone. Refer to mobile phone operating instructions for detail.
- ▶ Select MB Bluetooth on the mobile phone.
- ▶ When prompted, enter the passkey into COMAND and the mobile phone (▷ page 153).

### Show details

Details can be displayed for each mobile phone in the Bluetooth® phone list.

- ▶ Select Data/Connections → Bluetooth Telephones.
- ▶ Choose the mobile phone from the list and select Options → Details. The following mobile phone details appear:
  - Bluetooth® name
  - Bluetooth® address
  - Availability status
  - Authorization
  - Bluetooth® Class (mobile phone, notebook, etc.)
- ▶ **Closing detail display:** Slide ←⊙→.

### Deauthorizing the mobile phone

- ▶ Select Data/Connections → Bluetooth Telephones.
- ▶ Choose the mobile phone from the list and select Options → De-authorize. You will be asked whether you want to deauthorize the device.
- ▶ Select Yes.

**i** You should delete the device name MB Bluetooth from the Bluetooth® list of the mobile phone before authorizing that mobile phone again.

### Connecting another mobile phone

You can switch between several mobile phones that you have authorized.

**i** Switching to another authorized mobile phone is only possible while no phone calls are being made.



- ▶ Select Data/Connections → Bluetooth Telephones.
- ▶ Select the mobile phone from the Bluetooth® phone list.
- ▶ Confirm the selection. The selected mobile phone is connected provided it is within Bluetooth® range and Bluetooth® is activated on the respective device. You can only connect one mobile phone at a time. The currently connected mobile phone is indicated by a dot ● in the Bluetooth® phone list (▷ page 153).

### Main telephone menu

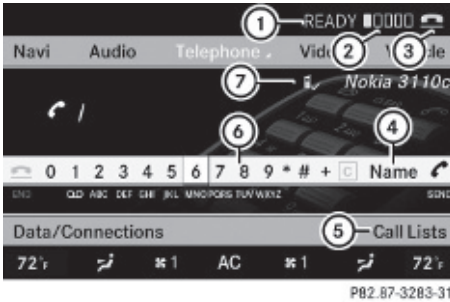
When the connected mobile phone is ready, the following display appears:



- ① Network status<sup>12</sup>
- ② Signal strength of mobile phone network  
<sup>12</sup>

- ③ Receiver symbol  (active) or  (inactive)
- ④ COMAND phone book
- ⑤ Call lists
- ⑥ Digits for call number entry
- ⑦ Bluetooth® name of the currently connected mobile phone

Bars ② indicate the current signal strength of the mobile network. When all bars full, reception is best. When all bars are empty, reception is poor or the mobile network is not available at all.

### Telephone submenu overview

Data/Connections	Call Lists
Bluetooth Telephones	Calls Received
Address Book	Calls Dialed
Download Contacts	Delete Call Lists <sup>13</sup>
Delete Contacts	

### Setting Transmission and Reception Volume

Incorrect settings for transmission and reception volume can impair call quality significantly.

You can therefore optimize these settings.

For information on best settings for your mobile phone

- visit [www.mbusa-mobile.com](http://www.mbusa-mobile.com)
- call the Mercedes-Benz Customer Assistance Center at 1-800-FOR-MERCEdes (1-800-367-6372) (in the USA)
- call Customer Service at 1-800-387-0100 (in Canada)

- ▶ Select Data/Connections → Bluetooth Telephones.
- ▶ When the desired mobile phone is selected: Select Options → Reception Volume or Transmission Volume.

**i** The options Reception Volume and Transmission Volume will only appear when the selected mobile phone is authorized.

<sup>12</sup> Visible when supported by the mobile phone.

<sup>13</sup> Only available when using a mobile phone that does not support automatic download of call lists.

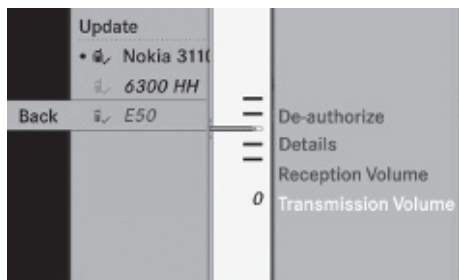

P82.87-3284-31

- ▶ **Changing the volume:** Slide and press .

## Making calls

**Observe Safety notes, see page 148.**

## Incoming call



P82.87-3285-31

- ▶ **Rejecting:** Select Reject.
- or
- ▶ Press button on the multifunction steering wheel or on the telephone keypad in the center console.
- ▶ **Answering:** Select Accept.
- or
- ▶ Press button on the multifunction steering wheel or on the telephone keypad in the center console.
- or
- ▶ Answer the call via the Voice Control System (▷ page 237).

<sup>14</sup> Except you have accepted the call via button on the multifunction steering wheel.

After answering the call, you will conduct the conversation via the hands-free system. The volume can be adjusted (▷ page 88). For more available functions during a single party call see (▷ page 157).

When a call comes in, the following appears in the COMAND display:

- the phone number of the calling party
- the name and number of the calling party provided both are stored in the address book
- Ca11 from Unknown when the caller ID is not being sent

**i** You can answer a call even when COMAND is displaying a different main function. After answering the call, the display switches to the telephone display<sup>14</sup>. Once you hang up, the display switches back to the previous main function.

## Outgoing call

- ▶ Enter the phone number via the telephone keypad in the center console.
- or
- ▶ Use the COMAND controller to enter the phone number via the telephone menu.
- or
- ▶ Use the Voice Control System to enter the phone number digit by digit or to enter a name from the phone book (▷ page 237).
- ▶ **Deleting single digits:** Press on the telephone keypad in the center console briefly.
- or
- ▶ Select via the telephone menu and press briefly.

- **Deleting entire number:** Press and hold **CLEAR** on the telephone keypad in the center console until the number is deleted.

or

- Select **C** via the telephone menu and press and hold **☎** until the number is deleted.
- **Connecting call:** Press button **☎** on the multifunction steering wheel or on the telephone keypad in the center console.

or

- Select **☎** via the telephone menu

### Redial

- Go to the telephone menu.
- Press **☎** on the telephone keypad in the center console.

or

- Select SEND from the telephone menu and press **☎**.

The list of previously dialed number appears. The last number you have called at the top of the list.

- **Selecting number and connecting call:** Slide **↑** **⊙** **↓** and press **☎** to select a number or press **☎** on the telephone keypad in the center console.

### Calling voice mail<sup>15</sup>

Your voice mail number must be stored on the SIM card of your mobile phone and be assigned to key **1** on the mobile phone keypad.

- Press and hold **1** on the telephone keypad in the center console.

### Functions during a single party call (non-conference calls)

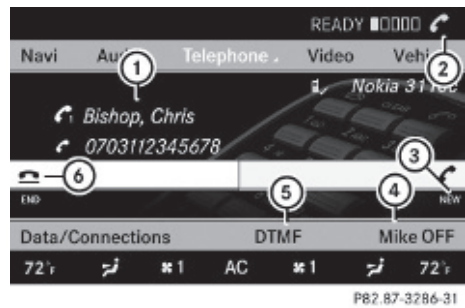

- ① Called or calling party
- ② **☎** Active call
- ③ NEW Connect to more parties<sup>16</sup>
- ④ Switching hands-free microphone on/off
- ⑤ Enable touch-tone dialing<sup>17</sup>
- ⑥ Ending call

### Switching hands-free microphone on or off

This function is available during an active call.

- **Switching off:** Select Mike OFF in the telephone menu. Symbol **⊗** appears and the message The microphone is turned OFF. is displayed briefly.
- **Switching on:** Select Mike ON in the telephone menu. Symbol **⊗** goes out. The message The microphone is turned ON. appears briefly.

### Touch-tone dialing<sup>17</sup>

You can use touch-tone dialing to control answering machines and other devices for remote inquiry.

When you want to check your answering machine for example, dial the respective number.

<sup>15</sup> Function only available when supported by the respective network provider.

<sup>16</sup> Function only available when the mobile phone supports HFP 1.5 or higher.

<sup>17</sup> Not available on all mobile phones.

- ▶ Select DTMF from the telephone menu during a call.

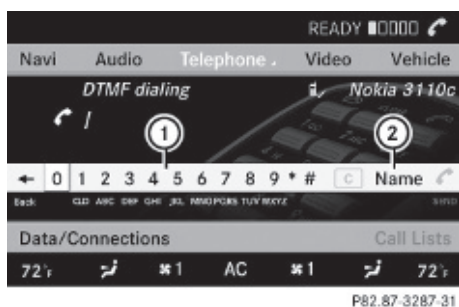



- ① Sending single digits via the predictive speller
  - ② Sending a phone book entry as a string
- ▶ **Sending single digits:** Select the desired digit via predictive speller ①. Each selected digit will be sent immediately.

You can, for example, save the number for an answering machine in the phone book. You can then search for the number for the answering machine in the phone book.

- ▶ Select Name.
- ▶ Select the desired phone book entry. The entry will be sent as a string immediately.
- ▶ **Back to call display:** Select  on the COMAND display.

**i** You can also use touch-tone dialing via the Voice Control System (▶ page 237).

### Ending an active call

- ▶ Press button  on the multifunction steering wheel or on the telephone keypad in the center console or select  via the telephone menu.

### Call waiting, call holding, and conference calls with multiple parties<sup>18, 19, 20</sup>

You can receive a call while you are already connected to another party (call waiting). You can also make another call yourself while still connected to another party.

You can switch between both parties or initiate a conference call.

You can toggle between two parties using call hold or initiate a conference call with up to two participants.

#### Call waiting<sup>21</sup>

When a call comes in while you are already talking to another party, the incoming call appears in the COMAND display. In addition, a signal sounds.

- ▶ **Rejecting:** Select Reject.
- or

- ▶ Press button  on the multifunction steering wheel or on the telephone keypad in the center console.

- ▶ **Accepting:** Select Accept.

or

- ▶ Answer the call via the Voice Control System (▶ page 237).

or

- ▶ Press button  on the multifunction steering wheel or on the telephone keypad in the center console.

The active call is put on hold. You are now connected to two parties. The new call you have accepted is now the active call.

- i** If your mobile phone does not support HFP 1.5 or higher, accepting the new call will end the active call.

<sup>18</sup> Function only available when supported by the respective network provider.

<sup>19</sup> Function only available when the mobile phone supports HFP 1.5 or higher.

<sup>20</sup> Limited availability of these functions with CDMA devices.

<sup>21</sup> Only available when the call waiting function on the mobile phone is activated.



## Calling an additional party

You can call another party during an active call. The active call is put on hold.

- ▶ Select **NEW** from the telephone menu and press .

or

- ▶ Press button  on the telephone keypad in the center console.
- ▶ Enter the number to call manually (▷ page 156) or from the phone book (▷ page 162).

## Switching between two parties (call hold)

When you are connected to two parties, the telephone menu appears as follows:

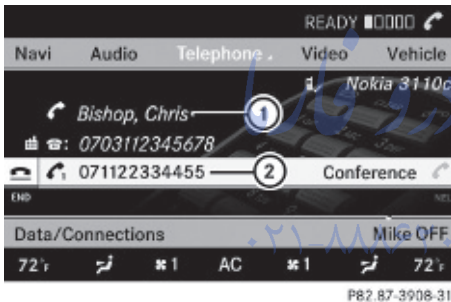

- ① Active call
- ② Call on hold

- ▶ **Switching to the other party:** Select ② using the COMAND controller.

or

- ▶ Press button  on the telephone keypad in the center console.

or

- ▶ Press button  on the multifunction steering wheel.

## Initiating a conference call

You can initiate a conference call with the active parties and parties that are on hold. All participants will be able to hear and talk to each other.

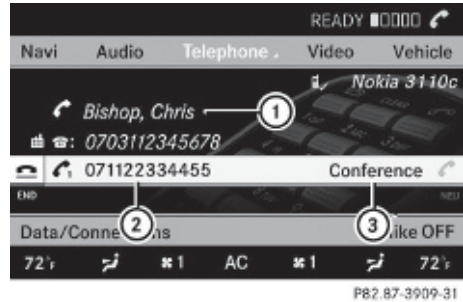

- ① Active call
- ② Call on hold
- ③ Initiating conference call

- ▶ **Initiating conference call:** Select Conference ③ using the COMAND controller.



## COMAND phone book and address book

 **Observe Safety notes, see page 76.**

The COMAND phone book is an extract of entries from the address book that contain at least one phone number.

The COMAND address book holds entries from various sources such as mobile phones, SD cards, imports from Bluetooth® devices, the COMAND phone book, or the navigation system. These entries can be used for making phone calls or for navigation.

## Importing contacts automatically

When a mobile phone is connected to COMAND via the Bluetooth® interface, the contacts of the mobile phone are imported into the COMAND phone book automatically. This may take some time, depending on the mobile phone. Phone book entries stored in the mobile phone itself or the SIM card may be imported, depending on the mobile phone. Contacts in the COMAND that have been imported automatically are identified by the symbols  or . Such contacts can only

be accessed when the respective mobile phone is connected to COMAND via the Bluetooth® interface.

### Importing contacts manually

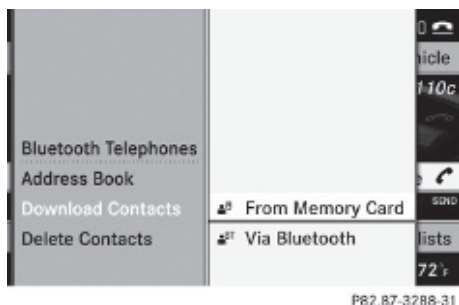

- i** Contacts that were imported manually can always be accessed. Contacts that were imported automatically can only be accessed when the respective mobile phone is connected to COMAND via the Bluetooth® interface.

Data can be imported

- from memory card
  - via the Bluetooth® interface (for example Bluetooth® phone or Bluetooth® PC)
- ▶ **Importing data:** Load the memory card or activate Bluetooth® in COMAND and the Bluetooth® mobile phone/PC. Refer to operating instructions of the respective Bluetooth® device.

- ▶ Select Data/Connections → Download Contacts → From Memory Card or Via Bluetooth.

- ▶ Select Add or Overwrite.

- i** The contact data, or vCards<sup>22</sup>, must be sent from the Bluetooth® device to COMAND. Refer to operating instructions of the respective Bluetooth® device.

- ▶ **Stopping data import:** Press .

or

- ▶ Press .

When the data have been imported, the message **Import successful** appears in the COMAND display.

When the COMAND phone book memory is full, the message **Memory full**. Contacts could not be imported completely. appears in the COMAND display.

- i** When switching to another main function, such as navigation, while importing data via Bluetooth®, the import is aborted. The import of vCards from a memory card however will be continued.

### Accessing contacts/details

You can access contacts via the list or the predictive speller.



Basic address book display

- ① List

 Entry containing data that can be used for route guidance

 Entry with voice name, see Voice Control System (▷ page 237)







 Address book entry

 Mobile phone entry

 SIM card entry

**BT** Bluetooth® entry

<sup>22</sup> vCards are electronic business cards used by e-mail applications, mobile phones, PADS, etc. to exchange contact information.

-  Memory card entry
-  Entry containing multiple phone numbers
- ② Two-row predictive speller
  -  Changing predictive speller language
  -  Changing character set
  -  Deleting selection
  -  Confirming selection
  -  Back

### Selecting contacts from list

- ▶ Phone book: Select Name.
- ▶ Address book: Select Data/Connections → Address Book.
- ▶ **Changing from predictive speller to list:** Press  until the predictive speller disappears.







or

- ▶ Select  .
- ▶ **Selecting contact:** Slide   or rotate   and press .

### Selecting contacts via predictive speller



- ▶ Phone book: Select Name.
- ▶ Address book: Select Data/Connections → Address Book.
- ▶ **Changing from list to predictive speller:** Select Back from the list.

or

- ▶ Press .
- ▶ **Selecting character:** Slide   or   and press . Repeat this procedure until COMAND changes to the list automatically. The first character you enter determines the first letter of the entry you are searching. When similar entries exist, the next character that is different is highlighted and thus offered for selection.

- ① You can also enter the characters via the telephone keypad in the center console.

### Displaying contact details

- ▶ Select Options → Details.  
The contact details appear.
- ▶ **Back to list:** Slide   until the list is highlighted.

### Creating/editing contacts

- ① This function is not available at a vehicle speed of above approximately 3 mph (5 km/h). When the vehicle speed is below approximately 2 mph (3 km/h), the function is available again.
- ① You can create address data in the address book directly. When you save phone numbers to the phone book, they are created in the address book. When you save a destination for navigation, COMAND creates an address book entry that contains the entire data usable for route guidance.

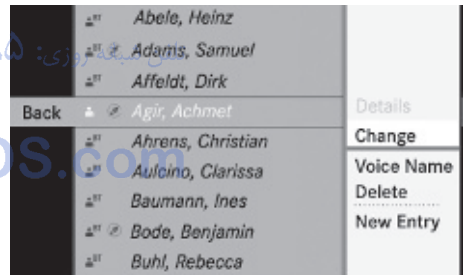

P82.87-3290-31

- ▶ Select the contact<sup>23</sup> (▷ page 160).
- ▶ Select Options → New Entry or Change.  
The input menu with the data fields appears.

<sup>23</sup> For changing contact only.

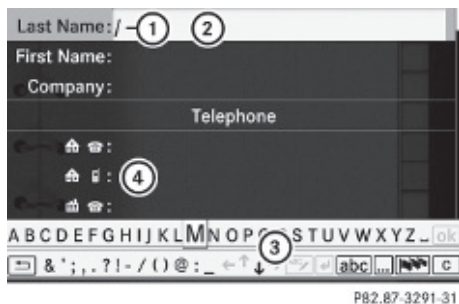

- ① Cursor
- ② Data field
- ③ Two-row predictive speller
  - Selecting language
  - Changing character set
  - Selecting upper or lower case
  - Back
  - Deleting selection
  - Confirming selection
- ④ Preset category

▶ Enter data into the data fields.

▶ **Entering data into data field:** Select the respective characters in predictive speller ③.

▶ **Moving the cursor:** Select the respective arrow in predictive speller ③.

▶ **Changing to other data field:** Slide until the predictive speller disappears.

▶ Slide and press .

or

▶ Select in the predictive speller.

▶ **Aborting data entry:** Select Back. When a data field contains data, you will be asked whether you would like to save the entry.

▶ **Saving data:** Select . The entry is created in the phone book and the address book.

## Deleting contacts



P82.87-3292-31

▶ **Selecting contact:** Select Data/Connections → Delete Contacts → Internal Contacts or Imported from memory card. or Imported via Bluetooth. or Delete All.

▶ **Confirming selection:** Press . You will be asked whether you want to delete the data.

▶ Select Yes.

Automatically imported contacts cannot be deleted (▷ page 159).

## Calling a number saved in an entry

### Via phone book

▶ Select Name.

▶ Select contact (▷ page 160).

▶ **Contact with multiple phone numbers (entry with symbol ):** Rotate and press .

or



▶ Press on the telephone keypad in the center console.

▶ **Contact with one phone number (entry without symbol ):** Press .



or

▶ Press on the telephone keypad in the center console.

### Via address book

- ▶ Select Data/Connections.
  - ▶ Open Address Book.
  - ▶ Select contact (▷ page 160).
  - ▶ Press .
  - ▶ Rotate  and press .
- or
- ▶ Select Options → Call.

### Starting route guidance to an entry

- i** You can use this function once you have saved a destination to the destination memory (▷ page 120). COMAND will then also save the entire destination data in the address book.
- ▶ Select an address book entry with symbol .
- ▶ Display the entry details and select the address data field.
- ▶ Select Options → Navigate → Start.
- i** You can only select the function Navigate when the address data field contains complete data usable for route guidance. Entries with complete, usable data is indicated by symbol .

### Voice names

- i** Voice names are made via the Voice Control System (▷ page 237).

### Adding or changing voice names

- i** You can add one voice name for each address book entry.
- ▶ Search for an address book entry. Entries with voice name are indicated by symbol .
- ▶ Select Options → Voice Name → Add or Change.  
Further operations is conducted via the Voice Control System. The Voice Control System will lead you through the menus.

### Deleting voice name

- ▶ Search for an address book entry with voice name.
- ▶ Select Options → Voice Name → Delete.  
You will be asked if you want to delete the voice name.

### Listening to a voice name

- ▶ Search for an address book entry with voice name.
- ▶ Select Options → Voice Name → Listen.  
You will hear the voice name.

### Call lists

COMAND displays separate lists of the phone calls that came in and went out while the mobile phone was in operation. The list of incoming calls includes the ones you have missed.

- i** The respective menu item can only be selected when calls were made or received via COMAND or when call lists were imported from the mobile phone.

### Selecting a call list entry

- ▶ Press shortcut button .
- ▶ Select Call lists.  
A menu appears.

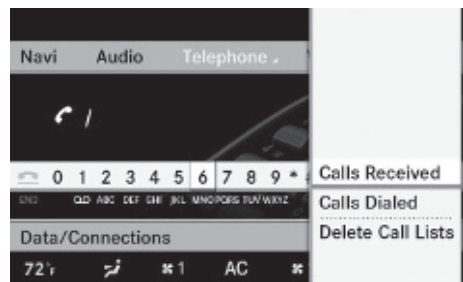

P82.87-3293-31

- ▶ Select Calls Received or Calls Dialed.

The respective list appears.

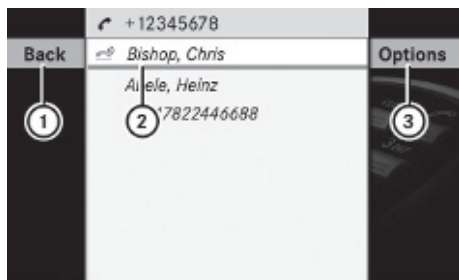

P82.87-3294-31

Example illustration: List of numbers you have dialed

- ① Close list
- ② Phone number and name if available
- ③ Options, for example saving

- ▶ **Selecting entry:** Slide .
- ▶ **Dialing number:** Press button .

Incoming calls that you have missed or rejected are indicated by a symbol in front of the name or number.

- ❗ Select Delete Call Lists to delete both lists at the same time. The Delete Call Lists option is only available when using a mobile phone that does not support automatic download of call lists.

### Saving list entries

When a call comes in, COMAND displays the phone number in the call list if the caller number is not stored in the address book. You can save this entry. The entry still appears in the call list. The phone number appears when the number has not been used yet. The caller name appears when the entry has been used already.

### Saving to address book as new entry

- ▶ Open a call list.
- ▶ Select the list entry.

- ▶ Select Options → Save Number.
- ▶ Select New Entry to create a new entry.
- ▶ Select a phone number category, for example Home.
- ▶ Select a telephone category, for example Cellular Phone Number.

Number category	Symbol (phone and address book)
Unclassified	None
Home	
Work	

Phone category	Symbol (phone and address book)
Unclassified	None
Cellular Phone Number	
Pager	
Car	
Landline	
Preferred	<input checked="" type="checkbox"/>

- ❗ When you have not classified the phone number and telephone category for a phone number, symbol appears in the display.

- ▶ Select Next (save).  
The input menu with the data fields appears. The data field for the phone number is filled-out automatically.

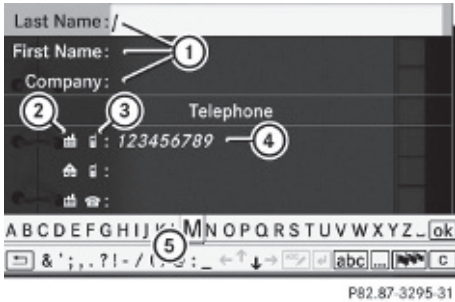

- ① Data fields for first name, last name, and company
  - ② Number category
  - ③ Phone category
  - ④ The data field for the phone number is filled-out automatically.
  - ⑤ Two-row predictive speller
- ▶ Proceed as described in section “Creating/editing contacts” (▶ page 161).

### Adding to an existing address book entry

- ▶ Open a call list.
- ▶ Select the list entry.
- ▶ Select Options → Save Number.
- ▶ Select Add to add an entry.
- ▶ Select a phone number category, for example Home.
- ▶ Select a telephone category, for example Cellular Phone Number.
- ▶ Select Next (save).  
The address book search menu appears.
- ▶ Select the desired entry (▶ page 160).
- ▶ Confirm the selection.  
COMAND saves the data when the entry contains less than five phone numbers for the selected phone number category.  
A corresponding message appears.  
When the entry contains five phone numbers already, you are asked whether you want to overwrite one of the existing phone numbers.
- ▶ Select Yes or No.

- ▶ Confirm the selection.  
When selecting Yes, a list with the existing five phone numbers appears.
- ▶ Select the phone number to overwrite.  
COMAND replaces the selected phone number with the new data.

## COMAND FM/AM radio

### Safety notes

#### ⚠ Warning!

Please devote your attention first and foremost to the traffic situation you are in. Before your journey, please familiarize yourself with the radio functions. Only use the COMAND when road and traffic conditions permit you to do so. Otherwise you could be involved in an accident in which you or others could be injured.

### FM/AM radio submenu overview

- ① The components and operating principles of COMAND can be found on (▶ page 76).

FarmaSOS.com



Radio (except Weather Band)	Presets (except Weather Band)	Channel (only Weather Band)	Info	FM or AM or WB	Sound
Save Station	Autostore	Channel list	Program Information	Switch to FM wave band	Treble
Frequency Entry	Preset station list			Switch to AM wave band	Bass
Show Station Info				Switch to Weather Band	Balance/Fader
<input type="checkbox"/> HD Radio					3D Sound
Active Source for Rear					
Rear OFF					

### Switching to radio mode

- ▶ Select Audio → FM/AM Radio.

or

- ▶ Press shortcut button  (> page 77) once or twice.

The radio display appears once you have switched to radio mode. You will hear the last tuned station/channel in the previously selected wave band, provided that the station/channel can be received.

- i** The number of times you have to press shortcut button  depends on the operating mode currently selected.

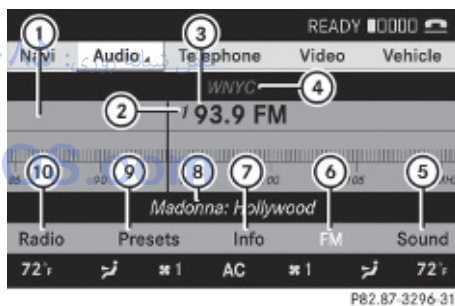

Example illustration: Radio mode in FM wave band

- ① Main area with frequency display
- ② Preset position of selected station
- ③ Frequency of selected station
- ④ Name of selected station; HD Radio™ stations with additional HD Radio™ symbol and program number (HD1, HD2...)
- ⑤ Sound settings
- ⑥ To switch to FM wave band, AM wave band or Weather Band

- ⑦ Additional information provided by radio station or HD Radio™ program information
- ⑧ Artist and song title (when provided by the radio station)
- ⑨ Preset options
- ⑩ Radio options

**i** Station name display ④ is available for the AM/FM wave band and can only be seen when it is switched on (> page 170) and if the station transmits a name.

## HD Radio™

### Important Notes

- i** HD Radio™ features include
  - digital broadcasts in the same wave band as analog AM/FM; the analog AM/FM stations remain at their current place on the dial
  - the ability to broadcast multiple program streams over a single FM/AM frequency (e.g. HD1, HD2, etc.)
  - static-free, clear reception
  - FM stations offer CD quality sound, AM stations sound like analog FM stations
  - a variety of data services, including text-based information – artist name, song title, etc. – shown on the display

More information on HD Radio™ you will find at [www.hdradio.com](http://www.hdradio.com).

**i** Note that subprograms and program info shown in illustrations are dependent on program content delivered by the radio stations. Program content is subject to change. Therefore, subprograms and program info shown in illustrations and descriptions contained in this manual may differ from the subprograms and program info delivered by the radio station.

### Switching to HD Radio™

**i** Since HD Radio™ stations are embedded in the AM/FM wave band, HD Radio™ operation is very similar to analog AM/FM radio operation.

You will only hear HD Radio™ programs if the HD Radio™ function is activated in the radio submenu.

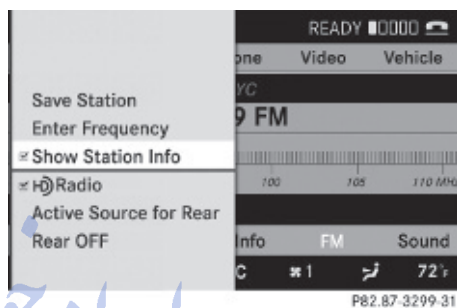

- ▶ Select Radio → HD Radio in the radio display.  
If the check box  is checked, HD Radio™ is activated.

### Switching wave bands

You can switch between the FM, AM and WB (Weather Band) wave bands.

- ▶ Select Audio → FM/AM Radio → FM or AM or WB.

You will hear the last tuned station on the selected wave band.

### Selecting stations/channels

You have the following selection options:

- The search function
- The station presets
- The manual frequency entry
- The channel list (Weather band only)

### Selecting stations/channels using the search function

- ▶ Slide or rotate when the main area is selected.  
Depending on the direction in which the controller is being slid or rotated, the system searches upward or downward and stops at the next receivable station/channel.

or

- ▶ Press and hold button or on the multifunction steering wheel<sup>24</sup>.

### Selecting stations using station presets

- i** This function is not available for Weather Band.

- ▶ Select Audio → FM/AM Radio → FM or AM.
- ▶ Select Presets.

or

- ▶ Press when the main area is selected.  
The preset menu appears. The dot in front of a preset position indicates that the currently selected station is saved there.
- ▶ Select station preset by rotating or sliding and press .

or

- ▶ Enter a position number with the telephone keypad using buttons - (▷ page 79).

or

- ▶ Press button or on the multifunction steering wheel briefly<sup>24</sup>.

- i** Vehicles with rear multicontour seats: Rear occupants can also select a station using the buttons on the rear armrest (▷ page 80).

### Selecting stations by entering the frequency manually

- i** This function is not available for Weather Band.

- ▶ Select Audio → FM/AM Radio → FM or AM.

### Entering the frequency using the COMAND controller

- ▶ Select Radio → Enter Frequency.  
The menu for manual frequency entry appears.
- ▶ **Exiting menu without making an entry:** Press back button in the center console (▷ page 87).
- ▶ **Increasing or decreasing number:** Slide or rotate .

- i** You can only select available frequencies.

- ▶ **Selecting the next number:** Slide .

- ▶ **Confirming frequency entry:** Press . COMAND tunes in to the frequency entered.

- i** If you enter a frequency which is outside the frequency range, COMAND tunes in to the next lowest frequency.

### Entering the frequency using the telephone keypad

- ▶ Press button on the telephone keypad (▷ page 79).
- ▶ Enter frequency using buttons - . COMAND tunes in to the frequency entered.

### Selecting channels using the WB channel

- i** This function is only available for Weather Band.

<sup>24</sup> Function is only available if the Audio menu is selected in the instrument cluster.

- ▶ Select Audio → FM/AM Radio → WB → Channel.

or

- ▶ Press when the main area is selected. The channel list appears. The dot • in front of a list entry indicates the currently selected channel.
- ▶ Select channel by rotating or sliding and press .

- i** Vehicles with rear multicontour seats: Rear occupants can also select a channel using the buttons on the rear armrest (> page 80).

### Saving stations

- i** Twenty stations can be saved in each wave band except for Weather Band.

You have the following options:

- Saving stations manually
- Saving stations using the autostore function

### Saving stations manually

#### Option 1

- ▶ Select Audio → FM/AM Radio → FM or AM.
- ▶ Select Radio → Save Station.

#### Option 2

- ▶ Press when the main area is selected.

#### Option 3

- ▶ Select Audio → FM/AM Radio → FM or AM.
- ▶ Select Presets.

All three of these will call up a station preset screen. The dot • in front of a preset position indicates that the currently selected station is saved there.

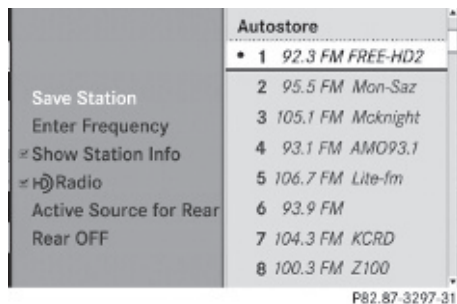

- ▶ **Selecting a preset position:** Slide or rotate .

### Saving a station to a selected preset position

If you have called up the station preset screen using option 1:

- ▶ Press briefly.

In options 2 and 3:

- ▶ Press and hold until you hear a signal. The station is saved.

### Saving using the autostore function

- i** This function is not available for Weather Band. The autostore function saves receivable stations as presets in order of their reception quality. All stations saved manually in the preset memory will be lost if COMAND finds 20 stations. If COMAND finds less than 20 stations, for example 9, then the stations saved in preset positions 1 – 9 will be overwritten.

#### Option 1

- ▶ Press when the main area is selected.
- ▶ Select Autostore.

#### Option 2

- ▶ Select Audio → FM/AM Radio → FM or AM.
- ▶ Select Presets → Autostore.

### Option 3

- ▶ Select Audio → FM/AM Radio → Radio → Save Station → Autostore.

#### Station name display

- i In the FM wave band, COMAND can show the name of the station currently tuned in. Station name display 1 can only be seen when it is switched on and if the station transmits a name.



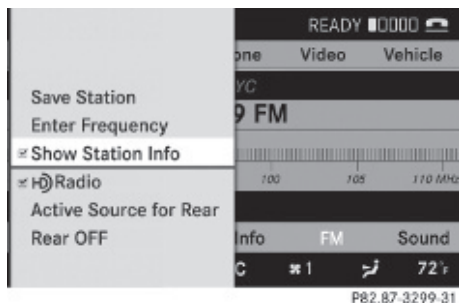

- ▶ **Switching the station name display on/off:** Select Audio → FM/AM Radio → FM → Radio → Show Station Info. The station name display 1 is switched on or off, depending on the previous setting. When the station name display 1 is switched on, a checkmark appears in front of the Show Station Info menu item.



#### Displaying information

You can display program information or other additional information when provided by the radio station you are listening to.

- ▶ Select Info (if available) in the radio display. The available information appears. The content and scope of the information depends on the radio station.
- ▶ **Closing screen:** Slide ←○→, press  or press back button .

### COMAND satellite radio

#### Safety notes

##### Warning!

Please devote your attention first and foremost to the traffic situation you are in. Before your journey, please familiarize yourself with the radio functions.

Only use the COMAND when road and traffic conditions permit you to do so. Otherwise you could be involved in an accident in which you or others could be injured.

## Satellite radio submenu overview

**i** The components and operating principles of COMAND can be found on (▷ page 76).

Sat. Radio	Presets	Info	Category	Sound
Channel List	Station presets	Showing program info	Selecting category	Treble
Save Channel				Bass
Enter Channel				Balance/Fader
Service				3D Sound

## Introduction to satellite radio

**i** A subscription to SIRIUS XM Satellite Radio service provider is required for the satellite radio operation described in this section. Contact an authorized Mercedes-Benz Center for details and availability for your vehicle.

SIRIUS XM Satellite Radio provides over 130 channels of digital-quality radio, including 100% commercial-free music, sports, news and entertainment. SIRIUS XM Satellite Radio uses a fleet of high-power satellites to broadcast 24 hours per day, coast to coast, in the contiguous U. S. and Canada.

This diverse, satellite-delivered programming is available for a monthly subscription fee.

For more information and service availability call the SIRIUS XM Service Center at 1-888-539-7474, or visit

- [www.sirius.com](http://www.sirius.com) (USA)
- [www.siriuscanada.ca](http://www.siriuscanada.ca) (Canada)

**i** Satellite radio service may be unavailable or interrupted from time to time for a variety of reasons, such as environmental or topographic conditions and other things we cannot control. Service might also not be available in certain places (e.g. in tunnels, parking garages, under leafy trees, or within or next to buildings) or near other obstructions. In such situations, the

satellite radio's main menu shows the No Service screen. At this point, the radio's functions are restricted.

## Switching to satellite radio

▶ Select Audio → Sat. Radio.

or

▶ Press shortcut button  (▷ page 77) once or twice. The satellite radio menu appears if it was the last active radio mode. The screen which then appears depends on the activation status of the satellite radio service.

The following conditions are possible:

- Satellite radio service is not activated (only the preview channel is displayed).
- Satellite radio service is activated.

## Satellite radio service is not activated

The telephone number of the SIRIUS XM Service Center and the twelve-digit electronic serial number (SIRIUS-ID) of the particular receiver are displayed.

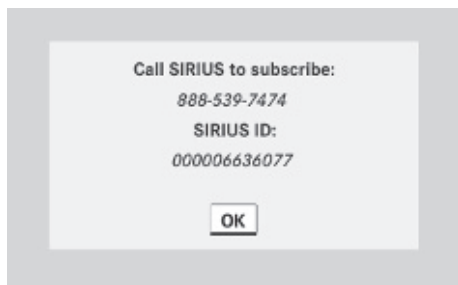

P82.87-2361-31

This information is required when calling the SIRIUS XM Service Center for an activation request.

- i** Activating the satellite radio service might not be available in certain places (e.g. in tunnels, parking garages, under leafy trees, or within or next to buildings). If a subscription is not included with system purchase, credit card information is required to activate your account.

The activation process takes approximately 5 to 10 minutes after calling the SIRIUS XM Service Center.

- i** It is also possible to activate the satellite radio service online. To do so please visit SIRIUS XM Satellite Radio's website at [www.sirius.com](http://www.sirius.com) (USA) or [www.siriuscanada.ca](http://www.siriuscanada.ca) (Canada).

► **Closing screen:** Press .

### Preview channel



P82.87-3302-31

- i** If the satellite radio service has not been activated, only the preview channel is available. You cannot tune in another channel. If you try to do this, you will see the screen described in the section "Satellite radio service is not activated" (► page 171).

### Satellite radio service is activated

The main satellite radio menu appears. You will hear the last tuned channel, provided that it can be received.

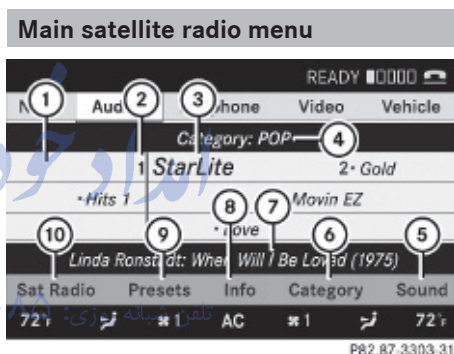

P82.87-3303-31

- ① Main area with channel display
- ② Preset position of selected channel
- ③ Selected channel
- ④ Selected program category
- ⑤ Sound settings
- ⑥ To select program category
- ⑦ Artist and song title
- ⑧ Other channel information
- ⑨ Preset options
- ⑩ Satellite radio options

- i** Main area ① can show all channels included in your subscription. Which channels are shown depends on the selected program category ④. Note that categories and channels shown in illustrations are dependent on programming content delivered by the



service provider. Programming content is subject to change.



Therefore, channel and categories shown in illustrations and descriptions contained in this manual may differ from the channels and categories delivered by the service provider.

### Selecting program category

- i** The channels are categorized. Categories allow you to tune to stations broadcasting a certain type of program.

Satellite radio channels are split up into categories such as News, Sports, Rock, or Country, if available.

- ▶ Select Audio → Sat. Radio → Category.  
The category list appears.

- ▶ Select category by rotating  or sliding  and press .

When selecting a channel using the channel search function or the channel list, you have access to the channels you subscribe to and which are included in the selected category.

- i** When you select the category All Channels, you have access to all the channels you subscribe to, regardless of category, when you are tuning in a channel using the channel search function or the channel list.

### Tuning in channels

You have the following selection options:

- the channel search function
- the channel presets
- the manual channel number entry
- the channel list

### Tuning in channels using channel search function

- i** If you try to tune in a channel when the satellite radio service is not activated, you will see the screen described in the section “Satellite radio service is not activated” (▷ page 171).

- ▶ Slide  or rotate  when the main area is selected.

Depending on the direction in which the controller is being pressed or rotated, the system searches upward or downward and stops at the next receivable channel.

- i** Which channels are found by the channel search function depends on which channels you have subscribed to and the program category you have selected (▷ page 173).

### Tuning in channels using channel presets

- ▶ Select Audio → Sat. Radio → Presets.



or

- ▶ Press  when the main area is selected. The preset menu appears. The dot • in front of a preset position indicates that this is the channel currently selected and being listened to.



P82.87-3304-31

- ▶ Select station preset and briefly press .
- or

- ▶ Enter a position number with the telephone keypad using buttons  -  (▷ page 79).  
COMAND tunes in the corresponding channel as long as it is included in your subscription and is still available.

- i** Vehicles with rear multicontour seats:  
Rear occupants can also select a channel using the buttons on the rear armrest (▷ page 80).

If the channel is not included in your subscription, you will see the message described in the section “Satellite radio service is not activated” (▷ page 171).





If the channel is no longer available, you will see the message Invalid Channel.

- ▶ **Closing message:** Press .

### Tuning in channels using manual channel number entry

- i** If you try to tune in a channel when the satellite radio service is not activated, you will see the screen described in the section “Satellite radio service is not activated” (▷ page 171).

### Entering the channel number using the COMAND controller





- ▶ Select Audio → Audio → Sat. Radio → Sat. Radio → Channel Entry.  
The menu for manual channel number entry appears.
- ▶ **Exiting menu without making an entry:**  
Press back button  in the center console (▷ page 87).
- ▶ **Increase or decreasing number:** Slide   or rotate .

- ▶ **Selecting next number:** Slide  .

- ▶ **Confirming channel entry:** Press .

Further operation depends on whether the selected channel number is valid or if the channel is included in your subscription.

### Entering the channel number using the telephone keypad

- ▶ Press button  on the telephone keypad (▷ page 79).
  - ▶ Enter channel number using buttons   - .
- Further operation depends on whether the selected channel number is valid or if the channel is included in your subscription.

### Channel number is valid and channel is included in subscription

COMAND tunes in the channel entered.

### Channel number is invalid

You will see the message Invalid Channel.





- ▶ **Closing message:** Press .

### Channel number is valid but channel is not included in subscription

You will see the screen described in the section “Satellite radio service is not activated” (▷ page 171).

- ▶ **Closing display:** Press .

### Tuning in channels using the channel list

- ▶ Select Audio → Audio → Sat. Radio → Sat. Radio → Channel List.  
The channel list appears. The dot  in front of a list entry indicates the currently selected channel.
- ▶ Select channel by rotating  or sliding   and press .

- i** The contents of the channel list depends on which channels are included in your subscription and which program category you have selected (▷ page 173). If satellite

radio service is not activated, the channel list contains only the preview channel.

### Saving channels

**i** There are 20 preset positions available.

#### Option 1

▶ Select Audio → Sat. Radio → Sat. Radio → Save Channel.

#### Option 2

▶ Press  when the main area is selected.

#### Option 3

▶ Select Audio → Sat. Radio → Presets.

All three of these will call up a preset menu. The dot • in front of a preset position indicates that this is the channel currently selected and being listened to.



▶ **Selecting a preset position:** Slide   or rotate  .

### Saving a channel to a selected preset position

If you have called up the channel preset screen using option 1:

▶ Press  briefly.

In options 2 and 3:

▶ Press and hold  until you hear a signal. The channel is saved.

### Displaying information

▶ Select Audio → Sat. Radio → Info (if available).

**i** If the program provider does not offer any information, the Info menu item cannot be selected.

You will see a screen that may contain the following information:

- the selected program category
- the selected channel
- the artist of the track currently being played
- the name of the current track

**i** The program provider determines what information is displayed on the screen. COMAND shows no more than two lines per item of information. If an item of information is too long, COMAND shortens it.

▶ **Closing screen:** Slide   or press .

### Channel update

The service provider may conduct a channel update.

During the update, the message Updating channels... will appear on the display. No functions can be operated in satellite radio mode during the update.

### Calling SIRIUS XM Service Center

- i** It may be necessary to call the SIRIUS XM Service Center if, for example:
- You want to cancel the subscription or resubscribe at a later date.
  - You have forgotten to pay the bill.
  - You sell the vehicle.
- ▶ Select Audio → Sat. Radio → Sat. Radio → Service.  
The telephone number of the SIRIUS XM Service Center and the twelve-digit electronic serial number (SIRIUS-ID) of the particular receiver are displayed.
- ▶ **Closing screen:** Slide ←→ or press ↻.

### COMAND audio CD/audio DVD/MP3

#### Safety notes

##### Warning!

COMAND and the CD/DVD drive in the rear are classified as Class 1 laser products. You must not open the casing. There is a risk of exposure to invisible laser radiation if you open the casing, or if the casing is faulty or damaged.

COMAND and the CD/DVD drive in the rear do not contain any parts that you are able to maintain yourself. For safety reasons, all maintenance work must be carried out by qualified technicians.

##### Warning!

Only carry out the following when the vehicle is stationary:

- Inserting a disc/device
- Ejecting a disc/device

There is a risk of accident by being distracted from road and traffic conditions if you load a disc/device while the vehicle is in motion.

Bear in mind that at a speed of just 30 mph (approximately 50 km/h), your vehicle is

covering a distance of 44 feet (approximately 14 m) every second.

### Notes about MP3 mode

#### Permissible media for MP3/WMA files

- CD-R and CD-RW
- DVD-R and DVD-RW
- DVD+R and DVD+RW
- SD cards
- USB flash drives
- iPod®
- MP3 players

#### Permissible file systems

- ISO9660/Joliet for CDs
- UDF for DVDs
- FAT16 or FAT32 for storage media

#### Multisession CDs

For multisession CDs, the first session type of the CD determines how COMAND will process the CD.

For example, if the first session type is according to the audio CD standard and the second session type is according to the data CD standard containing MP3/WMA tracks, COMAND will treat the CD as a conventional audio CD. This means that it is only possible to access the audio CD tracks. Access to the MP3/WMA tracks is not possible.

Similarly, if the first session type is according to the data CD standard containing MP3/WMA tracks and the second session type is according to the audio CD standard, COMAND will treat the CD as a data CD. This means that it is only possible to access the MP3/WMA tracks. Access to the audio CD tracks is not possible.

## File structure on a disc

When you create an audio disc, the tracks can be organized in folders. A disc may contain a maximum of 4000 tracks.

The directory depth may not exceed a maximum of 8 levels. The system will ignore files in lower levels.

## Notes on USB storage media

Do not store data other than audio data on a USB storage medium. Doing so will increase the time required to initialize the USB storage medium.

A maximum of 8 directory levels with up to 4000 tracks each are supported.

For information on connecting USB storage media to the built-in USB socket in the glove box see (> page 80).

## Track and folder names

When you create an audio medium, you can assign names to the tracks and folders. COMAND uses these names for the corresponding display. Empty folders or folders which contain data other than MP3/WMA tracks are not displayed by COMAND. If MP3/WMA files are saved in the root directory itself (uppermost directory on storage medium), the root directory will also be treated as a folder. COMAND will then show the name of the root directory as the folder name.

You must observe the following when assigning track names:

- Track names must have at least one character.
- Track names must have the extension “mp3” or “wma”.
- There must be a period between the track name and the extension.

Example of a correct track name:

Track1.mp3

## Compatible file systems and compression methods

COMAND supports the following formats:

- MPEG1 Audio Layer 3 (MP3)<sup>25</sup>
- Microsoft Windows Media Audio (WMA) V2, V7, V8 or V9 that are not copy-proof

## Bit and sampling rates

### MP3

COMAND supports MP3 files of the following types:

- Fixed and variable bit rates from 32 kbit/s up to 320 kbit/s
- Sampling rates of 24 kHz to 48 kHz

### WMA (Windows Media® Audio)

Windows Media® Audio (WMA) is an audio data compression technology developed by Microsoft®.

COMAND supports WMA files of the following types:

- Fixed and variable bit rates from 5 kbit/s up to 384 kbit/s
- Sampling rates of 8 kHz to 48 kHz

COMAND does not support WMA files of the following types:

- DRM (Digital Rights Management) coded files
- variable bit rates
- Lossless Settings
- WMA Pro
- 5.1-Surround

- **i** Only use tracks with a bit rate of above 128 kbit/s and a sampling rate of above 44.1 kHz. Lower rates will cause an audible

<sup>25</sup> MPEG Layer 3 audio-coding technology under license of Fraunhofer-Institut for Integrated Circuits (IIS) and Thomson

loss of sound quality. This applies in particular when you have switched on 3-D sound.

### Notes on copyright

The music tracks that you create and play back in the MP3 or WMA format are generally subject to copyright protection in accordance with the applicable international and national regulations.

In many countries, reproductions are not permitted without the prior consent of the copyright holder, not even for private use. Make sure that you know the applicable copyright regulations and that you comply with these.

If you own these rights yourself, e.g. for your own compositions and recordings, or the copyright holder has granted you permission, these restrictions do not apply.

### Notes about audio DVD operation

COMAND can playback commercially available, prerecorded audio DVDs that bear the following label. You will usually find the label on the DVD booklet, the inlay, or the DVD itself.



**i** Audio DVDs differ from recordable DVD-R and DVD-RW discs.

Data on audio DVDs are stored either in uncompressed format or in lossless compressed format. The sound quality on audio DVDs is therefore better than on recordable DVDs that contain MP3 data because the MP3 format uses a lossy type of compression.

You cannot delete data from or record additional data to commercially available, prerecorded audio DVDs.

Please note the following information about CDs/DVDs and pay special attention to the notes on copied and/or self-written CDs/DVDs.

**i** The last track on many audio DVDs does not contain audio data. COMAND will then change to the next medium. This behavior is system-induced and does not indicate a system malfunction.

### Notes about CDs/DVDs

**i** Audio CDs with copy protection are not compatible with the CD audio standard and therefore may not be able to be played by COMAND.

There may be playback problems when playing copied discs.

There is a large variety of discs, disc-writing software and writers available. This variety means that there is no guarantee that the system will be able to play discs that you have written/copied yourself.

There may be playback problems if you use CD-R or CD-RW type discs you have copied yourself with a storage capacity of more than 700 MB. These CDs are not compatible with currently applicable standards.

**!** Do not affix stickers or labels to the discs. These could peel away and damage COMAND. COMAND is designed to hold discs which comply with the IEC 60908 standard. You can therefore only use discs with a maximum thickness of 1.3 mm.

If you insert thicker discs, e.g. those that contain data on both sides (DVD on one side and audio data on the other), they cannot be ejected and can damage COMAND.

Do not use CDs with a diameter of 8 cm. Attempting to play discs with a diameter of 8 cm or playing such discs with an adapter may cause damage COMAND.

Such damages are not covered by the Mercedes-Benz Limited Warranty.  
Only use round discs with a diameter of 12 cm.

### Notes about handling CDs/DVDs

- Only hold discs by the edge.
- Handle discs carefully to prevent playback problems.
- Avoid getting scratches, fingerprints and dust on discs.
- Clean discs from time to time with a commercially-available cleaning cloth. Do not wipe them with a circular motion, but only in straight lines from the center outwards.
- Only use a pen designed for such a purpose to label discs.
- Place discs back in their boxes after use.
- Protect discs from heat and direct sunlight.

### Inserting/ejecting CDs and DVDs

 **Observe Safety notes, see page 176.**

- i** If the CD/DVD has a printed side, this must face upwards when the CD/DVD is inserted. If neither side is printed, the side to be played should face downwards.

### DVD changer

The DVD changer contains a built-in magazine with six trays.

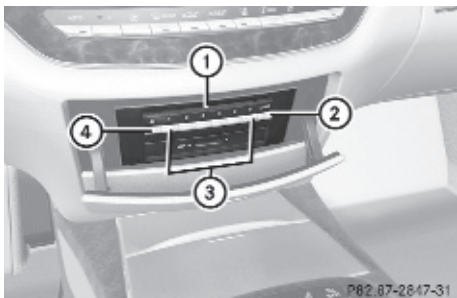

Magazine tray status:

- Indicator lamp on magazine tray button **③** is off: Magazine tray is empty
  - Indicator lamp on magazine tray button **③** is on: Magazine tray is loaded
  - Indicator lamp on magazine tray button **③** flashes: Magazine tray ready to be loaded
- **Loading individual tray:** Press button **③** of the magazine tray you want to load.
- When magazine tray is loaded, remove the disc from slot **①**.
- Wait until the message *Please insert disc \_.* appears in the COMAND display and the indicator lamp on magazine tray button **③** that you pressed flashes in quick succession.
- Insert the disc into slot **①**.  
When the disc was inserted correctly and is of permissible type, the disc is played back.
- **Loading all trays:** Press button **②**.  
The DVD changer evaluates which magazine trays are loaded and changes to the first empty tray.
- Wait until the message *Please insert disc \_.* appears in the COMAND display and the indicator lamp on the respective magazine tray button flashes in quick succession.
- Insert the disc into slot **①**.  
The DVD changer changes to the next empty tray.
- Repeat the previous two steps until all magazine trays are loaded.  
When the disc was inserted correctly and is of permissible type, the disc that was loaded last is played back.
- i** When you remove a disc while another one is played back, the DVD changer stops the playback. After removing the disc, playback is continued.



- ▶ **Removing a disc:** Press desired magazine tray button ③.
- ▶ Remove the disc from slot ①.  
If you do not remove the disc from slot ①, the DVD changer will automatically pull it back in after a short time.
- ▶ **Removing all discs:** Press button ④.  
The DVD changer ejects the disc from the currently selected magazine tray.
- ▶ Remove the disc from slot ①.  
The DVD changer changes to the next loaded magazine tray and ejects the disc.
- ▶ Repeat the last step until all magazine trays are empty.

### CD/DVD drive (vehicles with Rear Seat Entertainment System)

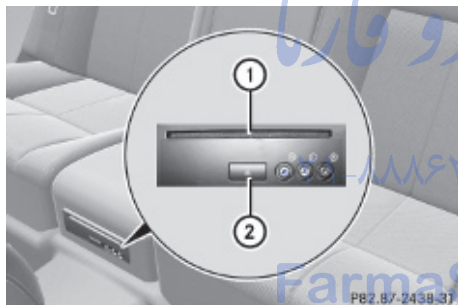

- ▶ **Press button ②** before loading a disc. This will ensure that the drive is empty.
- ▶ **Removing disc:** Press button ②.
- ▶ When magazine tray is loaded, remove the disc from slot ①.  
If you do not remove the disc from slot ①, the drive will automatically pull it back in after a short time and playback continues.
- ▶ **Loading disc:** Insert the disc into slot ①.
- ▶ **Playing back disc:** Select the main function Disc in the Rear Seat Entertainment System (▶ page 190).

### Inserting/ejecting an SD card

⚠ Observe Safety notes, see page 176.

- ▶ **Some SD cards might not be suitable for use in temperatures that may occur in a vehicle.**  
SD cards with over 32 GB of storage capacity are not recommended.  
Due to the number of SD cards available today, Mercedes-Benz cannot ensure that playback from every SD card is possible.



- ▶ **Loading SD card:** Push the SD card into slot ①. The side with the bevel must point to the right.  
When the SD card contains MP3 tracks, COMAND will start playback automatically.
- ▶ **Removing SD card:** Briefly push on SD card in slot ① and release it.
- ▶ Pull the SD card out.

### Audio CD/audio DVD/MP3 submenu overview

- ▶ **The components and operating principles of COMAND can be found on (▶ page 76).**

CD, DVD-A, MP3	II/■/▶ (audio DVD mode only)	REC (audio CD mode only)	Search	Media	Sound
Group (audio DVD mode only)	Pausing playback II	Copying audio data to hard disk	Current Track List	Selecting medium	Treble
Normal Track Sequence	Stopping playback ■		Folder		Bass
Medium Mix	Restarting playback ▶		Keyword Search		Balance/Fader
Track List Mix (MP3 mode only)			Playlists		3D Sound
Gracenote Media Database (audio CD mode only)			Artists		
Active Source for Rear			Albums		
Rear OFF			Track		
<input type="checkbox"/> Show Track Information (MP3 mode only)			Genres		
			Composers		
			Year		

### Switching to audio CD, audio DVD or MP3 mode

- ▶ Load CD/DVD (▷ page 179) or SD card (▷ page 180).

or

- ▶ Connect a USB device to the USB socket in the glove box.

or

- ▶ Select Audio → Media, then select Disc, Memory Card, Music Register, USB<sup>26</sup>, Media Interface ...

or

- ▶ Press shortcut button  once or twice.

<sup>26</sup> Selects the built-in USB socket in the glove box.

**i** Shortcut button  takes you directly to the previously set disc mode (audio CD/DVD, MP3-CD/DVD, video DVD). The number of times you have to press the shortcut button depends on the previously set mode.

### Example display in audio CD mode

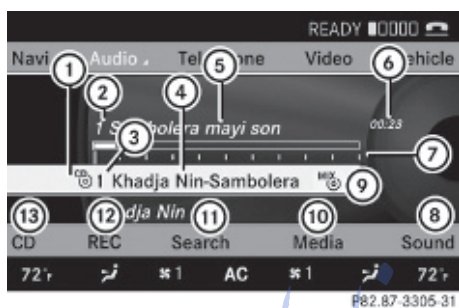

- ① Disc type
- ② Track number
- ③ Disc number
- ④ Disc name (only when saved on the disc)
- ⑤ Track name (only when saved on the disc)
- ⑥ Elapsed track time
- ⑦ Elapsed track time and track number (graphical display)
- ⑧ Sound settings
- ⑨ Current playback option
- ⑩ Medium selection
- ⑪ Track search
- ⑫ Copying audio data to hard disc
- ⑬ CD functions

### Example display in audio DVD mode

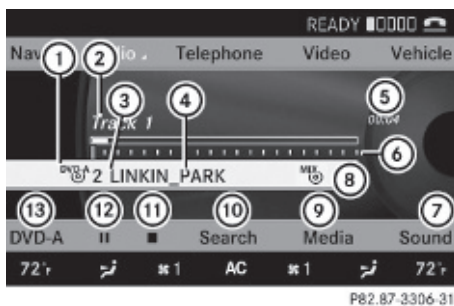

- ① Disc type
- ② Track name
- ③ Disc number
- ④ Disc name (only when saved on the disc)
- ⑤ Elapsed track time
- ⑥ Elapsed track time and track number (graphical display)
- ⑦ Sound settings
- ⑧ Current playback option
- ⑨ Medium selection
- ⑩ Track search
- ⑪ Stop function
- ⑫ Pause function
- ⑬ Audio DVD functions

### Example display in MP3 mode

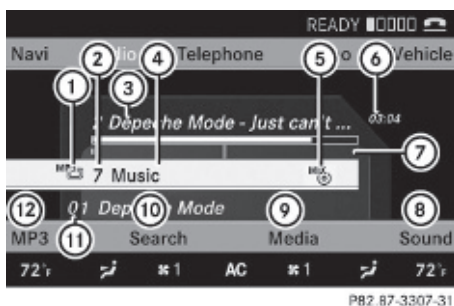



- ① Disc type
- ② Disc number
- ③ File name or track name (ID3 tags)
- ④ Medium or folder name
- ⑤ Current playback option

- ⑥ Elapsed track time
- ⑦ Elapsed track time and track number (graphical display)
- ⑧ Sound settings
- ⑨ Medium selection
- ⑩ Track search
- ⑪ Artist (ID3 tags)
- ⑫ MP3 functions

## CD/DVD/MP3 functions



### Stop function

**i** This function is only available in audio DVD mode.







- ▶ **Stopping playback:** Select Audio → Media → DVD-A →  (twice).
- ▶ **Restarting playback:** Select Audio → Media → DVD-A → . Playback restarts at the beginning of the DVD.

### Pause function



#### In audio CD, audio DVD and MP3 mode

- ▶ **Pausing playback:** Press button  on the multifunction steering wheel briefly.
- ▶ **Continuing playback:** Press button  on the multifunction steering wheel briefly once more.

#### In audio DVD mode only

- ▶ **Pausing playback:** Select Audio → Media → DVD-A → .  appears instead of .
- ▶ **Continuing playback:** Select Audio → Audio → DVD-A → .  appears instead of .

## Selecting CD/DVD/MP3 media

- ▶ Select Audio → Media.  
The media list appears. The dot • indicates the currently selected medium.
  - ▶ Select a medium.
- or
- ▶ Enter a media number with the telephone keypad using buttons  -  (▷ page 79).

## Selecting a track

### Selecting by skipping tracks



- ▶ **Skipping forward or backward:** Slide   or rotate  .

or



- ▶ Press button  or  on the multifunction steering wheel<sup>27</sup>.

**i** The skip forward function takes you to the next track. The skip backward function takes you to the beginning of the current track, provided it has been played for longer than 8 seconds. When the track has been played for less than 8 seconds, you will skip to the track before the current one. When you switch on the option Random Tracks, the track is chosen at random.

### Selecting a track using the telephone keypad

- ▶ Press button  on the telephone keypad (▷ page 79).
- ▶ Enter track number using buttons  - .



## Fast forward/rewind

- ▶ Select the main area.
- ▶ Slide   and hold until the desired track part is reached.

<sup>27</sup> Function is only available if the Audio menu is selected in the instrument cluster.

## Track search

You can use the following criteria to search for tracks:

- Current Track List
  - Folder
  - Keyword Search
  - Playlists
  - Artists
  - Albums
  - Tracks
  - Genres
  - Composers
  - Year
- ▶ Press  during playback while the main area is selected.
- or
- ▶ Select Audio → Search.  
The list of search criteria appears.
- ▶ Select a search criteria and press .
- ▶ Select a track and press .

## Copying audio data to hard disk (audio CD mode only)

You can copy audio data to the internal hard disk while in audio CD mode using the REC function.

- ▶ Select Audio → Media.
- ▶ Select an audio CD.
- ▶ Select REC.  
The copy menu appears.

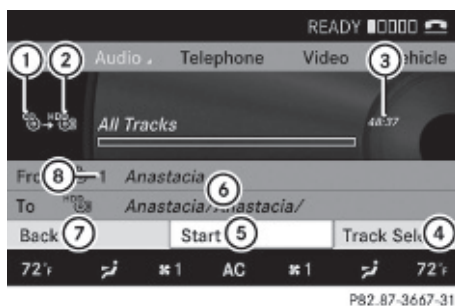

- ① Source
- ② Target
- ③ Total track length of source files
- ④ Track selection
- ⑤ Starting copy process
- ⑥ Name of source CD and target storage name
- ⑦ Back without copying
- ⑧ Medium position in media list

- ▶ **Selecting audio data:** Select Track Select..

The track list appears.

- ▶ Select All Music Files or select individual tracks.

- ▶ Select Continue.

The copy menu appears.

- ▶ **Copying audio data:** Select Start.

The copying process starts. The status bar  (> page 185) shows the copying progress.

- i** Do not remove the disc from which you are copying during the process. Otherwise the copied data on the hard disk will be corrupt.

- ▶ **Back without copying:** Select Back.



### ⑨ Status bar

**i** The copying process may take a while depending on the size of the data. If the required storage space is insufficient, a message appears.

► **Aborting copying process:** Select Cancel.

The audio data that have been copied already are stored on the hard disk.

► **Deleting audio data:** See (► page 199).

### Gracenote® media database

**i** This function is only available in audio CD mode and when operated from the built-in hard disk.

The COMAND hard disk contains a version of the Gracenote® Media Database, Emeryville, California, USA. Some audio displays show the company logo in the lower right to indicate availability.



A large number of audio discs contain text information. COMAND uses this information to display the artist, the album name and the track name.

When the audio disc does not contain text information, COMAND can recognize unknown audio tracks using the Gracenote® Media Database. The respective information must be stored in the Gracenote® Media Database and the function Gracenote Media Database in the CD submenu must be activated.

COMAND will then display the accompanying data such as artist, album name and track name.

When COMAND accesses the Gracenote® Media Database while reading an audio disc, the following message appears:



### Activating Gracenote® Media Database

► Select Audio → Media → CD → Gracenote Media Database

If the check box  is checked,

Gracenote® Media Database is activated.

### Setting the audio format

This function lets you choose the audio format that you would like COMAND to play and is only available in DVD-Audio mode.

**i** The tracks on an audio DVD can be stored in various audio formats. The number of audio formats depends on the audio DVD.

► Select Audio → Media → DVD-A → Group.

- i** The Group menu item cannot be selected if only one audio format is saved on the DVD.

The list of available audio formats appears. A dot • indicates the format currently selected.

- ▶ **Changing setting:** Slide or rotate .
- ▶ **Exiting menu:** Slide .

### Playback options

The following options are available:

- Normal Track Sequence: Tracks are played back in the order in which they are stored on the disc, e.g. track 1, 2, 3, etc.
- Medium Mix: Tracks are played back in random order, e.g. track 3, 8, 5, etc.
- Track List Mix (MP3 mode only): Tracks of the current folder and its subfolders are played back in random order.
- ▶ **Selecting an option:** Select Audio.
- ▶ Select CD, DVD-A or MP3.  
The option list appears. A dot • indicates which option is switched on.
- ▶ Select an option and press .
- The option is switched on. For all options except Normal Track Sequence, you will see a corresponding indicator in the main area.

- i** The Normal Track Sequence option is automatically activated when you select a different medium. If an option is activated, it remains activated after COMAND is switched on/off.

### Audio AUX and video AUX

You can play back external audio or video sources via the systems installed in your vehicle.

The sockets for external audio and video sources (AUX) are located

- in the glove box (COMAND)
- on the CD/DVD drive in the rear passenger compartment
- on the head restraints

- i** For operation of the external audio and video sources, refer to the operating instructions of the respective device. You may have to adjust the proper video standard on the external audio and video source to ensure proper replay.

Do not leave external devices in the vehicle. Proper function of the device could be impaired due to excessive temperatures, for example when exposing to direct sunlight or when the outside temperature is extremely low. Mercedes-Benz does not assume liability for damage to external devices.

#### Warning!

Operating an external audio source while the vehicle is in motion will distract you. You may not notice changing road and/or traffic conditions which may cause an accident.

Bear in mind that at a speed of just 30 mph (approximately 50 km/h), your vehicle is covering a distance of 44 feet (approximately 14 m) every second.

For your safety and the safety of others, pull over to a safe location and stop before operating an external audio source.

#### Warning!

Due to the different volumes of the external audio sources, system messages of the vehicle may be much louder. You may need to disable these system messages or adjust the volume of these messages manually.

- i** The volume of external audio sources is extremely variable. It is possible that a device connected as an external audio source will sound quieter or louder in the



vehicle or that the usual maximum volume cannot be achieved. On certain devices the volume can be set separately. In this case, start at a moderate volume and increase it slowly. In this way, you can determine whether the system is capable of playback without distortion, even at high volume.

- Connect external audio and video sources as described in the following sections.

### Audio and video AUX sockets in the glove box

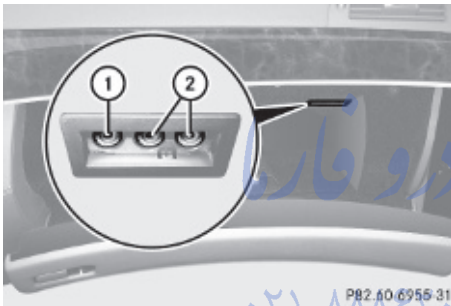

- ① Video AUX socket, yellow
  - ② Audio AUX socket (white socket for left channel, red socket for right channel)
- i** Vehicles with media interface: Instead of the external audio and video sockets, the media interface (► page 200) is located in the glove box.

### Audio/video AUX sockets on the Rear Seat Entertainment drive

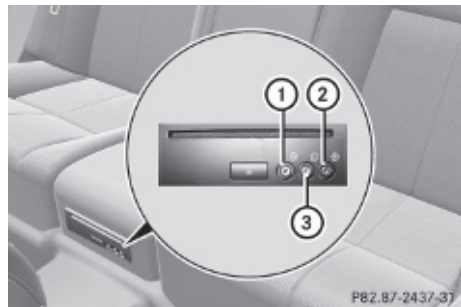

- ① V Video AUX socket, yellow
- ② R Audio AUX socket for right audio signal (red)
- ③ L Audio AUX socket for left audio signal (white)

### Audio/video AUX sockets on the head restraint

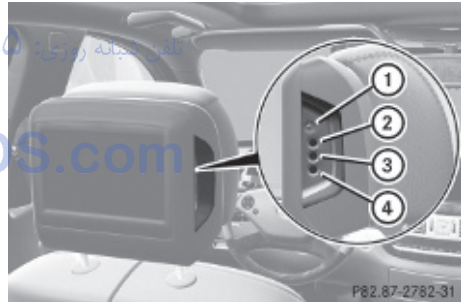

- ① Socket for wired headphone
- ② V Video AUX socket, yellow
- ③ L Audio AUX socket for left audio signal (white)
- ④ R Audio AUX socket for right audio signal (red)

### Switching to audio AUX operation (Rear Seat Entertainment System)

- Connect the audio device to the sockets on the head restraint or the rear seat and start

playback. Refer to operating instructions of the external device.

- ▶ **Selecting main function:** Select Aux.
- ▶ Press button **ok** on the remote control.
- ▶ Select Source.
- ▶ Select Display Aux for playback via the connections in the head restraint.

or

- ▶ Select Disk Drive Aux for playback via the connections in the rear seat.

#### Switching to audio AUX operation (COMAND)

- ▶ Select Audio → AUX.

The Audio AUX menu appears. You will hear the medium in the external audio source provided it is connected and set to playback.

You can adjust the following during audio AUX operation:

- Volume (▷ page 88)
- Balance and fader (▷ page 88)
- Treble and Bass (▷ page 88)
- 3D Sound (▷ page 89)

#### Switching to video AUX operation (Rear Seat Entertainment System)

- ▶ Connect the video device to the sockets on the head restraint or the rear seat and start playback. Refer to operating instructions of the external device.
- ▶ **Selecting main function:** Select Aux.
- ▶ Press button **ok** on the remote control.
- ▶ Select Source.

- ▶ Select Display Aux for playback via the connections in the head restraint.

or

- ▶ Select Disk Drive Aux for playback via the connections in the rear seat.

- ▶ **Switching from full screen to menu system:** Press button **ok** on the remote control.

- ▶ **Screen settings:** Select Display Aux. A list appears.

- ▶ Proceed as described in the section “Screen settings” (▷ page 194).

#### Switching to video AUX operation (COMAND)

- ▶ Select Video → AUX.

The video AUX menu appears. You will hear and see the medium in the external audio source provided it is connected and set to playback.

- ▶ **i** For operation of the external video source, refer to the operating instructions of the respective device.

You can adjust the following during video AUX operation:

- Brightness, Contrast and Color (▷ page 194)
- Picture format (▷ page 194)
- Volume (▷ page 88)
- Balance and fader (▷ page 88)
- Treble and Bass (▷ page 88)
- 3D Sound (▷ page 89)

## Rear Seat Entertainment System

 **Observe Safety notes, see page 76.**

### **Warning!**

The driver should not wear a Rear Seat Entertainment headphone while operating the vehicle under any circumstances. The use of a headphone while driving the vehicle could drastically impair the ability to react to audible traffic conditions (e.g. emergency sirens from police/fire/ambulance, another car's horn, etc.).

### **Warning!**

When not in use, headphones or external video sources should be stored in a safe location (e.g. one of the vehicle's storage compartments) so that they are not loose within the passenger compartment during braking, vehicle maneuvers or a traffic accident. Objects moving within the passenger compartment could cause serious personal injury to vehicle occupants.

### **Warning!**

Due to a potential choking hazard, wired headphone usage by children should only occur with adult supervision.

You can operate the Rear Seat Entertainment System via the remote controls (▷ page 81) that come with the vehicle.

The playback of audio and video sources with the Rear Seat Entertainment System is identical to playback with the COMAND to a large extent.

The COMAND and the Rear Seat Entertainment System can be operated simultaneously almost independent of each other. However, some menus may cause conflicts when the systems are used by multiple users. Conflicts can occur between the rear screens as well as COMAND and the Rear Seat Entertainment System.

## Remote controls for Rear Seat Entertainment System

The Rear Seat Entertainment System contains two remote controls for the rear passenger compartment.

For information on using the remote controls, see (▷ page 81).

## Headphones for Rear Seat Entertainment System

The Rear Seat Entertainment System contains two headphones for the rear passenger compartment.

For information on using the headphones, see (▷ page 82).

## Related topics

- Inserting/ejecting CDs and DVDs (▷ page 180)
- Connecting and playing back external devices (▷ page 186)
- Remote control (▷ page 81)
- Playing back audio CDs/audio DVDs (▷ page 176)
- Playing back video CDs/audio DVDs (▷ page 191)

## CD/DVD drive

 **Observe Safety notes, see page 176.**

When both screens are used with the CD/DVD drive, selecting certain menus or changing certain settings on one screen will also be applied to the other screen.

The following functions will be applied to both screens:

- Changing Playback options
- Selecting track
- Using Play, Pause, and Stop

- Forward and Rewind as well as Skipping tracks
- Selecting the DVD menu and moving within that menu
- Changing language, subtitles and camera angle
- Calling up interactive DVD contents

The following functions will be applied to one screen only:

- Changing audio, video and screen settings
- Switching between full screen, menu system and control menu

### Switching between main functions

By selecting the main functions you set the playback options of the various audio and video sources.

Main function	
Disc	Playback with rear CD/DVD drive
COMAND	Playback with COMAND System
Aux	Playback with an external device connected in the rear
System	Menu for basic settings

When exiting a main function, the settings are saved. When calling up again the function later the following is possible:

- The main function is already running on both screens.
- The main function does not run on the other screen.

In the first case, the main function appears the way it is already displayed on the other screen.

In the second case, the setting at which you have exited the main function the last time appears.

### Inserting/ejecting CDs and DVDs

Loading or ejecting a disc is only displayed on the screen on which the main function Disc is selected. Storage of the current settings for both screens are reset to the original settings.

### Simultaneous usage of COMAND and the Rear Seat Entertainment System

#### Adopting the audio signal from Rear Seat Entertainment System for front passenger

You can transmit the audio signal of the CD/DVD drive of the Rear Seat Entertainment System to the headphone of the front passenger. The volume is adjusted on the headphone. The audio signal is transmitted to the COMAND when the main function Disc is selected on either rear screen. When the main function Disc is not selected on at least one rear screen, the audio signal is not transmitted to the COMAND.

- ▶ Select Audio → Rear in the COMAND.

#### Playing the active COMAND source on the Rear Seat Entertainment System

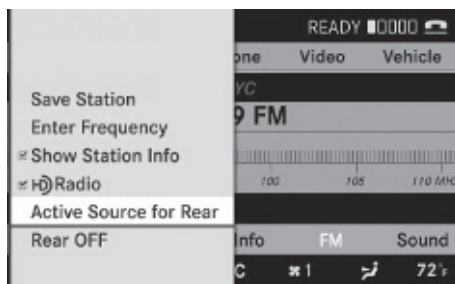

P82.87-3309-31

- ▶ Select Active Source for Rear in the COMAND.
- ▶ Switch to the main function COMAND in the Rear Seat Entertainment System.

## COMAND video DVD

### Safety notes

 Observe Safety notes, see page 176.

### Automatic picture fade-out

If a video DVD is playing when the vehicle is shifted from park position **P** into neutral position **N** or drive position **D** the picture is faded out automatically and the following message appears in the display: In order not to distract driver, picture is faded out while the vehicle is in motion.



When the vehicle is shifted back into park position **P**, the picture comes on again.

When the vehicle is shifted into reverse gear **R**, the rear view camera appears in the display during video DVD playback.

### Notes about video DVD operation

COMAND can playback commercially available, prerecorded video DVDs that bear the following label. You will usually find the label on the DVD booklet, the inlay, or the DVD itself.



-  Video DVDs differ from recordable DVD-R and DVD-RW discs.
-  There may be playback problems when playing copied DVDs.

There is a large variety of discs, disc-writing software and writers available. This variety

means that there is no guarantee that the system will be able to play discs that you have written/copied yourself.

Some DVDs may not comply with the NTSC or PAL TV playback standards. Sound, picture and other playback problems may occur when you play such DVDs.

COMAND can playback video DVDs meeting the following requirements:

- Correct regional code
- NTSC or PAL TV standard

The appropriate information is usually given either on the DVD or the DVD box. The factory setting of COMAND is regional code 1. This setting can only be changed five times at most by an authorized Mercedes-Benz Center. This will allow you to playback video DVDs with other regional codes, as long as they comply with the NTSC or PAL TV standard.

### Notes about DVDs

-  Do not affix stickers or labels to the discs. These could peel away and damage COMAND. COMAND is designed to hold discs which comply with the IEC 60908 standard. You can therefore only use discs with a maximum thickness of 1.3 mm. If you insert thicker discs, e.g. those that contain data on both sides (DVD on one side and audio data on the other), they cannot be ejected and can damage COMAND.
- Do not use CDs with a diameter of 8 cm. Attempting to play discs with a diameter of 8 cm or playing such discs with an adapter may cause damage COMAND.
- Such damages are not covered by the Mercedes-Benz Limited Warranty.
- Only use round discs with a diameter of 12 cm.

## Notes about handling DVDs

For notes about handling DVDs, see (▷ page 179).

you try to utilize such functions or carry out such actions, you will see the  symbol in the display.

### Functional limitations

Depending on the DVD, it is possible that certain functions or actions may be temporarily or permanently unavailable. If

### Inserting or ejecting DVDs

 **Observe Safety notes, see page 176.**

▶ Inserting or ejecting a DVD (▷ page 179).

### Video DVD submenu overview

DVD-V	II/▶	■	Media	Sound
DVD Functions	Pausing playback II	Stopping playback ■	Selecting medium	Treble
Brightness	Continuing playback ▶			Bass
Contrast				Balance/Fader
Color				3D Sound
16:9 Optimized				
4:3				
Widescreen				
Active Source for Rear				
Rear OFF				







### Switching to video DVD mode

- ▶ Insert a DVD (▷ page 179).
- or
- ▶ Select Video → Video DVD.
- or
- ▶ Press shortcut button  once or twice.

**i** Shortcut button  takes you directly to the previously set disc mode (audio CD/DVD, MP3-CD/DVD or video DVD). The number of times you have to press the

shortcut button depends on the previously set mode.

### Showing/hiding the DVD control menu

- ▶ **Showing the menu:** Slide   .
- ▶ **Hiding the menu:** Slide   .
- or
- ▶ Wait for approximately 8 seconds.





PB2.87-3310-31

Control menu

- ① Disc type
- ② Current track
- ③ Current scene
- ④ Elapsed track time
- ⑤ Show the menu system

### Showing/hiding the menu system

- ▶ **Showing the menu:** Press .
- ▶ **Hiding the menu:** Slide  to select Full screen and press .

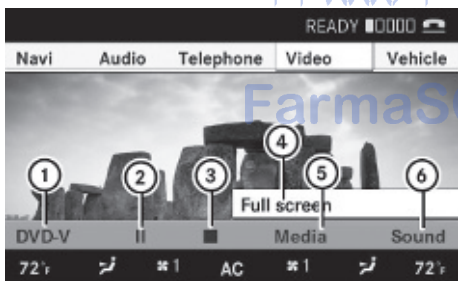



PB2.87-3311-31



Menu system

- ① Video DVD options
- ② Pause
- ③ Stop
- ④ Full-screen mode
- ⑤ Medium selection
- ⑥ Sound settings







### Fast forward/rewind

- ▶ While in full-screen mode or with activated control menu, slide   and hold until the desired track part is reached.

### Selecting the DVD medium

- ▶ Select Video → Video DVD.
- ▶ Show the menu system, if necessary (▷ page 193).
- ▶ Select Media.  
The media list appears. The dot  indicates the current medium.
- ▶ Select a medium.  
 COMAND changes the medium.

### Stop playback

- ▶ Select Video → Video DVD.
  - ▶ Show the menu system, if necessary (▷ page 193).
  - ▶ **Pausing playback:** Select . In the display, II changes to .
  - ▶ **Continuing playback:** Select . Play is continued from the point at which it was stopped.
  - ▶ **Stopping playback:** Select  again while playback is stopped.
- or
- ▶ Select  twice in quick succession during playback.
  - ▶ **Resuming playback:** Select . Playback starts again from the beginning.

### Pause playback

- ▶ Select Video → Video DVD.
- ▶ Show the menu system, if necessary (▷ page 193).



- ▶ **Pause playback:** Select **II**. In the display, **II** changes to ▶.
- ▶ **Continue playback:** Select ▶. Play is continued from the point at which it was stopped.

### Selecting scene/chapter

#### Entering scene/chapter using the COMAND controller

- ▶ Make sure that the control menu is shown (▷ page 192).
- ▶ **Skipping forwards or back:** Slide ←⊙→ or turn ⊙.

or

- ▶ Press button ▲ or ▼ on the multifunction steering wheel<sup>28</sup>.

- ⓘ Vehicles with rear multicontour seats: Rear occupants can also select a scene/chapter using the buttons on the rear armrest (▷ page 80).

#### Entering the scene/chapter using the telephone keypad

- ▶ Press button \*+ on the telephone keypad (▷ page 79).
- ▶ Enter scene/chapter using buttons 1 - 0. COMAND tunes in to the scene/chapter entered.

### Selecting film/track

- ⓘ This function is only available if the DVD is comprised of several films/tracks.
- ▶ Select Video → Video DVD.
- ▶ Show the menu system, if necessary (▷ page 193).

- ▶ Select DVD-V → DVD Functions → Title Selection. A selection list appears.
- ▶ Select a film/track.

### Screen settings

#### Setting brightness, contrast and color

- ▶ Select Video → Video DVD.
- ▶ Show the menu system, if necessary (▷ page 193).
- ▶ Select DVD-V → Brightness → Contrast or Color.
- ▶ **Changing settings:** Slide ↑⊙↓ or turn ⊙ until you reach the desired setting.
- ▶ **Saving settings:** Press ⊙.

#### Changing the picture format

- ▶ Select Video → Video DVD.
- ▶ Show the menu system, if necessary (▷ page 193).
- ▶ Select DVD-V. The DVD-V menu appears. The dot • in front of a menu item - 16:9 Optimized, 4:3 or Widescreen indicates the current format.
- ▶ **Changing the format:** Slide ↑⊙↓ or turn ⊙, until you reach the desired setting.
- ▶ **Saving the format:** Press ⊙.

### DVD menu

The DVD menu is the menu stored on the DVD itself. It is structured in various ways according to the individual DVD and permits certain actions and settings.

<sup>28</sup> Function is only available if the Audio menu is selected in the instrument cluster.

## Calling up the DVD menu

- ▶ Select Video → Video DVD.
- ▶ Show the menu system, if necessary (▷ page 193).
- ▶ Select DVD-V → DVD Functions → Menu.  
The DVD menu appears.

## Selecting menu items in the DVD menu

- ▶ Slide  $\uparrow$   $\odot$   $\downarrow$  or  $\leftarrow$   $\odot$   $\rightarrow$ .
- ▶ **Confirming the selection:** Press  $\odot$ .  
The selection menu appears.

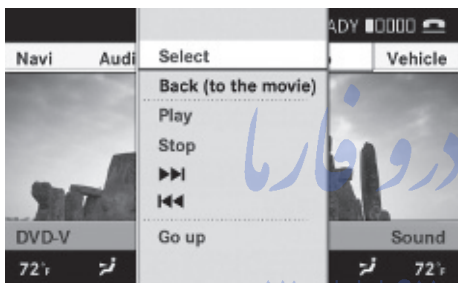

- ▶ **Reconfirming the selection:** Select Select.  
COMAND carries out the action defined by the selected DVD menu item.

**i** Depending on the DVD, it is possible the menu item Play either has no function or has no function in certain parts of the DVD menu.

## Stopping the movie or skipping to the beginning/end of a scene

- ▶ Select a menu item of your choice from the DVD menu.  
The selection menu appears.

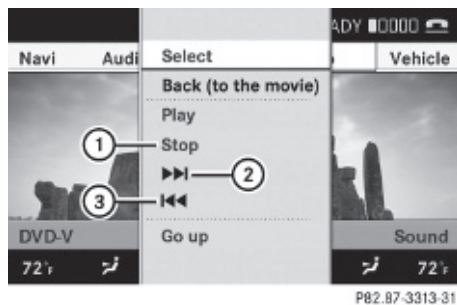

- ① Stop movie
- ② Skip to the end of a scene
- ③ Skip to the beginning of a scene



- ▶ **Stopping the movie:** Select Stop.
- ▶ **Skipping to the end of a scene:** Select  $\gg|$ .
- ▶ **Skipping to the beginning of a scene:** Select  $\ll|$ .

**i** Depending on the DVD, it is possible the menu items  $\gg|$  and  $\ll|$  either have no function or have no function in certain parts of the DVD menu.





## Switching to the next highest DVD menu level

- ▶ Press back button  $\leftarrow$  in the center console.  
or
  - ▶ Select the corresponding menu item in the DVD menu.  
or
  - ▶ Select a menu item of your choice from the DVD menu.
  - ▶ Select the menu item Go up in the selection menu.
- i** Depending on the DVD, the menu item Go up or the back button  $\leftarrow$  may only be available in certain DVD menus. On some DVDs, they may have no function at all.

### Back to the movie

- ▶ Press back button  until you can see the movie.
- or
- ▶ Select the corresponding menu item in the DVD menu.
- or
- ▶ Select a menu item of your choice from the DVD menu.
- ▶ Select the menu item Back (to the movie) in the selection menu.
- i** Depending on the DVD, the menu item Back (to the movie) or the back button  may be without function.





### Setting the language

- i** This function is not available for all DVDs. If it is available, you can set the language for the DVD menu and the audio language. The number of settings you can make is determined by the content of the DVD. It may also be possible to make the settings in the DVD menu (▶ page 194).
- ▶ Select Video → Video DVD.
- ▶ Show the menu system, if necessary (▶ page 193).
- ▶ Select DVD-V → DVD Functions.
- ▶ Select Audio Language.  
In both cases a selection list will appear. The dot • in front of an entry indicates the current language.
- ▶ **Changing the setting:** Slide  or turn , until you reach the desired setting.
- ▶ **Saving a setting:** Press .
- ▶ **Exiting the menu:** Slide .





### Subtitles and camera angles

- i** This function is not available for all DVDs. The number of settings you can make is

determined by the content of the DVD. It may also be possible to make the settings in the DVD menu (▶ page 194).

- ▶ Select Video → Video DVD.
- ▶ Show the menu system, if necessary (▶ page 193).
- ▶ Select DVD-V → DVD Functions.
- ▶ Select Subtitles or Camera Angle.  
In both cases a selection list will appear. The dot • in front of an entry indicates the current language.
- ▶ **Changing the setting:** Slide  or turn , until you reach the desired setting.
- ▶ **Saving a setting:** Press .
- ▶ **Exiting the menu:** Slide .

### Interactive content

- i** DVDs may include interactive content (e.g. a video game). In a video game you can control the play by selecting and initiating actions. The type and number of actions depends on the DVD.
- ▶ **Selecting an action:** Slide  or turn , until you reach the desired setting.
- ▶ **Initiating an action:** Press .
- A menu appears, the first entry Select is highlighted.
- ▶ Press .

### Music Register

#### Observe Safety notes, see page 76.

You can save MP3 or WMA audio files in the Music Register. The storage capacity is approximately 7 gigabyte.

- i** Keep your original music files in a safe place. A fault with the COMAND may cause the music files stored in the Music Register

to be lost. Mercedes-Benz USA, LLC is not liable for any loss of data.

### Music Register submenu overview

Music Register	Search	Media	Sound
Normal Track Sequence	Search functions	Selecting medium	Treble
Medium Mix			Bass
Track List Mix			Balance/Fader
Copy Music Files			3D Sound
Rename/Delete Files			
Delete All Music Files			
Memory Information			
Show Track Information			
Active Source for Rear			
Rear OFF			

### Switching to Music Register

#### From another main function

- ▶ Select Audio.  
The last selected audio mode is active.
- ▶ Select Audio once more.  
The audio menu appears.
- ▶ Select MUSIC REGISTER.
- i** When MUSIC REGISTER was the last selected audio mode, you will only have to select Audio once.

#### Within the audio functions

- ▶ Select Audio.  
The audio menu appears.

- ▶ Select MUSIC REGISTER.

The Music Register is being loaded. The Music Register display appears.

No audio files found:

A corresponding message appears.

- ▶ Copy audio files into the Music Register (▷ page 198) first.

Audio files found:

The first track in the first folder is played back or playback starts where you have stopped listening before.

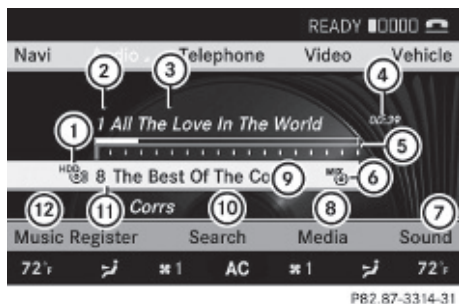

- ① Media type Music Register
- ② Track number
- ③ Track name
- ④ Elapsed track time
- ⑤ Elapsed track time (graphical display)
- ⑥ Current playback option (no display in “Normal Track Sequence”)
- ⑦ Sound settings
- ⑧ Medium selection
- ⑨ Current folder
- ⑩ Search functions
- ⑪ Medium position in media list
- ⑫ Calling up Music Register menu

### Copying audio data into the Music Register

You can copy audio files from storage media in the DVD changer, a memory card, or from external USB storage devices that contain MP3 or WMA audio files. External USB storage devices must be connected to the built-in USB socket for that purpose. The optional media interface is not intended for this purpose.

- ❗ Certain functions are not available while copying. A corresponding message will then appear.

### Selecting medium

- ▶ Select MUSIC REGISTER → Copy Music Files.  
The media list appears. Media with data that can be copied are highlighted.

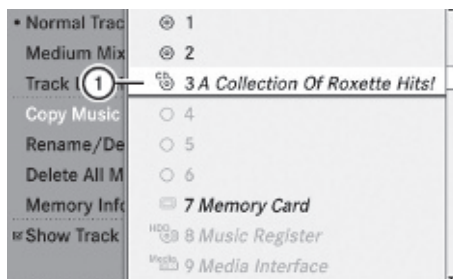

- ① Selected medium
- ▶ **Selecting medium:** Slide  $\uparrow \odot \downarrow$  or rotate  $\left\{ \odot \right\}$  and confirm with  $\odot$ .  
The medium is being loaded.

### Selecting audio files

- ▶ Select All Music Files.  
All audio files of the selected medium are copied. The symbol in front of All Music Files filled.
- or
- ▶ Select individual tracks.
- ▶ Select Continue.  
The copy menu appears.

### Starting copy process

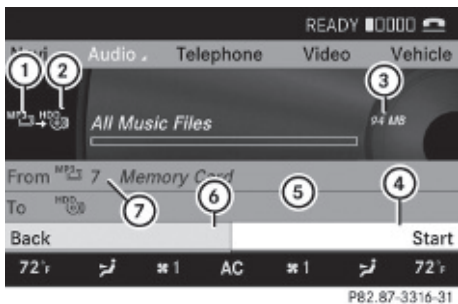

- ① Copies from memory card
- ② Copies to Music Register
- ③ Memory requirements, “Calling up memory information” (▶ page 199)
- ④ Starting copy process
- ⑤ Name of source medium and target storage name
- ⑥ Back without copying
- ⑦ Medium position in media list

▶ Select Start.

The copying process starts. The status bar shows the copying progress.

When the data has been copied, the first track of the copied album is played. The Music Register menu is displayed. You can now copy more audio files into the Music Register.

**!** Do not remove the memory card from which you are copying during the process. Otherwise the copied data in the Music Register will be corrupt.



- ① Status bar

**i** The copying process may take a while depending on the size of the data. Depending on the data source, the required time may vary. If the required storage space is insufficient, a message appears.

- ▶ **Aborting copying process:** Select Cancel. The audio data that have been copied already are stored in the Music Register.
- ▶ **Back without copying:** Select Back.

### Deleting audio files

This function will delete all audio files in the Music Register.

**!** The deletion process may take several minutes. Do not operate COMAND during this time to avoid malfunctions.

- ▶ Select MUSIC REGISTER → Delete All Music Files. You will be asked if you really want to delete.

### Calling up memory information

- ▶ Select MUSIC REGISTER → Memory Information.

A window with the following information opens:

- Storage capacity
- Available memory
- Occupied memory
- Contents (folders, tracks)

### Folder functions

You can view Music Register contents and modify and delete files.

- ▶ Select MUSIC REGISTER → Rename/Delete Files.

or



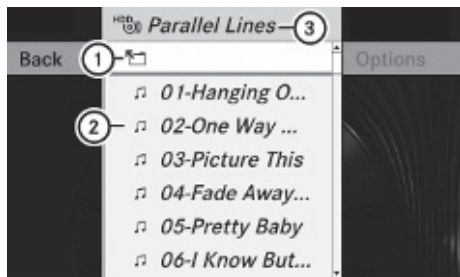



- ▶ Press  when the main area is highlighted. The contents of the current folder are displayed.









- ① Back
- ② Song title
- ③ Current folder

- ▶ **Back to previous folder:** Select symbol  . The previous folder appears.

### Renaming folders and tracks

- ▶ Select Rename/Delete Files.
- ▶ **Selecting folder or track:** Slide    or rotate   .
- ▶ Select Options → Change.
- ▶ Enter a name for the folder or track.
- ▶ **Saving changes:** Select  .

### Deleting folder or track:

- ▶ Select Rename/Delete Files.
- ▶ **Selecting folder or track:** Slide    or rotate   .
- ▶ Select Options → Delete. You will be asked if you really want to delete.

### Playback options

The following options are available:

- Normal Track Sequence  
Tracks are played back in the order in which they are stored on the disc, e.g. track 1, 2, 3, etc.
- Medium Mix  
Tracks of the current medium are played back in random order.
- Track List Mix  
Tracks of the currently active track list are played back in random order.

- ▶ **Selecting options:** Switch to Music Register (▶ page 197).
- ▶ Select MUSIC REGISTER. The list of options appears. The dot • indicates the currently selected option.
- ▶ Select an option. The option is activated. The corresponding display appears, except when Normal Track Sequence is selected, see position  in example illustration (▶ page 198).

 The option Normal Track Sequence is activated automatically when you change the current medium or select another medium. An activated option remains active after switching COMAND off and on again.

### Media Interface

#### Notes on media interface operation

#### Warning!

Operating an external audio source while the vehicle is in motion will distract you. You may not notice changing road and/or traffic conditions which may cause an accident. Bear in mind that at a speed of just 30 mph (approximately 50 km/h), your vehicle is covering a distance of 44 feet (approximately 14 m) every second.



For your safety and the safety of others, pull over to a safe location and stop before operating an external audio source.

## Connections

**i** Always store the devices in a safe place.

Only use genuine Mercedes-Benz connector cables.

Suitable connector cables are located in the vehicle or can be purchased at any authorized Mercedes-Benz Center.

The media interface allows for connection of the following media to the COMAND:

- iPod®
- USB devices
- MP3 player

**i** For further information on compatible multimedia devices

- visit [www.mbusa-mobile.com](http://www.mbusa-mobile.com)
- call the Mercedes-Benz Customer Assistance Center at 1-800-FOR-MERCEdes (1-800-367-6372) (in the USA)
- call Customer Service at 1-800-387-0100 (in Canada)

## Supported USB devices

The following USB devices are supported:

- USB flash drives
- USB hard drives (1", 1.8", and 2.5") with a starting/steady current not to exceed 800 mA (separate power supply may be necessary)
- selected MP3 players

**i** The media interface supports USB storage devices of "USB Device Subclass 6". Information on "USB Device Subclass 6" is available from the manufacturer of the respective device.

## Supported file formats on USB devices

The following file formats are supported:

- MP3: CBR, VBR (up to 320 kbit/s)
- WMA: CBR, VBR (up to 320 kbit/s)

## Special characteristics of USB devices

- Do not store data other than audio data on a USB device. Doing so will increase the time required to initialize the USB device.
- A maximum of 8 directory levels with up to 1000 tracks each are supported.
- Do not use USB extensions or adapters. They could impair functionality.
- Playlists on the USB device will be searched for in the background. Playlists that were found will be available in separate categories among the folders. The initialization of large USB storage devices that contain a large number of files may take several minutes.

**i** Files that are protected via DRM (Digital Rights Management) are not supported by the media interface.

## Connecting external devices

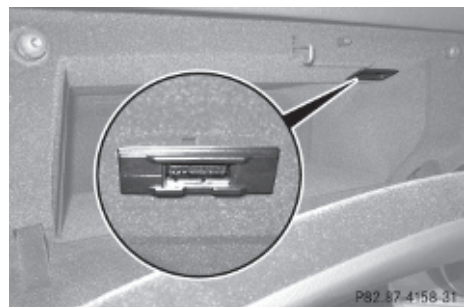

The media interface is located in the glove box.

Only connect one device at a time. Otherwise you will not be able to operate the external device. For more information contact an authorized Mercedes-Benz Center.

- i** Do not leave external devices in the vehicle. Proper function of the device could be impaired due to excessive temperatures, for example when exposing to direct sunlight or when the outside temperature is extremely low. Mercedes-Benz does not assume liability for damage to external devices.

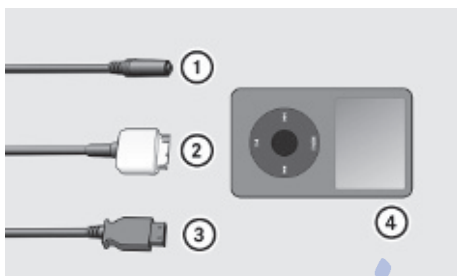

PB2.B7-2486-31

- ① 3.5 mm stereo jack AUX cable (4-pin) for connecting external devices via AUX port, e.g. MP3 players (audio and video)
- ② iPod® cable
- ③ USB cable for supported USB devices (optional)
- ④ Example device: iPod®

- ▶ Connect the audio device to the media interface in the glove box using the required cable ①, ②, or ③ while the vehicle is standing still. COMAND activates the device<sup>29</sup>.

When you disconnect a device, the message No device connected. appears.

- i** Do not operate iPods® or MP3 players via a remote control, for example Bluetooth® remote control, while operating the respective device via the media interface. This could cause unpredictable interactions.

Connecting a completely discharged iPod® or MP3 player can increase the initialization time.

- i** Error messages appear while activating a device when
- COMAND does not support the connected device
  - the power consumption of the connected device is too high
  - the media interface is malfunctioning

Contact an authorized Mercedes-Benz Center if required.

### Notes on operating a device via the AUX socket

#### **Warning!**

Due to the different volumes of the external audio sources, system messages of the vehicle may be much louder. You may need to disable these system messages or adjust the volume of these messages manually.

- i** The volume of external audio sources is extremely variable. It is possible that a device connected as an external audio source will sound quieter or louder in the vehicle or that the usual maximum volume cannot be achieved. On certain devices the volume can be set separately. In this case, start at a moderate volume and increase it slowly. In this way, you can determine whether the system is capable of playback without distortion, even at high volume.

### Switching to media interface operation

- i** Starting individual function may take several minutes, depending on the external device and the content of the medium, for example video podcasts.

Do not use software other than the genuine software for uploading your iPod® or MP3 player. Otherwise some or all functions may not be available.

<sup>29</sup> Does not apply to AUX devices.

## From another main function

- ▶ Press shortcut button . COMAND activates the last selected disc mode.

**i** When media interface operation was selected before, it is now activated.

- ▶ Select Media → Media Interface. The media list appears. The dot  indicates the currently played medium.

**i** When no device is connected, Media Interface instead of the device name appears.

If COMAND does not support the connected device, the message *Device incompatible.* appears. The device will be listed in the media list as *Not Available.* When two devices are connected, the message *Please ensure that only one device is connected.* appears.

- ▶ Confirm with .

COMAND activates a connected device. A corresponding message appears. Afterwards, the basic display appears.

- Track number (graphical display)
- Current playback option (no display in “Normal Track Sequence”)
- Sound settings
- Media list
- Album name (if available)
- Categories, playlists and/or folders
- Artist (if available)
- Submenu for basic settings

**i** The connected disc type  is identified by the respective symbols for iPod®, MP3 player, or USB storage device.

**i** When the connected device does not contain tracks that can be played, a corresponding message appears.

## Within the audio functions

- ▶ Connect an external device (▷ page 201). COMAND activates the device. Afterwards, the basic display appears.

or: تلفن شبانه روزی

- ▶ Select Audio → Media Interface.

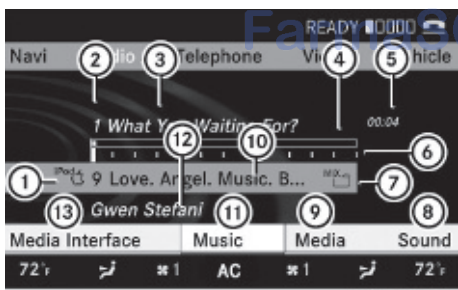

Example illustration: iPod® operation

- Disc type
- Track number
- Track name
- Elapsed track time (graphical display)
- Elapsed track time

## Selecting audio files

**i** COMAND lists the stored data on an iPod®, MP3 player, or USB storage device according to their own respective file structure.

## Selecting by skipping tracks

- ▶ **Skipping forward or backward:** Slide  or rotate .

or

- ▶ Press button  or  on the multifunction steering wheel<sup>30</sup>.

**i** The skip forward function takes you to the next track. The skip backward function takes you to the beginning of the current

<sup>30</sup> Function is only available if the Audio menu is selected in the instrument cluster.

track, provided it has been played for longer than 8 seconds. When the track has been played for less than 8 seconds, you will skip to the track before the current one. When you select an option other than Normal Track Sequence, the track is chosen at random.

### Selecting via telephone keypad

► **Initiating entry:** Press button **[ \* + ]**.  
The input menu appears. The number of digits you can enter depends on the number of stored tracks.

► **Entering track number:** Press a button, for example **[ 7 PQRS ]**.  
The number on the button you have pressed is the first digit in the input line.

**i** COMAND ignores invalid digits and does not display them.

► Enter more digits as desired.

► **Confirming entry:** Press **[ OK ]**.

or

► Hold down the last digit button of the desired track number (e.g. track 108, press **[ 1 0 8 ]**, **[ 0 ]**, then hold **[ 8 TUV ]**).  
The selected track is played back.

### Fast forward/rewind

► **With the main area active:** Slide **← ⏪ →** and hold until the desired track part is reached.

**i** With iPods®, the fast-rewind function works within the current track only.

### Selecting category/playlist/folder

#### iPod® and selected MP3 player

You can select tracks via categories and folders.

Categories, for example, can be:

- Current Track List
- Playlists
- Artists
- Albums
- Track
- Podcasts
- Genres
- Composers
- Audiobooks

**i** Some categories contain the entry All. When selecting this entry, the entire content of the respective category is played back.

### USB devices

You can select folders and playlists (if available). COMAND can display the respective album name and artist, the so-called metadata, during playback when the metadata have been read into the system.

Playlists are indicated in the display by a special symbol. When you open a playlist, the related tracks are opened and playback starts by selecting a track.

For USB storage devices, you can determine whether the metadata from the tags of coded audio data or the file name and folder is to be displayed during playback.

► **Displaying album name and artist:**  
Select Media Interface → Display Metadata.

### Selecting category and opening folder

► **Opening category/folder list:** Press **[ OK ]** when the window is selected.

or

► Select Music.  
The available categories or the folder content, e.g. subfolders, are displayed.

- i** The menu option Music is not available yet while the device is being activated.



P82.87-3320-31

Example illustration: Category list

- ① Device symbol and name or selected category
- ② Available categories

► **Selecting category/playlist/folder:**

Slide  $\uparrow \odot \downarrow$  or rotate  $\left[ \odot \right]$  and confirm with  $\odot$ .

The content of the selected category or folder appears.

- i** The message Please wait... may appear when data still needs to be read from the connected device.

- If necessary, repeat the above step until the tracks of the desired folder or album are displayed.

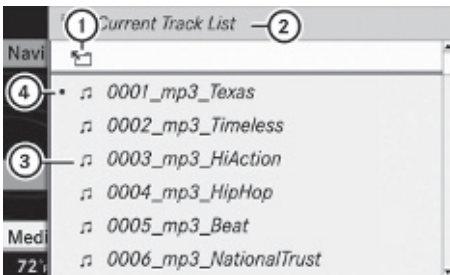

P82.87-3321-31

Example illustration: Current track list

- ① Back
- ② Current category
- ③ Track symbol
- ④ Current track

- **Selecting track:** Slide  $\uparrow \odot \downarrow$  or rotate  $\left[ \odot \right]$  and confirm with  $\odot$ .  
The track is played back.

- **Back to previous folder:** Select  $\left[ \square \right]$  and confirm.

- i** Symbol  $\left[ \square \right]$  is always displayed at the top of the respective folder.

### Playing back the content of a category or folder

- Select a category or folder.  
► Press  $\odot$  for longer than 2 seconds.  
The content of the selected category or folder is played back according to the selected playback option (► page 206).

### Alphabetical track selection

#### iPod® and MP3 player

- i** This function is available for alphabetically ordered categories and folders.

- Select a category, for example Artists.  
The available artists appear.

- Press the respective button on the telephone keypad once or more to enter the first character of the desired artist name. For example, press button  $\left[ \text{ZABC} \right]$  three times for an artist whose name starts with a "C".  
The available characters are displayed on the bottom of the display.

- i** When the entered character does not match any entry, the entry that matches a previously entered character appears first.

- i** The quality of the search results for iPods® and MP3 players depends significantly on the version and language of the software (e.g. iTunes®) that was used to upload the medium.

## USB storage device

**i** This function is available for alphabetically ordered directories. The function is not available within playlists for example.

- ▶ Within a folder, press the respective button on the telephone keypad once or more to enter the first character of the desired artist name. For example, press button  three times for an artist whose name starts with a "C".

The available characters are displayed on the bottom of the display.

When the directory contains folders only, COMAND will search for folders.

### Selecting active partition (USB storage devices only)

You can select this function with USB storage devices when the storage space is partitioned. The system supports up to 4 partitions (primary or logical, FAT formatted).

- i** The Windows formatting program supports FAT partitions of up to 32 gigabyte by default.
- ▶ Select Media Interface → Select Active Partition.

### Playback options

The following options are available:

- Normal Track Sequence  
Tracks are played back in regular order (e.g. in numerical or in alphabetical order).
- Random Tracks  
All available tracks on the current medium are played back in random order.
- Category Mix or Random Folder (with USB devices when Folder was selected)

Tracks of the currently active category or folder and its subfolders are played back in random order.

- ▶ **Selecting playback options:** Select Media Interface in the basic display. The list of options appears. The dot • indicates the currently selected option.
- ▶ Select an option.

## COMAND vehicle menu

### Introduction

#### Warning!

HYBRID vehicles: It is imperative that you read the HYBRID Supplemental Operating Instructions included in your vehicle literature portfolio. You may otherwise not receive all necessary safety information and warning for the operation of your vehicle.

In this menu, you can program the following vehicle functions:

#### Function

Multi-function Contour Seat Settings (▷ page 216)

Rear Window Sunshade (▷ page 207)

Easy Entry/Exit Feature (▷ page 208)

Exterior Lighting Delayed Shut-off (▷ page 208)

Interior Lighting Delayed Shut-off (▷ page 208)

Ambient Lighting (▷ page 209)

Automatic Mirror Folding (▷ page 209)

Locator Lighting (▷ page 210)

**Function**

Automatic Locking (▷ page 210)

Trunk Opening-height Restriction  
(▷ page 210)

You can select the individual vehicle functions in two ways.

### Approach 1: Selecting vehicle functions via the main area of the COMAND display

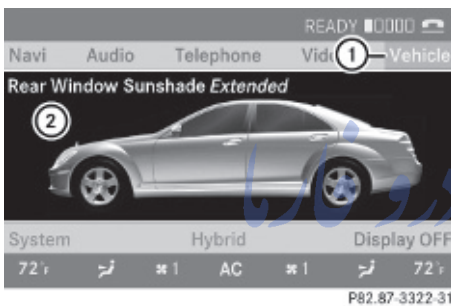

- ① Menu item Vehicle  
② Main area

- ▶ Select menu item Vehicle ①.  
Main area ② is active. You can select the individual vehicle functions by sliding ←→ or rotating [⊖].

### Approach 2: Selecting vehicle functions via the submenu



- ① Submenu

- ▶ Select Vehicle → Vehicle.  
Submenu ① opens. In the submenu, you can select the individual vehicle functions by sliding ←→ or rotating [⊖] and confirming the selection with [⊙].

The following sections always describe approach 1.

### Extending or retracting rear window sunshade

- ⓘ The components and operating principles of COMAND can be found on (▷ page 76).

This function is used to extend or retract the rear sunshade.

#### ⚠ Warning!

When operating the rear window sunshade, be sure that there is no danger of anyone being harmed by the extending or retracting procedure.

- ⓘ At temperatures below -4°F (-20°C), the rear window sunshade is switched off.

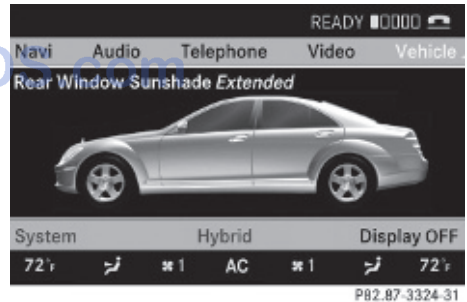

- ▶ Select Vehicle.  
The main area is active.
- ▶ **Selecting** Rear Window Sunshade function: Slide ←→ or rotate [⊖].
- ▶ **Opening/closing rear window sunshade:** Press [⊙].



### Setting easy-entry/exit feature

**i** The components and operating principles of COMAND can be found on (▷ page 76).

#### Warning!

You must make sure no one can become trapped or injured by the moving steering wheel and driver's seat when the easy-entry/exit feature is activated.

To stop seat/steering wheel movement, do one of the following:

- Press seat adjustment switch.
- Move steering wheel adjustment stalk.
- Press one of the memory position buttons or the memory button **M**.



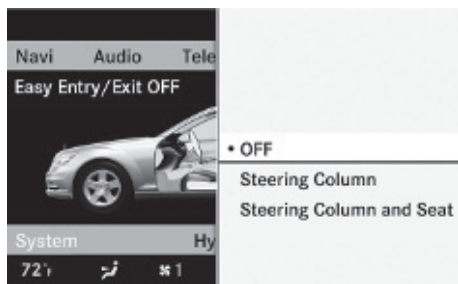

Do not leave children unattended in the vehicle, or with access to an unlocked vehicle. Children could open the driver's door and unintentionally activate the easy-entry/exit feature, which could result in an accident and/or serious personal injury.

Use this function to have the steering wheel move up and/or the driver's seat move back when entering the vehicle. You select the following settings:

- OFF, the easy-entry/exit function is switched off
- Steering Column, the steering wheel moves up
- Steering Column and Seat, the steering wheel moves up and the driver's seat moves back



P82.87-3325-31

- ▶ Select Vehicle.  
The main area is active.
  - ▶ **Selecting Easy Entry/Exit Feature:** Slide ←→ or rotate  and press .
  - ▶ **Selecting setting:** Slide ↑↓ or rotate  and press .
- The dot • indicates the currently selected setting.

### Setting interior/exterior lighting delayed shut-off (night security illumination)

**i** The components and operating principles of COMAND can be found on (▷ page 76).

**Interior lighting:** You can set if and for how long the interior lighting remains on in darkness after you have removed the SmartKey from the starter switch.

**Exterior lighting:** You can set if and for how long the exterior lighting remains on in darkness after closing the doors. The exterior lighting goes out automatically after the set time has elapsed.

You can select between the following settings:

- 0 seconds, delayed shut-off is switched off.
- 15, 30, 45, 60 seconds, delayed shut-off is switched on.

**i** You can reactivate this function by reopening a door within 1 minute. When you do not open or close a door or you do not close an opened door after removing the SmartKey from the starter switch, the exterior lighting will go out after 60 seconds.

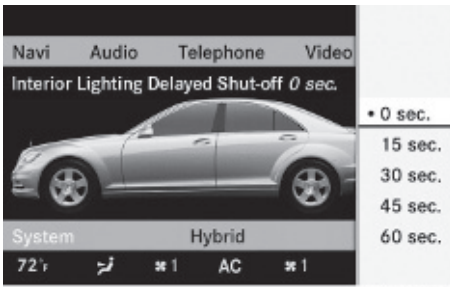

P82.87-3326-31

- ▶ Select Vehicle.  
The main area is active.
- ▶ **Selecting** Interior Lighting Delayed Shut-off or Exterior Lighting Delayed Shut-off: Slide ←→ or rotate and press .  
A menu appears.  
The dot • indicates the currently selected setting.
- ▶ **Selecting setting:** Slide ↑↓ or rotate and press .  
The dot • indicates the currently selected setting.

**i** The exterior lamp switch must be in position (▷ page 298) before turning off the engine. Otherwise the exterior lighting will not come on when leaving the vehicle.

### Setting interior ambient lighting

**i** The components and operating principles of COMAND can be found on (▷ page 76).

You can select the following settings:

- SOLAR (amber interior lighting)
- NEUTRAL (white interior lighting)
- POLAR (blue interior lighting)
- Brightness of the interior lighting ranging from 0 (off) to 5 (bright)

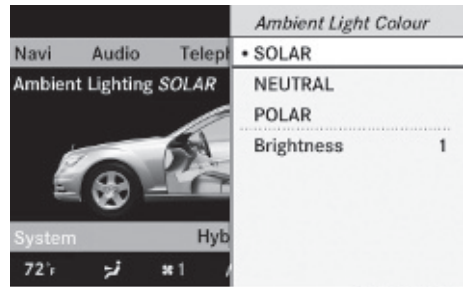

P82.87-3327-31

- ▶ Select Vehicle.  
The main area is active.
- ▶ **Selecting** Ambient Lighting: Slide ←→ or rotate and press .  
A menu appears.  
The dot • indicates the currently selected setting.
- ▶ **Selecting setting:** Slide ↑↓ or rotate and press .  
The dot • indicates the currently selected setting.

### Setting automatic mirror folding

**i** The components and operating principles of COMAND can be found on (▷ page 76).

In the Automatic Mirror Folding menu, you can determine whether the exterior rear view mirrors fold in when you lock the vehicle.



P82.87-3328-31

- ▶ Select Vehicle.  
The main area is active.
- ▶ **Selecting Automatic Mirror Folding:**  
Slide ←○→ or rotate [⊙].
- ▶ **Switching automatic fold-in function on/off:** Press [⊙].

### Locator lighting on/off

**i** The components and operating principles of COMAND can be found on (▷ page 76).

With the locator lighting feature activated and the exterior lamp switch in position **A** (▷ page 298), the following lamps will switch on during darkness when the vehicle is unlocked from the outside:

- Parking lamps<sup>31</sup>
- Front fog lamps or low-beam headlamps and LED daytime running lamps, depending on vehicle equipment
- Door entry lamps in the mirror

The locator lighting switches off when the driver's door is opened.

If you do not open a door after unlocking the vehicle with the SmartKey, the lamps will switch off automatically after approximately 40 seconds.

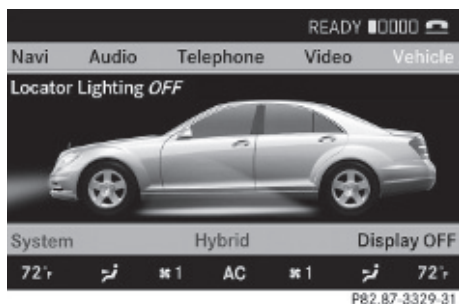

- ▶ Select Vehicle.  
The main area is active.
- ▶ **Selecting Locator Lighting function:**  
Slide ←○→ or rotate [⊙].
- ▶ **Switching locator lighting on or off:**  
Press [⊙].

### Automatic locking on/off

**i** The components and operating principles of COMAND can be found on (▷ page 76).

Use this function to activate or deactivate the automatic central locking (▷ page 278). With the automatic central locking system activated, the vehicle is centrally locked at vehicle speeds of approximately 9 mph (15 km/h).

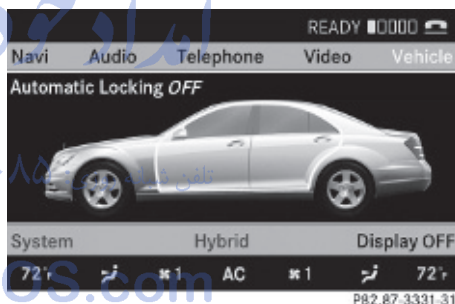

- ▶ Select Vehicle.  
The main area is active.
- ▶ **Selecting Automatic Locking:** Slide ←○→ or rotate [⊙].
- ▶ **Switching automatic locking on or off:**  
Press [⊙].

### Trunk opening-height restriction on/off

**i** The components and operating principles of COMAND can be found on (▷ page 76).

Vehicles with trunk opening/closing system:

<sup>31</sup> When the parking lamps are on, the tail lamps, license plate lamps, side marker lamps, and instrument panel lamps always come on as well.

You can select whether the trunk lid should open fully or only to the height of the roof.

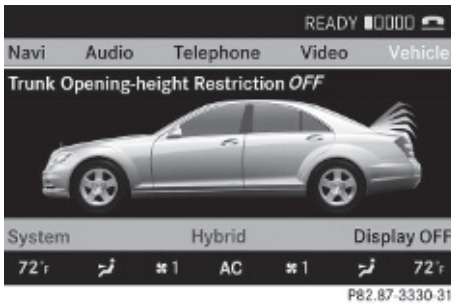

- ▶ Select **Vehicle**.  
The main area is active.
- ▶ **Selecting** Trunk Opening-height Restriction: Slide ←→ or rotate [⊙].
- ▶ **Switching trunk opening-height restriction on or off**: Press [⊙].

## COMAND automatic climate control

### Introduction

- ❗ The components and operating principles of COMAND can be found on (▷ page 76).

#### ⚠ Warning!

Follow the recommended settings for heating and cooling given on the following pages and pages in the “Controls in detail” chapter. Otherwise the windows could fog up, impairing visibility and endangering you and others.

You can operate the climate control via COMAND or via the buttons on the climate control panel (▷ page 363).

Some of the special climate control functions can only be operated via COMAND.

The following climate control functions can be operated via COMAND:

- Temperature (▷ page 211)
- Air distribution (▷ page 212)
- Air volume (▷ page 212)

- Switching off cooling (AC OFF) (▷ page 213)
- Central climate control (Mono) (▷ page 214)
- Footwell temperature (▷ page 214)
- Air flow from air vents (▷ page 215)
- Rear climate control (▷ page 215)

The climate control menu is called up via the climate control settings.

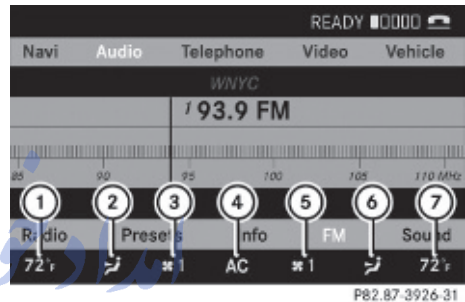

Climate control settings with functions (submenus)

- ① Temperature, driver's side
- ② Air distribution, driver's side
- ③ Air volume, driver's side
- ④ Central menu, climate control
- ⑤ Air volume, passenger side
- ⑥ Air distribution, passenger side
- ⑦ Temperature, passenger side

### Setting temperature

- ⚠ **Observe Safety notes, see page 365.**

Use the temperature controls ▼▲ (▷ page 363) in the center console or COMAND climate control settings to separately adjust the air temperature on each side of the passenger compartment.

- ▶ Select climate control settings →  
Temperature, left or right and then press [⊙].



- ▶ **Changing temperature:** Slide or rotate .
  - ▶ **Exiting menu:** Press , back button in the center console (▶ page 77) or slide .
- The setting is saved.

### Adjusting air distribution

**Observe Safety notes, see page 365.**

You can adjust the air distribution separately for the driver's and front passenger side.

- When you change the air distribution, the automatic function of the climate control system is switched off.
- ▶ Select climate control settings → Air distribution, driver's side or passenger side.



- Directs air through the defroster air vents to the windshield and front door windows
- Directs air through the center and side air vents
- Directs air through the center and side air vents and to the footwells
- Directs air to the footwells
- Air distribution is adjusted automatically
- Directs air through the defroster air vents to the windshield and front door windows and to the footwells
- Directs air into the entire vehicle interior
- Directs air through the center, side and defroster air vents to the windshield and front door windows

- ▶ **Changing air distribution:** Rotate . The symbol for air distribution changes. The direction and size of the arrows represent the air distribution.

- ▶ **Switching back to automatic mode:** Rotate and select AUTO.
  - ▶ **Exiting menu:** Press , back button in the center console (▶ page 77) or slide .
- The setting is saved.

### Adjusting air volume

Use rocker switches (▶ page 363) in the center console or COMAND climate control settings to separately adjust the air volume on each side of the passenger compartment.

- When you change the air volume, the automatic function of the climate control system is switched off.
- ▶ Select climate control settings → Air volume, driver's side or passenger side.

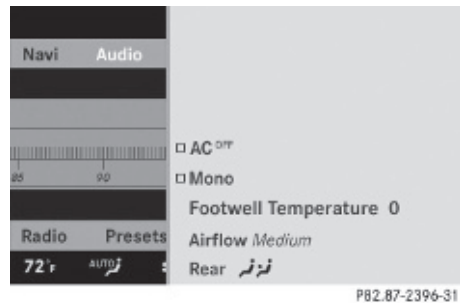
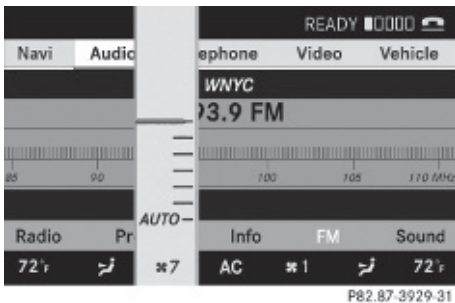

- **Changing air volume:** Slide or rotate .

or

- **Switching back to automatic mode:**

Rotate and select AUTO.

- **Exiting menu:** Press , back button

in the center console (► page 77) or slide .

The setting is saved.

### Central climate control menu via COMAND

The central climate control menu is in the center of the climate control settings. When the climate control is activated, you will see AC in the central menu. The following functions can only be operated in the central climate control menu via COMAND:

- Deactivating cooling () (► page 213)
- Central climate control (Mono) (► page 214)
- Footwell temperature (► page 214)
- Air flow from air vents (► page 215)
- Select climate control settings → Central menu.

### Activating/deactivating air conditioning

The air conditioning is operational while the engine is running and cools the interior air to the temperature set by the operator. In addition, the air conditioning dehumidifies the interior air and helps prevent window fogging.

- Condensation may drip out from underneath the vehicle. This is normal and not an indication of a malfunction.

#### **Warning!** تذکره!

If you deactivate the air conditioning, the vehicle will not be cooled when weather conditions are warm. The windows can fog up more quickly. Window fogging may impair visibility and endanger you and others.

- Select climate control settings → Central climate control menu.
  - **Selecting** : Slide or rotate .
  - **Confirming selection:** Press .
- A checkmark appears when the cooling is deactivated.
- appears in the central menu of the climate control settings.



P82.87-2397-31

**!** If the air conditioning cannot be activated again, this indicates that the air conditioning is losing refrigerant. The compressor has turned off.

Have the air conditioning checked at the nearest authorized Mercedes-Benz Center.

### Selecting Mono mode

Mono is used to adjust the climate zones for the entire vehicle at the same time. When the Mono function is switched on and you change the climate on the driver's side, these changes will be carried out in the same manner for all climate zones.

► Select climate control settings → Central climate control menu.

► **Selecting Mono:** Slide  $\uparrow \odot \downarrow$  or rotate  $\{\odot\}$ .

► **Confirming selection:** Press  $\odot$ .

A checkmark appears when the function has been selected.



P82.87-2398-31

► **Exiting menu:** Press back button  $\leftarrow$  in the center console (▷ page 77) or slide  $\leftarrow \odot \rightarrow$ .

The Mono function is automatically switched off when you:

- change a climate control setting for the front passenger side using COMAND
- operate a button from the climate control for the front passenger side
- operate one of the buttons for the rear climate control system

### Adjusting footwell temperature

**i** In automatic mode, this setting optimizes the footwell temperature when outside temperatures are low.

The Footwell Temperature function is used to adjust the temperature difference between the footwell and the rest of the passenger compartment.

The higher the selected value, the higher the temperature in the footwell will be.

► Select climate control settings → Central climate control menu.

► **Selecting Footwell Temperature:** Slide  $\uparrow \odot \downarrow$  or rotate  $\{\odot\}$  and then press  $\odot$ .

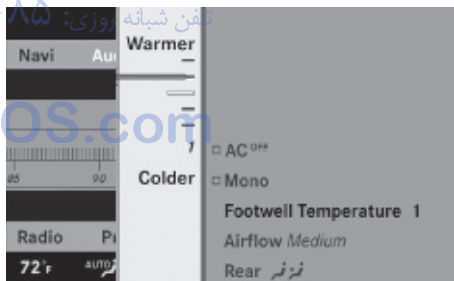

P82.87-4159-31

► **Changing temperature difference:** Slide  $\uparrow \odot \downarrow$  or rotate  $\{\odot\}$ .

► **Exiting menu:** Press  $\odot$ , back button  $\leftarrow$  in the center console (▷ page 77) or slide  $\leftarrow \odot \rightarrow$ .

The setting is saved.



## Adjusting air flow from air vents

- i** In automatic mode, this setting optimizes the air flow when outside temperatures are high.

The Airflow setting defines air distribution and air volume in automatic mode:

- Focused (default setting, increased air flow)
- Medium (reduced air flow)
- Diffuse (minimal air flow)

- i** When the interior ambient temperature of the vehicle is very hot and the climate control is cooling the interior, the setting for air flow is temporarily overridden.

- ▶ Select climate control settings → Central climate control menu → Airflow.  
A selection list appears.  
The current setting is indicated by a dot • .

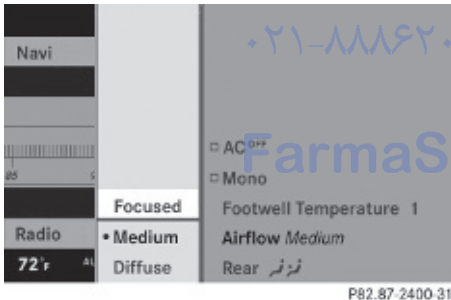

- ▶ **Changing air flow:** Slide  $\uparrow \odot \downarrow$  or rotate  $\left[ \odot \right]$ .

- ▶ **Confirming selection:** Press  $\odot$ .

## Operating rear climate control from the front

The Rear  $\left[ \text{تبرنگ} \right]$  function is used to operate the rear climate control via COMAND and the rocker switches on the control panel from the front (▷ page 363).

## Switching on rear climate control operation from the front

- ▶ Select climate control settings → Central climate control menu.  
▶ **Selecting Rear  $\left[ \text{تبرنگ} \right]$ :** Slide  $\uparrow \odot \downarrow$  or rotate  $\left[ \odot \right]$ .

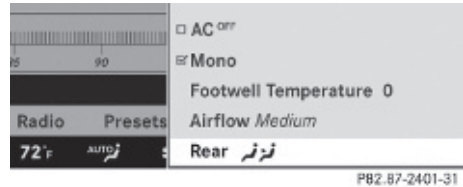

- ▶ **Confirming selection:** Press  $\odot$ .

In the climate control setting, Rear appears in the central menu. The rear climate control can be operated from the front.



Climate control settings, rear climate control

- ① Rear temperature, left
- ② Rear air distribution, left
- ③ Rear air volume
- ④ Central menu for rear climate control
- ⑤ Rear air distribution, right
- ⑥ Rear temperature, right

The rear climate control is operated in the same manner as the climate control system for the driver's and front passenger side.

## Central menu for rear climate control

In the central menu for the rear climate control, you can:

- switch back to operating the front climate control system
  - switch off the rear climate control
  - switch the automatic function of the rear climate control from automatic to manual
- ▶ Select climate control settings → Central climate control menu.

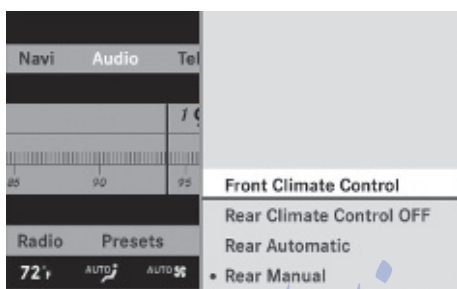

P82.87-2403-31

### Switching off rear climate control operation from the front

- ▶ Select climate control settings → Central climate control menu.  
The current setting is indicated by a dot • .
- ▶ **Selecting** Front Climate Control: Slide ↑⊙↓ or rotate ⊕⊙⊖.

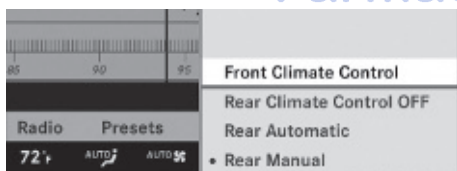

P82.87-2404-31

- ▶ **Confirming selection:** Press ⊕.
- The climate control settings shows the climate control settings for the driver and front passenger.

### Switching off rear climate control

- ▶ Select climate control settings → Central climate control menu.  
The current setting is indicated by a dot • .
- ▶ **Selecting** Rear Climate Control OFF: Slide ↑⊙↓ or rotate ⊕⊙⊖.

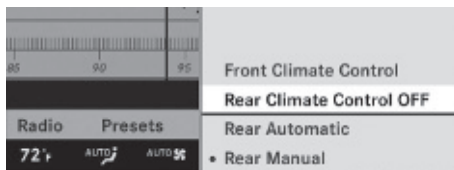

P82.87-2405-31

- ▶ **Confirming selection:** Press ⊕.
- The rear climate control is switched off.

### Switching on the automatic function of the rear climate control

- ▶ Select climate control settings → Central climate control menu.  
The current setting is indicated by a dot • .
- ▶ **Selecting** Rear Automatic: Slide ↑⊙↓ or rotate ⊕⊙⊖.

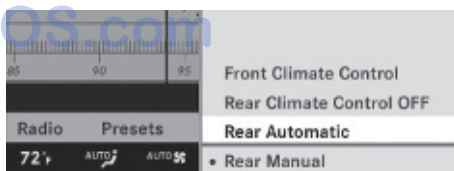

P82.87-2406-31

- ▶ **Confirming selection:** Press ⊕.
- The automatic function of the rear climate control is switched on.

## COMAND seats

### Operating seats via COMAND

⚠ Observe Safety notes, see page 286.

- ❗ The components and operating principles of COMAND can be found on (▶ page 77).

The following seat adjustments can be made via COMAND:

### Settings

Lumbar support (▷ page 217)

Multicontour seats, front (▷ page 218)

Drive-dynamic multicontour seats (▷ page 219)

### Selecting a seat

You must first select the seat for which you would like to make adjustments.



- ▶ Press button . The main area is active.
- ▶ **Switching to the bottom menu line:** Slide .

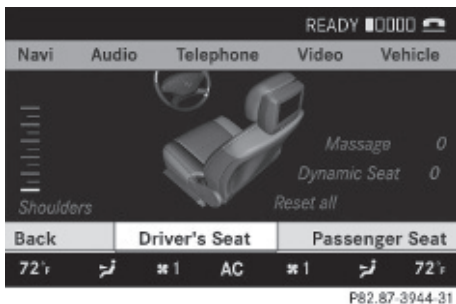

Example illustration: Drive-dynamic multicontour seat

- ▶ **Selecting seat:** Slide or rotate .
- ▶ **Confirming selection:** Press .

### Exiting menu

There are several ways to exit the multicontour seat menu.

- ▶ Press button again.
- or
- ▶ Press any shortcut button.
- or
- ▶ Select another main function from the main menu line.

### Lumbar support

To support the spine, you can adjust the curvature of the front seat backrests.

- ▶ Press button .
- The main area of the COMAND display is active. A scale appears.

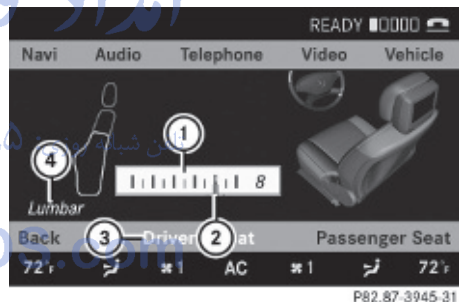

- ① Scale
- ② Cursor
- ③ Current seat
- ④ Current setting

- ▶ Select seat (▷ page 217).
- ▶ **Adjusting lumbar support:** Slide or rotate until desired setting is reached.
- ▶ **Confirming selection:** Press .
- ▶ **Switching to the bottom menu line:** Slide .
- ▶ **Confirming selection:** Press .

- ▶ **Information:** After you have pressed button , the seat last adjusted is active.

### Multicontour seats, front

- ❶ If PRE-SAFE® has been activated, the air pressure in the air chambers (on the sides of the seat cushion and seat backrest) of the front multicontour seats is increased.
- ❷ When you adjust the multicontour seat, noises may result from pumping air into or releasing air out of the air chambers.

To support the spine, you can individually adjust the seat backrest contour of the front seats by regulating the air pressure in the air chambers of the multicontour seat.

You can adjust the following air chambers:

- Sides of seat cushion
- Sides of seat backrest
- Seat backrest curvature in lumbar area
- Seat backrest curvature in shoulder area

The settings are made on the COMAND display.

### Adjusting sides of seat cushion

This function is used to adjust the air chambers in the sides of the seat cushion.

- ▶ Select seat (▷ page 216).
- ▶ **Selecting** Seat Sides: Slide  $\leftarrow \odot \rightarrow$  or rotate  $\left[ \odot \right]$ .
- ▶ **Confirming selection:** Press  $\odot$ .  
A scale appears.

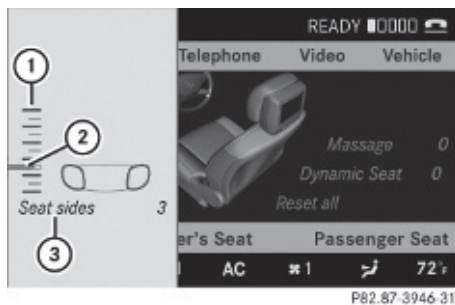

- ❶ Scale
- ❷ Cursor
- ❸ Current setting

- ▶ Slide  $\leftarrow \odot \rightarrow$  or rotate  $\left[ \odot \right]$  until desired setting is reached.
- ▶ **Saving setting:** Press  $\odot$ .

### Adjusting seat backrest sides

This function is used to adjust the air chambers in the seat backrest sides.

- ▶ Select seat (▷ page 216).
- ▶ **Selecting** Seatback Sides: Slide  $\leftarrow \odot \rightarrow$  or rotate  $\left[ \odot \right]$ .
- ▶ **Confirming selection:** Press  $\odot$ .  
A scale appears.

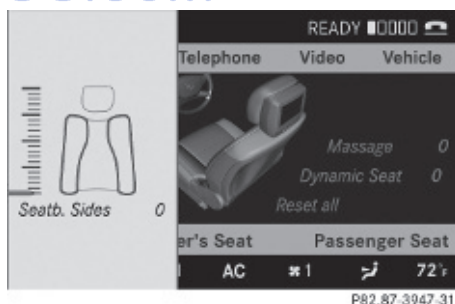

- ▶ Slide  $\leftarrow \odot \rightarrow$  or rotate  $\left[ \odot \right]$  until desired setting is reached.
- ▶ **Saving setting:** Press  $\odot$ .

## Adjusting seat backrest curvature in lumbar area

This function is used to adjust the air chambers in the lumbar area of the seat backrest.

- ▶ Select seat (▷ page 216).
- ▶ **Selecting Lumbar:** Slide ←○→ or rotate ⌚.
- ▶ **Confirming selection:** Press ⌂.  
Crosshair appears.  
You can use them to make two settings:
  - **vertical:** shift the point of greatest curvature upward or downward
  - **horizontal:** adjust the degree of curvature

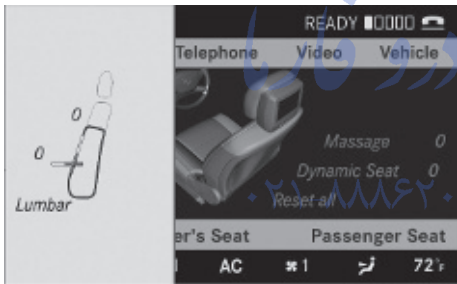

- ▶ Slide ↑○↓ or ←○→ until desired setting is reached.
- ▶ **Saving setting:** Press ⌂.

## Adjusting seat backrest curvature in shoulder area

This function is used to adjust the air chambers in the shoulder area of the seat backrest.

- ▶ Select seat (▷ page 216).
- ▶ **Selecting Shoulders:** Slide ←○→ or rotate ⌚.
- ▶ **Confirming selection:** Press ⌂.  
A scale appears.

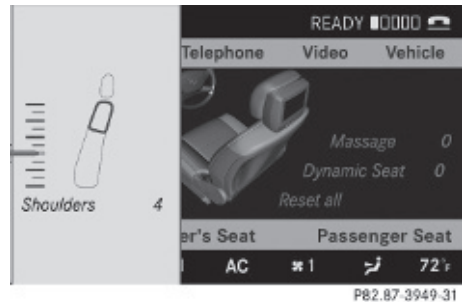

- ▶ Slide ↑○↓ or rotate ⌚ until desired setting is reached.
- ▶ **Saving setting:** Press ⌂.

## Drive-dynamic multicontour seats

For information on manual multicontour seat settings, see “Multicontour seats, front” (▷ page 218).

- ❗ If PRE-SAFE® has been activated, the air pressure in the air chambers (sides of seat cushion and seat backrest) of the drive-dynamic multicontour seats is increased.

The drive-dynamic multicontour seat automatically adjusts the lateral support provided by the seat backrest to your driving style.

The drive-dynamic multicontour seat electronically controls the air pressure in the air chambers of the seat backrest side bolsters. This function improves driving comfort and pleasure.

- ▶ Select seat (▷ page 216).
- ▶ **Selecting Dynamic Seat:** Slide ←○→ or rotate ⌚.
- ▶ **Confirming selection:** Press ⌂.  
A scale appears.

You can choose between:

- 0: off
- 1: level 1 (Less lateral support and slow air pressure build-up in the air chambers of the seat backrest side bolsters.)
- 2: level 2 (Strong lateral support and fast air pressure build-up in the air chambers of the seat backrest side bolsters.)

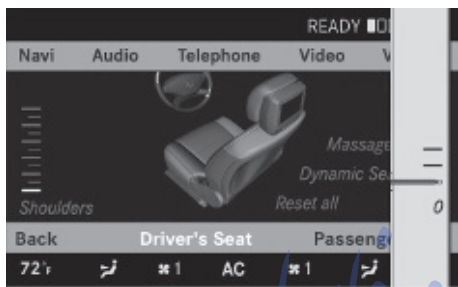

- ▶ Slide  $\uparrow \odot \downarrow$  or rotate  $\left[ \odot \right]$  until desired setting is reached.
- ▶ **Saving setting:** Press  $\odot$ .

## Message

- ▶ Select seat (▶ page 216).
- ▶ **Selecting Message:** Slide  $\leftarrow \odot \rightarrow$  or rotate  $\left[ \odot \right]$ .
- ▶ **Confirming selection:** Press  $\odot$ .

A list appears. You can choose between different types of massage:

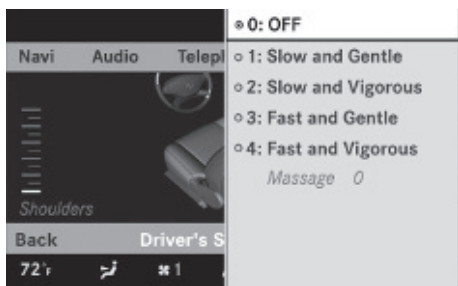

The current setting is indicated by a solid circle.

- ▶ Slide  $\uparrow \odot \downarrow$  or rotate  $\left[ \odot \right]$  until desired setting is reached.
- ▶ **Saving setting:** Press  $\odot$ .

**i** Depending on the setting, the massage function runs for about 7 to 10 minutes.

## Instrument cluster control system

### Introduction

The control system is activated as soon as the starter switch is in position 2.

The control system enables you to call up information about your vehicle and to change vehicle settings.

For example, you can use the control system to find out when your vehicle is next due for maintenance service, to call up statistical data on your vehicle, and much more.

### **Warning!**

A driver's attention to the road and traffic conditions must always be his/her primary focus when driving.

For your safety and the safety of others, selecting features through the multifunction steering wheel should only be done by the driver when traffic and road conditions permit it to be done safely.

Bear in mind that at a speed of just 30 mph (approximately 50 km/h), your vehicle is covering a distance of 44 feet (approximately 14 m) every second.

### **Warning!**









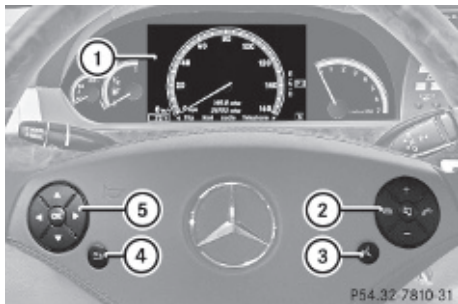



**HYBRID vehicles:** It is imperative that you read the HYBRID Supplemental Operating Instructions included in your vehicle literature portfolio. You may otherwise not receive all necessary safety information and warning for the operation of your vehicle.









The control system relays information to the multifunction display.

## Multifunction steering wheel

The displays in the multifunction display and the settings in the control system are controlled by using the buttons on the multifunction steering wheel.



①	Multifunction display
②	Press button  to end a call  to reject an incoming call  to answer a call  to dial <sup>32</sup>  to redial <sup>32</sup>  to mute
	Press button  to set the volume  to operate the RACETIMER <sup>33</sup>
③	Press button  to activate the Voice Control System
④	Press button briefly  to cancel the Voice Control System  to go back  to confirm messages

	Press and hold button  to select the standard display
⑤	Press button  to select menus 
	Press button briefly  to select function or scroll through lists  within Audio menu to select previous or next track, scene or stored station  within Telephone menu to switch to the phone book and select a name or number
	Press and hold button  within Audio to select previous or next station in station list or wave band  within Telephone menu to start the quick search in the phone book
	Press button  to confirm selection or messages

Depending on the selected menu, pressing the buttons on the multifunction steering wheel will alter what appears in the multifunction display.

The information available in the multifunction display is arranged in menus and accompanying functions. For example, in the Settings menu, you will find functions for making settings to your vehicle. There are functions for calling up information and for making settings to your vehicle.

<sup>32</sup> Function only available in telephone menu.

<sup>33</sup> AMG vehicles only.



It is helpful to think of the menus, and the functions within each menu, as being arranged in a circular pattern.

▶ Press button ◀ or ▶ repeatedly to switch menus.

The number of menus available in the system depends on which optional equipment is installed in your vehicle.

▶ Press button ⇐ to return to the next highest menu level.

From a menu's highest level, you will always see the screen from the Trip menu that was last active. When you press button ⇐ again, you switch to the standard display (▶ page 223).

### Multifunction display

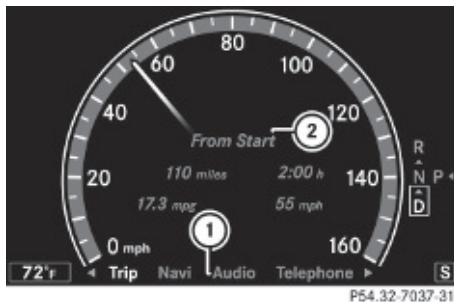

- ① Main menu
- ② Text field

Settings, functions as well as any malfunctions appear in the text field.

For more information on menus displayed in the multifunction display, see "Menus" (▶ page 222).

اردو خوردو فارما

### Menus

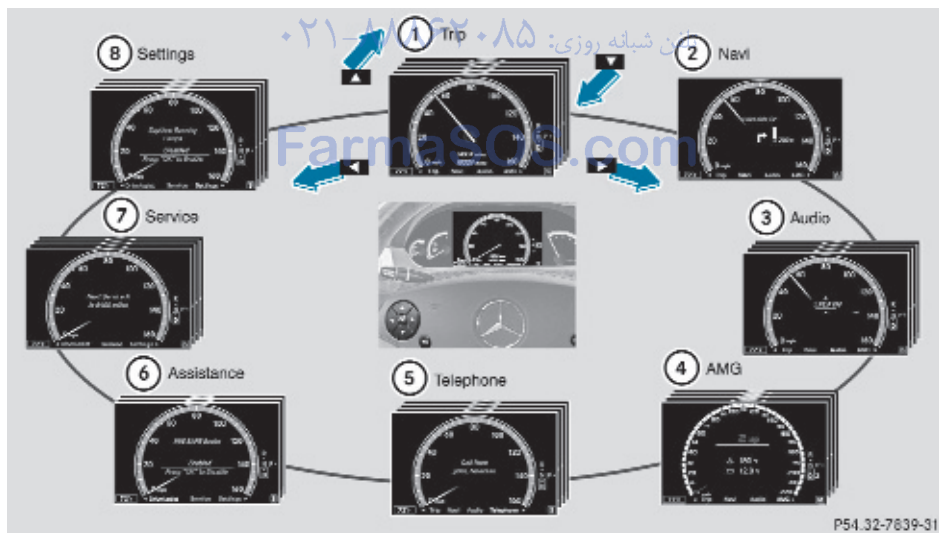

	Function
①	<b>Trip</b> menu (▷ page 223)
②	<b>Navi</b> menu (▷ page 225)
③	<b>Audio</b> menu (▷ page 226)
④	<b>AMG<sup>34</sup></b> menu (▷ page 227)
⑤	<b>Telephone</b> menu (▷ page 230)
⑥	<b>Assistance</b> menu (▷ page 231)
⑦	<b>Service</b> menu (▷ page 233)
⑧	<b>Settings</b> menu (▷ page 234)

### Trip menu

In the Trip menu, you can show an additional display for the speedometer and call up or reset your vehicle's statistical data.

The following information is available:

- Standard display (▷ page 223)
- Fuel consumption statistics since start (▷ page 223)
- Fuel consumption statistics since last reset (▷ page 224)
- Resetting values (▷ page 224)
- Remaining driving range and current fuel consumption (▷ page 224)
- Digital Speedometer (▷ page 224)

### Standard display

- ▶ Press button ◀ or ▶ to select the Trip menu.

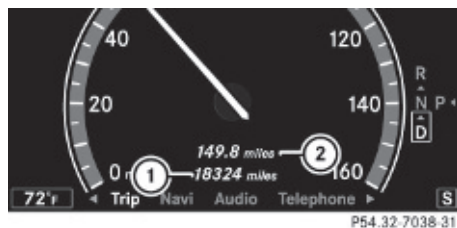

In the standard display, the main odometer ① and the trip odometer ② appear in the multifunction display.

### Fuel consumption statistics since start

- ▶ Press button ◀ or ▶ to select the Trip menu.
- ▶ Press button ▼ or ▲ to select From Start.







- ① Distance driven since start
- ② Time elapsed since start
- ③ Average speed since start
- ④ Average fuel consumption since start

All statistics stored since the last engine start will be reset approximately 4 hours after the SmartKey in the starter switch is turned to position **0** or removed from the starter switch. Resetting will not occur if you turn the SmartKey back to position **1** or **2** within this time period.

<sup>34</sup> AMG vehicles only.

### Fuel consumption statistics since last reset



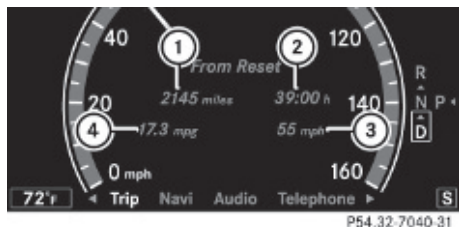

- ▶ Press button  or  to select the Trip menu.
- ▶ Press button  or  to select From Reset.



- ① Distance driven since last reset
- ② Time elapsed since last reset
- ③ Average speed since last reset
- ④ Average fuel consumption since last reset

### Resetting values

You can reset the values for the following functions:

- Trip odometer
  - Fuel consumption statistics since start
  - Fuel consumption statistics since last reset
- ▶ Press button  or  to select the Trip menu.
  - ▶ Press button  or  to select the function you wish to reset.
  - ▶ Press button .

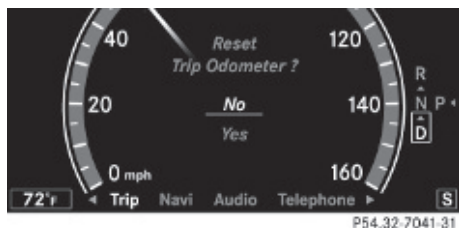





Example illustration: Reset trip odometer

- ▶ Press button  to select Yes.
- ▶ Press button  to confirm.

The fuel consumption statistics reset automatically to 0 after 99 999 miles or 9 999 hours, whichever occurs first.



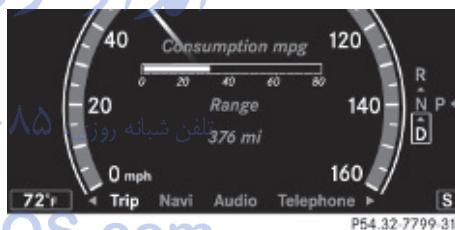

### Remaining driving range and current fuel consumption

- ▶ Press button  or  to select the Trip menu.
- ▶ Press button  or  to select the estimated remaining driving range and current fuel consumption display. Note that the values are calculated based on the current fuel tank level and the current driving style. Make sure to refuel in time.

If only very little fuel is left in the tank, a vehicle at the fuel pump  appears instead of the estimated remaining driving range.



### Digital speedometer

- ▶ Press button  or  to select the Trip menu.
- ▶ Press button  or  to select the digital speedometer.

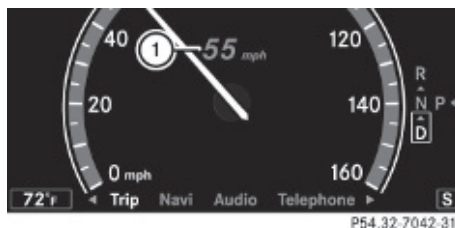

- ① Digital speedometer

## Navi menu

The display in the Navi menu depends on whether route guidance is active or not.

- ▶ Press button ◀ or ▶ to select the Navi menu.

## Route guidance not active

The multifunction display shows the direction of travel and the name of the street you are currently driving on, if known by the navigation system.

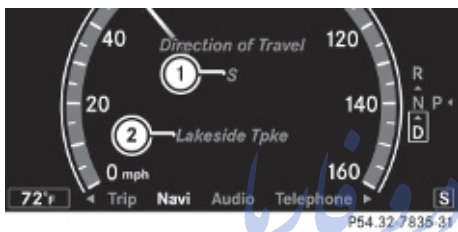

- ① Direction of travel
- ② Street you are currently driving on

## Route guidance active

The image in the multifunction display depends on whether you are being notified of a driving maneuver.

### No notification of driving maneuver

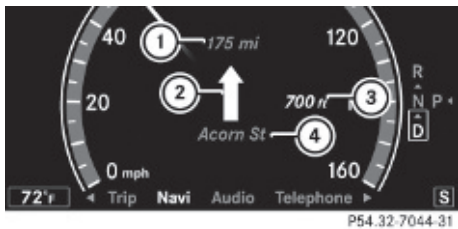

Example illustration

- ① Distance to destination
- ② Symbol for “follow the course of the road”
- ③ Distance to next driving maneuver
- ④ Street you are currently driving on

### Driving maneuver announced without lane advice

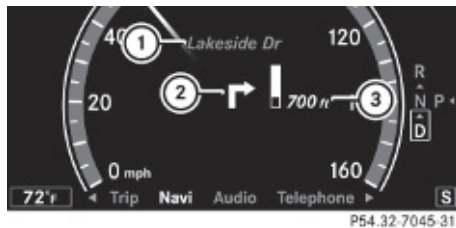

Example illustration

- ① Street into which the driving maneuver leads
- ② Symbol for driving maneuver
- ③ Distance to driving maneuver and graphical distance representation

When you are being notified of a driving maneuver, you will see a visual distance display ③ next to the driving maneuver symbol. The visual distance display is reduced from bottom to top the closer you come to the announced driving maneuver.

### Driving maneuver announced with lane advice

Lane advice is displayed only when the respective data are available on the digital map.

When driving on multilane roads or highways, COMAND can display lane advice for the next driving maneuver.

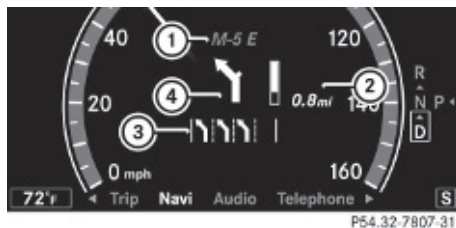

- ① Road into which the driving maneuver leads
- ② Distance to driving maneuver and graphical distance representation
- ③ Lane advice
- ④ Symbol for driving maneuver

During a driving maneuver additional lanes may become available on the road or highway.

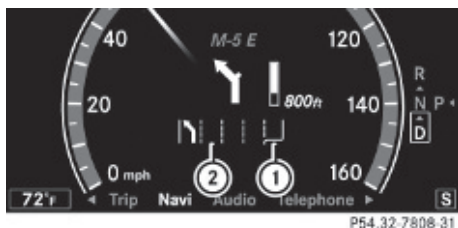

- ① Lane that opened up during the driving maneuver
- ② Through lane

### Navigation status displays in the instrument cluster

While route guidance is active, the following messages may be shown in the multifunction display:

- You have reached your destination.
- Area of dest. reached  
You have arrived in the area of your destination. The message appears, for example, for relatively large POIs.
- New route...  
COMAND calculates a new route, e.g. because you have deviated from the calculated route or due to a detour report. Afterward, COMAND continues route guidance.
- Calculating route  
COMAND is calculating a route. Afterward, COMAND starts route guidance.
- Off map  
The vehicle's location is outside of the digital map's range. The vehicle is in an off-map position (▷ page 134).
- Off mapped road  
The vehicle is either on a road that has not been digitized (▷ page 134) or on the side of a road, e.g. in a parking space.
- No route

COMAND cannot calculate a route to the selected destination.

- Direction of Dest.

The vehicle has gone off the map during route guidance (▷ page 134).

### Audio menu

The functions in the Audio menu operate the audio equipment which you have currently switched on.

The following functions are available:

- Selecting radio station (▷ page 226)
- Operating audio devices/audio media (▷ page 227)
- Operating video DVD (▷ page 227)

If no audio equipment is currently switched on, the message Audio OFF appears in the multifunction display.

- ▶ **To adjust the volume:** Press button or on the multifunction steering wheel. تلفن شماره رو.

### Selecting radio station

- The SIRIUS XM Satellite Radio is treated as a radio application.

Additional optional satellite radio equipment and a subscription to a satellite radio service provider are required for satellite radio operation. Contact an authorized Mercedes-Benz Center for details and availability for your vehicle.

For more information on satellite radio operation, see "Satellite radio" (▷ page 170).

- ▶ Switch on the COMAND system and select AM/FM radio (▷ page 165) or satellite radio (▷ page 170).
- ▶ Press button or to select the Audio menu.  
The currently tuned station appears in the multifunction display.



Example illustration for FM radio

- ① Station frequency
- ② Wave band setting

▶ **Selecting next or previous stored station:** Press button  or  briefly to select a stored station.

▶ **Selecting next or previous station in wave band:** Press and hold button  or  to select a station.

You can only change the frequency band and save new stations using the COMAND system, see (▶ page 169) (AM/FM radio) or (▶ page 175) (satellite radio).

### Operating audio devices/audio media

- ▶ Switch on the COMAND system and select CD, DVD-Audio or MP3 (▶ page 176).
- ▶ Press button  or  to select the Audio menu.



Example: audio CD

- ① Current track

▶ Press button  or  to select a track.

❗ When you play a CD or DVD with text, the multifunction display shows the name and number of the track. For MP3s, only the track is shown.

### Operating video DVD

- ▶ Switch on the COMAND system and select Video → Video → Video DVD (▶ page 192).
- ▶ Press button  or  to select the Audio menu.



- ① Current scene
- ② Disc number

▶ Press button  or  to select a scene.

### AMG menu

This function is only available in AMG vehicles.

The main screen of the AMG menu shows you

- the gear currently engaged
  - the engine oil temperature
  - the vehicle supply voltage
- ▶ Press button  or  to select the AMG menu.

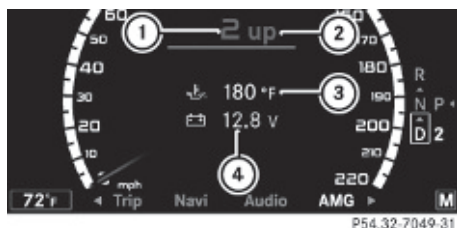



- ① Gear indicator
- ② Upshift indicator
- ③ Engine oil temperature indicator
- ④ Vehicle supply voltage indicator



The engine oil temperature will be shown in blue if the engine oil temperature has not yet reached 176°F (80°C). During this time, avoid driving at full engine speed.

If the engine reaches the overspeed range in the manual shift program, you will see up next to gear indicator ① as a reminder to upshift.

Use buttons  or  to select the following functions in the AMG menu:



- RACETIMER (▷ page 228)
- Overall analysis (▷ page 229)
- Lap analysis (▷ page 229)

## RACETIMER

### Warning!

The RACETIMER feature is only for use on roads and in conditions where high speed driving is permitted. Racing on public roads is prohibited under all circumstances. The driver is and must always remain responsible for following posted speed limits.



The RACETIMER allows you to time and save driving stretches.



- ▶ Press button  or  to select the AMG menu.
- ▶ Press button  to select the RACETIMER.



- ① Gear indicator
- ② Second hand
- ③ RACETIMER
- ④ Lap

You can start the RACETIMER when the engine is running or the starter switch is in position **2** (▷ page 284).

While the RACETIMER is being displayed, you cannot adjust the audio volume using buttons  or .

- ▶ **Starting:** Press button .
- ▶ **Displaying intermediate time:** Press button  while the timer is running. The intermediate time is shown for 5 seconds.
- ▶ **Stopping:** Press button .



When you stop the vehicle and turn the SmartKey to position **1** (▷ page 284) or, in vehicles with KEYLESS-GO, turn off the engine and do not open the driver's door, the RACETIMER stops timing. Timing is resumed when you press button  after switching the ignition back on or restarting the engine.

When you switch on the Night View Assist Plus (▷ page 356) while the RACETIMER is operating, the RACETIMER will continue to run in the background but cannot be operated with the multifunction steering wheel buttons.

To stop the RACETIMER, switch off the Night View Assist Plus first.

### Saving lap time and starting a new lap

You can save up to 16 laps.

- ▶ Press button  while the timer is running. The intermediate time will be shown for 5 seconds.
- ▶ Press button  within 5 seconds. The intermediate time shown will be saved as a lap time. The RACETIMER begins timing the new lap. The new lap begins to be timed as soon as the intermediate time is called up.



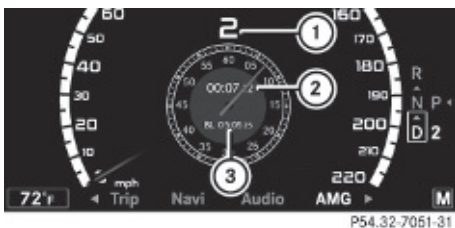

- ① Gear indicator
- ② RACETIMER
- ③ Best lap time

### Resetting current lap

- ▶ Press button  while the timer is running.  
The timer stops.
- ▶ Press button .
- ▶ The lap time is reset to "0".

### Deleting all laps

It is not possible to delete a single saved lap.

- ▶ Press button  while the timer is running.  
The timer stops.
- ▶ Press button  for at least 3 seconds.
- ▶ Press button .
- ▶ The timer starts. The saved laps are deleted.

or

- ▶ Press button .
- ▶ The reset menu appears in the multifunction display.

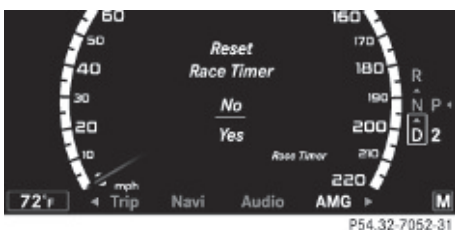

- ▶ Press button  to select Yes and confirm with button .
- ▶ The saved laps are deleted.

### Overall analysis

This function is only available if you have saved at least one lap and have stopped the RACETIMER.

- ▶ Press button  or  to select the AMG menu.
- ▶ Press button  repeatedly until the overall analysis appears in the multifunction display.

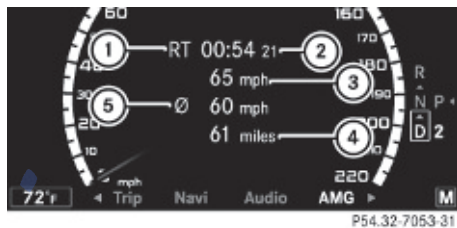

- ① Overall analysis of RACETIMER
- ② Overall driving time
- ③ Maximum speed
- ④ Overall distance driven
- ⑤ Average speed



### Lap analysis

This function is only available if you have saved at least two laps and have stopped the RACETIMER.

- ▶ Press button  or  to select the AMG menu.
- ▶ Press button  repeatedly until the lap analysis appears in the multifunction display.

Each lap is shown in its own submenu. The fastest lap is indicated by flashing symbol ①.



- ① Lap number
  - ② Lap time
  - ③ Maximum speed during lap
  - ④ Lap length
  - ⑤ Average speed during lap
- ▶ Press button  or  to see other lap analyses.



### Telephone menu

#### Warning!

A driver's attention to the road must always be his/her primary focus when driving. For your safety and the safety of others, we recommend that you pull over to a safe location and stop before placing or taking a telephone call. If you choose to use the telephone while driving, please use the hands-free device and only use the telephone when weather, road and traffic conditions permit.

Some jurisdictions prohibit the driver from using a mobile phone while driving a vehicle. Bear in mind that at a speed of just 30 mph (approximately 50 km/h), your vehicle is covering a distance of 44 feet (approximately 14 m) every second.

You can connect your telephone to the COMAND system via Bluetooth® (▷ page 151).

- ▶ Switch on the telephone and the COMAND system.
- ▶ Press button  or  to select the Telephone menu. One of the following messages will appear in the multifunction display:
  - No service: No network is available.
  - Ready for Bluetooth telephony...: The telephone has not been connected to the COMAND system via Bluetooth® yet.
    - ▶ Connect the telephone to the COMAND system via Bluetooth® (▷ page 152).
  - Telephone Ready or name of the network provider (if available): The telephone has found a network and is ready for use. You can operate it using the control system.

### Answering a call

When your telephone is ready to receive calls, you can answer a call at any time with the ignition on. When you are in the Telephone menu, you will see the following message in the multifunction display:

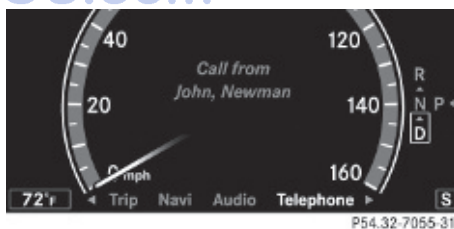

Example illustration



- ▶ Press button .
- The caller's number appears only if it is transmitted.
- The caller's name appears only if the number and the name are stored in the phone book.



## Ending a call or rejecting an incoming call



- ▶ Press button .





## Dialing a number from the phone book



When your telephone is ready to receive calls, you may select and dial a number from the phone book at any time.

- ▶ Press button  or  to select the Telephone menu.

- ▶ Press button  or  or  to switch to the phone book. The stored names are displayed in ascending alphabetical order.

- ▶ Press button  or  to select the desired entry.

If you press and hold button  or  the system scrolls rapidly through the list of names (quick search). After holding button  or  for a short while the scrolling speed increases. Release the button to stop the quick search. The search stops automatically at the end of the list.

- ▶ If the Symbol  appears on the right-hand side of the name several entries are present for the same name: Press button  or  and select the desired entry.

- ▶ Press button  or .

The control system dials the selected phone number.

If the connection is successful and this feature is supported by your network provider, the name of the party (if stored in your phone book) you are calling will appear in the multifunction display.



The control system stores the dialed number in the redial memory.

or



- ▶ Press button  if you do not want to make the call.

## Redialing

The control system stores the most recently dialed phone numbers. This eliminates the need to search through your entire phone book.

- ▶ Press button  or  to select the Telephone menu.

- ▶ Press button .

- ▶ Press button  or  to select the desired number or name.

- ▶ Press button  or .

The control system dials the selected phone number.

## Assistance menu

In the DriveAssist menu, you can change the settings of your driving systems.

The following functions are available:

- Displaying distance graphic, DISTRONIC PLUS (▷ page 334)
- Switching ESC on or off (▷ page 232)
- Activating/deactivating PRE-SAFE® Brake (vehicles with DISTRONIC PLUS only) (▷ page 232)
- Switching ATTENTION ASSIST on or off (▷ page 232)
- Switching Blind Spot Assist on or off (▷ page 233)
- Switching Lane Keeping Assist on or off (▷ page 233)

## Switching ESC on or off





### Warning!

Never switch off the ESC when you see the ESC warning lamp  flashing in the instrument cluster. In this case proceed as follows:

- When driving off, apply as little throttle as possible.
- While driving, ease up on the accelerator pedal.
- Adapt your speed and driving style to the prevailing road conditions.

Failure to observe these guidelines could cause the vehicle to skid. The ESC cannot prevent accidents resulting from excessive speed.

For more Information, see  page 66)



- ▶ Start the engine.
- ▶ Press button  or  to select the DriveAssist menu.
- ▶ Press button  or  to select the ESC function
- ▶ Press button .



- ▶ Press button  again if you would like to change the current status. Depending on the previous status, ESC will be Enabled or Disabled

### Warning!

When the ESC OFF warning lamp  is on, the ESC is switched off.





When the ESC warning lamp  and the ESC OFF warning lamp  are on

continuously, the ESC is not operational due to a malfunction.



When the ESC is switched off or not operational, vehicle stability in standard driving maneuvers is reduced.

Adapt your speed and driving to the prevailing road conditions and to the non-operating status of the ESC.

## Activating/deactivating PRE-SAFE® Brake (vehicles with DISTRONIC PLUS only)

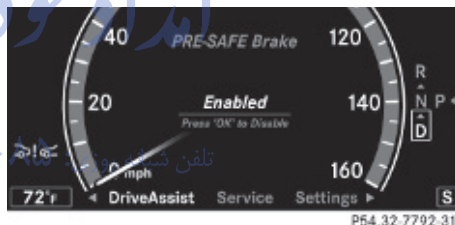



- ▶ Press button  or  to select the DriveAssist menu.
- ▶ Press button  or  to select the PRE-SAFE Brake function.
- ▶ Press button .





- ▶ Press button  again if you would like to change the current status. After the function has been activated, PRE-SAFE® Brake indicator  appears on the left-hand side of the multifunction display. When the HOLD function is switched on, the PRE-SAFE® Brake indicator  will not appear.

For more information on PRE-SAFE® Brake, see  page 69).

## Switching ATTENTION ASSIST on or off

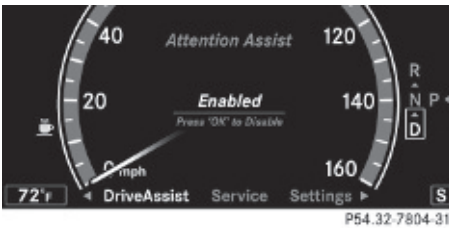



- ▶ Press button  or  to select the DriveAssist menu.
- ▶ Press button  or  to select the Attention Assist function
- ▶ Press button .



- ▶ Press button **OK** again if you would like to change the current status. After the function has been activated, ATTENTION ASSIST indicator  appears on the left-hand side of the multifunction display.

For more information on ATTENTION ASSIST, see (▷ page 355).



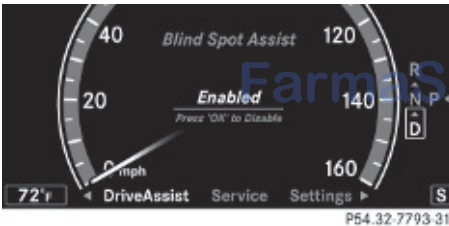

### Switching Blind Spot Assist on or off

- ▶ Press button  or  to select the DriveAssist menu.
- ▶ Press button  or  to select the Blind Spot Assist function
- ▶ Press button **OK**.



- ▶ Press button **OK** again if you would like to change the current status. Depending on the previous status, Blind Spot Assist will be Enabled or Disabled
- For more information on Blind Spot Assist, see (▷ page 359).

### Switching Lane Keeping Assist on or off

- ▶ Press button  or  to select the DriveAssist menu.
- ▶ Press button  or  to select the Lane Keeping Assist function
- ▶ Press button **OK**.

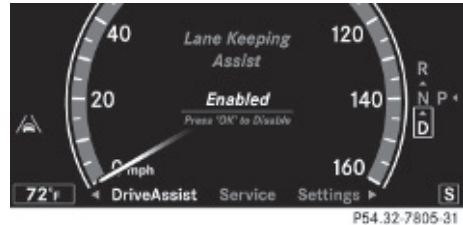

- ▶ Press button **OK** again if you would like to change the current status. After the function has been activated, the Lane Keeping Assist indicator  appears on the left-hand side of the multifunction display.
- For more information on Lane Keeping Assistance, see (▷ page 362).

### Service menu

In the Service menu the following functions are available:

- Vehicle status message memory (▷ page 233)
- Checking tire inflation pressure electronically with the Advanced TPMS (▷ page 414)
- Calling up the maintenance service indicator display (▷ page 439)
- Checking engine oil level (S 600 and S 65 AMG) (▷ page 406)

### Vehicle status message memory



Use the vehicle status message memory function to scan malfunction and warning messages that may be stored in the system. Such messages appear in the multifunction

display and are based on conditions or system status the vehicle's system has recorded.





The vehicle status message memory function only appears if there are any messages stored.

### Warning!

Malfunction and warning messages are only indicated for certain systems and are intentionally not very detailed. The malfunction and warning messages are simply a reminder with respect to the operation of certain systems. They do not replace the owner's and/or driver's responsibility to maintain the vehicle's operating safety. Have all required maintenance and safety checks performed on the vehicle. Bring the vehicle to an authorized Mercedes-Benz Center to address the malfunction and warning messages.

- ▶ Press button  or  to select the Service menu.

If conditions have occurred causing status messages to be recorded, the number of messages appears in the multifunction display: 2 Messages.

- ▶ Press button  or  to select the Messages function.
- ▶ Press button  to confirm.  
For malfunction and warning messages, see "Vehicle status messages in the multifunction display" (▷ page 452).
- ▶ Use button  or  to scroll through the messages.

If you turn the SmartKey in the starter switch to position 0 and then back to position 2, all messages will be deleted from the message memory.





### Settings menu



In the Settings menu the following functions are available:

- Switching daytime running lamp mode on or off (USA only) (▷ page 234)
- Setting Adaptive Highbeam Assist (▷ page 235)
- Showing or hiding additional speedometer (▷ page 235)
- Selecting speedometer display mode (▷ page 235)
- Activating/deactivating the seat belt adjustment function (▷ page 236)
- Switching the radar sensors on or off (▷ page 236)

### Switching daytime running lamp mode on or off (USA only)

- ▶ Press button  or  to select the Settings menu.
- ▶ Press button  or  to select the Day Running Lamps function.
- ▶ Press button .

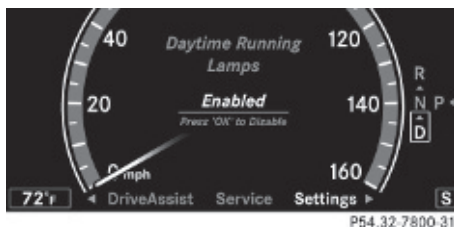

- ▶ Press button **OK** again if you would like to change the current status. Depending on the previous status, the Daytime Running Lamps will be switched on (Enabled) or off (Disabled).

With Daytime Running Lamps mode Enabled selected and the exterior lamp switch at position **0** or **A**, the low-beam headlamps are switched on when the engine is running.

In low ambient light conditions the following lamps will come on additionally:

- Parking lamps
- Tail lamps
- License plate lamps
- Side marker lamps

For more information on the daytime running lamp mode, see “Lighting” (▷ page 299).

- i** Make sure the exterior lamp switch is set to **D** or **A** when you switch off the daytime running lamps while driving at night.

For more information on the Adaptive Highbeam Assist, see (▷ page 301).

### Showing or hiding additional speedometer

You can have an additional digital speedometer shown in the multifunction display. Depending on the setting for the speedometer display mode (▷ page 235), the speed is shown in the unit of kilometers/hour (setting miles) or miles/hour (setting km).

- ▶ Press button **◀** or **▶** to select the Settings menu.
- ▶ Press button **▼** or **▲** to select the Add. Speedometer function.
- ▶ Press button **OK**.



P54.32-7796-31

### Setting Adaptive Highbeam Assist

- ▶ Press button **◀** or **▶** to select the Settings menu.
- ▶ Press button **▼** or **▲** to select the Adapt. High-beam Ass. .
- ▶ Press button **OK**.

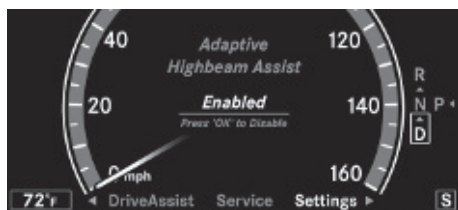

P54.32-7801-31

- ▶ Press button **OK** again if you would like to change the current status. Depending on the previous status, the Add. Speedometer will be switched On or Off.

### Selecting speedometer display mode

- ▶ Press button **◀** or **▶** to select the Settings menu.
- ▶ Press button **▼** or **▲** to select the Units function.
- ▶ Press button **OK**.

- ▶ Press button **OK** again if you would like to change the current status. Depending on the previous status, the Adaptive Highbeam Assist will be Enabled or Disabled.



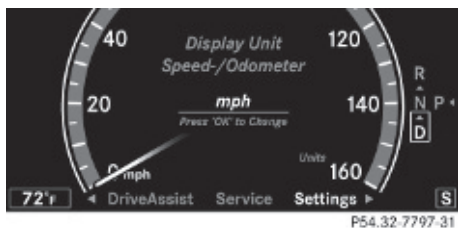

- ▶ Press button **[OK]** again if you would like to change the current status. Depending on the previous status, the Display Unit Speed-/Odometer will be switched to miles or km. The additional speedometer (▷ page 235) will be shown in the other unit.

### Activating/deactivating the seat belt adjustment function<sup>35</sup>

Use this function to set the seat belts to be adjusted automatically with the driver's or front passenger seat belt fastened and the starter switch in position **2**.

For more information on the seat belt adjustment function, see (▷ page 52).

- ▶ Press button **[◀]** or **[▶]** to select the Settings menu.
- ▶ Press **[OK]**.
- ▶ Press button **[▼]** or **[▲]** to select the Belt Adjustment function.

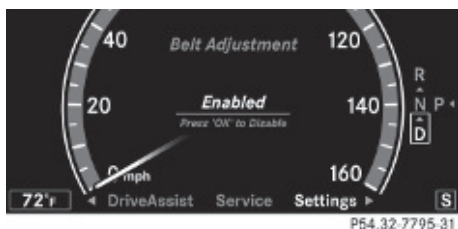

- ▶ Press button **[OK]** again if you would like to change the current status. Depending on the previous status, the Belt Adjustment function will be Enabled or Disabled.

### Switching the radar sensors on or off

If your vehicle is equipped with DISTRONIC PLUS or BAS PLUS it is equipped with a radar sensor system which you can switch on and off.

When traveling in Canada in a vehicle not registered in Canada, you must switch off the radar sensor system. Canadian law does not permit the use of the radar sensor system for vehicles from outside of Canada. When you switch off the radar sensor system, the following functions are deactivated:

- BAS PLUS (▷ page 64)
- PRE-SAFE® Brake (▷ page 69)
- DISTRONIC PLUS (▷ page 330)
- Blind Spot Assist (▷ page 359)

#### **i** USA only:

This device has been approved by the FCC as a "Vehicular Radar System". The radar sensor is intended for use in an automotive radar system only. Removal, tampering, or altering of the device will void any warranties, and is not permitted by the FCC. Do not tamper with, alter, or use in any non-approved way.

Any unauthorized modification to this device could void the user's authority to operate the equipment.

#### **i** Canada only:

This device complies with RSS-210 of Industry Canada. Operation is subject to the following two conditions:





1. This device may not cause interference, and
2. this device must accept any interference received, including interference that may cause undesired operation of the device.

Removal, tampering, or altering of the device will void any warranties, and is not

<sup>35</sup> Depending on vehicle production date

permitted. Do not tamper with, alter, or use in any non-approved way.

Any unauthorized modification to this device could void the user's authority to operate the equipment.

- ▶ Press button  or  to select the Settings menu.
- ▶ Press button  or  to select the Radar Sensors function.
- ▶ Press button .

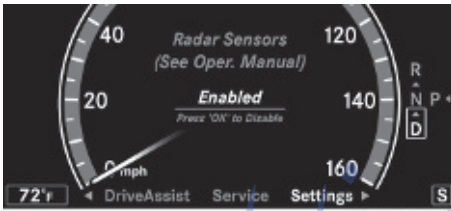

- ▶ Press button  again if you would like to change the current status. Depending on the previous status, the Radar Sensors will be switched on (Enabled) or off (Disabled).

**i** The selected status of the radar sensors remains stored in memory even if the engine is turned off and restarted.

The following message appears in the multifunction display if the radar sensors are switched off and you attempt to activate DISTRONIC PLUS or PRE-SAFE® Brake: Radar Sensors (See Oper. Manual) Disabled

## Voice Control System introduction

### Safety notes

#### Warning!

Only use the Voice Control System when road and traffic conditions permit you to do so. Otherwise you could be involved in an

accident in which you or others could be injured.

#### Warning!

Please devote your attention first and foremost to the traffic situation you are in. While the system permits hands-free phone operation, attention to traffic may be diverted not only by physical operation of a phone, but also by the distraction of a phone conversation while driving. As such, for safety reasons, we encourage the driver to stop the vehicle in a safe place before answering or placing a phone call.

For safety reasons, you should only select a destination when the vehicle is stationary.

While the navigation system provides directional assistance, the driver must remain focused on safe driving behavior, especially attention to traffic and street signs, and should utilize the system's audio cues while driving.

The navigation system does not supply any information on stop signs, yield signs, traffic regulations or traffic safety rules. Their observance always remains in the driver's personal responsibility. Maps do not cover all areas nor all routes within an area.

Traffic regulations always have priority over any route recommendations given.

Bear in mind that at a speed of just 30 mph (approximately 50 km/h), your vehicle is covering a distance of 44 feet (approximately 14 m) every second.

#### Warning!

Navigation announcements are intended to direct you while driving without diverting your attention from the road and driving.

Please always use navigation announcements instead of consulting the map display for directions. Consulting the symbols or map display for directions may cause you to divert your attention from driving and increase your risk of an accident.

**Warning!**

Please do not use the Voice Control System in an emergency, as the tone of your voice may change in a stressful situation. This could cause a delay in completing your phone call in a timely manner. This could distract you in an emergency situation and cause you to be involved in an accident.

**General information**

Depending on vehicle equipment, you can operate the following systems via the Voice Control System:

- Telephone (▷ page 245)
- Navigation (▷ page 240)
- Address book (▷ page 249)
- Audio (▷ page 252) (AM/FM radio, Satellite radio, CD/DVD changer, MP3 mode (SD card, USB, Music Register, Media Interface), AUX)
- Video

You control these systems using spoken commands. Moreover, controls such as the buttons on the multifunction steering wheel (▷ page 238) allow you to keep your hands on the steering wheel.

The Voice Control System recognizes commands and number sequences, irrespective of the speaker. To optimize speech recognition for your voice follow the individualization process (▷ page 271).

You can use the Voice Control System to call up all of COMAND's main menu items.

The commands can be spoken without pausing between the individual words. If an unavailable or incorrect command is used, the Voice Control System will prompt you for a new command by asking "Please repeat" or "Please repeat your entry".

The Voice Control System will confirm important commands and inform you in case of incorrect entries.

**i** To support the user, the Voice Control System contains an extensive help function (▷ page 267).

You can use the commands "Continue" or "Back" to scroll up or down in lists.

The command "Correction" lets you repeat the entry.

**Controls****Operation via the multifunction steering wheel**

The Voice Control System is operational approximately 30 seconds after switching on the COMAND.

**Item**

①		Activating the Voice Control System Answering a call
②		Canceling the Voice Control System
③		Increasing volume
		Decreasing volume

**i** The Voice Control System can be canceled at any time, even during a dialog. Please note that if the Voice Control System is canceled during a dialog, the complete procedure stops. If reactivated, dialog starts from the beginning.

## Starting the dialog with the Voice Control System

- ▶ Switch on the ignition (▷ page 284).
- ▶ Press button  on the multifunction steering wheel.  
An acoustic signal sounds. The dialog is started.
- ▶ Speak a command.

## Pausing and resuming a dialog

### Pausing

You can pause the dialog when a selection list is displayed in COMAND.

- ▶ Speak the command “Pause”.  
Continue With Push-to-talk appears at the top of the selection list. You can select an entry using the COMAND controller.

### Resuming



- ▶ Press button  on the multifunction steering wheel.  
The dialog is resumed.

## Aborting dialog

- ▶ Press button  on the multifunction steering wheel.
- or
- ▶ Speak one of the commands “Stop”, “Quit”, “Abort”, “Terminate”, “Cancel” or “Exit”.  
This does not apply when entering voice names or during the individualization process.
- or
- ▶ Press any COMAND button.

## Setting volume level

- ▶ Activate the Voice Control System.
- ▶ Speak a command, for example “Help”.

- ▶ Press button  or . The volume is increased or decreased during voice output.

or

- ▶ Set volume for voice output using the COMAND volume thumbwheel on the lower part of the front center console (▷ page 88).

- i** You can also set the text reader speed (▷ page 91).

## Displays

### COMAND Display

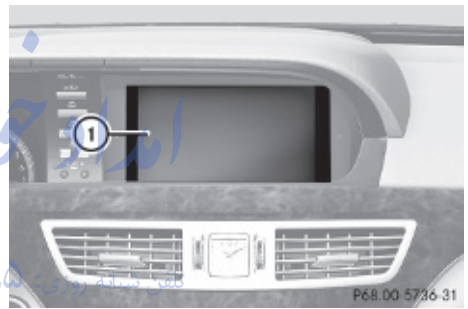

In addition to the acoustic help function, a visual help function (▷ page 93) is available on COMAND display ①.

Upon activating the Voice Control System, the most important available commands for the currently active mode appear on COMAND display ①.

When the Voice Control System requires additional information from the user, a selection list is shown on COMAND display ① in the address book and navigation system.



## Multifunction display



For example, telephone numbers are shown in the multifunction display ① while dialing when the main Telephone menu is selected in the instrument cluster control system.

### Symbols

The following symbols are found in the Voice Control System pages:

-  This symbol stands for commands and voice names you are speaking.
-  This symbol stands for voice output by the Voice Control System.
-  This symbol indicates that information is available on the COMAND display.

## Voice Control System navigation

### Important notes

### Safety notes for using the Voice Control System

 **Observe Safety notes, see page 237.**

### Safety notes for using the navigation system



 **Observe Safety notes, see page 95.**

## Navigation operation

You can use the Voice Control System to

- enter a country, state or province
- enter a city
- enter a district or a center
- enter a street
- enter an intersection
- enter a house number
- enter a zip code
- find address
- enter a POI (point of interest)
- select one of your last destinations
- calling up route information
- save a destination
- navigate to a destination stored in the destination memory of the address book
- display the map
- zoom the map in or out
- listen to the destination memory
- cancel route guidance
- start route guidance
- turn guide instructions on or off

## Selecting navigation mode

- ▶ Press button .
- ▶ Speak the command “Navigation”.
- ▶ Press button .
- ▶ Speak one of the navigation commands.

**i** You can use spoken navigation commands even when COMAND is in a mode other than navigation mode.

## Navigation commands

**i** You cannot start the route guidance until all necessary address data has been entered.

For a list of commands, see (▷ page 257).

### “Help navigation”

Use the command “Help navigation” to read out an option list of available functions and commands that can be used in conjunction with the navigation system.

#### Entering an address

Speak the commands and address data in whole words.





The system guides you completely through the dialog to route guidance. As soon as a valid address is entered (at least the town), you can use the “Start route guidance” command to start the route guidance.

When multiple choices for an entry are available, the system offers a numbered list of possible entries in the COMAND display. You will then have to select a line number. This number is taken over by the system.

- i** You can use the commands “Continue” or “Back” to scroll up or down in lists.

The command “Correction” lets you repeat the entry.

#### Sample dialog:

-  The system shows a numbered list of states recognized by the system.
-  Please select a line number.
-  Number two.
-  Number two accepted.





The selected entry is adopted from the list.

- i** Address entries for Puerto Rico must be spelled. For information on spelling, see (▷ page 268).

### “Enter state”, “Enter province”

Use the command “Enter state” or “Enter province” to select a different state or province on the navigation system.

#### Sample dialog:













-  Enter state.
-  Please say the name of the state.
-  New York.
-  New York accepted.

### “Enter destination”

Use the command “Enter destination” to enter a complete destination address.

The system guides you completely through the dialog to route guidance. As soon as a valid address is entered (at least the town), you can use the “Start route guidance” command to start the route guidance.

#### Sample dialog:



















-  Enter destination.
-  Preselected state is New York. Do you want to enter town first or street first?
-  Town first.
-  Please say the name of the town.
-  Nanuet.
-  Nanuet accepted.
-  Please say the name of the street.
-  Main Street.
-  Main Street accepted.
-  Do you want to start route guidance?
-  Yes.
-  Start route guidance.

The system calculates the route and, upon completing route calculation, starts route guidance.

### “Points of interest”

Use the command “Points of interest” to select a point of interest (POI) such as airports, railroad stations, gas stations etc.

**Sample dialog:**

-  Points of interest.
-  The system shows the following list on the COMAND display:
1. Current position
  2. Other state
  3. Other province
  4. Other town
-  Please select a line number or say an area name.
-  Number one.
-  Number one accepted.
-  Loading data.
-  The system displays a numbered list of available POI categories.
-  Please select a line number or say a category.
-  Number one (or e.g. Eat & Drink).
-  Number one accepted (or Eat & Drink) accepted.
-  Loading data.
-  The system displays a numbered list of available POIs of the selected category.
-  Please select a line number or say a category.
-  Number one.
-  Number one accepted.
-  Do you want to start route guidance?
-  Yes.
-  Starting route guidance.







- i** Depending on the number of categories and POI's available for a given area, the system may display several lists on each of which you may have to make a selection by speaking the desired line number or the name of a POI.

**Select POIs in your vicinity**

With following commands you can select POIs in your vicinity:

- “Next gas station”
- “Next parking lot”
- “Next Mercedes-Benz service center”
- “Next restaurant”
- “Next hospital”

**Sample dialog:**

-  Next gas station.
-  The system shows a numbered list of gas stations on the COMAND display.
-  Please select a line number.
-  Number one.
-  Number one accepted.
-  Do you want to start route guidance?
-  Yes.

The system calculates the route and, upon completing route calculation, starts route guidance.

**“Last destinations”**

Use the command “Last destinations” to select a destination from among a number of destinations last navigated to.









**“Save destination”**

Use the command “Save destination” to save the current destination in the address book.

- i** The Voice Control System may recognize names even if not saved in your voice. For best possible call-up performance, however, you should speak and save the names you intend to use yourself.
- If an entry is already available in the address book, the system will ask you if you would like to add the address to the available entry.



**Sample dialog:**

-  Save destination.
-  Please say the name.
-  John Smith.
-  Please repeat the name.
-  John Smith.
-  Where do you want to save: home or work?
-  Work.
-  The destination has been saved.

**“Find address”**

Use the command “Find address” to call up an address from memory and to start route guidance.

**“Navigate (to) <voice name>” (address book)**

Use the command “Navigate (to) <voice name>” to start route guidance by selecting voice name with a saved destination address from the COMAND address book.

A voice name may have two different destination addresses associated with it (home or work).

The system confirms your command, calculates the route, and begins route guidance. If only one address is stored, you can use the command “Navigate (to) <voice name>” to select the stored destination address for that name.





If two addresses are stored, you can use the commands

- “Navigate (to) <voice name> home”  
or
- “Navigate (to) <voice name> work”  
to directly select between home or work address for that name. The system confirms your selection, calculates the route, and begins route guidance.

**i** You can also navigate to address book entries without voice names.

Speak the command “Navigate (to)” and the first and last name in any order. This applies to other functions of address book entries also.



**Sample dialog:**

-  Navigate to John Smith.  
If more than one address exists for this voice name, the Voice Control System will prompt you:
-  Navigate to home or work?
-  Work.
-  John Smith work.  
Starting route guidance.

**“Start route guidance”**

Use the command “Start route guidance” to start route guidance after entering a valid destination.

**Sample dialog:**

-  Start route guidance.
-  Starting route guidance.  
Route guidance begins.

**“Route Information”**

You can use the “Route Information” command to get the following information on your currently planned route read out:

- Distance to destination
- Remaining driving time
- Expected arrival time

**“Guidance instructions on”**

Use the command “Guidance instructions on” to enable the system’s guidance voice output. The Voice Control System repeats the current guidance instructions.



**“Guidance instructions off”**

Use the command “Guidance instructions off” to mute the system’s guidance voice output.

### “Cancel route guidance”

Use the command “Cancel route guidance” to cancel route guidance.

#### Sample dialog:

-  Cancel route guidance.  
 Are you sure you want to cancel route guidance?  
 Yes.

Route guidance is canceled.

or

-  No.  
 Cancel.

The dialog with the Voice Control System is canceled. Route guidance remains active.

### “Map”

Use the command “Map” to activate or switch to map display.

### “Zoom in”, “Zoom out”

Use these commands to zoom in on map or to zoom out of map to the desired level of map detail.

### “Zoom in completely”, “Zoom out completely”

These commands are used to adapt the map display directly to the smallest or largest map scale.

### “Read out destination memory”

Use the command “Read out destination memory” to listen to all entries in the address book that contain an address. If applicable you can start route guidance to an entry.

#### Sample dialog:

-  Read out destination memory.  
 The system reads all address book entries that include an address. When a large number of entries is stored, the

system asks with which entry it is to start.

-  Say the name from which the list should start to read.

-  John Smith.

Starting with this name, the system reads all address book entries that include an address.

- ▶ Press button  on the multifunction steering wheel briefly when the desired entry is read. When more than one address for the entry exists, the Voice Control System will inquire.

-  Navigate to: home or work?

-  Home.

The system reads the selected voice name and starts route guidance.





### Commands for entering parts of an address

#### “Enter town”

You can use the “Enter town” command to enter any town in the state or province that is currently selected.

-  You can scroll through the list by using the “Continue” or “Back” command. Say “Correction” to enter the town or city again.

#### Sample dialog:

-  Enter town.  
 Please say the name of the town.  
 Albany.  
 Loading town list.

-  The system shows a numbered list of possible town names on the display. If there is only one entry on the list, the Voice Control System asks if it is correct.

-  Please select a line number.

-  Number one.







-  Number one accepted.

The city selected is adopted for route guidance.

### “Enter district”, “Enter center”

You can use the “Enter district” or “Enter center” command to enter an area in a city which you have selected previously.

#### Sample dialog:

-  Enter district.
-  Please say the name of the district.
-  Manhattan.
-  The system displays a list of available districts if more than one name matches the name of a district for the given city.
-  Please select a line number.
-  Number one.
-  Number one accepted.







The district selected is adopted for route guidance.

### “Enter street”

You can use the “Enter Street” command to enter the name of any street in the selected city.

- i** If only a few streets are stored for a selected town, they will be displayed for selection immediately after you give the “Enter Street” command.

#### Sample dialog:







-  Enter Street.
-  Please say the name of the street.
-  Mabel’s Street.
-  The system displays a numbered list of available street names.
-  Please select a line number.
-  Number one.
-  Number one accepted.

The street name selected is adopted for route guidance.

### “Enter intersection”, “Enter crossing”

Use the command “Enter intersection” or “Enter crossing” to enter an intersection.

#### Sample dialog:





-  Enter intersection.
-  Please say the name of the first street.
-  Forest Drive.
-  Forest Drive accepted.
-  Please say the name of the intersecting street.
-  Dudley Street.
-  Dudley Street accepted.

The intersection is adopted for route guidance.

### “Enter house number”

Use the command “Enter house number” to enter a house number for the street previously selected.

#### Sample dialog:

-  Enter house number.
-  Please say the house number.
-  Thirty-two.
-  House number accepted.

The house number is adopted for route guidance.

### “Correction”

If you have entered a city or street, you can use the “Correction” command to enter the city or street again.

## Voice Control System telephone

### Safety notes

- i** For more information on telephone, see (▷ page 148).

## Safety notes for using the Voice Control System

 Observe Safety notes, see page 237.

## Safety notes for using the telephone

 Observe Safety notes, see page 148.

### Telephone operation

You can use the Voice Control System to

- dial phone number
- store names and numbers in the COMAND address book
- dial a phone number directly from the COMAND address book
- delete the voice name of an address book entry
- have the system read out the phone book of the address book entry by entry
- manage and access an automated answering system/voice mail box<sup>36</sup>
- redial

The Voice Control System detects whether

- your telephone is switched on
- your telephone is connected via Bluetooth®
- the corresponding mobile network is logged in
- it is possible to dial

If dialing is not possible, the Voice Control System will advise you accordingly.

 You can continue operating your mobile phone using the telephone keypad or the keypad on your phone.

### Telephone commands

For a list of commands, see (▷ page 257).

## “Telephone”

Use the command “Telephone” to activate the telephone main menu. Use this command if you want the digits you are entering to appear on the COMAND display.

## “Help telephone”

The Voice Control System features a comprehensive help function.

Use the command “Help telephone” and the Voice Control System will read out an option list of available functions and commands that can be used in conjunction with the telephone (▷ page 93).

## “Dial number”

You can dial a phone number using the command “Dial number”.







The digits 0 to 9 and the word “Plus” are permitted. “Plus” replaces the international dialing code “00”.



Speak the telephone number

- as a continuous string or, with longer phone numbers,
- in digit blocks (three to five digits in each block).

After each digit block (separate the digit blocks by using an approximately 0.5 second pause), the Voice Control System repeats the recognized digits and waits until you continue speaking.

### Sample dialog:

-  Dial number.
-  Please say the number.
-  One two three four five six seven.
-  One two three four five six seven.
-  Ok.
-  Dialing.

 You can also dial the specified number if you press button  on the multifunction











<sup>36</sup> Only when supported by the mobile phone.

steering wheel instead of the concluding command “Ok”.

### “Repeat”

Using the command “Repeat” will repeat all digits spoken up to that point. Upon repeating the digits, the system will prompt you to continue your input.













#### Sample dialog:

-  Dial number.
-  Please say the number.
-  One two three.
-  One two three.
-  Repeat.
-  One two three, please continue.
-  Four five six seven.
-  Four five six seven.
-  Ok.
-  Dialing.

### “Correction”

Using the command “Correction” will correct the last entered digit block. After speaking the command, the last digit block is deleted and all previously entered digits are repeated. The system then prompts you to continue your input.











#### Sample dialog:

-  Dial number.
-  Please say the number.
-  One two three.
-  One two three.
-  Four five six seven.
-  Five five six seven.
-  Correction.
-  One two three, please continue.
-  Four five six seven.
-  Four five six seven
-  Ok.
-  Dialing.

### “Delete”

Using the command “Delete” will erase all digits entered. The system then prompts you to start your input again.

#### Sample dialog:

-  Dial number.
-  Please say the number.
-  One two three four five six seven.
-  One two three four five six seven.
-  Delete.
-  Number deleted. Please say the number again.
-  Four two seven three three nine one.
-  Four two seven three three nine one.
-  Ok.
-  Dialing.

### “Redial”

Use the command “Redial” to dial the last dialed number. تلف

### “Save name” (COMAND address book)

The command “Save name” saves a phone number with a voice name in the address book. Use this command for names that are rather difficult or when spelling and pronunciation of a name differ. After speaking the command, the Voice Control System prompts you to enter a phone number. The digits 0 to 9 and the word “Plus” are permitted. “Plus” replaces the international dialing code “00”.

-  Speak the telephone number as a continuous string.















The Voice Control System repeats the recognized digits and waits for you to continue or to confirm.

After speaking the command “Ok”, the Voice Control System prompts you two to three times to speak the name. When speaking the

name for the second time, make sure to pronounce it the same as the first time. Otherwise the name cannot be saved and the Voice Control System aborts saving.

After the command “Ok”, you will be prompted up to two times to input the name. When repeating the name, make sure that you pronounce it in the same manner as during the first input. Otherwise the name cannot be saved and the Voice Control System cancels the save procedure.



### Sample dialog:



-  Save name.
-  Please say the number.
-  One two three four five six seven.
-  One two three four five six seven.
-  Ok.
-  Do you want to add the number to an existing entry?
-  No.
-  Please say the name for the new entry.
-  Smith.
-  Please repeat the name.
-  Smith.
-  Do you want to save the number in a category?
-  No.
-  The entry Smith has been saved.

### “Call name” (COMAND address book)

The command “Call name” connects you to a phone number by selecting a name from the address book. You speak a voice name or a name entry. When the address book contains the last name only, speak the last name.

### Sample dialog:

-  Call name.
  -  Please say the name.
  -  Smith.
- If several telephone numbers exist for the same entry, the Voice Control System will ask for clarification.

-  Which number do you want to dial: Home or work?
-  Work.
-  Smith work.  
Dialing.

### “Call <entry>” (address book)

Use the command “Call <entry>” to place a phone call by directly selecting a name previously stored in your address book.

One address book entry can have different telephone numbers (mobile/car/land line/pager) for both the home and work fields.





If only one telephone number is stored for a given name, you can recall the entry using the command “Call John Smith”.

If several telephone numbers are associated with one entry, you can recall the desired telephone number by using the following commands:

- “Call John Smith home”
- “Call John Smith work”
- “Call John Smith home mobile”
- “Call John Smith home car”
- “Call John Smith home land line”
- “Call John Smith work mobile”
- “Call John Smith work car”
- “Call John Smith work land line”
- “Call John Smith work pager”

The system confirms your input and the number is dialed.







### Sample dialog:

-  Call John Smith.
- If several telephone numbers exist for the same entry, the Voice Control System will ask for clarification.
-  Which number do you want to dial: Home or work?
  -  Work.
  -  John Smith work.  
Dialing.

**“Delete name” (COMAND address book)**

The command “Delete name” deletes a voice name for an address book entry. The address data are not deleted.



**Sample dialog:**

-  Delete name.
-  Please say the name.
-  Smith.
-  Do you want to delete Smith.
-  Yes.
-  The voice name has been deleted.

**“Read out phone book”, “Read out address book” and dialing a phone number**

Use the command “Read out phone book” or “Read out address book” to listen to all entries in the phone book with a phone number stored, and select an entry and dial that number.



**Sample dialog:**

-  Read out phone book.
- The Voice Control System reads all address book entries that are stored with a phone number. When a large number of entries is stored, the system asks with which entry it is to start.
-  Please say the name from the starting point the list should be read.
-  Smith.
- Starting with this name, the system reads all address book entries including the phone number.

**▶ Selecting an entry and dialing that number:**

For the desired entry, press button  during or immediately after voice output.

If more than one phone number exists for a given entry, the Voice Control System prompts:

-  Which number do you want to dial: Home or work?
-  Home.
-  Smith home.
- Dialing.

**“Dialed calls”**

The command “Dialed calls” displays the last called phone numbers and to call one of these phone numbers.

**“Received calls”**

The command “Received calls” displays the last calls that came in.

**Managing announcement services or voice mail**

You can also use the Voice Control System to manage your voice mail or recorded announcement services.

- ▶ Press button  while a phone call is in progress.  
An acoustic signal confirms that the system is activated.
- ▶ Say the required digits (“Zero” to “Nine”).  
or
- ▶ Say the required words “Star” and “Pound”.
- ▶ Say the final command “Ok”.  
The system dials the number entered.

**Voice Control System address book****Safety notes** **Warning!**

Please devote your attention first and foremost to the traffic situation you are in.

Before your journey, please familiarize yourself with the address book functions.

Only use the Voice Control System when road and traffic conditions permit you to do so.

Otherwise you could be involved in an



accident in which you or others could be injured.

### COMAND address book overview

The address book lets you store voice names in address book entries.

You can dial a phone number from the address book or start route guidance to a stored address via the Voice Control System.

In addition to the voice names, the Voice Control System can also recognize all entries in the name fields of the address book.

Check address book entries for the following:

- Name entries such as first and last name are in the correct field.
- Do not use abbreviations or short forms, e.g. acronyms.
- Avoid unnecessary blanks within the name
- Do not use special characters.

You can improve the voice recognition by adding a voice name to an address book entry.

Use a voice name

- with names that are difficult to pronounce
- to differentiate names that sound similar
- with names that are pronounced significantly different from the way they are spelled



You can store voice names for up to 50 address book entries.

### Addressbook operation

You can use the Voice Control System to

- store a name
- select a name
- delete a name
- have the system read the address book to you

- have the system read the destination memory to you (▷ page 244)
- delete the address book
- open the address book
- open an entry in the address book
- have the system read the phone book to you (▷ page 249)

- ▶ Press button  on the multifunction steering wheel.
- ▶ Speak the command “Address book”.
- ▶ Press button  on the multifunction steering wheel.
- ▶ Speak one of the following address book commands.

### Addressbook commands

For a list of commands, see (▷ page 257).

#### “Help address book”

Use the command “Help address book” to have the system read the most important commands for the address book to you.

#### “Save name”

For information on “Save name”, see (▷ page 247).

#### “Call name”

For information on “Call name”, see (▷ page 248).

#### “Call <entry>”

For information on “Call <entry>”, see (▷ page 248).

#### “Find address”







For information on “Find address”, see (▷ page 243).

### “Delete name”

---

The command “Delete name” deletes a voice name for an address book entry. The address data are not deleted.

#### Sample dialog:

-  Delete name.
-  Please say the name.
-  Smith.
-  Do you want to delete Smith?
-  Yes.
-  The voice name has been deleted.

### “Navigate (to) <voice name>”

---

For information on “Navigate (to) <voice name>”, see (> page 243).



### “Read out address book”, “Read out phone book”

---

Use the command “Read out address book” or “Read out phone book” to have the system read all name entries and voice names in the address book to you. While the system is reading, you can select an entry by pressing button  on the multifunction steering wheel.

When the name field is empty, the phone number or the address is read. You can complete the missing data later.

#### Sample dialog:

-  Read out address book.
- The system reads all address book entries. When a large number of entries is stored, the system asks with which entry it is to start.
-  Please say the name from the starting point the list should be read.
-  Smith.
- Starting with this name, the system reads all address book entries.

► **Selecting address book entry:** Press button  on the multifunction steering wheel when the desired entry is read. When

the desired entry contains at least one phone number or one address, the Voice Control System will ask you what you would like to do. You can either dial the phone number or calculate the route to the stored address.

### “Read out destination memory”

---

For information on “Read out destination memory”, see (> page 244).

### “Delete address book”

---

Use the command “Delete address book” to delete all or individual voice names of the address book entries. Only the voice name is deleted; the remaining data in the entry are retained. When the address book entry contains a voice name only, the entire address book entry will be deleted.

### “Address book”

---







Use this command to open the address book.

### “Open entry”

---

Use the command “Open entry” you can open any address book entry.

#### Sample dialog:

-  Open entry.
-  The system displays a numbered list of entries in the COMAND display.
-  Please select a line number.
-  Number 1.
-  Number 1 accepted.
-  The system opens the first entry from the list.

When selected entry contains at least one phone number or one address, the Voice Control System will ask you what you would like to do. You can either dial the phone number or calculate the route to the stored address.

**i** The list is displayed only when the address book contains a very small number of entries. When the address book contains several entries, the Voice Control System prompts you to speak a name.

You can also use the commands “Open John Smith”, “Open Smith John”, or “Open <voice name>” to open an address book entry directly.

## Voice Control System radio

### Safety notes

#### Warning!

Please devote your attention first and foremost to the traffic situation you are in.

Before your journey, please familiarize yourself with the radio functions.

Only use the Voice Control System when road and traffic conditions permit you to do so.



Otherwise you could be involved in an accident in which you or others could be injured.

### Radio operation

You can use the Voice Control System to

- select a station
- find a station
- select a frequency (FM, AM)
- select a category (satellite radio)
- select the wave band (FM, AM or weather band)
- reading out the Presets
- switch to satellite radio
- switch to HD Radio™
- save a voice name for a station
- delete a station list (voice names only)
- delete a station (voice name only)
- select a channel number (satellite radio)

The names of all received and stored stations are available for voice recognition. To improve voice recognition, you can store a voice name for a specific speaker.

- ▶ **To select the radio or satellite radio application:** Press button  button on the multifunction steering wheel.
- ▶ Say the command “Radio” or “Satellite Radio”.
- ▶ Press button .
- ▶ Say one of the radio or satellite radio commands explained below.

### Radio commands

For a list of commands, see (▷ page 257).

You can always give the commands for the radio when you are listening to the radio, even if a different application is shown on the display.

#### “Help Radio”

Using the “Help Radio” command, the Voice Control System asks “For which radio functions do you want help?”. It then reads out a list of topics.

#### “Help Satellite Radio”

Using the “Help Satellite Radio” command, the Voice Control System asks “For which radio functions do you want help?”. It then reads out a list of topics.

#### “Help HD Radio”

Using the “Help HD Radio” command, you can have all the commands for the HD Radio™ read out.

## Selecting a wave band

You can set the wave band with the following commands:

- “FM”
- “AM”
- “Weatherband”

## “Next station”, “Previous station”

The following commands are used to start the station search and to tune in the next station:

- “Next station”
- “Previous station”

## “Next Category”, “Previous Category”

You can use the following commands to change the category on satellite radio:

- “Next Category”
- “Previous Category”

## Selecting frequency (FM range)

You can select frequencies within the FM range (87.9 to 107.9 MHz) directly. The Voice Control System also recognizes the words “Frequency”, “Point” and “Megahertz”.

### Sample dialog:

 Ninety five point five megahertz.  
The Voice Control System tunes the radio to frequency FM 95.5.

## Selecting frequency (AM range)

You can select frequencies within the AM range (530 to 1710 kHz) directly. Voice control also recognizes the words “Frequency” and “Kilohertz”.

### Sample dialog:







 Five hundred and thirty kilohertz.  
The Voice Control System tunes the radio to frequency AM 530.

## “Save station”

Using the “Save station” command you can give a voice name to the station currently selected. You can also use this command to improve voice recognition for difficult names or if you want to use a name of your own. You could, for example, save a station with the name “Favorite station<sup>37</sup>”.

When you have given the command, the Voice Control System prompts up to three times to say the station name. When repeating the station name, make sure that you pronounce it in exactly the same way as you did the first time. Otherwise, the name cannot be saved and the Voice Control System aborts the saving procedure.



### Sample dialog:

 Save station.  
 Please say the station name.  
 Favorite station<sup>37</sup>.  
 Please repeat the station name.  
 Favorite station<sup>37</sup>.  
 The station “Favorite station<sup>37</sup>” has been saved.

## “Select station”

Using the “Select station” command, you can select a saved station.

### Sample dialog:

 Select station.  
 Please say the station name.  
 Favorite station<sup>37</sup>.

The Voice Control System sets the station.

## “Favorite station<sup>37</sup>” or e.g. “WNYC”

Using this command, you can directly select a saved station.

<sup>37</sup> Example for a voice name.

**Sample dialog:**

 Favorite station<sup>37</sup>.

The Voice Control System sets the station.

**“Select Category” (satellite radio)**

Using the “Select category” command, you can select an available category.

**Sample dialog:**

 Select category.

 Please say the category name.

 News.

The Voice Control System sets the category.

**“Category News” (satellite radio)**

Use this command to select a satellite radio category.

**Sample dialog:**

 Category news.

The Voice Control System sets the category.

**“Enter Channel Number” (satellite radio)**

Use the command “Enter channel number” to select a satellite radio channel.

**“List station list” and “Selecting a Station” (FM only)**

Using the “List station list” command, you can hear the stored stations from the Presets and you can choose one of them.

 If the Voice Control System does not recognize the station name, have it read out the list of stations. This allows you to check whether you have saved the station you require in the Presets.

**Sample dialog:**

 List station list.

The Voice Control System reads out the stored stations from the Presets.

To select a station:

▶ Press button , when the system reads the desired station.

▶ **Canceling the dialog:** Press button . The dialog is concluded. The system confirms “Cancel”.

**“Delete station”**

You can use the “Delete station” command to delete a voice name for a station from the Presets.

**Sample dialog:**

 Delete station.

 Which station name do you want to delete?

 Favorite station<sup>37</sup>.

 Do you want to delete Favorite station<sup>37</sup>?

 Yes.

 Favorite station<sup>37</sup> deleted.

**“Delete station list”**

You can use the “Delete station list” command to delete all voice names or individual ones from the stations of the Presets.

**Sample dialog:**

 Delete station list.

 Do you want to delete them all?

 Yes.

 Are you sure you want to delete all voice names?

 Yes.

 All voice names have been deleted from the station list.

The system permanently deletes all voice names in the Presets.

or

 No

<sup>37</sup> Example for a voice name.

The system reads out the list of stations.

When the system reads the station to be deleted:

▶ Press button .

The station to be deleted is selected. The system reads out the selected station again.

 Do you want to delete “Favorite Station<sup>37</sup>”?

 Yes.

 Station deleted.

The system deletes the station and reads out the remaining entries in the Presets.

or

 No.

The system continues reading the Presets entry by entry.

### “HD Radio on”, “HD Radio off”

Use “HD Radio on” or “HD Radio off” to switch the HD Radio™ on or off.

### “Sirius”

Use “Sirius” to switch to SIRIUS XM Satellite Radio.

## Voice Control System CD/DVD changer/MP3

### Safety notes

#### Warning!

Please devote your attention first and foremost to the traffic situation you are in.

Before your journey, please familiarize yourself with the audio functions.

Only use the Voice Control System when road and traffic conditions permit you to do so.

Otherwise you could be involved in an accident in which you or others could be injured.

### Operation

You can use the Voice Control System to

- select a CD/DVD or another medium
- select a track
- select a folder in MP3 mode
- change the category when in media interface mode
- select a group in audio DVD mode
- select a chapter or scene when in video DVD mode

**i** Upon the command “Next/Previous CD/DVD”, the DVD changer switches from one CD/DVD to the next. It will skip empty slots. When you select an empty slot using the commands “CD/DVD 1” through “CD/DVD 6”, the current slot remains selected.

**i** The following commands “DVD audio”, “DVD video”, “Next/Previous CD/DVD” and “CD/DVD 1” to “CD/DVD 6”, cause the DVD changer to switch from one slot to another, regardless of the type of medium found in the selected slot. In your command, you can therefore replace the term “CD/DVD” with “Medium”.

### Selecting CD/DVD mode

- ▶ Press button  on the multifunction steering wheel.
- ▶ Speak one of the following commands:
  - “CD player”
  - “CD changer”
  - “DVD audio”
  - “DVD video”
  - “Hard disk”
  - “Memory card”
  - “Media interface”
  - “USB”
  - “Music Register”

<sup>37</sup> Example for a voice name.

- ▶ Press button  on the multifunction steering wheel.
- ▶ Speak one of the following commands.

## Commands

For a list of commands, see (▶ page 257).

### Help commands

Use the following commands and the Voice Control System will read out a list of available commands for the audio/video functions:

- “Help CD”
- “Help DVD audio”
- “Help DVD video”
- “Help MP3”
- “Help hard disk”
- “Help memory card”
- “Help media interface”
- “Help USB”
- “Help music register”

### “Next CD/DVD/Medium”

Use the command “Next CD”, “Next DVD” or “Next Medium” to select the next available medium in the CD/DVD changer.

### “Previous CD/DVD/Medium”

Use the command “Previous CD”, “Previous DVD” or “Previous Medium” to select the previous medium in the CD/DVD change.

### “CD/DVD/Medium 1” to “CD/DVD/Medium 6”

Use commands “CD/DVD/Medium 1” to “CD/DVD/Medium 6” to select one of up to six mediums in your CD/DVD changer.

### “Track 1” to “Track 99”

Use the commands “Track 1” to “Track 99” to select a title number from a loaded medium.

### “Next track”

Use the command “Next track” to select the next track.

### “Previous track”, “Repeat track”

Use the command “Previous track” or “Repeat track” to play again the track you are listening to. When you speak the command during the first seconds of the track, the previous track is played back.

### “Group 1” to “Group 9”

The “Group 1” to “Group 9” commands are used to select a group on the inserted audio-DVD.

### “Next group”, “Previous group”

Use the command “Next group” or “Previous group” to select a group on the inserted audio-DVD.

### “DVD audio”

Use the command “DVD audio” to start an audio DVD in the COMAND.

### “DVD video”

Use the command “DVD video” to start a video DVD in the COMAND.

### “Select scene”, “Select chapter”

Use the command “Select scene” or “Select chapter” to select a scene or chapter on the current video DVD.



### “Hard disk”, “Music Register”

Use the command “Hard disk” or “Music Register” to switch to the internal hard disk (Music Register) of the COMAND.

### “Memory card”

The “Memory card” command is used to switch from the DVD drive to the SD card.

## Voice Control System external devices

### Operation

You can use the Voice Control System to

- switch to audio AUX mode
- switch to media interface mode
- switch to the USB interface
- ▶ **Selecting application:** Press button  on the multifunction steering wheel.
- ▶ Speak one of the following commands.

### Commands

For a list of commands, see (▷ page 257).

### Help commands

Use the following commands to hear all commands for external devices:

- “Help Media Interface”
- “Help USB-Interface”

### “Audio AUX”

Use the command “Audio AUX” to switch to audio AUX mode.

### “Video AUX”

Use the command “Video AUX” to switch to video AUX mode.

### “Media Interface”

Use the command “Media Interface” to switch to the media interface in the glove box.

### “USB”

Use the command “USB” to switch to the USB interface in the glove box.

## Voice Control System command list

This section contains an overview of the most important commands for Voice Control System operation. Which commands are available for use depends on the equipment level in your vehicle.

**i** Some functions can be operated using several different commands. In the following list, these commands are grouped in one cell. When multiple similar, alternative commands are possible they are separated by a slash “/”. Choose your preferred command from those available. Possible additions to the commands are in brackets “()”. Other commands are possible. Refer to the respective help function.

### General commands

- yes
- right
- ok
- no
- cancel
- stop
- quit
- abort
- terminate
- exit

- pause

- address book

- CD-Player

- CD-Changer

- navigation

- route guidance

- navi

- nav

- destination guidance

- DVD audio

- DVD video

- radio

- sat radio

- satellite radio

- SIRIUS

- HD radio

- telephone (on)

- phone (on)

- video

- vehicle

- service

- system

- correction

- wrong

- incorrect

- help

- help functions

- help devices

- help scope of functions

- help voice control system

- help linguatronic

- general help

- 0 - 9

- Letters of the alphabet

- continue

- go forward

- next

- next page

- go on

- back

- go back

- previous page

- last page

- help Radio

- help HD radio

- help Satellite radio

- help telephone

- help address book

- help disc

- help CD player

- help CD changer

- help audio DVD

- help audio DVD player

- help audio DVD changer

- help DVD

- help DVD player

- help DVD changer

- help video DVD

- help video DVD player

- help video DVD changer

- help media
- help media player
- help media changer

- help media interface
- help UCI

- help USB interface
- help USB

- help MP3
- help MP3 player
- help MP3 changer

- help Music Register
- help hard disk

- help memory card
- help SD card

- help navigation
- help navi
- help nav
- help routing

- help route guidance
- help navigation guidance
- help destination guidance

- help map
- help map scale

- help points of interest
- help POI(s)

### Telephone commands

- all telephone functions

- telephone
- telephone on
- phone on

- make a call
- I'd like to use the phone
- I'd like to telephone
- I'd like to make a call

- save
- store

- save number
- save telephone number
- save name
- store number
- store telephone number
- store name

- dial
- dial number
- dial phone number
- dial telephone number

- confirm
- confirm number
- confirm phone number
- confirm telephone number
- repeat
- repeat number
- repeat phone number
- repeat telephone number

- read out phone book
- list phone book
- play phone book
- get phone book
- read aloud phone book

- redial
- redial last number
- redial last phone number
- last number

اراد خود رو فارما

تلفن شبانه روزی: ۰۲۱-۸۸۸۶۲۰۸۵

FarmaSOS.com

- correction
- wrong number
- wrong phone number
- wrong telephone number
- incorrect number
- incorrect phone number
- incorrect telephone number

- delete
- delete number
- delete phone number
- delete telephone number
- erase
- erase number
- erase phone number
- erase telephone number

### Navigation commands

- all navi/navigation functions
- navigation
- nav
- navi
- route guidance
- routing
- destination guidance
- navigate (to) <voice name> (work/home)
- drive (to) <voice name> (work/home)
- last destination(s)
- last address

- enter destination
- enter address
- destination entry
- destination input
- address entry
- address input
- change destination
- change address

- start/begin/continue route guidance
- start/begin/continue navigation
- start/begin/continue nav
- start/begin/continue routing
- navigation/route/destination guidance on
- cancel/exit/stop/quit/abort route guidance
- cancel/exit/stop/quit/abort navigation
- cancel/exit/stop/quit/abort nav
- cancel/exit/stop/quit/abort routing

- guidance instruction(s)
- guidance instruction(s) on
- switch guidance instruction(s) on
- switch route guidance instruction(s) on
- switch on guidance instruction(s)
- switch on route guidance instruction(s)

- guidance instructions off
- switch guidance instruction(s) off
- switch route guidance instruction(s) off
- switch off guidance instruction(s)
- switch off route guidance instruction(s)
- mute guidance instruction(s)
- mute route guidance instruction(s)

- map (on)
- show map
- switch on map
- turn on map

- zoom in
- zoom in on map
- magnify map

- zoom out
- minimize map
- zoom away from map
- make map smaller

- zoom in completely
- zoom in all the way
- zoom in to maximum size
- maximum zoom
- total magnification
- total magnify

- zoom out completely
- zoom out all the way
- zoom (out) to minimum size
- minimal zoom
- no zoom
- magnification zoom
- magnify zoom

- enter country
- enter another country
- change country

- enter (name of) state
- enter another (name of) state
- change (name of) state
- enter state name
- change state name

- enter (name of) province
- enter another (name of) province
- change (name of) province
- enter province name
- change province name

- enter zip code
- enter postal code
- enter post code

- enter (name of) town
- enter (name of) city
- enter another (name of) town
- enter another (name of) city
- change (name of) town
- change (name of) city
- town name
- city name

- enter (name of) district
- enter (name of) center
- enter another (name of) district
- enter another (name of) center
- change (name of) district
- change (name of) center
- district name
- center name

- enter (name of) street
- enter (name of) road
- enter another (name of) street
- enter another (name of) road
- change (name of) street
- change (name of) road
- street name
- road name

- enter (name of) street first
- enter (name of) road first
- street name first
- road name first

- intersection
- crossing
- enter intersection
- enter crossing

- enter (another) house number
- change house number

- point(s) of interest
- POI
- enter point(s) of interest
- enter POI(s)

- last destination(s)
- last address

- save destination
- save address
- store destination
- store address

- next/nearest/closest gas station
- next/nearest/closest gas stop
- next/nearest/closest fuel stop

- next/nearest/closest Mercedes-Benz service
- next/nearest/closest workshop
- next/nearest/closest repair shop
- next/nearest/closest MB service
- next/nearest/closest MB service point
- next/nearest/closest MB service center
- next/nearest/closest Mercedes service
- next/nearest/closest Mercedes service point
- next/nearest/closest Mercedes service center
- next/nearest/closest Mercedes-Benz service point
- next/nearest/closest Mercedes-Benz service center
- next/nearest/closest service point
- next/nearest/closest service center

- next hospital
- next medical center
- nearest hospital
- nearest medical center
- closest hospital
- closest medical center

- next/nearest/closest parking lot
- next/nearest/closest parking area

- next/nearest/closest restaurant

- current position

- destination area
- near destination

**Address book commands**

- all address book functions
- address book (on)
- address list (on)
- addresses (on)
- address directory (on)
- list/read out/read aloud/get/play address book
- list/read out/read aloud/get/play address list
- list/read out/read aloud/get/play addresses
- list/read out/read aloud/get/play address directory
- delete/clear/erase address book
- delete/clear/erase address list
- delete/clear/erase addresses
- delete/clear/erase address directory
- find/open/show/list/select/get/search (for) name
- find/open/show/list/select/get/search (for) entry
- find/open/show/list/select/get/search (for) <voice name>
- find/open/show/list/select/get/search (for) page
- find/open/show/list/select/get/search (for) item
- dial/phone/call name
- dial/phone/call <voice name>
- search for number
- find number
- delete name
- erase name
- delete <voice name>
- erase <voice name>
- list/read out/read aloud/play/get/recall destination memory
- list/read out/read aloud/play/get/recall navigation memory
- <voice name>
- <voice name> car
- <voice name> land line
- <voice name> mobile
- <voice name> home
- <voice name> pager
- <voice name> work car
- <voice name> work land line
- <voice name> work mobile
- <voice name> work pager
- call <voice name>
- call <voice name> work
- call <voice name> home
- call <voice name> land line
- call <voice name> car
- call <voice name> work car
- call <voice name> work land line
- call <voice name> work mobile
- call <voice name> work pager
- call <voice name> home car



- call <voice name> home land line
- call <voice name> home mobile
- call <voice name> home pager
- work
- office
- business
- company
- car
- car phone/telephone
- land line
- land line phone/telephone
- mobile
- cell phone/telephone
- mobile phone/telephone
- cellular phone/telephone
- pager
- work car
- work land line
- work mobile
- work pager
- home
- home car
- home land line
- home mobile
- home pager
- navigate to <voice name>
- drive to <voice name>
- navigate to <voice name> work
- navigate to <voice name> home

- dial name
- dial voice name
- save name
- save <voice name>
- save number
- save telephone number
- store <voice name>
- store number
- store telephone number
- accept
- accept number
- accept telephone number
- accept name
- ok
- finished
- <1> - <8>
- use <1> - <8>
- number <1> - <8>
- line <1> - <8>

### Audio/video commands

- audio
- video

### Radio

- all radio functions
- radio (on)
- AM
- AM radio (on)
- FM
- FM radio (on)

- weatherband radio (on)
- (find) next station
- (find) next channel
- (find) following station
- (find) following channel
- station search ascending/going up
- channel search ascending/going up
- other/another/find station
- other/another/find channel
- radio seek

- channel/station 1-x
- channel/station <voice name>

- delete/clear/erase station (name)
- delete/clear/erase channel (name)

- save/store station
- save/store channel

- select/choose station
- select/choose channel

- read out/read aloud/list/play/get/recall station list
- read out/read aloud/list/play/get/recall channel list

- delete/clear/erase station list
- delete/clear/erase channel list

- previous/preceding/last/prior station
- previous/preceding/last/prior channel
- station/channel search coming down

- radio info (off/on)

Example: 95.5 FM

- ninety-five five
- ninety-five five megahertz
- ninety-five point five
- ninety-five point five megahertz
- frequency ninety-five five
- frequency ninety-five point five
- frequency ninety-five five megahertz
- frequency ninety-five point five megahertz

Example: 540 AM

- five-hundred-forty
- five-hundred-forty kilohertz
- frequency five-hundred-forty
- frequency five-hundred-forty kilohertz

### HD Radio™

- HD radio
- turn on/switch on HD radio
- turn/switch HD radio on
- HD radio off
- turn off/switch off HD radio
- turn/switch HD radio off
- HD radio info

### Satellite radio

- sirius (on)
- sat radio (on)
- satellite radio (on)
- (enter) station number
- (enter) channel number
- next/other/another/following category

- list/read out/read aloud/play/get/recall category list
- previous/last category
- select/choose category
- all categories
- category <voice name>
- satellite radio info

### CD/DVD/MP3

- CD (on)
- CD player (on)
- CD changer (on)
- DVDA/ADVD/audio DVD/DVD audio player (on)
- DVDA/ADVD/audio DVD/DVD audio changer (on)
- video DVD/DVDV/VDVD/movie DVD/DVD movie/DVD video player
- video DVD/DVDV/VDVD/movie DVD/DVD movie/DVD video changer
- MP3 player/changer (on)
- next/other/another/following CD
- next/other/another/following disc
- next/other/another/following medium
- next/other/another/following DVD (audio/video)
- next/other/another/following MP3 CD
- next/other/another/following MP3 DVD

- previous/last/preceding/prior CD
- previous/last/preceding/prior disc
- previous/last/preceding/prior medium
- previous/last/preceding/prior DVD (audio/video)
- previous/last/preceding/prior MP3 CD
- previous/last/preceding/prior MP3 DVD
- next/other/another/following track
- next/other/another/following song
- next/other/another/following MP3
- (repeat/replay) previous/preceding/last/prior track
- (repeat/replay) previous/preceding/last/prior song
- (repeat/replay) previous/preceding/last/prior MP3
- track/MP3/song 1-99
- select track/MP3/song 1-99
- track/MP3/song number 1-99
- disc (number) 1-6
- CD (number) 1-6
- (audio/video) DVD (number) 1-6
- medium (number) 1-6
- group (number) 1-9
- select group (number) 1-9
- next/other/another/following group
- previous/preceding/last/prior group
- next/other/another/following directory
- next/other/another/following folder
- change audio/music source
- change video source
- select scene/chapter

- next/other/another/following chapter
- next/other/another/following scene
- chapter/scene up
- previous/preceding/last/prior scene
- previous/preceding/last/prior chapter
- chapter/scene down
- next/other/another/following title
- title up
- previous/preceding/last/prior title
- title down
- (select) scene/chapter 1-99
- (select) scene/chapter number 1-99
- (select) track/title/movie/film 1-99
- (select) track/title/movie/film number 1-99

### Memory card

- memory card (on)
- SD card (on)

### Hard disk, Music Register

- hard disk (on)
- music register (on)

### Media interface

- media interface (on)
- UCI (on)

### USB interface

- USB
- USB interface

### Aux

- audio auxiliary/aux (input)
- auxiliary/aux audio (input)
- video auxiliary/aux (input)
- auxiliary/aux video (input)

## Voice Control System troubleshooting

### Help function

To support the user, the Voice Control System contains an extensive help function.

The help function gives you

- general hints on how to best use the Voice Control System
- a listing of all available commands

### Help commands

#### “Help voice control”

Using the command “Help voice control” will give you information on how to best use the Voice Control System.

#### “Help”

- ▶ Press button  on the multifunction steering wheel and speak the command “Help”.

You will receive help for the currently selected application.

When you speak the command “Help” during a dialog such as after the command “Dial number”, you will receive help for the next dialog steps.

You can also call up the help function specifically for a particular system, for example using the command “Help telephone”.

### Help window

You can use the help window to view a selection of valid commands on the COMAND display.

The help functions can be switched on or off via COMAND in the System menu (▷ page 93).

### Entering digits and spelling

#### Entering digits

- Digits from “Zero” to “Nine” may be used.
- Speaking phone numbers in digit blocks of 3 to 5 digits has proven a very reliable method for the input of phone numbers.

#### Spelling

- The letters of the English alphabet and the digits 0 - 9 may be used.
- Speak the letters in blocks of 5 - 7 letters at a time.
- Speak each individual letter clearly.

### What to do if ...

Problem	Possible cause/consequence	Suggested solution
The Voice Control System does not recognize commands.	You have not operated the system from the driver's seat.	▶ Operate the Voice Control System only by the driver as the microphone is geared to the driver side.
	You have spoken unclearly, too loudly or too quietly.	▶ Speak the commands in a continuous manner using a normal tone.
	The blower could be set to the highest setting, vents could be pointing at microphones or wind noise could be created due to open windows.	▶ Avoid loud disturbances.

امداد خودرو فارما

شماره تماس: ۰۸۵۰۸۸۶۲۰۸۵

FarmaSOS.com

Problem	Possible cause/consequence	Suggested solution
An address book entry without voice name is not recognized.	The address book fields for first and last name are completed. However, you only spoke the last name or the first name.	<ul style="list-style-type: none"> <li>▶ Say both the first name and the last name of the address book entry.</li> </ul>
	Pronunciation of names in the address book does not differ sufficiently or the spelling differs from the pronunciation.	<ul style="list-style-type: none"> <li>▶ Make sure the address book entries are reasonable. Check the address book entries for the following:               <ul style="list-style-type: none"> <li>• Name entries such as first and last name are in the correct field.</li> <li>• Do not use abbreviations or short forms, e.g. acronyms.</li> <li>• Avoid unnecessary blanks within the name</li> <li>• Do not use special characters.</li> </ul> </li> <li>or</li> <li>▶ Create a voice name (▷ page 247).</li> <li>or</li> <li>▶ Speak the command “Read out address book”. The Voice Control System reads the address book aloud.</li> <li>▶ Press button  on the multifunction steering wheel when the desired name is read.</li> </ul>
An address book entry with voice name is not recognized.	The voice names do not differ from each other sufficiently.	<ul style="list-style-type: none"> <li>▶ Make voice names that differ as much as possible. For example, make the names Wight and Wright unique by entering them as “Mr Wight office” and “Mr Wright John”.</li> <li>or</li> <li>▶ Speak the command “Read out address book”. The Voice Control System reads the address book aloud.</li> <li>▶ Press button  on the multifunction steering wheel when the desired name is read.</li> </ul>

Problem	Possible cause/consequence	Suggested solution
<p>A station list entry is not recognized.</p>	<p>The voice names of the station names do not differ from each other sufficiently.</p>	<ul style="list-style-type: none"> <li>▶ Create a voice name for the station (&gt; page 253).</li> <li>or</li> <li>▶ Speak the command “Read out station list”. The Voice Control System reads the station list aloud.</li> <li>▶ Press button  on the multifunction steering wheel when the desired station name is read. The station is selected (&gt; page 254).</li> </ul>
<p>The Voice Control System prompts you to repeat a voice name repeatedly when saving.</p>	<p>The way you have spoken the voice name is different.</p>	<ul style="list-style-type: none"> <li>▶ Pronounce the voice name in the same way during the entire process.</li> </ul>
<p>You want to enter a city, street or city center but you have to spell the entry.</p>	<p>Entering part of an address has failed after several attempts, e.g. due to background noise, or you have tried to enter an address in Puerto Rico (&gt; page 241).</p>	<ul style="list-style-type: none"> <li>▶ Spell the entry.</li> </ul>
<p>You have entered a phone number as a string but the Voice Control System does not understand you.</p>		<ul style="list-style-type: none"> <li>▶ Speak the phone number in groups of digits, e.g. three to five digits each.</li> </ul>



## Voice Control System individualization

- i** The individualization can only be performed when the vehicle is stationary. If you drive off, the individualization will be canceled.

After starting the session, the system will guide you through the individualization by means of acoustic instructions.

The individualization is used to adapt the Voice Control System to your own voice and to therefore improve speech recognition. This does not affect the speech recognition of other users.

Individualization consists of two stages:

- Digits
- Commands

You can activate individualization in the COMAND system settings (▷ page 93). A dialog and screen displays will guide you through the individualization process.

The system can be reset to the factory settings at any time.

- i** You may wish to complete only a portion of the individualization process.

Completing the digits portion alone may result in an improved recognition rate.

Individualization can be exited at any time. The data trained, however, will only be retained if a given individualization portion is completed and the data is stored when prompted to do so by the system.

# امداد خودرو فارما

تلفن شبانه روزی: ۰۲۱-۸۸۸۶۲۰۸۵

**FarmaSOS.com**

Vehicle equipment .....	274
Locking and unlocking .....	274
Starter switch positions .....	284
Seats .....	286
Multifunction steering wheel .....	293
Mirrors .....	294
Memory function .....	297
Lighting .....	298
Wipers .....	305
Power windows .....	307
Driving and parking .....	311
Automatic transmission .....	317
Transfer case .....	325
Instrument cluster .....	326
Driving systems .....	327
Climate control system .....	363
Rear window defroster .....	372
Power tilt/sliding sunroof .....	373
Panorama roof with power tilt/ sliding panel .....	375
Loading and storing .....	379
Useful features .....	384

لرمان خودرو فارما

تلفن: ۰۲۱-۸۸۸۶۲۰۸۸

FarmaSOS.com



## Vehicle equipment

**i** This Operator's Manual describes all features, standard or optional, potentially available for your vehicle at the time of purchase. Please be aware that your vehicle might not be equipped with all features described in this manual.

- ▶ Use the mechanical key to lock the vehicle (▷ page 500).
- ▶ Have the vehicle battery and the vehicle battery connections checked at an authorized Mercedes-Benz Center.

If the SmartKey is malfunctioning, contact Roadside Assistance or an authorized Mercedes-Benz Center.

## Locking and unlocking

### Notes

**⚠ Observe Safety notes, see page 56.**

When unlocking or locking the vehicle with the SmartKey an acoustic signal sounds. The acoustic signal is activated at the factory. If you wish to deactivate the feature, or adjust its signal volume, contact an authorized Mercedes-Benz Center.

When unlocking the vehicle, all turn signal lamps flash once. An acoustic signal sounds once, and the locking knobs in the doors move up. The anti-theft alarm system is disarmed.

When locking the vehicle, all turn signal lamps flash three times. An acoustic signal sounds three times, and the locking knobs in the doors move down. The anti-theft alarm system is armed.

All doors and the trunk must be closed.

If you cannot lock or unlock the vehicle with the SmartKey, the batteries in the SmartKey are discharged, the SmartKey is malfunctioning, or the vehicle battery is drained.

- ▶ Check the batteries in the SmartKey (▷ page 277) and replace them if necessary.
- ▶ Use the mechanical key to unlock the driver's door and the trunk (▷ page 499).

## SmartKey



Your vehicle comes supplied with two SmartKeys, each with remote control and a removable mechanical key.

The SmartKey centrally locks and unlocks

- the doors
- the trunk lid
- the fuel filler flap



Example illustration: SmartKey with KEYLESS-GO

- ①  Lock button
- ②  Unlock button for trunk lid
- ③  Unlock button

**i** USA only:

This device complies with Part 15 of the FCC Rules. Operation is subject to the following two conditions:

1. This device may not cause harmful interference, and
2. this device must accept any interference received, including

interference that may cause undesired operation.

Any unauthorized modification to this device could void the user's authority to operate the equipment.

**i** Canada only:

This device complies with RSS-210 of Industry Canada. Operation is subject to the following two conditions:

1. This device may not cause interference, and
2. this device must accept any interference received, including interference that may cause undesired operation of the device.

Any unauthorized modification to this device could void the user's authority to operate the equipment.

### Factory setting

► **Global unlocking:** Press button .



Unless you open a door or the trunk within approximately 40 seconds after unlocking the vehicle:

- The vehicle will be locked again.
- The anti-theft alarm system will be rearmed.

► **Global locking:** Press button .

### Selective setting

If you frequently travel alone, you may wish to reprogramm the SmartKey. Pressing button  will then only unlock the driver's door and the fuel filler flap.

► **Switching on/off:** Press and hold buttons  and  simultaneously for approximately 6 seconds until the battery check lamp (▷ page 277) flashes twice.

The SmartKey will then function as follows:

► **Unlocking driver's door and fuel filler flap:** Press button  once.

► **Global unlocking:** Press button  twice.

► **Global locking:** Press button .

### KEYLESS-GO

Vehicles equipped with KEYLESS-GO come with two SmartKeys with KEYLESS-GO, each with remote control and a removable mechanical key.

The KEYLESS-GO function is integrated into the SmartKey. The validity of the SmartKey is checked every time you grasp an outside door handle.

When the SmartKey is valid, your vehicle unlocks

- the doors
- the trunk lid
- the fuel filler flap

**i** USA only: تلفن

This device complies with Part 15 of the FCC Rules. Operation is subject to the following two conditions:

1. This device may not cause harmful interference, and
2. this device must accept any interference received, including interference that may cause undesired operation.

Any unauthorized modification to this device could void the user's authority to operate the equipment.

**i** Canada only:

This device complies with RSS-210 of Industry Canada. Operation is subject to the following two conditions:

1. This device may not cause interference, and
2. this device must accept any interference received, including interference that may cause undesired operation of the device.

Any unauthorized modification to this device could void the user's authority to operate the equipment.

### Important notes on using KEYLESS-GO

- You can also use the SmartKey with KEYLESS-GO like a normal SmartKey (▷ page 274).
- You can combine KEYLESS-GO functions with normal SmartKey functions (e.g. unlocking with KEYLESS-GO and locking with button ).
- Always carry the SmartKey with you.
- Never store the SmartKey together with
  - electronic items such as a mobile phone or another SmartKey
  - metallic objects such as coins or metal foil

Doing so could impair the function of the KEYLESS-GO system.

- To lock or unlock the vehicle, the SmartKey must be located outside the vehicle within approximately 3 ft (1 m) of a door or the trunk.
- When the vehicle has been parked for more than 72 hours, the KEYLESS-GO function is deactivated. Pull an outside door handle and switch on the ignition once to activate the KEYLESS-GO function.
- If the SmartKey is positioned farther away from the vehicle, the system may no longer recognize the SmartKey. The vehicle

cannot be locked or the engine started via the KEYLESS-GO system.

- If the SmartKey is removed from the vehicle (e.g. if a passenger exits the vehicle with the SmartKey)
  - when pressing the KEYLESS-GO start/stop button or trying to lock the vehicle with the outside door handle the message **Key Not Detected** appears in the multifunction display
  - with the engine running, the red message **Key Not Detected** appears in the multifunction display while driving off

Find the SmartKey or change its present location immediately (e.g. place it on the front passenger seat or insert it in shirt pocket).

- If you have started the engine with the KEYLESS-GO start/stop button, you can turn it off again by
  - pressing the KEYLESS-GO start/stop button
  - inserting the SmartKey into the starter switch when the vehicle is at a standstill and the automatic transmission is in park position **P**
- The vehicle could be inadvertently unlocked if the SmartKey is within 3 ft (1 m) of the vehicle and
  - an outside door handle is splashed with water
  - or
  - you attempt to clean an outside door handle
- Remember that the engine can be started by anyone with a SmartKey that is left inside the vehicle.

**Possibility 1** (One SmartKey in the vehicle, one SmartKey outside the vehicle):

If you leave the SmartKey behind when exiting and locking the vehicle, no message appears in the multifunction display.

**Possibility 2** (One SmartKey in the vehicle, no SmartKey outside the vehicle):

When exiting and trying to lock the vehicle, the message Key Detected In Vehicle appears in the multifunction display. The vehicle will not be locked.

### Factory setting

► **Global unlocking:** Pull an outside door handle.

Unless you open a door or the trunk within approximately 40 seconds after unlocking the vehicle:

- The vehicle will be locked again.
- The anti-theft alarm system will be rearmed.

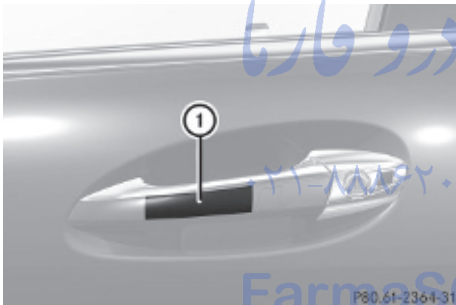

► **Global locking:** Touch outside of a door handle ①.

### Selective setting

If you frequently travel alone, you may wish to reprogram the SmartKey. Pulling the driver's outside door handle will then only unlock the driver's door and the fuel filler flap.

► **Switching on/off:** Press and hold buttons and simultaneously for approximately 6 seconds until the battery check lamp (> page 277) flashes twice.

KEYLESS-GO will then function as follows:

► **Unlocking driver's door and fuel filler flap:** Pull the driver's outside door handle.

► **Global unlocking:** Pull any outside door handle other than the driver's outside door handle.

► **Global locking:** Touch outside of a door handle ①.

### Checking SmartKey batteries



Example illustration: SmartKey with KEYLESS-GO

► Press button or on the SmartKey.

Battery check lamp ① comes on briefly to indicate that the SmartKey batteries are in order.

If the battery check lamp does not come on briefly during check, the SmartKey batteries are discharged.

► Replace the batteries (> page 502).

**i** You can obtain the required batteries at any authorized Mercedes-Benz Center.

**i** If the batteries are checked within signal range of the vehicle, pressing button or will lock or unlock the vehicle accordingly.

### Loss of the SmartKey

If you lose your SmartKey or mechanical key, you should do the following:



- ▶ Have the SmartKey deactivated by an authorized Mercedes-Benz Center.
- ▶ Report the loss of the SmartKey or the mechanical key to your car insurance company immediately.
- ▶ Have the mechanical lock replaced if necessary.

Any authorized Mercedes-Benz Center will be glad to supply you with a replacement. For information on replacing the SmartKey, see “Replacing the SmartKey” (▷ page 278).

### Replacing the SmartKey

Only you, or someone authorized by you can order a replacement key from any Mercedes-Benz Center. In order to do so, the Mercedes-Benz Center will require proof of identity and vehicle ownership with original documents, including the following:

#### If you are the current owner of the vehicle:

- the vehicle’s current state registration
- a current identity card, passport, or drivers license

#### If you are an authorized person:

- the vehicle’s current state registration
- a current identity card, passport, or drivers license for the authorized individual
- signed and dated authorization from the owner of the vehicle for which the key is being requested

**i** Duplicated or photocopied documentation will not be accepted.

### Activating the key

Once you, or an authorized person, has provided the appropriate documents, the Mercedes-Benz Center will need to synchronize the key to your vehicle before it can be used. In order to do so, the Mercedes-Benz Center need access to your vehicle.

### Opening the doors from the inside

You can open a door from the inside even when it is locked unless it is secured with the child safety lock (▷ page 61).

Open door only when conditions are safe to do so.



Example illustration driver’s door

If the vehicle has previously been locked with the SmartKey or with KEYLESS-GO, opening a door from the inside will trigger the anti-theft alarm system.

To cancel the alarm, see (▷ page 73).

- ▶ **Front doors:** Pull on inside door handle ② on the respective front door. If the door was locked, locking knob ① will move up.
- ▶ **Rear doors:** Pull up locking knob on the respective rear door to unlock door.
- ▶ Pull on the inside door handle on the respective rear door.

### Automatic central locking

You can switch the automatic central locking on or off using the COMAND system (▷ page 210).

The doors and the trunk lock automatically when the vehicle is set into motion.

You can open a locked front door from the inside. Open door only when conditions are safe to do so.

The doors are designed to unlock automatically after an accident if the force of the impact exceeds a preset threshold.

The vehicle locks automatically when the ignition is switched on and the wheels are turning at a vehicle speed of above 9 mph (15 km/h). You could therefore lock yourself out when the vehicle is pushed or towed or is on a test stand.

### Locking and unlocking from the inside

 **Observe Safety notes, see page 56.**

You can lock or unlock the vehicle from the inside using the central locking or unlocking switch. This can be useful, for example, if you want to lock the vehicle before starting to drive.

The central locking or unlocking switch does not lock or unlock the fuel filler flap or the interior storage compartments, such as the glove box.

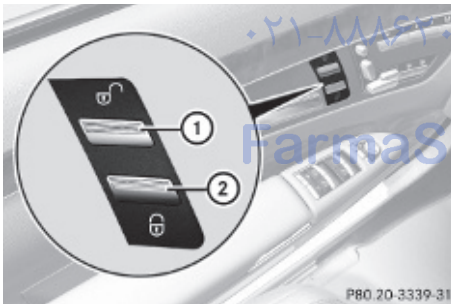

- ▶ **Locking:** Press central locking switch ②. When the front passenger door is closed, the vehicle locks.
- ▶ **Unlocking:** Press central unlocking switch ①.

You can open a locked front door from the inside. Open door only when conditions are safe to do so.

If the vehicle was previously locked with the central locking switch

- and the SmartKey is set to factory settings, the complete vehicle is unlocked when a front door is opened from the inside
- and the SmartKey is set to selective settings, only the front door opened from the inside is unlocked

If the vehicle has been locked centrally with the SmartKey or with KEYLESS-GO, it will not unlock using the central unlocking switch.

### Opening the trunk

 **Warning!**

Make sure the trunk is closed when the engine is running and while driving. Among other dangers, deadly carbon monoxide (CO) gases may enter vehicle interior resulting in unconsciousness and death.

 When you open the trunk, the trunk lid swings open upwards. Always make sure there is sufficient overhead clearance.

You can open the trunk when the vehicle is stationary.

A minimum height clearance of 5.9 ft (1.80 m) is required to open the trunk lid.

### Opening the trunk from the outside

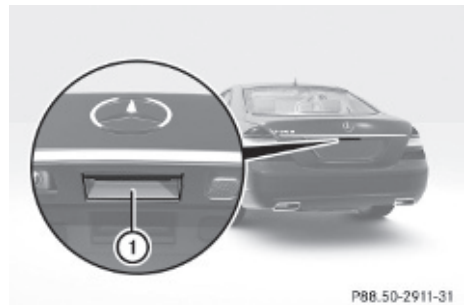

P88.50-2911-31

- ▶ Press and hold button  (▷ page 274) on the SmartKey until the trunk unlocks and begins to open.

or

- ▶ Pull on handle ①.

In vehicles without KEYLESS-GO: The vehicle must be unlocked.

If the trunk does not open, it is still locked separately (▷ page 283).

Vehicles with trunk opening/closing system:

- ▶ **Stopping the opening procedure:** Press button  on the SmartKey.

### Opening the trunk from the inside

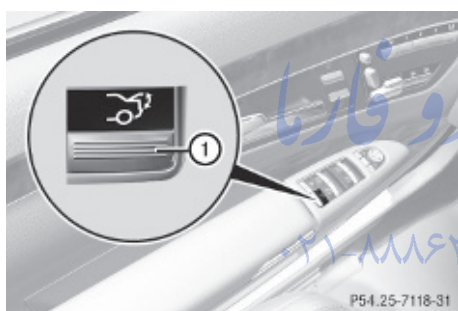

Example illustration: Vehicles with trunk opening/closing system

- ▶ Press remote trunk opening switch ① until the trunk begins to open.

If the trunk does not open, it is still locked separately (▷ page 283).

Vehicles with trunk opening/closing system:

- ▶ **To interrupt the opening procedure:** Press remote trunk opening switch ①.

### Trunk opening-height restriction

Vehicles with trunk opening/closing system:

The trunk lid opening height can be limited when transporting goods on a roof rack (e.g. presence of an optional MB sport luggage container). When the trunk opening-height is switched on, the trunk opens to approximately the height of the roof edge.

- ▶ **Switching on/off:** Use the COMAND system (▷ page 210).

### Closing the trunk

#### **Warning!**

Make sure the trunk is closed when the engine is running and while driving. Among other dangers, deadly carbon monoxide (CO) gases may enter vehicle interior resulting in unconsciousness and death.

#### **Warning!**

To prevent possible personal injury, always keep hands and fingers away from the trunk opening when closing the trunk lid. Be especially careful when small children are around.

#### **Observe Safety notes, see page 56.**

Do not leave the SmartKey in the open trunk. You may lock yourself out.

If the vehicle was previously locked centrally with the SmartKey or KEYLESS-GO, the trunk lid will lock automatically when closed. All turn signal lamps flash three times to confirm locking.

### Closing the trunk from the outside manually



- ▶ Lower trunk lid by pulling firmly on handles ①.
- ▶ Close trunk with hands placed flat on trunk lid.

The power closing assist automatically ensures that the trunk lid is pulled completely close (▷ page 283).

### Closing the trunk from the inside automatically

#### Warning!

Maintain sight of the area around the rear of the vehicle while operating the trunk lid with the door mounted switch. Monitor the closing procedure carefully to make sure no one is in danger of being injured.

To interrupt the closing procedure, release the door mounted remote trunk opening/closing switch again.

Even with the SmartKey removed from the starter switch or the SmartKey with KEYLESS-GO removed from the vehicle, the remote trunk opening/closing switch can be operated. Therefore, do not leave children unattended in the vehicle, or with access to an unlocked vehicle. A child's unsupervised access to a vehicle could result in an accident and/or serious personal injury.

In vehicles with trunk opening/closing system you can close the trunk from the inside using the remote trunk opening/closing switch.

If the trunk lid comes into contact with an object while closing, the closing procedure is stopped and the trunk lid reopens slightly. This will happen only while the trunk is in its upper motion sequence. Check if luggage has been piled too high, for example.

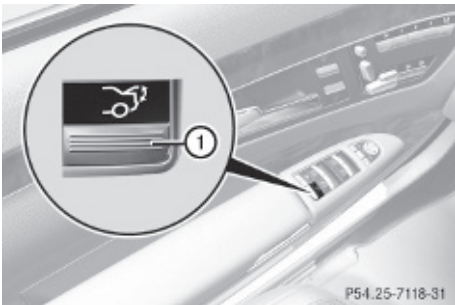

- ▶ Press and hold remote trunk opening/closing switch ① until the trunk is closed.
- ▶ **To interrupt the closing procedure:**  
Release remote trunk opening/closing switch ①.

### Closing the trunk from the outside automatically

#### Warning!

Monitor the closing procedure carefully to make sure no one is in danger of being injured. To prevent possible personal injury, always keep hands and fingers away from the trunk opening when closing the trunk lid. Be especially careful when small children are around. To stop the closing procedure, do one of the following:

- Press button  on the SmartKey.
- Press the remote trunk opening/closing switch (on the driver's door).
- Press the trunk closing switch.
- Press the KEYLESS-GO locking/closing switch.
- Pull the trunk lid handle.

Even with the SmartKey removed from the starter switch or the SmartKey with KEYLESS-GO removed from the vehicle, the remote trunk opening/closing switch can be operated. Therefore, do not leave children unattended in the vehicle, or with access to an unlocked vehicle. A child's unsupervised access to a vehicle could result in an accident and/or serious personal injury.

In vehicles with trunk opening/closing system you can close the trunk separately from the outside using the trunk closing switch.



P88.50.2888.31

Vehicles without KEYLESS-GO

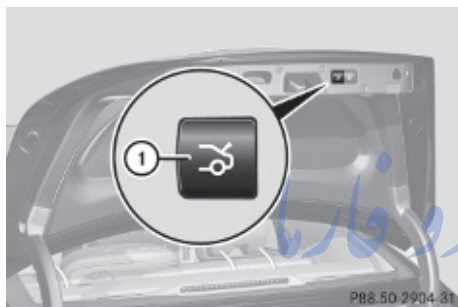

P88.50.2904.31

Vehicles with KEYLESS-GO

- ▶ Press trunk closing switch ① briefly.

If the trunk lid comes into contact with an object while closing, the closing procedure is stopped and the trunk lid reopens slightly. This will happen only while the trunk is in its upper motion sequence. Check if luggage has been piled too high, for example.

### Closing the trunk and locking vehicle from outside

In vehicles with trunk opening/closing system and KEYLESS-GO, you can close the trunk and lock the vehicle simultaneously from the outside using the KEYLESS-GO locking/closing switch.

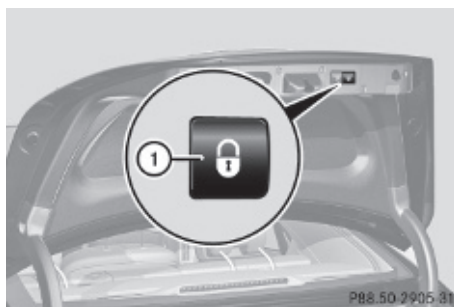

P88.50.2905.31

- ▶ Make sure you have the SmartKey with KEYLESS-GO with you.
- ▶ Press KEYLESS-GO locking/closing switch ① briefly.

With all doors closed:

- The locking knobs in the doors move down.
- The trunk lid starts to close automatically.
- All turn signal lamps flash three times to confirm locking once the trunk has closed completely.
- An acoustic signal sounds three times.
- The anti-theft alarm system is armed.

If the trunk lid comes into contact with an object while closing, the closing procedure is stopped and the trunk lid reopens slightly. This will happen only while the trunk is in its upper motion sequence. Check if luggage has been piled too high, for example.

### Trunk lid emergency release

The trunk lid can be opened from inside the trunk with the emergency release button.

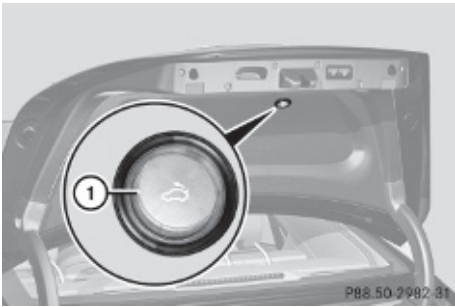

- ▶ Briefly press emergency release button ①.

The emergency release button unlocks and opens the trunk while the vehicle is standing still or in motion.

Illumination of the emergency release button:

- The button flashes for 30 minutes after opening the trunk.
- The button flashes for 60 minutes after closing the trunk.

The emergency release button does not open the trunk, if the vehicle battery is discharged or disconnected.

### Valet locking

You can lock the trunk separately with the mechanical key. This denies unauthorized access to the trunk, e.g. when you valet park the vehicle.

- ▶ Leave only the SmartKey less its mechanical key with the vehicle.

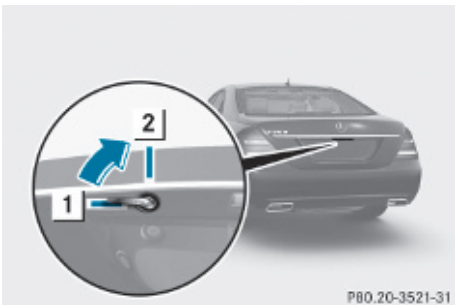

- ▶ **Valet locking:** Close the trunk.
- ▶ Remove the mechanical key from the SmartKey (▷ page 499).
- ▶ Insert the mechanical key in the trunk lid lock.
- ▶ Turn the mechanical key clockwise to position ② and remove the mechanical key in that position to lock the trunk.

The trunk remains locked even when the vehicle is centrally unlocked.

You can then only open the trunk with the mechanical key.

- ▶ **Cancelling:** Insert the mechanical key in the trunk lid lock.
- ▶ Turn the mechanical key counterclockwise to neutral position ① and remove the mechanical key in that position to unlock the trunk.  
You can now open the trunk.

### Power closing assist for doors and trunk lid

It is not necessary to slam the door or trunk lid closed. An electrical power-assisted mechanism draws doors and trunk lid closed quietly and automatically once door and trunk lid has been latched. When the electrical power-assisted mechanism has stopped, doors and/or trunk can be reopened.

#### ⚠ Warning!

To prevent possible personal injury, always keep hands and fingers away from the door or trunk opening when closing a door or the trunk lid. Be especially careful when small children are around.

In case of danger, pull the inside or outside door handle, or pull the trunk lid handle.

To prevent personal injury, never actuate the closing assist mechanism by tampering with the door or trunk lid latch.



**⚠ Warning!**

Only drive with the doors closed. Otherwise, one or more of the doors could open while the vehicle is in motion, putting you and/or others at risk.

**⚠ Warning!**

Make sure the trunk is closed when the engine is running and while driving. Among other dangers, deadly carbon monoxide (CO) gases may enter vehicle interior resulting in unconsciousness and death.

- ▶ **Power closing assist for doors:** Press the doors gently past the initial engage position into the lock.
- ▶ **Power closing assist for trunk lid:** Press the trunk lid gently into its lock.

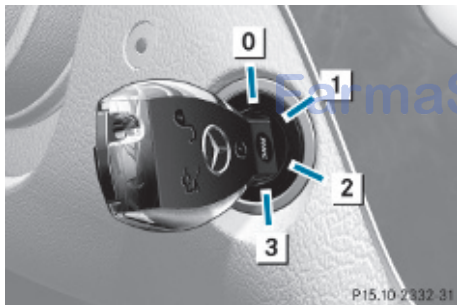
**Starter switch positions****SmartKey****⚠ Observe Safety notes, see page 56.**

Starter switch

- 0 For removing SmartKey
- 1 Power supply for some electrical consumers, e.g. wipers
- 2 Ignition (power supply for all electrical consumers) and driving position
- 3 Starting position

When you switch on the ignition, all lamps in the instrument cluster come on. The high-beam headlamp indicator lamp and turn signal indicator lamps will only come on if

activated. If a lamp in the instrument cluster fails to come on when the ignition is switched on, have it checked and replaced if necessary. If a lamp in the instrument cluster remains on after starting the engine or comes on while driving, refer to “Lamps in instrument cluster” (▷ page 489).

- ▶ Always remove the SmartKey from the starter switch when the engine is not in operation. This will help to prevent accelerated vehicle battery discharge or a completely discharged vehicle battery.

If the SmartKey cannot be turned in the starter switch, the vehicle battery may not be sufficiently charged.

- ▶ Check the vehicle battery and charge it if necessary (▷ page 514).

or

- ▶ Get a jump start (▷ page 514).

- ❗ If the SmartKey does not belong to the vehicle, the SmartKey can be turned in the starter switch. However, the ignition does not switch on and the engine does not start.

**KEYLESS-GO****⚠ Observe Safety notes, see page 56.**

Vehicles equipped with the KEYLESS-GO feature are supplied with a SmartKey with integrated KEYLESS-GO function and a removable KEYLESS-GO start/stop button.

The KEYLESS-GO start/stop button must be inserted in the starter switch and the SmartKey present in the vehicle.

Pressing the KEYLESS-GO start/stop button without depressing the brake pedal corresponds to the various starter switch positions (▷ page 284).

Pressing the KEYLESS-GO start/stop button with the brake pedal firmly depressed will start the engine (▷ page 311).

The KEYLESS-GO start/stop button can be pulled out of the starter switch easily. You can



then insert the SmartKey into the starter switch.

- i** The KEYLESS-GO start/stop button does not need to be removed from the starter switch when you leave the vehicle. However, always take the SmartKey with you when you leave the vehicle. As long as the SmartKey is in the vehicle, the vehicle's electrical systems can be switched on or the engine can be started using the KEYLESS-GO start/stop button.

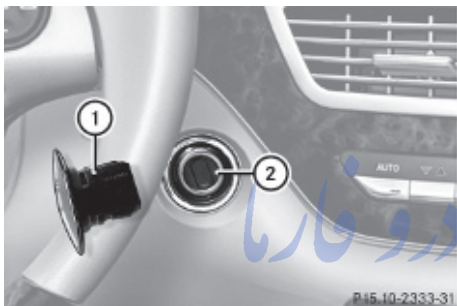

- ① KEYLESS-GO start/stop button
- ② Starter switch

- ▶ Insert the KEYLESS-GO start/stop button into the starter switch (if not inserted already).
- i** Allow for 2 seconds until the system has detected the KEYLESS-GO start/stop button.
- ▶ Make sure the automatic transmission is in park position **P**.
- ▶ Do not depress the brake pedal.

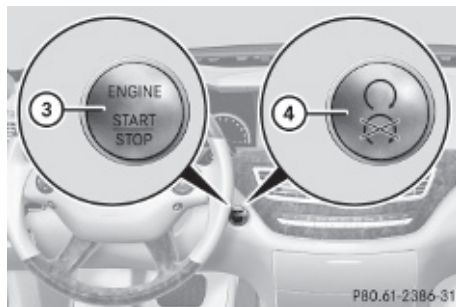

KEYLESS-GO start/stop button

- ③ USA only
- ④ Canada only

### Position 0

Before you press the KEYLESS-GO start/stop button, the vehicle's on-board electronics have status **0** (as with SmartKey removed).

### Position 1

- ▶ Press the KEYLESS-GO start/stop button once.  
This supplies power for some electrical consumers, e.g. wipers.

- i** When you now open the driver's door, the power supply is switched off.

### Ignition (or position 2)

- ▶ Press the KEYLESS-GO start/stop button twice.  
This supplies power for all electrical consumers.  
When you switch on the ignition, all lamps in the instrument cluster come on. The high-beam headlamp indicator lamp and turn signal indicator lamps will only come on if activated. If a lamp in the instrument cluster fails to come on when the ignition is switched on, have it checked and replaced if necessary. If a lamp in the instrument cluster remains on after starting the engine or comes on while driving, refer to "Lamps in instrument cluster" (> page 489).

- i** When you now press the KEYLESS-GO start/stop button once and the driver's door is open, the power supply is switched off.

## Seats

### Safety notes

#### Warning!

In order to avoid possible loss of vehicle control the following must be done before the vehicle is put into motion:

- seat adjustment
- head restraint adjustment
- steering wheel adjustment
- rear view mirror adjustment
- fastening of seat belts

#### Warning!

Do not adjust the driver's seat while driving. Adjusting the seat while driving could cause the driver to lose control of the vehicle.

Never ride in a moving vehicle with the seat backrest in an excessively reclined position as this can be dangerous. You could slide under the seat belt in a collision. If you slide under it, the seat belt would apply force at the abdomen or neck. That could cause serious or fatal injuries. The seat backrest and seat belts provide the best restraint when the wearer is in a position that is as upright as possible and seat belts are properly positioned on the body.

#### Warning!

Your seat must be adjusted so that you can correctly fasten your seat belt.

Observe the following points:

- Adjust the seat backrest until your arms are slightly angled when holding the steering wheel.
- Adjust the seat to a comfortable seating position that still allows you to reach the accelerator/brake pedal safely. The position should be as far back as possible with the driver still able to operate the controls properly.
- Adjust the head restraint so that it is as close to the head as possible. The center of the head restraint must support the back of the head at eye level.
- Never place hands under the seat or near any moving parts while a seat is being adjusted.

Failure to do so could result in an accident and/or serious personal injury.

#### Warning!

The power seats can be operated at any time. Therefore, do not leave children unattended in the vehicle, or with access to an unlocked vehicle. A child's unsupervised access to a vehicle could result in an accident and/or serious personal injury.

#### Warning!

According to accident statistics, children are safer when properly restrained in the rear seating positions than in the front seating position. Thus, we strongly recommend that children be placed in the rear seats whenever possible. Regardless of seating position, children 12 years old and under must be seated and properly secured in an appropriately sized infant restraint, toddler restraint, or booster seat recommended for the size and weight of the child. For additional information, see "Children in the vehicle".

A child's risk of serious or fatal injuries is significantly increased if the child restraints are not properly secured in the vehicle and/

or the child is not properly secured in the child restraint.

**Warning!**

For your protection, drive only with properly positioned head restraints.

Adjust the head restraint so that it is as close to the head as possible and the center of the head restraint supports the back of the head at eye level. This will reduce the potential for injury to the head and neck in the event of an accident or similar situation.

Do not drive the vehicle without the seat head restraints. Head restraints are intended to help reduce injuries during an accident.

**Seat adjustment**

You can adjust the lumbar support, multicontour seats for driver and front passenger, as well as drive-dynamic multicontour seats using COMAND (> page 216).

**!** When moving the seats, make sure there are no items in the footwell or behind the seats. Otherwise, you could damage the seats and/or the items.

**Power seats**

**Front power seats**

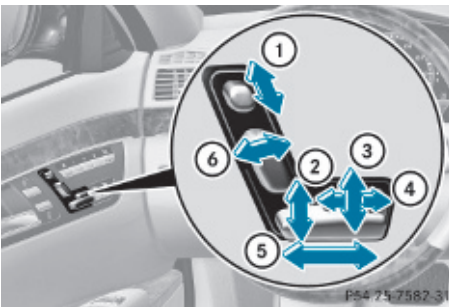

**i** If PRE-SAFE® has been activated, the front passenger's seat and/or rear power

seats will be moved to a more favorable seat position.

- i** You can store the settings for the seat position with the memory function (> page 297).
- ▶ **Head restraint height:** Press the switch up or down in direction of arrow ①.
- ▶ **Seat height:** Press the switch up or down in direction of arrow ②.
- ▶ **Seat cushion tilt:** Press the switch up or down in direction of arrow ③ until your upper legs are lightly supported.
- ▶ **Seat cushion depth:** Press the switch forward or backward in direction of arrow ④ until your legs are supported comfortably.
- ▶ **Seat fore and aft:** Press the switch forward or backward in direction of arrow ⑤.
- i** When moving the seat fore or aft, the head restraints may readjust automatically.
- ▶ **Seat backrest tilt:** Press the switch forward or backward in direction of arrow ⑥.

**Rear power seats (rear outer seats)**

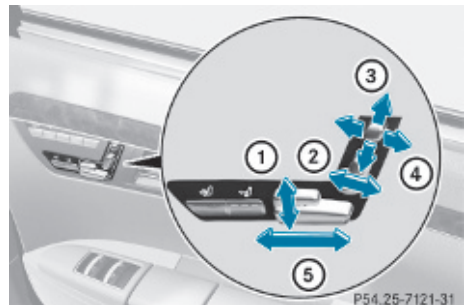

- ① Seat cushion tilt
- ② Seat backrest tilt
- ③ Folding head restraint up and down (> page 291)
- ④ Head restraint tilt
- ⑤ Seat fore and aft adjustment

- ▶ Adjust the seat using seat switches ①, ② and ⑤.

### Adjusting front passenger seat from driver's seat/rear

#### Warning!

When adjusting the front passenger seat, make sure the seat, if occupied, is as far from the front passenger front air bag as possible.

Otherwise, the passenger could be seriously or even fatally injured in the event of an accident or braking maneuver.

Make sure no one is caught or injured while the seat is being adjusted.

Even with the SmartKey or SmartKey with KEYLESS-GO removed from the starter switch or the SmartKey with KEYLESS-GO removed from the vehicle, the power seats can be operated. Therefore, do not leave children unattended in the vehicle, or with access to an unlocked vehicle. A child's unsupervised access to a vehicle could result in an accident and/or serious personal injury.

- !** Do not move the front passenger seat completely forward if objects are stored in the parcel net in the front passenger-side footwell. Items in the net may be damaged.

### Adjusting front passenger seat from driver's seat

You can adjust the front passenger seat using the seat switches on the driver's side.



- ▶ Press button ①.

When the indicator lamp in button ① is on, you can operate the following features of the front passenger seat:

- seat adjustment
- seat heating/ventilation
- memory function

### Setting front passenger seat position from rear

The button is located on the right rear passenger door.

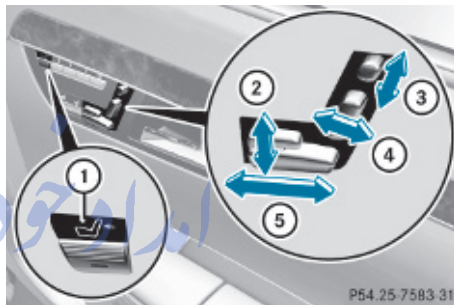

- ▶ Press button ① to adjust the front passenger seat. The indicator lamp in button ① comes on.
- ▶ Adjust front passenger seat using seat switches ②, ③, ④ and ⑤.
- ▶ To adjust right rear passenger seat, press button ① again. The indicator lamp in button ① goes out.

- i** The front passenger seat cannot be adjusted from the rear when the override switch is activated (▷ page 61).

### Head restraint fore and aft adjustment



- ▶ Push or pull on the upper edge of the head restraint cushion to the desired position.

### Comfort head restraint

#### **Warning!**

When folding back the side cushions, never reach between the side cushion and the mounting post. You could otherwise be trapped.

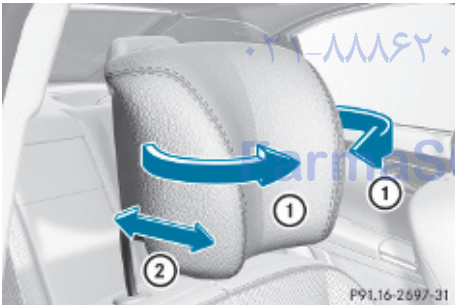

You can adjust the side cushions of the head restraints individually.

- ▶ **Adjusting side cushions:** Pull or push side cushions ① into desired position.
- ▶ **Adjusting forward or backward:** Pull or push head restraint in direction of arrow ②.

### Easy-entry/exit feature

This feature allows for easier entry into and exit from the vehicle. When entering and

exiting the vehicle, the driver's seat moves to its most rearward position. The steering wheel moves to its uppermost position. With the easy-entry/exit feature activated the steering wheel tilts upwards and the driver's seat moves to its most rearward position

- when you remove the SmartKey from the starter switch,
- or
- when you open the driver's door with the SmartKey in starter switch position 0 or 1 or the KEYLESS-GO start/stop button in position 1

The easy-entry/exit feature can be switched on or off in the Vehicle menu of the COMAND system (▷ page 208).

#### **Warning!**

You must make sure no one can become trapped or injured by the moving steering wheel and driver's seat when the easy-entry/exit feature is activated.

To stop seat/steering wheel movement, do one of the following:

- Press seat adjustment switch.
- Move steering wheel adjustment stalk.
- Press one of the memory position buttons or the memory button **M**.

Do not leave children unattended in the vehicle, or with access to an unlocked vehicle. Children could open the driver's door and unintentionally activate the easy-entry/exit feature, which could result in an accident and/or serious personal injury.

- Do not activate the easy-entry/exit feature if the seat backrest is in an excessively reclined position. Doing so could cause damage to front or rear seats. First move the seat backrest to an upright position.

The steering wheel and driver's seat will return to their last set memory position or a factory-set maximum forward position

- when you close the driver's door with the ignition switched on
- when you insert the SmartKey into the starter switch
- when you press the KEYLESS-GO start/stop button once with the driver's door closed

**i** For safety reasons, the driver's seat will not return to its last set position if the system recognizes the last set position as an extreme forward position. Instead, the driver's seat will remain at or move to a factory-set maximum forward position. To again fully return the driver's seat to your last set position or to memory position, adjust the seat to the desired position or press and hold the respective memory position button (▷ page 297).

**i** The last set driver's seat and steering wheel positions are stored when the ignition is switched off and the position is stored in memory.

**i** If the current position for the steering wheel is in the uppermost tilt position, the steering wheel will not move. If the current seat position is within a factory-set position range and the system recognizes the current seat position to be rearward enough for easy entry and exit, the driver's seat will not move to the rear. The adjustment procedure is interrupted briefly when the engine is started.

#### **Warning!**

Let the system complete the adjustment procedure before setting the vehicle in motion. All driver's seat and steering wheel adjustments must be completed before setting the vehicle in motion. Driving off with the driver's seat/steering wheel still

adjusting could cause the driver to lose control of the vehicle.

### Crash-responsive exit aid

When you open the driver's door after an accident has occurred, the steering column moves up. The position of the SmartKey in the starter switch is insignificant. This function facilitates exiting as well as rescue of vehicle occupants.

The crash-responsive exit aid can only be triggered when the easy-entry/exit feature is activated via the control system.

### Rear seat head restraints

#### **Warning!**

For safety reasons, always drive with the rear head restraints in the upright position when the rear seats are occupied.

Keep the area around head restraints clear of articles (e.g. clothing) to not obstruct the folding operation of the head restraints.

#### **Warning!**

For your protection, drive only with properly positioned head restraints.

Adjust the head restraint in such a way that it is as close to the head as possible and the center of the head restraint supports the back of the head at eye level. This will reduce the potential for injury to the head and neck in the event of an accident or similar situation.

With a rear seat occupied, make sure to move the respective head restraint up from the lowest non-use position and have the occupant adjust the head restraint properly.

Do not drive the vehicle without the seat head restraints installed when the rear seats are occupied. Head restraints are intended to help reduce injuries during an accident.



**Warning!**

Make sure the rear seat head restraints engage when placing them upright manually. Otherwise their protective function cannot be ensured.

The back of the head will not be supported in the event of a collision. That could cause serious or even fatal injuries. Rear seat occupants can be seriously injured or killed.

**Folding rear seat head restraints back**

The rear seat head restraints and the rear seat power head restraints can be folded backward for increased visibility.



- ▶ Switch on the ignition.
- ▶ Press head restraint release switch ① in the front center console briefly. The head restraints will fold backward.

**Placing rear seat head restraints upright**



- ▶ Pull the head restraint forward until it locks into position.

**Placing power rear seat head restraints upright (rear outer seats)**

**i** When you fasten your seat belt in the rear, the respective rear outer seat head restraint places upright automatically.

- ▶ Switch on the ignition.
- ▶ Press and hold head restraint release switch ① (▷ page 291) in the front center console. The rear seat head restraints will fold up.
- ▶ Pull the rear center seat head restraint upright manually until it locks into position.

**Power rear seat head restraints (rear outer seats)**

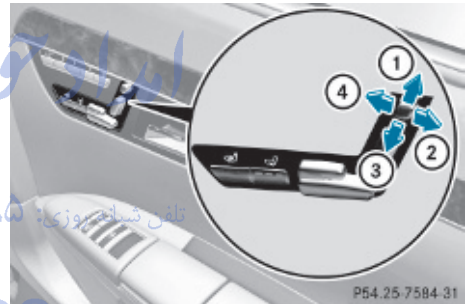

- ▶ Press switch up in direction of arrow ①. The head restraint will move to an upright position.
- ▶ Press switch down in direction of arrow ③. The head restraint will fold down.
- ▶ Press the switch forward or backward in direction of arrow ② or ④. The head restraint will be tilted.

**Comfort rear seat head restraints (rear outer seats)**

**Warning!**

When folding back the side cushions, never reach between the side cushion and the



mounting post. You could otherwise be trapped.

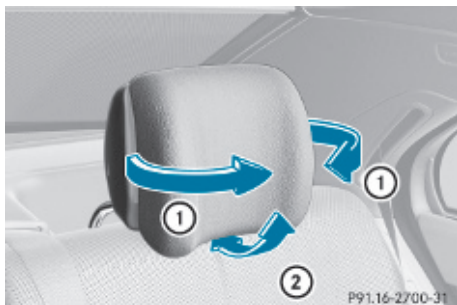

- ▶ **Adjusting side cushions:** Pull or push side cushions ① into desired position.
- ▶ **Adjusting head restraint angle:** Push or pull on the lower edge of the head restraint cushion in direction of arrow ②.

### Seat ventilation



The blue indicator lamps in seat ventilation button ① come on to show which ventilation level you have selected.

- ❗ The seat ventilation for the driver's seat can be activated using the summer opening feature (▷ page 309).

- ▶ Switch on the ignition.
- ▶ **Switching on:** Press seat ventilation button ① repeatedly until the desired ventilation level is set.
- ▶ **Switching off:** Press seat ventilation button ① repeatedly until all indicator lamps go out.

### Seat heating

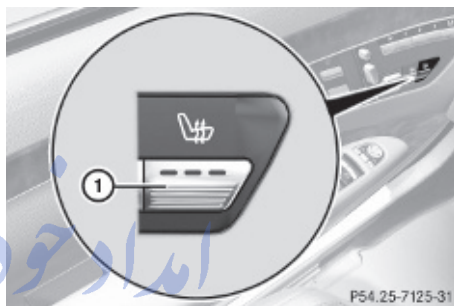

The red indicator lamps in front or rear seat heating button ① come on to show which heating level you have selected.

The seat heating switches from level 3 (high) to level 2 after approximately 5 minutes.

The seat heating switches from level 2 to level 1 (low) after approximately 10 minutes.

After approximately 20 minutes in level 1, the seat heating switches off automatically.

- ▶ Switch on the ignition.
- ▶ **Switching on:** Press respective seat heating button ① repeatedly until the desired heating level is set. One or more red indicator lamps in respective seat heating button ① show the selected heating level.
- ▶ **Switching off:** Press respective seat heating button ① repeatedly until all indicator lamps go out.

If there is insufficient voltage the seat heating switches off automatically.

The seat heating will switch back on again automatically as soon as sufficient voltage is available.

### Multicontour seats, rear

You can adjust the rear outer multicontour seats using the buttons on the center console.

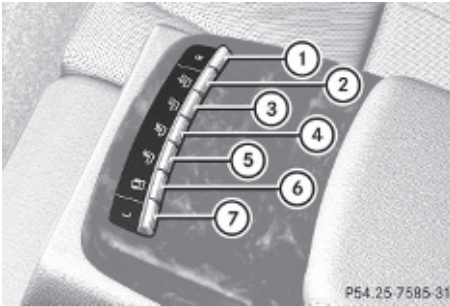

- ▶ **Selecting a seat:** Press rocker switch ① or ⑦ forward or backward.

The indicator lamp in the selected rocker switch lights up for a short while.

### Gentle massage

- ▶ **Switching on:** Press rocker switch ② forward.
- ▶ **Switching off:** Pull rocker switch ② backward.

### Vigorous massage

- ▶ **Switching on:** Press rocker switch ③ forward.
- ▶ **Switching off:** Pull rocker switch ③ backward.

### Position of seat backrest curvature

- ▶ **Moving upward:** Press rocker switch ④ forward.
- ▶ **Moving downward:** Pull rocker switch ④ backward.

### Lumbar region support

- ▶ **Selecting greater curvature:** Press rocker switch ⑤ forward.
- ▶ **Selecting less curvature:** Pull rocker switch ⑤ backward.

### Side bolster adjustment

- ▶ **Reducing width:** Press rocker switch ⑥ forward.
- ▶ **Increasing width:** Pull rocker switch ⑥ backward.

## Multifunction steering wheel

### Safety notes

#### ⚠ Warning!

Do not adjust the steering wheel while driving. Adjusting the steering wheel while driving could cause the driver to lose control of the vehicle.

The electrical steering wheel adjustment feature can be operated at any time. Therefore, do not leave children unattended in the vehicle, or with access to an unlocked vehicle. A child's unsupervised access to a vehicle could result in an accident and/or serious personal injury.

Make sure

- you can reach the steering wheel with your arms slightly bent at the elbows
- you can move your legs freely
- all displays (including malfunction and indicator lamps) on the instrument cluster are clearly visible

### Steering wheel adjustment

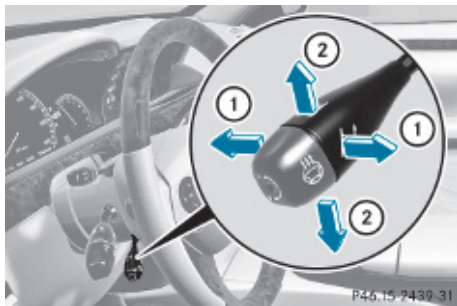

► **Adjusting steering wheel in or out:** Move stalk in direction of arrows ①.

► **Adjusting steering wheel up or down:** Move stalk in direction of arrows ②.

❗ The memory function (▷ page 297) lets you store the settings for the steering wheel together with the settings for the seat position and the exterior rear view mirrors.

### Heated steering wheel

The steering wheel heating warms up the leather area of the steering wheel.

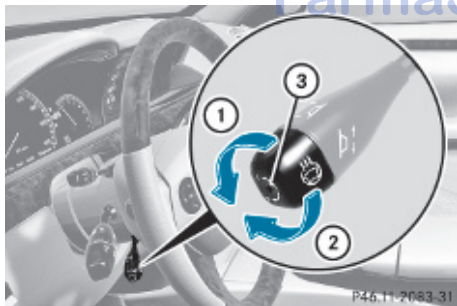

► Switch on the ignition.

► **Switching on:** Turn switch at the tip of the stalk in direction of arrow ①. Indicator lamp ③ comes on.

❗ The steering wheel heating will not switch on, when the temperature of the vehicle interior is above 86°F (30°C).

► **Switching off:** Turn switch at the tip of stalk in direction of arrow ②. Indicator lamp ③ goes out.

❗ Indicator lamp ③ flashes or goes out in case of power surge or undervoltage or if the steering wheel heating malfunctions.

❗ The steering wheel heating switches off automatically when you remove the SmartKey from the starter switch or, on vehicles with KEYLESS-GO, when you switch off the ignition and open the driver's door.

The steering wheel heating switches off automatically:

- when you remove the SmartKey from the starter switch
- on vehicles with KEYLESS-GO, when you switch off the ignition and open the driver's door
- when the temperature of the vehicle interior is above 86°F (30°C)
- after approximately 24 minutes

For more information on the steering wheel, see "Multifunction steering wheel" (▷ page 221).

### Mirrors

#### Notes

Adjust the interior and exterior rear view mirrors before driving so that you have a good view of the road and traffic conditions.

#### Interior rear view mirror

► Adjust the interior rear view mirror manually.

## Exterior rear view mirrors

### Warning!

Exercise care when using the passenger-side exterior rear view mirror. The mirror surface is convex (outwardly curved surface for a wider field of view). Objects in mirror are closer than they appear. Check your interior rear view mirror and glance over your shoulder before changing lanes.

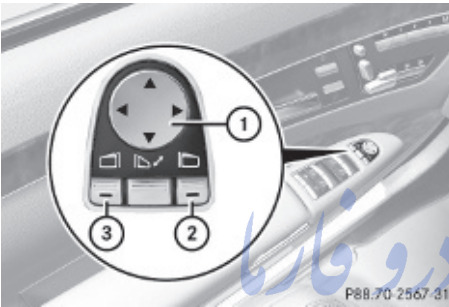

**i** You can store the settings for the exterior rear view mirror position with the memory function (▷ page 297).

- ▶ Switch on the ignition.
- ▶ Press button **3** for the driver's side exterior rear view mirror or button **2** for the passenger-side exterior rear view mirror.  
The indicator lamp in the respective button comes on.
- ▶ Press adjustment button **1** up, down, left or right according to the desired setting.

If you do not make adjustments to the selected exterior rear view mirror within 15 seconds, the indicator lamp goes out. You will then have to select the desired exterior rear view mirror again before adjustments can be made. Adjustments can only be made with the indicator lamp for the respective exterior rear view mirror button illuminated.

**!** If an exterior rear view mirror was forcibly hit from the front, manually snap it back into place.

**i** At low ambient temperatures, the exterior rear view mirrors will be heated automatically.

## Auto-dimming rear view mirrors

The exterior rear view mirror on the driver's side and the interior rear view mirror will respond automatically to glare when the ignition is switched on and incoming light from headlamps falls on the sensor in the interior rear view mirror.

The rear view mirrors will not react if the automatic transmission is set to reverse gear **R** or the interior lighting is switched on.

### Warning!

The auto dimming function does not react if incoming light is not aimed directly at sensors in the interior rear view mirror.

The interior rear view mirror and the exterior rear view mirror on the driver's side do not react, for example, if the rear window sunshade is in raised position.

Light hitting the mirror(s) at certain angles (incident light) could blind you. As a result, you may not be able to observe traffic conditions and could cause an accident.

## Exterior rear view mirror parking position

To assist during parking maneuvers, you can set the passenger-side exterior rear view mirror so that you can see the rear wheel and the road curb.

## Setting and storing the parking position



- ▶ Switch on the ignition.
- ▶ Press button ③, to select the passenger-side exterior rear view mirror.
- ▶ Shift the automatic transmission into reverse gear **R**.  
The passenger-side exterior rear view mirror moves to the preset parking position.
- ▶ Adjust the passenger-side exterior rear view mirror with adjustment button ② so that you see the rear wheel and the road curb.  
The exterior rear view mirror parking position is stored.

You can also store the parking position using the memory button **M** ①:

- ▶ Switch on the ignition.
- ▶ Press button ③, to select the passenger-side exterior rear view mirror.
- ▶ Adjust the passenger-side exterior rear view mirror with adjustment button ② so that you see the rear wheel and the road curb.
- ▶ Press memory button **M** ① and within 3 seconds, press one of the arrows of adjustment button ②.  
The parking position is stored if the exterior rear view mirror does not move.

**i** If the exterior rear view mirror does move, repeat the above steps. After the setting is stored, you can move the exterior rear view mirror again.

## Calling up the parking position

- ▶ Switch on the ignition.
- ▶ Press button ③, to select the passenger-side exterior rear view mirror.
- ▶ Shift the automatic transmission into reverse gear **R**.  
The passenger-side exterior rear view mirror moves to the stored parking position.

The passenger-side exterior rear view mirror returns to its previously stored driving position

- when you switch off the ignition
- 10 seconds after you have put the gear selector lever out of reverse gear **R**
- immediately once your vehicle exceeds a speed of approximately 6 mph (10 km/h)
- immediately when you press button ④ to select the driver's side exterior rear view mirror

**i** If you adjust the exterior rear view mirrors while they are in the parking position, the new exterior rear view mirror position is stored as a new parking position.

## Power-folding exterior rear view mirrors

**!** Before you drive the vehicle through an automatic car wash, fold in the exterior rear view mirrors. Otherwise they may get damaged.

## Folding in and out automatically

The function must be activated in the COMAND system (▷ page 209).

The exterior rear view mirrors fold in automatically as soon as the vehicle is locked from the outside.

The exterior rear view mirrors fold out automatically as soon as the vehicle is unlocked and the driver's or front passenger door is subsequently opened.

## Folding in and out manually

- i** The mirrors do not fold out if they have been folded in manually. Please make sure both mirrors are folded out before driving off.

The exterior rear view mirrors can vibrate if they are not folded out completely.



- ▶ **Folding in:** Briefly press button ①. Both exterior rear view mirrors fold in.
  - ▶ **Folding out:** Briefly press button ①. Both exterior rear view mirrors fold out.
- !** If an exterior rear view mirror housing is forcibly pushed forward (hit from the rear), reposition it manually by applying firm pressure until it snaps back into place. If an exterior rear view mirror housing is forcibly pushed rearward (hit from the front), press button ① to fold mirrors in. Then press button ① again to fold mirrors out. Do not force mirrors by hand as this may damage the adjustment mechanism. The mirror housing is then properly positioned and you can adjust the mirror in the usual manner.

Each memory position button on the driver's side can store all of the following settings:

- Seat position
- Multicontour seat: previously saved settings
- Drive-dynamic multicontour seat: activation/deactivation
- Steering wheel position
- Exterior rear view mirrors' position

### **⚠ Warning!**

Do not activate the memory function while driving. Activating the memory function while driving could cause the driver to lose control of the vehicle.

Each memory position button on the front passenger side can store all of the following settings:

- Seat position
- Multicontour seat: previously saved settings
- Drive-dynamic multicontour seat: activation/deactivation



## Memory function

### Notes

With the memory function you can store up to three different configurations per front seat.



### Storing positions into memory

- ▶ Adjust the seats.
- ▶ On the driver's side, also adjust the steering wheel and exterior rear view mirrors to the desired positions.
- ▶ Press memory button **M** once and within 3 seconds press memory position button **1**, **2** or **3**.

When the settings are stored to the selected position, an acknowledgement signal sounds.

### Recalling positions from memory

- ▶ Press and hold desired memory position button **1**, **2** or **3** until the seat has moved to the stored position completely. On the driver's side, also wait for the steering wheel and exterior rear view mirrors to move to the stored position.

**i** Releasing the memory position button stops movement to the stored positions immediately.

## Lighting

### Notes

- i** If you drive in countries with left-hand driving, you must have the headlamps modified for symmetrical low beams. Relevant information can be obtained at any authorized Mercedes-Benz Center.
- i** The active Bi-Xenon headlamps increase usable illumination over conventional headlamps because they follow the curvature of the road ahead. The beams of the active Bi-Xenon headlamps shift to either side according to the vehicle's steering angle and speed.

### Exterior lamp switch



- |          |          |  |
|----------|----------|--|
| <b>1</b> |          | Standing lamps, left                                 |
| <b>2</b> |          | Standing lamps, right                                |
| <b>3</b> | <b>0</b> | Off<br>Daytime running lamp mode                     |
| <b>4</b> | <b>A</b> | Automatic headlamp mode<br>Daytime running lamp mode |
| <b>5</b> |          | Parking lamps <sup>38</sup>                          |
| <b>6</b> |          | Low-beam headlamps or high-beam headlamps            |
| <b>7</b> |          | Vehicles without front fog lamps:<br>Rear fog lamp   |
| <b>7</b> |          | Vehicles with front fog lamps: Front fog lamps       |
| <b>8</b> |          | Vehicles with front fog lamps: Rear fog lamp         |

**i** The exterior lamps (except standing lamps or parking lamps) go out automatically when you remove the SmartKey from the starter switch or open the driver's door with the ignition switched off.

When the parking lamps or the rear fog lamp are switched on and you remove the SmartKey from the starter switch and open the driver's door, an acoustic signal sounds.

In addition, the message Please Switch Off Lights appears in the multifunction display.

<sup>38</sup> When the parking lamps are on, the tail lamps, the license plate lamps, the side marker lamps, and the instrument cluster illumination are also on.



Switch off the parking lamps or the rear fog lamp manually.

**!** Failure to switch off the parking lamps when leaving the vehicle may result in a discharged battery.

**i** Vehicles without front fog lamps: For better detection of the vehicle, the LED daytime running lamps are dimmed to parking lamp level when the low-beam headlamps are switched on.

### Low-beam headlamps

The low-beam headlamps can be switched on and off with the exterior lamp switch.

► Switch on the ignition.

► **Switching on:** Turn the exterior lamp switch to position .

The following lamps come on:

- Low-beam headlamps
- Parking lamps<sup>38</sup>
- Green indicator lamp  in the exterior lamp switch



► **Switching off:** Turn the exterior lamp switch to position .



### Automatic headlamp mode

#### Warning!

If the exterior lamp switch is set to , the headlamps will not automatically come on under foggy conditions.

To minimize risk to you and to others, activate headlamps by turning exterior lamp switch to  when driving or when traffic and/or ambient lighting conditions require you to do so.

In low ambient lighting conditions, only switch from position  to  with the vehicle at a standstill in a safe location. Switching

from  to  will briefly switch off the headlamps. Doing so while driving in low ambient lighting conditions may result in an accident.

The automatic headlamp feature is only an aid to the driver. The driver is responsible for the operation of the vehicle's lights at all times.

► **Switching on:** Turn the exterior lamp switch to position .

**When ambient light is low:** When the SmartKey is in starter switch position **1** or when the KEYLESS-GO start/stop button has been pressed once, the parking lamps<sup>38</sup> come on automatically.

When the engine is running, the low-beam headlamps come on additionally.

**When ambient light is bright:** When the SmartKey is in starter switch position **1** or when the KEYLESS-GO start/stop button has been pressed once, all lamps are off.

When the engine is running, the daytime running lamps<sup>39</sup> come on automatically.

When the low-beam headlamps are switched on, the green indicator lamp  in the exterior lamp switch comes on.

Once the low-beam headlamps are on, the high-beam headlamps are also available.

### Daytime running lamp mode

In Canada, the daytime running lamp mode is mandatory and therefore in a constant mode.

In the USA, the daytime running lamp mode is deactivated by default.

► Activate the daytime running lamp mode using the control system, see "Switching

<sup>38</sup> When the parking lamps are on, the tail lamps, the license plate lamps, the side marker lamps, and the instrument cluster illumination are also on.

<sup>39</sup> USA only: The daytime running lamp mode must be activated via the control system.

daytime running lamp mode on or off (USA only)" (▷ page 234).

- ▶ Turn the exterior lamp switch to position  or .

When the engine is running and the ambient light is bright, the daytime running lamps come on.

In low ambient lighting conditions, the following lamps will come on additionally:



- Low-beam headlamps
- Parking lamps<sup>38</sup>
- green indicator lamp  in the exterior lamp switch

You can only switch on the high-beam headlamps when the low-beam headlamps are on.

The high-beam flasher is available at all times.



### Canada only

When the engine is running, and you

- shift from a driving position to park position **P** with the vehicle at a standstill or the electronic parking brake is engaged, the daytime running lamps or the low-beam headlamps will go out with a delay of 3 minutes
- turn the exterior lamp switch to position , the daytime running lamps and the parking lamps<sup>38</sup> come on in bright ambient lighting conditions.
- turn the exterior lamp switch to position , the manual headlamp mode has priority over the daytime running lamp mode



The corresponding exterior lamps come on (▷ page 298).

### USA only



When the engine is running, and you turn the exterior lamp switch to position  or , the manual headlamp mode has priority over the daytime running lamp mode.



The corresponding exterior lamps come on (▷ page 298).

## Fog lamps

Fog lamps cannot be switched on with the exterior lamp switch in position  or .



### ⚠ Warning!

In low ambient lighting or foggy conditions, only switch from position  to  with the vehicle at a standstill in a safe location.

Switching from  to  will briefly switch off the headlamps. Doing so while driving in low ambient lighting conditions may result in an accident.

Front fog lamps will operate with the parking lamps and/or the low-beam headlamps on.



The rear fog lamp can only be switched on with the exterior lamp switch in position . Fog lamps should only be used in conjunction with low-beam headlamps. Consult your State or Province Motor Vehicle Regulations regarding permissible lamp operation.

- ▶ Switch on the ignition.
- ▶ Turn the exterior lamp switch to position  or  (▷ page 298).

## Vehicles with front fog lamps

- ▶ **Switching on front fog lamps:** Pull out the exterior lamp switch to first stop (▷ page 298).

The green indicator lamp  in the exterior lamp switch comes on.

- ▶ **Switching on rear fog lamp:** Pull out the exterior lamp switch to second stop. The rear fog lamp, the front fog lamps, the green  and the yellow indicator lamp  in the exterior lamp switch come on.

- ▶ **Switching off front fog lamps/rear fog lamp:** Push in the exterior lamp switch to its stop.

<sup>38</sup> When the parking lamps are on, the tail lamps, the license plate lamps, the side marker lamps, and the instrument cluster illumination are also on.

## Vehicles without front fog lamps



- ▶ **Switching on rear fog lamp:** Pull out the exterior lamp switch to its stop (▷ page 298).  
The rear fog lamp and the yellow indicator lamp  in the exterior lamp switch come on.
- ▶ **Switching off rear fog lamp:** Push in the exterior lamp switch to its stop.

## Locator lighting and night security illumination

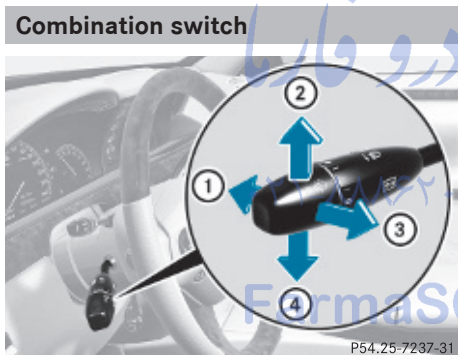
The locator lighting and night security illumination are described in the COMAND vehicle menu section under (▷ page 208).



## Turn signals



- ▶ Press the combination switch in direction of arrow ② or ④.  
The corresponding turn signal indicator lamp  or  in the instrument cluster flashes.

The combination switch resets automatically after major steering wheel movements.

### To signal minor directional changes:

- ▶ Press the combination switch only to the point of resistance in direction of arrow ② or ④ and release.  
The corresponding turn signal lamps will flash three times.

## High beam

- ▶ Turn the exterior lamp switch to position  (▷ page 298).
- ▶ **Switching on:** Push the combination switch in direction of arrow ①.  
The high-beam headlamp indicator lamp  in the instrument cluster comes on.
- ▶ **Switching off:** Pull the combination switch in direction of arrow ③ to its original position.

- ⓘ Also note the information on high-beam headlamps with activated automatic headlamp mode (▷ page 299) or the daytime running lamp mode (▷ page 299).

## Adaptive Highbeam Assist

Depending on the driving and traffic situation, low-beam leveling and the high-beam headlamps are controlled via an optical sensor. The sensor is located on the front of the overhead control panel. Glare for other road users is reduced and the illumination of road ahead is improved. The transitions between low-beam and high-beam headlamps take place without a sudden change of light.

### ⚠ Warning!

The Adaptive Highbeam Assist is only an aid intended to support you while driving. The driver is and remains responsible for proper vehicle lighting in accordance with the prevailing light, sight and traffic conditions. The system may be impaired or unavailable when







- visibility is poor, e.g. due to snow, rain, fog, or heavy spray
- the optical sensor area of the windshield is dirty, fogged up, or covered by a sticker for example

The system cannot recognize the following road users:

- Road users without a lighting system of their own, e.g. pedestrians
- Road users with dim lighting of their own, e.g. cyclists
- Road users whose lighting is obstructed, e.g. road users behind a guardrail
- In some seldom cases, even road users with a lighting system of their own may be recognized too late or not at all.

The automatic high-beam headlamps will then not be deactivated or it will be activated in spite of preceding or oncoming road users.

This could endanger you and/or others and cause an accident. Always pay close attention to the traffic situation and switch off the high beam manually if necessary.

- ▶ **Activating:** Enable the Adaptive Highbeam Assist via the control system (▷ page 235).
- ▶ Turn the exterior lamp switch to position .
- ▶ Press the combination switch in direction of arrow . The Adaptive Highbeam Assist indicator  in the multifunction display comes on when switching on the low-beam headlamps. When driving faster than approximately 34 mph (55 km/h) and no other road users are recognized, the high-beam headlamps are switched on automatically. The high-beam headlamp indicator lamp  in the instrument cluster comes on additionally. When driving slower than approximately 28 mph (45 km/h), other road users are recognized, or the road is illuminated sufficiently, the high-beam headlamps are switched off automatically. The indicator lamp  in the instrument cluster goes out. The Adaptive Highbeam Assist indicator  in the multifunction display remains on.

Adaptive control of the headlamp leveling takes place at a speed of approximately 25 mph (40 km/h).

- ▶ **Deactivating:** Pull the combination switch back to its initial position. The Adaptive Highbeam Assist indicator  in the multifunction display goes out.

### High-beam flasher

- ▶ **Switching on:** Pull the combination switch briefly in direction of arrow .

### Hazard warning flasher

The hazard warning flasher can be switched on at all times, even with the SmartKey removed from the starter switch.

The hazard warning flasher comes on automatically when an air bag deploys.

S 600 and S 65 AMG (USA only):

The hazard warning flasher comes on automatically when you brake the vehicle strongly at a speed of more than 50 mph (70 km/h) and bring it to a complete stop.



- ▶ **Switching on:** Press hazard warning flasher switch . All turn signal lamps are flashing.

**i** With the hazard warning flasher activated and the combination switch set for either left or right turn, only the respective left or

right turn signals will operate when the ignition is switched on.

- ▶ **Switching off:** Press hazard warning flasher switch ① again.

- ❗ If the hazard warning flasher was activated automatically, press hazard warning flasher switch ① to switch it off.

S 600 and S 65 AMG (USA only):

When the hazard warning flasher was activated by a hard stop automatically, it will be switched off automatically at a vehicle speed of above 6 mph (10 km/h).

### Headlamp cleaning system

The headlamps will be cleaned with a high-pressure water jet automatically when the engine is running and you have

- switched on the headlamps and
- the windshield wipers have wiped the windshield with washer fluid five times

The counter resets when you switch off the ignition.

For information on filling up the washer reservoir, see “Washer system and headlamp cleaning system” (▷ page 409).



### Corner-illuminating lamps

The corner-illuminating lamps improve illumination of the area in the direction into which you are turning.

The corner-illuminating lamps will only operate in low ambient lighting conditions.

If you are driving faster than 25 mph (40 km/h) the corner-illuminating function is not available.

### Switching on

- ▶ Make sure the engine is running.
- ▶ Turn the exterior lamp switch to position  or  (▷ page 298).

or

- ▶ Activate the daytime running lamp mode (▷ page 299).
- ▶ Switch on the left or right turn signal, depending on whether you are turning left or right.

The respective corner-illuminating lamp comes on. If you have switched on the turn signal for one side but turn the steering wheel in the other direction, the corner-illuminating lamp comes on on the side of the turn signal.

or

- ▶ Turn steering wheel in desired direction. Driving forward: The corner-illuminating lamp on the side of your steering direction comes on.

Driving in reverse: The corner-illuminating lamp opposite to your steering direction comes on.

The corner-illuminating lamps will come on automatically depending on the steering angle, even if you did not switch on either turn signal. If the corner-illuminating lamps came on automatically, they will also go out automatically depending on the steering angle and vehicle speed.

The corner-illuminating lamps temporarily come on on both sides of the vehicle if you turn the steering wheel in one direction and then again in the other direction shortly thereafter.

The corner-illuminating lamp remains lit for a short time only. It then goes out automatically.

## Switching off

- ▶ Switch off the left or right turn signal.

or

- ▶ Steer straight ahead.  
The corner-illuminating lamp goes out.

**i** There may be a brief delay before the corner-illuminating lamps go out.

## Interior lighting in the front

**i** Even with the SmartKey being removed from the starter switch you can still use the lighting for the storage compartment, glove box and vanity mirrors, when you open a door or press one of the interior lighting buttons. If a lamp is switched on and you do not lock the vehicle, it will be switched off automatically after 30 minutes.

When you lock the vehicle from the outside, the interior lighting is switched off.



- 1 Left front reading lamp on/off
- 2 Rear interior lighting on/off
- 3 Front interior lighting on/off
- 4 Automatic control on/off
- 5 Right front reading lamp on/off

## Automatic control

- ▶ **Activating:** Press button .

The OFF indicator lamp next to the button goes out.

The interior lighting comes on, when you

- unlock the vehicle
- remove the SmartKey from the starter switch (Interior Lighting Delayed Switch-off must be switched on (▷ page 208))
- open a door

The interior lighting goes out after a short time (▷ page 208).

**i** If a door remains open, the interior lamps go out automatically after approximately 5 minutes.

- ▶ **Deactivating:** Press button . The OFF indicator lamp next to the button comes on.

## Manual control

- ▶ **Switching front interior lighting on/off:** Press button .
- ▶ **Switching rear interior lighting on/off:** Press button .
- ▶ **Switching front reading lamps on/off:** Press respective button .

**i** The brightness of the ambient lighting is adjusted via COMAND (▷ page 209).

## Emergency lighting

The interior lighting comes on automatically if the vehicle is involved in an accident.

### Switching off:

- ▶ Press hazard warning flasher switch (▷ page 302).
- or
- ▶ Press switch .
- or
- ▶ Unlock the vehicle with the SmartKey.

## Interior lighting in the rear

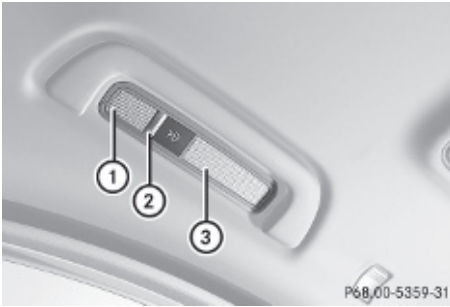

**i** An interior lamp switched on manually does not go out automatically.

Leaving an interior lamp switched on for an extended period of time with the engine turned off could result in a discharged battery.



- ① Rear reading lamp
- ②  Rear reading lamp switch
- ③ Rear interior lamp

#### Switching rear reading lamp and rear interior lamp on/off:

- ▶ Press reading lamp switch . Rear reading lamp ① and rear interior lamp ③ come on.
- ▶ Press reading lamp switch  once more. Only rear reading lamp ① remains on.
- ▶ Press reading lamp switch  once more. All rear lamps are off.

## Wipers

### Notes

**!** Do not operate the wipers when the windshield is dry. Dust that accumulates on a windshield might scratch the glass and/or damage the wiper blades when wiping occurs on a dry windshield. If it is necessary to operate the wipers in dry weather conditions, always operate the wipers with washer fluid.

<sup>40</sup> Rain sensor operation with low sensitivity.

<sup>41</sup> Rain sensor operation with high sensitivity.

**!** If the windshield wipers leave smears on the windshield after the car has been driven through an automatic car wash, then wax or other residue is on the windshield. Shortly after washing the car in an automatic car wash, clean the windshield with washer fluid.





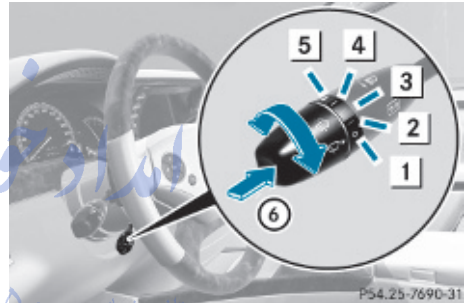

### Windshield wipers

- ▶ Observe notes on page (▷ page 305).

### Switching on/off



#### Combination switch

- ①  Windshield wipers off
- ②  Slow intermittent wiping<sup>40</sup>
- ③  Fast intermittent wiping<sup>41</sup>
- ④  Slow continuous wiping
- ⑤  Fast continuous wiping
- ⑥  Single wipe /  Wiping with washer fluid

- ▶ Switch on the ignition.
- ▶ Turn the combination switch to the desired position, depending on the intensity of the rain.

**i** When the windshield wipers are switched on and you stop the vehicle, the wipers operate more slowly.





- Remove blockage.
- Turn the windshield wipers on again.

If the windshield wipers fail to function at all with the combination switch in position

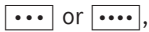

- set the combination switch to the next higher wiper speed
- have the windshield wipers checked at the nearest authorized Mercedes-Benz Center

## Power windows

### Opening and closing

The door windows are opened and closed electrically. The switches for all door windows are located on the driver's door control panel. The switches for the respective door windows are located on the front passenger door and on the rear doors.

- i** Operating the rear door windows from the rear is not possible when you activate the override switch (▷ page 61).

**⚠ Observe Safety notes, see page 56.**

#### **⚠ Warning!**

When opening or closing the door windows, make sure there is no danger of anyone being harmed by the opening/closing procedure.

The door windows are equipped with the express operation and automatic reversal function. If in express operation mode a door window encounters an obstruction that blocks its path, the automatic reversal function will stop the door window and open it slightly.

The door windows operate differently when the switch is pulled and held. See the "Closing when a door window is blocked" section in this chapter for details.

The closing of the door windows can be immediately halted by releasing the switch or, if the switch was pulled past the resistance

point and released, by either pressing or pulling the respective switch.

Activate the override switch when children are riding in the back seats of the vehicle. The children may otherwise injure themselves, e.g. by becoming trapped in the door window opening.

#### **⚠ Warning!**

Do not keep any part of your body up against the window pane when opening a window. The downward motion of the pane may pull that part of your body down between the window pane and the door frame and trap it there. If there is a risk of entrapment, release the switch and pull it to close the window.

- i** You can also open or close the door windows using the SmartKey, see "Summer opening feature" (▷ page 309) and "Convenience closing feature" (▷ page 309).

- i** After switching off the ignition or removing the SmartKey from the starter switch, you can operate the door windows until you open the driver's or front passenger door. If no door was opened you can operate the door windows for up to 5 minutes.

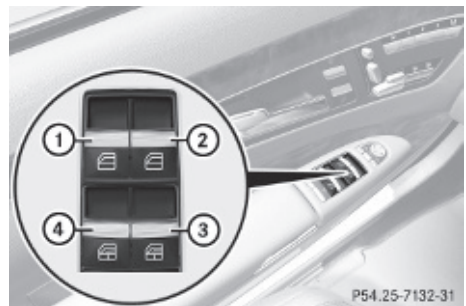

P54.25-7132-31

- ▶ Switch on the ignition.
- ▶ **Opening/closing:** Press or pull and hold switch ① to ④ to the resistance point. The corresponding door window moves downward or upward until you release the switch.
- ▶ **Express operation:** Press or pull switch ① to ④ past the resistance point and release. The corresponding door window opens or closes completely.
- ▶ **Stopping during express operation:** Press or pull the respective switch again.

### Closing when a door window is blocked

#### Warning!

Make sure that nobody can become trapped and be seriously or even fatally injured when closing a door window with greater force or without automatic reversal function.

If the upward movement of a door window is blocked during the closing procedure, the door window will stop and open slightly.

- ▶ Immediately after the door window has stopped because it was blocked, pull and hold the respective switch upward until the door window is fully closed. The door window closes with greater force.

If the door window is blocked again and opens slightly:

- ▶ Immediately after the door window was blocked, pull and hold the respective switch upward until the door window is fully closed. The door window closes without automatic reversal function.

#### Warning!

Pulling and holding the switch to close the door window immediately after it had been blocked two times will cause the door window to close without any reversal function for as long as you hold the switch.

### Rear door window sunshades

- ▶ **Extending:** With the door window fully closed, pull switch ③ or ④. The rear door window sunshade will be fully extended.
- i** The rear door window sunshade cannot be extended partially.
- ▶ **Retracting:** Press switch ③ or ④. The rear door window sunshade will be fully retracted.
- i** The switches on the rear doors can also be used to close the rear door window sunshades on the other side of the vehicle.

- i** The switches on the driver's door have priority over the rocker switches on the other doors.

### Synchronizing door windows

The door windows must be synchronized if they cannot be fully closed (express operation).

Each door window must be synchronized separately.

- ▶ Close all doors.
- ▶ Switch on the ignition.
- ▶ Pull and hold switch ①, ②, ③ or ④ (▷ page 307) until the respective door window is closed. The door window opens again slightly.
- ▶ Pull and hold the respective switch once more immediately until the door window is closed completely.
- ▶ Hold the respective switch for approximately 1 second. The door window is synchronized.

### Summer opening feature

When the weather is warm, you can ventilate the vehicle before driving off by simultaneously

- opening the door windows
- retracting the rear door window sunshades
- opening the tilt/sliding sunroof
- opening the panorama roof with power tilt/sliding panel and roller sunblinds
- switching on the seat ventilation for the driver's seat



The summer opening feature can only be activated via the remote control of the SmartKey. The SmartKey must be in close proximity to the driver's outside door handle.

- ▶ Aim the transmitter eye of the SmartKey at the driver's outside door handle.

### When roller sunblinds and/or rear door window sunshades are extended:

- ▶ Press and hold button  on the SmartKey.  
The vehicle unlocks.

The roller sunblinds and/or rear door window sunshades begin to retract after approximately 1 second.

- i** When the vehicle is equipped with rear door window sunshades, the rear window sunshade opens simultaneously.
- ▶ With the roller sunblinds and/or rear door window sunshades fully retracted, press and hold button  on the SmartKey again.  
The door windows and the tilt/sliding sunroof or the panorama roof with power tilt/sliding panel open.
- ▶ Release button  on the SmartKey to interrupt the opening procedure.

### When roller sunblinds and/or rear door window sunshades are retracted or when the vehicle is equipped with tilt/sliding sunroof only:

- ▶ Press and hold button  on the SmartKey.  
The vehicle unlocks.

The door windows and the tilt/sliding sunroof or the panorama roof with power tilt/sliding panel open after approximately 1 second.

- ▶ Release button  on the SmartKey to interrupt the opening procedure.

### Convenience closing feature

When locking the vehicle, you can simultaneously close



- the door windows
- the tilt/sliding sunroof
- the panorama roof with power tilt/sliding panel

Afterward, you can extend the roller sunblinds of the panorama roof with power tilt/sliding panel and the rear door window sunshades.

### Warning!

When closing the door windows and the tilt/sliding sunroof or panorama roof with power tilt/sliding panel, make sure there is no danger of anyone being harmed by the closing procedure.

If potential danger exists, proceed as follows:

- Release button  to stop the closing procedure. To open, press and hold button . To continue the closing procedure after making sure that there is no danger of





anyone being harmed by the closing procedure, press and hold button .

Vehicles with KEYLESS-GO:

- Release the sensor surface on the outside door handle to stop the closing procedure.
- Immediately pull on the same outside door handle and hold firmly. The door windows and the tilt/sliding sunroof or panorama roof with power tilt/sliding panel will open for as long as the door handle is held but the door not opened.

### With SmartKey

The SmartKey must be in close proximity to the driver's outside door handle.

- ▶ Aim transmitter eye of the SmartKey at the driver's outside door handle.
- ▶ Press and hold button  on the SmartKey until the door windows and the tilt/sliding sunroof or panorama roof with power tilt/sliding panel are closed completely.
- ▶ Release button  on the SmartKey to interrupt the closing procedure.
- ▶ **Vehicles with panorama roof with power tilt/sliding panel and/or rear door window sunshades:** Press button  on the SmartKey once more. The roller sunblinds and/or the rear door window sunshades extend.
- ▶ Press button  on the SmartKey to interrupt the extending procedure.

**i** Vehicles with rear door window sunshades: The rear window sunshade extends simultaneously.

### With KEYLESS-GO

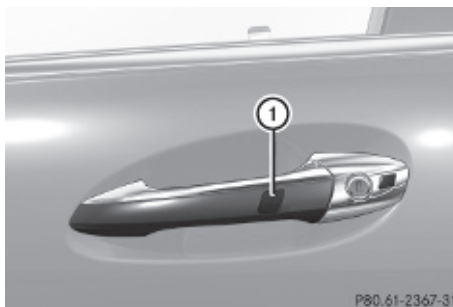

The SmartKey with KEYLESS-GO must be located outside the vehicle within approximately 3 ft (1 m) of a door.

- ▶ Close all doors.
- ▶ Touch and hold sensor surface **①** on an outside door handle until the door windows and the tilt/sliding sunroof or panorama roof with power tilt/sliding panel are closed completely.
- i** Make sure you are only touching sensor surface **①**.
- ▶ Release sensor surface **①** to interrupt the closing procedure.
- ▶ **Vehicles with panorama roof with power tilt/sliding panel and/or rear door window sunshades:** Touch and hold sensor surface **①** once more. The roller sunblinds and/or the rear door window sunshades extend.
- ▶ Pull on the outside door handle and hold firmly to interrupt the extending procedure.
- i** Vehicles with rear door window sunshades: The rear window sunshade extends simultaneously.

## Driving and parking

### Safety notes

#### Warning!

Make sure absolutely no objects are obstructing the pedals' range of movement. Keep the driver's footwell clear of all obstacles. If there are any floor mats or carpets in the footwell, make sure the pedals still have sufficient clearance.

During sudden driving or braking maneuvers the objects could get caught between or under the pedals. You could then no longer brake or accelerate. This could lead to accidents and injury.

#### Warning!

With the engine not running, there is no power assistance for the brake and steering systems. In this case, it is important to keep in mind that a considerably higher degree of effort is necessary to brake and steer the vehicle. Adapt your driving accordingly.

#### Warning!

HYBRID vehicles: It is imperative that you read the HYBRID Supplemental Operating Instructions included in your vehicle literature portfolio. You may otherwise not receive all necessary safety information and warning for the operation of your vehicle.

### Starting the engine

#### Warning!

Inhalation of exhaust gas is hazardous to your health. All exhaust gas contains carbon monoxide (CO), and inhaling it can cause unconsciousness and possible death.

Do not run the engine in confined areas (such as a garage) which are not properly ventilated. If you think that exhaust gas fumes are entering the vehicle while driving, have the cause determined and corrected

immediately. If you must drive under these conditions, drive only with at least one window fully open at all times.

### Automatic transmission



Gearshift pattern for automatic transmission

- ① Button for selecting park position **P**
- P** Park position
- R** Reverse gear
- N** Neutral position
- D** Drive position

For more information on how to operate the gear selector lever, see "Automatic transmission" (▷ page 317).

- ▶ Make sure the automatic transmission is in park position **P**.

The transmission position indicator in the multifunction display should be on **P** (▷ page 320).

### With SmartKey

- ▶ Do not depress the accelerator pedal.
- ▶ Turn the SmartKey in the starter switch to position **3** (▷ page 284) and release it. The engine starts automatically.

### With KEYLESS-GO

#### Warning!

As long as the SmartKey is in your vehicle, the vehicle can be started. Therefore, never leave

children unattended in the vehicle, as they could otherwise accidentally start the engine.

When leaving the vehicle, always take the SmartKey with you and lock the vehicle. Do not leave children unattended in the vehicle, or with access to an unlocked vehicle. A child's unsupervised access to a vehicle could result in an accident and/or serious personal injury.

You can start your vehicle without the SmartKey in the starter switch using the KEYLESS-GO start/stop button.

The SmartKey must be located in the vehicle.

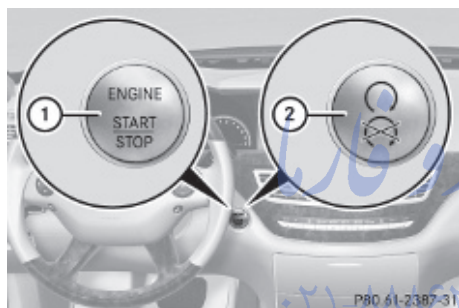

KEYLESS-GO start/stop button

① USA only

② Canada only

- ▶ Make sure the KEYLESS-GO start/stop button is inserted in the starter switch (▷ page 284).

**i** To start the engine with the SmartKey instead of the KEYLESS-GO function, remove the KEYLESS-GO start/stop button from the starter switch. Proceed as described in "With SmartKey" (▷ page 311).

- ▶ Depress the brake pedal during the starting procedure.
- ▶ Do not depress the accelerator pedal.
- ▶ Press the KEYLESS-GO start/stop button once.  
The engine starts automatically.

## Starting difficulties

- i** Remember that extended starting attempts can drain the battery.

### The engine does not start. You can hear the starter.

There could be a malfunction in the engine electronics or in the fuel supply system.

Carry out the following steps:

- ▶ If you are starting the engine with the SmartKey: Turn the SmartKey in the starter switch to position **0** and repeat the starting procedure.
- ▶ If you are starting the engine with KEYLESS-GO: Close any doors that may be open to allow for better detection of the SmartKey.

or

- ▶ Remove the KEYLESS-GO start/stop button from the starter switch.
- ▶ Start the engine with the SmartKey as radio signals from another source may be interfering with the KEYLESS-GO function.
- ▶ Repeat the starting procedure.

If the engine does not start after several starting attempts:

- ▶ Contact an authorized Mercedes-Benz Center or call Roadside Assistance.

### The engine does not start. You cannot hear the starter.

The battery may not be charged sufficiently.

- ▶ Get a jump start (▷ page 514).

If the engine will not start despite a jump start:

- ▶ Contact an authorized Mercedes-Benz Center or call Roadside Assistance.

The starter has been exposed to excessive temperatures.

- ▶ Let the starter cool for about 2 minutes.
- ▶ Repeat the starting procedure.





If the engine does not start after several starting attempts:

- ▶ Contact an authorized Mercedes-Benz Center or call Roadside Assistance.

### Driving off

#### Warning!

On slippery road surfaces, never downshift in order to obtain braking action. This could result in drive wheel slip and reduced vehicle control. Your vehicle's ABS will not prevent this type of loss of control.

- !** Do not run a cold engine at high engine speeds. Running a cold engine at high engine speeds may shorten the service life of the engine. This is not covered by the Mercedes-Benz Limited Warranty.  
S 63 AMG: At engine temperatures below 68°F (20°C), the engine's maximum speed is restricted in order to protect it from damage. Avoid driving your vehicle at full speed when the engine is cold to prevent premature engine wear and/or diminished comfort.
- !** You have forgotten to release the electronic parking brake when driving off if
  - an acoustic warning sounds
  - the message **Please Release Parking Brake** appears in the multifunction display
  - the red indicator lamp for the electronic parking brake  (USA only) or  (Canada only) in the instrument cluster flashes

Release the electronic parking brake.
- !** Avoid spinning of a drive wheel. This may cause serious damage to the drivetrain which is not covered by the Mercedes-Benz Limited Warranty.

- !** Simultaneously depressing the accelerator pedal and applying the brakes reduces engine performance and causes premature brake and drivetrain wear which is not covered by the Mercedes-Benz Limited Warranty.



- i** Once the vehicle is in motion, the doors and the trunk lock automatically. The locking knobs in the doors move down. The automatic door lock feature can be deactivated (> page 210).

### Automatic transmission

#### Warning!

It is dangerous to shift the automatic transmission out of park position **P** or neutral position **N** if the engine speed is higher than idle speed. If your foot is not firmly on the brake pedal, the vehicle could accelerate quickly forward or in reverse. You could lose control of the vehicle and hit someone or something. Only shift into gear when the engine is idling normally and when your right foot is firmly on the brake pedal.

- !** Only shift the automatic transmission into reverse gear **R** or park position **P** when the vehicle is stopped. Otherwise the automatic transmission could be damaged.
- ▶ Depress the brake pedal. The gear selector lever can now be used.
- ▶ Shift the automatic transmission into drive position **D** or reverse gear **R**.
- i** Shifting the automatic transmission out of park position **P** is only possible with the brake pedal depressed. Without the brake pedal depressed, the gear selector lever can be moved up or down. However, the parking pawl remains engaged, not allowing shifting to occur.

- ▶ Wait for the gear selection process to complete before setting the vehicle in motion.
  - ▶ Release the brake pedal.
  - ▶ Carefully depress the accelerator pedal. The electronic parking brake releases automatically.
- The red indicator lamp  (USA only) or  (Canada only) in the instrument cluster goes out.

After a cold start, the automatic transmission shifts at a higher engine speed. This allows the catalytic converter to reach its operating temperature earlier.

For more information on driving, see “Driving instructions” (▷ page 434).

### Problems while driving

#### The engine runs erratically and misfires

- An ignition cable may be damaged.
  - The engine electronics may not be operating properly.
  - Unburned gasoline may have entered the catalytic converter and damaged it.
- ▶ Give very little gas.
  - ▶ Have the problem checked at an authorized Mercedes-Benz Center as soon as possible.

#### The coolant temperature is above 248°F (120°C)

The coolant is too hot and is no longer cooling the engine.

- ▶ Stop the vehicle in a safe location as soon as possible.
- ▶ Turn off the engine immediately.
- ▶ Allow the engine and coolant to cool off.
- ▶ Check the coolant level and add coolant if necessary (▷ page 408).

### In case of accident

If the vehicle is leaking fuel:

- ▶ Do not start the engine under any circumstances.
- ▶ Exit the vehicle at a safe distance from the roadway.
- ▶ Notify local fire and/or police authorities.

If the extent of the damage cannot be determined:

- ▶ Contact an authorized Mercedes-Benz Center or call Roadside Assistance.

If no damage on major assemblies, fuel system, and engine mount can be determined:

- ▶ Start the engine in the usual manner.

### Parking

#### Warning!

Do not park in areas where the hot exhaust system could come into contact with combustible materials. Combustible materials such as grass, hay or leaves could be ignited and cause a vehicle fire.

Unintended vehicle movement could cause serious personal injury or damage to the vehicle or the vehicle drivetrain. To reduce such risks, always do the following before turning off the engine and leaving the vehicle:

- Keep right foot on the brake pedal.
- Engage the electronic parking brake.
- Shift the automatic transmission into park position **P**.
- Slowly release the brake pedal.
- When parked on an incline, always turn the front wheels towards the road curb.
- Turn the SmartKey in the starter switch to position **0** and remove the SmartKey from

the starter switch, or press the KEYLESS-GO start/stop button.

- Take the SmartKey with you and lock the vehicle when leaving.

## Electronic parking brake

### Warning!

When leaving the vehicle, always remove the SmartKey from the starter switch, take it with you, and lock the vehicle. Do not leave children unattended in the vehicle, or with access to an unlocked vehicle. Children could release the electronic parking brake and/or shift the automatic transmission out of park position **P**, either of which could result in an accident and/or serious personal injury.



### Releasing electronic parking brake manually

- ▶ Switch on the ignition.
- ▶ Pull handle ①.

The red indicator lamp **PARK** (USA only) or **(P)** (Canada only) in the instrument cluster goes out.

### Releasing electronic parking brake automatically

The electronic parking brake releases automatically when all of the following conditions are fulfilled:

- The engine is running.
- The automatic transmission is in drive position **D** or reverse gear **R**. With the

automatic transmission in reverse gear **R** the trunk lid must be closed.

- The hood is closed.
- You have fastened your seat belt.
- You depress on the accelerator pedal.

**i** If you have not fastened your seat belt, the following conditions must be met in order for the electronic parking brake to release automatically:

- The driver's door is closed and you shift the automatic transmission out of park position **P**.
- or
- The driver's door is closed and you drive faster than 2 mph (3 km/h).

### Engaging electronic parking brake manually

- ▶ Press handle ①.



The red indicator lamp **PARK** (USA only) or **(P)** (Canada only) in the instrument cluster comes on.

**i** You can engage the electronic parking brake even when the SmartKey is removed from the starter switch.

### Engaging electronic parking brake automatically

When at least one of the following conditions is met, the electronic parking brake engages automatically when the HOLD function (▷ page 342) or DISTRONIC PLUS (▷ page 330) has brought your vehicle to a standstill.

- The engine is turned off.
- The driver's door is opened and the seat belt is not inserted in the seat belt buckle.
- The hood lock is released.
- The trunk lid is opened while the automatic transmission is in reverse gear **R**.
- The vehicle is stationary for an extended period of time.

The red indicator lamp  (USA only) or  (Canada only) in the instrument cluster comes on.



- i** In addition to engaging the electronic parking brake, the automatic transmission may shift into park position **P** automatically.

### Emergency braking with electronic parking brake

In an emergency situation, you can also brake your vehicle by using the electronic parking brake.

- ▶ While driving, press handle . All four wheels of the vehicle will be braked for as long as you press and hold the handle for the electronic parking brake. The longer you keep the handle pressed, the stronger your vehicle will be braked.

During the braking procedure

- an acoustic warning sounds
- the message Please Release Parking Brake appears in the multifunction display
- the red indicator lamp for the electronic parking brake  (USA only) or  (Canada only) in the instrument cluster flashes

Once the vehicle comes to a complete stop, the electronic parking brake will engage automatically.

### Turning off the engine

#### **Warning!**

Do not turn off the engine before the vehicle has come to a complete stop. With the engine not running, there is no power assistance for the brake and steering systems. In this case, it is important to keep in mind that a considerably higher degree of effort is necessary to brake and steer the vehicle.

- i** If the engine cannot be turned off as described, see “Emergency engine shutdown” (▷ page 521).

- ▶ Shift the automatic transmission into park position **P**.

- i** Observe instructions if you want the automatic transmission to remain in neutral position **N**, see “Remaining in neutral position **N**” (▷ page 319).

### With SmartKey

- ▶ Turn the SmartKey in the starter switch to position **0**.
- ▶ Remove the SmartKey from the starter switch.

When you turn off the engine using the SmartKey, and remove the SmartKey from the starter switch or open a front door, the automatic transmission will shift into park position **P** automatically.

#### **Warning!** تلفن نشه زورن

Keep in mind that turning off the engine alone only will shift the automatic transmission into neutral position **N** automatically.

Always shift the automatic transmission into park position **P** before turning off the engine.

Otherwise the vehicle could roll away which could result in an accident and/or serious personal injury.

### With KEYLESS-GO

- ▶ Press the KEYLESS-GO start/stop button. With the driver's door closed, the starter switch is now in position **1**. With the driver's door opened, the starter switch is set to position **0**, same as the SmartKey removed from the starter switch (▷ page 284).

When you turn off the engine using the KEYLESS-GO start/stop button and open a front door, the automatic transmission will shift into park position **P** automatically.

**⚠ Warning!**

Keep in mind that turning off the engine alone only will shift the automatic transmission into neutral position **N** automatically.

Always shift the automatic transmission into park position **P** before turning off the engine.

Otherwise the vehicle could roll away which could result in an accident and/or serious personal injury.

- i** In an emergency you can turn off the engine while driving by pressing and holding the KEYLESS-GO start/stop button for approximately 3 seconds.

If you have started the engine with the KEYLESS-GO start/stop button and cannot turn it off as described above:

- ▶ Remove the KEYLESS-GO start/stop button from the starter switch.
- ▶ Insert the SmartKey into the starter switch. The engine turns off. The starter switch is in position **0** (▷ page 284).

**Automatic transmission****Introduction**

For information on driving with an automatic transmission, see “Driving and parking” (▷ page 311).

**⚠ Warning!**

Make sure absolutely no objects are obstructing the pedals’ range of movement. Keep the driver’s footwell clear of all obstacles. If there are any floor mats or carpets in the footwell, make sure the pedals still have sufficient clearance.

During sudden driving or braking maneuvers the objects could get caught between or under the pedals. You could then no longer brake or accelerate. This could lead to accidents and injury.

**⚠ Warning!**

HYBRID vehicles: It is imperative that you read the HYBRID Supplemental Operating Instructions included in your vehicle literature portfolio. You may otherwise not receive all necessary safety information and warning for the operation of your vehicle.

- !** Allow the engine to warm up under low load use. Do not place full load on the engine until the operating temperature has been reached.

Avoid spinning of a drive wheel for an extended period when driving on slippery road surfaces.

This may cause serious damage to the engine and the drivetrain which is not covered by the Mercedes-Benz Limited Warranty.

- i** During the brief warm-up, transmission upshifting is delayed. This allows the catalytic converter to heat up more quickly to operating temperature.

**Gear selector lever**

Gearshift pattern for automatic transmission

- 1** Button for selecting park position **P**
- P** Park position
- R** Reverse gear
- N** Neutral position
- D** Drive position

### **Warning!**

It is dangerous to shift the automatic transmission out of park position **P** or neutral position **N** if the engine speed is higher than idle speed. If your foot is not firmly on the brake pedal, the vehicle could accelerate quickly forward or in reverse. You could lose control of the vehicle and hit someone or something. Only shift into gear when the engine is idling normally and when your right foot is firmly on the brake pedal.

**!** The vehicle must be stopped when you shift the automatic transmission

- directly between drive position **D** and reverse gear **R**
- directly between reverse gear **R** and drive position **D**
- directly into park position **P**

Otherwise the automatic transmission could be damaged.

When trying to free a vehicle stuck in mud or snow, see “Rocking the vehicle” (▷ page 321).

**i** Shifting the automatic transmission out of park position **P** is only possible with the brake pedal depressed.

Without the brake pedal depressed, the gear selector lever can be moved up or down, but the parking pawl remains engaged, not allowing shifting to occur.

**i** Depending on vehicle production date: The automatic transmission will shift into park position **P** automatically when

- you open the driver’s door while driving at low speed, and
- the automatic transmission is in drive position **D** or reverse gear **R**

After the vehicle has engaged park position **P** automatically, you can engage drive position **D** or reverse gear **R** again to override this locking feature purposely.

**i** The gear selector lever always returns to its original position.

The current transmission position **P**, **R**, **N**, or **D** appears in the multifunction display (▷ page 320).

### **Shifting into park position P**

► With the vehicle at a standstill, press button  on the gear selector lever.

SmartKey: When you turn off the engine using the SmartKey, and remove the SmartKey from the starter switch or open a front door, the automatic transmission will shift into park position **P** automatically.

KEYLESS-GO: When you turn off the engine using the KEYLESS-GO start/stop button and open a front door, the automatic transmission will shift into park position **P** automatically.

### **Warning!**

Keep in mind that turning off the engine alone only will shift the automatic transmission into neutral position **N** automatically.

Always shift the automatic transmission into park position **P** before turning off the engine.

Otherwise the vehicle could roll away which could result in an accident and/or serious personal injury.

**i** Moving the gear selector lever up or down shifts the automatic transmission out of park position **P**.

HOLD function or DISTRONIC PLUS:

The automatic transmission will shift into park position **P** automatically when HOLD function or DISTRONIC PLUS brings your vehicle to standstill. In addition, at least one of the following conditions must be met:

- The engine is turned off.
- The driver’s door is opened and the seat belt is not inserted in the seat belt buckle.

In addition to shifting into park position **P**, the electronic parking brake will engage automatically.

### Shifting into neutral position N

- ▶ With the vehicle at a standstill, depress the brake pedal.
- ▶ Move the gear selector lever up or down to the resistance point to select neutral position **N**.

When you turn off the engine, the automatic transmission will shift into neutral position **N** automatically.

SmartKey: Removing the SmartKey from the starter switch or opening a front door after turning off the engine will shift the automatic transmission into park position **P** automatically.

KEYLESS-GO: Opening a front door after turning off the engine will shift the automatic transmission into park position **P** automatically.

### Remaining in neutral position N

If you want the automatic transmission to remain in neutral position **N**, e.g. when taking the vehicle through an automatic conveyor-type car wash, observe the following instructions.

#### Warning!

When leaving the SmartKey in the starter switch, do not leave children unattended in the vehicle. It is possible for children to switch on the ignition which could result in unsupervised use of vehicle equipment. Unsupervised use of vehicle equipment could result in an accident and/or serious personal injury.

With SmartKey:

- ▶ Make sure the ignition is switched on.
- ▶ With the vehicle at a standstill, depress the brake pedal and keep it pressed.
- ▶ Shift the automatic transmission into neutral position **N**.
- ▶ Release the brake pedal.

- ▶ If engaged release the electronic parking brake manually.
- ▶ Switch off the ignition and leave the SmartKey in the starter switch.

With KEYLESS-GO:

- ▶ Make sure the ignition is switched on.
- ▶ With the vehicle at a standstill, depress the brake pedal and keep it pressed.
- ▶ Shift the automatic transmission into park position **P**.
- ▶ Release the brake pedal.
- ▶ Remove the KEYLESS-GO start/stop button from the starter switch.
- ▶ Insert the SmartKey into the starter switch.
- ▶ Switch on the ignition.
- ▶ Depress the brake pedal and keep it pressed.
- ▶ Shift the automatic transmission into neutral position **N**.
- ▶ Release the brake pedal.
- ▶ If engaged release the electronic parking brake manually.
- ▶ Switch off the ignition and leave the SmartKey in the starter switch.

### Shifting into reverse gear R

- ▶ With the vehicle at a standstill, depress the brake pedal.
- ▶ Move the gear selector lever up past the resistance point.

### Shifting into drive position D

- ▶ With the vehicle at a standstill, depress the brake pedal.
- ▶ Move the gear selector lever down past the resistance point.

#### Shifting procedure

The automatic transmission selects individual gears automatically, depending on



- the selected gear range (▷ page 321)
- the selected program mode:  
**C/S** (▷ page 322)  
or  
**M** (AMG vehicles only) (▷ page 324)
- the position of the accelerator pedal
- the vehicle speed

With drive position **D** selected, you can influence transmission shifting by

- limiting the gear range
- extending the gear range
- changing the gears manually (AMG vehicles only)

### Transmission positions

The current transmission position appears in the multifunction display.

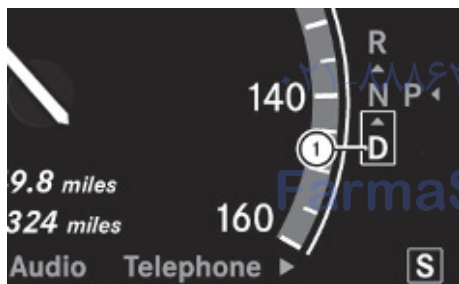

#### ① Transmission position indicator

If the current transmission position does not appear in the multifunction display due to a malfunction, for example, make sure that the automatic transmission is in the desired position.

- ▶ Shift the automatic transmission into drive position **D**.
- ▶ Select automatic program mode **S**.
- ▶ Do not limit the gear range.
- ▶ Drive off carefully.

### Effect

#### **P** Park position

Shift the automatic transmission into park position **P** only when the vehicle is stopped. The park position is not intended to serve as a brake when the vehicle is parked. Rather, the driver should always engage the electronic parking brake in addition to shifting the automatic transmission into park position **P** to secure the vehicle.

If the vehicle's electrical system is malfunctioning, the automatic transmission could remain locked in park position **P**.

- ▶ Have the vehicle's electrical system checked at an authorized Mercedes-Benz Center as soon as possible.

#### **R** Reverse gear

Shift the automatic transmission into reverse gear **R** only when the vehicle is stopped.

**Effect****N Neutral position**

No power is transmitted from the engine to the drive axle. When the brakes are released, the vehicle can be moved freely (pushed or towed).

To avoid damage to the transmission, never shift the automatic transmission into neutral position **N** while driving.

Exception: If the ESC is switched off or malfunctioning, shift the automatic transmission into neutral position **N** if the vehicle is in danger of skidding.

**!** Coasting the vehicle, or driving for any other reason with the automatic transmission in neutral position **N** can result in transmission damage that is not covered by the Mercedes-Benz Limited Warranty.

**D Drive position**

The automatic transmission shifts automatically. All forward gears are available.

**Driving tips****Kickdown**

Use the kickdown when you want maximum acceleration.

- ▶ **U.S. vehicles except AMG vehicles:**  
Fully depress the accelerator pedal. Depending on the engine speed the automatic transmission shifts into a lower gear.
- ▶ **Canada vehicles and AMG vehicles:**  
Depress the accelerator pedal past the point of resistance. Depending on the engine speed the automatic transmission shifts into a lower gear.

**Rocking the vehicle**

Rocking the vehicle by shifting the automatic transmission directly between drive position **D** and reverse gear **R** can help free a vehicle stuck in mud or snow. The engine control system of this vehicle electronically limits directly shifting the automatic transmission between drive position **D** and reverse gear **R** to very low speeds, i.e. approximately 5 mph (9 km/h). To shift the automatic transmission directly between drive position **D** and reverse gear **R**, move the gear selector lever up or down past the resistance point.

**Working on the vehicle****Warning!**

When working on the vehicle, engage the electronic parking brake and shift the automatic transmission into park position **P**. Otherwise the vehicle could roll away which could result in an accident and/or serious personal injury.

**Gear ranges**

With the automatic transmission in drive position **D** and driving in automatic program mode **C** or **S**, you can limit or extend the gear range, see “One-touch gearshifting” (▷ page 323).

The current gear range appears in the multifunction display.

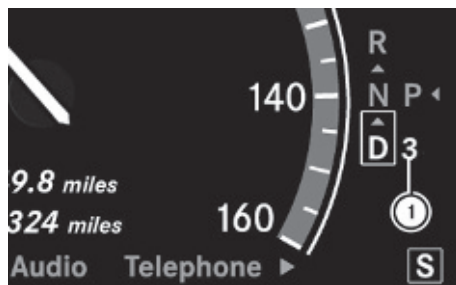

P54.32-7032-31

- ① Gear range indicator

**Effect**

- |          |  |
|----------|--|
| <b>3</b> | With this selection you can use the braking effect of the engine.  |
| <b>2</b> | Allows the use of the engine's braking effect when driving <ul style="list-style-type: none"> <li>• on steep downgrades</li> <li>• in mountainous regions</li> <li>• under extreme operating conditions</li> </ul> |
| <b>1</b> | For maximum use of the engine's braking effect on very steep or lengthy downgrades.  |

**Automatic shift program**

The program mode selector switch is used to adjust

- the shift program
- the suspension tuning of the AIRMATIC or the ABC system
- the engine control

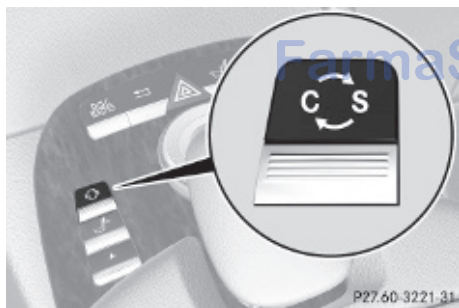

Program mode selector switch

<b>C</b> Comfort	For comfort driving
<b>S</b> Sport	For sporty driving



Program mode selector switch on AMG vehicles

<b>C</b> Comfort	For standard driving
<b>S</b> Sport	For sporty driving
<b>M</b> Manual	For manual gearshifting

The current program mode appears in the multifunction display.



① Program mode indicator

You should only change the program mode when the automatic transmission is in park position **P**.

The last selected automatic program mode (**C** or **S**) is active when the engine is restarted.

- ▶ Press the program mode selector switch repeatedly until the letter of the desired program mode appears in the multifunction display.

Selecting program mode **C** means:

- The vehicle starts out more gentle, both forward and reverse, except when driving off with full throttle.
- Traction and driving stability are improved on icy roads.
- Upshifts occur earlier even when you give more gas. The engine then operates at lower revolutions and the wheels are less likely to spin.

Selecting program mode **S** means that upshifts occur later.

### One-touch gearshifting

With the automatic transmission in drive position **D** and driving in automatic program mode **C** or **S**, you can limit or extend the gear range using the steering wheel gearshift control.

AMG vehicles: For information on using the steering wheel gearshift control in manual program mode **M**, see “Manual shift program” (> page 324).



Steering wheel gearshift control (example illustration)

- i** You cannot shift with the steering wheel gearshift control when the automatic transmission is in park position **P**, neutral position **N**, or reverse gear **R**.

### Limiting gear range

#### **⚠ Warning!**

On slippery road surfaces, never downshift in order to obtain braking action. This could result in drive wheel slip and reduced vehicle control. Your vehicle's ABS will not prevent this type of loss of control.

- ▶ Briefly pull left gearshift control ①. The automatic transmission will shift into the next lower gear as permitted by the shift program. This action simultaneously limits the gear range of the automatic transmission.

- i** To avoid overrevving the engine when downshifting, the automatic transmission will not shift into a lower gear if the engine's maximum speed would be exceeded.

### Extending gear range

- ▶ Briefly pull right gearshift control ②. The automatic transmission will shift into the next higher gear as permitted by the shift program. This action simultaneously extends the gear range of the automatic transmission.

- i** If you press on the accelerator pedal when the engine has reached the revolution limit of the current gear range, the automatic transmission will upshift beyond any gear range limit selected.

### Canceling gear range limit

- ▶ Pull and hold right gearshift control ② until the gear range indicator disappears from the multifunction display. The automatic transmission will shift from the current gear range directly into drive position **D**.

## Shifting into optimal gear range

- ▶ Pull and hold left gearshift control ①.  
The automatic transmission will select the gear range suited for optimal acceleration and deceleration automatically. This will involve shifting down one or more gears.

## Manual shift program

The manual shift program is available on AMG vehicles only.

Manual program mode **M** differs with regard to spontaneity, response time, and shifting smoothness from automatic program mode **S**.

In manual program mode **M**, system-controlled automatic gearshifting is switched off. You need to change the gears by manually upshifting or downshifting using the steering wheel gearshift control.



Program mode selector switch on AMG vehicles

<b>C</b> Comfort	For standard driving
<b>S</b> Sport	For sporty driving
<b>M</b> Manual	For manual gearshifting

The current program mode appears in the multifunction display (▷ page 322).  
For information on automatic program mode (**C** or **S**), see “Automatic shift program” (▷ page 322) and “One-touch gearshifting” (▷ page 323).

## Activating manual shift program

- ▶ Press the program mode selector switch repeatedly until **M** appears in the multifunction display.  
The automatic transmission switches to manual program mode **M**. Automatic shifting is switched off. The gear range is not limited.

You can change the gears manually with drive position **D** selected. You can upshift or downshift through the gears in succession.

- ① Manual program mode **M** will not be stored. When the engine is turned off with manual program mode **M** selected, the automatic transmission will go to automatic program mode (**C** or **S**) when the engine is restarted.

## Upshifting

- ① In manual program mode **M**, the automatic transmission will not upshift, even if the engine has reached its overrevving range. Shift up into the next gear before the engine has reached its overrevving range. Make absolutely certain that the engine speed does not reach the red marking on the tachometer. Otherwise the engine could be damaged which is not covered by the Mercedes-Benz Limited Warranty.

- ▶ Briefly pull right gearshift control ② (▷ page 323).  
The automatic transmission shifts into the next higher gear.

## Upshift indicator

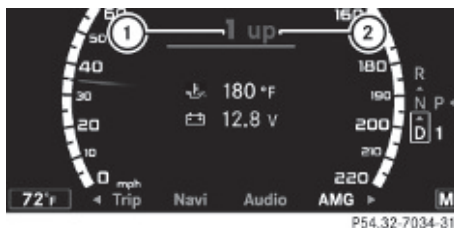

In manual program mode **M**, upshift indicator ② in the multifunction display advises you to upshift before the engine reaches the overspeed range. Thus you can drive at the maximum engine speed for each gear without overrevving the engine.

- ▶ Shift the automatic transmission from current gear ① into the next higher gear. The fuel supply will otherwise be interrupted to prevent the engine from overrevving.

### Downshifting

#### **Warning!**

On slippery road surfaces, never downshift in order to obtain braking action. This could result in drive wheel slip and reduced vehicle control. Your vehicle's ABS will not prevent this type of loss of control.

- ▶ Briefly pull left gearshift control ① (▷ page 323). The automatic transmission shifts into the next lower gear.
- i** For maximum acceleration, pull and hold the left gearshift control. Depending on the engine speed the automatic transmission selects the optimal gear for maximum acceleration.
- i** When you brake or stop, the automatic transmission shifts down into a gear from which you can easily accelerate or take off.

### Kickdown

Using the kickdown while driving in manual program mode **M** is not possible.

### Deactivating manual shift program

- ▶ Press the program mode selector switch repeatedly until **C** or **S** appears in the multifunction display.

or

- ▶ Restart the engine. The automatic transmission will go to automatic program mode **C**.

Manual program mode **M** is not stored.

### Emergency operation (limp-home mode)

If vehicle acceleration becomes less responsive or sluggish or the automatic transmission no longer shifts, the automatic transmission is most likely operating in limp-home (emergency operation) mode. In this mode only second gear and reverse gear **R** can be selected.

- ▶ Stop the vehicle in a safe location.
- ▶ Shift the automatic transmission into park position **P**.
- ▶ Turn off the engine.
- ▶ Wait at least 10 seconds before restarting.
- ▶ Restart the engine.
- ▶ Shift the automatic transmission into drive position **D** (for second gear) or reverse gear **R**.
- ▶ Have the automatic transmission checked at an authorized Mercedes-Benz Center as soon as possible.

### Transfer case

This section applies to vehicles equipped with all-wheel drive (4MATIC) only. Both the front and rear axles are powered at all times when the vehicle is being operated.

- !** Only conduct operational or performance tests on a two-axle dynamometer. If such tests are necessary, contact an authorized Mercedes-Benz Center. You could

otherwise seriously damage the brake system or the transfer case which is not covered by the Mercedes-Benz Limited Warranty.

**!** Because the ESC operates automatically, the engine and ignition must be shut off (SmartKey in starter switch position **0** or **1** or KEYLESS-GO start/stop button in position **0** or **1**) when the electronic parking brake is being tested on a brake test dynamometer or when the vehicle is being towed with one axle raised.

Active braking action through the ESC may otherwise seriously damage the brake system which is not covered by the Mercedes-Benz Limited Warranty.

## Instrument cluster

### Introduction

For a full view illustration of the instrument cluster, see "Instrument cluster" (▷ page 32).

### **Warning!**

No messages will be displayed if either the instrument cluster or the multifunction display is inoperative.

As a result, you will not be able to see information about your driving conditions, such as

- speed
- outside temperature
- warning/indicator lamps
- malfunction/warning messages
- failure of any systems

Driving characteristics may be impaired.

If you must continue to drive, do so with added caution. Contact an authorized Mercedes-Benz Center as soon as possible.

### **Warning!**

HYBRID vehicles: It is imperative that you read the HYBRID Supplemental Operating Instructions included in your vehicle literature portfolio. You may otherwise not receive all necessary safety information and warning for the operation of your vehicle.

The language setting for the multifunction display can be changed via COMAND (▷ page 94).

### Activating the instrument cluster

The instrument cluster is activated when you

- open a door
- switch on the ignition
- switch on the exterior lamps

### Adjusting the instrument cluster illumination



- ▶ **To brighten illumination:** Turn knob ① clockwise.
- ▶ **To dim illumination:** Turn knob ① counterclockwise.

**i** The instrument cluster illumination is dimmed or brightened automatically to suit ambient light conditions.

The instrument cluster illumination will also be adjusted automatically when you switch on the vehicle's exterior lamps.



### Coolant temperature gauge

The coolant temperature gauge is located on the left side in the instrument cluster (▷ page 32).

#### Warning!

Driving when your engine is overheated can cause some fluids which may have leaked into the engine compartment to catch fire. You could be seriously burned.

Steam from an overheated engine can cause serious burns which can occur just by opening the engine hood. Stay away from the engine if you see or hear steam coming from it.

Stop the vehicle in a safe location away from other traffic. Turn off the engine, get out of the vehicle and do not stand near the vehicle until the engine has cooled down.

During severe operating conditions, e.g. stop-and-go traffic, the coolant temperature may rise close to 248°F (120°C), i.e. close to the red zone of the temperature gauge.

**!** Excessive coolant temperature triggers a warning in the multifunction display.

The engine should not be operated with a coolant temperature above 248°F (120°C), i.e. in the red zone of the coolant temperature gauge. Doing so may cause serious engine damage which is not covered by the Mercedes-Benz Limited Warranty.

### Tachometer

The red marking on the tachometer (▷ page 32) denotes excessive engine speed.

**!** Avoid driving at excessive engine speeds, as it may result in serious engine damage that is not covered by the Mercedes-Benz Limited Warranty.

To help protect the engine, the fuel supply is interrupted if the engine is operated within the red marking.

### Outside temperature indicator

The outside temperature indicator is on the bottom left-hand side of the instrument cluster (▷ page 32).

#### Warning!

The outside temperature indicator is not designed to serve as an ice-warning device and is therefore unsuitable for that purpose.

Indicated temperatures just above the freezing point do not guarantee that the road surface is free of ice. The road may still be icy, especially in wooded areas or on bridges.

### Fuel gauge

The fuel gauge is on the left-hand side of the instrument cluster (▷ page 32). Once the fuel level has fallen below the reserve mark, the yellow segment indicator for the fuel reserve comes on.

## Driving systems

### Introduction

This section describes the following driving systems of your vehicle:

- Cruise control
- DISTRONIC PLUS
- Hill-start assist system
- HOLD function
- AIRMATIC
- Active Body Control (ABC)
- All-wheel drive (4MATIC)
- Parktronic system with Parking Guidance
- Rear view camera
- Night View Assist Plus
- ATTENTION ASSIST
- Blind Spot Assist
- Lane Keeping Assist

The driving safety systems ABS, Adaptive Brake, Adaptive Brake Lights, BAS, BAS PLUS, EBP, ESC and PRE-SAFE® Brake are described in the “Safety and security” section (▷ page 63).

### Cruise control

The cruise control maintains the speed you set for your vehicle automatically.

The use of the cruise control is recommended for driving at a constant speed for extended periods of time.

The currently set speed or last set speed (“Resume” function) appears in the multifunction display for approximately 5 seconds. The set speed is shown by a triangle in the speedometer and the corresponding speedometer segments from the selected speed to the vehicle maximum speed in the multifunction display are illuminated.

#### ⚠ Warning!

The cruise control is a convenience system designed to assist the driver during vehicle operation. The driver is and must always remain responsible for the vehicle’s speed and for safe brake operation.

Only use the cruise control if the road, traffic, and weather conditions make it advisable to travel at a constant speed.

- The use of the cruise control can be dangerous on winding roads or in heavy traffic because conditions do not allow safe driving at a constant speed.
- The use of the cruise control can be dangerous on slippery roads. Rapid changes in tire traction can result in wheel spin and loss of control.
- Deactivate the cruise control when driving in fog.

The “Resume” function should only be operated if the driver is fully aware of the

previously set speed and wishes to resume this particular preset speed.

#### ⚠ Warning!

When the cruise control is braking, the brake pedal is retracted (i.e. depressed automatically). The pedals’ range of motion must not be impeded by any obstacles:

- Do not place any objects in the footwell.
- Make sure that the floor mats and carpets are securely in place.
- Do not rest your foot underneath the brake pedal, as it could otherwise be trapped.

You could otherwise cause an accident and injure yourself and/or others.

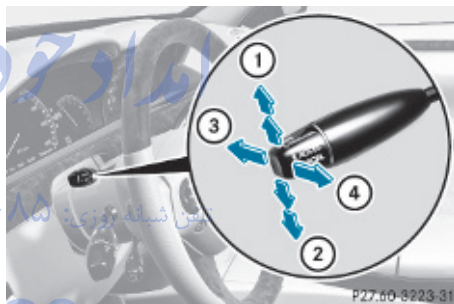

- ① Setting current or higher speed
- ② Setting current or lower speed
- ③ Canceling the cruise control
- ④ Activating the cruise control or resuming to last set speed

### Activating cruise control

You can activate the cruise control at a vehicle speed above 20 mph (30 km/h).

You cannot activate the cruise control

- when you brake
- when you have engaged the electronic parking brake

- when the automatic transmission is in park position **P**, reverse gear **R**, or neutral position **N**
- the ESC is switched off or has switched off due to a malfunction

The vehicle speed displayed in the speedometer can briefly vary from the speed setting for the cruise control system.

### Setting current speed

- ▶ Accelerate or decelerate to the desired speed.
  - ▶ Briefly lift the cruise control lever in direction of arrow ① or press in direction of arrow ②.
  - ▶ Remove your foot from the accelerator pedal.
- i** On uphill grades, the cruise control may not be able to maintain the set speed. Once the grade eases, the set speed will be resumed.

On downhill grades, the cruise control maintains the set speed by braking with the vehicle's brake system. In addition, on longer downhill grades the automatic transmission will downshift automatically.

### Canceling cruise control

- ▶ Depress the brake pedal.
- or
- ▶ Briefly push the cruise control lever in direction of arrow ③.

The last set speed is stored for later use.

The last stored speed is deleted from memory when the engine is turned off.

The cruise control switches off automatically when you depress the brake pedal or you engage the electronic parking brake. In this case, the speedometer segments in the multifunction display will go out.

The cruise control also switches off automatically when

- the vehicle speed falls below 20 mph (30 km/h)
- the ESC is in operation
- the ESC is switched off via the control system
- the ESC has switched off due to a malfunction
- you shift the automatic transmission into neutral position **N** while driving

The speedometer segments in the multifunction display go out and an acoustic warning will sound. Observe additional messages in the multifunction display that may appear.

Depressing the accelerator pedal does not deactivate the cruise control. After a brief acceleration (e.g. for passing), the cruise control will resume the last set speed.

### Changing the set speed

#### **Warning!**

Keep in mind that it may take a brief moment until the vehicle has made the necessary adjustments.

Increase or decrease the set vehicle speed to a value that the prevailing road conditions and legal speed limits permit. Otherwise, sudden and unexpected acceleration or deceleration of the vehicle could cause an accident and/or serious injury to you and others.

You can increase or decrease the set speed in 1 mph (Canada: 1 km/h) increments or in 5 mph (Canada: 10 km/h) increments.

When you use the cruise control lever to decelerate, the brake system will brake the vehicle automatically if the engine's braking power does not brake the vehicle sufficiently.

### Adjustment in 1 mph (Canada: 1 km/h) increments

- i** The set speed value is increased or decreased in 1 mph (Canada: 1 km/h) increments each time you lift or press the cruise control lever up or down to the resistance point.
- ▶ **Increasing:** Briefly lift the cruise control lever up to the resistance point in direction of arrow ①.
- ▶ **Decreasing:** Briefly press the cruise control lever down to the resistance point in direction of arrow ②.
- ▶ Release the cruise control lever. The new speed is set and the vehicle will accelerate or decelerate.

### Adjustment in 5 mph (Canada: 10 km/h) increments

- i** The set speed value is increased or decreased in 5 mph (Canada: 10 km/h) increments each time you lift or press the cruise control lever up or down past the resistance point.
- ▶ **Increasing:** Briefly lift the cruise control lever up past the resistance point in direction of arrow ①.
- ▶ **Decreasing:** Briefly press the cruise control lever down past the resistance point in direction of arrow ②.
- ▶ Release the cruise control lever. The new speed is set and the vehicle will accelerate or decelerate. Keep in mind that it may take a brief moment until the vehicle has reached the set speed.

### Setting stored speed (Resume function)

#### **Warning!**

The set speed stored in memory should only be set again if prevailing road conditions and legal speed limits permit. Possible acceleration or deceleration differences

arising from returning to the preset speed could cause an accident and/or serious injury to you and others.

- ▶ Briefly pull the cruise control lever in direction of arrow ④.
- ▶ If no speed is stored, the current speed is set and stored.
- ▶ Remove your foot from the accelerator pedal.

The last stored speed is deleted from memory when the engine is turned off.

## DISTRONIC PLUS

### Safety notes

When activated, the DISTRONIC PLUS adaptive cruise control system increases the driving convenience afforded by the cruise control while traveling on expressways and other major roadways.

- If the DISTRONIC PLUS distance sensor detects a slower moving vehicle directly ahead, your vehicle speed will be reduced so that you follow that vehicle at your preset following distance.
- If there is no vehicle directly ahead of you, the DISTRONIC PLUS will function in the same way as standard cruise control (▷ page 328).

#### **Warning!**

The DISTRONIC PLUS requires familiarity with its operational characteristics. We strongly recommend that you review the following information carefully before operating the system.

#### **Warning!**

HYBRID vehicles: It is imperative that you read the HYBRID Supplemental Operating Instructions included in your vehicle literature portfolio. You may otherwise not receive all necessary safety information and warning for the operation of your vehicle.

**⚠ Warning!**

When the DISTRONIC PLUS is braking, the brake pedal is retracted (i.e. depressed automatically). The pedals' range of motion must not be impeded by any obstacles:

- Do not place any objects in the footwell.
- Make sure that the floor mats and carpets are securely in place.
- Do not rest your foot underneath the brake pedal, as it could otherwise be trapped.

You could otherwise cause an accident and injure yourself and/or others.

**⚠ Warning!**

The DISTRONIC PLUS is a convenience system. Its speed adjustment reduction capability is intended to make cruise control more effective and usable when traffic speeds vary. It is not however, intended to, nor does it, replace the need for extreme care.

The responsibility for the vehicle's speed, distance to the preceding vehicle and, most importantly, brake operation to ensure a safe stopping distance, always remains with the driver.

The DISTRONIC PLUS cannot take street and traffic conditions into account.

Complex driving situations are not always fully recognized by the DISTRONIC PLUS. This could result in wrong or missing distance warnings.

**⚠ Warning!**

The DISTRONIC PLUS adaptive cruise control is not a substitute for active driving involvement. It does not react to pedestrians or on stationary objects, nor does it recognize or predict the curvature and lane layout or the movement of preceding vehicles. The DISTRONIC PLUS can only apply a maximum of 40% of the vehicle's braking power.

The DISTRONIC PLUS may not detect narrow vehicles possibly driving in front of you, such

as motorcycles and vehicles driving in an offset formation.

It is the driver's responsibility at all times to be attentive to the road, weather and traffic conditions. Additionally, the driver must provide the steering, braking and other driving inputs necessary to remain in control of the vehicle.

High-frequency sources such as toll stations, speed measuring systems etc. can cause the DISTRONIC PLUS system to temporarily cease functioning.

**⚠ Warning!**

The DISTRONIC PLUS cannot take road and traffic conditions into account. Only use the DISTRONIC PLUS if the road, weather and traffic conditions make it advisable to travel at a constant speed.

**⚠ Warning!**

Use of the DISTRONIC PLUS can be dangerous on slippery roads. Rapid changes in tire traction can result in wheel spin and loss of control.

The DISTRONIC PLUS does not function in adverse sight and distance conditions. Do not use the DISTRONIC PLUS during conditions of fog, heavy rain, snow or sleet.

**⚠ Warning!**

The DISTRONIC PLUS cannot take weather conditions into account. Switch off the DISTRONIC PLUS or do not switch it on if:

- roads are slippery or covered with snow or ice. The wheels could lose traction while braking or accelerating, and the vehicle could skid.
- the DISTRONIC PLUS system sensor covers are dirty or visibility is diminished due to snow, rain or fog, for example. The distance control system functionality could be impaired.

Always pay attention to surrounding traffic conditions even while the DISTRONIC PLUS is

switched on. Otherwise, you may not be able to recognize dangerous situations until it is too late. This could cause an accident in which you and/or others could be injured.

#### **Warning!**

The “Resume” function should only be operated if the driver is fully aware of the previously set speed and wishes to resume this particular preset speed.

#### **Warning!**

Close attention to road and traffic conditions is imperative at all times, regardless of whether or not the DISTRONIC PLUS is activated.

Use of the DISTRONIC PLUS can be dangerous on winding roads or in heavy traffic because conditions do not allow safe driving at a constant speed.

The DISTRONIC PLUS will not react to stationary objects in the roadway (e.g. a stopped vehicle in a traffic jam or a disabled vehicle). The DISTRONIC PLUS will also not respond to oncoming vehicles.

Switch off the DISTRONIC PLUS:

- when changing from the left to the right lane if vehicles are moving more slowly in the left lane
- when entering a turn lane or highway off ramp
- in complex driving situations, such as in highway construction zones

In these situations, the DISTRONIC PLUS will continue to maintain the set speed unless deactivated.

The DISTRONIC PLUS is designed and intended only to maintain a set speed and keep a set distance from moving objects in front of it.

The DISTRONIC PLUS functions in a speed range of 0 to 120 mph (Canada: 0 to 200 km/h) if a preceding vehicle is detected. If no preceding vehicle is detected the DISTRONIC PLUS functions in a

speed range of 20 to 120 mph (Canada: 30 to 200 km/h).

Always obey applicable speed limits.

Do not use the DISTRONIC PLUS if you are driving on a road with steep uphill or downhill slopes.

When traveling in Canada in a vehicle not registered in Canada, you must switch off the radar sensor system (▷ page 236). Canadian law does not permit the use of the radar sensor system for vehicles from outside of Canada. When you switch off the radar sensor system, the following functions are deactivated:

- DISTRONIC PLUS
- BAS PLUS (▷ page 64)
- PRE-SAFE® Brake (▷ page 69)
- Blind Spot Assist (▷ page 359)

 Due to its radar-emitting nature DISTRONIC PLUS may have an appearance similar to a radar detector to law enforcement officials. You may want to refer to this section of your Operator’s Manual when asked.

 **USA only:**

This device has been approved by the FCC as a “Vehicular Radar System”. The radar sensor is intended for use in an automotive radar system only. Removal, tampering, or altering of the device will void any warranties, and is not permitted by the FCC. Do not tamper with, alter, or use in any non-approved way.

Any unauthorized modification to this device could void the user’s authority to operate the equipment.

**i** Canada only:

This device complies with RSS-210 of Industry Canada. Operation is subject to the following two conditions:

1. This device may not cause interference, and
2. this device must accept any interference received, including interference that may cause undesired operation of the device.

Removal, tampering, or altering of the device will void any warranties, and is not permitted. Do not tamper with, alter, or use in any non-approved way.

Any unauthorized modification to this device could void the user's authority to operate the equipment.

### DISTRONIC PLUS displays in multifunction display



- ① Speed of the vehicle ahead
- ② Marker
- ③ Distance warning lamp

If the DISTRONIC PLUS is activated, marker ② indicates the set speed.

The vehicle speed displayed on the speedometer can briefly vary from the speed setting on the DISTRONIC PLUS system.

If the DISTRONIC PLUS detects a vehicle directly ahead, the ring on the speedometer dial comes on between the speed of the vehicle ahead ① and the set speed.

If the DISTRONIC PLUS calculates that there is a danger of collision, the distance warning lamp  in the instrument cluster comes on and an intermittent warning sounds.

- Immediately apply the brake to avoid a collision.

Under no circumstances should the driver await the intermittent warning sound before braking. See the following warning note.

The intermittent warning sound ceases and the distance warning lamp  goes out when the necessary distance to the vehicle ahead is again established.

#### Warning!

An intermittent warning sounds and the distance warning lamp  in the instrument cluster is illuminated if the DISTRONIC PLUS system calculates that the distance to the vehicle ahead and your vehicle's current speed indicate that the DISTRONIC PLUS will not be capable of slowing the vehicle sufficiently to maintain the preset following distance, which creates a danger of a collision.

Immediately brake the vehicle to increase your distance to the preceding vehicle. The warning sound is intended as a final caution in which you should intercede with your own braking inputs to avoid a potentially dangerous situation. Do not wait for the operation of the warning signal to intercede with your own braking. This will result in potentially dangerous emergency braking which will not always result in an impact being avoided.

Tailgating increases the risk of an accident.

#### Warning!

The DISTRONIC PLUS brakes your vehicle with a maximum deceleration of 13 ft/s<sup>2</sup> (4 m/s<sup>2</sup>). This corresponds to approximately 40% of the maximum deceleration of your vehicle.



You must also apply the brakes yourself to avoid a collision. The DISTRONIC PLUS brakes the vehicle in an effort to restore the preset distance or to maintain the set speed. The brake pedal is automatically applied as this happens which results in the brake pedal moving

Keep driver's foot area clear at all times, including the area under the brake pedal. Objects stored in this area may impair pedal movement which could interfere with the braking ability of the DISTRONIC PLUS system.

Do not place your foot under the brake pedal – your foot could become caught.

### Warning!

If you do not receive visual or acoustic warning signals during a critical traffic situation, DISTRONIC PLUS has either not recognized the collision risk, has been deactivated or is malfunctioning.

Remember, whether or not DISTRONIC PLUS is operating, it is ultimately always the drivers responsibility to apply the brakes in order to control the vehicle and avoid a collision.

## Displaying the distance graphic

In the DriveAssist menu under Distance Display you see the current settings for DISTRONIC PLUS. The Information shown in the multifunction display depends on whether DISTRONIC PLUS is activated or deactivated. For activating or deactivating the DISTRONIC PLUS system, see “Activating DISTRONIC PLUS” (▷ page 335) or “Deactivating DISTRONIC PLUS” (▷ page 338).

The menu overview can be found on (▷ page 222).

▶ Press  or  to select the DriveAssist menu.

▶ Press  or  to select the Distance Display function.

▶ Press .

The DISTRONIC PLUS distance graphic appears and you will see one of the following displays in the multifunction display.

## DISTRONIC PLUS activated

If you switch on the DISTRONIC PLUS, you will see the set speed in the multifunction display for approximately 5 seconds. When the DISTRONIC PLUS is activated the following display appears in the multifunction display.



P54.32-7863 31

- ① DISTRONIC PLUS activated
- ② Your vehicle
- ③ Preset distance threshold to the preceding vehicle
- ④ Preceding vehicle, if detected

## DISTRONIC PLUS deactivated

When the DISTRONIC PLUS is deactivated, you will see the following display in the multifunction display.



- ① Preceding vehicle, if detected
- ② Actual distance to the preceding vehicle
- ③ Preset distance threshold to the preceding vehicle
- ④ Your vehicle

### DISTRONIC PLUS lever

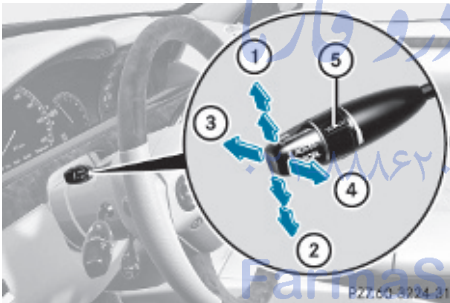

- ① Setting current or higher speed
- ② Setting current or lower speed
- ③ Deactivating the DISTRONIC PLUS
- ④ Activating the DISTRONIC PLUS or resuming to the last set speed
- ⑤ Setting following distance

### Activating DISTRONIC PLUS

#### **Warning!**

When the DISTRONIC PLUS is switched on, the vehicle can be braked. You should therefore switch off the DISTRONIC PLUS if the vehicle must be towed.

You can activate the DISTRONIC PLUS when the vehicle speed is above 20 mph (30 km/h).

It is also possible to activate the DISTRONIC PLUS when the vehicle speed is below 20 mph (30 km/h) and the DISTRONIC PLUS has detected a preceding vehicle.

If the DISTRONIC PLUS is activated, the set speed is indicated with marker ② (> page 333) in the speedometer dial.

The maximum vehicle speed you can set is 120 mph (Canada: 200 km/h).

If the DISTRONIC PLUS is not activated after the DISTRONIC PLUS lever is pulled in direction of arrow ④ (> page 335), you will see the message: DISTRONIC PLUS --- mph (Canada: DISTRONIC PLUS --- kmh) in the multifunction display.

In the following cases you cannot activate the DISTRONIC PLUS:

- within 2 minutes after driving off, following an engine start
- if the vehicle is secured with the electronic parking brake
- if the ESC is switched off or has switched off due to a malfunction
- when the automatic transmission is in park position **P**, reverse gear **R**, or neutral position **N**
- if the hood is open
- if the driver's door is open and the driver has not fastened his or her seat belt
- if the front passenger or a rear passenger door is open
- if the radar sensors are switched off (> page 236)

### Switching on while driving

You can switch on the DISTRONIC PLUS when the vehicle speed is above 20 mph (30 km/h).

Below 20 mph (30 km/h), you can only switch on the DISTRONIC PLUS if the preceding vehicle has been detected and is shown in the multifunction display. If you no longer see the preceding vehicle in the multifunction display and if it is no longer detected because it has changed lanes, for example, the DISTRONIC PLUS switches off and a signal sounds.

- ▶ Pull the DISTRONIC PLUS lever briefly in direction of arrow ④ to call up the last set speed, or if no speed is stored, to set and store the current speed.  
The DISTRONIC PLUS is switched on.

or

- ▶ Tap the DISTRONIC PLUS lever up ① or down ② until desired speed is set.  
The DISTRONIC PLUS is switched on.
- ▶ Remove your foot from the accelerator pedal.  
Your vehicle adapts its speed to the preceding vehicle, observing the set speed as a maximum value.

If you do not completely remove your foot from the accelerator pedal, the message DISTRONIC PLUS Override appears in the multifunction display. The distance to a slower-driving vehicle will not be set. You will drive at the speed you dictate by pressing the accelerator pedal.

### Switching on when approaching a stationary vehicle

It is helpful to switch on the DISTRONIC PLUS display in the multifunction display to see that a preceding vehicle is detected (> page 334). You can only switch on the DISTRONIC PLUS below a speed of 20 mph (30 km/h) when a preceding vehicle is detected.

If the preceding vehicle is stationary, you can only switch on the DISTRONIC PLUS if your vehicle is also at a standstill.

- ▶ Pull the DISTRONIC PLUS lever briefly in direction of arrow ④.  
The DISTRONIC PLUS is switched on.
- ▶ Tap the DISTRONIC PLUS lever up ① or down ② until desired speed is set.

You can adjust the set speed using the DISTRONIC PLUS lever and the target distance using the distance setting switch on the DISTRONIC PLUS lever (> page 339).

- i** If the DISTRONIC PLUS is switched off, the PRE-SAFE® Brake (> page 69) will warn of an impending collision if this function has been activated with the instrument cluster control system (> page 232).

### Starting off

When the preceding vehicle starts off:

- ▶ Remove your foot from the brake pedal.
- ▶ Pull the DISTRONIC PLUS lever briefly in direction of arrow ④.

or

- ▶ Briefly step on the accelerator pedal.  
Your vehicle starts off and adapts its speed to the preceding vehicle.

### Driving

If there is no preceding vehicle, the DISTRONIC PLUS functions like the cruise control (> page 328).

When the DISTRONIC PLUS detects that the preceding vehicle is driving more slowly, it brakes the vehicle in order to keep the distance specified by you.

When the DISTRONIC PLUS detects that the preceding vehicle is driving faster, it accelerates the vehicle up to the set speed.

#### Warning!

When you step on the brake pedal, you switch off the DISTRONIC PLUS except when the vehicle is at a standstill. The DISTRONIC PLUS will no longer brake your vehicle. You are always responsible for maintaining a distance from other vehicles, observing road speeds and braking well in advance.

## Stopping

### Warning!

The braking effect of the DISTRONIC PLUS is canceled and the vehicle can start to roll if

- the DISTRONIC PLUS is switched off using the DISTRONIC PLUS lever
- you accelerate
- the DISTRONIC PLUS system or the power supply is malfunctioning, e.g. due to battery failure
- the electrical components in the engine compartment or the fuses have been manipulated
- the battery is disconnected

### Warning!

Never get out of the vehicle while the DISTRONIC PLUS is switched on!

The DISTRONIC PLUS must never be operated or switched off by passengers or from outside the vehicle.

The DISTRONIC PLUS is not a substitute for the electronic parking brake. It must not be used to secure the vehicle when parking.

When you get out of the vehicle or switch off the engine, deactivate the DISTRONIC PLUS and secure the vehicle from rolling away by engaging the electronic parking brake.

When the DISTRONIC PLUS detects that the preceding vehicle is stopping, the vehicle brakes until it also stops. Once the vehicle is at a standstill, it remains stationary, without depressing the brake pedal.

After a short while, the vehicle is secured in place by the electronic parking brake so that the operating brake can be relieved of load.

Depending on the following distance set using the distance setting switch on the DISTRONIC PLUS lever (▷ page 339), the vehicle will stop adequate away from the preceding vehicle.

When the DISTRONIC PLUS is activated and the vehicle is at a standstill, the automatic

transmission shifts into park position **P** automatically when

- opening the driver's door and releasing the seat belt
- turning off the engine
- opening the hood
- a system malfunction occurs
- the on-board voltage is insufficient

The DISTRONIC PLUS is deactivated.

## Setting the current speed

- ▶ Accelerate or decelerate to the desired speed.
- ▶ Briefly lift the DISTRONIC PLUS lever in direction of arrow ① or depress in direction of arrow ② (▷ page 335). The current speed is set.
- ▶ Remove your foot from the accelerator pedal.

- i** If you do not take your foot off of the accelerator pedal and continue to accelerate past the set speed, the following message will appear in the multifunction display:

### DISTRONIC PLUS Override

The distance to a slower moving vehicle in front of you will not be set. Your vehicle speed will then be determined only by the accelerator pedal position.

## Changing the set speed

### Warning!

Keep in mind that it may take a brief moment until the vehicle has made the necessary adjustments.

Increase or decrease the set vehicle speed to a value that the prevailing road conditions and legal speed limits permit. Otherwise, sudden and unexpected acceleration or deceleration of the vehicle could cause an accident and/or serious injury to you and others.

You can increase or decrease the set speed in 1 mph (Canada: 1 km/h) increments or in 5 mph (Canada: 10 km/h) increments.

When you use the DISTRONIC PLUS lever to decelerate, the brake system will brake the vehicle automatically if the engine's braking power does not brake the vehicle sufficiently.

### Adjustment in 1 mph (Canada: 1 km/h) increments

- i** The set speed value is increased or decreased in 1 mph (Canada: 1 km/h) increments each time you lift or press the DISTRONIC PLUS lever up or down to the resistance point.
- ▶ **Increasing:** Briefly lift the DISTRONIC PLUS lever up to the resistance point in direction of arrow ①.
- ▶ **Decreasing:** Briefly press the DISTRONIC PLUS lever down to the resistance point in direction of arrow ②.
- ▶ Release the DISTRONIC PLUS lever. The new speed is set and the vehicle will accelerate or decelerate.

### Adjustment in 5 mph (Canada: 10 km/h) increments

- i** The set speed value is increased or decreased in 5 mph (Canada: 10 km/h) increments each time you lift or press the DISTRONIC PLUS lever up or down past the resistance point.
- ▶ **Increasing:** Briefly lift the DISTRONIC PLUS lever up past the resistance point in direction of arrow ①.
- ▶ **Decreasing:** Briefly press the DISTRONIC PLUS lever down past the resistance point in direction of arrow ②.
- ▶ Release the DISTRONIC PLUS lever. The new speed is set and the vehicle will accelerate or decelerate. Keep in mind that it may take a brief moment until the vehicle has reached the set speed.

### Setting stored speed (Resume function)

#### Warning!

The set speed stored in memory should only be set again if prevailing road conditions and legal speed limits permit. Possible acceleration or deceleration differences arising from returning to the preset speed could cause an accident and/or serious injury to you and others.

- ▶ Briefly pull the DISTRONIC PLUS lever in direction of arrow ④ (▷ page 335). The DISTRONIC PLUS is activated and resumes to the last set speed or, if no speed is stored, it will set and store the current speed.
- ▶ Remove your foot from the accelerator pedal.

### Deactivating DISTRONIC PLUS

- ▶ Depress the brake pedal (only possible if the vehicle is in motion).
- or  
تلفن شبانه روزی: ۰۲۱-۸۸۸۲۰۰۵
- ▶ Briefly push the DISTRONIC PLUS lever in direction of arrow ③ (▷ page 335). The last set speed is stored for later use. The last stored speed is deleted from memory when the engine is turned off. The DISTRONIC PLUS switches off automatically when
  - the vehicle is secured with the electronic parking brake
  - the vehicle speed falls below 15 mph (25 km/h) and no preceding vehicle is detected
  - the ESC is in operation, or switched off via the control system (▷ page 232), or the ESC has switched off due to a malfunction
  - you shift the automatic transmission into park position **P**, reverse gear **R**, or neutral position **N** while driving

- the radar sensors are switched off
- you pull the DISTRONIC PLUS lever in direction of arrow ④ (▷ page 335) for driving off and the front passenger or a rear passenger door is open

The marker for the set speed on the speedometer dial go out, an acoustic signal sounds, and the message DISTRONIC PLUS Off appears in the multifunction display for approximately 5 seconds.

#### **Warning!**

The DISTRONIC PLUS switches off and releases the brakes when the vehicle decelerates below the minimum speed of 20 mph (30 km/h) by operation of the system unless the DISTRONIC PLUS detects a vehicle directly ahead of you. At that time the driver must apply the brakes in order to reduce vehicle speed further or bring it to a stop.

Depressing the accelerator pedal does not deactivate the DISTRONIC PLUS. After a brief acceleration (e.g. for passing), the DISTRONIC PLUS will resume the last set speed.

### Setting the following distance in DISTRONIC PLUS

You can set the specified following distance for the DISTRONIC PLUS by varying the time setting between 1.0 and 2.0 seconds. Using this time setting and the current speed of your vehicle, the DISTRONIC PLUS calculates and sets the required following distance to the preceding vehicle.

The set distance will be shown in the multifunction display.

#### **Warning!**

It is up to the driver to exercise discretion to select the appropriate setting given road conditions, traffic, driver's preferred driving style and applicable laws and driving recommendations for safe following distance.

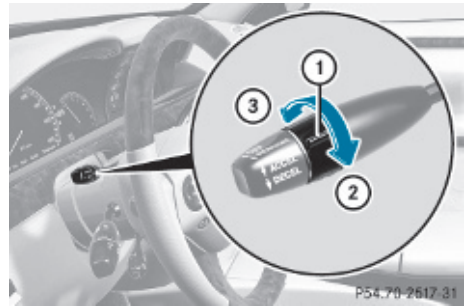

- ▶ **Increasing distance:** Turn distance setting switch ① in direction of arrow ②. Increasing the distance setting tells the DISTRONIC PLUS to maintain a greater following distance to the preceding vehicle.
- ▶ **Decreasing distance:** Turn distance setting switch ① in direction of arrow ③. Decreasing the distance setting tells the DISTRONIC PLUS to maintain a shorter following distance to the preceding vehicle.

### Driving with DISTRONIC PLUS

This section describes a number of driving situations where special precaution is required on the part of the driver. Be prepared to brake in such situations. Braking will deactivate the DISTRONIC PLUS system.

#### **Warning!**

The DISTRONIC PLUS works to maintain the speed selected by the driver unless a moving obstacle proceeding directly ahead of it in the same travel direction is detected (e.g. following another vehicle ahead of you at your set distance).

This means that:

- Your vehicle can pass another vehicle after you have changed lanes.
- While in a sharp turn or if the preceding vehicle is in a sharp turn, the DISTRONIC PLUS could lose sight of the preceding vehicle. Your vehicle could then accelerate to the previously selected speed.



The DISTRONIC PLUS regulates only the distance between your vehicle and those directly ahead of it. It may not register stationary objects in the road, e.g.:

- a stopped vehicle in a traffic jam
- a disabled vehicle
- an oncoming vehicle

The driver must always be alert, observe all traffic and intercede as required by means of steering or braking the vehicle.

#### **Warning!**

The DISTRONIC PLUS should not be used in snowy or icy road conditions.

The most likely cause for a malfunctioning system is a dirty sensor (located in the hood grille and in the bumper), especially at times of snow and ice or heavy rain.

In such a case, the DISTRONIC PLUS will switch off, and the message DISTRONIC PLUS Currently Unavailable See Oper. Manual appears in the multifunction display.

For cleaning and care of the sensors, see (> page 443).

- i** If the message DISTRONIC PLUS Currently Unavailable See Oper. Manual disappears during driving and the last speed stored flashes for approximately 5 seconds, the dirt (e.g. slush) has dissolved; the DISTRONIC PLUS is available again.

Another cause might be that the radar sensors have been manually switched off in the instrument cluster control system. Please verify that the radar sensors are switched on (> page 236).

### Turns and bends

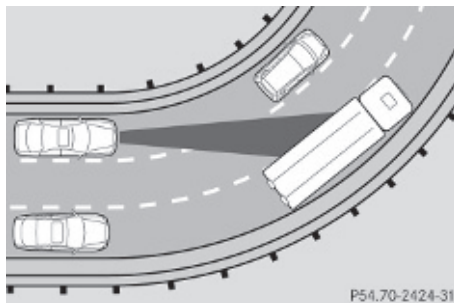

In turns or bends, the DISTRONIC PLUS may not detect a preceding vehicle, or it may detect one too soon. This may cause your vehicle to brake late or unexpectedly.

### Offset driving

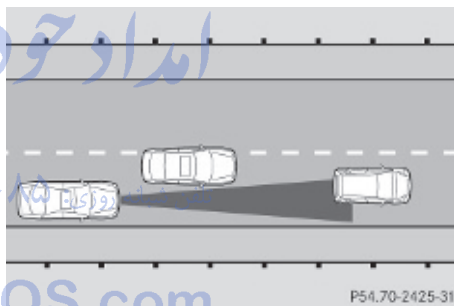

A vehicle traveling in your lane but offset from your direct line of travel may not be detected by the DISTRONIC PLUS. There will be insufficient distance to the preceding vehicle.

### Lane changing

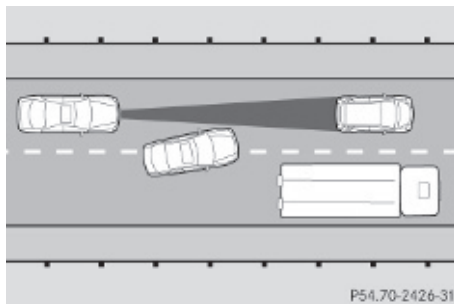



The DISTRONIC PLUS has not yet detected the vehicle changing lanes. There will be insufficient distance to the lane-changing vehicle.

### Narrow vehicles

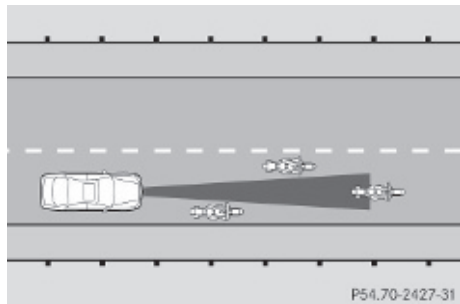

Because of their narrow profile, the vehicles traveling near the outer edges of the lane have not yet been detected by the DISTRONIC PLUS. There will be insufficient distance to the preceding vehicles.

### Obstacles and stationary vehicles

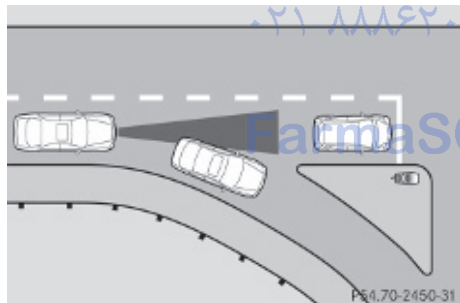

The DISTRONIC PLUS does not brake for obstacles or stationary vehicles. If, for example, the vehicle detected in front of you changes lanes to bypass an obstacle or stationary vehicle in front of it, the DISTRONIC PLUS will not brake for the obstacle or stationary vehicle.

### Cross-traffic

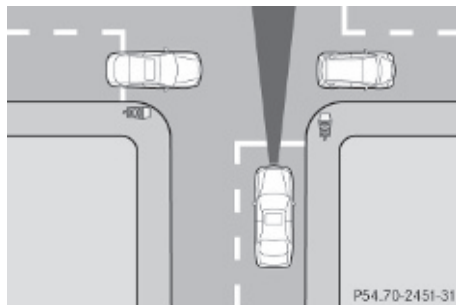

The DISTRONIC PLUS may inadvertently detect crossing vehicles. If you switch on the DISTRONIC PLUS, for example, at a traffic light with cross traffic, the vehicle may suddenly start to drive off.

### Hill-start assist system

On uphill grades, the hill-start assist system maintains the pressure in the brake system for approximately 1 second after you have released the brake pedal. Therefore, you can start off smoothly without the vehicle moving immediately after releasing the brake pedal.

#### Warning!

The hill-start assist system is not designed to function as a parking brake. It does not prevent the vehicle from moving when parked on an incline.

Always engage the electronic parking brake in addition to shifting the automatic transmission into park position **P**.

The hill-start assist system is inactive

- when starting off on a level road or downhill grades
- with the automatic transmission in neutral position **N**
- with the electronic parking brake engaged
- if the ESC has switched off due to a malfunction

## HOLD function

The HOLD function can assist you

- when driving off, especially on steep slopes
- when maneuvering on steep slopes
- when waiting in traffic

The vehicle is kept stationary without the driver having to depress the brake pedal.

Upon depressing the accelerator pedal, the braking effect is canceled and the HOLD function is deactivated.

### Warning!

HYBRID vehicles: It is imperative that you read the HYBRID Supplemental Operating Instructions included in your vehicle literature portfolio. You may otherwise not receive all necessary safety information and warning for the operation of your vehicle.

## Activation conditions

You can activate the HOLD function when

- the vehicle is stationary
- the engine is running
- your seat belt is fastened or the driver's door is closed
- the electronic parking brake is released
- the hood is closed
- the automatic transmission is in neutral position **N**, drive position **D**, or reverse gear **R**

When the automatic transmission is in reverse gear **R**, the trunk lid must be closed.

- the DISTRONIC PLUS is deactivated (▷ page 338).

## Activating HOLD

- ▶ Make sure the activation conditions are met.
- ▶ Depress the brake pedal.
- ▶ Continue to depress the brake pedal with increased pedal pressure until the message HOLD appears in the multifunction display. The HOLD function is activated. You can now release the brake pedal.



HOLD function activated

- i** The brake pedal does not return to the rest position completely while the HOLD function is activated.
- i** If the HOLD function is not activated when depressing the brake pedal, wait briefly and repeat the above steps.

### Warning!

The vehicle's brakes are applied when the HOLD function is activated. Therefore, deactivate the HOLD function, for example, when the vehicle is pulled through an automatic car wash or being towed.

## Deactivating HOLD

The HOLD function is switched off when

- you depress the accelerator pedal with the automatic transmission in drive position **D** or reverse gear **R**
- you shift the automatic transmission into park position **P**

- you depress the brake pedal fully again until the message HOLD in the multifunction display disappears
- you engage the electronic parking brake
- you activate the DISTRONIC PLUS

**i** After a while, the vehicle will be secured by the electronic parking brake to relieve the service brake.

### **⚠ Warning!**

The braking effect of the HOLD function is canceled and the vehicle can start to roll if

- the HOLD function is deactivated by depressing the accelerator pedal or the brake pedal
- the HOLD function or the power supply is malfunctioning, e.g. due to battery failure
- the electrical components in the engine compartment or the fuses have been manipulated
- the battery is disconnected

### **⚠ Warning!**

Never get out of the vehicle while the HOLD function is activated!

The HOLD function must never be operated or deactivated by passengers or from outside the vehicle.

The HOLD function does not replace the electronic parking brake. It must not be used to secure the vehicle when parking.

Deactivate the HOLD function when leaving or parking the vehicle. Use the electronic parking brake to secure the vehicle.

When the HOLD function is activated, the automatic transmission shifts into park position **P** automatically when

- opening the driver's door and releasing the seat belt
- turning off the engine
- opening the hood

- a system malfunction occurs
- the on-board voltage is insufficient

The HOLD function is deactivated.

## **AIRMATIC**

### **Introduction**

The AIRMATIC lets you select the chassis and suspension setup. The chassis and suspension setup adjusts the damping behavior and the ride height for your vehicle. The AIRMATIC consists of two components. The Adaptive Damping System (ADS) (▷ page 343) and the vehicle level control (▷ page 344).

### **Adaptive Damping System (ADS)**

The Adaptive Damping System (ADS) is controlled electronically and operates continuously. It adjusts the damping characteristics to the current operating and driving conditions. The damping is adjusted individually for each wheel. Driving safety and tire comfort are increased.

The fine tuning of the damping is dependent on

- your driving style
- road surface conditions
- your personal settings

The selected setting remains stored in memory even if the SmartKey is removed from the starter switch.



- ▶ Start the engine.

### Sporty damping adjustment

The firmer suspension tuning in sport driving mode provides enhanced road contact. Select this mode for example, on winding highways.

- ▶ **If indicator lamp ② is not lit:** Press ADS switch ①.

Indicator lamp ② comes on. The sport driving mode with a firmer suspension tuning is selected. The message AIRMATIC SPORT appears in the multifunction display.

### Comfort damping adjustment

Vehicle handling in comfort driving mode is softer. Select this mode when you prefer a more comfortable driving style on straight freeways.

- ▶ **If indicator lamp ② is lit:** Press ADS switch ①.

Indicator lamp ② goes out. The comfort driving mode is selected. The message AIRMATIC COMFORT appears in the multifunction display.

### Vehicle level control

Your vehicle automatically adjusts its ride height.

The all-around vehicle level control provides best possible suspension and constant ground clearance. The vehicle lowers at high speed automatically in order to increase driving safety and to reduce fuel consumption.

The following vehicle levels are available:

- normal
- raised; the vehicle is raised by approximately 1.0 in (25 mm) compared to normal level
- lowered; the vehicle is lowered by approximately 0.4 in (10 mm) compared to normal level

You can choose between normal or raised level when the vehicle is stationary and the engine is running.

The vehicle chassis ride height is raised or lowered according to the selected level setting and to the vehicle speed. With increasing speed, ride height is reduced by up to approximately 0.8 in (20 mm). With decreasing speed, the ride height is again raised to the selected vehicle level.

- ⓘ These height adjustments are so small that you may not notice any change.

### Adjusting vehicle level manually

#### ⚠ Warning!

To help avoid personal injury, keep hands and feet away from wheel housing area, and stay away from under the vehicle when lowering the vehicle chassis.

Select the normal level for driving on normal roads. Select the raised level for driving on rough roads or with snow chains. Select the raised level only when required by current driving conditions. Otherwise, the handling may be impaired and the fuel consumption may increase.

The selected vehicle level setting remains stored in memory even if the SmartKey is removed from the starter switch.



### Selecting raised level

- ▶ Start the engine.

When indicator lamp ② is off:

- ▶ Briefly press vehicle level control switch ①.

Indicator lamp ② comes on. The vehicle adjusts from normal level to raised level. The message: *Vehicle Rising* appears in the multifunction display when adjusting from normal level to raised level. The message disappears when the vehicle is raised. Indicator lamp ② is then lit.

When the vehicle is in raised level, pressing vehicle level control switch ① will return the vehicle to normal level.

The vehicle is lowered to the normal level automatically when

- the vehicle speed is above 75 mph (120 km/h)
- the vehicle speed stays between 50 mph (80 km/h) and 75 mph (120 km/h) for approximately 3 minutes.

Indicator lamp ② in vehicle level control switch ① goes out.

If you do not drive in this speed range, the selected vehicle level setting remains stored in memory even if the SmartKey is removed from the starter switch.

### Selecting normal level

- ▶ Start the engine.

When indicator lamp ② is on:

- ▶ Briefly press vehicle level control switch ①.

Indicator lamp ② goes out. The vehicle adjusts from raised level to normal level.

### ABC

The ABC system is an active, computer-controlled system that adjusts the suspension hydraulically at all four wheels in response to various driving situations. It selects the optimum suspension tuning and ride height for your vehicle automatically.

### Vehicle level control

Your vehicle adjusts its ride height automatically to increase vehicle safety and to reduce fuel consumption.

The vehicle chassis ride height is raised or lowered according to the selected level setting and to the vehicle speed. With increasing speed, the ride height is reduced by up to approximately 0.6 in (15 mm). With decreasing speed, the ride height is again raised to the selected vehicle level.

These height adjustments are so small that you may not notice any change.

#### Warning!

When you turn off the engine, the entire vehicle is lowered. You should therefore make sure that no one is near the wheel housing or under the vehicle when you turn off the engine. Otherwise, parts of the individuals body could be trapped.

- ▶ When you turn off the engine, the entire vehicle is lowered. When parking, position your vehicle in such a way that it will not scrape against a curb, for example, when it is lowered. Your vehicle could otherwise be damaged.

- ▶ S 63 AMG and S 65 AMG only:

When you turn off the engine, the entire vehicle is lowered by 0.4 in (10 mm).

### Setting the vehicle level

#### Warning!

To help avoid personal injury, keep hands and feet away from wheel housing area, and stay away from under the vehicle when lowering the vehicle chassis.

The following vehicle level settings can be selected when the vehicle is stationary and the engine is running:

Level	Use for	Indicator lamp
<b>Normal</b>	For driving on normal roads.	The indicator lamp is off.
<b>Raised</b>	For driving on rough roads or with snow chains (> page 433).	The indicator lamp is on.

Select the “Raised” level setting only when required by current driving conditions. Otherwise the fuel consumption may increase and/or the handling may be impaired.

- i** The selected setting remains stored in memory, even when the engine is turned off and restarted.

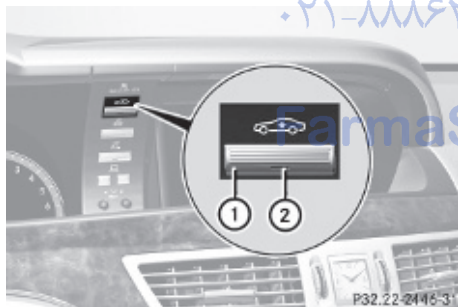

- ▶ Start the engine.

### Selecting a higher level

If indicator lamp ② is off:

- ▶ Press vehicle level control switch ①. Indicator lamp ② comes on. The vehicle is raised to a higher level.

### Selecting a normal level

If indicator lamp ② is on:

- ▶ Press vehicle level control switch ①. Indicator lamp ② goes out. The vehicle is adjusted to a normal level.

### Suspension tuning

The suspension tuning of the ABC system is adjusted for each wheel individually and depends on:

- your driving style
- the road condition, such as bumps etc.
- your individual selection, sporty or comfortable
- the vehicle loading

- i** The selected setting remains stored in memory, even when the engine is turned off and restarted.



- ▶ Start the engine.

### Sporty suspension tuning

The firmer chassis and suspension setup in sport driving mode provides enhanced road contact. Select this mode when you prefer a firmer chassis and suspension setup.

- ▶ **When indicator lamp ② is off:** Press button ①. Indicator lamp ② comes on. The sporty chassis and suspension setup is selected. The message ABC Active Body Control SPORT appears in the multifunction display.

### Comfort suspension tuning

Vehicle handling in comfort driving mode is softer. Select this mode when you prefer a more comfortable driving style.

▶ **When indicator lamp ② is on:** Press button ①.

Indicator lamp ② goes out. The comfortable chassis and suspension setup is selected.

The message ABC Active Body Control COMFORT appears in the multifunction display.

### All-wheel drive (4MATIC)

In vehicles with all-wheel drive (4MATIC), both axles are powered at all times when the vehicle is being operated. The 4MATIC improves traction in conjunction with the ESC (▷ page 66) and the Electronic Traction System (ETS/4-ETS) (▷ page 67).

#### **Warning!**

If a drive wheel is spinning due to insufficient traction:

- While driving off, apply as little throttle as possible.
- While driving, ease up on the accelerator pedal.
- Adapt your speed and driving style to the prevailing road conditions.

Failure to observe these guidelines could cause the vehicle to skid.

The 4MATIC cannot prevent accidents resulting from excessive speed.

! Do not tow with one axle raised. Doing so could damage the transfer case, which is not covered by the Mercedes-Benz Limited Warranty. All wheels must be on or off the ground. Observe instructions for towing the vehicle with all wheels on the ground.

! Only conduct operational or performance tests on a two-axle dynamometer. If such tests are necessary, contact an authorized Mercedes-Benz Center. You could otherwise seriously damage the brake system and/or the transfer case which is not covered by the Mercedes-Benz Limited Warranty.

i In winter operation, the maximum effectiveness of the 4MATIC is only achieved with winter tires (▷ page 432) or snow chains as required.

### Parktronic system

The Parktronic system with Parking Guidance is an electronic parking aid with ultrasonic sensors designed to assist the driver during parking maneuvers. The Parktronic system indicates the relative distance between the vehicle and an obstacle visually and audibly.

The Parktronic system is activated automatically when

- you switch on the ignition and
- you release the electronic parking brake or
- you start the engine and
- shift the automatic transmission into drive position **D**, reverse gear **R**, or neutral position **N**

The Parktronic system deactivates at speeds above approximately 11 mph (18 km/h). At lower speeds, the Parktronic system activates again.

The Parktronic system also deactivates when you shift the automatic transmission into park position **P** or engage the electronic parking brake and turn off the engine.

The Parktronic system monitors the surroundings of your vehicle with six sensors



in the front bumper and four sensors in the rear bumper.



Example illustration, sensors in the front bumper

To function properly, sensors ① must be free of dirt, ice, snow and slush. Clean sensors ① regularly. Be careful not to scratch or damage sensors ①, see “Cleaning the driving systems sensors” (▷ page 443).

#### **Warning!**

The Parktronic is a supplemental system. It is not intended to, nor does it replace, the need for extreme care. The responsibility during parking and other critical maneuvers always remains with the driver.

#### **Warning!**

Make sure no persons or animals are in or near the area in which you are parking/maneuvering. Otherwise, they could be injured.

**!** Special attention must be paid to objects with smooth surfaces or low silhouettes (e.g. trailer couplings, painted posts, elevated crossbars or road curbs). Such objects may not be detected by the system and can damage the vehicle.

During parking maneuvers, pay special attention to objects located above or below the height of the sensors (e.g. street curbs, painted posts, or trailer hitches etc.). The Parktronic system will not detect such objects at close range and damage to your vehicle or the object may result.

**!** Ultrasonic signals from outside sources (e.g. truck air brakes, car wash, or jackhammers) may impair the operation of the Parktronic system.

### Range of the sensors

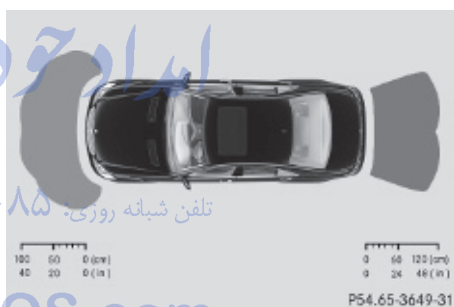
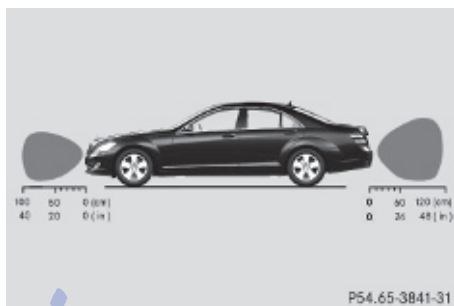

### Front sensors

Center	approx. 40 in (100 cm)
Corners	approx. 24 in (60 cm)

### Rear sensors

Center	approx. 48 in (120 cm)
Corners	approx. 32 in (80 cm)

### Minimum distance

Center	approx. 8 in (20 cm)
Corners	approx. 6 in (15 cm)

If the Parktronic system detects an obstacle in this range, all the distance warning segments illuminate and you hear a warning

signal. If the obstacle is closer than the minimum distance, the actual distance may no longer be indicated by the Parktronic system.

### Warning indicators

Visual signals indicate the relative distance between the sensors and an obstacle.

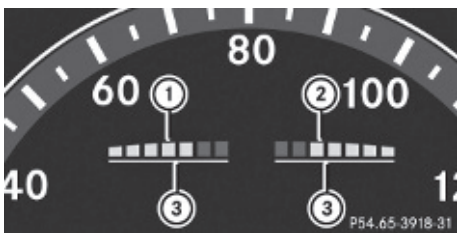

Front area warning indicators

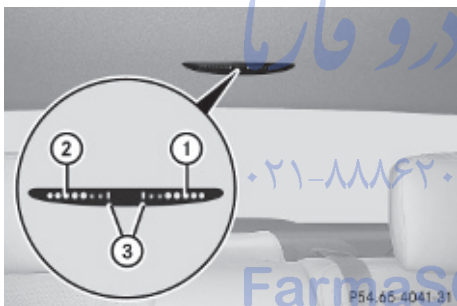

Rear area warning indicators

Each warning indicator is divided into five yellow and two red distance segments for left side ① and right side ② of the vehicle. The Parktronic system is ready to measure when the yellow readiness indicators ③ are illuminated.

The current transmission position determines which warning indicator will be activated.

Current transmission position	Warning indicator
D	Front area activated
R	Front and rear area activated
N	With the electronic parking brake engaged: neither activated With the electronic parking brake released: front and rear area activated

As your vehicle approaches an object, one or more distance segments will illuminate, depending on the distance. When the seventh distance segment illuminates, you have reached the minimum distance.

- **Front area:** An intermittent acoustic warning will sound as the first red distance segment illuminates and a constant acoustic warning lasting a maximum of 2 seconds will sound for the second red distance segment. The signal is canceled when the automatic transmission is shifted into park position **P**.
- **Rear area:** An intermittent acoustic warning will sound as the first red distance segment illuminates and a constant acoustic warning lasting a maximum of 2 seconds will sound for the second red distance segment. The signal is canceled when the automatic transmission is shifted into drive position **D** or park position **P**.

### Switching the Parktronic system on/off

The Parktronic system switches on automatically when the ignition is switched on.

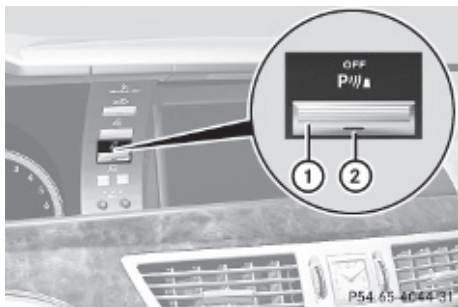

- ▶ **Switching off:** Press Parktronic switch ①.  
Indicator lamp ② comes on.
- ▶ **Switching on:** Press Parktronic switch ① again.
- ❗ When you switch the Parktronic system on or off the Parking Guidance (▷ page 350) is also switched on or off.

### Parktronic system malfunction

There is a malfunction in the Parktronic system, if only the red distance segments illuminate and an acoustic warning sounds. The Parktronic system will switch off automatically after 20 seconds and indicator lamp ② in Parktronic switch ① comes on.

- ▶ Have the Parktronic system checked at an authorized Mercedes-Benz Center as soon as possible.

If only the red distance segments illuminate and no acoustic warning sounds, the Parktronic system sensors are dirty (e.g. dirt, ice, snow and slush). Another cause could be interference from other radio or ultrasonic signals (e.g. truck air brakes, car wash, or jackhammers). The Parktronic system will switch off automatically after 20 seconds and indicator lamp ② in Parktronic switch ① comes on.

- ▶ Switch off the ignition.
- ▶ Clean the Parktronic system sensors (▷ page 443).
- ▶ Switch on the ignition.

or

- ▶ Check the Parktronic system operation at another location to rule out interference from outside radio or ultrasonic signals.

### Parking Guidance

The Parking Guidance is part of the Parktronic system. With the Parktronic system switched on (▷ page 349), the Parking Guidance is also available.

The Parking Guidance is an electronic parking aid equipped with ultrasonic sensors. The ultrasonic sensors scan the area on both sides of vehicle. When a suitable parking space is found, it is indicated by a parking space symbol in the multifunction display. You will receive steering instructions for parking in that space.

#### ⚠ Warning!

The Parking Guidance is only an aid and may display parking spaces that are not suitable for parking such as

- no-parking zones
- parking space with unsuitable road/ground surface
- driveways
- entrances/exits

The Parking Guidance scans for and measures potential parking spaces when driving past. Subsequent changes to the parking space are not taken into account. This may be the case if the position of the vehicle parked in front or behind the space changes or obstacles in the parking space are moved.

The Parking Guidance does not relieve you of the responsibility to pay attention. If you only rely on the Parking Guidance, you may cause an accident and injure yourself and others.

You are always responsible for safety and must continue to pay attention to your immediate surroundings when parking and maneuvering.

### Warning!

The system cannot detect objects located above the area that the sensors scan. These objects, e.g. protruding load, overhang, or truck tail lifts, will be ignored when computing the parking procedure. The Parking Guidance might therefore provide untimely steering instructions. This could cause a collision. Thus, do not use the Parking Guidance in such situations.

### Warning!

Make sure no persons or animals are in the area in which you are maneuvering. You could otherwise injure them.

- !** Special attention must be paid to objects with smooth surfaces or low silhouettes (e.g. trailer couplings, painted posts, elevated crossbars or road curbs). Such objects may not be detected by the system and can damage the vehicle.

Use the Parking Guidance for parking spaces that are

- parallel to the direction of travel
- located on straight streets, i.e. not in curves
- on the same level as the street, i.e. not on sidewalks, for example.

Parking instructions:

- On narrow streets, drive by the parking space as close as possible.
- Parking spaces that are dirty, overgrown or located in front of trailers may not be detected correctly.
- Snowfall or heavy rain may cause imprecise measurement of the parking space.
- Also observe the Parktronic system warning indicator (▷ page 349) while the Parking Guidance is active.

- You may not use the Parking Guidance when transporting cargo that protrudes the vehicle.
- Do not use the Parking Guidance when driving with snow chains or when a spare wheel is mounted.
- How well your vehicle will be parked after completion of the Parking Guidance depends on the position and shape of the vehicles parked in front of and behind the parking space as well as the conditions of the immediate surroundings. In certain cases, the Parking Guidance may guide you too far into the parking space or not far enough. If this is the case, cancel the parking procedure with the Parking Guidance and correct the vehicle position yourself.

### Detecting a parking space

The Parking Guidance is active when driving forward. The system operates at a vehicle speed of up to 22 mph (35 km/h). It scans automatically for and measures potential parking spaces on both sides of the vehicle.

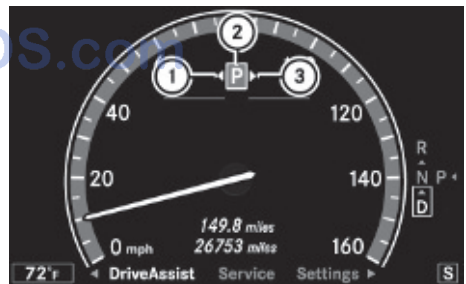

- ① Detected parking space on the left
- ② Parking space symbol
- ③ Detected parking space on the right

At a vehicle speed of below 19 mph (30 km/h), you see white parking space symbol ② as a system display in the multifunction display. As soon as the Parking Guidance has detected a suitable parking

space, parking space symbol ② changes to blue.

When a parking space has been detected, an additional arrow to the right ③ or to the left ① appears.

In order to be detected by the Parking Guidance, a parking space must be

- closed-in at the rear
- parallel to the direction of travel
- at least 5 ft (1.5 m) wide
- at least 4.3 ft (1.3 m) longer than your vehicle is

A parking space is shown in the multifunction display when driving by until you have reached a distance of 50 ft (15 m) from the space. The Parking Guidance only shows parking spaces on the passenger side of the vehicle unless you activate the driver's side (left) turn signal. If you would like to park on the driver's side, the left turn signal must remain on until the reverse gear is engaged.

## Parking

The following describes the parallel parking process on the passenger side. Parallel parking on the driver's side is performed reversed left to right.

### Warning!

The Parking Guidance is only an aid and may not detect all obstacles. The Parking Guidance does not relieve you of the responsibility to pay attention. You are always responsible for safety and must continue to pay attention to your immediate surroundings when parking and maneuvering. Otherwise, you could endanger yourself and others.

- ▶ Bring the vehicle to a standstill as long as the desired parking space is displayed by

the blue parking space symbol in the multifunction display.

- ▶ Shift the automatic transmission into reverse gear **R**. The message Check Surroundings Press 'OK' to Confirm appears in the multifunction display.
- ▶ Press **OK** on the multifunction steering wheel to confirm. The display in the multifunction display changes to the Parking Guidance.

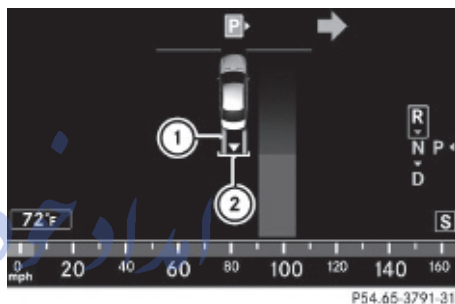

- ▶ Where necessary, depending on the distance to the parking space, back up in a straight line a short distance. This is indicated by a green lane ①.
- ▶ Back up until you hear an audible warning, then stop. The stopping position has been reached, indicated by a white bracket ②.

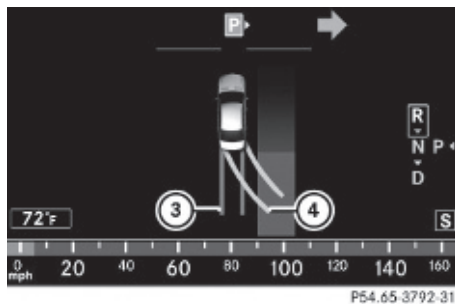

- ▶ When the vehicle is stationary, turn the steering wheel until red lane ③ matches up with yellow lane ④. Lane ④ then turns green. If the parking space is located within the display range, a white bracket with an arrow for the target position is shown at the end of the green lane.

### Driving into the parking space

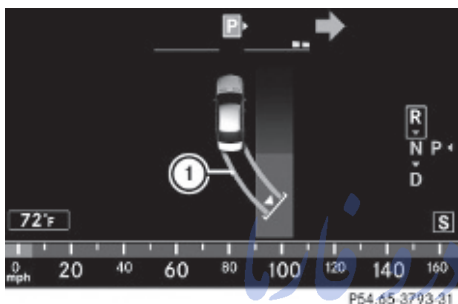

Green lane ① indicates the correct steering wheel position.

- ▶ Maintain the steering wheel position and carefully back up.
- ▶ Stop as soon as you hear the audible warning. The vehicle has reached the position for countersteering.

### Countersteering

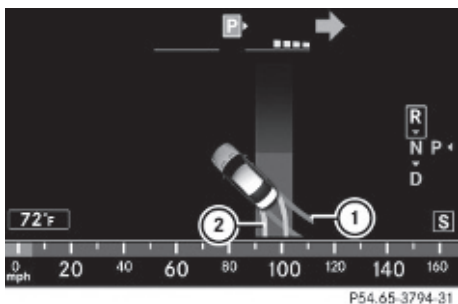

- ▶ When the vehicle is stationary, turn the steering wheel until red lane ① matches up with yellow lane ②. Lane ② then turns green and a white arrow and a white bracket are shown to indicate the target position.

### Reaching end position

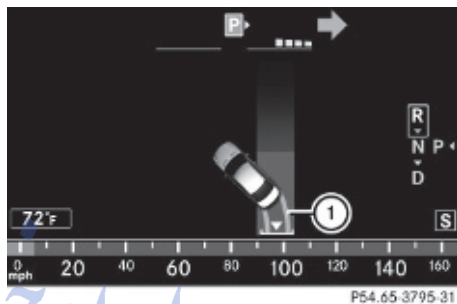

Green lane ① indicates the correct steering wheel position.

- ▶ Maintain the steering wheel position and carefully back up until the end position has been reached. The message Parking Guidance Finished appears in the multifunction display and you will hear an audible warning.

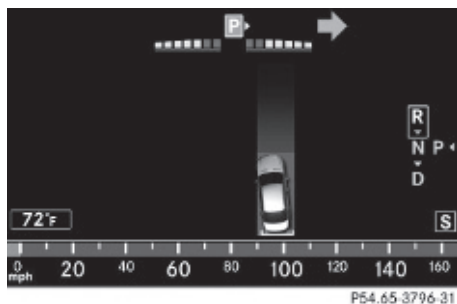

### End position

Depending on the size of the parking space, the vehicle may be positioned at an angle in the parking space. The Parking Guidance guides you close to the rear limit of the parking space where possible.

- ▶ Adjust the end position by maneuvering as needed.
- ▶ Observe the Parktronic system warning indicator (▷ page 349).

### Canceling the Parking Guidance

- ▶ Press the Parktronic switch (▷ page 349). The Parking Guidance is canceled immediately and the Parktronic system is deactivated.

The Parking Guidance is canceled automatically if guidance into the parking space is no longer possible or if an error occurs.

The parking space symbol disappears and the message Parking Guidance Canceled appears in the multifunction display.

### Rear view camera

The rear view camera is an optical parking aid.

The area behind the vehicle appears in the COMAND system display as a mirror image, like in the rear view mirror.

In addition, the rear view camera contains guidelines to help you with driving in reverse.

#### Warning!

Make sure no persons or animals are in or near the area in which you are parking/maneuvering. Otherwise, they could be injured.

#### Warning!

The rear view camera is only an aid and may display obstacles

- from a distorted perspective
- inaccurately
- may not display obstacles at all

The rear view camera does not relieve you of the responsibility to be cautious. Take care and pay careful attention. The rear view camera may not show objects which are

- very close to the rear bumper
- under the rear bumper
- above the trunk handle

You are responsible for safety at all times and must continue to pay attention to the immediate surroundings when parking and maneuvering. This includes the area behind, in front of, and beside the vehicle. Otherwise you could endanger yourself and/or others.

#### Warning!

The rear view camera either will not function or will not function to its full capability if

- the trunk lid is open
  - it is raining very hard, snowing or foggy
  - it is night or you are parking/maneuvering your vehicle in an area where it is very dark
  - the camera is exposed to a very bright white light
  - the immediate surroundings are illuminated with fluorescent light (the COMAND system display can flicker)
  - there is a sudden change in temperature, e.g. if you drive into a heated garage from the cold (lens condensation)
  - the camera lens is dirty or covered
  - the rear of your vehicle is damaged
- In this case, have the position and setting of the camera checked by a qualified specialist workshop. Mercedes-Benz recommends that you contact a Mercedes-Benz Center for this purpose.

Do not use the rear view camera in these situations. Otherwise you could injure yourself or others and/or damage property including your vehicle while parking/maneuvering.



### Warning!

Use of rear view camera can be dangerous if you are color-blind or have impaired color vision.

Only use rear view camera if you can see and distinguish all colored guidelines shown by rear view camera on the COMAND system display.

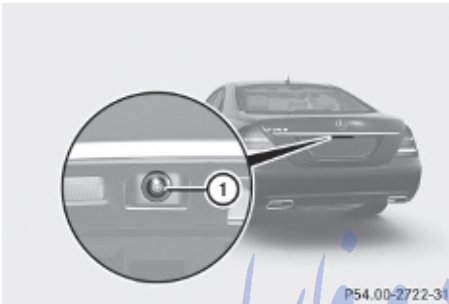

Camera lens ① must be free of dirt, ice, snow, and slush to function properly. Clean the camera lens regularly. Being careful not to scratch or damage the camera lens, see "Cleaning the rear view camera lens" (► page 444).

### Switching on or off

- **Switching on:** Switch on the ignition.
- Switch on the COMAND system.
- Shift the automatic transmission to reverse gear **R**.  
The COMAND system display will show the area behind the vehicle with guidelines.

### Warning!

Please note that objects which do not touch the ground may appear to be further away than they actually are, for example:

- the bumper of a vehicle parked behind you
- a trailer hitch
- the back of a truck

In such cases, you should not use the guidelines to judge the distance. You may

misjudge the distance which increases the risk of impacting the objects.

Even when the object you approach is directly on the ground do not approach the object any closer than the red guideline.

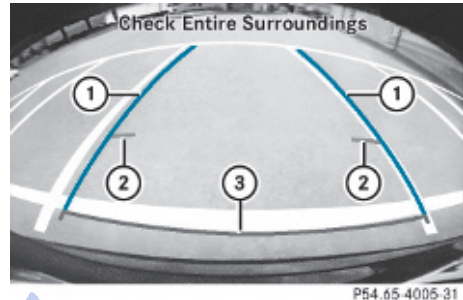

Red guideline ③ indicates an approximate distance of 10 in (0.25 m) from the rear of the vehicle. Yellow guidelines ② indicate an approximate distance of 3 ft (1 m) from the rear of the vehicle. Blue guidelines ① indicate the approximate width required for the vehicle.

**i** The image from the rear view camera will no longer be displayed if you select another function on the COMAND system while reverse gear **R** is engaged. To display the image again, disengage and reengage reverse gear **R**.

- **Switching off:** Shift the automatic transmission into park position **P**, neutral position **N**, or drive position **D**.

### ATTENTION ASSIST

The ATTENTION ASSIST supports you during long, monotonous rides, e.g. on freeways and highways. The ATTENTION ASSIST is active at a vehicle speed of between 50 mph (80 km/h) and 112 mph (180 km/h). Always obey applicable speed limits. The ATTENTION ASSIST suggests to take a rest when recognizing fatigue or increasing inattentiveness of the driver.

### Warning!

The ATTENTION ASSIST is only an aid to the driver. It might not recognize fatigue or increasing inattentiveness in time or fail to recognize them at all. The system cannot substitute a rested and attentive driver.

Fatigue can cause you to recognize dangers too late, to misjudge potential dangers, or to react slower. Therefore, make sure to be rested before and during your trip. Take rests early enough and regularly, especially during long trips. Failure to do so could cause you to recognize dangers too late which could result in an accident and serious injury to you and/or others.

The ATTENTION ASSIST interprets your fatigue or increasing inattentiveness considering the following criteria:

- the individual driving style, for example the way you steer
- the driving conditions such as time of day and duration of the ride

The ATTENTION ASSIST function is restricted and warnings will be delayed or not issued at all when

- road conditions are bad, e.g. heavy bumps or potholes
- crosswinds are strong
- driving in a sporty manner with high speed in curves or rapid acceleration
- driving slower than 50 mph (80 km/h) or faster than 112 mph (180 km/h) most of the time
- operating the COMAND or making phone calls via COMAND
- changing lanes or varying the vehicle speed, i.e. you intervene actively

### Warnings and displays in the multifunction display

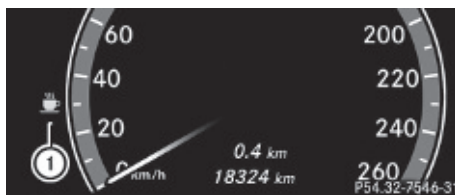

- ▶ Switch on the ATTENTION ASSIST via the control system (> page 232). ATTENTION ASSIST indicator ① appears in the multifunction display.

When the ATTENTION ASSIST is active, it will warn you after 20 minutes of driving at the earliest. An intermittent warning will then sound twice and the message Attention Assist: Time for a rest? appears in the multifunction display.

- ▶ If possible park your vehicle in a safe location and take a rest.
- ▶ Confirm the message by pressing button  on the multifunction steering wheel.

If you do not take a rest and the ATTENTION ASSIST continues to recognize fatigue or increasing inattentiveness, you will be warned once more after 15 minutes at the earliest.

During long trips, take regular and duly rests that allow you to recover sufficiently.

The ATTENTION ASSIST will be reset and restarts evaluating the degree of your fatigue when

- you turn off the engine
- you release the seat belt and open the driver's door, e.g. during a rest or for a driver change

### Night View Assist Plus

The Night View Assist Plus illuminates the road with infrared light in addition to the normal headlamps.

A camera at the top of the windshield measures the infrared light and shows a black-and-white image in the multifunction

display. The image in the multifunction display corresponds to a road lit up by high-beam headlamps.

### **Warning!**

The Night View Assist Plus is only an aid to support you while driving and cannot substitute your careful attention. Do not rely on the display of the Night View Assist Plus; instead, continue to look through the windshield. You are always responsible for safety and must drive in accordance with traffic conditions. Otherwise, you could endanger yourself and others.

The system may be impaired or unavailable when

- visibility is poor, e.g. due to snow, rain, fog, or heavy spray
- the camera area of the windshield is dirty, fogged up or covered by a sticker for example
- driving through curves or on inclines or declines

### **Warning!**

The Night View Assist Plus cannot record objects immediately in front of or next to the vehicle. When maneuvering, continue to look through the windshield. Make sure no persons or animals are in the area in which you are maneuvering. You could otherwise injure them.

The Night View Assist Plus image in the multifunction display is not impaired by the headlamps of approaching vehicles.

As a result, you can better follow the course of the road and detect obstacles earlier on.

- i** Infrared light is invisible to the human eye and thus does not blind. The Night View Assist Plus can remain switched on permanently even with oncoming traffic present.

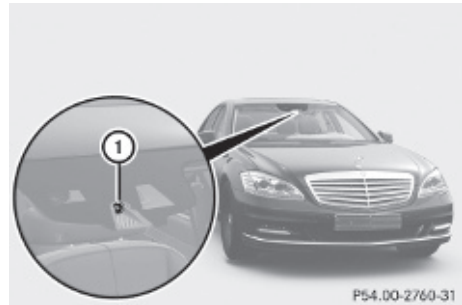

The Night View Assist Plus monitors the area in front of your vehicle via camera ①.

### **Switching on or off**

You can only switch on the Night View Assist Plus if

- the SmartKey in the starter switch is set to position **2**
- it is dark
- the exterior lamp switch is set to **A** or , or if the daytime running lamp mode is activated (▶ page 299)
- the automatic transmission is not in reverse gear **R**



- ▶ Press button ① up or down. The Night View Assist Plus image appears in the multifunction display.

- i** The infrared headlamps only come on above a speed of approximately 6 mph (10 km/h). Therefore, when you are at a standstill, you do not have a complete view

and cannot check the function of the Night View Assist Plus.

### Image on multifunction display

When you switch on the Night View Assist Plus, the dial for the speedometer changes on the multifunction display. The speedometer dial is shown as a bar on the lower edge of the multifunction display. The line for main menus is no longer available. If you would like to change a setting using the steering wheel buttons, you must first switch off the Night View Assist Plus.

### Pedestrian detection

The Night View Assist Plus detects pedestrians by means of specific characteristics, e.g. a human silhouette.

Pedestrian detection is activated when

- the Night View Assist Plus is switched on
- the vehicle speed is above approximately 6 mph (10 km/h)
- driving in darkness, e.g. on highways without road lighting

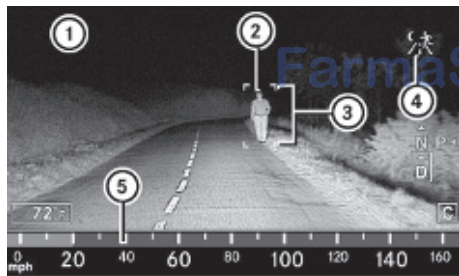

- 1 Night View Assist Plus image
- 2 Detected pedestrian
- 3 Frame
- 4 Symbol for active pedestrian detection
- 5 Speedometer dial

When pedestrian detection is active, symbol ④ appears in the Night View Assist Plus image. Once a pedestrian is detected, that pedestrian is highlighted by frame ③.

When you have been made aware of a pedestrian, assess the situation by looking through the windshield. The actual distance between your vehicle and objects or pedestrians cannot be assessed properly via a screen display.

Other objects apart from pedestrians may also be highlighted.

### Warning!

The pedestrian detection may be impaired or unavailable when

- pedestrians are obstructed fully or in part by other objects such as parking vehicles
- the silhouette in the Night View Assist Plus image is displayed incomplete or interrupted, e.g. by significant light reflection
- a pedestrian's silhouette is not rich enough in contrast compared to the background
- pedestrians are not in erected position but, for example, sit, crouch down, or lie

**i** Animals cannot be detected.

### Adjusting instrument cluster illumination

If you change the brightness of the instrument cluster while the Night View Assist Plus is switched on, only the brightness of the multifunction display is changed.

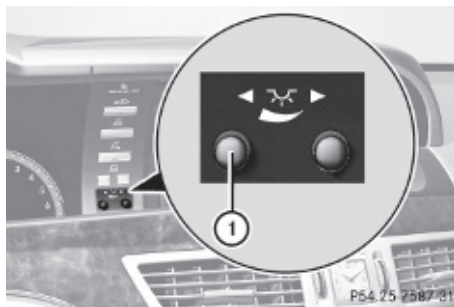

- ▶ Make sure the Night View Assist Plus is switched on.
- ▶ **Brightening illumination:** Turn knob ① clockwise.

- ▶ **Dimming illumination:** Turn knob ① counterclockwise.

### Dirty or fogged-up windshield

The Night View Assist Plus image is diminished when the windshield in front of the camera is

- dirty
- fogged up on the outside
- fogged up on the inside

#### Warning!

Please do not forget that your primary responsibility is to drive the vehicle. A driver's attention to the road must always be his/her primary focus when driving. For your safety and the safety of others, stop before trying to remove window fogging or cleaning the windshield in front of the Night View Assist Plus camera.

Bear in mind that at a speed of just 30 mph (approximately 50 km/h), your vehicle is covering a distance of 44 feet (approximately 14 m) every second.

- ▶ **Removing condensation:** Check settings of the climate control and change them, if necessary (▷ page 363).
- ▶ Swing the camera cover downward (▷ page 444).
- ▶ **Cleaning inside of windshield:** Use a soft, non-scratching cloth (▷ page 444).

### Blind Spot Assist

The Blind Spot Assist uses radar sensors to monitor the area on both sides of your vehicle. It will assist you when you change lanes driving at speeds of above 20 mph (30 km/h). A red warning lamp will come on in the exterior rear view mirror as soon as another vehicle is detected. If you then activate the corresponding turn signals to change lanes, the red warning lamp flashes

and warning sounds (collision warning). The Blind Spot Assist operates using sensors in the rear bumper.

#### Warning!

The Blind Spot Assist is only a driving aid and may not detect all vehicles.

The Blind Spot Assist may not be able to detect narrow vehicles such as motorcycles or bicycles, or it may not detect them until it is too late.

The monitoring function may be impaired if your sensors are dirty, subject to heavy spray, or if visibility is poor due to e.g. snow, rain, or fog. This can result in vehicles not being detected or being detected too late.

The Blind Spot Assist cannot detect road, traffic and weather conditions.

It is the driver's responsibility at all times to be attentive to road, weather and traffic conditions and to provide the steering, braking and other driving inputs necessary to retain control of the vehicle. Failure to do so could result in recognizing dangers too late, possibly resulting in an accident and serious injury to yourself and others.

In order for the Blind Spot Assist to function, the radar sensors must be switched on and operational.

When traveling in Canada in a vehicle not registered in Canada, you must switch off the radar sensor system (▷ page 236). Canadian law does not permit the use of the radar sensor system for vehicles from outside of Canada. When you switch off the radar sensor system, the following functions are deactivated:

- Blind Spot Assist
- BAS PLUS (▷ page 64)
- PRE-SAFE® Brake (▷ page 69)
- DISTRONIC PLUS (▷ page 330)

#### USA only:

This device has been approved by the FCC as a "Vehicular Radar System". The radar

sensor is intended for use in an automotive radar system only. Removal, tampering, or altering of the device will void any warranties, and is not permitted by the FCC. Do not tamper with, alter, or use in any non-approved way.

Any unauthorized modification to this device could void the user's authority to operate the equipment.

**i** Canada only:

This device complies with RSS-210 of Industry Canada. Operation is subject to the following two conditions:

1. This device may not cause interference, and
2. this device must accept any interference received, including interference that may cause undesired operation of the device.

Removal, tampering, or altering of the device will void any warranties, and is not permitted. Do not tamper with, alter, or use in any non-approved way.

Any unauthorized modification to this device could void the user's authority to operate the equipment.

### Sensor monitoring range

The Blind Spot Assist is able to monitor a range up to 10 ft (3 m) to the rear and both sides of the vehicle.

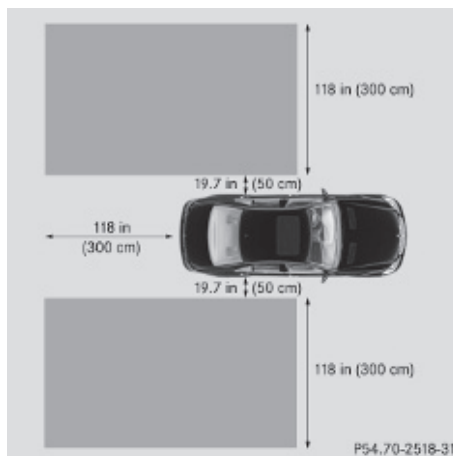

### Warning!

The Blind Spot Assist monitors certain areas in the immediate vicinity of your vehicle. Vehicles approaching and passing at speeds that exceed the speed of your vehicle significantly will not be detected. There will be no warning display and no audible warning. When driving in a very wide lane, the sensors may not be able to cover the entire width of the neighboring lane. Vehicles driving on the outside of the neighboring lane may not be detected.

It is the driver's responsibility at all times to be attentive to road, weather and traffic conditions and to provide the steering, braking and other driving inputs necessary to retain control of the vehicle. Failure to do so could result in recognizing dangers too late, possibly resulting in an accident and serious injury to yourself and others.

When driving in a very narrow lane, the sensors may detect and display vehicles in the second lane over. This will be the case if there are vehicles driving on the inside edge of their lane.

The system may issue causeless warnings in the area of guardrails or similar structural boundaries.

The two Blind Spot Assist sensors are built into the rear bumper. Make sure that the area



of the bumper around the sensors is free of dirt, ice and snow. The radar sensors must not be obstructed, for example, by bicycle carriers or overhanging luggage.

**!** In the event of a significant impact or damage affecting the bumpers, have the radar sensors checked by a qualified specialist workshop such as a Mercedes-Benz Center. Failure to do this can result in Blind Spot Assist not functioning correctly.

### Indicator and warning lamps



Exterior rear view mirror, driver's side

- ▶ Make sure that the radar sensors (▷ page 236) and Blind Spot Assist (▷ page 233) are switched on.
- ▶ Switch on the ignition. Red warning lamps ① in the exterior rear view mirrors come on.
- ▶ Start the engine. Yellow indicator lamps ① in the exterior rear view mirrors come on up to a speed of 20 mph (30 km/h).

Above a speed of 20 mph (30 km/h), yellow indicator lamps ① go out and the Blind Spot Assist is active. If the Blind Spot Assist detects a vehicle in its range, red warning lamp ① on the corresponding side of the vehicle comes on. The warning is issued each time a vehicle enters the area monitored by the Blind Spot Assist from behind or from the side. When you pass another vehicle, the warning is issued only when the speed differential is less than 7 mph (12 km/h).

When you shift the automatic transmission in reverse gear **R**, yellow indicator lamps ① in the exterior rear view mirrors goes out after approximately 3 seconds. The Blind Spot Assist is then not active.

The brightness of indicator lamps/warning lamps ① is controlled automatically depending on the brightness of the ambient light.

#### **Warning!**

The Blind Spot Assist is not active at speeds below approximately 20 mph (30 km/h). The yellow indicator lamps in the exterior rear view mirrors are illuminated. You will not be alerted to the presence of vehicles in the monitored area at these speeds.

It is the driver's responsibility at all times to be attentive to road, weather and traffic conditions and to provide the steering, braking and other driving inputs necessary to retain control of the vehicle. Failure to do so could result in recognizing dangers too late, possibly resulting in an accident and serious injury to yourself and others.

### Collision warning

If a vehicle is detected in the Blind Spot Assist range and you activate the turn signal, a two-tone warning will sound once. Red warning lamp ① on the corresponding side of the vehicle will flash.

#### **Warning!**

Do not change lanes or make turns, while red warning lamp ① is flashing. Doing so could result in an accident and serious injury to yourself and others.

- ▶ Remain on the lane that you are currently on until traffic conditions permit to change.

If the turn signal remains on, red warning lamp ① will flash to indicate that vehicles have been detected. No further audible warnings will sound.



## Lane Keeping Assist

The Lane Keeping Assist supports you at a vehicle speed of above 40 mph when you have set the display unit to miles in the Display Unit Speed-/Odometer: menu in the control system (> page 235). When you have set the display unit to km, the system supports you at a vehicle speed of above 60 km/h. When the Lane Keeping Assist detects lane markings, the system is designed to alert you in case you leave your lane unintentionally. A warning is usually issued when a front wheel is on the lane marking. An interval vibration in the steering wheel that lasts for up to 1.5 seconds will then alert you.

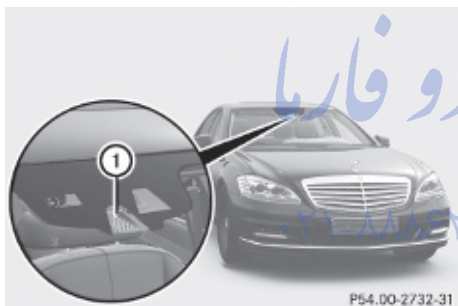

The Lane Keeping Assist monitors the area in front of your vehicle via camera ①.

The system can distinguish various conditions in order to alert you early enough and to avoid unnecessary warnings when crossing lane markings.

The warning is issued sooner when

- cutting a curve on the outside of the turn
- driving on very wide lanes such as highway lanes
- the system recognizes dividing lines because crossing them is often crucial due to soft shoulders or guardrails behind for example

The warning is issued later however when

- driving on narrow lanes
- cutting a curve on the inside of the turn

The system does not issue a warning when

- steering, braking, or accelerating in a clearly active manner, e.g. when changing lanes, passing, exiting a highway
- cutting a narrow curve
- making a very sharp turn
- a driving safety system such as the ABS, the BAS, or the ESC has been activated

When setting the turn signal in either direction, the warning will be suppressed. The system will issue a warning if a turn signal has been on for an extended period of time.

### ⚠ Warning!

The Lane Keeping Assist does not keep the vehicle in the lane. The Lane Keeping Assist is only an aid to the driver and may not always recognize lane markings properly or fail to recognize them at all.

The system may be impaired or unavailable when

- visibility is poor, e.g. due to snow, rain, fog, or heavy spray
- oncoming traffic, sun glare or reflection from other vehicles
- the camera area of the windshield is dirty, foggy, or otherwise obstructed
- lane markings are not present
- lane markings are worn, dark, or covered e.g. by snow or dirt
- the distance to the preceding vehicle is too short
- when lane markings are ambiguous, for example in road work sections
- lane markings change rapidly, e.g. on highway exits or turn-off lanes
- lanes are narrow and winding

The Lane Keeping Assist cannot take road and traffic conditions into account. It is the driver's responsibility at all times to be attentive to road, weather and traffic

conditions and to provide the steering, braking and other driving inputs necessary to retain control of the vehicle. Failure to do so could result in recognizing dangers too late, possibly resulting in an accident and serious injury to yourself and others.

### Switching on or off

- Switch on or off the Lane Keeping Assist via the control system (► page 233). The Lane Keeping Assist indicator  appears in the multifunction display.

## Climate control system

### Control panels

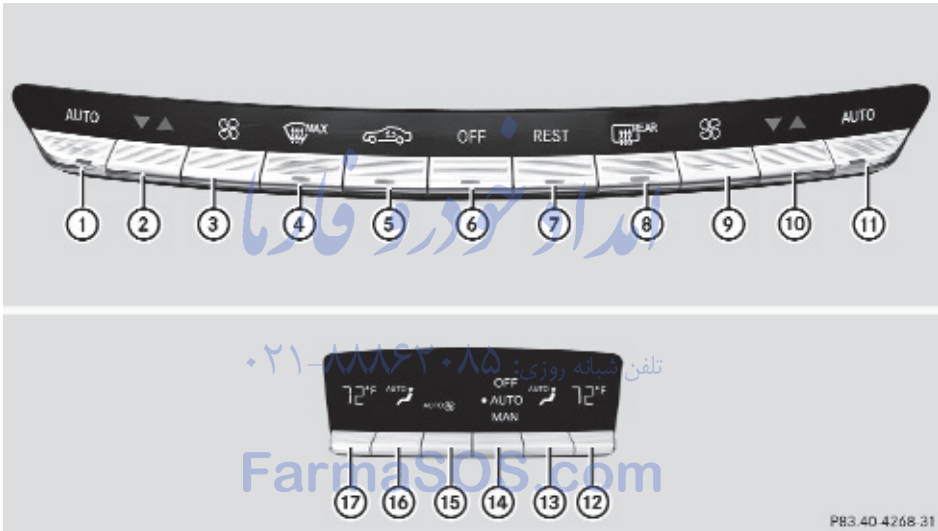

PB3.40 4268.31

Function	Recommendation/Notes	
<b>Front climate control panel</b>		
① Air distribution and air volume, driver's side (automatic mode)	① Switch on the automatic mode. The indicator lamp in button <b>AUTO</b> comes on.	(► page 366)
② Temperature control, driver's side	① Set the temperature to 72°F (22°C).	(► page 367)
③ Manual fan speed adjustment, driver's side		(► page 370)

	Function	Recommendation/Notes	
④	Front defroster	<b>i</b> Keep this setting selected only until the windshield or the side windows are clear again.	(▷ page 370)
⑤	Air recirculation	<b>i</b> Only use this function for a short time, e.g. in a tunnel. Otherwise, the windows can fog up due to lack of fresh air.	(▷ page 371)
⑥	Climate control on/off	<b>i</b> Switch on/off the climate control system.	(▷ page 366)
⑦	Residual heat/ventilation	<b>i</b> With the engine turned off, it is possible to continue to heat or ventilate the interior.	(▷ page 372)
⑧	Rear window defroster		(▷ page 372)
⑨	Manual fan speed adjustment, passenger side		(▷ page 370)
⑩	Temperature control, passenger side	<b>i</b> Set the temperature to 72°F (22°C).	(▷ page 367)
⑪	Air distribution and air volume, passenger side (automatic mode)	<b>i</b> Switch on the automatic mode. The indicator lamp in button <b>AUTO</b> comes on.	(▷ page 366)
	<b>Rear climate control panel</b>		
⑫	Temperature control, right	<b>i</b> Set the temperature to 72°F (22°C).	
⑬	Air distribution, right		
⑭	OFF Rear climate control on/off AUTO Rear climate control automatic mode MAN Rear climate control manual mode		
⑮	Air volume		

	Function	Recommendation/Notes
⑩	Air distribution, left	
⑪	Temperature control, left	<b>i</b> Set the temperature to 72°F (22°C).

### Notes on climate control system

**i** If you have the air distribution and air volume automatically controlled, you can adjust the temperature, footwell temperature and air flow. The following basic settings are recommended:

- Automatic air distribution control (▷ page 366)
- Temperature: 72°F (22°C) (▷ page 367)
- Footwell temperature: 0 (▷ page 214)
- Air flow: focused (▷ page 215)

The climate control system is operational whenever the engine is running. You can operate the climate control system in either the automatic or manual mode. The system cools or heats the interior depending on the selected interior temperature.

It can only function optimally when you are driving with the windows, the tilt/sliding sunroof or tilt/sliding panel closed.

Nearly all dust particles, pollutants and odors are filtered out before outside air enters the passenger compartment through the air distribution system.

### **⚠ Warning!**

Severe conditions (e.g. strong air pollution) may require replacement of the filter before its scheduled replacement interval. A clogged filter will reduce the air volume to the interior and the windows could fog up, impairing visibility and endangering you and others. Have a clogged filter replaced as soon as possible at an authorized Mercedes-Benz Center.

### **⚠ Warning!**

Follow the recommended settings for heating and cooling given on the following pages and in the “COMAND automatic climate control” section. Otherwise the windows could fog up, impairing visibility and endangering you and others.

- ▶ Keep the air intake grille in front of the windshield free of snow and debris.

Do not obstruct air flow by placing objects on the air flow-through exhaust slots below the rear window.

**i** If the vehicle interior is hot, ventilate the interior before driving off, see “Summer opening feature” (▷ page 309). The climate control will then adjust the interior temperature to the set value much faster.

The following climate control functions can be operated via COMAND:

- Temperature (▷ page 211)
- Air distribution (▷ page 212)
- Air volume (▷ page 212)
- Switching off cooling ( (▷ page 213)
- Central climate control (Mono) (▷ page 214)
- Footwell temperature (▷ page 214)
- Air flow from air vents (▷ page 215)
- Rear climate control (▷ page 215)

### Deactivating the climate control system

#### Warning!

When the climate control system is deactivated, the outside air supply and circulation are also deactivated. Only choose this setting for a short time. Otherwise the windows could fog up, impairing visibility and endangering you and others.

### Deactivating the front climate control

- ▶ **Deactivating:** Press rocker switch **[OFF]** up or down.

The indicator lamp in the rocker switch comes on. You will see Climate Control OFF in the COMAND display.

- ▶ **Reactivating:** Press rocker switch **[OFF]** up or down.

The indicator lamp in the rocker switch goes out. You will see the previous settings in the COMAND display.

### Deactivating the rear climate control

#### Operating on the front climate control panel

- ▶ Activate the Rear **[فوق]** function via COMAND (▷ page 215). This function is used to operate the rear climate control via COMAND and the rocker switches on the control panel from the front.

- ▶ **Deactivating:** Press rocker switch **[OFF]** up or down.

The indicator lamp in the rocker switch comes on.

- ▶ **Reactivating:** Press rocker switch **[OFF]** up or down.

The indicator lamp in the rocker switch goes out. The previous settings are once again in effect.

### Operating on the rear climate control panel

- ▶ **Deactivating:** Press rocker switch **(14)** (▷ page 363) up or down repeatedly until OFF mode is selected in display.

- ▶ **Reactivating:** Press rocker switch **(14)** up or down repeatedly until AUTO mode is selected in display.

or

- ▶ Press rocker switch **(14)** up or down repeatedly until MAN mode is selected in display.

### Air conditioning

The air conditioning is operational while the engine is running and cools the interior air to the temperature set by the operator. In addition, the air conditioning dehumidifies the interior air and helps prevent window fogging.

#### Warning!

If you deactivate the air conditioning, the vehicle will not be cooled when weather conditions are warm. The windows can fog up more quickly. Window fogging may impair visibility and endanger you and others.

- i** Condensated water may drip out from underneath the vehicle. This is normal and not an indication of a malfunction.

The air conditioning uses the refrigerant R134a. This refrigerant is free of CFCs which are harmful to the ozone layer.

The cooling function can be activated or deactivated via COMAND (▷ page 213).

### Automatic mode



When operating the climate control system in automatic mode, the interior air temperature, air volume and air distribution are adjusted automatically.

In automatic mode, cooling with dehumidification is switched on. This function can be switched off if necessary.

### **Warning!**



If you deactivate the air conditioning, the vehicle will not be cooled when weather conditions are warm. The windows can fog up more quickly. Window fogging may impair visibility and endanger you and others.

## Automatic mode with the front climate control

- ▶ Set the desired temperature (▷ page 367).
- ▶ **Activating:** Press rocker switch  up or down.  
The indicator lamp in the rocker switch comes on.
- ▶ **Deactivating:** Press rocker switch  up or down.  
or
- ▶ Adjust air distribution via COMAND (▷ page 212).  
The indicator lamp in rocker switch  goes out.

## Automatic mode with the rear climate control

### Operating on the front climate control panel



- ▶ Set the desired temperature (▷ page 367).
- ▶ Activate the Rear  function via COMAND (▷ page 215). This function is used to operate the rear climate control via COMAND and the rocker switches on the control panel from the front.
- ▶ **Activating:** Press rocker switch  up or down.  
The indicator lamp in the rocker switch comes on.
- ▶ **Deactivating:** Press rocker switch  up or down.

or

- ▶ Adjust air distribution via COMAND (▷ page 212).  
The indicator lamp in rocker switch  goes out.

- ▶ **Information:** To return to the standard display, activate the Front Climate Control function via COMAND (▷ page 216).

### Operating on the rear climate control panel

- ▶ Set the desired temperature (▷ page 367).
- ▶ **Activating:** Press rocker switch  (▷ page 363) repeatedly until AUTO mode is selected in the display.
- ▶ **Deactivating:** Press rocker switch  repeatedly until MAN mode or OFF mode is selected in the display.

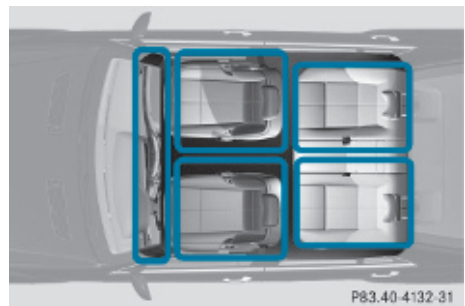

### Setting temperature

You can adjust the air temperature for each of the 5 zones separately. You should raise or lower the temperature setting in small increments, preferably starting at 72°F (22°C).





P83.40 4132-31

### Front temperature with front climate control panel



- **Increasing/decreasing:** Press rocker switches   up or down or use COMAND (► page 211).

The climate control system will correspondingly adjust the interior air temperature.

### Rear temperature with front climate control panel

- Activate the Rear  function via COMAND (► page 215). This function is used to operate the rear climate control via COMAND and the rocker switches on the control panel from the front.
- **Increasing/decreasing:** Press rocker switches   up or down.

### Rear temperature with rear climate control panel

- **Increasing/decreasing:** Press rocker switches   up or down.

### Adjusting air vents

#### **Warning!**

When operating the climate control, the air that enters the passenger compartment through the air vents can be very hot or very cold (depending on the set temperature). This may cause burns or frostbite to unprotected skin in the immediate area of the air vents.

Always keep sufficient distance between unprotected parts of the body and the air vents. If necessary, use the air distribution adjustment to direct the air to air vents in the vehicle interior that are not in the immediate area of unprotected skin.

For best possible performance of the climate control:

- Keep the air intake grille in front of the windshield free of snow, leaves, sticks, and any other debris.
  - Always keep all air vents and grilles in the passenger compartment free from obstruction.
- i** For draft-free ventilation, move the adjustable center and side air vents to the middle position.

### Center air vents

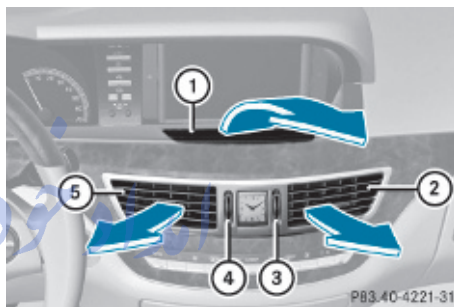

- ① Cockpit air vent, fixed
- ② Right center air vent, adjustable
- ③ Thumbwheel for air volume control for adjustable right center air vent
- ④ Thumbwheel for air volume control for adjustable left center air vent
- ⑤ Left center air vent, adjustable

- **Opening/closing:** Turn thumbwheels ③ and ④ upward or downward.



## Side air vents

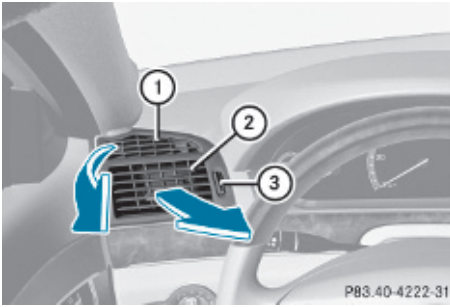

Example illustration driver's side

- ① Left side defroster air vent, fixed
- ② Left side air vent, adjustable
- ③ Thumbwheel for air volume control for adjustable left side air vent

► **Opening/closing:** Turn thumbwheel ③ upward or downward.

## Ventilated glove box

The glove box can be ventilated, for instance to cool its contents, when the climate control system is activated. The level of airflow to the glove box depends on the airflow and air distribution settings. The temperature of the air is approximately the same as that of the air flowing from the center air vents.

**!** Close the glove box air vent when heating the vehicle interior. Activate the air conditioning (cooling function) when the outside temperature is high. Otherwise, temperature-sensitive items stored in the glove box could be damaged.

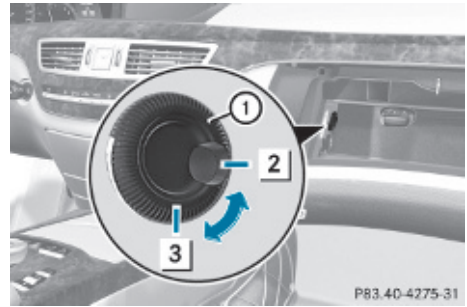

► **Opening:** Turn thumbwheel ① clockwise from position ③ to position ②.

► **Closing:** Turn thumbwheel ① counterclockwise from position ② to position ③.

## Rear center console air vents

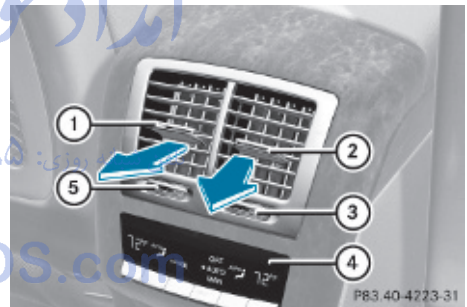

- ① Left rear center air vent, adjustable
- ② Right rear center air vent, adjustable
- ③ Thumbwheel for air volume control for right rear center air vent
- ④ Rear climate control panel
- ⑤ Thumbwheel for air volume control for left rear center air vent

► **Opening/closing:** Turn thumbwheel ③ or ⑤ in the required direction.

## B-pillar air vents

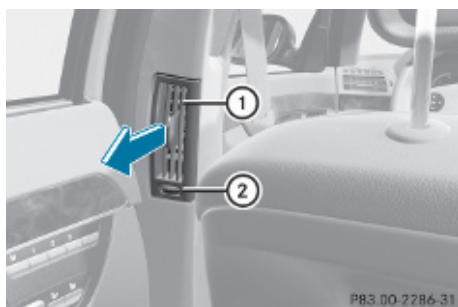

- ① Side air vent, adjustable
  - ② Thumbwheel for air volume control for side air vent
- **Opening/closing:** Turn thumbwheel ② to the left or to the right.



### Adjusting air distribution

The air distribution can be adjusted separately on each side of the passenger compartment.

### Air distribution in front/rear passenger compartment via COMAND

The air distribution can be adjusted via COMAND (▷ page 212).

### Air distribution in rear passenger compartment with rear climate control panel

Symbol	Function
	Directs air through the rear center air vents
	Directs air to the rear footwells
	Directs air through the rear center air vents and to the rear footwells

- Press rocker switches ⑬ or ⑭ (▷ page 363) up or down until the desired symbol appears in the display.



### Adjusting air volume

You can adjust the air volume separately on each side of the passenger compartment. You can adjust the air volume via COMAND (▷ page 212).

### Front air volume with the front climate control panel

- **Decreasing/increasing:** Press rocker switches  up or down.

### Rear air volume with the front climate control panel

- Activate the Rear  function via COMAND (▷ page 215). This function is used to operate the rear climate control via COMAND and the rocker switches on the control panel from the front.
- **Decreasing/increasing:** Press rocker switches  up or down.

### Rear air volume with the rear climate control panel

- **Decreasing/increasing:** Press rocker switch ⑮ (▷ page 363) up or down.

### Front defroster

You can use this setting to defrost the windshield, for example if it is iced up.

You can also defog the windshield and the front door windows.

- ① Keep this setting selected only until the windshield or the front door windows are clear again.

## Activating

- ▶ Press rocker switch  up or down. The indicator lamp in the rocker switch comes on.

The climate control switches to the following functions automatically:

- most efficient blower speed and heating power, depending on outside temperature
- air flows onto the windshield and the front door windows
- the air conditioning compressor switches on at outside temperatures above approximately 41°F (5°C) for air-drying

## Adjustments

You can adjust the air volume and the temperature when the front defroster is switched on. The air flow will remain on the windshield and front door windows.

- ▶ Press rocker switch  up or down to increase or decrease air volume to the desired level. The air volume increases/decreases to the next higher/lower blower speed and heating switches to the temperature that was set before the front defroster was switched on.

The indicator lamp in rocker switch  goes out.

or

- ▶ Press rocker switches  up or down. Heating switches to the temperature that was set before the front defroster was switched on.

The indicator lamp in rocker switch  goes out.

- ❗ The air conditioning compressor remains on even with the indicator lamp in button  goes out. This helps to prevent windshield from fogging.

## Deactivating

- ▶ Press rocker switch  up or down. The indicator lamp in the rocker switch goes out.

The previous settings are once again in effect, except air recirculation mode stays off.

## Windshield fogged on the outside

- ▶ Switch the windshield wipers on (▷ page 305).
- ▶ Press rocker switch  up or down. The indicator lamp in the rocker switch comes on.

## Maximum cooling MAX COOL

MAX COOL is only available in U.S. vehicles. MAX COOL is only operational when the engine is running.

If  is selected on both the left and right side and there is a high demand for cooling, the display MAXCOOL appears in the COMAND display.

This provides the fastest possible cooling of the vehicle interior (when windows and tilt/sliding sunroof or tilt/sliding panel are closed).

## Air recirculation mode

Switch to air recirculation mode to prevent unpleasant odors from entering the vehicle from the outside (e.g. before driving through a tunnel). This setting cuts off the intake of outside air and recirculates the air in the passenger compartment.

### Warning!

Fogged windows impair visibility, endangering you and others. If the windows begin to fog on the inside, switching off the air recirculation mode immediately should clear interior window fogging. If interior

window fogging persists, make sure the air conditioning is activated, or press button



- **Activating:** Press rocker switch  up or down.

The indicator lamp in the rocker switch comes on.

- ❗ The air recirculation mode is activated automatically at high outside temperatures.

The indicator lamp in rocker switch  is not lit when the air recirculation mode is switched on automatically.

A quantity of outside air is added when the cooling demand is not at maximum.

If the air conditioning has been turned off or the outside temperature is below 41°F (5°C), the air recirculation mode will not switch on automatically.

- **Deactivating:** Press rocker switch  up or down.

The indicator lamp in the rocker switch goes out.

- ❗ The manually selected air recirculation mode is deactivated automatically:

- after 5 minutes if the outside temperature is below approximately 41°F (5°C)
- after 5 minutes if the air conditioning is turned off
- after 30 minutes if the outside temperature is above approximately 41°F (5°C)

### Residual heat and ventilation

With the engine turned off, it is possible to continue to heat or ventilate the interior for up to 30 minutes. This feature makes use of the residual heat produced by the engine.

- ❗ If you switch on the residual heat function when outside temperatures are high, only the ventilation will be switched on.

- ❗ Regardless of the selected air volume, the blower operates at low speed when heating. In case of ventilation the blower operates at higher speed.

- ❗ How long the system will provide heating depends on the coolant temperature and the selected temperature. The blower will run at low speed regardless of the air distribution control setting.

- **Activating:** Switch off the ignition.

- Press rocker switch  up or down. The indicator lamp in the rocker switch comes on.

- **Deactivating:** Press rocker switch  up or down. The indicator lamp in the rocker switch goes out.

The residual heat is deactivated automatically: تلفن شد



- when the ignition is switched on
- after approximately 30 minutes
- if the battery voltage drops
- if the coolant temperature is too low

### Rear window defroster

#### Warning!

Any accumulation of snow and ice should be removed from the rear window before driving. Visibility could otherwise be impaired, endangering you and others.

The rear window defroster uses a large amount of power. To keep the battery drain to a minimum, switch off the defroster as soon as the rear window is clear. The defroster is switched off automatically after approximately 6 to 17 minutes of operation depending on the outside temperature.

- ▶ Switch on the ignition.
- ▶ **Switching on:** Press rocker switch  up or down.  
The indicator lamp in the rocker switch comes on.
- ▶ **Switching off:** Press rocker switch  up or down.

The rear window defroster switches off when the battery voltage is too low. Too many electrical consumers may be operating simultaneously.

- ▶ Switch off consumers that are currently not needed if required.

## Power tilt/sliding sunroof

### Opening and closing

 **Observe Safety notes, see page 56.**

#### **Warning!**

When opening or closing the tilt/sliding sunroof, make sure there is no danger of anyone being harmed by the opening/closing procedure.

The tilt/sliding sunroof is equipped with the express operation and automatic reversal function. If the movement of the tilt/sliding sunroof is blocked during the closing procedure, the tilt/sliding sunroof will stop and open slightly.

The tilt/sliding sunroof operates differently when the sunroof switch is pressed and held. See the “Closing when the tilt/sliding sunroof is blocked” section for details.

The opening/closing procedure of the tilt/sliding sunroof can be immediately halted by releasing the sunroof switch or, if the sunroof switch was moved past the resistance point and released, by moving the sunroof switch in any direction.

#### **Warning!**

The tilt/sliding sunroof is made out of glass. In the event of an accident, the glass may

shatter. This may result in an opening in the roof.

In a vehicle rollover, occupants not wearing their seat belts or not wearing them properly may be thrown out of the opening. Such an opening also presents a potential for injury for occupants wearing their seat belts properly as entire body parts or portions of them may protrude from the passenger compartment.

-  To avoid damaging the seals, do not transport any objects with sharp edges which can stick out of the tilt/sliding sunroof.

Do not open the tilt/sliding sunroof if there is snow or ice on the roof, as this could result in malfunctions.

If you cannot open or close the tilt/sliding sunroof due to a malfunction contact Roadside Assistance or an authorized Mercedes-Benz Center.

-  Please keep in mind that weather conditions can sometimes change rapidly. Make sure to close the tilt/sliding sunroof when leaving the vehicle. If water enters the vehicle interior, vehicle electronics could be damaged which is not covered by the Mercedes-Benz Limited Warranty.

-  You can also open or close the tilt/sliding sunroof using the SmartKey or the KEYLESS-GO function, see “Summer opening feature” (▶ page 309) and “Convenience closing feature” (▶ page 309).

-  After switching off the ignition or removing the SmartKey from the starter switch, you can operate the tilt/sliding sunroof until you open the driver’s or front passenger door. If no door was opened you can operate the tilt/sliding sunroof for up to 5 minutes.

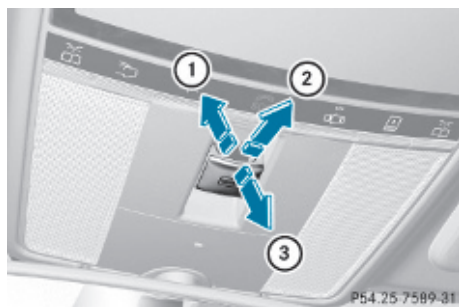

Sunroof switch

- ① Raising
- ② Opening
- ③ Closing

With the sunroof closed or raised, you can slide the sunroof screen forward and back.

- ▶ Switch on the ignition.

### Opening

- ▶ **Opening manually:** Press and hold the sunroof switch to the resistance point in direction of arrow ②.
- ▶ Release the sunroof switch when the desired position is reached.
- ▶ **Express operation:** To open the tilt/sliding sunroof completely, press the sunroof switch past the resistance point in direction of arrow ② and release.
- ▶ **Stopping during express operation:** Move the sunroof switch in any direction.

**i** Express opening is not available when the tilt/sliding sunroof is raised. The tilt/sliding sunroof must be closed first.

**i** When the tilt/sliding sunroof is open, resonance noises may result in addition to the usual wind noises. They are caused by minimal pressure changes in the passenger compartment. To reduce or eliminate these noises, change the position of the tilt/sliding sunroof or open a window slightly.

### Raising

- ▶ **Raising manually:** Press and hold the sunroof switch to the resistance point in direction of arrow ①.
- ▶ Release the sunroof switch when the desired position is reached.
- ▶ **Express operation:** To raise the tilt/sliding sunroof completely, press the sunroof switch past the resistance point in direction of arrow ① and release.
- ▶ **Stopping during express operation:** Move the sunroof switch in any direction.

**i** Express raising is not available when the tilt/sliding sunroof is open. The tilt/sliding sunroof must be closed first.

### Closing

- ▶ **Closing manually:** Pull and hold the sunroof switch to the resistance point in direction of arrow ③.
- ▶ Release the sunroof switch when the desired position is reached.
- ▶ **Express operation:** To close the tilt/sliding sunroof completely, pull the sunroof switch past the resistance point in direction of arrow ③ and release.
- ▶ **Stopping during express operation:** Move the sunroof switch in any direction.

### Closing when the tilt/sliding sunroof is blocked

#### **Warning!**

Make sure that nobody can become trapped and be seriously or even fatally injured when closing the tilt/sliding sunroof with greater force or without automatic reversal function.

If the movement of the tilt/sliding sunroof is blocked during the closing procedure (e.g. by ice or pollution), the tilt/sliding sunroof will stop and open slightly.

- ▶ Immediately after the tilt/sliding sunroof has stopped and opened because it was blocked, pull and hold the sunroof switch



in direction of arrow ③ until the tilt/sliding sunroof is fully closed.

The tilt/sliding sunroof closes with greater force.

If the tilt/sliding sunroof is blocked again and opens slightly:

- ▶ Immediately after the tilt/sliding sunroof was blocked and has opened, pull and hold the sunroof switch in direction of arrow ③ until the tilt/sliding sunroof is fully closed.  
The tilt/sliding sunroof closes without automatic reversal function.

#### **Warning!**

Pulling and holding the sunroof switch to close the tilt/sliding sunroof immediately after it had been blocked two times will cause the tilt/sliding sunroof to close without any reversal function for as long as you hold the sunroof switch.

#### **Synchronizing**

The tilt/sliding sunroof must be synchronized after a malfunction or if it does not open smoothly.

- ❗ If the tilt/sliding sunroof cannot be closed or synchronized, contact an authorized Mercedes-Benz Center or call Roadside Assistance.
- ▶ Switch on the ignition.
- ▶ Press and hold the sunroof switch in direction of arrow ① (▷ page 374) until the tilt/sliding sunroof is fully raised at the rear.
- ▶ Keep holding the sunroof switch in direction of arrow ① for approximately 1 second.
- ▶ Check the express operation feature (▷ page 374).  
If the tilt/sliding sunroof opens and closes completely, the roof is synchronized. Otherwise repeat the above steps.

#### **Panorama roof with power tilt/sliding panel**

##### **Extending and retracting the roller sunblinds**

The roller sunblinds only operate with the tilt/sliding panel closed. The front and rear roller sunblind can be operated individually.

- ▶ Switch on the ignition.

##### **Operating front roller sunblind**

#### **Warning!**

When extending the front roller sunblind, make sure no one is in danger of being injured by the extending procedure.

The front roller sunblind is equipped with the express operation and automatic reversal function. If the movement of the front roller sunblind is blocked during the extending procedure, the front roller sunblind will stop and retract slightly.

The extending of the front roller sunblind can be immediately halted by releasing the roof panel switch or, if the roof panel switch was moved past the resistance point and released, by moving the roof panel switch in any direction.

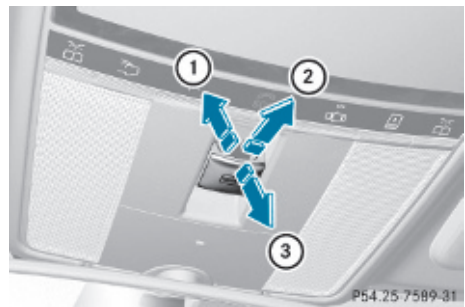

Roof panel switch

- ① Retracting
- ② Retracting
- ③ Extending

- ▶ **Retracting/Extending:** Move the roof panel switch to the resistance point in the



required direction of arrow ①, ② or ③ until the front roller sunblind has reached its desired position.

- ▶ **Express operation:** Move the roof panel switch past the resistance point in direction of arrow ①, ② or ③ and release. The front roller sunblind retracts/extends completely.
- ▶ **Stopping during express operation:** Move the roof panel switch in any direction.

### Operating rear roller sunblind from front

#### ⚠ Warning!

When extending the rear roller sunblind, make sure no one is in danger of being injured by the extending procedure.

The rear roller sunblind is equipped with the express operation and automatic reversal function. If the movement of the rear roller sunblind is blocked during the extending procedure, the rear roller sunblind will stop and retract slightly.

The extending of the rear roller sunblind can be immediately halted by pressing the sunblind switch again.



- ▶ **Retracting/Extending:** Press roller sunblind switch ①. The rear roller sunblind retracts/extends completely.
- ▶ **Stopping:** Press roller sunblind switch ① again.

To change directions, you must first extend or retract the rear roller sunblind completely.

### Operating rear roller sunblind from rear

#### ⚠ Warning!

When extending the rear roller sunblind, make sure no one is in danger of being injured by the extending procedure.

The rear roller sunblind is equipped with the express operation and automatic reversal function. If the movement of the rear roller sunblind is blocked during the extending procedure, the rear roller sunblind will stop and retract slightly.

The extending of the rear roller sunblind can be immediately halted by releasing the sunblind switch or, if the sunblind switch was moved past the resistance point and released, by pressing or pulling the sunblind switch again.



Rear door control panel

- ▶ **Retracting/Extending:** Press or pull roller sunblind switch ① until the rear roller sunblind has reached the desired position.
- ▶ **Express operation:** Press or pull roller sunblind switch ① past the resistance point and release. The rear roller sunblind retracts or extends completely.
- ▶ **Stopping during express operation:** Press or pull roller sunblind switch ① again.

## Opening and closing the panorama roof with power tilt/sliding panel

 **Observe Safety notes, see page 56.**

### **Warning!**

When opening or closing the tilt/sliding panel, make sure there is no danger of anyone being harmed by the opening/closing procedure.

The tilt/sliding panel is equipped with the express operation and automatic reversal function. If the movement of the tilt/sliding panel is blocked during the closing procedure, the tilt/sliding panel will stop and open slightly.

The tilt/sliding panel operates differently when the roof panel switch is pressed and held. See the “Closing when the tilt/sliding panel is blocked” section in this chapter for details.

The opening/closing procedure of the tilt/sliding panel can be immediately halted by releasing the roof panel switch or, if the roof panel switch was moved past the resistance point and released, by moving the roof panel switch in any direction.

### **Warning!**

The panorama roof with tilt/sliding panel is made out of glass. In the event of an accident, the glass may shatter. This may result in an opening in the roof.

In a vehicle rollover, occupants not wearing their seat belts or not wearing them properly may be thrown out of the opening. Such an opening also presents a potential for injury for occupants wearing their seat belts properly as entire body parts or portions of them may protrude from the passenger compartment.

 **To avoid damaging the seals, do not transport any objects with sharp edges which can stick out of the tilt/sliding panel. Do not open the tilt/sliding panel if there is snow or ice on the roof, as this could result in malfunctions.**

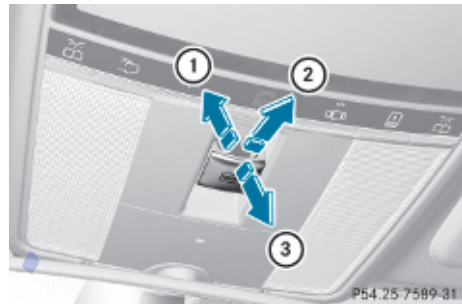

 Please keep in mind that weather conditions can sometimes change rapidly. Make sure to close the tilt/sliding panel when leaving the vehicle. If water enters the vehicle interior, vehicle electronics could be damaged which is not covered by the Mercedes-Benz Limited Warranty.



Roof panel switch

- ① Raising
- ② Opening
- ③ Closing

The tilt/sliding panel only operates with the roller sunblinds retracted.

-  You can also open or close the tilt/sliding panel using the SmartKey, see “Summer opening feature” (▷ page 309) or see “Convenience closing feature” (▷ page 309).
-  If the front roller sunblind is extended while the tilt/sliding panel is being raised, the roller sunblind will retract first.

► Switch on the ignition.

## Opening

- **Opening manually:** Press and hold the roof panel switch to the resistance point in direction of arrow ②.
- Release the roof panel switch when the desired position is reached.
- **Express operation:** To open the tilt/sliding panel completely, press the roof

panel switch past the resistance point in direction of arrow ② and release.

- ▶ **Stopping during express operation:** Move the roof panel switch in any direction.

**i** When the tilt/sliding panel is open, resonance noises may result in addition to the usual wind noises. They are caused by minimal pressure changes in the passenger compartment. To reduce or eliminate these noises, change the position of the tilt/sliding panel or open a window slightly.

### Raising

- ▶ **Raising manually:** Press and hold the roof panel switch to the resistance point in direction of arrow ①.
- ▶ Release the roof panel switch when the desired position is reached.
- ▶ **Express operation:** To raise the tilt/sliding panel completely, press the roof panel switch past the resistance point in direction of arrow ① and release.
- ▶ **Stopping during express operation:** Move the roof panel switch in any direction.

**i** Express raising is not available when the tilt/sliding panel is open. The tilt/sliding panel must be closed first.

### Closing

- ▶ **Closing manually:** Pull and hold the roof panel switch to the resistance point in direction of arrow ③.
- ▶ Release the roof panel switch when the desired position is reached.
- ▶ **Express operation:** To close the tilt/sliding panel completely, pull the roof panel switch past the resistance point in direction of arrow ③ and release.
- ▶ **Stopping during express operation:** Move the roof panel switch in any direction.

### Closing when the tilt/sliding panel is blocked

#### **Warning!**

Make sure that nobody can become trapped and be seriously or even fatally injured when closing the tilt/sliding panel without automatic reversal function.

If the movement of the tilt/sliding panel is blocked during the closing procedure (e.g. by ice or pollution), the tilt/sliding panel will stop and open slightly.

- ▶ Immediately after the tilt/sliding panel has stopped and opened because it was blocked, pull and hold the roof panel switch in direction of arrow ③ until the tilt/sliding panel is fully closed.

If the tilt/sliding panel is blocked again and opens slightly:

- ▶ Immediately after the tilt/sliding panel was blocked and has opened, pull and hold the roof panel switch in direction of arrow ③ until the tilt/sliding panel is fully closed. The tilt/sliding panel closes without automatic reversal function.

#### **Warning!**

Pulling and holding the roof panel switch to close the tilt/sliding panel immediately after it had been blocked two times will cause the tilt/sliding panel to close without any reversal function for as long as you hold the roof panel switch.

### Synchronizing the panorama roof

The tilt/sliding panel and front roller sunblinds must be synchronized after a malfunction or if the tilt/sliding panel does not open smoothly.

- !** Do not attempt to open the tilt/sliding panel before the tilt/sliding panel is properly synchronized. The tilt/sliding

panel could otherwise lock-up in the open position.

If the tilt/sliding panel cannot be closed or synchronized, contact an authorized Mercedes-Benz Center or call Roadside Assistance.

### Tilt/sliding panel and front roller sunblind

- ▶ Switch on the ignition.
- ▶ Pull and hold the roof panel switch several times in direction of arrow ③ (▷ page 375) until the tilt/sliding panel is fully closed.
- ▶ Keep holding the roof panel switch in direction of arrow ③ for approximately 1 second.
- ▶ Pull and hold the roof panel switch several times in direction of arrow ③ until the front roller sunblind is fully extended.
- ▶ Keep holding the roof panel switch in direction of arrow ③ for approximately 1 second.
- ▶ Check the express operation feature of the front roller sunblind.  
If the front roller sunblind retracts completely, the front roller sunblind is synchronized. Otherwise repeat the above steps.
- ▶ Check the express operation feature of the tilt/sliding panel (▷ page 377).  
If the tilt/sliding panel opens completely, the tilt/sliding panel is synchronized. Otherwise repeat the above steps.

### Rear roller sunblind

- ▶ Switch on the ignition.
- ▶ Pull roller sunblind switch ① (▷ page 376) in the rear door control panel several times until the rear roller sunblind is fully extended.

- ▶ Keep holding roller sunblind switch ① for approximately 1 second.
- ▶ Check the express operation feature of the front roller sunblind.  
If the rear roller sunblind retracts completely, the rear roller sunblind is synchronized. Otherwise repeat the above steps.

### Loading and storing

#### Loading instructions

##### Warning!

Always fasten items being carried as securely as possible using cargo tie-down hooks and fastening materials appropriate for the weight and size of the load.

In an accident, during hard braking or sudden maneuvers, loose items will be thrown around inside the vehicle. This can cause injury to vehicle occupants unless the items are securely fastened in the vehicle.

To help avoid personal injury during a collision or sudden maneuver, exercise care when transporting cargo. Do not pile luggage or cargo higher than the seat backrests.

The trunk is the preferred place to carry objects. Always use cargo tie-down hooks when transporting cargo. Do not place anything on the rear-window shelf.

Never drive a vehicle with the trunk open. Deadly carbon monoxide (CO) gases may enter vehicle interior resulting in unconsciousness and death.

### Load distribution

The total load weight including vehicle occupants and luggage/cargo should not exceed the total load limit indicated on the corresponding Tire and Loading Information placard located on the driver's door B-pillar (▷ page 418).

The handling characteristics of a fully loaded vehicle depends greatly on the load

distribution. It is therefore recommended to load the vehicle accordingly with the heaviest items being placed towards the front of the vehicle.

Please pay attention to and comply with the following instructions when loading the vehicle and transporting cargo:

- Always place items being carried against front or rear seat backrests, and fasten them as securely as possible.
- The heaviest portion of the cargo should always be kept as low as possible against front or rear seat backrests.

### Roof rack

For information about further roof rack equipment, contact an authorized Mercedes-Benz Center.

#### Warning!

Only use roof racks approved by Mercedes-Benz for your vehicle model to avoid damage to the vehicle.

Follow the manufacturer's installation instructions. Otherwise, an improperly attached roof rack system or its load could become detached from the vehicle.

Do not exceed the maximum roof load of 220 lb (100 kg).

Take into consideration that when the roof rack is loaded, the handling characteristics are different from those when operating the vehicle without the roof rack loaded.

Make sure

- you can raise the power tilt/sliding sunroof or the panorama roof with tilt/sliding panel completely
- you can open the trunk completely

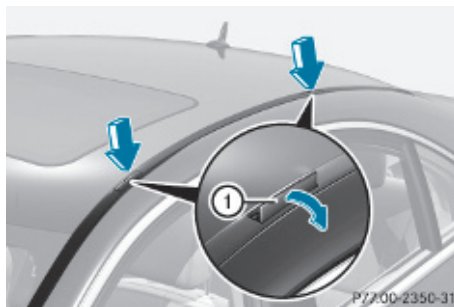

- ▶ Flip trim covers ① open.
- ▶ Only attach the roof rack to the anchorage points under trim covers ①.
- ▶ Observe manufacturer's instructions for installation.

### Parcel nets

#### Warning!

Parcel nets are intended for storing light-weight items only, such as road maps, mail, etc.

Heavy objects, objects with sharp edges, or fragile objects may not be transported in the parcel nets. In an accident, during hard braking, or sudden maneuvers, they could be thrown around inside the vehicle and cause injury to vehicle occupants.

Parcel nets cannot protect transported goods in the event of an accident.

Parcel nets are located in the front passenger footwell and on each side of the left and right trunk side walls.

### Hooks

#### Coat hooks

Two coat hooks are located in the vehicle, one on each side.

Use coat hooks to secure light-weight items only. The maximum permissible weight per coat hook is 6,6 lbs (3 kg).



- ▶ **Opening:** Press coat hook ①. The coat hook moves out.
- ▶ **Closing:** Press coat hook ① until it engages.

### Retaining hook

A retaining hook can be used to attach cargo items such as bags.

- ❗ Do not use the retaining hook to tie down cargo.



- ▶ Pull strap ① of retaining hook ② down.

### Cargo tie-down hooks

Four cargo tie-down hooks are located in the trunk.

Always follow loading instructions (▷ page 379).

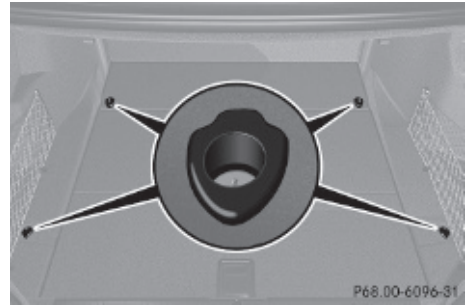

Carefully secure cargo by applying even load on all cargo tie-down hooks with rope of sufficient strength to hold down the cargo.

### Front storage compartments

#### ⚠ Warning!

To help avoid personal injury during a collision or sudden maneuver, exercise care when storing objects in the vehicle. Put luggage or cargo in the trunk if possible.

Do not pile luggage or cargo higher than the seat backrests.

Keep compartment lids closed. This will help to prevent stored objects from being thrown about and injuring vehicle occupants during

- braking
- vehicle maneuvers
- an accident

### Glove box

The glove box can be ventilated (▷ page 369).



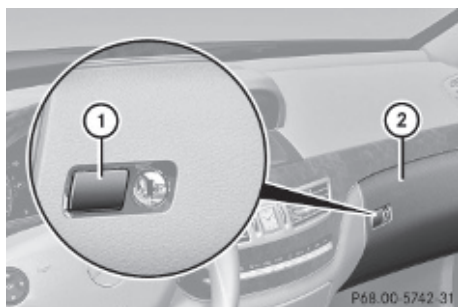

- ▶ **Opening:** Press glove box lid release ①.
- ▶ **Closing:** Push glove box lid ② upwards until it engages.

You can lock the glove box, e.g. when the vehicle is in the shop for service.

The glove box can only be locked or unlocked with the mechanical key.

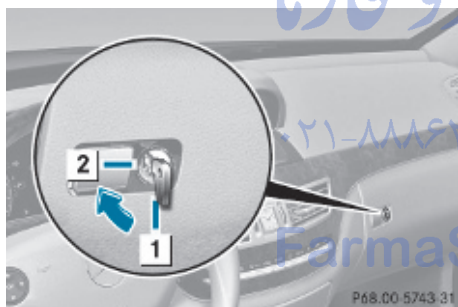

- ① Glove box unlocked
- ② Glove box locked



### Eyeglasses compartment

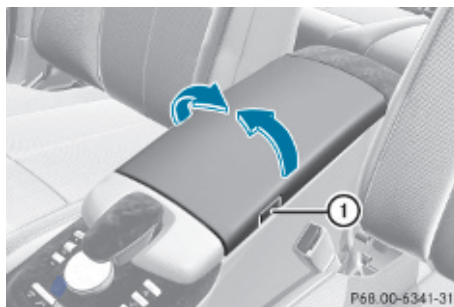

- ▶ **Opening:** Press eyeglasses compartment mark ①.
- ▶ **Closing:** Guide eyeglasses compartment upward until it engages.

### Front armrest storage compartment



- ① The Roadside Assistance button  (▶ page 389) and the Information button  (▶ page 392) are located in the storage compartment.

- ▶ **Opening storage compartment:** Press button ① and swing armrest upward.

### Door storage compartments

#### **Warning!**

Keep the door storage compartments closed while vehicle is in motion. Failure to do so may cause the seat belt to catch at the rear and prevent proper positioning of the seat belt.

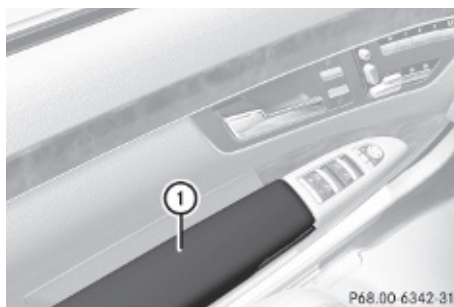

- ▶ **Opening:** Pull storage compartment lid ① upward.



## Rear storage compartments

### Warning!

To help avoid personal injury during a collision or sudden maneuver, exercise care when storing objects in the vehicle. Put luggage or cargo in the trunk if possible.

Do not pile luggage or cargo higher than the seat backrests.

Keep compartment lids closed. This will help to prevent stored objects from being thrown about and injuring vehicle occupants during

- braking
- vehicle maneuvers
- an accident

## Rear armrest storage compartment

**!** Do not sit on or lean your body weight against the armrest when it is folded down, as you could otherwise damage it.

**!** Before storing the armrest in the seat backrest, close the storage compartment cover.

► Fold the rear armrest down.



Vehicles without control panel in rear armrest

► **Opening:** Pull release catch ① and swing the storage compartment cover upward in direction of arrow.



Vehicles with control panel in rear armrest

► **Opening:** Press button ① and swing the storage compartment cover upward in direction of arrow.

## Rear seat storage compartment



► **Opening:** Pull handle ① backward in the direction of arrow.

## Rear storage box

► Fold the rear armrest down.

**!** Do not sit on or lean your body weight against the armrest when it is folded down, as you could otherwise damage it.

**i** When the rear seats are in their basic position, you can open the cover more easily.

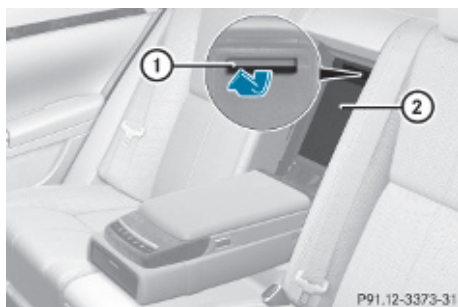

- ▶ Pull handle ① upward in direction of arrow.
- ▶ Swing cover ② down.

### Storage bags

#### Warning!

Storage bags are intended for storing light-weight items only.

Heavy objects, objects with sharp edges or fragile objects may not be transported in the storage bag. In an accident, during hard braking, or sudden maneuvers, they could be thrown around inside the vehicle and cause injury to vehicle occupants.

Storage bags cannot protect transported goods in the event of an accident.

Storage bags are located on the back of the front seats.

### Storage spaces under trunk floor

#### Front storage space

You can place a suitcase in the hollow under the front part of the trunk floor.

- ❗ Fold down the suitcase handle before closing the trunk to avoid damaging the trunk lid.

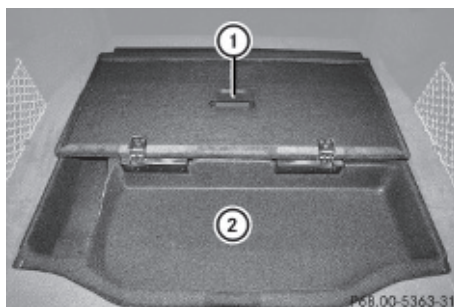

- ① Trunk floor
- ② Suitcase storage space

### Rear storage space

Only the S 600 is equipped with the rear storage space.

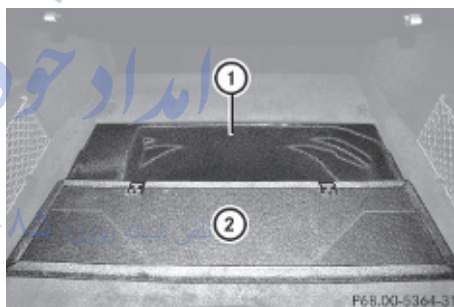

- ① Storage space
- ② Trunk floor

### Useful features

#### Cup holders

#### Warning!

In order to help prevent spilling liquids on vehicle occupants and/or vehicle equipment, only use containers that fit into the cup holder. Use lids on open containers and do not fill containers to a height where the contents, especially hot liquids, could spill during braking, vehicle maneuvers, or in an accident. Liquids spilled on vehicle occupants may cause serious personal injury. Liquids spilled on vehicle equipment may cause

damage not covered by the Mercedes-Benz Limited Warranty.

When not in use, keep the cup holder closed. An open cup holder may cause injury to you or others when contacted during braking, vehicle maneuvers, or in an accident.

Keep in mind that objects placed in the cup holder may come loose during braking, vehicle maneuvers, or in an accident and be thrown around in the vehicle interior. Objects thrown around in the vehicle interior may cause an accident and/or serious personal injury.

### Cup holder in front center console

The cup holder can be removed for cleaning purposes.

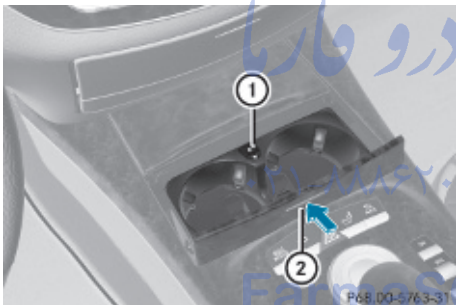

- ▶ **Opening:** Press chrome label (2).
- ▶ **Removing:** Press latch (1) back and pull cup holder out.
- ▶ **Inserting:** Insert cup holder and press latch (1) forward.
- ▶ **Closing:** Fold cover in until it engages.

### Rear cup holder

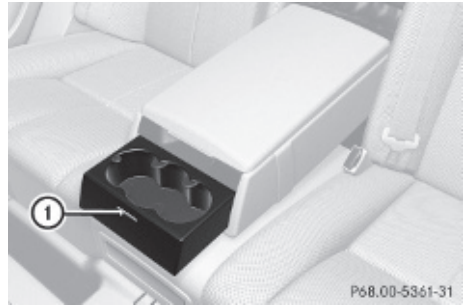

Vehicles without control panel in rear armrest

- ▶ **Opening:** Press chrome label (1).



Vehicles with control panel in rear armrest

- ▶ **Opening:** Press front of cup holder (1).

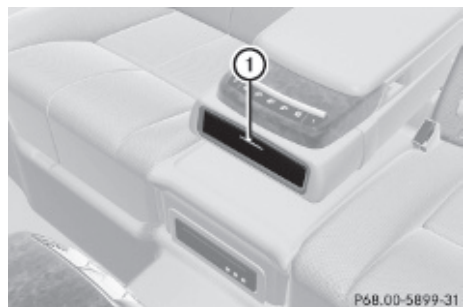

Vehicles with Rear Seat Entertainment

- ▶ **Opening:** Press front of cup holder (1).

## Sun visors

### Warning!

Do not use the vanity mirror while driving. Keep the vanity mirrors in the sun visors closed while vehicle is in motion. Reflected glare can endanger you and others.

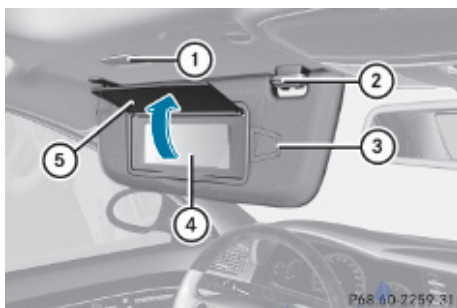

- ① Vanity mirror lamp
- ② Mounting
- ③ Holder, e.g. for gas cards
- ④ Front vanity mirror
- ⑤ Front vanity mirror cover

### Glare through the windshield

- ▶ Flip sun visor down when you experience glare.

### Glare through a door window

- ▶ Close vanity mirror cover ⑤ if opened.
- ▶ Disengage sun visor from mounting ②.
- ▶ Pivot sun visor to the side.

### Vanity mirror

The vanity mirror lamp only functions when the sun visor is engaged in mounting ②.

- ▶ Flip sun visor down.
- ▶ Lift up vanity mirror cover ⑤.  
Vanity mirror lamp ① comes on.

## Rear vanity mirrors



- ▶ **Opening:** Press mark ①.  
The rear vanity mirror swings down in direction of arrow.
- ▶ **Closing:** Swing rear vanity mirror up until it engages.

## Rear window sunshade

### Warning!

When operating the rear window sunshade make sure there is no danger of anyone being harmed by the extending or retracting procedure.

The extending or retracting procedure can be immediately halted by briefly pressing rear window sunshade switch. To reverse direction of movement, press rear window sunshade switch again.

### Observe Safety notes, see page 56.

You can also operate the rear window sunshade via COMAND (▷ page 207). If you operate the rear window sunshade via COMAND, this takes precedence over the rear window sunshade buttons on the rear doors.

- ① Operating the rear window sunshade from the rear is not possible if you activate the override switch (▷ page 61).
- ① The rear window sunshade is switched off at temperatures below  $-4^{\circ}\text{F}$  ( $-20^{\circ}\text{C}$ ).

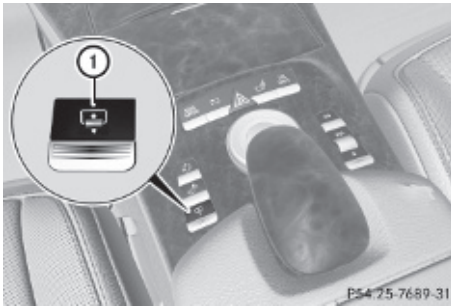

- ▶ Switch on the ignition.
- ▶ **Extending/Retracting:** Press rear window sunshade switch ① briefly.



- ▶ Switch on the ignition.
- ▶ **Extending/Retracting:** Press or pull the rear window sunshade switch ① past the resistance point.

## Ashtrays

### Center console ashtray

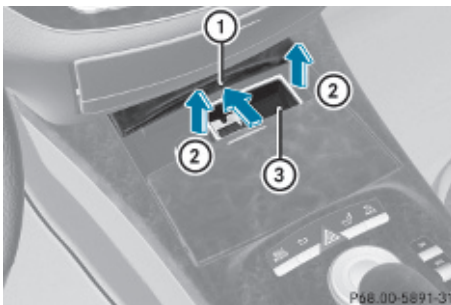

- ▶ **Opening:** Press mark on cover ① forward.
- ▶ **Removing ashtray insert:** Grab ashtray insert ③ on the grooved side and pull it up and out in the direction indicated by arrows ②.
- ▶ **Reinstalling ashtray insert:** Push ashtray insert ③ back into the frame until it engages.
- ▶ **Closing:** Briefly press mark on cover ①.

### Rear door ashtray



- ▶ **Opening:** Lift up cover ②.
- ▶ **Removing ashtray insert:** Press open cover ② outwards beyond the stop. Ashtray insert ① pops out of the holder.
- ▶ Remove ashtray insert ① by pulling it upwards.
- ▶ **Reinstalling ashtray insert:** Push ashtray insert ① back into frame until it engages.
- ▶ **Closing:** Push cover ② downwards.

## Cigarette lighters

⚠ **Observe Safety notes, see page 56.**

### ⚠ Warning!

Never touch the heating element or sides of the lighter; they are extremely hot. Hold the knob only.

Make sure any children traveling with you do not injure themselves or start a fire with the hot cigarette lighter.



To avoid possible injury to children sitting in the rear seat, activate the override switch. Activation of the override switch deactivates the rear center console lighter.

If the engine is off and the cigarette lighter is being used extensively, the vehicle battery may become discharged.

- ▶ Open the cover (▷ page 387).



- ▶ Switch on the ignition.
- ▶ Push in cigarette lighter ①. Cigarette lighter ① will pop out automatically when hot.
- ▶ Take out cigarette lighter ①.
- ▶ Reinsert cigarette lighter ① in its socket after use.



Rear center console

- ▶ Switch on the ignition.
- ▶ Open the cover.
- ▶ Push in cigarette lighter ①. Cigarette lighter ① will pop out automatically when hot.

## Power outlets

The power outlets can be used to accommodate 12V DC electrical accessories (e.g. auxiliary lamps, mobile phone chargers) up to a maximum of 15 A (180 W).

If the engine is off and the power outlets are being used extensively, the vehicle battery may become discharged.

- ▶ Switch on the ignition.

## Power outlet in glove box

- ▶ Open the glove box (▷ page 381).

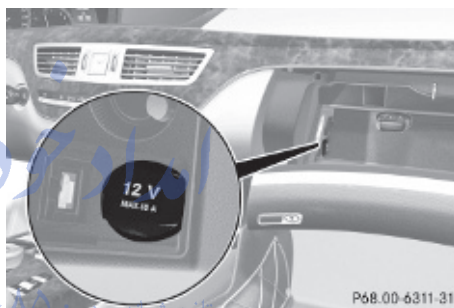

## Power outlet in rear center console

- ▶ Open the cover.



## Power outlet in trunk



## Tele Aid

**!** In order to activate the Tele Aid system, a subscriber agreement must be completed. To ensure your system is activated and operational, please press Information button  to perform the acquaintance call. Failure to complete either of these steps may result in a system that is not activated.

If you have any questions regarding activation, please call the Customer Assistance Center at 1-800-FOR-MERCEdes (1-800-367-6372) (USA only) or 1-888-923-8367 (Canada only).

Shortly after the completion of your Tele Aid acquaintance call, you will receive a user ID and password in the mail. You may use this password to access the Tele Aid section in “Owner’s Online” at [www.mbusa.com](http://www.mbusa.com) (USA only). The “My Tele Aid” section will give you access to account information, remote door unlock and more.

The Tele Aid system is available if

- it has been activated and is operational. Activation requires a subscription for monitoring services, connection and cellular air time
- vehicle battery power is available
- the relevant cellular phone network and GPS signals are available and pass the

information on to the Customer Assistance Center

- i** Location of the vehicle on a map is only possible if the vehicle is able to receive signals from the GPS satellite network and pass the information on to the Customer Assistance Center.



## The Tele Aid system

(Telematic Alarm Identification on Demand)

The Tele Aid system consists of three types of response:

- Automatic and manual emergency
- Roadside Assistance
- Information

To adjust the speaker volume during a Tele Aid call do the following:

- ▶ Press button  or  on the multifunction steering wheel.

or

- ▶ Use the COMAND volume thumbwheel  on the lower part of the front center console (▷ page 87).

Be sure to check “Owner’s Online” at [www.mbusa.com](http://www.mbusa.com) (USA only) for more information and a description of all available features.

## System self-test



The system performs a self-test after you have switched on the ignition.

### Warning!

A malfunction in the system has been detected if any or all of the following conditions occur:

- The indicator lamp in the SOS button does not come on during the system self-test.
- The indicator lamp in Roadside Assistance button  does not come on during the system self-test.



- The indicator lamp in Information button  does not come on during the system self-test.
- The indicator lamp in the SOS button, Roadside Assistance button , or Information button  remains illuminated constantly in red after the system self-test.
- The message Tele Aid Inoperative or Tele Aid Not Activated appears in the multifunction display after the system self-test

If a malfunction is indicated as outlined above, the system may not operate as expected. In case of an emergency, help will have to be summoned by other means.

Have the system checked at the nearest Mercedes-Benz Center or contact the Customer Assistance Center at 1-800-FOR-MERcedes (1-800-367-6372) (USA only) or 1-888-923-8367 (Canada only) as soon as possible.

## Emergency calls

**!** In order to activate the Tele Aid system, a subscriber agreement must be completed. To ensure your system is activated and operational, please press Information button  to perform the acquaintance call. Failure to complete either of these steps may result in a system that is not activated.

If you have any questions regarding activation, please call the Customer Assistance Center at 1-800-FOR-MERcedes (1-800-367-6372) (USA only) or 1-888-923-8367 (Canada only).

An emergency call is initiated automatically following an accident in which the Emergency Tensioning Devices (ETDs) or air bags have deployed.

**i** An automatically initiated Tele Aid emergency call cannot be canceled.

An emergency call can also be initiated manually (▷ page 391).

Once the emergency call is in progress, the indicator lamp in the SOS button will begin to flash. The message Connecting Call appears in the multifunction display. Emergency Call Activated appears in the COMAND display and the audio system is muted. When the connection is established, the message Call Connected appears in the multifunction display. Emergency Call Activated appears in the COMAND display.

All information relevant to the emergency, such as the location of the vehicle (determined by the GPS satellite location system), vehicle model, identification number and color are generated.

**i** While the emergency call message Emergency Call Activated is displayed, operation of the audio system or COMAND system is not possible.

The climate control system can be operated using the climate control panel (▷ page 211). تلفن: ۰۲۱-۸۸۸۶۲۰۸

A voice connection between the Customer Assistance Center and the occupants of the vehicle will be established automatically soon after the emergency call has been initiated. The Customer Assistance Center will attempt to determine the nature of the emergency more precisely, provided they can speak to an occupant of the vehicle.

**i** If no vehicle occupant responds, an ambulance will be sent to the vehicle immediately.

### **Warning!**

If the indicator lamp in the SOS button is flashing continuously and there was no voice connection to the Customer Assistance Center established, then the Tele Aid system could not initiate an emergency call (e.g. the relevant cellular phone network is not available).

The message **Call Failed** appears in the multifunction display for approximately 10 seconds.

Should this occur, assistance must be summoned by other means.

- i** During the emergency call the telephone is switched off automatically and must be switched back on to make a call.
- i** The “911” emergency call system is a public service. Using it without due cause is a criminal offense.

### Initiating an emergency call manually

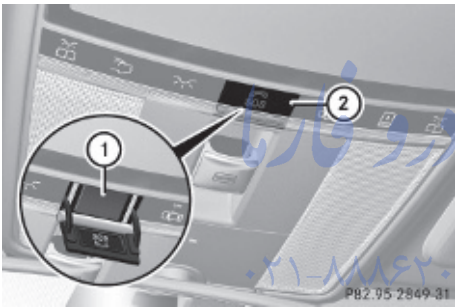

- ▶ Briefly press on cover ② to open.
- ▶ Press SOS button ① briefly. The indicator lamp in SOS button ① will flash until the emergency call is concluded.
- ▶ Wait for a voice connection to the Customer Assistance Center.
- ▶ Close cover ② after the emergency call is concluded.

#### **⚠ Warning!**

If you feel at any way in jeopardy when in the vehicle (e.g. smoke or fire in the vehicle, vehicle in a dangerous road location), please do not wait for voice contact after you have pressed the emergency button. Carefully leave the vehicle and move to a safe location. The Customer Assistance Center will automatically contact local emergency officials with the vehicle's approximate location if they receive an automatic SOS

signal and cannot make voice contact with the vehicle occupants.

- ▶ **Terminating calls:** Press button  on the multifunction steering wheel.

or

- ▶ Press the respective button for ending a telephone call on the telephone keypad.

### Roadside Assistance button

- ▶ Open the front armrest storage compartment (▷ page 382).

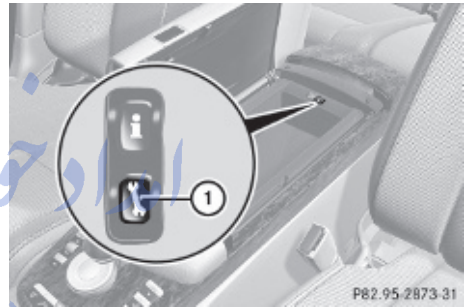

- ▶ Press and hold Roadside Assistance button ① for longer than 2 seconds. A call to a Mercedes-Benz Roadside Assistance dispatcher will be initiated. The indicator lamp in Roadside Assistance button ① will flash while the call is in progress. The message **Connecting Call** will appear in the multifunction display. **Roadside Assistance Activated** appears in the COMAND Display. The audio system or the COMAND system is muted.

When the connection is established, the message **Call Connected** appears in the multifunction display. **Roadside Assistance Activated** appears in the COMAND display. The Tele Aid system will transmit data generating the vehicle identification number, model, color and location (subject to availability of cellular and GPS signals).

**i** The COMAND system display indicates that a Tele Aid call is in progress. While the call is connected you can change to the navigation menu by pressing shortcut button . Spoken commands are not available.



A voice connection between the Roadside Assistance dispatcher and the occupants of the vehicle will be established.

► Describe the nature of the need for assistance.

The Mercedes-Benz Roadside Assistance dispatcher will either dispatch a qualified Mercedes-Benz technician or arrange to tow your vehicle to the nearest authorized Mercedes-Benz Center. For services such as labor and/or towing, charges may apply. Refer to the Roadside Assistance manual for more information.

Sign and Drive services (USA only):

Services such as a jump start, a few gallons of fuel or the replacement of a flat tire with the vehicle spare wheel are obtainable at no charge.

**i** If the indicator lamp in Roadside Assistance button  is flashing continuously and there was no voice connection to the Customer Assistance Center established, then the Tele Aid system could not initiate a Roadside Assistance call (e.g. the relevant cellular phone network is not available). The message **Call Failed** appears in the multifunction display. **Call could not be connected!** appears in the COMAND display. Confirm the message pressing  (► page 79).

If the indicator lamp in Roadside Assistance button  is flashing continuously and there was no voice connection established, then the Tele Aid system could not initiate a Roadside Assistance call (e.g. the relevant cellular phone network is not available). The message **Call Failed** appears in the multifunction display. **Call**

**could not be connected!** appears in the COMAND display. Confirm the message pressing  (► page 79).

► **Terminating calls:** Press button  on the multifunction steering wheel.

or

► Press the respective button for ending a telephone call on the telephone keypad.

### Information button

► Open the front armrest storage compartment (► page 382).

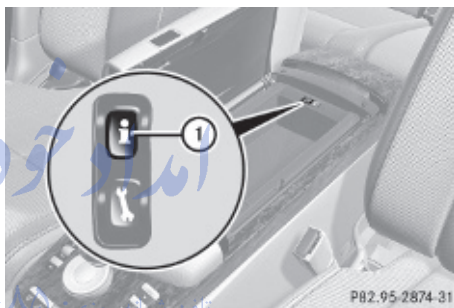

► Press and hold Information button  for longer than 2 seconds.

A call to the Customer Assistance Center will be initiated. The indicator lamp in Information button  will flash while the call is in progress. The message **Connecting Call** will appear in the multifunction display. **Information Call Activated** appears in the COMAND display. The audio system or the COMAND system is muted.



When the connection is established, the message **Call Connected** appears in the multifunction display. **Information Call Activated** appears in the COMAND display. The Tele Aid system will transmit data generating the vehicle identification number, model, color and location (subject to availability of cellular and GPS signals).

**i** The COMAND system display indicates that a Tele Aid call is in progress. While the

call is connected you can change to the navigation menu by pressing shortcut button . Spoken commands are not available.

A voice connection between the Customer Assistance Center representative and the occupants of the vehicle will be established. Information regarding the operation of your vehicle, the nearest authorized Mercedes-Benz Center or Mercedes-Benz USA products and services is available to you.

For more details concerning the Tele Aid system, please visit **www.mbusa.com** (USA only), log in to “Owner’s Online” and visit the “My Tele Aid” section to learn more.

- i** If the indicator lamp in Information button  is flashing continuously and there was no voice connection established, then the Tele Aid system could not initiate an Information call (e.g. the relevant cellular phone network is not available). The message **Call Failed** appears in the multifunction display. **Call could not be connected!** appears in the COMAND display. Confirm the message pressing  (**>** page 79).

► **Terminating calls:** Press button  on the multifunction steering wheel.

or

► Press the respective button for ending a telephone call on the telephone keypad.

## Call priority

If other service calls such as a Roadside Assistance call or Information call are active, an emergency call is still possible. In this case, the emergency call will take priority and override all other active calls.

The indicator lamp in the respective button flashes until the call is concluded. Automatic initiated emergency calls can only be terminated by a Customer Assistance Center representative. All other calls can be terminated by pressing button  on the

multifunction steering wheel or the respective button for ending a telephone call on the telephone keypad.



## Destination Download to the COMAND system

- i** The components and operating principles of the COMAND system can be found on (**>** page 77).

Destination Download allows you access to a database of over 10 million points of interest (POIs) that can be downloaded to your vehicle’s navigation system. If you know the destination, the address can be downloaded, or can be provided with points of interests near your location.

## Route guidance

You will be prompted to confirm that route guidance to the entered address is to be started.

- Slide  or rotate  to select Yes menu item and confirm by pressing .

The system calculates the route and subsequently starts the route guidance to the defined address.

- i** If you select No, you can save the address to your address book.

- i** The Destination Download feature is available if the relevant mobile phone network is available and data connection is possible.

## Search & Send

- i** In order to utilize Search & Send your vehicle must be equipped with Tele Aid, Navigation, and an active Tele Aid subscription.

“Search & Send” is a navigation destination address entry service. A destination address located using Google Maps® or Yahoo Local Maps® websites can be delivered via Tele Aid

directly to the Navigation system in your vehicle.

### Specify and Send a Destination Address

**i** Please refer to any specific instructions provided by either website regarding entering or sending an address. Each website functions differently and is subject to change.

- ▶ Go to **www.maps.google.com** or **www.maps.yahoo.com** and enter a destination address in the address entry field.
- ▶ Depending on which website you are using, click on the appropriate button to send the destination address to your Tele Aid account email address.
- ▶ Enter the email address you specified when you activated your Tele Aid account in the appropriate field when the “Send” dialog box appears.
- ▶ Click “Send”.

### Retrieve Destination Address

- ▶ Press the Tele Aid Information button to begin the download of the destination address to your vehicle's navigation system.
  - i** If you have sent more than one destination address to your vehicle you must make one Information call for each destination address download.
  - ▶ Select Yes when the message appears asking if you would like to start navigation. This will open the start navigation screen.
  - ▶ Select Start.
- or
- ▶ Select No if you wish to save the downloaded destination address in the From Memory destination list for future use.

**i** Destination addresses will download in the same order they were sent. If you have

multiple Mercedes-Benz vehicles equipped with Tele Aid and active accounts, each destination address sent will be retrievable by all vehicles associated with the e-mail address you specified for your Tele Aid account.

### Remote door unlock

---

In case you have locked your vehicle unintentionally (e.g. SmartKey inside vehicle), and the reserve SmartKey is not available:

- ▶ Contact the Customer Assistance Center at 1-800-FOR-MERCEdes (1-800-367-6372) (USA only) or 1-888-923-8367 (Canada only). You will be asked to provide your password.
- ▶ Then return to your vehicle at the time arranged with the Customer Assistance Center and pull the trunk lid handle for a minimum of 20 seconds until the indicator lamp in the SOS button is flashing. The message **Connecting Call** appears in the multifunction display.

As an alternative, you may unlock the vehicle via Internet in the “My Tele Aid” section of “Owner’s Online”, using your ID and password (USA only).

- i** The remote door unlock feature is available if the relevant cellular phone network is available.
- The SOS button will flash and the message **Connecting Call** will appear in the multifunction display to indicate receipt of the door unlock command.
- If the trunk lid handle was pulled for more than 20 seconds before door unlock authorization was received, you must wait 15 minutes before pulling the trunk lid handle again.

### Remote door lock

---

If you have forgotten to lock your vehicle and are no longer near it, you can have it locked remotely through the Customer Assistance Center.

The vehicle can be remotely locked within four days after the ignition has been switched off.

- ▶ Contact the Customer Assistance Center at 1-800-FOR-MERcedes (1-800-367-6372) (USA only) or 1-888-923-8367 (Canada only).

You will be asked to provide your password.

When you are inside your vehicle the next time and switch on the ignition, the message Tele Aid Doors Locked Remotely will appear on the multifunction display.

- i** The remote door lock feature is available if the relevant cellular phone network is available and data connection is possible.

### Automatic Maintenance Call

Your vehicle is equipped with a feature that considerably enhances vehicle care. Just prior to reaching a vehicle maintenance milestone, Tele Aid transmits important vehicle maintenance information that alerts your authorized Mercedes-Benz Center of required service. This is automatic and does not require driver intervention. This feature allows your preferred Mercedes-Benz Center to significantly improve the process of arranging your service appointment and ensures that your vehicle receives the best possible care.

- i** The Automatic Maintenance Call feature is available if the relevant telephone network is available and data connection is possible.

### Stolen Vehicle Recovery Services

In the event your vehicle was stolen:

- ▶ Report the incident to the police. The police will issue a numbered incident report.
- ▶ Pass this number on to the Customer Assistance Center along with your password. The Customer Assistance Center will then attempt to covertly contact the vehicle's Tele Aid system. Once the vehicle is located, the Customer Assistance Center will contact the local law enforcement and you. The vehicle's location will only be provided to law enforcement.

- i** If the anti-theft alarm stays on for more than 30 seconds, the Tele Aid system will notify the Customer Assistance Center automatically.

### Garage door opener

The integrated remote control can operate up to three separately controlled devices compatible with HomeLink® or some other systems.

#### **⚠ Warning!**

Before programming the integrated remote control to a garage door opener or gate operator, make sure people and objects are out of the way of the device to prevent potential harm or damage. When programming a garage door opener, the door moves up or down. When programming a gate operator, the gate opens or closes.

Do not use the integrated remote control with any garage door opener that lacks safety stop and reverse features as required by U.S. federal safety standards (this includes any garage door opener model manufactured before April 1, 1982). A garage door that cannot detect an object - signaling the door to stop and reverse - does not meet current U.S. federal safety standards.



When programming a garage door opener, park vehicle outside the garage.

Do not run the engine while programming the integrated remote control. Inhalation of exhaust gas is hazardous to your health. All exhaust gas contains carbon monoxide (CO), and inhaling it can cause unconsciousness and possible death.

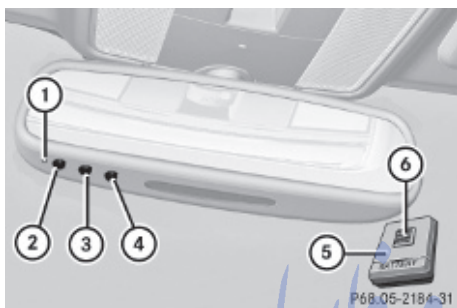

Interior rear view mirror with integrated remote control

Hand-held remote control ⑤ is not part of the vehicle equipment.

### Programming the integrated remote control

- ▶ **Step 1:** Switch on the ignition.
- ▶ **Step 2:** If you have previously programmed a signal transmitter button and wish to retain its programming, proceed to step 3.

or

- ▶ If you are programming the integrated remote control for the first time, press and hold the two outer signal transmitter buttons ② and ④ and release them when indicator lamp ① begins to flash after approximately 20 seconds.

Do not hold the buttons for longer than 30 seconds.

This procedure erases any previous settings for all three channels and initializes the memory. If you later wish to program a second and/or third hand-held transmitter to the remaining two signal

transmitter buttons, do not repeat this step and begin directly with step 3.

- ▶ **Step 3:** Hold the end of hand-held remote control ⑤ of the device you wish to train approximately 2 to 12 in (5 to 30 cm) away from the signal transmitter button (②, ③ or ④) to be programmed, while keeping indicator lamp ① in view.
- ▶ **Step 4:** Using both hands, simultaneously press hand-held remote control button ⑥ and the desired signal transmitter button (②, ③ or ④). Do not release the buttons until step 5 is completed. Indicator lamp ① will flash, first slowly and then rapidly.

**i** Indicator lamp ① flashes immediately the first time the signal transmitter button is programmed. If this button has already been programmed, the indicator lamp will start flashing after 20 seconds.

- ▶ **Step 5:** After indicator lamp ① changes from a slow to a rapidly flashing light, release the hand-held remote control button and the signal transmitter button.
- ▶ **Step 6:** Press and hold the just-trained signal transmitter button (②, ③ or ④) and observe indicator lamp ①.

If indicator lamp ① stays on constantly, programming is complete and your device should activate when the respective signal transmitter button (②, ③ or ④) is pressed and released.

**i** If indicator lamp ① flashes rapidly for approximately 2 seconds and then turns to a constant light, continue with programming steps 8 through 12 as your garage door opener may be equipped with the “rolling code” feature.

- ▶ **Step 7:** To program the remaining two signal transmitter buttons, repeat the steps above starting with step 3.



### Rolling code programming

To train a garage door opener (or other rolling code devices) with the rolling code feature, follow these instructions after completing the “Programming” portion (steps 1 through 6) of this text. For your convenience and to complete the procedure faster, you might want to have someone assist you.

► **Step 8:** Locate the “training” button on the garage door opener motor head unit.

**i** Exact location and color of the button may vary by garage door opener brand. Depending on manufacturer, the “training” button may also be referred to as “learn” or “smart” button. If there is difficulty locating the transmitting button, refer to the garage door opener Operator’s Manual.

► **Step 9:** Press the “training” button on the garage door opener motor head unit. The “training light” is activated.

You have 30 seconds to initiate the following two steps.

► **Step 10:** Return to the vehicle and firmly press, hold for 2 seconds and release the programmed signal transmitter button (②, ③ or ④).

► **Step 11:** Press, hold for 2 seconds and release same signal transmitter button a second time to complete the training process.

**i** Some garage door openers (or other rolling code equipped devices) may require you to press, hold for 2 seconds and release the same signal transmitter button a third time to complete the training process.

► **Step 12:** Confirm the garage door operation by pressing the programmed signal transmitter button (②, ③ or ④).

► **Step 13:** To program the remaining two signal transmitter buttons, repeat the steps above starting with step 3.

### Gate operator/Canadian programming

Canadian radio-frequency laws require transmitter signals to “time-out” (or quit) after several seconds of transmission which may not be long enough for the integrated signal transmitter to pick up the signal during programming. Similar to this Canadian law, some U.S. gate operators are designed to “time-out” in the same manner.

If you live in Canada or if you are having difficulties programming a gate operator (regardless of where you live) by using the programming procedures, replace step 4 with the following:

► **Step 4:** Press and hold the signal transmitter button (②, ③ or ④). Do not release this button until it has been successfully trained.

► While still holding down the signal transmitter button (②, ③ or ④), “cycle” your hand-held remote control button ⑥ as follows: Press and hold button ⑥ for 2 seconds, then release it for 2 seconds, and again press and hold it for 2 seconds. Repeat this sequence on the hand-held remote control until the frequency signal has been learned.

Upon successful training, indicator lamp ① will flash slowly and then rapidly after several seconds.

► Proceed with programming step 5 and step 6 to complete.

**i** Upon completion of programming the integrated remote control, make sure you retain the hand-held remote control that came with the garage door opener, gate operator or other device. You may need it for use in other vehicles, for future programming of an integrated remote control, or simply for continued use as a hand-held remote control to operate the respective device in other situations.

## Reprogramming a single signal transmitter button

To program a device using a signal transmitter button previously trained, follow these steps:

- ▶ Switch on the ignition.
- ▶ Press and hold the desired signal transmitter button (②, ③ or ④). Do not release the button. Indicator lamp ① will begin to flash after 20 seconds.
- ▶ Without releasing the signal transmitter button, proceed with programming starting with step 3.

## Operation of integrated remote control

- ▶ Switch on the ignition.
- ▶ Select and press the appropriate integrated signal transmitter button (②, ③ or ④) to activate the remote controlled device. The integrated remote control transmitter continues to send the signal as long as the button is pressed – up to 20 seconds.

## Erasing the integrated remote control memory

- ❗ If you sell your vehicle, erase the codes of all three channels.
- ▶ Switch on the ignition.
- ▶ Simultaneously press and hold outer signal transmitter buttons ② and ④, for approximately 20 seconds, until indicator lamp ① flashes rapidly. Do not hold for longer than 30 seconds. The codes of all three channels are erased.

## Programming tips

If you are having difficulty programming the integrated remote control, here are some helpful tips:

- Check the frequency of hand-held remote control ⑤ (typically located on the reverse side of the remote). The integrated remote control is compatible with radio-frequency devices operating between 280-390 MHz.
- Put a new battery in hand-held remote control ⑤. This will increase the likelihood of the hand-held remote control sending a stronger and more accurate signal to the integrated remote control.
- While performing step 3, hold hand-held remote control ⑤ at different lengths and angles from the signal transmitter button (②, ③ or ④) you are programming. Attempt varying angles at the distance of 2 to 12 inches (5 to 30 cm) away or the same angle at varying distances.
- If another hand-held remote control is available for the same device, try the programming steps again using that other hand-held remote control. Make sure new batteries are in the hand-held remote control before beginning the procedure.
- Straighten the antenna wire from the garage door opener assembly. This may help improve transmitting and/or receiving signals.
- ❗ Certain types of garage door openers are incompatible with the integrated remote control. If you should experience further difficulties with programming the integrated remote control, contact an authorized Mercedes-Benz Center, or call the Mercedes-Benz Customer Assistance Center (USA only) at 1-800-FOR-MERCEdes (1-800-367-6372), or the HomeLink® Hotline (USA only) at 1-800-355-3515, or the Customer Service (Canada only) at 1-800-387-0100.

**i** USA only:

This device complies with Part 15 of the FCC Rules. Operation is subject to the following two conditions:

1. This device may not cause harmful interference, and
2. this device must accept any interference received, including interference that may cause undesired operation.

Any unauthorized modification to this device could void the user's authority to operate the equipment.

**i** Canada only:

This device complies with RSS-210 of Industry Canada. Operation is subject to the following two conditions:

1. This device may not cause interference, and
2. this device must accept any interference received, including interference that may cause undesired operation of the device.

Any unauthorized modification to this device could void the user's authority to operate the equipment.

- ▶ Move the driver's seat or front passenger seat as far to the rear as possible.

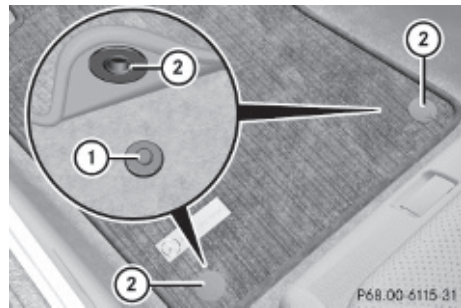

- ▶ **Removing:** Pull floormat off of retainer pins ①.
- ▶ **Installing:** Press floormat eyelets ② onto retainer pins ①.

**Infrared reflecting windshield**

Infrared reflecting glass reduces the amount of radiated heat entering the vehicle interior through the windows.

The infrared reflecting glass also prevents the transmission of signals through the glass by in-vehicle electronic devices, e.g. electronic toll collection devices.

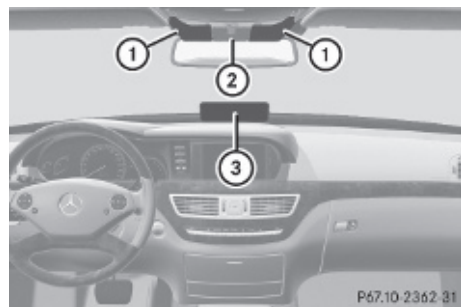

Vehicles without Night View Assist Plus

- ① Infrared transparent area (located left and right to the cover of the rain light sensor)
- ② Cover of the rain light sensor
- ③ Infrared transparent area

**Floormats****⚠ Warning!**

Whenever you are using floormats, make sure there is enough clearance and that the floormats are securely fastened.

Floormats should always be securely fastened using the fastening equipment.

Before driving off, check that the floormats are securely in place and adjust them if necessary. A loose floormat could slip and hinder proper functioning of the pedals.

Do not place several floormats on top of each other as this may impair pedal movement.

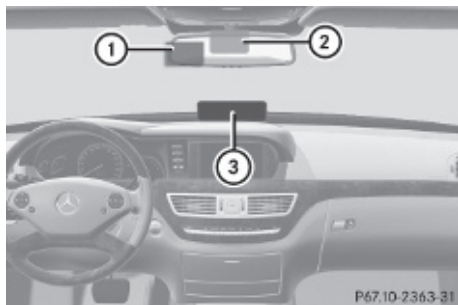

Vehicles with Night View Assist Plus

- ① Infrared transparent area (located left to the cover of the rain light sensor)
- ② Cover of the rain light sensor
- ③ Infrared transparent area

To allow the use of these devices in the vehicle, infrared transparent areas ① and ③ are placed in the windshield.

You can see them from certain angles when ambient light condition permits.

تلفن شبانه روزی: ۰۲۱-۸۸۸۶۲۰۸۵

FarmaSOS.com

Vehicle equipment .....	402
The first 1000 miles (1500 km) .....	402
At the gas station .....	402
Engine compartment .....	404
Tires and wheels .....	410
Winter driving .....	432
Driving instructions .....	434
Maintenance .....	438
Vehicle care .....	440

# امداد خودرو فارما

تلفن شبانه روزی: ۰۲۱-۸۸۸۶۲۰۸۵

[FarmaSOS.com](http://FarmaSOS.com)



## Vehicle equipment

**i** This Operator's Manual describes all features, standard or optional, potentially available for your vehicle at the time of purchase. Please be aware that your vehicle might not be equipped with all features described in this manual.

## The first 1000 miles (1500 km)

The more cautiously you treat your vehicle during the break-in period, the more satisfied you will be with its performance later on.

- Drive your vehicle during the first 1000 miles (1500 km) at varying but moderate vehicle and engine speeds.
- During this period, avoid heavy loads (full throttle driving) and excessive engine speeds (no more than  $\frac{2}{3}$  of maximum rpm in each gear).
- Select **C** as the preferred shift program (▷ page 322) for the first 1000 miles (1500 km).
- Avoid accelerating by kickdown.
- Do not attempt to slow the vehicle down by shifting to a lower gear using the gear selector lever.
- Select gear ranges **3**, **2** or **1** (▷ page 321) only when driving at moderate speeds (for hill driving).

After 1000 miles (1500 km) you may gradually increase vehicle and engine speeds to the permissible maximum.

**i** Additional instructions for AMG vehicles:

- During the first 1000 miles (1500 km), do not exceed a speed of 85 mph (140 km/h).
- During this period, avoid engine speeds above 4500 rpm in each gear.
- Shift gears in a timely manner.

All of the above instructions, as may apply to your vehicle type, also apply when driving the first 1000 miles (1500 km) after the engine or the rear differential has been replaced.

**i** Always obey applicable speed limits.

## At the gas station

### Refueling

#### **Warning!**

Gasoline is highly flammable and poisonous. It burns violently and can cause serious personal injury.

Never allow sparks, flames or smoking materials near gasoline!

Turn off the engine before refueling.

Whenever you are around gasoline, avoid inhaling fumes and any skin or clothing contact. Extinguish all smoking materials.

Direct skin contact with fuels and the inhalation of fuel vapors are damaging your health.

#### **Warning!**

Overfilling of the fuel tank may create pressure in the system which could cause a gas discharge. This could cause the gas to spray back out when removing the fuel pump nozzle, which could cause personal injury.

**i** Never refuel vehicles with gasoline engine with diesel fuel. Even small amounts of diesel fuel will damage the fuel system and engine. Damage resulting from the use of non-approved fuels or fuel additives or resulting from mixing gasoline with diesel fuel is not covered by the Mercedes-Benz Limited Warranty.

**i** If you have accidentally filled the tank with incorrect or non-approved fuel, do not switch on the ignition. Otherwise the incorrect or non-approved fuel will get into the fuel lines. The fuel system must be drained completely. Contact an authorized

Mercedes-Benz Center to have the fuel system drained completely.

**!** To prevent damage to the catalytic converters, only use premium unleaded gasoline in this vehicle.

Any noticeable irregularities in engine operation should be repaired promptly.

Otherwise, excessive unburned fuel may reach the catalytic converter, causing it to overheat and potentially start a fire.

**i** Only use premium unleaded gasoline with a minimum Posted Octane Rating of 91 (average of 96 RON/86 MON). Information on gasoline quality can normally be found on the fuel pump. Please contact gas station personnel in case labels on the pump cannot be found. For more information on gasoline, see “Premium unleaded gasoline” (▷ page 541), see “Fuel requirements” (▷ page 541), or contact an authorized Mercedes-Benz Center, or visit **www.mbusa.com** (USA only).

Locking/unlocking the vehicle with the SmartKey or KEYLESS-GO automatically locks/unlocks the fuel filler flap.

**i** In case the central locking system does not release the fuel filler flap, or the opening mechanism is clamping, contact Roadside Assistance or an authorized Mercedes-Benz Center.

The fuel filler flap is located on the right-hand side of the vehicle towards the rear.

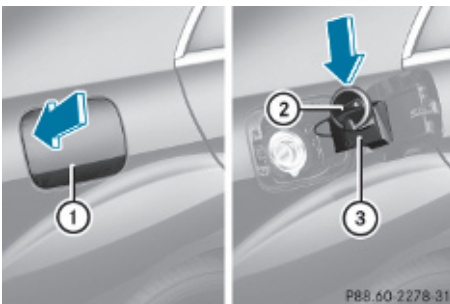

▶ Turn off the engine.

**i** Leaving the engine running and the fuel filler cap open can cause the yellow engine malfunction indicator lamp  to illuminate.

For more information, see also “Practical hints” (▷ page 496).

▶ Remove the SmartKey from the starter switch.

KEYLESS-GO: Open the driver’s door. This puts the starter switch in position **0**, same as with the SmartKey removed from the starter switch. The driver’s door then can be closed again.

▶ **Opening:** Press fuel filler flap (1) at the point indicated by the arrow.

▶ Turn fuel filler cap (2) counterclockwise.

▶ Take off fuel filler cap (2).

▶ Place fuel filler cap (2) in direction of arrow into holder (3).

▶ Fully insert filler nozzle unit and refuel.

▶ Only fill your tank until the filler nozzle unit cuts out – **do not top off or overfill**.

▶ **Closing:** Turn fuel filler cap (2) clockwise until it audibly engages.

**i** Close the fuel filler flap before locking the vehicle. Otherwise the flap locking pin will prevent closing the fuel filler flap.

▶ Close fuel filler flap (1).

### Check regularly and before a long trip

For information on quantities and requirements of operating agents, see “Fuels, coolants, lubricants, etc.” (▷ page 537).

Check the following:

- Engine oil level (▷ page 405)
- Tire inflation pressure (▷ page 413)
- Coolant level (▷ page 408)
- Vehicle lighting (▷ page 504)



- Washer system and headlamp cleaning system (▷ page 409)
- Brake fluid (▷ page 409)

## Engine compartment

### Hood

#### Warning!

Do not pull the release lever while the vehicle is in motion. Otherwise the hood could be forced open by passing air flow.

This could cause the hood to come loose and injure you and/or others.

#### Warning!

HYBRID vehicles: It is imperative that you read the HYBRID Supplemental Operating Instructions included in your vehicle literature portfolio. You may otherwise not receive all necessary safety information and warning for the operation of your vehicle.

### Opening

#### Warning!

If you see flames or smoke coming from the engine compartment, or if the coolant temperature gauge indicates that the engine is overheated, do not open the hood. Move away from vehicle and do not open the hood until the engine has cooled. If necessary, call the fire department.

#### Warning!

You could be injured when the hood is open – even when the engine is turned off.

Parts of the engine can become very hot. To prevent burns, let the engine cool completely before touching any components on the vehicle. Comply with all relevant safety precautions.

#### Warning!

To help prevent personal injury, stay clear of moving parts when the hood is open and the engine is running.

The radiator fan may continue to run for approximately 30 seconds or may even restart after the engine has been turned off. Stay clear of fan blades.

#### Warning!

The engine is equipped with a transistorized ignition system. Because of the high voltage it is dangerous to touch any components (ignition coils, spark plug sockets, diagnostic socket) of the ignition system

- with the engine running
- while starting the engine
- when the ignition is switched on and the engine is turned manually



- ▶ Pull hood lock release lever ①. The hood is unlocked.

- ⚠ Never open the hood if the wiper arms are folded forward away from the windshield. Otherwise the windshield wipers or the hood could be damaged.



**!** To avoid damage to the handle never pull up the hood on the handle.

- ▶ Pull handle ② to its stop out of radiator grille.
- ▶ Pull up on hood.  
The hood will be held open at shoulder height by gas-filled struts automatically.

### Closing

#### **Warning!**

When closing the hood, use extreme caution not to catch hands or fingers. Be careful that you do not close the hood on anyone.

Make sure the hood is securely engaged before driving off. Do not continue driving if the hood can no longer engage after an accident, for example. The hood could otherwise come loose while the vehicle is in motion and injure you and/or others.

- ▶ Let the hood drop from a height of approximately 8 in (20 cm).
- ▶ Check to make sure the hood is fully closed.

If you can raise the hood at a point above the headlamps, then it is not properly closed. Open it again and let it drop with somewhat greater force.

### Engine oil

The amount of oil your engine consumes will depend on a number of factors, including

driving style. Increased oil consumption can occur when the vehicle is new or the vehicle is driven frequently at higher engine speeds. Engine oil consumption checks should only be made after the vehicle break-in period.

**!** Do not use any special lubricant additives, as these may damage the drive assemblies. Using special additives not approved by Mercedes-Benz may cause damage not covered by the Mercedes-Benz Limited Warranty.

For further information contact an authorized Mercedes-Benz Center.

### Notes on checking engine oil level

When checking the oil level

- the vehicle must be parked on level ground
- with the engine at operating temperature, the vehicle must have been stationary for at least 5 minutes with the engine turned off
- with the engine not at operating temperature, the vehicle must have been stationary for at least 30 minutes with the engine turned off

### Checking engine oil level with the oil dipstick

On the S 450 4MATIC, S 550 4MATIC, S 550, and S 63 AMG you can check the engine oil level with the oil dipstick.

- ▶ Open the hood (▷ page 404).

فارس خودرو فارس فارسSOS.com

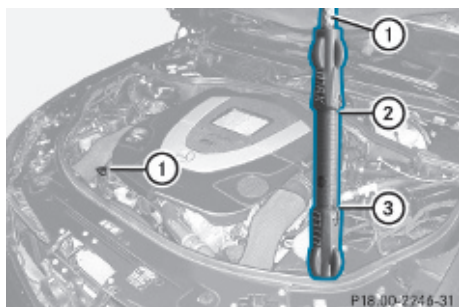

S 550 and S 63 AMG

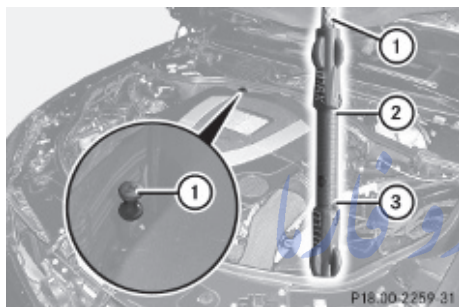

S 450 4MATIC and S 550 4MATIC

- ▶ Pull out oil dipstick ①.
- ▶ Wipe oil dipstick ① clean.
- ▶ Slowly insert oil dipstick ① fully into the dipstick guide tube.
- ▶ Pull out oil dipstick ① again after approximately 3 seconds to obtain accurate reading.

The oil level is correct when it is between lower (min) mark ③ and upper (max) mark ② of oil dipstick ①.

**i** S 450 4MATIC, S 550 and S 550 4MATIC:

The filling quantity between the upper and lower marks on the oil dipstick is approximately 2.1 US qt. (2.0 l).

**i** S 63 AMG only:

The filling quantity between the upper and lower marks on the oil dipstick is approximately 1.6 US qt. (1.5 l).

- ▶ If necessary, add engine oil.

For more information on engine oil, see “Fuels, coolants, lubricants etc.”

(▷ page 537).

For information on messages in the multifunction display concerning engine oil, see the “Practical hints” section

(▷ page 483).

### Checking engine oil level with the control system

On the S 600 and S 65 AMG you can check the engine oil level with the control system.

- i** The menu overview can be found on (▷ page 222).

- ▶ Switch on the ignition.
- ▶ Press ◀ or ▶ on the multifunction steering wheel to select the Service menu.
- ▶ Press ▲ or ▼ on the multifunction steering wheel to select Engine Oil Level.
- ▶ Press **OK**.

The following message appears in the multifunction display:

Measuring  
Engine Oil Level  
Accurate Only  
When Vehicle Is Level

One of the following messages will subsequently appear in the multifunction display:

- Engine Oil Level  
OK
- Add 1.0 qts. Engine Oil  
At Next Refueling  
(Canada: 1.0 l)
- Add 1.5 qts. Engine Oil  
At Next Refueling  
(Canada: 1.5 l)
- Add 2.0 qts. Engine Oil  
At Next Refueling  
(Canada: 2.0 l)

**i** If you want to interrupt the checking procedure, press button  on the multifunction steering wheel.

► If necessary, add engine oil.

For more information on engine oil, see “Fuels, coolants, lubricants etc.”

(▷ page 537).

### Other display messages

If the ignition is not switched on, the following message appears in the multifunction display:

For Engine Oil Level  
Ignition Must be On

► Switch on the ignition.

Need More Time  
to Check  
Engine Oil Level

► If the engine is at operating temperature, wait 5 minutes before repeating check procedure.

► If the engine is not at operating temperature yet, you must wait 30 minutes before checking oil.

If you see the message:  
Engine Oil Level  
Not Measurable  
With Running Engine

► Turn off the engine.

► If the engine is at operating temperature, wait 5 minutes before checking oil.

► If the engine is not at operating temperature yet, you must wait 30 minutes before checking oil.

If there is excess engine oil with the engine at normal operating temperature, the following message appears in the multifunction display:

Reduce  
Engine Oil Level

► Have excess oil siphoned or drained off. Contact an authorized Mercedes-Benz Center.

**!** Excess oil must be siphoned or drained off. It could cause damage to the engine and emission control system not covered by the Mercedes-Benz Limited Warranty.

For information on messages in the multifunction display concerning engine oil, see the “Practical hints” section (▷ page 483).

### Adding engine oil

**!** Only use approved engine oils and oil filters required for vehicles with Maintenance System. For a listing of approved engine oils and oil filters, contact an authorized Mercedes-Benz Center or visit [www.mbusa.com](http://www.mbusa.com) (USA only).

The following will result in engine or emission control system damage not covered by the Mercedes-Benz Limited Warranty:

- Using engine oils and oil filters of specification other than those expressly required for the Maintenance System.
- Changing of oil and oil filter at change intervals longer than those called for by the Maintenance System.
- Using any oil additives.

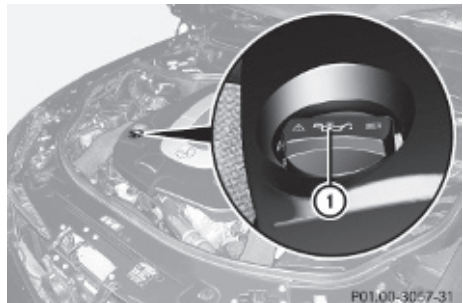

Example illustration: S 550

P01.00-30-7-31

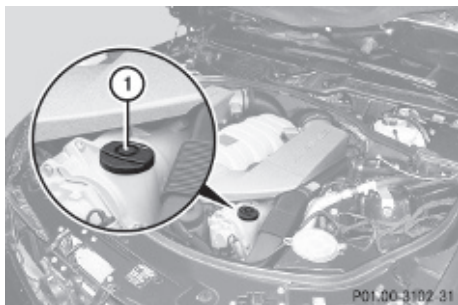

Example illustration: S 63 AMG

- ▶ Unscrew filler cap ① from filler neck.
- ▶ Add engine oil as required. Be careful not to overfill with oil.

Be careful not to spill any oil when adding. Avoid environmental damage caused by oil entering the ground or water.

**!** Excess oil must be siphoned or drained off. It could cause damage to the engine and emission control system not covered by the Mercedes-Benz Limited Warranty.

- ▶ Screw filler cap ① back on filler neck.

For more information on engine oil, see the “Technical data” section (▶ page 537) and (▶ page 539).

### Transmission fluid level

The transmission fluid level does not need to be checked. If you notice transmission fluid loss or gearshifting malfunctions, have an authorized Mercedes-Benz Center check the transmission.

### Active Body Control (ABC) fluid level

Regular fluid level check is not required. If you notice fluid leaks or malfunction messages in the multifunction display, have an authorized Mercedes-Benz Center check the ABC system.

### Coolant level

The engine coolant is a mixture of water and anticorrosion/antifreeze.

When checking the coolant level, the vehicle must be parked on level ground, and the coolant temperature must be below 158°F (70°C).

#### **⚠ Warning!**

In order to avoid any potentially serious burns:

- Use extreme caution when opening the hood if there are any signs of steam or coolant leaking from the cooling system, or if the coolant temperature gauge indicates that the coolant is overheated.
- Do not remove the cap on the coolant expansion tank if the coolant temperature is above 158°F (70°C). Allow the engine to cool down before removing the cap. The coolant expansion tank contains hot fluid and is under pressure.
- Using a rag, slowly open the cap approximately 1/2 turn counterclockwise to relieve excess pressure. If opened immediately, scalding hot fluid and steam will be blown out under pressure.
- Do not spill antifreeze on hot engine parts. Antifreeze contains ethylene glycol which may burn if it comes into contact with hot engine parts.

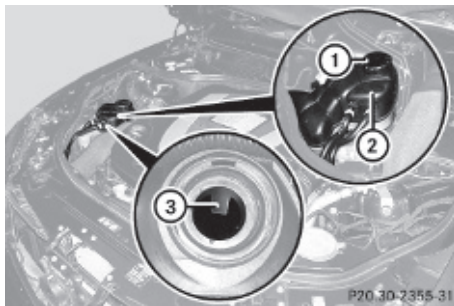

Example illustration: S 550

- ▶ Using a rag, slowly open cap ① approximately  $1/2$  turn counterclockwise to relieve excess pressure.
- ▶ Continue turning cap ① counterclockwise and remove it.

The coolant level is correct if the level

- for cold coolant: reaches marking bar ③ in coolant expansion tank ②
- for warm coolant: is approximately 0.6 in (1.5 cm) higher

- ▶ Add coolant as required.
- ▶ Screw cap ① back on and tighten it.

For more information on coolant, see the “Technical data” section (▷ page 538) and (▷ page 542).

### Washer system and headlamp cleaning system

#### ⚠ Warning!

Washer solvent/antifreeze is highly flammable. Do not spill washer solvent/antifreeze on hot engine parts, because it may ignite and burn. You could be seriously burned.

- ❗ Always use washer solvent/antifreeze where temperatures may fall below freezing point. Failure to do so could result in damage to the washer system/fluid reservoir.

- ❗ Only use washer fluid which is suitable for plastic lenses. Improper washer fluid can damage the plastic lenses of the headlamps.

- ❗ Do not use distilled or deionized water in the washer fluid reservoir. Otherwise, the washer fluid level sensor could be damaged.

Fluid for the washer system and the headlamp cleaning system is supplied from the washer fluid reservoir.

During all seasons, use MB Windshield Washer Concentrate “MB SummerFit”. Mix it with water or premixed washer solvent/antifreeze depending on the ambient temperature (▷ page 544).



Example illustration: S 550 with AIRMATIC

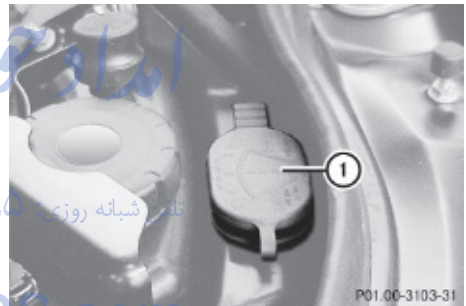

Vehicles with Active Body Control (ABC)

- ▶ **Opening washer fluid reservoir:** Pull tab of cap ① upwards.
- ▶ Refill the washer fluid reservoir.
- ▶ **Closing washer fluid reservoir:** Press cap ① onto filler hole until it engages.

For more information, see “Washer system and headlamp cleaning system” (▷ page 539).

### Brake fluid level

- ❗ If you find that the brake fluid in the brake fluid reservoir has fallen to the minimum mark or below, have the brake system checked for brake pad thickness and leaks immediately. Contact an authorized



Mercedes-Benz Center immediately. Do not add brake fluid as this will not solve the problem. For more information, see “Practical hints”.

When checking the brake fluid level, the vehicle must be parked on level ground.

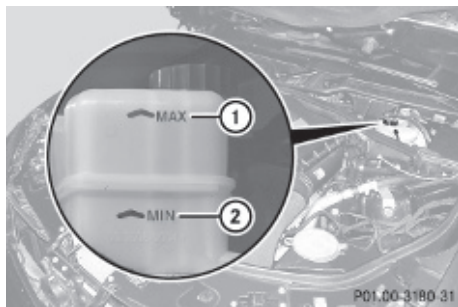

The brake fluid level is correct when it is between lower mark (MIN) ② and upper mark (MAX) ① of the brake fluid reservoir.

## Tires and wheels

### Safety notes

Contact an authorized Mercedes-Benz Center for information on tested and recommended rims and tires for summer and winter operation. They can also offer advice concerning tire service and purchase.

#### **Warning!**

Replace rims or tires with the same designation, manufacturer and type as shown on the original part. For further information contact an authorized Mercedes-Benz Center. If incorrectly sized rims and tires are mounted, the wheel brakes or suspension components can be damaged. Also, the operating clearance of the wheels and the tires may no longer be correct.

#### **Warning!**

Worn, old tires can cause accidents. If the tire tread is worn to minimum tread depth, or if

the tires have sustained damage, replace them.

When replacing rims, only use genuine Mercedes-Benz wheel bolts specified for the particular rim type. Failure to do so can result in the bolts loosening and possibly an accident.

Retreaded tires are not tested or recommended by Mercedes-Benz, since previous damage cannot always be recognized on retreads. The operating safety of the vehicle cannot be assured when such tires are used.

#### **Warning!**

If you feel a sudden significant vibration or ride disturbance, or you suspect that possible damage to your vehicle has occurred, you should turn on the hazard warning flashers, carefully slow down, and drive with caution to an area which is a safe distance from the road. Inspect the tires and the vehicle underbody for possible damage. If the vehicle or tires appear unsafe, have the vehicle towed to the nearest authorized Mercedes-Benz Center or tire dealer for repairs.

#### **Warning!**

Do not drive with a flat tire. A flat tire affects the ability to steer or brake the vehicle. You could lose control of the vehicle. Continued driving with a flat tire or driving at high speed with a flat tire will cause excessive heat build-up and possibly a fire.

### Important guidelines

- Only use sets of tires and rims of the same type and make.
- Tires must be of the correct size for the rim.
- Break in new tires for approximately 60 miles (100 km) at moderate speeds.
- Regularly check the tires and rims for damage. Dented or bent rims can cause tire



inflation pressure loss and damage to the tire beads.

- If the vehicle is heavily loaded, check tire inflation pressure and correct as required.
- Do not allow your tires to wear down too far. Adhesion properties on wet roads are sharply reduced at tread depths of less than  $\frac{1}{8}$  in (3 mm).
- When replacing individual tires, you should mount new tires on the front wheels first (on vehicles with same-sized wheels all around).

### Recommended tire inflation pressure

#### **Warning!**

Follow recommended tire inflation pressures.

Do not underinflate tires. Underinflated tires wear excessively and/or unevenly, adversely affect handling and fuel economy, and are more likely to fail from being overheated.

Do not overinflate tires. Overinflated tires can adversely affect handling and ride comfort, wear unevenly, increase stopping distance, and result in sudden deflation (blowout) because they are more likely to become punctured or damaged by road debris, potholes etc.

Do not overload the tires by exceeding the specified load limit as indicated on the Tire and Loading Information placard on the driver's door B-pillar. Overloading the tires can overheat them, possibly causing a blowout. Overloading the tires can also result in handling or steering problems, or brake failure.

Your vehicle is equipped with the Tire and Loading Information placard located on the driver's door B-pillar (▷ page 418).

The tire inflation pressure should be checked regularly. Only adjust the tire inflation pressure on cold tires. The tires can be considered cold if the vehicle has been parked for at least 3 hours or driven less than

1 mile (1.6 km). Depending on the ambient temperature, the driving speed and the tire load, the tire temperature changes. When the tire temperature changes by 18°F (10°C), the tire inflation pressure will change by approximately 1.5 psi (0.1 bar). Keep this in mind when checking tire inflation pressure on warm tires and adjust the tire pressure only if the tire inflation pressure is too low for the current operating conditions. If you check the tire inflation pressure when the tires are warm, the reading will be higher than the cold reading. This is normal. Do not let air out to match the specified cold tire inflation pressure. Otherwise, the tire will be underinflated.

Follow recommended cold tire inflation pressures listed on Tire and Loading Information placard on the driver's door B-pillar.

Keeping the tires properly inflated provides the best handling, tread life and riding comfort.

In addition to the Tire and Loading Information placard on the driver's door B-pillar, also consult the tire inflation pressure label on the inside of the filler flap for any additional information pertaining to special driving situations. For more information, see "Important notes on tire inflation pressure" (▷ page 412).

**i** Data shown on Tire and Loading Information placard example are for illustration purposes only. Tire data are specific to each vehicle and may vary from data shown in the following illustration. Refer to Tire and Loading Information placard on vehicle for actual data specific to your vehicle.

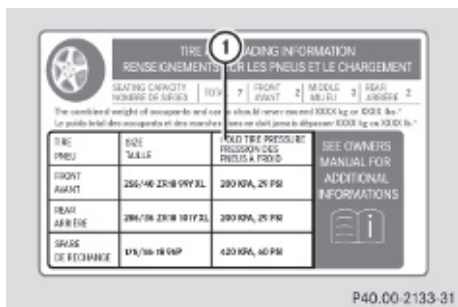

The Tire and Loading Information placard lists the recommended cold tire inflation pressures ① for maximum loaded vehicle weight. The tire inflation pressures listed apply to the tires installed as original equipment.

### Important notes on tire inflation pressure

#### ⚠ Warning!

If the tire inflation pressure drops repeatedly, check the tires for punctures from foreign objects and/or whether air is leaking from the valves or from around the rim.

Tire temperature and tire inflation pressure are also increased while driving, depending on the driving speed and the tire load.

If you will be driving your vehicle at high speeds of 100 mph (160 km/h) or higher, where it is legal and conditions allow, consult the tire inflation pressure label on the inside of the fuel filler flap on how to adjust the cold tire inflation pressure. If you do not adjust the tire inflation pressure, excessive heat can build up and result in sudden tire failure.

If you are not sure about the proper tire inflation pressure, contact an authorized Mercedes-Benz Center.

① Driving comfort may be reduced when the tire inflation pressure is adjusted to the value for speeds above 100 mph (160 km/h) as specified on the tire inflation pressure label located on the inside of the fuel filler flap.

Make sure to readjust the tire inflation pressure for normal driving speeds.

Supplemental tire inflation pressure information for different loading conditions of the vehicle can be found on the tire inflation pressure label. The tire inflation pressure label is located on the inside of the fuel filler flap.

For the tire inflation pressure for spare wheels such as Minispare wheels or spare wheels with collapsible tire refer to

- the yellow label on the spare wheel rim
- the “Technical data” section of this Operator’s Manual (▷ page 536)
- the Tire and Loading Information placard on the driver’s door B-pillar

Unless specified otherwise, the tire inflation pressures on the tire inflation pressure label are valid for all approved, factory-equipped tires.

① Data shown on tire inflation pressure label examples are for illustration purposes only. Tire inflation pressure data are specific to each vehicle and may vary from data shown in the following illustrations. Refer to the tire inflation pressure label on vehicle for actual data specific to your vehicle.

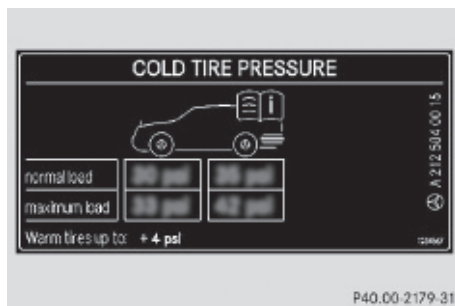

Example illustration: Tire inflation pressures for all approved, factory equipped tires

When a tire size is specified, the tire inflation pressure that follows applies to that particular tire size only.

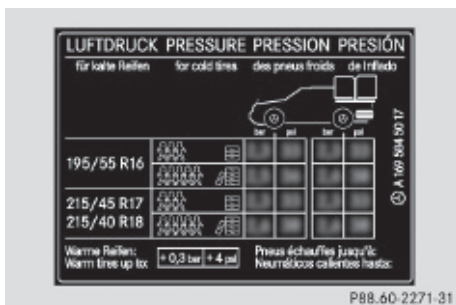

Example illustration: Tire inflation pressures for particular tire sizes

Some tire inflation pressure labels may only show the rim diameter instead of the entire tire size, e.g. **R 18** or **18"**.

The rim diameter is part of the tire size as specified on the tire sidewall (▷ page 426).

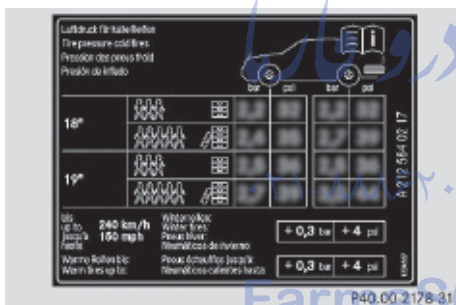

Example illustration: Tire inflation pressures specific to rim diameter

## Potential problems associated with underinflated and overinflated tires

### Underinflated tires

#### ⚠ Warning!

Follow recommended tire inflation pressures. Do not underinflate tires. Underinflated tires wear excessively and/or unevenly, adversely affect handling and fuel economy, and are more likely to fail from being overheated.

Underinflated tires can

- cause excessive and uneven tire wear
- adversely affect fuel economy

- lead to tire failure from being overheated
- adversely affect handling characteristics

### Overinflated tires

#### ⚠ Warning!

Follow recommended tire inflation pressures. Do not overinflate tires. Overinflated tires can adversely affect handling and ride comfort, wear unevenly, increase stopping distance, and result in sudden deflation (blowout) because they are more likely to become punctured or damaged by road debris, potholes etc.

Overinflated tires can

- adversely affect handling characteristics
- cause uneven tire wear
- be more prone to damage from road hazards
- adversely affect ride comfort
- increase stopping distance

### Checking tire inflation pressure

### Safety notes

#### ⚠ Warning!

Follow recommended tire inflation pressures. Do not underinflate tires. Underinflated tires wear excessively and/or unevenly, adversely affect handling and fuel economy, and are more likely to fail from being overheated.

Do not overinflate tires. Overinflated tires can adversely affect handling and ride comfort, wear unevenly, increase stopping distance, and result in sudden deflation (blowout) because they are more likely to become punctured or damaged by road debris, potholes etc.

Do not overload the tires by exceeding the specified load limit as indicated on the Tire and Loading Information placard on the driver's door B-pillar. Overloading the tires

can overheat them, possibly causing a blowout. Overloading the tires can also result in handling or steering problems, or brake failure.

Check the tire inflation pressure at least once a month.

Check and adjust the tire inflation pressure when the tires are cold (▷ page 411).

### Checking tire inflation pressure manually

Follow the steps below to achieve correct tire inflation pressure:

- ▶ Remove the cap from the valve on one tire.
- ▶ Firmly press a tire gauge onto the valve.
- ▶ Read the tire inflation pressure on the tire gauge and check against the recommended tire inflation pressure on the Tire and Loading Information placard on the driver's door B-pillar (▷ page 418). If necessary, add air to achieve the recommended tire inflation pressure.
- ▶ If you have overfilled the tire, release tire inflation pressure by pushing the metal stem of the valve with e.g. a tip of a pen. Then recheck the tire inflation pressure with the tire gauge.
- ▶ Install the valve cap.
- ▶ Repeat this procedure for each tire.

### Advanced Tire Pressure Monitoring System (Advanced TPMS)

Your vehicle is equipped with the Advanced Tire Pressure Monitoring System (Advanced TPMS). It measures the tire inflation pressure in the vehicle's tires and issues warnings in case of pressure loss in one or more of the tires.

The TPMS is equipped with a combination low tire pressure/ TPMS malfunction telltale (USA) or a low tire pressure telltale (Canada) in the instrument cluster. Depending on how the telltale illuminates, it indicates a low tire pressure condition or a malfunction in the TPMS system itself:

- If the telltale illuminates continuously, one or more of your tires is significantly underinflated. There is no malfunction in the TPMS.
- USA only: If the telltale flashes for 60 seconds and then stays illuminated, the TPMS system itself is not operating properly.

The TPMS only functions on wheels that are equipped with the proper electronic sensors.

#### Warning!

The TPMS does not indicate a warning for wrongly selected inflation pressures. Always adjust tire inflation pressure according to the Tire and Loading Information placard or the supplemental tire inflation pressure information on the inside of the fuel filler flap. The TPMS is not able to issue a warning due to a sudden dramatic loss of pressure (e.g. tire blowout caused by a foreign object). In this case bring the vehicle to a halt by carefully applying the brakes and avoiding abrupt steering maneuvers.

#### Warning!

Each tire, including the spare (if provided), should be checked at least once a month when cold and inflated to the inflation pressure recommended by the vehicle manufacturer on the Tire and Loading Information placard on the driver's door B-pillar or the tire inflation pressure label on the inside of the fuel filler flap. If your vehicle has tires of a different size than the size indicated on the Tire and Loading Information placard or the tire inflation pressure label, you should determine the proper tire inflation pressure for those tires.

As an added safety feature, your vehicle has been equipped with a tire pressure monitoring system (TPMS) that illuminates a low tire pressure telltale when one or more of your tires are significantly underinflated.

Accordingly, when the low tire pressure telltale illuminates, you should stop and check your tires as soon as possible, and inflate them to the proper pressure. Driving on a significantly underinflated tire causes the tire to overheat and can lead to tire failure.

Underinflation also reduces fuel efficiency and tire tread life, and may affect the vehicle's handling and stopping ability. Please note that the TPMS is not a substitute for proper tire maintenance, and it is the driver's responsibility to maintain correct tire pressure, even if underinflation has not reached the level to trigger illumination of the TPMS low tire pressure telltale.

USA only:

Your vehicle has also been equipped with a TPMS malfunction indicator to indicate when the system is not operating properly. The TPMS malfunction indicator is combined with the low tire pressure telltale. When the system detects a malfunction, the telltale will flash for approximately 1 minute and then remain continuously illuminated. This sequence will continue upon subsequent vehicle start-ups as long as the malfunction exists. When the malfunction indicator is illuminated, the system may not be able to detect or signal low tire pressure as intended.





TPMS malfunctions may occur for a variety of reasons, including the installation of incompatible replacement or alternate tires or wheels on the vehicle that prevent the TPMS from functioning properly. Always check the TPMS malfunction telltale after replacing one or more tires or wheels on your vehicle to ensure that the replacement or alternate tires and wheels allow the TPMS to continue to function properly.

If a condition causing the TPMS to malfunction develops, it may take up to 10 minutes for the system to signal a malfunction using the TPMS telltale flashing and illumination sequence.

The telltale extinguishes after a few minutes driving if the malfunction has been corrected.

Tire pressure inquiries are made using the multifunction display. The current tire inflation pressure for each tire appears in the multifunction display after a few minutes of driving.

**i** Possible differences between the readings of a tire pressure gauge of an air hose, e.g. gas station equipment, and the vehicle's control system can occur. The tire pressure displayed by the control system apply to sea level. In high-altitude locations, the reading on a tire pressure gauge will be higher than the reading issued by the vehicle's control system. Do not reduce the tire inflation pressure under such circumstances.

- ▶ Switch on the ignition.
- ▶ Press button  or  on the multifunction steering wheel to select the Service menu (> page 233).
- ▶ Press button  or  to select Tire Press..
- ▶ Press button .

The current inflation pressure for each tire appears in the multifunction display.

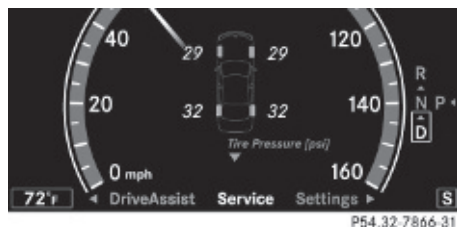

Example illustration

When the vehicle has been parked for longer than 20 minutes, the message Tire

**i** USA only:

Pressure Displayed After Driving A Few Minutes appears in the multifunction display.

**i** With a spare wheel mounted, the system may still indicate the tire inflation pressure of the removed road wheel for some minutes. If this happens, keep in mind that the indicated value where the spare wheel is mounted does not reflect the actual spare tire inflation pressure.

**i** Operating radio transmission equipment (e.g. wireless headsets, two-way radios) in or near the vehicle could cause the TPMS to malfunction.

**i** USA only:  
This device complies with Part 15 of the FCC Rules. Operation is subject to the following two conditions:

1. This device may not cause harmful interference, and
2. this device must accept any interference received, including interference that may cause undesired.

Any unauthorized modification to this device could void the user's authority to operate the equipment.

**i** Canada only:  
This device complies with RSS-210 of Industry Canada. Operation is subject to the following two conditions:

1. This device may not cause interference, and
2. this device must accept any interference received, including interference that may cause undesired operation of the device.

Any unauthorized modification to this device could void the user's authority to operate the equipment.

## Tire inflation pressure warnings

If the system detects a significant loss of tire inflation pressure in one or more than one tire, a message appears in the multifunction display. In addition, an acoustic warning sounds and the low tire pressure telltale in the instrument cluster comes on.



Example illustration

The respective tire and the corresponding tire inflation pressure are indicated in yellow.

## Restarting Advanced TPMS

### **Warning!**

It is the driver's responsibility to set the tire inflation pressure to the recommended cold tire inflation pressure. Underinflated tires affect the ability to steer or brake the vehicle. You might lose control over the vehicle.

When you restart the TPMS, the system sets new reference values for each tire.

The TPMS must be restarted when you have adjusted the tire inflation pressure to a new level (e.g. because of different load or driving conditions). The TPMS is then recalibrated to the current tire inflation pressures.

**i** Canada only:

The TPMS usually recognizes tire pressure adjustments and sets new reference values automatically. You can, however, restart the TPMS manually as described.



Restart the TPMS after adjusting the tire inflation pressure to the inflation pressure recommended for the vehicle operating condition. Tire inflation pressure should only be adjusted on cold tires. Observe the recommended tire inflation pressure on the Tire and Loading Information placard on the





driver's door B-pillar. Some vehicles may have supplemental tire inflation pressure information for driving at high speeds or for vehicle loads less than the maximum loaded vehicle condition. If such information is provided, it can be found on the inside of the fuel filler flap.

▶ Using the Tire and Loading Information placard on the driver's door B-pillar (▷ page 418) or the supplemental tire inflation pressure information on the inside of the fuel filler flap, make sure the tire inflation pressure of all four tires is correct.

▶ Switch on the ignition.

▶ Press button  or  on the multifunction steering wheel to select the Service menu.

▶ Press button  or  on the multifunction steering wheel to select Tire Press..

▶ Press button .

The current inflation pressure for each tire appears in the multifunction display or the following message appears in the multifunction display:

Tire Pressure  
Displayed After Driving  
A Few Minutes

▶ Press button .

The following message appears in the multifunction display:

Use Current  
Pressures As New  
Reference Values  
Press 'OK' to Confirm

▶ Press button .

The following message appears in the multifunction display:

Tire Pressure Monitor  
Reactivated

After driving a few minutes the system verifies that the current tire inflation pressures are within the system's specified range. Afterwards the current tire inflation pressures are accepted as reference values and then monitored.

▶ **If you wish to cancel:** Press button .

or

▶ Press button  to exit the menu screen.

**i** When the wheel positions have been changed, the inflation pressure of a tire may be displayed for the wrong position temporarily. After driving for a few minutes, the inflation pressure will be shown for the correct position.

### Maximum tire inflation pressure

#### **Warning!**

Never exceed the maximum tire inflation pressure. Follow recommended tire inflation pressures.

Do not underinflate tires. Underinflated tires wear excessively and/or unevenly, adversely affect handling and fuel economy, and are more likely to fail from being overheated.

Do not overinflate tires. Overinflated tires can adversely affect handling and ride comfort, wear unevenly, increase stopping distance, and result in sudden deflation (blowout) because they are more likely to become punctured or damaged by road debris, potholes etc.



**i** For illustration purposes only. Actual data on tires are specific to each vehicle and may vary from data shown in above illustration.



This is the maximum permissible tire inflation pressure ① for the tire.

Always follow the recommended tire inflation pressure (▷ page 411) for proper tire inflation.

### Loading the vehicle

Two labels on your vehicle show how much weight it may properly carry.

(1) The Tire and Loading Information placard can be found on the driver's door B-pillar. This placard tells you important information about the number of people that can be in the vehicle and the total weight that can be carried in the vehicle. It also contains information on the proper size and recommended tire inflation pressures for the original equipment tires on your vehicle.

(2) The certification label, also found on the driver's door B-pillar. It tells you about the gross weight capacity of your vehicle, called the Gross Vehicle Weight Rating (GVWR). The GVWR includes the weight of the vehicle, all occupants, fuel and cargo. The certification label also tells you about the front and rear axle weight capacity, called the Gross Axle Weight Rating (GAWR).

The GAWR is the total allowable weight that can be carried by a single axle (front or rear). Never exceed the GVWR or GAWR for either the front axle or rear axle.



① Driver's door B-pillar

Following is a discussion on how to work with the information contained on the Tire and Loading Information placard with regards to loading your vehicle.

### Tire and Loading Information

#### ⚠ Warning!

Do not overload the tires by exceeding the specified load limit as indicated on the Tire and Loading Information placard on the driver's door B-pillar. Overloading the tires can overheat them, possibly causing a blowout. Overloading the tires can also result in handling or steering problems, or brake failure.

### Tire and Loading Information placard

① Data shown on Tire and Loading Information placard example are for illustration purposes only. Load limit data are specific to each vehicle and may vary from data shown in the following illustration. Refer to Tire and Loading Information placard on vehicle for actual data specific to your vehicle.

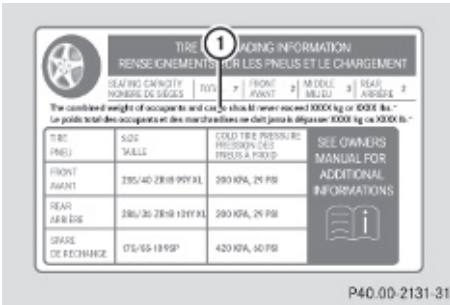

The Tire and Loading Information placard showing load limit information ① is located on the driver’s door B-pillar (▷ page 418).

- ▶ Locate the statement “The combined weight of occupants and cargo should never exceed XXX kilograms or XXX lbs.” on the Tire and Loading Information placard.

The combined weight of all occupants, cargo/luggage and trailer tongue load (if applicable) should never exceed the weight referenced in that statement.

### Seating capacity

**i** Data shown on Tire and Loading Information placard example are for illustration purposes only. Seating capacity data are specific to each vehicle and may vary from data shown in the following illustration. Refer to Tire and Loading Information placard on vehicle for actual data specific to your vehicle.

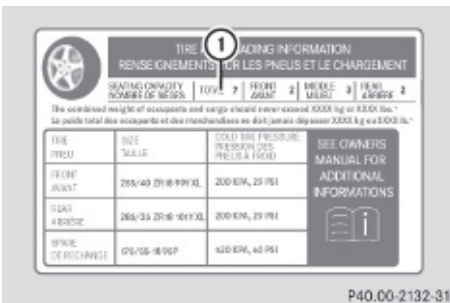

The seating capacity gives you important information on the number of occupants that

can be in the vehicle. Observe front and rear seating capacity. The Tire and Loading Information placard showing seating capacity ① is located on the driver’s door B-pillar (▷ page 418).

### Steps for determining correct load limit

The following steps have been developed as required of all manufacturers under Title 49, Code of U.S. Federal Regulations, Part 575 pursuant to the “National Traffic and Motor Vehicle Safety Act of 1966”.

- ▶ **Step 1:** Locate the statement “The combined weight of occupants and cargo should never exceed XXX kg or XXX lbs.” on your vehicle’s Tire and Loading Information placard.
- ▶ **Step 2:** Determine the combined weight of the driver and passengers that will be riding in your vehicle.
- ▶ **Step 3:** Subtract the combined weight of the driver and passengers from XXX kilograms or XXX lbs.
- ▶ **Step 4:** The resulting figure equals the available amount of cargo and luggage load capacity. For example, if the “XXX” amount equals 1 400 lbs and there will be five 150 lbs passengers in your vehicle, the amount of available cargo and luggage load capacity is 650 lbs (1 400 - 750 (5 x 150) = 650 lbs).
- ▶ **Step 5:** Determine the combined weight of luggage and cargo being loaded on the vehicle. That weight may not safely exceed the available cargo and luggage load capacity calculated in step 4.
- ▶ **Step 6 (if applicable):** If your vehicle will be towing a trailer, load from your trailer will be transferred to your vehicle. Consult this manual to determine how this reduces the available cargo and luggage load capacity of your vehicle (▷ page 422).

The following table shows examples on how to calculate total and cargo load capacities with varying seating configurations and

number and size of occupants. The following examples use a load limit of 1500 lbs. **This is for illustration purposes only.** Make sure you are using the actual load limit for your vehicle stated on the vehicle's Tire and Loading Information placard (> page 419).

امداد خودرو فارما

تلفن شبانه روزی: ۰۲۱-۸۸۸۶۲۰۸۵

FarmaSOS.com

		Example 1	Example 2	Example 3
Step 1	<b>Combined weight limit of occupants and cargo from Tire and Loading Information placard</b>	1 500 lbs	1 500 lbs	1 500 lbs

		Example 1	Example 2	Example 3
Step 2	<b>Number of occupants (driver and passengers)</b>	5	3	1
	<b>Seating configuration</b>	front: 2 rear: 3	front: 1 rear: 2	front: 1
	<b>Occupants weight</b>	Occupant 1: 150 lbs Occupant 2: 180 lbs Occupant 3: 160 lbs Occupant 4: 140 lbs Occupant 5: 120 lbs	Occupant 1: 200 lbs Occupant 2: 190 lbs Occupant 3: 150 lbs	Occupant 1: 150 lbs
	<b>Combined weight of all occupants</b>	750 lbs	540 lbs	150 lbs

		Example 1	Example 2	Example 3
Step 3	<b>Available cargo/ luggage and trailer tongue weight (total load limit from Tire and Loading Information placard minus combined weight of all occupants)</b>	1 500 lbs - 750 lbs = 750 lbs	1 500 lbs - 540 lbs = 960 lbs	1 500 lbs - 150 lbs = 1 350 lbs

The higher the weight of all occupants, the less cargo and luggage load capacity is available.

For more information, see “Trailer tongue load” (▷ page 422).

### Certification label

Even after careful determination of the combined weight of all occupants, cargo and the trailer tongue load (if applicable) (▷ page 422) as to not exceed the permissible load limit, you must make sure your vehicle never exceeds the Gross Vehicle

Weight Rating (GVWR) and the Gross Axle Weight Rating (GAWR) for either the front or rear axle. You can obtain the GVWR and GAWR from the certification label. The certification label can be found on the driver's door B-pillar, see the "Technical data" section (▷ page 524).

**Gross Vehicle Weight Rating (GVWR):** The total weight of the vehicle, all occupants, all cargo, and the trailer tongue load (if applicable) must never exceed the GVWR.

**Gross Axle Weight Rating (GAWR):** The total allowable weight that can be carried by a single axle (front or rear).

To assure that your vehicle does not exceed the maximum permissible weight limits (GVWR and GAWR for front and rear axle), have the loaded vehicle (including driver, passengers and all cargo and, if applicable, trailer fully loaded) weighed on a suitable commercial scale.

### Trailer tongue load

The tongue load of any trailer is an important weight to measure because it affects the load you can carry in your vehicle. If a trailer is towed, the tongue load must be added to the weight of all occupants riding and any cargo you are carrying in the vehicle. The tongue load typically is 10% of the trailer weight and everything loaded in it.

Your Mercedes-Benz has been designed primarily to carry passengers and their cargo. Mercedes-Benz does not recommend trailer towing with your vehicle.

### Maximum tire load

#### Warning!

Do not overload the tires by exceeding the specified load limit as indicated on the Tire and Loading Information placard on the driver's door B-pillar. Overloading the tires can overheat them, possibly causing a blowout. Overloading the tires can also result

in handling or steering problems, or brake failure.



**i** For illustration purposes only. Actual data on tires are specific to each vehicle and may vary from data shown in above illustration.

The maximum tire load rating ① is the maximum weight the tires are designed to support.

For more information on tire load rating, see (▷ page 427).

For information on calculating total and cargo load capacities, see (▷ page 419).

### Direction of rotation

Unidirectional tires offer added advantages, such as better hydroplaning performance. To benefit, however, you must make sure the tires rotate in the direction specified.

An arrow on the sidewall indicates the intended direction of rotation of the tire.

Spare wheels may be mounted against the direction of rotation (spinning) even with a unidirectional tire for temporary use only until the regular drive wheel has been repaired or replaced. Always observe and follow applicable temporary use restrictions and speed limitations indicated on the spare wheel.

## Tire care and maintenance

### Warning!

Regularly check the tires for damage. Damaged tires can cause tire inflation pressure loss. As a result, you could lose control of your vehicle.

Worn, old tires can cause accidents. If the tire tread is worn to minimum tread depth, or if the tires have sustained damage, replace them.

Check the tire inflation pressure at least once a month. For more information on checking tire inflation pressure, see “Recommended tire inflation pressure” (▷ page 411).

## Tire inspection

Every time you check the tire inflation pressure, you should also inspect your tires for the following:

- excessive treadwear (▷ page 423)
- cord or fabric showing through the tire's rubber
- bumps, bulges, cuts, cracks or splits in the tread or side of the tire

Replace the tire if you find any of the above conditions.

Make sure you also inspect the spare tire periodically for condition and inflation. Spare tires will age and become worn over time even if never used, and thus should be inspected and replaced when necessary.

## Life of tire

### Warning!

Tires and spare tire should be replaced after 6 years, regardless of the remaining tread.

The service life of a tire is dependent upon varying factors including but not limited to:

- Driving style
- Tire inflation pressure
- Distance driven

## Tread depth

### Warning!

Although the applicable federal motor vehicle safety laws consider a tire to be worn when the treadwear indicators (TWI) become visible at approximately  $1/16$  in (1.6 mm), we recommend that you do not allow your tires to wear down to that level. As tread depth approaches  $1/8$  in (3 mm), the adhesion properties on a wet road are sharply reduced. Depending upon the weather and/or road surface (conditions), the tire traction varies widely.

Do not allow your tires to wear down too far. Adhesion properties on wet roads are sharply reduced at tread depths of less than  $1/8$  in (3 mm).

Treadwear indicators (TWI) are required by law. These indicators are located in six places on the tread circumference and become visible at a tread depth of approximately  $1/16$  in (1.6 mm), at which point the tire is considered worn and should be replaced.

The recommended minimum tire tread depth for summer tires is  $1/8$  in (3 mm). The recommended minimum tire tread depth for winter tires is  $1/6$  in (4 mm).

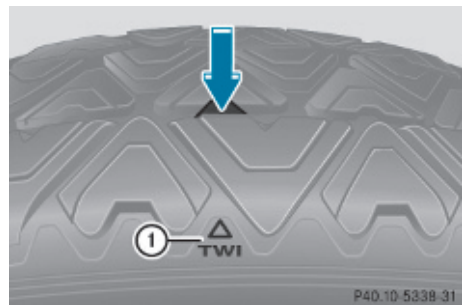

Treadwear indicator ① appears as a solid band across the tread.

## Storing tires

- ❗ Keep unmounted tires in a cool, dry place with as little exposure to light as possible. Protect tires from contact with oil, grease and fuels.

## Cleaning tires

- ❗ Never use a round nozzle to power wash tires. The intense jet of water can result in damage to the tire. Always replace a damaged tire.

### Uniform Tire Quality Grading Standards

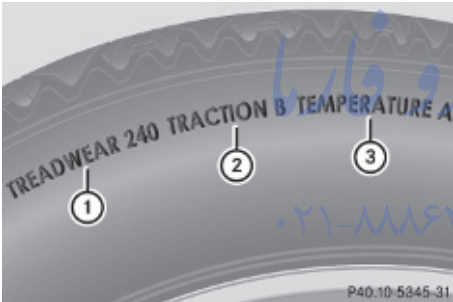

The Uniform Tire Quality Grading is a U.S. Government requirement designed to give drivers consistent and reliable information regarding tire performance. Tire manufacturers are required to grade tires based on three performance factors: treadwear ①, traction ②, and temperature resistance ③. Although not a Government of Canada requirement, all tires made for sale in North America have these grades branded on the sidewall.

- i For illustration purposes only. Actual data on tires are specific to each vehicle and may vary from data shown in above illustration.

Quality grades can be found, where applicable, on the tire sidewall between tread shoulder and maximum section width. For example:

Treadwear	Traction	Temperature
200	AA	A

All passenger car tires must conform to federal safety requirements in addition to these grades.

## Treadwear

The treadwear grade is a comparative rating based on the wear rate of the tire when tested under controlled conditions on a specified U.S. Government test course. For example, a tire graded 150 would wear one and one-half ( $1 \frac{1}{2}$ ) times as well on the government course as a tire graded 100.

The relative performance of tires depends upon the actual conditions of their use, however, and may depart significantly from the norm due to variations in driving habits, service practices and differences in road characteristics and climate.

## Traction

### ⚠ Warning!

The traction grade assigned to this tire is based on straight-ahead braking traction tests, and does not include acceleration, cornering, hydroplaning, or peak traction characteristics.

The traction grades, from highest to lowest, are AA, A, B, and C. Those grades represent the tire's ability to stop on wet pavement as measured under controlled conditions on specified government test surfaces of asphalt and concrete. A tire marked C may have poor traction performance.

### ⚠ Warning!

If ice has formed on the road, tire traction will be substantially reduced. Under such weather conditions, drive, steer and brake with extreme caution.



The safe speed on a wet, snow covered or icy road is always lower than on a dry road.

You should pay particular attention to the condition of the road whenever the outside temperature is close to the freezing point.

Mercedes-Benz recommends winter tires (▷ page 432) with a minimum tread depth of approximately  $\frac{1}{6}$  in (4 mm) on all four wheels for the winter season to ensure normal balanced handling characteristics. On packed snow, they can reduce your stopping distance compared to summer tires.

Stopping distance, however, is still considerably greater than when the road is not covered with snow or ice. Exercise appropriate caution.

**!** Avoid spinning of a drive wheel. This may cause serious damage to the drivetrain which is not covered by the Mercedes-Benz Limited Warranty.

## Temperature

### Warning!

The temperature grade for this tire is established for a tire that is properly inflated and not overloaded. Excessive speed, underinflation, or excessive loading, either separately or in combination, can cause excessive heat build-up and possible tire failure.

The temperature grades are A (the highest), B, and C, representing the tire's resistance to the generation of heat and its ability to dissipate heat when tested under controlled conditions on a specified indoor laboratory test wheel. Sustained high temperature can cause the material of the tire to degenerate and reduce tire life, and excessive temperature can lead to sudden tire failure. The grade C corresponds to a level of performance which all passenger car tires must meet under the Federal Motor Vehicle Safety Standard No. 109. Grades B and A represent higher levels of performance on the

laboratory test wheel than the minimum required by law.

## Rotating tires

### Warning!

Rotate front and rear wheels only if the tires are of the same dimension.

If your vehicle is equipped with mixed-size tires (different tire dimensions front vs. rear), tire rotation is not possible.

### Warning!

Have the tightening torque checked after changing a wheel. The wheels could come loose if they are not tightened to a torque of 110 lb-ft (150 Nm).

Only use genuine Mercedes-Benz wheel bolts specified for your vehicle's rims.

Tire rotation can be performed on vehicles with tires of the same dimension all around. If your vehicle is equipped with tires of the same dimension all around, tires can be rotated, observing a front-to-rear rotation pattern that will maintain the intended rotation (spinning) direction of the tire (▷ page 422).

In some cases, such as when your vehicle is equipped with mixed-size tires (different tire dimension front vs. rear), tire rotation is not possible.

If applicable to your vehicle's tire configuration, tires can be rotated according to the tire manufacturer's recommended intervals in the tire manufacturer's warranty pamphlet located in your vehicle literature portfolio. If none is available, tires should be rotated every 3 000 to 6 000 miles (5 000 to 10 000 km), or sooner if necessary, according to the degree of tire wear. The same rotation (spinning) direction must be maintained.

Rotate tires before the characteristic tire wear pattern becomes visible (shoulder wear on front tires and tread center wear on rear tires).

Thoroughly clean the mounting face of wheels and brake disks, i.e. the inner side of the wheels/tires, during each rotation. Check for and ensure proper tire inflation pressure.

For information on wheel change, see “Flat tire” (▷ page 508).

### Tire labeling

Besides tire name (sales designation) and manufacturer name, a number of markings can be found on a tire.

Following are some explanations for the markings on your vehicle's tires:

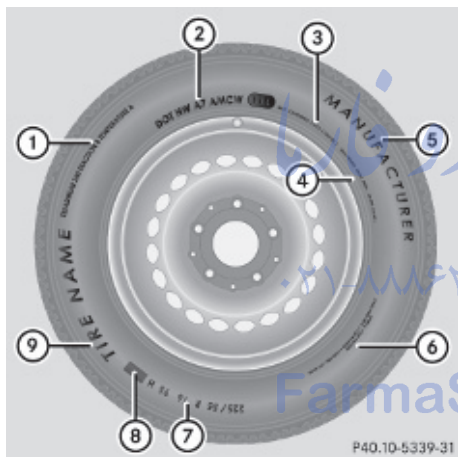

- ① Uniform Tire Quality Grading Standards (▷ page 424)
- ② DOT, Tire Identification Number (▷ page 429)
- ③ Maximum tire load (▷ page 422)
- ④ Maximum tire inflation pressure (▷ page 417)
- ⑤ Manufacturer
- ⑥ Tire ply material (▷ page 430)
- ⑦ Tire size designation, load and speed rating (▷ page 426)
- ⑧ Load identification (▷ page 429)
- ⑨ Tire name

① For illustration purposes only. Actual data on tires are specific to each vehicle and may vary from data shown in above illustration.

For more information, see “Rims and tires” (▷ page 532).

### Tire size designation, load and speed rating

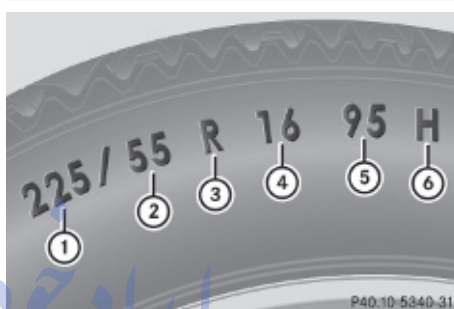

- ① Tire width
- ② Aspect ratio in %
- ③ Radial tire code
- ④ Rim diameter
- ⑤ Load index
- ⑥ Speed symbol

① For illustration purposes only. Actual data on tires are specific to each vehicle and may vary from data shown in above illustration.

General: Depending on the design standards used, the tire size molded into the sidewall may have no letter or a letter preceding the tire size designation.

No letter preceding the size designation (as illustrated above): Passenger car tire based on European design standards.

Letter “P” preceding the size designation: Passenger car tire based on U.S. design standards.

Letter “LT” preceding the size designation: Light Truck tire based on U.S. design standards.

Letter “T” preceding the size designation: Temporary spare tires which are high pressure compact spares designed for temporary emergency use only.

### Tire width

Tire width ① indicates the nominal tire width in millimeters.

### Aspect ratio

Aspect ratio ② is the dimensional relationship between tire section height and section width and is expressed in percentage. The aspect ratio is arrived at by dividing section height by section width.

### Tire code

Tire code ③ indicates the tire construction type. The “R” stands for radial tire type. Letter “D” means diagonal or bias ply construction; letter “B” means belted-bias ply construction.

At the tire manufacturer’s option, any tire with a speed capability above 149 mph (240 km/h) can include a “ZR” in the size designation (for example: 245/40 ZR 18). For additional information, see “Tire speed rating” (▷ page 427).

### Rim diameter

Rim diameter ④ is the diameter of the bead seat, not the diameter of the rim edge. The rim diameter is indicated in inches (in).

### Load index

#### **Warning!**

The tire load rating must always be at least half of the GAWR of your vehicle. Otherwise, tire failure may be the result which may cause an accident and/or serious injury to you or others.

Always replace rims and tires with the same designation, manufacturer and type as shown on the original part.

#### **Warning!**

Do not overload the tires by exceeding the specified load limit as indicated on the Tire

and Loading Information placard on the driver’s door B-pillar. Overloading the tires can overheat them, possibly causing a blowout. Overloading the tires can also result in handling or steering problems, or brake failure.

Load index ⑤ is a numerical code associated with the maximum load a tire can support.

For example, a load rating of 91 corresponds to a maximum load of 1356 lb (615 kg) the tire is designed to support. See also “Maximum tire load” (▷ page 422) where the maximum load associated with the load index is indicated in kilograms and lbs.

For additional information on the load index, see “Load identification” (▷ page 429).

### Speed symbol

#### **Warning!**

Even when permitted by law, never operate a vehicle at speeds greater than the maximum speed rating of the tires.

Exceeding the maximum speed for which tires are rated can lead to sudden tire failure, causing loss of vehicle control and possibly resulting in an accident and/or serious personal injury and possible death, for you and for others.

Regardless of the tire speed rating, local speed limits should be obeyed. Use prudent driving speeds appropriate to prevailing conditions.

Speed symbol ⑥ indicates the approved maximum speed (tire speed rating) for the tire.

Summer tires

Index	Speed rating
Q	up to 100 mph (160 km/h)
R	up to 106 mph (170 km/h)
S	up to 112 mph (180 km/h)
T	up to 118 mph (190 km/h)

Index	Speed rating
H	up to 130 mph (210 km/h)
V	up to 149 mph (240 km/h)
W	up to 168 mph (270 km/h)
Y	up to 186 mph (300 km/h)
ZR...Y	up to 186 mph (300 km/h)
ZR...(..Y)	above 186 mph (300 km/h)
ZR	above 149 mph (240 km/h)

- At the tire manufacturer's option, any tire with a speed capability above 149 mph (240 km/h) can include a "ZR" in the size designation (for example: 245/40 ZR18). To determine the maximum speed capability of the tire, the service description for the tire must be referred to. The service description is comprised of load index (5) and speed symbol (6).

If your tire includes "ZR" in the size designation and no service description is given, the tire manufacturer must be consulted for the maximum speed capability.

If a service description is given, the speed capability is limited by the speed symbol in the service description. Example: 245/40 ZR18 97Y. In this example, "97Y" is the service description. The letter "Y" designates the speed rating and the speed capability of the tire is limited to 186 mph (300 km/h).

- Any tire with a speed capability above 186 mph (300 km/h) must include a "ZR" in the size designation AND the service description must be placed in parenthesis. Example: 275/40 ZR 18 (99Y). The "(Y)" speed symbol in parenthesis designates the maximum speed capability of the tire as being above 186 mph (300 km/h).

Consult the tire manufacturer for the actual maximum permissible speed of the tire.

All-season and winter tires

Index	Speed rating
Q M+S <sup>42</sup>	up to 100 mph (160 km/h)
T M+S <sup>42</sup>	up to 118 mph (190 km/h)
H M+S <sup>42</sup>	up to 130 mph (210 km/h)
V M+S <sup>42</sup>	up to 149 mph (240 km/h)

- i** Not all M+S rated tires provide special winter performance. Make sure the tires you use show M+S and the mountain/snowflake  marking on the tire sidewall. These tires meet specific snow traction performance requirements of the Rubber Manufacturers Association (RMA) and the Rubber Association of Canada (RAC) and have been designed specifically for use in snow conditions.

An electronic speed limiter prevents your vehicle from exceeding a speed of:

- 130 mph (210 km/h):
  - All models except AMG vehicles
- 155 mph (250 km/h):
  - S 63 AMG
  - S 65 AMG
- 186 mph (300 km/h):
  - S 63 AMG (Performance Package)
  - S 63 AMG with increased top speed
  - S 65 AMG with increased top speed

The factory equipped tires on your vehicle may have a tire speed rating above the maximum speed permitted by the electronic speed limiter.

Make sure your tires have the required tire speed rating as specified for your vehicle in

the “Technical data” section (▷ page 532), for example when purchasing new tires.

If you are uncertain about the correct reading of the information given on a tire’s sidewall, any authorized Mercedes-Benz Center will be glad to assist you.

### Load identification



**i** For illustration purposes only. Actual data on tires are specific to each vehicle and may vary from data shown in above illustration.

In addition to the load index, special load identification ① may be molded into the tire sidewall following the letter designating the speed symbol ⑥ (▷ page 426).

- No specification given: absence of any text (like in above example) indicates a standard load (SL) tire.
- XL or Extra Load: designates an extra load (or reinforced) tire.
- Light Load: designates a light load tire.
- C, D, E: designates load range associated with the maximum load a tire can carry at a specified pressure.

### DOT, Tire Identification Number (TIN)

U.S. tire regulations require each new tire manufacturer or tire retreader to mold a TIN into or onto a sidewall of each tire produced.

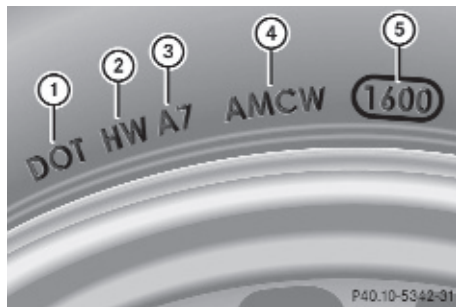

The TIN is a unique identifier. The TIN facilitates efforts by tire manufacturers to notify purchasers in recall situations or other safety matters concerning tires. It gives purchasers the means to easily identify such tires.

The TIN is comprised of “Manufacturer’s identification mark” ②, “Tire size” ③, “Tire type code” ④ and “Date of manufacture” ⑤.

**i** For illustration purposes only. Actual data on tires are specific to each vehicle and may vary from data shown in above illustration.

### DOT (Department of Transportation)

Tire branding symbol ① denotes that the tire meets requirements of the U.S. Department of Transportation.

### Manufacturer’s identification mark

Manufacturer’s identification mark ② denotes the tire manufacturer.

New tires have a mark with two symbols.

Retreaded tires have a mark with four symbols. For more information on retreaded tires, see (▷ page 410).

### Tire size

Code ③ indicates the tire size.

### Tire type code

Tire type code ④ may, at the option of the manufacturer, be used as a descriptive code for identifying significant characteristics of the tire.

### Date of manufacture

The date of manufacture ⑤ identifies the week and year of manufacture.

The first two figures identify the week, starting with “01” to represent the first full week of the calendar year. The second two figures represent the year.

For example, “3208” represents the 32nd week of 2008.

### Tire ply material



**i** For illustration purposes only. Actual data on tires are specific to each vehicle and may vary from data shown in above illustration.

This marking tells you about the type of cord and number of plies in the sidewall ① and under the tread ②.

### Tire and loading terminology

#### Accessory weight

The combined weight (in excess of those standard items which may be replaced) of automatic transmission, power steering, power brakes, power windows, power seats,

radio, and heater, to the extent that these items are available as factory-installed equipment (whether installed or not).

#### Air pressure

The amount of air inside the tire pressing outward on each square inch of the tire. Air pressure is expressed in pounds per square inch (psi), kilopascal (kPa), or bar.

#### Aspect ratio

Dimensional relationship between tire section height and section width expressed in percentage.

#### Bar

Metric unit for air pressure. There are 14.5038 pounds per square inch (psi) to 1 bar; there are 100 kilopascals (kPa) to 1 bar.

#### Bead

The tire bead contains steel wires wrapped by steel cords that hold the tire onto the rim.

#### Cold tire inflation pressure

Tire inflation pressure when your vehicle has been sitting for at least 3 hours or driven no more than 1 mile (1.6 km).

#### Curb weight

The weight of a motor vehicle with standard equipment including the maximum capacity of fuel, oil, and coolant, and, if so equipped, air conditioning and additional optional equipment, but without passengers and cargo.

#### DOT (Department of Transportation)

A tire branding symbol which denotes the tire meets requirements of the U.S. Department of Transportation.

### **GAWR (Gross Axle Weight Rating)**

---

The GAWR is the maximum permissible axle weight. The gross vehicle weight on each axle must never exceed the GAWR for the front and rear axle indicated on the certification label located on the driver's door B-pillar.

### **GVW (Gross Vehicle Weight)**

---

The GVW comprises the weight of the vehicle including fuel, tools, spare wheel, installed accessories, passengers and cargo and, if applicable, trailer tongue load. The GVW must never exceed the GVWR indicated on the certification label located on the driver's door B-pillar.

### **GVWR (Gross Vehicle Weight Rating)**

---

This is the maximum permissible vehicle weight of the fully loaded vehicle (weight of the vehicle including all options, passengers, fuel, and cargo and, if applicable, trailer tongue load). It is indicated on the certification label located on the driver's door B-pillar.

### **Kilopascal (kPa)**

---

Metric unit for air pressure. There are 6.9 kPa to 1 psi; another metric unit for air pressure is bar. There are 100 kilopascals (kPa) to 1 bar.

### **Load index**

---

Numerical code associated with the maximum load a tire can support.

### **Maximum load rating**

---

The maximum load in kilograms and pounds that can be carried by the tire.

### **Maximum loaded vehicle weight**

---

The sum of curb weight, accessory weight, total load limit, and production options weight.

### **Maximum permissible tire inflation pressure**

---

This number is the greatest amount of air pressure that should ever be put in the tire.

### **Normal occupant weight**

---

The number of occupants the vehicle is designed to seat, multiplied by 68 kilograms (150 lb).

### **Occupant distribution**

---

The distribution of occupants in a vehicle at their designated seating positions.

### **Production options weight**

---

The combined weight of those installed regular production options weighing over 5 lbs (2.3 kilograms) in excess of those standard items which they replace, not previously considered in curb weight or accessory weight, including heavy duty brakes, ride levelers, roof rack, heavy duty battery, and special trim.

### **PSI (Pounds per square inch)**

---

A standard unit of measure for air pressure.

### **Recommended tire inflation pressure**

---

The recommended tire inflation pressure for normal driving conditions is listed on the Tire and Loading Information placard located on the driver's door B-pillar. It provides best handling, tread life and riding comfort. Supplemental information pertaining to special driving situations can be found on the tire inflation pressure label on the inside of the fuel filler flap.

### **Rim**

---

A metal support for a tire or a tire and tube assembly upon which the tire beads are seated.



## Sidewall

The portion of a tire between the tread and the bead.

## TIN (Tire Identification Number)

Unique identifier which facilitates efforts by tire manufacturers to notify purchasers in recall situations or other safety matters concerning tires and gives purchasers the means to easily identify such tires. The TIN is comprised of “Manufacturer’s identification mark”, “Tire size”, “Tire type code” and “Date of manufacture”.

## Tire ply composition and material used

This indicates the number of plies or the number of layers of rubber-coated fabric in the tire tread and sidewall. Tire manufacturers also must indicate the ply materials in the tire and sidewall, which include steel, nylon, polyester, and others.

## Tire speed rating

Part of tire designation (speed symbol); indicates the speed range for which a tire is approved.

## Total load limit

Rated cargo and luggage load plus 68 kilograms (150 lb) times the vehicle’s designated seating capacity.

## Traction

The adhesive friction of a tire on a surface on which it moves. The amount of grip provided.

## Tread

The portion of a tire that comes into contact with the road.

## Treadwear indicators

Narrow bands, sometimes called “wear bars” that show across the tread of a tire when only  $\frac{1}{16}$  in (1.6 mm) of tread remains.

## Uniform Tire Quality Grading Standards

A tire information system that provides consumers with ratings for a tire’s traction, temperature and treadwear. Ratings are determined by tire manufacturers using U.S. government testing procedures. The ratings are molded into the sidewall of the tire.

## Vehicle maximum load on the tire

Load on an individual tire that is determined by distributing to each axle its share of the maximum loaded vehicle weight and dividing it by two.

## Winter driving

### General information

Have your vehicle winterized at an authorized Mercedes-Benz Center.

### Winter tires

#### Warning!

Winter tires with a tread depth of less than  $\frac{1}{6}$  in (4 mm) must be replaced. They are no longer suitable for winter operation.

#### Warning!

If you use your spare wheel when winter tires are fitted on the other wheels, be aware that the difference in tire characteristics may very well impair turning stability and that overall driving stability may be reduced. Adapt your driving style accordingly.

Have the spare wheel replaced by a regular road wheel with a winter tire at the nearest authorized Mercedes-Benz Center.

Always use winter tires at temperatures below 45°F (7°C) and whenever wintry road conditions prevail. Not all M+S rated tires provide special winter performance. Make sure the tires you use show the mountain/snowflake  marking on the tire sidewall. These tires meet specific snow traction performance requirements of the Rubber Manufacturers Association (RMA) and the Rubber Association of Canada (RAC) and have been designed specifically for use in snow conditions. Use of winter tires is the only way to achieve the maximum effectiveness of your vehicle's driving safety systems such as the ABS and the ESC in winter operation.

For safe handling, make sure all mounted winter tires are of the same make and have the same tread design.

For information on winter tires for your vehicle model, see the "Technical data" section (▷ page 532).

Always observe the speed rating of the winter tires installed on your vehicle.

After installing winter tires:

- ▶ Check the tire inflation pressure and adjust it if necessary (▷ page 413).
- ▶ Restart the Advanced Tire Pressure Monitoring System (▷ page 414).

### Snow chains

**!** When driving with snow chains, always select the raised level of the vehicle level control. Other settings may result in damage to your vehicle.

**!** Some tire sizes do not leave adequate clearance for snow chains. To help avoid serious damage to your vehicle or tires, make sure the use of snow chains is permissible as specified in the "Technical data" section of this Operator's Manual.

Snow chains should only be driven on snow-covered roads at speeds not to exceed

30 mph (50 km/h). Remove chains as soon as possible when driving on roads without snow.

Observe the following guidelines when using snow chains:

- Use of snow chains is not permissible with all wheel/tire combinations (▷ page 532).
- Use snow chains in pairs and on rear wheels only. Follow the manufacturer's mounting instructions.

**!** If snow chains are mounted to the front wheels, they may scrape against the body or axle components. The tires or the vehicle could be damaged as a result.

- Only use snow chains that are approved by Mercedes-Benz. Any authorized Mercedes-Benz Center will be glad to advise you on this subject.
- Use of snow chains may be prohibited depending on location. Always check local and state laws before installing snow chains.
- Do not use snow chains on the spare wheel.

**i** When driving with snow chains, you may wish to switch off the ESC (▷ page 232) before setting the vehicle in motion. This will improve the vehicle's traction.

### Winter driving instructions

#### Warning!

If the vehicle becomes stuck in snow, make sure snow is kept clear of the exhaust pipe and from around the vehicle with the engine running. Otherwise, deadly carbon monoxide (CO) gases may enter vehicle interior resulting in unconsciousness and death.

To assure sufficient fresh air ventilation, open a window slightly on the side of the vehicle not facing the wind.

 **Warning!**

The outside temperature indicator is not designed to serve as an ice-warning device and is therefore unsuitable for that purpose.

Indicated temperatures just above the freezing point do not guarantee that the road surface is free of ice. The road may still be icy, especially in wooded areas or on bridges.

 **Warning!**

On slippery road surfaces, never downshift in order to obtain braking action. This could result in drive wheel slip and reduced vehicle control. Your vehicle's ABS will not prevent this type of loss of control.

The most important rule for slippery or icy roads is to drive sensibly and to avoid abrupt acceleration, braking and steering maneuvers. Do not use the cruise control or DISTRONIC PLUS system under such conditions.

When the vehicle is in danger of skidding, shift the automatic transmission to neutral position **N**. Try to keep the vehicle under control by corrective steering action.

-  For information on driving with snow chains, see "Snow chains" (▷ page 433).

Road salts and chemicals can adversely affect braking efficiency. Increased pedal force may become necessary to produce the normal brake effect.

Depressing the brake pedal periodically when traveling at length on salt-strewn roads can bring road-salt-impaired braking efficiency back to normal.

If the vehicle is parked after being driven on salt-treated roads, the braking efficiency should be tested as soon as possible after driving is resumed.

 **Warning!**

Make sure not to endanger any other road users when carrying out these braking maneuvers.

**Driving instructions****Drive sensibly – save fuel**

To save fuel you should:

- Keep tires at the recommended inflation pressures.
- Remove unnecessary loads.
- Remove roof rack when not in use.
- Allow engine to warm up under low load use.
- Avoid frequent acceleration and deceleration.
- Have all maintenance work performed at the intervals specified in the Maintenance Booklet and as required by the Maintenance system. Contact an authorized Mercedes-Benz Center.

Fuel consumption is also increased by driving in cold weather, in stop-and-go traffic, on short trips and in mountainous areas.

**Drinking and driving** **Warning!**

Drinking and driving and/or taking drugs and driving are very dangerous combinations. Even a small amount of alcohol or drugs can affect your reflexes, perceptions and judgment.

The possibility of a serious or even fatal accident are greatly increased when you drink or take drugs and drive.

Do not drink or take drugs and drive or allow anyone to drive who has been drinking or taking drugs.

**Pedals** **Warning!**

Make sure absolutely no objects are obstructing the pedals' range of movement. Keep the driver's footwell clear of all

obstacles. If there are any floor mats or carpets in the footwell, make sure that the pedals still have sufficient clearance. During sudden driving or braking maneuvers, the objects could get caught between the pedals. You could then no longer brake or accelerate. This could lead to accidents and injury.

### Power assistance

#### Warning!

There is no power assistance for the steering and the brake when the engine is not running. Steering and braking requires significantly more effort and you could lose control of the vehicle and cause an accident as a result. Do not turn off the engine while the vehicle is in motion.

### Brakes

#### Downhill grades

**!** When driving down long and steep grades, relieve the load on the brakes by shifting into a lower gear to use the engine's braking power. This helps prevent overheating of the brakes and reduces wear.

When using the engine's braking power, a drive wheel may not spin for an extended period of time, e.g. on slippery road surfaces. This may cause serious damage to the drivetrain which is not covered by the Mercedes-Benz Limited Warranty.

#### Continuous or hard braking

#### Warning!

Resting your foot on the brake pedal will cause excessive and premature wear of the brake pads.

It can also result in the brakes overheating, thereby significantly reducing their effectiveness. It may not be possible to stop the vehicle in sufficient time to avoid an accident.

After hard braking, it is advisable to drive on for some time, rather than immediately park, so that the air stream will cool down the brakes faster.

#### Wet roads

#### Warning!

After driving in heavy rain for some time without applying the brakes or through water deep enough to wet brake components, the first braking action may be somewhat reduced and increased pedal pressure may be necessary to obtain expected brake effect. Maintain a safe distance from vehicles in front.

To help prevent brake disk corrosion after driving on wet or salt-covered roads, it is advisable to brake the vehicle with considerable force prior to parking. The heat generated serves to dry the brakes.

#### Salt-covered roads

#### Warning!

A layer of salt on the brake discs and the brake linings may cause a delay in the braking effect, resulting in a significantly increased braking distance, which could lead to an accident.

To avoid this danger, you should:

- occasionally brake carefully when you are driving on salt-covered roads, so that any layer of salt that may have built up on the brake discs and the brake linings is

removed without putting other road users at risk

- maintain a greater distance to the vehicle ahead and drive with particular care
- carefully apply the brakes at the end of a trip and immediately after commencing a new trip, so that salt residues are removed from the brake disc

## Brake service

**!** The brake fluid level in the reservoir may be too low if the red brake warning lamp in the instrument cluster comes on while the engine is running and an acoustic warning sounds. Observe additional messages in the multifunction display that may appear. Brake pad wear or a leak in the system may be the reason for low brake fluid in the reservoir.

Have the brake system inspected immediately. Contact an authorized Mercedes-Benz Center.

All checks and service work on the brake system should be carried out by qualified technicians only. Contact an authorized Mercedes-Benz Center.

Only install brake pads and use brake fluid recommended by Mercedes-Benz.

### Warning!

If other than recommended brake pads are installed, or other than recommended brake fluid is used, the braking properties of the vehicle can be degraded to an extent that safe braking is substantially impaired. This could result in an accident.

**!** Vehicles with 4MATIC:

Only conduct operational or performance tests on a two-axle dynamometer. If such tests are necessary, contact an authorized Mercedes-Benz Center. You could otherwise seriously damage the brake system or the transfer case which is not

covered by the Mercedes-Benz Limited Warranty.

**!** Vehicles with 4MATIC:

Because the ESC operates automatically, the engine and ignition must be shut off (SmartKey in starter switch position **0** or **1** or KEYLESS-GO start/stop button in position **0** or **1**) when the electronic parking brake is being tested on a brake test dynamometer.

Active braking action through the ESC may otherwise seriously damage the brake system which is not covered by the Mercedes-Benz Limited Warranty.

**!** Vehicles without 4MATIC:

Because the ESC operates automatically, the engine and ignition must be shut off (SmartKey in starter switch position **0** or **1** or KEYLESS-GO start/stop button in position **0** or **1**) when the electronic parking brake is being tested on a brake test dynamometer or when the vehicle is being towed with one axle raised.

Active braking action through the ESC may otherwise seriously damage the brake system which is not covered by the Mercedes-Benz Limited Warranty.

If your brake system is only subjected to moderate loads, you should occasionally test the effectiveness of the brakes by applying above-normal braking pressure at higher speeds. This will also enhance the grip of the brake pads.

### Warning!

Make sure not to endanger any other road users when carrying out these braking maneuvers.

Refer to the description of the Brake Assist System (BAS) (> page 64) or BAS PLUS (> page 64).

## High-performance brake system

The high-performance brake system is only available on S 63 AMG and S 65 AMG.

### Warning!

New vehicle brake pads and disks, and replacement brake pads and disks may take several hundred miles of driving until they provide optimum braking efficiency. Until that time, you may need to use increased brake pedal pressure while braking. Please be aware of this and adjust your driving and braking accordingly during this break-in period.

Excessive high-demand braking will cause correspondingly high brake wear. Please be attentive to the brake warning lamp in the instrument cluster and brake condition messages in the multifunction display. Especially for high-performance driving, it is important to maintain and have the brake system checked regularly.

The high-performance brake system is designed to operate under the extremely high operating demands required to accommodate the performance capabilities of the vehicle.



The brakes may produce a squeaking-type noise depending on the

- vehicle speed
- brake force applied
- ambient conditions, e.g. temperature and humidity

As with any brake system, the wear of individual brake system components such as brake pads or disks strongly depends on your driving style and the conditions under which you operate the vehicle. Thus, a driving style calling for high-demand braking will cause your vehicle's brakes to wear more quickly.

## Driving off

Warm up the engine smoothly. Do not place full load on the engine until the operating temperature has been reached.

-  When driving off on a slippery surface, do not allow a drive wheel to spin for an extended period with the ESC switched off. Doing so may cause serious damage to the drivetrain which is not covered by the Mercedes-Benz Limited Warranty.
-  Simultaneously depressing the accelerator pedal and applying the brakes reduces engine performance and causes premature brake and drivetrain wear which is not covered by the Mercedes-Benz Limited Warranty.

## Hydroplaning

Depending on the depth of the water layer on the road, hydroplaning may occur, even at low speeds and with new tires. In heavy rain or when conditions indicate possible hydroplaning:

- ▶ Reduce vehicle speed.
- ▶ Avoid track grooves in the road.
- ▶ Apply brakes cautiously.

## Standing water

-  Do not drive through flooded areas. Before driving through water, determine its depth.

If you must drive through standing water, drive slowly to prevent water from entering the passenger compartment or the engine compartment. Water in these areas could cause damage to electrical components or wiring of the engine or transmission, or could result in water being ingested by the engine through the air intake causing severe internal engine damage. Any such damage is not covered by the Mercedes-Benz Limited Warranty.

### Driving abroad

If you plan to drive the vehicle outside the U.S. or Canada, you should request dealer network information for your destination from any authorized Mercedes-Benz Center.

### Control and operation of radio transmitter

#### Safety notes

##### Warning!

Please do not forget that your primary responsibility is to drive the vehicle. A driver's attention to the road must always be his/her primary focus when driving. For your safety and the safety of others, we recommend that you pull over to a safe location and stop before placing or taking a telephone call.

If you choose to use the telephone<sup>43</sup> while driving, please use the hands-free device and only use the telephone when road, weather and traffic conditions permit. Some jurisdictions prohibit the driver from using a mobile telephone while driving a vehicle.

Only operate the COMAND<sup>43</sup> (Cockpit Management and Data System) if road, weather and traffic conditions permit. Otherwise, you may not be able to observe traffic conditions and could endanger yourself and others.

Bear in mind that at a speed of just 30 mph (approximately 50 km/h), your vehicle is covering a distance of 44 feet (approximately 14 m) every second.

### Emission control

Certain systems of the engine serve to keep the toxic components of the exhaust gases within permissible limits required by law. These systems will function properly only when maintained strictly according to factory

specifications. Any adjustments on the engine should, therefore, be carried out only by qualified Mercedes-Benz Center authorized technicians.

Engine adjustments should not be altered in any way. Moreover, the specified service procedures must be carried out regularly according to Mercedes-Benz servicing requirements. For details refer to the Maintenance Booklet.

##### Warning!

Inhalation of exhaust gas is hazardous to your health. All exhaust gas contains carbon monoxide (CO), and inhaling it can cause unconsciousness and possible death.

Do not run the engine in confined areas (such as a garage) which are not properly ventilated. If you think that exhaust gas fumes are entering the vehicle while driving, have the cause determined and corrected immediately. If you must drive under these conditions, drive only with at least one window fully open at all times.

### Maintenance

#### Notes

The Maintenance System in your vehicle tracks the distance driven and the time elapsed since the last maintenance service. It calculates other maintenance service work required, and calls for the next maintenance service accordingly.

We strongly recommend that you have your vehicle serviced at an authorized Mercedes-Benz Center. Have it serviced in accordance with the Maintenance Booklet at the times called for by the maintenance service indicator.

 Failure to have the vehicle maintained in accordance with the Maintenance Booklet and maintenance service indicator at the designated times/mileage will result in

<sup>43</sup> Observe all legal requirements.



vehicle damage not covered by the Mercedes-Benz Limited Warranty.

### Maintenance service indicator message

Information on maintenance work and maintenance intervals are specified in the Maintenance Booklet. Contact an authorized Mercedes-Benz Center, or visit [www.mbusa.com](http://www.mbusa.com) (USA only) for additional information.

The maintenance service indicator message will notify you when the next maintenance service is required.

Starting approximately 1 month before the next maintenance service is required, one of the following messages will appear in the multifunction display. The messages will appear while you are driving or when you switch on the ignition (example service A):

Next Service A in XXXX miles (km)

Next Service A in XX days

Service A Due

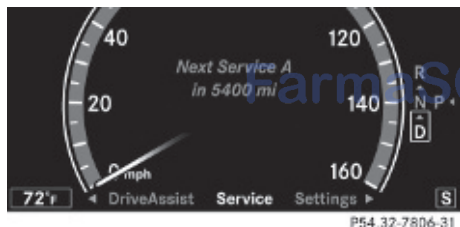

Refer to Maintenance Booklet for a listing of maintenance services and intervals they need to be performed at.

### Clearing the maintenance service indicator message

The maintenance service indicator message is cleared automatically

- after approximately 10 seconds when you switch on the ignition
- after approximately 10 seconds when reaching the service threshold while driving
- after approximately 30 seconds, once the suggested maintenance service term has passed

► **Clearing the maintenance service indicator message manually:** Press button  on the multifunction steering wheel.

The standard display appears in the multifunction display.

### Maintenance service term exceeded

If you have exceeded the suggested maintenance service term, you will see the following message in the multifunction display:

Service A Exceeded By XXXXX miles (km)

Service A Exceeded by XXX days

Service A Exceeded By XXX days





In addition, a signal sounds when the message appears.

Any authorized Mercedes-Benz Center will reset the maintenance service indicator following a completed maintenance service.

### Calling up the maintenance service indicator display

- ❗ The menu overview can be found on (▷ page 222).

You can call up the maintenance service indicator display at any time to check when the next maintenance service is required.

- ▶ Switch on the ignition.  
The standard display of the control system appears (▷ page 223).
- ▶ Press button  or  on the multifunction steering wheel to select the Service menu.
- ▶ Press button  or  to select ASSYST PLUS.
- ▶ Press button  on the multifunction steering wheel to confirm.  
The maintenance service indicator display with the maintenance service deadline appears in the multifunction display.

**i** If the battery was disconnected, the days of disconnection will not be included in the count shown by the maintenance service indicator. To arrive at the true maintenance service deadline, you will need to subtract these days from the days shown in the maintenance service indicator message or maintenance service indicator display.

### Resetting the maintenance service indicator

In the event that the maintenance service on your vehicle is not carried out at an authorized Mercedes-Benz Center, you can have the maintenance service indicator reset.

The automotive maintenance facility carrying out the maintenance service will find the information for resetting the maintenance service indicator in the maintenance-relevant literature for your vehicle.

Such literature is available at any authorized Mercedes-Benz Center or directly from Mercedes-Benz.

**!** If the maintenance service indicator was reset inadvertently, have an authorized Mercedes-Benz Center correct it.

Only reset the maintenance service indicator if the proper maintenance service has been performed. Not following the proper maintenance service as described in the Maintenance Booklet will result in

engine damage and/or other vehicle damage not covered by the Mercedes-Benz Limited Warranty.

## Vehicle care

### Cleaning and care of the vehicle

#### Notes

Regular and proper care will help to maintain the value of your vehicle.

#### **Warning!**

Many cleaning products can be hazardous. Some are poisonous, others are flammable. Always follow the instructions on the particular container. Always open your vehicle's doors or windows when cleaning the inside.

Never use fluids or solvents that are not designed for cleaning your vehicle.

Always lock away cleaning products and keep them out of reach of children.

**!** When cleaning the vehicle, do not use scouring agents. Never apply strong force and only use a soft, wet cloth or sponge. Otherwise you may scratch or damage the surface to be cleaned.

While in operation, even while parked, your vehicle is subjected to varying external influences which, if gone unchecked, can attack the paintwork as well as the vehicle underbody and cause lasting damage.

Such damage is caused not only by extreme and varying climatic conditions, but also by:

- Air pollution
- Road salt
- Tar
- Gravel and stone chipping

To avoid paint damage, you should immediately remove:

- Grease and oil
- Fuel
- Coolant
- Brake fluid
- Bird droppings
- Insects
- Tree resins etc.

Frequent washing reduces and/or eliminates the aggressiveness and potency of the above adverse influences.

More frequent washings are necessary to deal with unfavorable conditions:

- near the ocean
- in industrial areas (smoke, exhaust emissions)
- during winter operation

You should check your vehicle from time to time for stone chipping or other damage. Any damage should be repaired as soon as possible to prevent corrosion.

In doing so, do not neglect the underbody of the vehicle. A prerequisite for a thorough check is a washing of the underbody followed by a thorough inspection. Damaged areas need to be re-undercoated.

Your vehicle has been treated at the factory with a wax-base rustproofing in the body cavities which will last for the lifetime of the vehicle. Post-production treatment is neither necessary nor recommended by Mercedes-Benz because of the possibility of incompatibility between materials used in the production process and others applied later. We have selected vehicle-care products and compiled recommendations which are specially matched to our vehicles and which always reflect the latest technology. You can obtain Mercedes-Benz approved vehicle-care products at an authorized Mercedes-Benz Center.

Scratches, corrosive deposits, corrosion or damage due to negligent or incorrect care cannot always be removed or repaired with the vehicle-care products recommended here. In such cases it is best to seek aid at an authorized Mercedes-Benz Center.

The following topics deal with the cleaning and care of your vehicle and give important “how-to” information as well as references to Mercedes-Benz approved vehicle-care products.

### Power washer

**!** Follow the instructions provided by the power washer manufacturer on maintaining a distance between the vehicle and the nozzle of the power washer.

Never use a round nozzle to power-wash tires. The intense jet of water can result in damage to the tire.

Always replace a damaged tire.

Always keep the jet of water moving across the surface. Do not aim directly at electrical parts, electrical connectors, seals, or other rubber parts.

**i** Vehicles with KEYLESS-GO:

If a door handle is hit by a strong jet of water, and a SmartKey is within approximately 3 ft (1 m) of the vehicle, it could be inadvertently locked or unlocked.

### Tar stains

Quickly remove tar stains before they dry and become more difficult to remove. A tar remover is recommended.

### Paintwork, painted body components

**!** Affixing stickers, magnets, adhesive tape or similar materials to painted body components may damage the paintwork.

Mercedes-Benz approved Paint Care should be applied when water drops on the paint surface do not “bead up”. This should

normally be done every 3 to 5 months, depending on the climate and washing detergent used.

Mercedes-Benz approved Paint Cleaner should be applied if the paint surface shows signs of embedded dirt (i.e. loss of gloss).

Do not apply any of these products or wax if your vehicle is parked in the sun or if the hood is still hot.

- ▶ Use the appropriate MB-Touch-Up Stick for quick and provisional repairs of minor paint damage (i.e. chips from stones, vehicle doors, etc.).

### Engine cleaning

Prior to cleaning the engine compartment, make sure to protect electrical components and connectors from contact with water and cleaning agents.

Corrosion protection, such as MB Anticorrosion Wax should be applied to the engine compartment after every engine cleaning. Before applying, all control linkage bushings and joints should be lubricated. The poly-V-belt and all pulleys should be protected from any wax.

### Vehicle washing

In the winter, thoroughly remove all traces of road salt as soon as possible.

When washing the vehicle underbody, do not forget to clean the inner sides of the wheels.

- i** Vehicles with KEYLESS-GO:  
If a door handle is hit by a strong jet of water, and a SmartKey is within approximately 3 ft (1 m) of the vehicle, it could be inadvertently locked or unlocked.

### Hand-wash

- ▶ Do not use hot water or wash your vehicle in direct sunlight.
- ▶ Only use a soft, wet cloth or sponge to clean the vehicle.

- ▶ Only use a mild vehicle wash detergent, such as Mercedes-Benz approved Car Shampoo.
- ▶ Thoroughly spray the vehicle with a diffused jet of water.
- ▶ Do not spray directly towards the ventilation intake.
- ▶ Use plenty of water and rinse the sponge and chamois frequently.
- ▶ Rinse with clean water and dry with a chamois thoroughly.

Do not allow cleaning agents to dry on the finish.

### Automatic car wash

#### Warning!

The vehicle is braked when the HOLD function or DISTRONIC PLUS is activated. Therefore, deactivate the HOLD function or DISTRONIC PLUS before the vehicle is washed in an automatic car wash.

You can have your vehicle washed in an automatic car wash from the start. Brushless car washes are preferable.

- ▶ To protect the filter system, activate the air recirculation mode using rocker switch  on the climate control panel.

- !** Do not clean your vehicle in an automatic touchless car wash which uses caustic spray. Caustic spray will damage the paint or ornamental moldings.

If the vehicle is very dirty, prewash it before running it through the automatic car wash.

- !** Make sure the combination switch is set to wiper setting . Otherwise, the rain sensor could activate and cause the wipers to move unintentionally. This may lead to vehicle damage.

Due to the width of the vehicle, fold in exterior rear view mirrors prior to running the vehicle through an automatic car wash to prevent damage to the mirrors.

► **When taking the vehicle through an automatic conveyor-type car wash:**

**Make sure the automatic transmission remains in neutral position N.** Observe instructions, see “Remaining in neutral position N” (► page 319).

When leaving the automatic car wash, make sure the mirrors are folded out.

After running the vehicle through an automatic car wash, wipe any wax off of the windshield and the wiper blade inserts. This will prevent smears and reduce wiping noise which can be caused by residual wax on the windshield.

### Ornamental moldings

► For regular cleaning and care of ornamental moldings, use a damp cloth.

**!** Do not use chrome cleaner on ornamental moldings. Although ornamental moldings may have chrome appearance, they could be made of anodized aluminum that will be damaged when cleaned with chrome cleaner. Instead, use a damp cloth to clean those ornamental moldings.

For very dirty ornamental moldings of which you are sure are chrome-plated, use a chrome cleaner. If in doubt whether an ornamental molding is chrome-plated, contact an authorized Mercedes-Benz Center.

### Headlamps, brake lamps, tail lamps, side markers, turn signal lenses

► Use a mild vehicle wash detergent, such as Mercedes-Benz approved Car Shampoo, with plenty of water.

**!** Only use window cleaning solutions that are suitable for plastic lamp lenses. Window cleaning solutions which are not suitable may damage the plastic lamp lenses of the headlamps. Therefore, do not use abrasives, solvents or cleaners that contain solvents.

### Cleaning the driving systems sensors

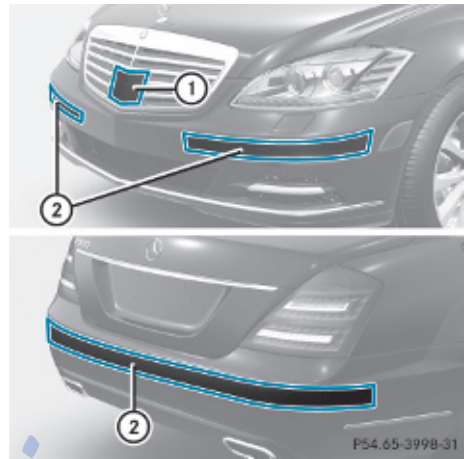

► Switch off the ignition.

► Clean DISTRONIC PLUS/PRE-SAFE® Brake system sensor cover ① by hand.

To clean DISTRONIC PLUS/PRE-SAFE® Brake system sensor cover ① and the bumper area near sensors ② observe the following:

- Use a mild vehicle wash detergent, such as Mercedes-Benz approved Car Shampoo, with plenty of water.
- Use a soft, non-scratching cloth.

**!** If you use a power washer to clean the sensor covers, observe the following:

- Follow the instructions provided by the power washer manufacturer.
- Maintain a distance between the sensor covers and the nozzle of the power washer.

## Cleaning the rear view camera lens

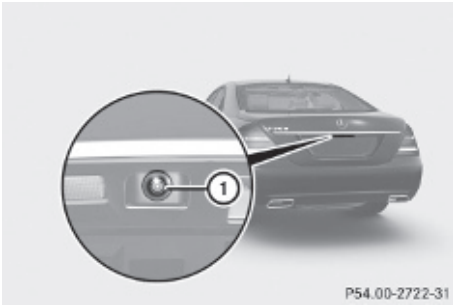

- Only use clean water and a soft, non-scratching cloth to clean rear view camera lens ①.

Be careful not to apply wax to rear view camera lens ① when waxing the vehicle. If necessary, remove the wax using the Mercedes-Benz approved Car Shampoo with plenty of water.

**!** Do not clean the camera and the area around the camera

- with a high-pressure cleaner
- with a dry cloth and strong pressure
- with aggressive cleaning agents

You could otherwise damage the camera.

## Cleaning the windshield in front of the Night View Assist Plus camera

The Night View Assist Plus camera is located in front of the interior rear view mirror.

### **!** Warning!

Please do not forget that your primary responsibility is to drive the vehicle. A driver's attention to the road must always be his/her primary focus when driving. For your safety and the safety of others, stop before trying to remove window fogging or cleaning the window in front of the Night View Assist Plus camera.

Bear in mind that at a speed of just 30 mph (approximately 50 km/h), your vehicle is

covering a distance of 44 feet (approximately 14 m) every second.

**!** Do not clean the lens of the Night View Assist Plus camera. If the camera lens is dirty, please contact an authorized Mercedes-Benz Center.

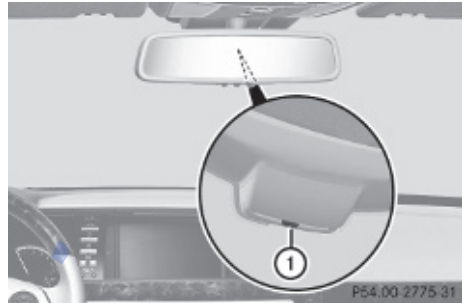

- Use recessed handle ① of camera cover to swing camera cover downward.



- Clean inside of windshield in front of camera ② with a soft, non-scratching cloth.

**!** If you use a windshield cleaning product, make sure that none of the cleaning product comes into contact with the lens of the Night View Assist Plus camera.

- Use recessed handles ① of camera cover to swing camera cover up.

## Cleaning the windows and the wiper blades

**!** The windshield wipers must be in a vertical position before folding them away from the windshield. They could otherwise damage the hood.

Never open the hood when the wiper arms are folded forward.

- ▶ Make sure the hood is fully closed.
- ▶ Switch on the ignition.
- ▶ Turn combination switch to wiper setting  (▷ page 305).
- ▶ With wiper arms in vertical position, switch off the ignition.

### Warning!

For safety reasons, switch off wipers and remove SmartKey from starter switch before cleaning the windshield and/or the wiper blades. Vehicles with KEYLESS-GO: Make sure the vehicle's on-board electronics have status **0**. Otherwise, the wiper motor could suddenly turn on and cause injury.

- !** Do not pull on the wiper blade inserts. They could tear.
- ▶ Fold the wiper arms forward until they snap into place.
- ▶ Clean the windshield and the wiper blade inserts with a clean cloth and mild detergent solution.
- ▶ Use a soft, clean cloth and a mild window cleaning solution on all outside and inside glass surfaces.  
An automotive glass cleaner is recommended.
- !** Fold the windshield wiper arms back onto the windshield before turning the SmartKey in the starter switch or pressing the KEYLESS-GO start/stop button.  
Hold on to the wiper when folding the wiper arm back. If released, the force of the

impact from the tensioning spring could crack the windshield.

- !** To clean the window interior, do not use a dry cloth, abrasives, solvents or cleaners containing solvents. Do not touch the inside of the windows with hard objects such as an ice scraper or ring. Doing so may damage the windows.

## Cleaning the panorama roof with power tilt/sliding panel

The rear part of the tilt/sliding panel has a protective layer on the inside.

- ▶ Use a soft, clean cloth and a mild window cleaning solution.  
An automotive glass cleaner is recommended.
- !** Do not use a dry cloth, abrasives, solvents or cleaners containing solvents. Do not touch the protective layer with hard objects such as an ice scraper or ring. Never apply strong force and only use a soft, non-scratching cloth when cleaning the rear part of the tilt/sliding panel.  
Otherwise you may scratch or damage the protective layer.

## Light alloy wheels

If possible, clean wheels once a week.

- ▶ Use Mercedes-Benz approved Wheel Care, a soft bristle brush and a strong spray of water for cleaning the light alloy wheels.
- !** Only use acid-free cleaning materials. Acid may cause corrosion or damage the clear coat.
- !** The vehicle should not be parked for an extended period of time immediately after it has been cleaned. This applies especially after the wheel rims have been cleaned with wheel rim cleaner. Wheel rim cleaners can lead to increased corrosion of the brake disks and brake pads. Non-approved



wheel cleaners may also damage the wheel paint if the vehicle is not driven after cleaning.

Therefore, the vehicle's brake system should always be warmed-up before it is parked after cleaning. Drive your vehicle for several minutes to allow the brakes to dry. When applying Mercedes-Benz approved Tire Care and Mercedes-Benz approved Wheel Care products, take care not to spray them on the brake disks.

### Plastic and rubber parts

- ▶ Use a gentle dishwashing detergent or mild detergent for delicate fabrics as a washing solution.
- ▶ Wipe with a cloth moistened in a lukewarm solution. The surface may temporarily change color. If this is the case, wait for it to dry.

#### Warning!

Do not use cleaners or cockpit care sprays containing solvents to clean the cockpit or the steering wheel. Cleaners containing solvents will make the surface porous and vehicle occupants could suffer serious injuries from plastic parts coming loose in the event of air bag deployment.

- ❗ Do not use oil, wax or scouring agents. Otherwise you may scratch or damage the surface.

### Hard plastic trim items

- ▶ Use Mercedes-Benz approved Interior Care on a soft, lint-free cloth and apply with light pressure.

### COMAND display

- ❗ You must switch off the COMAND display and allow it to cool prior to cleaning.

- ❗ Do not use any liquids or cleaning agents. These can damage or even destroy the COMAND display screen.

- ▶ Use a standard microfiber cloth and apply with light pressure.

### Steering wheel

- ▶ Wipe with a damp cloth and dry thoroughly or clean with Mercedes-Benz approved Leather Care.

### Carpets

- ▶ Use Mercedes-Benz approved Carpet and Fabric Care for cleaning the carpets.

### Headliner and shelf below rear window

- ▶ Use a soft bristle brush or a dry-shampoo cleaner in case of excessive dirt.

### Seat belts

- ▶ Only use clear, lukewarm water and soap.

- ❗ The seat belts must not be treated with chemical cleaning agents. Do not dry the seat belts at temperatures above 176°F (80°C) or in direct sunlight.

#### Warning!

Do not bleach or dye seat belts as this may severely weaken them. In a crash they may not be able to provide adequate protection.

### Upholstery

Using aftermarket seat covers or wearing clothing that have the tendency to give off coloring (e.g. when wet, etc.) may cause the upholstery to become permanently discolored. By lining the seats with a proper intermediate cover, contact-discoloration will be prevented.

**Warning!**

Only use seat or head restraint covers which have been tested and approved by Mercedes-Benz for your vehicle model.

Using other seat or head restraint covers may interfere with or prevent

- deployment of the front side impact air bags
- deployment of the rear side impact air bags
- activation of the NECK-PRO active front head restraints

Contact an authorized Mercedes-Benz Center for availability.

**Leather upholstery**

Please note that leather upholstery is a natural product and is therefore subject to a natural aging process. Leather upholstery may also react to certain ambient influences such as high humidity or high temperature by showing wrinkles for example.

► Wipe leather upholstery with a damp cloth and dry thoroughly or clean with Mercedes-Benz approved Leather Care.

❗ To avoid damage to leather upholstery:

- Wipe with light pressure only.
- Do not clean with abrasive cleaning agents such as scouring milk or powder.
- Do not soak the leather upholstery.  
As leather is a natural product, it could otherwise harden or become porous.
- Exercise particular care when cleaning perforated leather as its underside should not become wet.

**Wood trims**

► Only use water and a damp cloth to clean wood trims in your vehicle.

❗ Do not use solvents like tar remover or wheel cleaner nor polishes or waxes as these may be abrasive.

**Chrome-plated exhaust tip**

Regular cleaning and care of chrome-plated exhaust tips will help to maintain their shine and the classy appearance.

► Use Mercedes-Benz approved Chrome Polishing Paste each time the vehicle has been washed, especially during the winter.

❗ Do not use alkaline cleaners such as wheel cleaners as they could cause corrosion.

# امداد خودرو فارما

تلفن شبانه روزی: ۰۲۱-۸۸۸۶۲۰۸۵

**FarmaSOS.com**

Vehicle equipment .....	450
Where will I find ...? .....	450
Vehicle status messages in the multifunction display .....	452
What to do if ... .....	489
Unlocking/locking manually .....	499
Resetting activated NECK-PRO active front head restraints .....	501
Replacing batteries (SmartKey, remote control, headphone) .....	502
Replacing bulbs .....	504
Replacing wiper blades .....	507
Flat tire .....	508
Battery .....	512
Jump starting .....	514
Towing the vehicle .....	516
Fuses .....	519

امداد خودرو فارما

تلفن شبانه روزی: ۰۲۱-۸۸۸۶۲۰۸۵

FarmaSOS.com



## Vehicle equipment

- i** This Operator's Manual describes all features, standard or optional, potentially available for your vehicle at the time of purchase. Please be aware that your vehicle might not be equipped with all features described in this manual.

## Where will I find ...?

### First aid kit

- i** Check expiration dates and contents for completeness at least once a year and replace missing/expired items.

The first aid kit is located in the trunk on the right side storage pocket, secured by a tensioning strap.

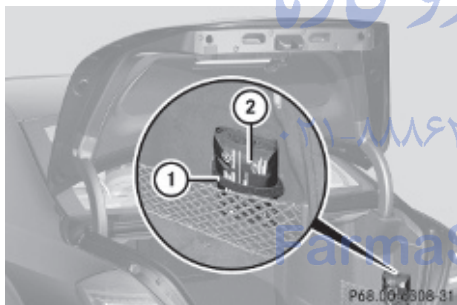

- Loosen tensioning strap ①.  
First aid kit ② can be removed.

### Vehicle tool kit

The vehicle tool kit is located in the space underneath the trunk floor.

- i** Vehicles without spare wheel are not factory-equipped with the tools required for a wheel change such as a jack or a wheel wrench. Some tools required for a wheel change are specific to your vehicle. Contact an authorized Mercedes-Benz

Center to obtain the tools approved for your vehicle.

The vehicle tool kit includes:

- Alignment bolt<sup>44</sup>
- Collapsible wheel chock<sup>44</sup>
- Fuse chart
- Jack<sup>44</sup>
- Pair of gloves<sup>44</sup>
- Towing eye bolt
- Wheel wrench<sup>44</sup>

- **Removing:** Open the trunk (> page 279).  
► Lift the trunk floor using the floor handle.  
► Engage the floor handle on the upper trunk lip.

- !** To prevent damage, always disengage the floor handle from the upper trunk lip and lower the trunk floor before closing the trunk.

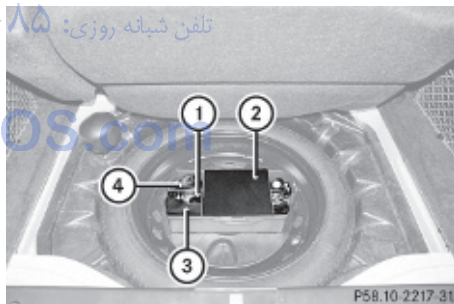

- ① Collapsible wheel chock
- ② Vehicle tool kit box cover
- ③ Tool bag
- ④ Jack

- Open vehicle tool kit box cover ②.

### Collapsible wheel chock

The collapsible wheel chock serves to secure the vehicle, e.g. while changing a wheel.

<sup>44</sup> Vehicles with spare wheel only.

- ▶ Take the collapsible wheel chock from the vehicle tool kit (▷ page 450).

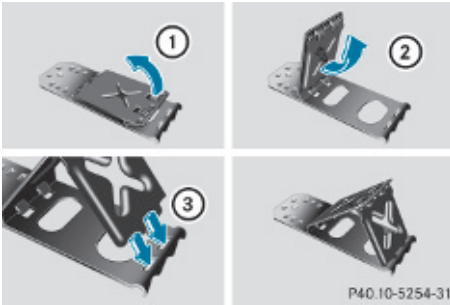

- ▶ **Setting up:** Tilt both plates upward ①.
- ▶ Fold the lower plate outward ②.
- ▶ Guide the tabs of the lower plate all the way into the openings of base plate ③.

For information on where to place wheel chocks when changing a wheel, see “Lifting the vehicle” (▷ page 509).

## Jack

### **Warning!**

Only use the jack supplied with your vehicle to lift the vehicle briefly for wheel changes. If you use the jack for any other purpose, you or others could be injured, as the jack is designed only for the purpose of changing a wheel.

When using the jack, observe the safety notes in the “Mounting the spare wheel” section and the notes on the jack.

- ▶ Take the jack from the vehicle tool kit (▷ page 450).

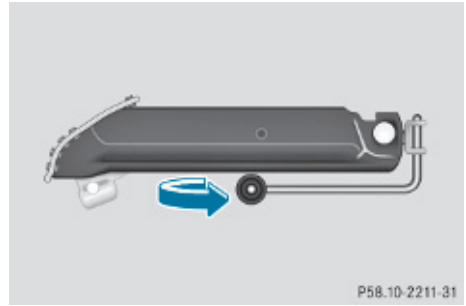

Storage position

- ▶ Turn the crank handle in the direction of arrow as far as it will go.



Operational position

- ▶ Turn the crank handle clockwise.
- Before placing the jack back into the vehicle tool kit:
- ▶ Fully collapse the jack.
  - ▶ Fold in the crank handle (storage position).

## Spare wheel

### **Observe Safety notes, see page 508.**

The spare wheel is located in the space underneath the trunk floor.

- ▶ **Removing:** Open the trunk (▷ page 279).
- ▶ Lift the trunk floor using the floor handle.
- ▶ Engage the trunk floor handle on the upper trunk lip.

- ▶ **!** To prevent damage, always disengage the floor handle from the upper trunk lip and

lower the trunk floor before closing the trunk.

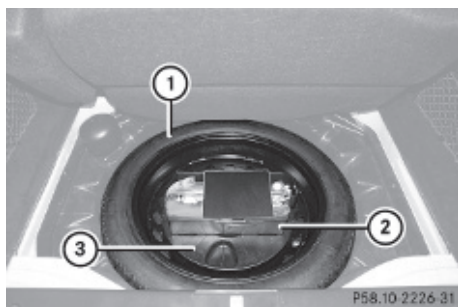

- ▶ Remove spare wheel mounting ③ by turning it counterclockwise.

❗ Vehicle tool kit box ② can only be removed together with spare wheel mounting ③. After removing spare wheel mounting ③, you can disengage vehicle tool kit box ② from spare wheel mounting ③.

- ▶ Remove spare wheel ①.

The spare wheel bolts are located in a container on the spare wheel rim.

- ▶ Take off the spare wheel bolts. For information on mounting the spare wheel, see “Flat tire” (▷ page 508).

### Storing the spare wheel after use

- ▶ Place spare wheel ① into the spare wheel well (▷ page 452).
- ▶ Secure spare wheel ① by turning spare wheel mounting ③ clockwise (▷ page 452).

## Vehicle status messages in the multifunction display

### Notes

Warning and malfunction messages appear in the multifunction display located in the instrument cluster.

Certain warning and malfunction messages are accompanied by an audible signal.

Address these messages accordingly and follow the additional instructions given in this Operator’s Manual.

High-priority messages are shown in red in the multifunction display. Messages of lower priority are shown in yellow or white.

Certain messages of high priority cannot be cleared from the multifunction display using **OK** or **↩** on the multifunction steering wheel (▷ page 221).

Other messages of high priority and messages of less immediate priority can be cleared from the multifunction display using **OK** or **↩**. They are then stored in the vehicle status message memory (▷ page 233). Remember that clearing a message will only make the message disappear. Clearing a message will not correct the condition that caused the message to appear.

### ⚠ Warning!

All categories of messages contain important information which should be taken note of and, where a malfunction is indicated, addressed as soon as possible at an authorized Mercedes-Benz Center.

Failure to repair the condition noted may cause damage not covered by the Mercedes-Benz Limited Warranty, or result in property damage or personal injury.

### ⚠ Warning!

No messages will be displayed if either the instrument cluster or the multifunction display is inoperative.

As a result, you will not be able to see information about your driving conditions, such as

- speed
- outside temperature
- warning/indicator lamps



- malfunction/warning messages
- failure of any systems

Driving characteristics may be impaired.

If you must continue to drive, do so with added caution. Contact an authorized Mercedes-Benz Center as soon as possible.

 **Warning!**

HYBRID vehicles: It is imperative that you read the HYBRID Supplemental Operating Instructions included in your vehicle literature

portfolio. You may otherwise not receive all necessary safety information and warning for the operation of your vehicle.

Read and observe the notes on the HOLD function (▷ page 342) and parking (▷ page 314) when you park the vehicle.

On the pages that follow, you will find a compilation of the most important warning and malfunction messages that may appear.

For your convenience the messages are divided into text messages (▷ page 454) and symbol messages (▷ page 466).

امداد خودرو فارما



تلفن شبانه روزی: ۰۲۱-۸۸۸۶۲۰۸۵

FarmaSOS.com

## Text messages

## Safety systems

Display messages		Possible causes/consequences and ► Solutions
PRE-SAFE	Inoperative See Oper. Manual	The PRE-SAFE® system has failed. All other occupant safety systems, such as the air bags, are still available. ► Contact an authorized Mercedes-Benz Center as soon as possible.
PRE-SAFE	Function Currently Limited See Oper. Manual	The PRE-SAFE® Brake is temporarily unavailable. The PRE-SAFE® Brake is deactivated because: <ul style="list-style-type: none"> <li>• the DISTRONIC PLUS cover in the radiator grille is dirty</li> <li>• the area around the sensors in the front or the rear bumper is dirty</li> <li>• its function is impaired as a result of heavy precipitation</li> <li>• the radar sensor system is temporarily inoperative due to electromagnetic interference near television and radio transmitter stations, toll stations, speed measuring systems, etc.</li> <li>• the system is out of the operating temperature range</li> <li>• the battery voltage is insufficient</li> </ul> The PRE-SAFE® Brake becomes operational again and the message in the multifunction display disappears when: <ul style="list-style-type: none"> <li>• dirt on the radiator grille has fallen off while driving (e.g. slush or snow)</li> <li>• the system recognizes full sensor availability (due to lessening rain or the road surface drying)</li> <li>• the system is within the operating temperature range</li> </ul> If the message in the multifunction display does not disappear: <ul style="list-style-type: none"> <li>► Clean the DISTRONIC PLUS cover in the radiator grille (&gt; page 443).</li> <li>► Clean the front and the rear bumper (&gt; page 443).</li> <li>► Restart the vehicle.</li> <li>► Wait until the battery recovers.</li> </ul>
PRE-SAFE	Function Limited See Oper. Manual	The PRE-SAFE® Brake is unavailable due to a malfunction. The BAS PLUS may also be unavailable. ► Contact an authorized Mercedes-Benz Center as soon as possible.

Display messages	Possible causes/consequences and ► Solutions
Front Passenger Airbag Enabled See Oper. Manual	<p>The front passenger front air bag is activated while driving even though a child, small individual, or object below the system's weight threshold is on the front passenger seat, or the front passenger seat is empty. Objects on the seat or forces acting on the seat may make the system sense supplemental weight.</p> <ul style="list-style-type: none"> <li>► Stop the vehicle in a safe location as soon as possible.</li> <li>► Engage the electronic parking brake.</li> <li>► Switch off the ignition.</li> <li>► Open the front passenger door.</li> <li>► Remove child and child restraint from front passenger seat and properly secure the child in rear seat employing the child restraint if necessary.</li> <li>► Make sure no objects which apply supplemental weight to the seat are present. The system may recognize such supplemental weight and sense that an occupant on the front passenger seat is of a greater weight than actually present.</li> <li>► Keep the seat unoccupied, close the front passenger door and switch on the ignition.</li> </ul> <p>Monitor the  <b>PASS AIR BAG OFF</b> indicator lamp right of the instrument cluster (► page 48) and the multifunction display in the instrument cluster (► page 32) for the following:</p> <p>With the seat unoccupied and the ignition switched on,</p> <ul style="list-style-type: none"> <li>• the message <b>Front Passenger Airbag Enabled See Oper. Manual</b> or the message <b>Front Passenger Airbag Disabled See Oper. Manual</b> should not appear in the multifunction display at any time the seat is unoccupied. Wait at least 60 seconds for the system to complete the necessary check cycles and to make sure neither message appears in the multifunction display.</li> </ul> <p>If above conditions are met, you can occupy the front passenger seat again. Depending on the front passenger classification sensed by the OCS, the  <b>PASS AIR BAG OFF</b> indicator lamp will remain illuminated or go out.</p> <p>If above conditions are not met, the system is not working properly. Have the system checked at an authorized Mercedes-Benz Center as soon as possible.</p>

 **Warning!**

If the  **PASS AIR BAG OFF** indicator lamp remains out even after performing the above corrective steps, do not have any children 12 years old and under and other small individuals use the front passenger seat until the system has been repaired.

**Display messages****Possible causes/consequences and ► Solutions**

Front Passenger Airbag Disabled See Oper. Manual

The front passenger front air bag is deactivated while driving even though an adult or someone larger than a small individual is occupying the front passenger seat. Forces acting on the seat may make the system sense a decrease in weight.

- Stop the vehicle in a safe location as soon as possible.
- Engage the electronic parking brake.
- Switch off the ignition.
- Have the front passenger vacate the seat and exit the vehicle.
- Keep the seat unoccupied, close the front passenger door and switch on the ignition.

Monitor the  **PASS AIR BAG OFF** indicator lamp right of the instrument cluster (► page 48) and the multifunction display in the instrument (► page 32) cluster for the following:

With the seat unoccupied and the ignition switched on,

- the  **PASS AIR BAG OFF** indicator lamp right of the instrument cluster should illuminate and remain illuminated, indicating that the OCS (► page 46) has deactivated the front passenger front air bag.
- the message Front Passenger Airbag Enabled See Oper. Manual or the message Front Passenger Airbag Disabled See Oper. Manual should not appear in the multifunction display at any time the seat is unoccupied. Wait at least 60 seconds for the system to complete the necessary check cycles and to make sure neither message appears in the multifunction display.

If above conditions are met, you can occupy the front passenger seat again. Depending on the front passenger classification sensed by the OCS, the  **PASS AIR BAG OFF** indicator lamp will remain illuminated or go out.

If above conditions are not met, the system is not working properly. Have the system checked at an authorized Mercedes-Benz Center as soon as possible.

 **Warning!**

If the  **PASS AIR BAG OFF** indicator lamp remains illuminated with an adult occupant on the front passenger seat even after performing the above corrective steps, do not have any passenger use the front passenger seat until the system has been repaired.

## Driving systems

Display messages		Possible causes/consequences and ► Solutions
ABC	Malfunction Stop Vehicle	<p>You have started driving although the vehicle level is still too low.</p> <p>The vehicle is being raised. The ABC message goes out after a few seconds.</p> <ul style="list-style-type: none"> <li>► Stop the vehicle in a safe location or as soon as it is safe to do so.</li> <li>► Wait until the message disappears from the multifunction display. You may then drive off.</li> </ul>
ABC	Malfunction Stop Vehicle	<p>The vehicle is losing oil.</p> <p>The ABC message appears continuously.</p> <ul style="list-style-type: none"> <li>► Stop the vehicle in a safe location or as soon as it is safe to do so.</li> <li>► Engage the electronic parking brake.</li> <li>► Call Roadside Assistance.</li> </ul> <p>or</p> <ul style="list-style-type: none"> <li>► Contact an authorized Mercedes-Benz Center.</li> </ul>
ABC	Malfunction Stop Vehicle	<p>The ABC is malfunctioning.</p> <p>The ABC message appears continuously.</p> <ul style="list-style-type: none"> <li>► Do not turn steering wheel too far to avoid damaging the front fenders.</li> <li>► Listen for scraping noises.</li> <li>► Do not drive faster than 50 mph (80 km/h).</li> <li>► Contact an authorized Mercedes-Benz Center as soon as possible.</li> </ul>
ABC	Malfunction	<p>The capability of the ABC system is restricted. This can impair handling.</p> <ul style="list-style-type: none"> <li>► Do not drive faster than 50 mph (80 km/h).</li> <li>► Contact an authorized Mercedes-Benz Center as soon as possible.</li> </ul>

Display messages		Possible causes/consequences and ► Solutions
ABC	Vehicle Rising Please Wait Briefly	The vehicle's level is too low while at a standstill. The vehicle will be raised. ► Do not drive off. ► Wait until the message disappears from the multifunction display. You may then drive off.
Cruise Control	Inoperativ e	The cruise control is malfunctioning. ► Have the cruise control checked at an authorized Mercedes-Benz Center.
Cruise Control	- - - mph	One of the activation conditions for cruise control has not been fulfilled. You may have attempted to set a speed below 20 mph (30 km/h). ► Drive faster than 20 mph (30 km/h) if the situation allows and set the speed. ► Check the activation conditions for cruise control (► page 328).

تلفن شبانه روزی: ۰۲۱-۸۸۸۶۲۰۸۵

FarmaSOS.com

Display messages		Possible causes/consequences and ► Solutions
DISTRONIC PLUS	Currently Unavailable See Oper. Manual	<p>The DISTRONIC PLUS is temporarily unavailable. The DISTRONIC PLUS is deactivated because:</p> <ul style="list-style-type: none"> <li>• the DISTRONIC PLUS cover in the radiator grille is dirty</li> <li>• its function is impaired as a result of heavy precipitation</li> <li>• the radar sensor system is temporarily inoperative due to electromagnetic interference near television and radio transmitter stations, toll stations, speed measuring systems, etc.</li> <li>• the radar sensors do not sense any other vehicles or objects, i.e. road sign or similar to this, for a long time</li> <li>• the system is out of the operating temperature range</li> <li>• the battery voltage is insufficient</li> </ul> <p>► If necessary, clean the DISTRONIC PLUS cover in the radiator grille (► page 443).</p> <p>► Restart the vehicle.</p> <p>► Try activating the DISTRONIC PLUS again later.</p> <p>► Wait until the system is within the operating temperature range or the battery recovers.</p> <p>The DISTRONIC PLUS becomes operational again without the engine being restarted when:</p> <ul style="list-style-type: none"> <li>• dirt on the radiator grille has fallen off while driving (e.g. slush or snow)</li> <li>• the system recognizes full sensor availability (due to lessening rain or the road surface drying)</li> <li>• the message in the multifunction display disappears</li> </ul>
DISTRONIC PLUS	Inoperative	<p>The DISTRONIC PLUS is malfunctioning. The BAS PLUS and the PRE-SAFE® Brake are also not available.</p> <p>► Contact an authorized Mercedes-Benz Center as soon as possible.</p>
DISTRONIC PLUS	Override	<p>You have accelerated. The DISTRONIC PLUS has switched off.</p> <p>► Stop accelerating.</p>



Display messages		Possible causes/consequences and ► Solutions
DISTRONIC PLUS	- - - mph	<p>One of the activation conditions for the DISTRONIC PLUS has not been fulfilled. You may have attempted to set a speed below 20 mph (30 km/h).</p> <ul style="list-style-type: none"> <li>► Drive faster than 20 mph (30 km/h) if the situation allows and set the speed.</li> <li>► Check the activation conditions for the DISTRONIC PLUS (► page 335).</li> </ul>
HOLD	Off	<p>The HOLD function switched off because the vehicle was sliding, for example on a slippery surface.</p> <ul style="list-style-type: none"> <li>► Activate the HOLD function later.</li> </ul>
Blind Spot Assist	Currently Unavailable See Oper. Manual	<p>The Blind Spot Assist is deactivated because the area around the sensors in the front or the rear bumper is dirty.</p> <ul style="list-style-type: none"> <li>► Clean the front and rear bumper (► page 443).</li> </ul> <p>The Blind Spot Assist is deactivated because the battery voltage is insufficient.</p> <ul style="list-style-type: none"> <li>► Have the battery checked at an authorized Mercedes-Benz Center.</li> </ul> <p>The Blind Spot Assist is switched off because the radar sensor system is temporarily inoperative due to electromagnetic interference near television and radio transmitter stations, toll stations, speed measuring systems, etc.</p> <ul style="list-style-type: none"> <li>► Wait until the message in the multifunction display disappears.</li> </ul>
Blind Spot Assist	Inoperative	<p>The Blind Spot Assist is malfunctioning.</p> <ul style="list-style-type: none"> <li>► Contact an authorized Mercedes-Benz Center as soon as possible.</li> </ul>

Display messages		Possible causes/consequences and ► Solutions
Parking Guidance	Currently Unavailable See Oper. Manual	<p>The Advanced Parking Guidance is deactivated because the area around the sensors in the front or the rear bumper is dirty.</p> <p>► Clean the front and rear bumper (▷ page 443).</p> <p>The Advanced Parking Guidance is deactivated because the battery voltage is insufficient.</p> <p>► Have the battery checked at an authorized Mercedes-Benz Center.</p> <p>The Advanced Parking Guidance is switched off because the radar sensor system is temporarily inoperative due to electromagnetic interference near television and radio transmitter stations, toll stations, speed measuring systems, etc.</p> <p>► Wait to see if the interference is temporary. Try in a location where the interfering source might not be present.</p>
Parking Guidance	Canceled	<p>The Advanced Parking Guidance has been canceled because:</p> <ul style="list-style-type: none"> <li>• the vehicle is sliding</li> <li>• the bumper became dirty in the area of the sensors</li> <li>• there has been a malfunction تلف</li> </ul> <p>► Use the Advanced Parking Guidance again later.</p> <p>If the parking space symbol is not shown in the multifunction display at a speed below 10 mph (16 km/h):</p> <p>► Clean the bumpers (▷ page 443).</p> <p>or</p> <p>► Restart the engine.</p> <p>or</p> <p>► Contact an authorized Mercedes-Benz Center.</p>
Parking Guidance	Finished	<p>Advanced Parking Guidance: The vehicle is in the end position.</p> <p>The display message disappears automatically.</p>
Radar Sensors	Deactivated See Oper. Manual	<p>You have attempted to activate the DISTRONIC PLUS or the PRE-SAFE® Brake even though you have switched off the radar sensors on the vehicle.</p> <p>► Check if switching on the radar sensors is permitted (▷ page 236).</p> <p>► Switch on the radar sensors using the instrument cluster control system.</p>

Display messages		Possible causes/consequences and ► Solutions
Lane Keeping Assist	Currently Unavailable See Oper. Manual	<p>The Lane Keeping Assist is temporarily unavailable. The Lane Keeping Assist is deactivated because:</p> <ul style="list-style-type: none"> <li>• the windshield in front of the camera is dirty</li> <li>• its function is impaired as a result of heavy precipitation or fog</li> <li>• lane markings are not present for an extended period of time</li> <li>• lane markings are worn, dark, or covered by dirt or snow for example</li> </ul> <p>The Lane Keeping Assist becomes operational again and the message in the multifunction display disappears when:</p> <ul style="list-style-type: none"> <li>• dirt on the windshield has fallen off while driving (e.g. slush or snow)</li> <li>• the system recognizes full camera availability</li> </ul> <p>► If necessary, clean the windshield in front of the camera (► page 445).</p>
Lane Keeping Assist	Inoperative	<p>The Lane Keeping Assist is malfunctioning.</p> <p>► Contact an authorized Mercedes-Benz Center.</p>

## Vehicle

Display messages		Possible causes/consequences and ► Solutions
Apply Brake	to Shift from 'P'	<p>You have attempted to shift the automatic transmission into drive position <b>D</b>, reverse gear <b>R</b> or neutral position <b>N</b> without depressing the brake pedal.</p> <p>► Depress the brake pedal.</p>
Door Open	Vehicle Not in Park	<p>You have opened the driver's door and the automatic transmission is still in drive position <b>D</b>, reverse gear <b>R</b> or neutral position <b>N</b>.</p> <p>► Before you leave the vehicle, make sure the automatic transmission is in park position <b>P</b> and the electronic parking brake is engaged.</p>

Display messages		Possible causes/consequences and ► Solutions
Service Required	Do Not Shift Gears	<p>The automatic transmission cannot be shifted out of the current transmission position because of a malfunction.</p> <p>If the automatic transmission is in drive position <b>D</b>:</p> <ul style="list-style-type: none"> <li>► Without shifting the automatic transmission out of drive position <b>D</b>, drive to an authorized Mercedes-Benz Center.</li> </ul> <p>If the automatic transmission is set to neutral position <b>N</b>, reverse gear <b>R</b> or park position <b>P</b>:</p> <ul style="list-style-type: none"> <li>► Do not drive.</li> <li>► Contact an authorized Mercedes-Benz Center or call Roadside Assistance.</li> </ul>
Only Shift to Position 'P' When Vehicle Is Stationary		<p>You have attempted to shift the automatic transmission into park position <b>P</b> although the vehicle was still in motion.</p> <ul style="list-style-type: none"> <li>► Stop your vehicle as soon as it is safe to do so.</li> <li>► Shift the automatic transmission to park position <b>P</b>.</li> <li>► Engage the electronic parking brake.</li> </ul>
Shift to P or N	to Start Engine	<p>You have attempted to start the engine while the automatic transmission was in reverse gear <b>R</b> or drive position <b>D</b>.</p> <ul style="list-style-type: none"> <li>► Shift the automatic transmission into park position <b>P</b> or neutral position <b>N</b>. Make sure the brake pedal is depressed.</li> </ul>
Auxiliary Battery (message appears in white)	Malfunction	<p>The backup battery for the automatic transmission is no longer charging.</p> <ul style="list-style-type: none"> <li>► Contact an authorized Mercedes-Benz Center.</li> </ul>
Auxiliary Battery (message appears in red)	Malfunction	<p>The backup battery for the automatic transmission is discharged. In case of failure of the on-board electrical system, you may not be able change transmission positions.</p> <ul style="list-style-type: none"> <li>► Stop the vehicle in a safe location or as soon as it is safe to do so.</li> <li>► Engage the electronic parking brake.</li> <li>► Do <b>not</b> drive any further.</li> <li>► Contact an authorized Mercedes-Benz Center or call Roadside Assistance.</li> </ul>

Display messages		Possible causes/consequences and ► Solutions
Next Service X	in ... days in ... mls (km)	The specified maintenance service must be carried out within the remaining time range or driving distance (▷ page 439). ► Have the maintenance service carried out at an authorized Mercedes-Benz Center.
Service X	Due	The specified maintenance service must be carried out (▷ page 439). ► Have the maintenance service carried out at an authorized Mercedes-Benz Center as soon as possible.
Service X Exceeded	by X days by XXX mls (km)	The specified maintenance service term has been exceeded (▷ page 439). ► Have the maintenance service carried out at an authorized Mercedes-Benz Center as soon as possible.

**!** Failure to have the vehicle maintained in accordance with the Maintenance Booklet and maintenance service indicator at the designated times/mileage will result in vehicle damage not covered by the Mercedes-Benz Limited Warranty.

## Tires

Display messages		Possible causes/consequences and ► Solutions
Tire Pressures	Displayed After Driving A Few Minutes	The tire inflation pressure is being checked by the Advanced TPMS. ► Drive the vehicle for a few minutes.
Tire Pressure Monitor	Inoperative	The Advanced TPMS is malfunctioning. ► Have the Advanced TPMS checked at an authorized Mercedes-Benz Center.
Tire Pressure Monitor	Inoperative No Wheel Sensors	There are wheels without appropriate wheel sensors mounted (e.g. winter tires). ► Have the appropriate wheel sensors installed at an authorized Mercedes-Benz Center.

Display messages		Possible causes/consequences and ► Solutions
Wheel Sensor(s)	Missing	<p>At least one sensor is defect (e.g. battery is empty). The respective tire is indicated by - - instead of the tire inflation pressure in the multifunction display.</p> <ul style="list-style-type: none"> <li>► Have the Advanced TPMS checked at an authorized Mercedes-Benz Center.</li> <li>► Have the wheel sensors installed at an authorized Mercedes-Benz Center.</li> </ul> <p>At least one wheel without appropriate wheel sensors is mounted (e.g. spare wheel). The respective tire is indicated by - - instead of the tire inflation pressure in the multifunction display.</p> <ul style="list-style-type: none"> <li>► Have the Advanced TPMS checked at an authorized Mercedes-Benz Center.</li> <li>► Have the wheel sensors installed at an authorized Mercedes-Benz Center.</li> </ul>
Tire Pressure Monitor	Currently Unavailable	<p>The Advanced TPMS cannot monitor the tire inflation pressure due to a nearby radio interference source or insufficient power supply.</p> <p>As soon as the causes of the malfunction have been rectified, the Advanced TPMS becomes active again automatically after a few minutes of driving.</p>
Tire Pressure Please Rectify		<p>The tire inflation pressure is too low in at least one tire. or The tire inflation pressures of the individual tires differ from each other significantly.</p> <p>The tire inflation pressure values are shown in the multifunction display.</p> <ul style="list-style-type: none"> <li>► Check and correct tire inflation pressure as required (▷ page 413).</li> <li>► Restart the Advanced TPMS (▷ page 416).</li> </ul>
Caution Tire Defect		<p>At least one tire is deflating. The respective tire is indicated in the multifunction display.</p> <ul style="list-style-type: none"> <li>► Carefully bring the vehicle to a halt, avoiding abrupt steering and braking maneuvers.</li> <li>► If necessary, change the wheel (▷ page 508).</li> </ul>

Display messages	Possible causes/consequences and ► Solutions
Check Tires	<p>The tire inflation pressure in at least one tire is significantly below the reference value.</p> <p>The respective tire is indicated in the multifunction display.</p> <ul style="list-style-type: none"> <li>► Carefully bring the vehicle to a halt, avoiding abrupt steering and braking maneuvers.</li> <li>► Check and adjust tire inflation pressure as required.</li> <li>► If necessary, change the wheel (► page 508).</li> </ul>

 **Warning!**

Do not drive with a flat tire. A flat tire affects the ability to steer or brake the vehicle. You may lose control of the vehicle. Continued driving with a flat tire will cause excessive heat build-up and possibly a fire.

 **Warning!**

Follow recommended tire inflation pressures.

Do not underinflate tires. Underinflated tires wear excessively and/or unevenly, adversely affect handling and fuel economy, and are more likely to fail from being overheated.

Do not overinflate tires. Overinflated tires can adversely affect handling and ride comfort, wear unevenly, increase stopping distance, and result in sudden deflation (blowout) because they are more likely to become punctured or damaged by road debris, potholes etc.

تلفن شبانه روزی: +۸۵-۸۸۷۳۰۱۱

### Symbol messages









#### Brake









FarmaSOS.com

Display messages	Possible causes/consequences and ► Solutions
 <p>Check Brake Pad Wear</p>	<p>The brake pads have reached their wear limit.</p> <ul style="list-style-type: none"> <li>► Have the brake pads replaced as soon as possible at an authorized Mercedes-Benz Center.</li> </ul>

**!** Brake pad thickness must be visually inspected by a qualified technician at the intervals specified in the Maintenance Booklet.





Display messages	Possible causes/consequences and ► Solutions	
<p><b>BRAKE</b> (USA only)</p>  <p>(Canada only)</p>	<p>ABS and ESC Inoperative. See Oper. Manual</p>	<p>In addition, the yellow ESC warning lamp , the yellow ESC OFF warning lamp , and the yellow ABS indicator lamp  come on.</p> <p>The brake system is still functioning normally but due to a malfunction, the ABS, the BAS, the BAS PLUS, the ESC, the hill-start assist system, the HOLD function, the Adaptive Brake Lights, the PRE-SAFE® system, and the PRE-SAFE® Brake are unavailable.</p> <p>The ATTENTION ASSIST is disabled.</p> <ul style="list-style-type: none"> <li>► Continue driving with added caution. Wheels may lock during hard braking, reducing steering capability.</li> <li>► Adjust driving to be consistent with reduced braking responsiveness.</li> <li>► Have the system checked at an authorized Mercedes-Benz Center as soon as possible.</li> </ul> <p>Failure to follow these instructions increases the risk of an accident.</p>
<p><b>BRAKE</b> (USA only)</p>  <p>(Canada only)</p>	<p>ABS and ESC Currently Unavailable. See Oper. Manual</p>	<p>In addition, the yellow ESC warning lamp , the yellow ESC OFF warning lamp , and the yellow ABS indicator lamp  come on.</p> <p>The brake system is still functioning normally but temporarily the ABS, the BAS, the BAS PLUS, the ESC, the hill-start assist system, the HOLD function, the Adaptive Brake Lights, the PRE-SAFE® system, and the PRE-SAFE® Brake are unavailable.</p> <p>The self-diagnosis may not be completed yet.</p> <p>The ATTENTION ASSIST is disabled.</p> <ul style="list-style-type: none"> <li>► Drive a short distance with added caution at a vehicle speed of above 12 mph (20 km/h). When the message disappears, the ESC is available again.</li> </ul> <p>If the message does not disappear:</p> <ul style="list-style-type: none"> <li>► Continue driving with added caution. Wheels may lock during hard braking, reducing steering capability.</li> <li>► Adjust driving to be consistent with reduced braking responsiveness.</li> <li>► Have the system checked at an authorized Mercedes-Benz Center as soon as possible.</li> </ul> <p>Failure to follow these instructions increases the risk of an accident.</p>

Display messages	Possible causes/consequences and	► Solutions
<p><b>BRAKE</b> (USA only)</p> <p> (Canada only)</p>	<p>ABS and ESC Currently Unavailable See Oper. Manual</p>	<p>In addition, the yellow ESC warning lamp , the yellow ESC OFF warning lamp , and the yellow ABS indicator lamp  come on.</p> <p>The brake system still functions normally but due to insufficient power supply, the ABS, the BAS, the BAS PLUS, the ESC, the hill-start assist system, the HOLD function, the Adaptive Brake Lights, the PRE-SAFE® system, and the PRE-SAFE® Brake are unavailable.</p> <p>The ATTENTION ASSIST is disabled.</p> <ul style="list-style-type: none"> <li>► Continue driving with added caution. Wheels may lock during hard braking, reducing steering capability.</li> <li>► Adjust driving to be consistent with reduced braking responsiveness.</li> </ul> <p>When the voltage is above the required value again, the ABS, the BAS, the BAS PLUS, the ESC, the hill-start assist system, the HOLD function, the Adaptive Brake Lights, the PRE-SAFE® system, and the PRE-SAFE® Brake are operational again and the message should disappear.</p> <p>If the message does not disappear:</p> <ul style="list-style-type: none"> <li>► Have the alternator and the battery checked.</li> </ul> <p>Failure to follow these instructions increases the risk of an accident.</p>
<p><b>BRAKE</b> (USA only)</p> <p> (Canada only)</p>	<p>EBR, ABS, and ESC Inoperative See Oper. Manual</p>	<p>In addition, the yellow ESC warning lamp , the yellow ESC OFF warning lamp , and the yellow ABS indicator lamp  come on and an acoustic warning sounds.</p> <p>The brake system is still functioning normally but due to a malfunction, the ABS, the BAS, the BAS PLUS, the EBP, the ESC, the HOLD function, the Adaptive Brake Lights, the PRE-SAFE® system, and the PRE-SAFE® Brake are unavailable.</p> <p>The ATTENTION ASSIST is disabled.</p> <ul style="list-style-type: none"> <li>► Continue driving with added caution. Wheels may lock during hard braking, reducing steering capability.</li> <li>► Adjust driving to be consistent with reduced braking responsiveness.</li> <li>► Have the system checked at an authorized Mercedes-Benz Center as soon as possible.</li> </ul> <p>Failure to follow these instructions increases the risk of an accident.</p>

Display messages	Possible causes/consequences and ► Solutions	
<p><b>PARK</b> (USA only)</p> <p><b>(P)</b> (Canada only)</p>	<p>Please Release Parking Brake</p>	<p>In addition, the red indicator lamp for the electronic parking brake flashes and an acoustic warning sounds.</p> <p>You are driving with the electronic parking brake engaged, or you are carrying out an emergency brake maneuver with the electronic parking brake (&gt; page 315).</p> <ul style="list-style-type: none"> <li>► Release electronic parking brake.</li> <li>or</li> <li>► Drive off carefully.</li> <li>or</li> <li>► Release the handle for electronic parking brake.</li> </ul>
<p><b>PARK</b> (USA only)</p> <p><b>(P)</b> (Canada only)</p>	<p>Please Release Parking Brake</p>	<p>In addition, the red indicator lamp for the electronic parking brake flashes, the yellow warning lamp for the electronic parking brake comes on and an acoustic warning sounds.</p> <p>The electronic parking brake is malfunctioning. The braking effect is reduced.</p> <p>While driving:</p> <ul style="list-style-type: none"> <li>► Release the handle for electronic parking brake.</li> </ul> <p>While at a standstill:</p> <ul style="list-style-type: none"> <li>► Switch off the ignition.</li> <li>► Press handle for electronic parking brake until the warning message disappears from the multifunction display.</li> </ul> <p>If the warning message does not disappear:</p> <ul style="list-style-type: none"> <li>► Shift the automatic transmission to park position <b>P</b> (&gt; page 317).</li> <li>► Protect vehicle from rolling away while parked by using the collapsible wheel chock from the vehicle tool kit (&gt; page 450).</li> <li>► Contact an authorized Mercedes-Benz Center as soon as possible.</li> </ul>
<p><b>PARK</b> (USA only)</p> <p><b>(P)</b> (Canada only)</p>	<p>Turn On the Ignition to Release the Parking Brake</p>	<p>In addition, the red indicator lamp for the electronic parking brake comes on.</p> <p>You have tried to release the electronic parking brake, but the ignition was not switched on.</p> <ul style="list-style-type: none"> <li>► Switch on the ignition.</li> </ul>

Display messages	Possible causes/consequences and ► Solutions	
<div data-bbox="90 177 169 213" style="border: 1px solid black; padding: 2px; display: inline-block;"><b>PARK</b></div> (USA only) <div data-bbox="90 252 169 288" style="border: 1px solid black; padding: 2px; display: inline-block;"><b>(P)</b></div> (Canada only)	Parking Brake See Oper. Manual	<p>In addition, the yellow warning lamp for the electronic parking brake comes on. The red indicator lamp for the electronic parking brake may also come on.</p> <p>The electronic parking brake is malfunctioning.</p> <p>To release:</p> <ul style="list-style-type: none"> <li>► Pull handle of electronic parking brake.</li> </ul> <p>or</p> <ul style="list-style-type: none"> <li>► Drive off carefully.</li> <li>► Contact an authorized Mercedes-Benz Center as soon as possible.</li> </ul> <p>To engage:</p> <ul style="list-style-type: none"> <li>► Switch off the ignition.</li> <li>► Press handle for electronic parking brake for at least 10 seconds until the warning message in the multifunction display disappears.</li> </ul> <p>If the warning message does not disappear:</p> <ul style="list-style-type: none"> <li>► Shift the automatic transmission to park position <b>P</b> (► page 317).</li> <li>► Protect vehicle from rolling away while parked by using the collapsible wheel chock from the vehicle tool kit (► page 450).</li> <li>► Contact an authorized Mercedes-Benz Center as soon as possible.</li> </ul>
<div data-bbox="90 959 169 995" style="border: 1px solid black; padding: 2px; display: inline-block;"><b>PARK</b></div> (USA only) <div data-bbox="90 1034 169 1070" style="border: 1px solid black; padding: 2px; display: inline-block;"><b>(P)</b></div> (Canada only)	Parking Brake See Oper. Manual	<p>In addition, the red indicator lamp for the electronic parking brake flashes.</p> <p>The power supply for the electronic parking brake was interrupted.</p> <ul style="list-style-type: none"> <li>► Pull handle of electronic parking brake.</li> </ul> <p>or</p> <ul style="list-style-type: none"> <li>► Drive off carefully.</li> </ul> <p>or</p> <ul style="list-style-type: none"> <li>► Press handle for electronic parking brake until the warning message in the multifunction display disappears.</li> </ul>

Display messages	Possible causes/consequences and ► Solutions
<p><b>PARK</b> (USA only)</p> <p><b>(P)</b> (Canada only)</p>	<p>Parking Brake See Oper. Manual</p> <p>In addition, the red indicator lamp for the electronic parking brake flashes and the yellow warning lamp for the electronic parking brake comes on.</p> <p>The electronic parking brake is malfunctioning.</p> <ul style="list-style-type: none"> <li>► Switch ignition off and back on again, and engage or release electronic parking brake.</li> </ul> <p>or</p> <ul style="list-style-type: none"> <li>► Drive off carefully.</li> <li>► Contact an authorized Mercedes-Benz Center as soon as possible.</li> </ul>
<p><b>PARK</b> (USA only)</p> <p><b>(P)</b> (Canada only)</p>	<p>Parking Brake See Oper. Manual</p> <p>When you engage or release the electronic parking brake, the red indicator lamp for the electronic parking brake flashes for approximately 10 seconds. Afterward, it goes out or comes on continuously. The yellow warning lamp for the electronic parking brake comes on.</p> <p>The electronic parking brake is malfunctioning or overheated for example due to overvoltage or undervoltage.</p> <ul style="list-style-type: none"> <li>► Drive off carefully.</li> <li>► Contact an authorized Mercedes-Benz Center as soon as possible.</li> </ul> <p>In the event of overvoltage or undervoltage:</p> <ul style="list-style-type: none"> <li>► Remove the cause of the overvoltage or undervoltage, e.g. charge the battery or restart the engine.</li> <li>► Switch ignition off and back on again, and engage or release electronic parking brake.</li> </ul> <p>If the electronic parking brake still cannot be released:</p> <ul style="list-style-type: none"> <li>► Contact an authorized Mercedes-Benz Center as soon as possible.</li> </ul> <p>If overheated:</p> <ul style="list-style-type: none"> <li>► Let vehicle cool down, and do not engage electronic parking brake during this time.</li> </ul> <p>or</p> <ul style="list-style-type: none"> <li>► Switch ignition off and back on again, and engage or release electronic parking brake.</li> </ul>

Display messages		Possible causes/consequences and ► Solutions
<div data-bbox="90 177 169 213"><b>PARK</b></div> <div data-bbox="87 221 194 248">(USA only)</div> <div data-bbox="90 253 169 290"></div> <div data-bbox="87 298 172 352">(Canada only)</div>	Parking Brake Inoperative	<p>When you engage or release the electronic parking brake, the red indicator lamp for the electronic parking brake flashes and goes out after approx. 10 seconds. The yellow warning lamp for the electronic parking brake comes on.</p> <p>The electronic parking brake is malfunctioning.</p> <ul style="list-style-type: none"> <li>► Switch ignition off and back on again, and engage or release electronic parking brake.</li> </ul> <p>If the electronic parking brake cannot be engaged:</p> <ul style="list-style-type: none"> <li>► Shift the automatic transmission to park position <b>P</b> (► page 317).</li> <li>► Protect vehicle from rolling away while parked by using a chock from the vehicle tool kit (► page 450).</li> <li>► Contact an authorized Mercedes-Benz Center as soon as possible.</li> </ul>
<div data-bbox="90 651 169 687"><b>BRAKE</b></div> <div data-bbox="87 695 194 722">(USA only)</div> <div data-bbox="90 727 169 764"></div> <div data-bbox="87 772 172 826">(Canada only)</div>	Service See Oper. Manual	<p>S 600 and S 65 AMG only:</p> <p>The brake system sensors are malfunctioning. The brake system continues to function normally with full brake force boost.</p> <ul style="list-style-type: none"> <li>► Continue driving with added caution.</li> <li>► Have the system checked at an authorized Mercedes-Benz Center as soon as possible.</li> </ul>
<div data-bbox="90 898 169 935"><b>BRAKE</b></div> <div data-bbox="87 943 194 970">(USA only)</div> <div data-bbox="90 975 169 1011"></div> <div data-bbox="87 1019 172 1074">(Canada only)</div>	Check Brake Fluid Level	<p>There is insufficient brake fluid in the reservoir.</p> <p>Risk of accident!</p> <ul style="list-style-type: none"> <li>► Stop the vehicle in a safe location or as soon as it is safe to do so.</li> <li>► Engage the parking brake.</li> <li>► Do <b>not</b> drive any further.</li> <li>► Contact an authorized Mercedes-Benz Center or call Roadside Assistance.</li> </ul> <p>Do not add brake fluid! This will not solve the problem.</p>







### **Warning!**

Driving with the message Check Brake Fluid Level displayed can result in an accident. Have your brake system checked immediately.









Do not add brake fluid before checking the brake system. Overfilling the brake fluid reservoir can result in spilling brake fluid on hot engine parts and the brake fluid catching fire. You can be seriously burned.





**!** If you find that the brake fluid in the brake fluid reservoir has fallen to the minimum mark or below, have the brake system checked for brake pad thickness and leaks.

Safety systems

Display messages	Possible causes/consequences and ► Solutions
 <p>Inoperative See Oper. Manual</p>	<p>In addition, the yellow ESC warning lamp  and the yellow ESC OFF warning lamp  come on.</p> <p>The brake system is still functioning normally but due to a malfunction, the BAS, the BAS PLUS, the ESC, the hill-start assist system, the HOLD function, the Adaptive Brake Lights, the PRE-SAFE® system, and the PRE-SAFE® Brake are unavailable.</p> <p>The ATTENTION ASSIST is disabled.</p> <ul style="list-style-type: none"> <li>► Continue driving with added caution. Wheels may lock during hard braking, reducing steering capability.</li> <li>► Adjust driving to be consistent with reduced braking responsiveness.</li> <li>► Have the system checked at an authorized Mercedes-Benz Center as soon as possible.</li> </ul> <p>Failure to follow these instructions increases the risk of an accident.</p>
 <p>Currently Unavailable See Oper. Manual</p>	<p>In addition, the yellow ESC warning lamp  and the yellow ESC OFF warning lamp  come on.</p> <p>The brake system is still functioning normally but without the BAS, the BAS PLUS, the ESC, the hill-start assist system, the HOLD function, the Adaptive Brake Lights, the PRE-SAFE® system, and the PRE-SAFE® Brake available.</p> <p>The ATTENTION ASSIST is disabled.</p> <ul style="list-style-type: none"> <li>► Drive a short distance with added caution at a vehicle speed of above 12 mph (20 km/h). When the message disappears, the ESC is available again.</li> </ul> <p>If the message does not disappear:</p> <ul style="list-style-type: none"> <li>► Continue driving with added caution. Wheels may lock during hard braking, reducing steering capability.</li> <li>► Adjust driving to be consistent with reduced braking responsiveness.</li> <li>► Have the system checked at an authorized Mercedes-Benz Center as soon as possible.</li> </ul> <p>Failure to follow these instructions increases the risk of an accident.</p>



Display messages	Possible causes/consequences and ► Solutions	
	<p>Currently Unavailable See Oper. Manual</p>	<p>If the yellow ESC warning lamp  flashes while driving and this message appears, the Electronic Traction System (ETS/4-ETS) has switched off to prevent overheating of the drive wheel brakes.</p> <p>The BAS PLUS and the PRE-SAFE® Brake are also not available.</p> <p>As soon as the brakes have cooled off, the Electronic Traction System (ETS/4-ETS) switches on again.</p> <p>The message in the multifunction display disappears and the ESC warning lamp  goes out.</p>
	<p>Tele Aid Inoperative</p>	<p>One or more main functions of the Tele Aid system are malfunctioning.</p> <p>► Have the Tele Aid system checked at an authorized Mercedes-Benz Center.</p>
	<p>SRS Malfunction Service Required</p>	<p>There is a malfunction in the Supplemental Restraint System (SRS). The air bags or Emergency Tensioning Devices (ETDs) could deploy unexpectedly or fail to activate in an accident.</p> <p>► Drive with added caution to the nearest authorized Mercedes-Benz Center.</p>
	<p>Front Left SRS Malfunction Service Required</p>	<p>Components of the driver's supplemental restraint system may not work properly.</p> <p>► Drive with added caution to the nearest authorized Mercedes-Benz Center.</p>
	<p>Front Right SRS Malfunction Service Required</p>	<p>Components of the front passenger's supplemental restraint system may not work properly.</p> <p>► Drive with added caution to the nearest authorized Mercedes-Benz Center.</p>
	<p>Rear Left SRS Malfunction Service Required</p>	<p>Components of the left rear passenger's supplemental restraint system may not work properly.</p> <p>► Drive with added caution to the nearest authorized Mercedes-Benz Center.</p>

Display messages		Possible causes/consequences and ► Solutions
	Rear Center SRS Malfunction Service Required	Components of the center rear passenger's supplemental restraint system may not work properly. ► Drive with added caution to the nearest authorized Mercedes-Benz Center.
	Rear Right SRS Malfunction Service Required	Components of the right rear passenger's supplemental restraint system may not work properly. ► Drive with added caution to the nearest authorized Mercedes-Benz Center.
	Left Side Curtain Airbag Malfunction Service Required	The left window curtain air bag may not work properly. ► Drive with added caution to the nearest authorized Mercedes-Benz Center.
	Right Side Curtain Airbag Malfunction Service Required	The right window curtain air bag may not work properly. ► Drive with added caution to the nearest authorized Mercedes-Benz Center.







 **Warning!**











In the event a malfunction of the SRS is indicated as outlined above, the SRS may not be operational.

For your safety, we strongly recommend that you contact an authorized Mercedes-Benz









Center immediately to have the system checked. Otherwise the SRS may not be activated when needed in an accident, which could result in serious or fatal injury, or it might deploy unexpectedly and unnecessarily which could also result in injury.







## Driving systems



Display messages	Possible causes/consequences and ► Solutions
 <p>Vehicle Rising Please Wait Briefly</p>	<p>Vehicles with AIRMATIC: The vehicle level is too low.</p> <ul style="list-style-type: none"> <li>► Wait until the message disappears from the multifunction display.</li> </ul>
 <p>STOP Car Too Low</p>	<p>You have started driving although the vehicle level was too low. The vehicle will be raised.</p> <ul style="list-style-type: none"> <li>► Stop the vehicle as soon as it is safe to do so.</li> <li>► Engage the electronic parking brake.</li> <li>► Wait until the message disappears from the multifunction display. You may then drive off.</li> </ul>
 <p>STOP Car Too Low</p>	<p>The AIRMATIC is malfunctioning.</p> <ul style="list-style-type: none"> <li>► Avoid excessive steering maneuvers. The fenders or tires could otherwise be damaged. Listen for scraping noises.</li> <li>► Stop and press the vehicle level control switch to select a higher vehicle level (► page 343).</li> <li>► Do not drive faster than 50 mph (80 km/h).</li> <li>► Contact an authorized Mercedes-Benz Center as soon as possible.</li> </ul> <p>There is otherwise danger of an accident.</p>
 <p>Malfunction</p>	<p>The capability of the AIRMATIC system is restricted. This can impair the handling.</p> <ul style="list-style-type: none"> <li>► Do not drive faster than 50 mph (80 km/h).</li> <li>► Have the vehicle checked at an authorized Mercedes-Benz Center.</li> </ul>
 <p>Attention Assist Time for a rest?</p>	<p>The ATTENTION ASSIST has determined that your concentration has declined considering certain criteria. In addition, an acoustic warning sounds.</p> <ul style="list-style-type: none"> <li>► Take a rest if required.</li> </ul> <p>During long trips, take regular and duly rests that allow you to recover sufficiently.</p>
 <p>Attention Assist Inoperative</p>	<p>The ATTENTION ASSIST is malfunctioning.</p> <ul style="list-style-type: none"> <li>► Contact an authorized Mercedes-Benz Center as soon as possible.</li> </ul>

Display messages	Possible causes/consequences and ► Solutions
 <p>Night View Assist Inoperative</p>	<p>The Night View Assist Plus is malfunctioning.</p> <ul style="list-style-type: none"> <li>► Contact an authorized Mercedes-Benz Center as soon as possible.</li> </ul>
 <p>Night View Assist Currently Unavailable</p>	<p>The temperature of the Night View Assist Plus camera is too high (► page 356).</p> <ul style="list-style-type: none"> <li>► Wait until the message Night View Assist Available Again appears.</li> </ul> <p>In addition you can:</p> <ul style="list-style-type: none"> <li>► Swing the camera cover down (► page 444).</li> <li>► Adjust the air distribution of the climate control so that air flows upward (► page 212).</li> </ul>
 <p>Night View Assist Lights Must Be Set to AUTO or ON</p>	<p>You have tried to switch on Night View Assist Plus, but the exterior lamp switch is not set to <b>A</b> or .</p> <ul style="list-style-type: none"> <li>► Turn the exterior lamp switch to <b>A</b> or  (► page 298).</li> </ul>
 <p>Night View Assist Not in Reverse Gear</p>	<p>You have tried to switch on Night View Assist Plus while the automatic transmission was in reverse gear <b>R</b>.</p> <ul style="list-style-type: none"> <li>► Shift the automatic transmission to park position <b>P</b>, neutral position <b>N</b> or drive position <b>D</b> (► page 317).</li> </ul>
 <p>Night View Assist Lights ON or AUTO, Not in R Gear</p>	<p>You have tried to switch on Night View Assist Plus, but the exterior lamp switch is not set to <b>A</b> or .</p> <p>In addition, the automatic transmission is in reverse gear <b>R</b>.</p> <ul style="list-style-type: none"> <li>► Turn the exterior lamp switch to <b>A</b> or .</li> <li>► Shift the automatic transmission to park position <b>P</b>, neutral position <b>N</b> or drive position <b>D</b> (► page 317).</li> </ul>
 <p>Night View Assist Only When It Is Dark</p>	<p>You have tried to switch on Night View Assist Plus by daylight. You can only switch on Night View Assist Plus when it is dark.</p>

## Vehicle

Display messages	Possible causes/consequences and ► Solutions
	The trunk is open. ► Close the trunk (▷ page 280).
	You are driving with the hood open. ► Stop the vehicle in a safe location as soon as it is safe to do so. ► Close the hood (▷ page 405). There is otherwise danger of an accident.
	You are driving with at least one door open. The display symbol shows you which doors are open. ► Close all doors.
	Shift to P You have attempted to turn off the engine with the KEYLESS-GO start/stop button and opened the driver's door with the automatic transmission not shift to park position P. ► Shift the automatic transmission to park position P (▷ page 317). or ► Close the driver's door.
	Key Detected In Vehicle A SmartKey with KEYLESS-GO left in the vehicle was recognized while trying to lock the vehicle from the outside. ► Take the SmartKey out of the vehicle.
	Don't Forget Your Key This message appears for a maximum of 60 seconds if the driver's door is opened with the engine turned off and no SmartKey in the starter switch. This message is only a reminder. ► Take the SmartKey with you when leaving the vehicle.
	Take Your Key From Ignition You have forgotten to remove the SmartKey. ► Remove the SmartKey from the starter switch.
	Obtain a New Key The SmartKey with KEYLESS-GO must be replaced. ► Contact an authorized Mercedes-Benz Center.
	Close Doors to Lock Vehicle You tried to lock the vehicle but not all doors were closed. ► Close doors and lock the vehicle again.

Display messages	Possible causes/consequences and ► Solutions
 <p>Key Does Not Belong to Vehicle</p>	<p>The SmartKey in the starter switch does not belong to the vehicle.</p> <ul style="list-style-type: none"> <li>► Remove the SmartKey from the starter switch.</li> </ul>
 <p>Replace Key Battery</p>	<p>The batteries in the SmartKey with KEYLESS-GO are discharged.</p> <ul style="list-style-type: none"> <li>► Replace the batteries (► page 502).</li> </ul>
 <p>Key Not Detected (message appears in red)</p>	<p>The SmartKey with KEYLESS-GO is not detected while the engine is running because the SmartKey is not in the vehicle.</p> <ul style="list-style-type: none"> <li>► Stop the vehicle as soon as it is safe to do so.</li> <li>► Engage the electronic parking brake.</li> <li>► Search for the SmartKey.</li> </ul> <p>The vehicle cannot be locked centrally nor can the engine be started again after the engine is stopped.</p>
 <p>Key Not Detected (message appears in red)</p>	<p>The SmartKey with KEYLESS-GO is not detected while the engine is running because there is strong radio-frequency interference.</p> <ul style="list-style-type: none"> <li>► Stop the vehicle as soon as it is safe to do so.</li> <li>► Engage the electronic parking brake.</li> <li>► Remove the KEYLESS-GO button from the starter switch (► page 285).</li> <li>► Operate the vehicle with the SmartKey in the starter switch.</li> </ul>
 <p>Key Not Detected (message appears in red)</p>	<p>The SmartKey with KEYLESS-GO is momentarily not detected.</p> <ul style="list-style-type: none"> <li>► Change the position of the SmartKey in the vehicle.</li> <li>► If necessary, remove the KEYLESS-GO button from the starter switch (► page 285).</li> <li>► Operate the vehicle with the SmartKey in the starter switch.</li> </ul>
 <p>Key Not Detected (message appears in white)</p>	<p>The SmartKey with KEYLESS-GO is momentarily not detected.</p> <ul style="list-style-type: none"> <li>► Change the position of the SmartKey in the vehicle.</li> <li>► If necessary, remove the KEYLESS-GO button from the starter switch (► page 285).</li> <li>► Operate the vehicle with the SmartKey in the starter switch.</li> </ul>
 <p>Key Being Initialize d... Please Wait</p>	<p>The SmartKey with KEYLESS-GO is being initialized in the vehicle.</p> <ul style="list-style-type: none"> <li>► Wait until the message disappears from the multifunction display.</li> </ul>

Display messages	Possible causes/consequences and ► Solutions
 Remove 'Start' Button and Insert Key	The KEYLESS-GO system is malfunctioning. <ul style="list-style-type: none"> <li>► Remove the KEYLESS-GO button from the starter switch (► page 285).</li> <li>► Operate the vehicle with the SmartKey in the starter switch.</li> </ul>
 Check Washer Fluid	The water level has dropped to approximately 1.1 US qts (1.0 l). <ul style="list-style-type: none"> <li>► Add washer fluid (► page 409).</li> </ul>

## Engine

Display messages	Possible causes/consequences and ► Solutions
 Check Coolant Level See Oper. Manual	The coolant level is too low. <ul style="list-style-type: none"> <li>► Add coolant (► page 408).</li> <li>► If you have to add coolant frequently, have the cooling system checked at an authorized Mercedes-Benz Center.</li> </ul>

### Warning!

Do not spill antifreeze on hot engine parts. Antifreeze contains ethylene glycol which may burn if it comes into contact with hot engine parts. You could be seriously burned.

**!** Do not ignore the low engine coolant level warning. Extended driving with the message and symbol displayed may cause serious engine damage not covered by the Mercedes-Benz Limited Warranty.

Do not drive without sufficient amount of coolant in the cooling system. The engine will overheat causing major engine damage.



Display messages	Possible causes/consequences and ► Solutions	
	Coolant Low Stop Vehicle Turn Engine Off	<p>The coolant is too hot.</p> <ul style="list-style-type: none"> <li>► Stop the vehicle immediately as soon as it is safe to do so.</li> <li>► Turn off the engine immediately.</li> <li>► Engage the parking brake.</li> <li>► Only start the engine again after the message disappears. You could otherwise damage the engine.</li> <li>► Observe the coolant temperature gauge in the instrument cluster.</li> <li>► If the temperature rises again: Contact an authorized Mercedes-Benz Center immediately.</li> </ul> <p>During severe operation conditions and stop-and-go city traffic, the coolant temperature may rise close to 248°F (120°C).</p>



### **Warning!**



Driving when your engine is overheated can cause some fluids which may have leaked into the engine compartment to catch fire. You could be seriously burned.

Steam from an overheated engine can cause serious burns which can occur just by opening the engine hood. Stay away from the engine if you see or hear steam coming from it.

Stop the vehicle in a safe location away from other traffic. Turn off the engine, get out of the vehicle and do not stand near the vehicle until the engine has cooled down.

- !** The engine should not be operated with the coolant temperature above 248°F (120°C). Doing so may cause serious damage which is not covered by the Mercedes-Benz Limited Warranty.

Display messages		Possible causes/consequences and ► Solutions
	Coolant Low Stop Vehicle Turn Engine Off	<p>The poly-V-belt could be broken.</p> <ul style="list-style-type: none"> <li>► Stop the vehicle immediately as soon as it is safe to do so.</li> <li>► Turn off the engine immediately.</li> <li>► Check the poly-V-belt.</li> </ul> <p>► <b>If it is broken:</b> Do not continue to drive. Otherwise the engine will overheat due to an inoperative water pump which may result in damage to the engine. Contact an authorized Mercedes-Benz Center.</p> <p>► <b>If it is intact:</b> Do not continue to drive the vehicle with this message displayed. Doing so could result in serious engine damage that is not covered by the Mercedes-Benz Limited Warranty.</p> <ul style="list-style-type: none"> <li>► Observe the coolant temperature gauge in the instrument cluster.</li> <li>► Drive to the nearest authorized Mercedes-Benz Center immediately.</li> </ul>
		<p>The radiator cooling fan is malfunctioning.</p> <ul style="list-style-type: none"> <li>► Observe the coolant temperature gauge in the instrument cluster.</li> </ul> <p>If the coolant temperature is below 248°F (120°C), you may continue driving to an authorized Mercedes-Benz Center.</p> <ul style="list-style-type: none"> <li>► Avoid placing heavy loads on the engine (e.g. by driving uphill) as well as stop-and-go traffic.</li> <li>► Have the fan replaced as soon as possible.</li> </ul>
		<p>The battery is no longer charging.</p> <p>Possible causes:</p> <ul style="list-style-type: none"> <li>• alternator malfunctioning</li> <li>• broken poly-V-belt</li> <li>• a malfunction in the electronic system</li> </ul> <ul style="list-style-type: none"> <li>► Stop immediately in a safe location or as soon as it is safe to do so and check the poly-V-belt.</li> <li>► <b>If it is broken:</b> Do not continue to drive. Otherwise the engine will overheat due to an inoperative water pump which may result in damage to the engine. Contact an authorized Mercedes-Benz Center.</li> <li>► <b>If it is intact:</b> Drive to the nearest authorized Mercedes-Benz Center immediately. Adjust driving to be consistent with reduced braking responsiveness.</li> </ul>

Display messages		Possible causes/consequences and ► Solutions
	Check Engine Oil at Next Refueling	<p>All models except S 600 and S 65 AMG: The engine oil level has dropped to approximately the minimum level.</p> <ul style="list-style-type: none"> <li>► Check the engine oil level (► page 405) and add engine oil as required (► page 407).</li> <li>► If you must add engine oil frequently, have the engine checked for possible leaks.</li> </ul>
	Check Engine Oil Level (Add 1 quart) (USA only) Check Engine Oil Level (Add 1 Liter) (Canada only)	<p>S 600 and S 65 AMG only: The engine oil level is too low.</p> <ul style="list-style-type: none"> <li>► Add engine oil (► page 407) and check the engine oil level (► page 405).</li> <li>► If you must add engine oil frequently, have the engine checked for possible leaks.</li> </ul>

If the message Check Engine Oil at Next Refueling (All models except S 600 and S 65 AMG) or Check Engine Oil Level (Add 1 quart) (Canada: 1 Liter) appears while the engine is running and at operating temperature, the engine oil level has dropped to approximately the minimum level.







The message will be stored in the vehicle status message memory after you have cleared it from the multifunction display.

Visually check for oil leaks. If there are no obvious oil leaks, drive to the nearest service





station to refill your engine oil to the required level.





For information on approved engine oils contact an authorized Mercedes-Benz Center or visit [www.mbusa.com](http://www.mbusa.com) (USA only).

**!** Engine oil level warnings should not be ignored. Extended driving with the symbol displayed could result in serious engine damage that is not covered by the Mercedes-Benz Limited Warranty.

Display messages		Possible causes/consequences and ► Solutions
	Engine Oil Level Cannot Be Measured	S 600 and S 65 AMG only: The measuring system is malfunctioning. ► Have the measuring system checked at an authorized Mercedes-Benz Center.
	Engine Oil Level Too High	S 600 and S 65 AMG only: You have added too much engine oil. There is a risk of damaging the engine or the catalytic converter. ► Have oil siphoned or drained off. Observe all legal requirements with respect to its disposal.
	Engine Oil Level Low Stop Vehicle Turn Engine Off	S 600 and S 65 AMG only: The engine oil level is too low. There is a danger of engine damage. ► Stop the vehicle in a safe location or as soon as it is safe to do so. ► Turn off the engine. ► Engage the electronic parking brake. ► Add engine oil (► page 407) and check the engine oil level (► page 405).
		The fuel level is low. <i>تلفن شبانه روزی: ۰۲۱۱۱۱۱۱۱۱</i> ► Refuel at the next gas station.
	Reserve Fuel	The fuel level has dropped below the reserve mark. ► Refuel at the next gas station.
	Gas Cap Loose	A loss of pressure has been detected in the fuel system. The fuel cap may not be closed properly or the fuel system may be leaking. ► Check the fuel cap (► page 403). ► <b>If it is not closed properly:</b> Close the fuel cap. ► <b>If it is closed properly:</b> Have the fuel system checked at an authorized Mercedes-Benz Center.





**Lamps**

Display messages		Possible causes/consequences and ► Solutions
	Active Headlamps Inoperative	The active headlamps are malfunctioning. ► Contact an authorized Mercedes-Benz Center as soon as possible.
	Check Left Reverse Lamp or Check Right Reverse Lamp	The left or right backup lamp is malfunctioning. ► Contact an authorized Mercedes-Benz Center as soon as possible.
	Check Center Brake Lamp	The high-mounted brake lamp is malfunctioning. This message will only appear if all LEDs have stopped working. ► Contact an authorized Mercedes-Benz Center as soon as possible.
	Check Left Fog Lamp or Check Right Fog Lamp	The left or right front fog lamp is malfunctioning. ► Contact an authorized Mercedes-Benz Center as soon as possible.
	Check Front Left Sidemarkers Lamp or Check Front Right Sidemarkers Lamp	The front left side or right side marker lamp is malfunctioning. ► Contact an authorized Mercedes-Benz Center as soon as possible.

Display messages		Possible causes/consequences and ► Solutions
	Check Rear Left Sidemarker Lamp or Check Rear Right Sidemarker Lamp	The rear left side or right side marker lamp is malfunctioning. ► Contact an authorized Mercedes-Benz Center as soon as possible.
	Check Front Left Parking Lamp or Check Front Right Parking Lamp	The left or right front parking lamp is malfunctioning. A substitute bulb is being used. ► Contact an authorized Mercedes-Benz Center as soon as possible.
	Check Left High Beam or Check Right High Beam	The left or right high-beam lamp is malfunctioning. ► Replace the bulb as soon as possible (► page 504).
	Check Left License Plate Lamp or Check Right License Plate Lamp	The left or right license plate lamp is malfunctioning. ► Contact an authorized Mercedes-Benz Center as soon as possible.

امداد خودرو فارما

FarmaSOS.com

Display messages		Possible causes/consequences and ► Solutions
	Auto Lamp Function Inoperative	<p>The light sensor is malfunctioning. The headlamps come on automatically.</p> <ul style="list-style-type: none"> <li>► Contact an authorized Mercedes-Benz Center as soon as possible.</li> </ul> <p>To switch off the headlamps (U.S. vehicles only):</p> <ul style="list-style-type: none"> <li>► Switch off the daytime running lamp mode in the instrument cluster control system (► page 234).</li> <li>► Switch off the headlamps using the exterior lamp switch (► page 298).</li> </ul>
	Check Left Low Beam or Check Right Low Beam	<p>The left or right low-beam lamp is malfunctioning.</p> <ul style="list-style-type: none"> <li>► Contact an authorized Mercedes-Benz Center as soon as possible.</li> </ul>
	Check Rear Left Fog Lamp	<p>The rear fog lamp is malfunctioning. A substitute bulb is being used.</p> <ul style="list-style-type: none"> <li>► Contact an authorized Mercedes-Benz Center as soon as possible.</li> </ul>
	Please Switch Off Lights	<p>You have removed the SmartKey from the starter switch, opened the driver's door and left the headlamps on or removed the SmartKey with KEYLESS-GO from the vehicle and left the headlamps on.</p> <ul style="list-style-type: none"> <li>► Turn the exterior lamp switch to <b>0</b> or <b>A</b> (► page 298).</li> </ul> <p>or</p> <ul style="list-style-type: none"> <li>► <b>With the rear fog lamp switched on:</b> Push in the exterior lamp switch to its stop.</li> </ul>
	Check Left Tail and Brake Lamp or Check Right Tail and Brake Lamp	<p>The left or right tail lamp/brake lamp is malfunctioning. This message will only appear if a critical number of LEDs have stopped working. A substitute bulb is being used.</p> <ul style="list-style-type: none"> <li>► Contact an authorized Mercedes-Benz Center as soon as possible.</li> </ul>

امداد خودرو فارما

تلفن شبانه روزی: ۰۲۱-۸۸۷۲۰۸۵

Tam333.com





Display messages		Possible causes/consequences and ► Solutions
	Check Left Cornering Light or Check Right Cornering Light	The left or right corner-illuminating lamp is malfunctioning. ► Contact an authorized Mercedes-Benz Center as soon as possible.
	Check Rear Left Turn Signal or Check Rear Right Turn Signal	The left or right rear turn signal lamp is malfunctioning. A substitute bulb is being used. ► Contact an authorized Mercedes-Benz Center as soon as possible.
	Check Front Left Turn Signal or Check Front Right Turn Signal	The left or right front turn signal lamp is malfunctioning. ► Contact an authorized Mercedes-Benz Center as soon as possible.
	Check Left Mirror Turn Signal or Check Right Mirror Turn Signal	The turn signal in the left or right exterior rear view mirror is malfunctioning. This message will only appear if all LEDs have stopped working. ► Contact an authorized Mercedes-Benz Center as soon as possible.

امداد خودرو فارما

FarmaSOS.com

تلفن شبانه روزی: ۰۲۱-۸۵۰۰۰۰۰۰۰۰

## Tires

Display messages		Possible causes/consequences and ► Solutions
	Tire Press. Warning Caution Tire Malfunction	At least one tire is deflating. <ul style="list-style-type: none"> <li>► Carefully bring the vehicle to a halt, avoiding abrupt steering and braking maneuvers.</li> <li>► If necessary, change the wheel (▷ page 508).</li> </ul>
	Check Tire Pressure	The tire inflation pressure in at least one tire is significantly below the reference value. <ul style="list-style-type: none"> <li>► Carefully bring the vehicle to a halt, avoiding abrupt steering and braking maneuvers.</li> <li>► Check and adjust tire inflation pressure as required.</li> <li>► If necessary, change the wheel (▷ page 508).</li> </ul>

 **Warning!**

Do not drive with a flat tire. A flat tire affects the ability to steer or brake the vehicle. You may lose control of the vehicle. Continued driving with a flat tire will cause excessive heat build-up and possibly a fire.

 **Warning!**

Follow recommended tire inflation pressures.

Do not underinflate tires. Underinflated tires wear excessively and/or unevenly, adversely affect handling and fuel economy, and are more likely to fail from being overheated.

Do not overinflate tires. Overinflated tires can adversely affect handling and ride comfort, wear unevenly, increase stopping distance, and result in sudden deflation (blowout) because they are more likely to become punctured or damaged by road debris, potholes etc.

## What to do if ...

### Lamps in instrument cluster

#### Notes

If any of the following lamps in the instrument cluster fails to come on during the bulb self-check when switching on the ignition, have the respective bulb checked and replaced if necessary.



When you switch on the ignition, all lamps in the instrument cluster come on. The high-beam headlamp indicator lamp and turn





signal indicator lamps will only come on if activated. If a lamp in the instrument cluster fails to come on when the ignition is switched on, have it checked and replaced if necessary.





 **Warning!**

HYBRID vehicles: It is imperative that you read the HYBRID Supplemental Operating Instructions included in your vehicle literature portfolio. You may otherwise not receive all necessary safety information and warning for the operation of your vehicle.

## Brake

Problem	Possible causes/consequences and ► Solutions
 The yellow ABS indicator lamp comes on while the engine is running.	<p>The brake system is still functioning normally but due to a malfunction, the ABS, the BAS, the BAS PLUS, the ESC, the hill-start assist system, the HOLD function, the Adaptive Brake Lights, the PRE-SAFE® system, and the PRE-SAFE® Brake are unavailable.</p> <p>The ATTENTION ASSIST is disabled.</p> <ul style="list-style-type: none"> <li>► Continue driving with added caution. Wheels may lock during hard braking, reducing steering capability.</li> <li>► Adjust driving to be consistent with reduced braking responsiveness.</li> <li>► Read and observe messages that may appear in the multifunction display (► page 452).</li> <li>► Have the system checked at an authorized Mercedes-Benz Center as soon as possible.</li> </ul> <p>Failure to follow these instructions increases the risk of an accident.</p>
 The yellow ABS indicator lamp comes on while the engine is running.	<p>The brake system still functions normally but due to insufficient power supply, the ABS, the BAS, the BAS PLUS, the ESC, the hill-start assist system, the HOLD function, the Adaptive Brake Lights, the PRE-SAFE® system, and the PRE-SAFE® Brake are unavailable.</p> <p>The ATTENTION ASSIST is disabled.</p> <p>When the voltage is above the required value again, the ABS is operational again. The ABS indicator lamp should go out.</p> <ul style="list-style-type: none"> <li>► Continue driving with added caution. Wheels may lock during hard braking, reducing steering capability.</li> <li>► Adjust driving to be consistent with reduced braking responsiveness.</li> <li>► Read and observe messages that may appear in the multifunction display (► page 452).</li> <li>► If the ABS indicator lamp does not go out: Have the alternator and the battery checked.</li> </ul>

Problem	Possible causes/consequences and ► Solutions
 The yellow ABS indicator lamp comes on while the engine is running.	<p>The brake system is still functioning normally but temporarily the ABS, the BAS, the BAS PLUS, the ESC, the hill-start assist system, the HOLD function, the Adaptive Brake Lights, the PRE-SAFE® system, and the PRE-SAFE® Brake are unavailable. The self-diagnosis has not been completed yet. The ATTENTION ASSIST is disabled.</p> <p>The indicator lamp will go out after driving a short distance at a vehicle speed of above 12 mph (20 km/h).</p> <p>If the ABS indicator lamp does not go out:</p> <ul style="list-style-type: none"> <li>► Continue driving with added caution. Wheels may lock during hard braking, reducing steering capability.</li> <li>► Adjust driving to be consistent with reduced braking responsiveness.</li> <li>► Read and observe messages that may appear in the multifunction display (▷ page 452).</li> <li>► Have the system checked at an authorized Mercedes-Benz Center as soon as possible.</li> </ul> <p>Failure to follow these instructions increases the risk of an accident.</p>
   The yellow ESC warning lamp, the yellow ESC OFF warning lamp, and the yellow ABS indicator lamp come on while the engine is running and an acoustic warning sounds.	<p>The Electronic Brake Proportioning (EBP) switched off due to a malfunction.</p> <p>The ABS, the BAS, the BAS PLUS, the ESC, the hill-start assist system, the HOLD function, the Adaptive Brake Lights, the PRE-SAFE® system, and the PRE-SAFE® Brake are also switched off.</p> <p>The brake system is still functioning normally but without the systems specified above available. The ATTENTION ASSIST is disabled.</p> <ul style="list-style-type: none"> <li>► Continue driving with added caution. Wheels may lock during hard braking, reducing steering capability.</li> <li>► Adjust driving to be consistent with reduced braking responsiveness.</li> <li>► Read and observe messages that may appear in the multifunction display (▷ page 452).</li> <li>► Have the system checked at an authorized Mercedes-Benz Center as soon as possible.</li> </ul> <p>Failure to follow these instructions increases the risk of an accident.</p>

Problem	Possible causes/consequences and ► Solutions
<p> (USA only)   (Canada only)</p> <p>The red indicator lamp for the electronic parking brake flashes and/or the yellow warning lamp for the electronic parking brake is on.</p>	<p>The electronic parking brake is malfunctioning or defective.</p> <ul style="list-style-type: none"> <li>► Read and observe messages that may appear in the multifunction display (▷ page 452).</li> <li>► Have the system checked at an authorized Mercedes-Benz Center as soon as possible.</li> </ul>
<p> (USA only)   (Canada only)</p> <p>The red brake warning lamp comes on while the engine is running and an acoustic warning sounds.</p>	<p>There is insufficient brake fluid in the reservoir.  Risk of accident!</p> <ul style="list-style-type: none"> <li>► Do not drive any further. Stop the vehicle in a safe location as soon as it is safe to do so.</li> <li>► Engage the electronic parking brake.</li> <li>► Read and observe messages that may appear in the multifunction display (▷ page 452).</li> <li>► Contact an authorized Mercedes-Benz Center.</li> </ul> <p>Do not add brake fluid! This will not solve the problem.</p>





### **Warning!**

Driving with the brake warning lamp illuminated can result in an accident. Have your brake system checked immediately if the brake warning lamp stays on. Do not add brake fluid before checking the brake system. Overfilling the brake fluid reservoir can result in spilling brake fluid on hot engine parts and

the brake fluid catching fire. You can be seriously burned.

**!** If you find that the brake fluid in the brake fluid reservoir has fallen to the minimum mark or below, have the brake system checked for brake pad thickness and leaks.

**Safety systems**

Problem	Possible causes/consequences and ► Solutions
<p> The red seat belt telltale comes on for a maximum of 6 seconds after starting the engine.</p>	<p>The seat belt telltale reminds you and your passengers to fasten your seat belts before driving off.</p> <p>► Fasten your seat belts.</p> <p>Regardless of whether the seat belts are fastened or not, the seat belt telltale always comes on and remains lit for 6 seconds after starting the engine.</p>
<p> The red seat belt telltale comes on. In addition you hear a warning chime for a maximum of 6 seconds after starting the engine.</p>	<p>You have forgotten to fasten your seat belt.</p> <p>► Fasten your seat belt. The warning chime stops sounding.</p>
<p> The red seat belt telltale comes on while the vehicle is standing still and the engine is running or while driving.</p>	<p>You and/or your front passenger have forgotten to fasten your seat belts.</p> <p>► Fasten your seat belts. The seat belt telltale goes out. <small>تلفن شد</small></p> <p>There are items placed on the front passenger seat and therefore the system senses the front passenger seat as being occupied.</p> <p>► Remove the items from the front passenger seat and put them in a safe place. The seat belt telltale goes out.</p>
<p> The red seat belt telltale flashes while driving. In addition, an intermittent warning chime sounds with increasing intensity.</p>	<p>The vehicle's speed once exceeded 15 mph (25 km/h) and you and/or your front passenger have forgotten to fasten your seat belts.</p> <p>► Fasten your seat belts. The seat belt telltale goes out and the warning chime stops sounding.</p> <p>There are items placed on the front passenger seat and therefore the system senses the front passenger seat as being occupied.</p> <p>► Remove the items from the front passenger seat and put them in a safe place. The seat belt telltale goes out and the warning chime stops sounding.</p>

- i** After 60 seconds with an unfastened seat belt the warning chime stops sounding and the seat belt telltale illuminates continuously. The seat belt telltale will only go out if both, the driver and front passenger's seat belt are fastened, or the vehicle is standing still and a front door is opened.

Problem	Possible causes/consequences and ► Solutions
 The red SRS indicator lamp comes on while driving.	<p>There is a malfunction in the restraint systems. The air bags or Emergency Tensioning Devices (ETDs) could deploy unexpectedly or fail to activate in an accident.</p> <p>► Drive with added caution to the nearest authorized Mercedes-Benz Center.</p>

### **Warning!**

In the event a malfunction of the SRS is indicated as outlined above, the SRS may not be operational.



For your safety, we strongly recommend that you contact an authorized Mercedes-Benz

Center immediately to have the system checked. Otherwise the SRS may not be activated when needed in an accident, which could result in serious or fatal injury, or it might deploy unexpectedly and unnecessarily which could also result in injury.

تلفن شبانه روزی: ۰۲۱-۸۸۸۶۲۰۸۵

FarmaSOS.com



Problem	Possible causes/consequences and ► Solutions
 The yellow ESC OFF warning lamp comes on while the engine is running.	<p>The ESC has been switched off. Risk of accident!</p> <p>When the ESC is switched off it will not stabilize the vehicle if the system recognizes that the vehicle starts to skid or that a wheel is spinning.</p> <ul style="list-style-type: none"> <li>► Switch the ESC back on. Exceptions: (► page 67).</li> <li>► If leaving the ESC switched off, adapt your speed and driving to the prevailing road and weather conditions.</li> <li>► If the ESC cannot be switched back on: Have the system checked at an authorized Mercedes-Benz Center as soon as possible.</li> </ul>
 The yellow ESC warning lamp and the yellow ESC OFF warning lamp come on while the engine is running.	<p>The ESC is not operational due to a malfunction. The ABS, the BAS, the BAS PLUS, the hill-start assist system, the HOLD function, the Adaptive Brake Lights, the PRE-SAFE® system, and the PRE-SAFE® Brake are also switched off. The brake system is still functioning normally but without the systems specified above available. The ATTENTION ASSIST is disabled.</p> <ul style="list-style-type: none"> <li>► Read and observe additional messages that may appear in the multifunction display.</li> <li>► Continue driving with added caution. Wheels may lock during hard braking, reducing steering capability.</li> <li>► Adapt your speed and driving to the prevailing road and weather conditions.</li> <li>► Have the system checked at an authorized Mercedes-Benz Center as soon as possible.</li> </ul> <p>Failure to follow these instructions increases the risk of an accident.</p>
 The yellow ESC warning lamp flashes while driving.	<p>The ESC or the ETS/4-ETS has come into operation because of detected traction loss in at least one tire.</p> <ul style="list-style-type: none"> <li>► When driving off, apply as little throttle as possible.</li> <li>► While driving, ease up on the accelerator pedal.</li> <li>► Adapt your speed and driving to the prevailing road and weather conditions.</li> <li>► Do not deactivate the ESC. Exceptions: (► page 67).</li> </ul> <p>Failure to follow these instructions increases the risk of an accident.</p>



## Driving systems

Problem	Possible causes/consequences and ► Solutions
 DISTRONIC PLUS or PRE-SAFE® Brake: The red distance warning lamp comes on while driving and an acoustic warning sounds.	You are gaining too rapidly on the vehicle ahead of you or DISTRONIC PLUS or PRE-SAFE® Brake has recognized a stationary obstacle on your probable line of travel. <ul style="list-style-type: none"> <li>► Apply the brakes immediately.</li> <li>► Carefully observe the traffic situation. You may need to brake or maneuver to avoid hitting an obstacle.</li> </ul>



## Vehicle

Problem	Possible causes/consequences and ► Solutions
The yellow fuel tank reserve warning lamp in the fuel gauge comes on while driving.	The fuel level has gone below the reserve mark. <ul style="list-style-type: none"> <li>► Refuel at the next gas station.</li> </ul>

## Engine

Problem	Possible causes/consequences and ► Solutions
 The yellow engine malfunction indicator lamp comes on when the engine is running.	There may be a malfunction in <ul style="list-style-type: none"> <li>• the fuel management system</li> <li>• the ignition system</li> <li>• the emission control system</li> <li>• systems which affect emissions</li> </ul> Such malfunctions may result in excessive emissions values and may switch the engine to limp-home (emergency operation) mode. <ul style="list-style-type: none"> <li>► Have the vehicle checked as soon as possible at an authorized Mercedes-Benz Center.</li> </ul> <p><b>i</b> Some states may by law require you to visit a workshop as soon as the engine malfunction indicator lamp comes on. Check local requirements.</p>
 The yellow engine malfunction indicator lamp comes on when the engine is running.	A loss of pressure has been detected in the fuel system. The fuel cap may not be closed properly or the fuel system may be leaky. <ul style="list-style-type: none"> <li>► Check the fuel cap (▷ page 402).</li> <li>► <b>If it is not closed properly:</b> Close the fuel cap.</li> <li>► <b>If it is closed properly:</b> Have the fuel system checked by an authorized Mercedes-Benz Center.</li> </ul>

## Tires

Problem	Possible causes/consequences and ► Solutions
<p> USA only: Combination low tire pressure telltale/TPMS malfunction telltale for the Advanced TPMS illuminates continuously. Canada only: Low tire pressure telltale for the Advanced TPMS illuminates continuously.</p>	<p>The Advanced TPMS detects a loss of pressure in at least one tire.</p> <ul style="list-style-type: none"> <li>► Carefully bring the vehicle to a halt, avoiding abrupt steering and braking maneuvers. Observe the traffic situation around you.</li> <li>► Read and observe messages in the multifunction display (▷ page 452).</li> </ul> <p>If the tire inflation pressure in the respective tire(s) has (have) been corrected, the combination low tire pressure/TPMS malfunction telltale goes out after a few minutes of driving.</p>
<p> USA only: Combination low tire pressure telltale/TPMS malfunction telltale for the Advanced TPMS flashes 60 seconds and then stays illuminated.</p>	<p>There is a malfunction in the Advanced TPMS.</p> <ul style="list-style-type: none"> <li>► Read and observe messages in the multifunction display (▷ page 452).</li> <li>► Have the Advanced TPMS checked at an authorized Mercedes-Benz Center.</li> </ul> <p>After the malfunction has been remedied, the combination low tire pressure/TPMS malfunction telltale goes out after a few minutes of driving.</p>

### **Warning!**

Each tire, including the spare (if provided), should be checked at least once a month when cold and inflated to the inflation pressure recommended by the vehicle manufacturer on the Tire and Loading Information placard on the driver's door B-pillar or the tire inflation pressure label on the inside of the fuel filler flap. If your vehicle has tires of a different size than the size indicated on the Tire and Loading Information placard or the tire inflation pressure label, you should

determine the proper tire inflation pressure for those tires.

As an added safety feature, your vehicle has been equipped with a tire pressure monitoring system (TPMS) that illuminates a low tire pressure telltale when one or more of your tires are significantly underinflated. Accordingly, when the low tire pressure telltale illuminates, you should stop and check your tires as soon as possible, and inflate them to the proper pressure. Driving on a significantly underinflated tire causes the tire to overheat and can lead to tire failure.

Underinflation also reduces fuel efficiency and tire tread life, and may affect the vehicle's handling and stopping ability. Please note that the TPMS is not a substitute for proper tire maintenance, and it is the driver's responsibility to maintain correct tire pressure, even if underinflation has not reached the level to trigger illumination of the TPMS low tire pressure telltale.

USA only:

Your vehicle has also been equipped with a TPMS malfunction indicator to indicate when the system is not operating properly. The TPMS malfunction indicator is combined with the low tire pressure telltale. When the system detects a malfunction, the telltale will flash for approximately 1 minute and then

remain continuously illuminated. This sequence will continue upon subsequent vehicle start-ups as long as the malfunction exists. When the malfunction indicator is illuminated, the system may not be able to detect or signal low tire pressure as intended. TPMS malfunctions may occur for a variety of reasons, including the installation of incompatible replacement or alternate tires or wheels on the vehicle that prevent the TPMS from functioning properly. Always check the TPMS malfunction telltale after replacing one or more tires or wheels on your vehicle to ensure that the replacement or alternate tires and wheels allow the TPMS to continue to function properly.

## Lamp in center console

### Problem

 **PASS AIR BAG OFF**  
The front passenger front air bag off indicator lamp illuminates and remains illuminated with the weight of a typical adult or someone larger than a small individual on the front passenger seat.

### Possible causes/consequences and ► Solutions

The system is malfunctioning.

- Have the system checked as soon as possible at an authorized Mercedes-Benz Center.
- Read and observe messages in the multifunction display and follow corrective steps (► page 452).

### Warning!

If the  **PASS AIR BAG OFF** indicator lamp illuminates and remains illuminated with the weight of a typical adult or someone larger

than a small individual on the front passenger seat, do not have any passenger use the front passenger seat until the system has been repaired.

Problem	Possible causes/consequences and ► Solutions
<p> <b>PASS AIR BAG OFF</b></p> <p>The front passenger front air bag off indicator lamp does not illuminate and/or does not remain illuminated with the weight of a typical 12-month-old child in a standard child restraint or less on the front passenger seat.</p>	<p>The system is malfunctioning.</p> <ul style="list-style-type: none"> <li>► Make sure there is nothing between seat cushion and child seat and check installation of the child seat.</li> <li>► Make sure no objects applying supplemental weight onto the seat are present.</li> <li>► If the front passenger front air bag off indicator lamp remains out, have the system checked as soon as possible at an authorized Mercedes-Benz Center. Do not transport a child on the front passenger seat until the system has been repaired.</li> <li>► Read and observe messages in the multifunction display and follow corrective steps (► page 452).</li> </ul>

### **Warning!**

If the  **PASS AIR BAG OFF** indicator lamp does not illuminate or remains out with the weight of a typical 12-month-old child in a standard child restraint or less on the front passenger seat, do not transport a child on the front passenger seat until the system has been repaired.

### Removing the mechanical key



## Unlocking/locking manually

### Unlocking the vehicle

If you cannot unlock the vehicle with the SmartKey or with KEYLESS-GO, unlock the driver's door and the trunk using the mechanical key.

The anti-theft alarm system will trigger when you

- unlock the driver's door or the trunk with the mechanical key and
- open the driver's door or the trunk

To cancel the alarm, insert the SmartKey into the starter switch.

SmartKey

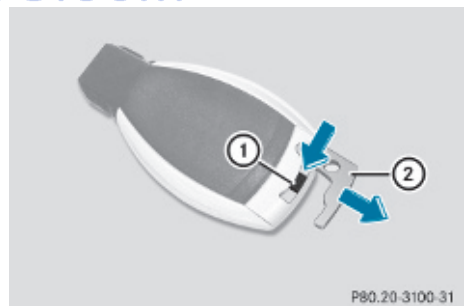

SmartKey with KEYLESS-GO

- Move locking tab ① in the direction of arrow.
- Slide mechanical key ② out of the housing.

## Unlocking the driver's door

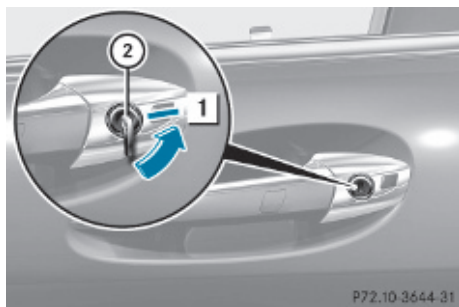

- ▶ Insert mechanical key ② into the driver's door lock.
- ▶ Turn mechanical key ② counterclockwise to position ①.
- ▶ Pull the door handle past the resistance point until the locking knob moves up. The driver's door is unlocked.
- ▶ Pull the door handle once more to open the driver's door.
- ▶ Turn mechanical key ② back and remove it from the driver's door lock.

## Unlocking the trunk

A minimum height clearance of 5.9 ft (1.8 m) is required to open the trunk lid.

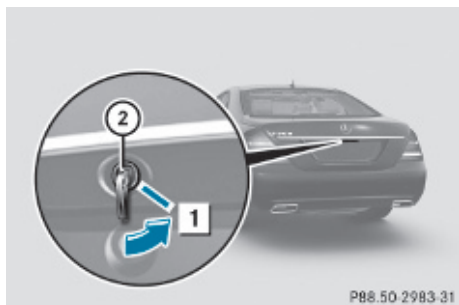

- ▶ Insert mechanical key ② into the trunk lid lock.
- ▶ Turn mechanical key ② counterclockwise to position ①.

**!** When you open the trunk, the trunk lid swings open upwards. Always make sure there is sufficient overhead clearance.

- ▶ Turn mechanical key ② back and remove it from the trunk lid lock.

## Locking the vehicle

If you cannot lock the vehicle with the SmartKey or with KEYLESS-GO, lock it as follows:

- ▶ Open the driver's door and the rear left door.
- ▶ Close the front passenger door, the right rear door, and the trunk.

**i** If you cannot close the trunk with the remote trunk opening/closing switch, lower the trunk lid manually and close it with hands placed flat on the trunk lid until it is engaged in its lock.

- ▶ Press the central locking switch (▷ page 279). The locking knobs of the front passenger door and the rear doors move down.
- ▶ **If the vehicle battery is disconnected or drained:** Press down the locking knobs on the front passenger door and the rear doors.
- ▶ Exit the vehicle.
- ▶ Check whether the trunk is locked.
- ▶ If it is not locked, lock it with the mechanical key (▷ page 283). Except for the driver's door, the vehicle should now be locked.
- ▶ Close the driver's door.
- ▶ Enter the vehicle through the rear left door.
- ▶ Press down the locking knob of the driver's door.

**!** To prevent inadvertent lockout, make sure to have the SmartKey with you before proceeding with the next step. The next step will lock the vehicle.

- ▶ Exit the vehicle.
  - ▶ Close the rear left door.  
The vehicle is locked.
- i** This procedure does not arm the anti-theft alarm system, nor does it lock the fuel filler flap.

### Resetting activated NECK-PRO active front head restraints

If the NECK-PRO active front head restraints have been triggered in a rear-end collision, they must be reset.

You can tell that the NECK-PRO active front head restraints have been triggered when they have been moved forward and cannot be adjusted.

#### **⚠ Warning!**

For safety reasons, have the NECK-PRO active front head restraints checked at an authorized Mercedes-Benz Center after a rear-end collision.

#### **⚠ Warning!**

When pushing back the head restraint cushion, make sure your fingers do not become caught between the head restraint cushion and the cover. Failing to do so may lead to injury.

**!** Be careful not to damage upholstery.

- i** Pressing the head restraint cushion back requires high force. If you encounter difficulties when pushing the head restraint back, please have the procedure performed at an authorized Mercedes-Benz Center.

### Head restraints (standard)

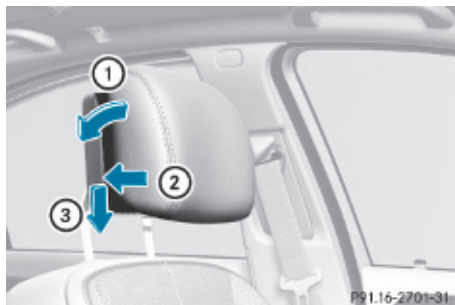

- ▶ Push the head restraint cushion by the bottom, back as far as it will go ②.
- ▶ Push the head restraint cushion down into the guide as far as it will go ③.
- ▶ Fold the head restraint cushion by the top, back firmly until it engages ①.
- ▶ Repeat this procedure on the NECK-PRO active front head restraint for the second front seat.

### Comfort head restraints

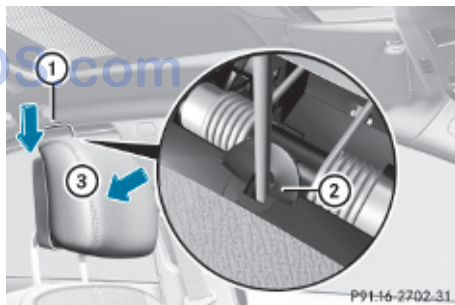

- ▶ Take reset tool ① out of the Mercedes-Benz literature pouch.
- ▶ Guide reset tool ① into rectangular opening ② between head restraint cushion and head restraint cover.
- ▶ Press reset tool ① downward in direction of arrow until you hear the head restraint release mechanism audibly engage.
- ▶ Pull out reset tool ①.



- ▶ Firmly press the head restraint cushion backward towards the head restraint cover in direction of arrow ③ until it engages.
- ▶ Repeat this procedure for the second front seat.
- ▶ After resetting the NECK-PRO active front head restraints store reset tool ① in the Mercedes-Benz literature pouch.

For information on NECK-PRO active front head restraints, see “NECK-PRO active front head restraints” (▷ page 55).

For information on head restraint adjustment, see “Seats” (▷ page 286).

## Replacing batteries (SmartKey, remote control, headphone)

### Notes

If the batteries in the SmartKey are discharged, the vehicle can no longer be locked or unlocked. It is recommended to have the batteries replaced at an authorized Mercedes-Benz Center.

### ⚠ Warning!

Batteries contain poisonous and corrosive substances. Therefore, keep the batteries out of reach of children.

If a battery is swallowed, seek medical help immediately.

### ⚠ Warning!

SmartKey batteries contain perchlorate material, which may require special handling and regard for the environment. Check with your local government's disposal guidelines. California residents, see [www.dtsc.ca.gov/HazardousWaste/Perchlorate/index.cfm](http://www.dtsc.ca.gov/HazardousWaste/Perchlorate/index.cfm).

Batteries contain materials that can harm the environment if disposed of improperly. Recycling of batteries is the preferred method of disposal. Many states (USA only) or provinces (Canada only) require sellers of batteries to accept old batteries for recycling.

## SmartKey

When inserting the batteries, make sure they are clean and free of lint.

When replacing batteries, always replace both batteries.

**i** The required replacement batteries are available at any authorized Mercedes-Benz Center.

Replacement batteries: Lithium, type CR 2025 or equivalent.

- ▶ Remove the mechanical key from the SmartKey (▷ page 499).

## Replacing batteries (SmartKey)

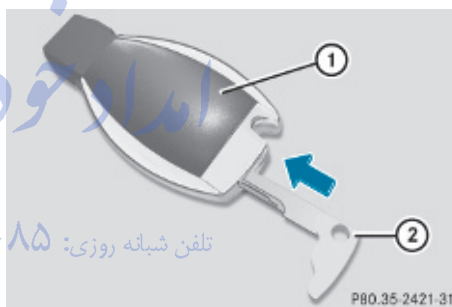

- ▶ Press mechanical key ② into the SmartKey opening until battery compartment cover ① opens. Do not keep the cover shut.

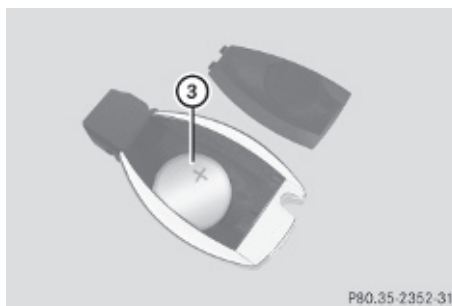

- ▶ Remove the battery compartment cover.
- ▶ Pat the SmartKey against the palm of your hand until battery ③ falls out.

- ▶ Insert the new battery with the positive terminal (+) facing up. Use a lint-free cloth.
- ▶ Insert the tabs of the battery compartment into the housing and press the cover closed.
- ▶ Slide mechanical key ① back into the SmartKey.
- ▶ Check the operation of the SmartKey.

- ▶ Return battery compartment ② into SmartKey housing until it locks into place.
- ▶ Slide mechanical key ① back into the SmartKey.
- ▶ Check the operation of the SmartKey as well as the KEYLESS-GO function.

### Replacing batteries (SmartKey with KEYLESS-GO)

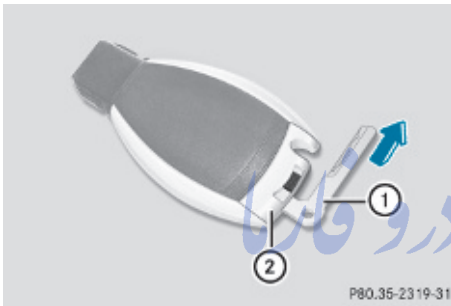

- ▶ Insert mechanical key ① into opening.
- ▶ Press mechanical key ① in direction of arrow. Battery compartment ② is unlatched.
- ▶ Pull battery compartment ② out of the SmartKey housing.

### Remote control for Rear Seat Entertainment System and/or SPLITVIEW



The remote control contains two batteries of size AAA, 1.5 V.

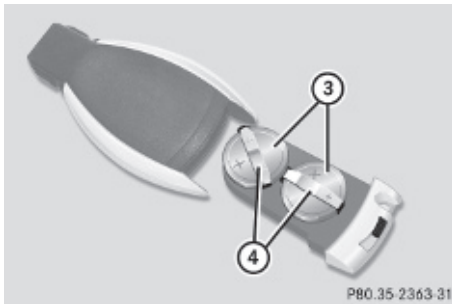

- ▶ Remove the cover of battery compartment ③ on the back of the remote control by pressing down the snap-fit hook ②.
- ▶ Take out the empty batteries ⑤.
- ▶ Insert the new batteries. Mind the polarity marks on the batteries.  
Battery on the left: The positive terminal (+) must face upwards.  
Battery on the right:

- ▶ Pull out batteries ③.
- ▶ Insert new batteries ③ under contact springs ④ with the positive terminal (+) side facing up.

The positive terminal (+) must face downwards.

- ▶ Put the cover with engagement hooks ④ first onto the battery compartment and let the snap-fit hook ② snap in.

### Wireless headphone



The headphone contains two batteries of size AAA, 1.5 V.

- ▶ Open battery compartment cover ① by folding it up. When doing so, hold the left headphone as shown in the illustration to prevent the inserted batteries from falling out.
- ▶ Take out the empty batteries.
- ▶ Insert the new batteries. Mind the polarity marks on the batteries.  
Battery on the left:  
The positive terminal (+) must face upwards.  
Battery on the right:  
The positive terminal (+) must face downwards.
- ▶ Close the battery compartment.  
The state indicator LED lights green when you switch on the headphone and the batteries were inserted correctly.

## Replacing bulbs

### Safety notes

Safe vehicle operation depends on proper exterior lighting and signaling to a large degree.

Correct headlamp adjustment is extremely important. Have headlamps checked and readjusted at regular intervals and when a bulb has been replaced. Contact an authorized Mercedes-Benz Center for headlamp adjustment.

### ⚠ Warning!

Bulbs and bulb sockets can be very hot. Allow the lamp to cool down before changing a bulb. Keep bulbs out of reach of children.

Halogen lamps contain pressurized gas. A bulb can explode if you

- touch or move it when hot
- drop the bulb
- scratch the bulb

Wear eye and hand protection.

Because of high voltage in Xenon lamps, it is dangerous to replace the bulb or repair the lamp and its components. We recommend that you have such work done by a qualified technician.

### ⚠ Warning!

The bulbs in the tail lamps cannot be replaced individually. The tail lamp bulbs are under pressure and could explode during an attempt to replace them.

If the tail lamps are malfunctioning, have them replaced at an authorized Mercedes-Benz Center.

- ⓘ Since replacing bulbs is a technically highly demanding process, we recommend to have them replaced at an authorized Mercedes-Benz Center.

- ⓘ If the headlamps or front fog lamps are fogged up on the inside as a result of high

humidity, driving the vehicle a distance with the lights on should clear up the fogging.

## Bulbs

You can replace the following bulbs yourself:

Bi-Xenon headlamps (vehicles with halogen daytime running lamps)

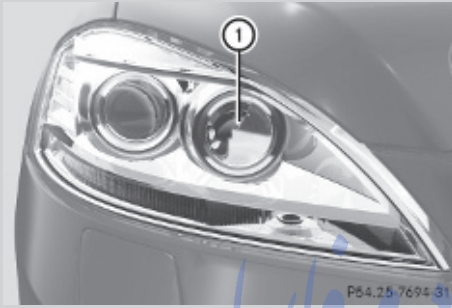

Type

- ① High-beam spot: H7 55 W

Bi-Xenon headlamps (vehicles with LED daytime running lamps)

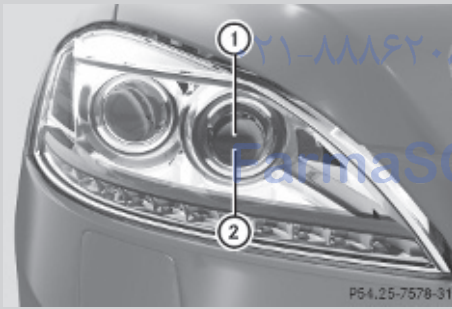

Type

- ① High-beam spot<sup>45</sup>: H11 55 W  
 ② Infrared light<sup>45</sup> (Night View Assist Plus): H11.55 W  
 تلفن شبانه ۰۸۱-۸۸۶۲۰۸۱

## Notes on bulb replacement

**!** Do not replace LEDs or bulbs not described in this section. You could otherwise damage the LEDs, the bulbs or parts of the vehicle. Only have the LEDs and bulbs replaced at an authorized Mercedes-Benz Center.

**⚠ Observe Safety notes, see page 504.**

- Only use 12-volt bulbs of the same type and with the specified watt rating.
- Switch the lights off before changing a bulb to prevent short circuits.
- Always use a clean lint-free cloth when handling bulbs.

<sup>45</sup> Because the driver's side headlamp is difficult to access, have its bulbs replaced by an authorized Mercedes-Benz Center.

- ▶ Your hands should be dry and free of oil and grease.
- ▶ If the newly installed bulb does not come on, contact an authorized Mercedes-Benz Center.

**i** Mercedes-Benz recommends using Longlife (LL) bulbs.

### Replacing bulbs for front lamps

#### **⚠ Warning!**

Do not remove the cover for the Bi-Xenon headlamp. Because of high voltage in Xenon lamps, it is dangerous to replace the bulb or repair the lamp and its components. It is recommended to have such work done by a qualified technician.

Before you start to replace a bulb for a front lamp, do the following:

- ▶ Switch off the ignition.
- ▶ Turn the exterior lamp switch to position **0**.
- ▶ Open the hood (> page 404).

### High-beam spot (vehicles with halogen daytime running lamps)

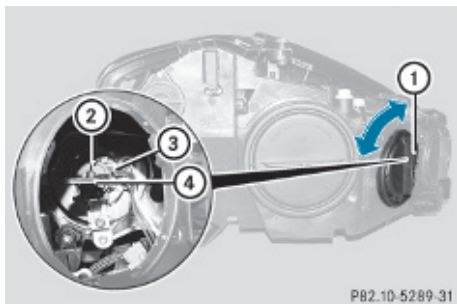

- ▶ Turn housing cover **①** counterclockwise and remove it.
- ▶ Turn bulb socket **②** counterclockwise and pull it out.
- ▶ Pull the bulb out of bulb socket **②**.

- ▶ Insert the new bulb into bulb socket **②**.
- ▶ Insert bulb socket **②**.  
Driver's side headlamp: Wire **③** is guided to the upper right.  
Passenger-side headlamp: Wire **③** is guided to the lower left.
- ▶ Turn bulb socket **②** clockwise. Handle **④** of bulb socket **②** is in a horizontal position.
- ▶ Align housing cover **①** and turn it clockwise.

### High-beam spot (vehicles with LED daytime running lamps) or infrared light (Night View Assist Plus)

- i** To replace bulbs of the driver's side headlamp, the washer fluid reservoir in the engine compartment must be released. Have such work performed at an authorized Mercedes-Benz Center.

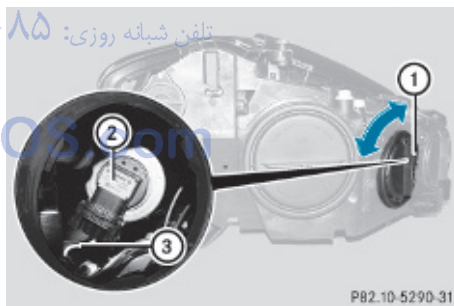

- ▶ Turn housing cover **①** counterclockwise and remove it.
- ▶ Turn bulb socket **②** counterclockwise and pull it out.
- ▶ Press both tabs to the left and right of bulb socket **②** and pull the bulb out of bulb socket **②**.
- ▶ Insert and press the new bulb into bulb socket **②** until it engages.

- ▶ Insert bulb socket ② into the guide on the headlamp.  
Wire ③ is guided to the lower right.
- ▶ Turn bulb socket ② clockwise.  
Wire ③ is guided to the lower left.
- ▶ Align housing cover ① and turn it clockwise.

## Replacing bulbs for rear lamps

### Tail lamp unit

The tail lamps are equipped with HiP bulbs and LEDs. Have them replaced at an authorized Mercedes-Benz Center.

## Replacing wiper blades

### Safety notes

#### ⚠ Warning!

For safety reasons, switch off the wipers and remove the SmartKey from the starter switch (vehicles with KEYLESS-GO: Make sure the vehicle's on-board electronics have status **0**) before replacing a wiper blade. Otherwise, the wiper motor could suddenly turn on and cause injury.

#### ⚠ Warning!

Wiper blades are components that are subject to wear and tear. Replace the wiper blades twice a year, preferably in the spring and fall. Otherwise the windshield will not be wiped properly. As a result, you may not be able to observe surrounding traffic conditions and could cause an accident.

- ❗ To avoid damage to the hood, the wiper arms should only be folded forward when in the vertical position.
- ❗ Never open the hood when a wiper arm is folded forward.  
Hold on to the wiper when folding a wiper arm back. If released, the force of the

impact from the tensioning spring could crack the windshield.

Do not allow a wiper arm to contact the windshield glass without a wiper blade inserted.

Mercedes-Benz recommends that you have this work carried out at an authorized Mercedes-Benz Center.

## Placing wiper arms in vertical position

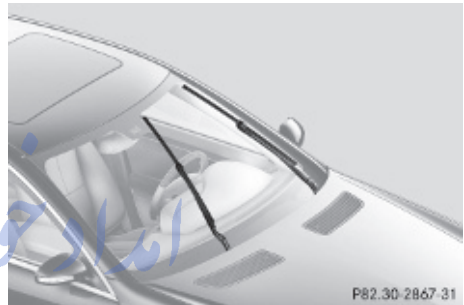

Wiper arms in vertical position

- ▶ Make sure the hood is fully closed.

### Vehicles with SmartKey

- ▶ Turn the SmartKey in the starter switch to position **1**.
- ▶ Turn the combination switch to wiper setting .
- ▶ With wiper arms in vertical position, turn the SmartKey in the starter switch to position **0**.
- ▶ Remove the SmartKey from the starter switch.

### Vehicles with KEYLESS-GO

- ▶ Make sure the vehicle's on-board electronics have status **1**.
- ▶ Turn the combination switch to wiper setting .

- ▶ Press the KEYLESS-GO start/stop button repeatedly until the windshield wipers start.
- ▶ Press the KEYLESS-GO start/stop button when the wiper arms are in a vertical position.

### Removing wiper blades

- ! Do not pull on the wiper blade inserts. They could tear.
- ▶ Fold the wiper arm forward until it snaps into place.



- ▶ Turn the wiper blade in direction of arrow ①.
- ▶ Slide the wiper blade sideways out of the retainer in the direction of arrow ②.

### Installing wiper blades

- ▶ Slide the wiper blade onto the wiper arm until it locks in place.
- ▶ Rotate the wiper blade into a position parallel to the wiper arm.
- ▶ Fold the wiper arm backward to rest on the windshield. Make sure you hold on to the wiper when folding the wiper arm back.

- ! Make sure the wiper blades are installed properly. Improperly installed wiper blades may cause windshield damage.

## Flat tire

### Safety notes

#### ⚠ Warning!

The dimensions of the spare wheel are different from those of the road wheels. As a result, the vehicle handling characteristics change when driving with a spare wheel mounted. Adapt your driving style accordingly.

The spare wheel is for temporary use only. When driving with a spare wheel mounted, ensure proper tire inflation pressure and do not exceed a vehicle speed of 50 mph (80 km/h).

Contact the nearest authorized Mercedes-Benz Center as soon as possible to have the spare wheel replaced with a regular road wheel.

Never operate the vehicle with more than one spare wheel mounted.

Do not switch off the ESC when a spare wheel is mounted.

### Preparing the vehicle

- ▶ Whenever possible, park the vehicle in a safe distance from moving traffic on a hard, flat surface.
- ▶ Turn on the hazard warning flasher.
- ▶ Turn the steering wheel so that the front wheels are in a straight-ahead position.
- ▶ Engage the electronic parking brake.
- ▶ Shift the automatic transmission into park position **P**.
- ▶ Turn off the engine.
- ▶ Remove the SmartKey from the starter switch.

or

- ▶ Vehicles with KEYLESS-GO: Open the driver's door (this puts the starter switch in position **0**, same as with the SmartKey removed from the starter switch). The driver's door can then be closed again.



Open doors only when conditions are safe to do so.

- ▶ Vehicles with KEYLESS-GO: Remove the KEYLESS-GO start/stop button from the starter switch.
- ▶ Have any passenger exit the vehicle at a safe distance from the roadway. Open doors only when conditions are safe to do so.

## Mounting the spare wheel

### Introduction

- ▶ Prepare the vehicle as described (▷ page 508).
- ▶ Take the following out of the vehicle:
  - spare wheel
  - jack
  - vehicle tool kit

For information on where to find the respective items, see “Where will I find ...?” (▷ page 450) and (▷ page 451).

- i** Vehicles without spare wheel are not factory-equipped with the tools required for a wheel change such as a jack or a wheel wrench. Some tools required for a wheel change are specific to your vehicle. Contact an authorized Mercedes-Benz Center to obtain the tools approved for your vehicle. This section describes the wheel change using the tools approved and recommended for your vehicle.

### Lifting the vehicle

#### Warning!

When jacking up the vehicle, only use the jack which has been specifically approved by Mercedes-Benz for your vehicle.

The jack is designed exclusively for jacking up the vehicle at the jack take-up brackets built into both sides of the vehicle. Make sure the jack arm is fully seated in the jack take-up

bracket. The jack must always be vertical when in use, especially on inclines or declines.

The jack is intended only for lifting the vehicle briefly for wheel changes. It is not suited for performing maintenance work under the vehicle. To help avoid personal injury, use the jack only to lift the vehicle during a wheel change.

Never get beneath the vehicle while it is supported by the jack. Keep hands and feet away from the area under the lifted vehicle. Always lower the vehicle onto sufficient capacity jackstands before working under the vehicle.

Always make sure the electronic parking brake is engaged. In addition, block the wheels with wheel chocks or other sizeable objects before raising the vehicle with the jack. Do not disengage the electronic parking brake while the vehicle is raised.

Make sure that the ground on which the vehicle is standing and where you place the jack is solid, level and not slippery. If necessary, use a large underlay. On slippery surfaces, such as tiled floors, you should use a non-slip underlay, for example a rubber mat. Do not use wooden blocks or similar objects to support the jack. Otherwise the jack may not be able to achieve its load-bearing capacity if it is not at its full height.

Never start the engine when the vehicle is raised.

Also observe the notes on the jack.

- ▶ Prevent the vehicle from rolling away by blocking wheels with wheel chocks or other sizeable objects.

When your vehicle is equipped with a wheel chock, it is included with the vehicle tool kit (▷ page 450). For information on setting up the collapsible wheel chock, see (▷ page 450).

When changing a wheel on a level surface:

- ▶ Place a wheel chock or other sizeable object in front of and another wheel chock or other sizeable object behind the wheel that is diagonally opposite to the wheel being changed.

Always try lifting the vehicle using the jack on a level surface. However, should circumstances require you to do so on a hill:

- ▶ Place wheel chocks or other sizeable objects on the downhill side in front of both wheels on the side opposite to the side on which the wheel is to be changed.

#### Warning!

Only jack up the vehicle on level ground or on slight inclines/declines. Otherwise, the vehicle could fall off the jack and injure you or others.

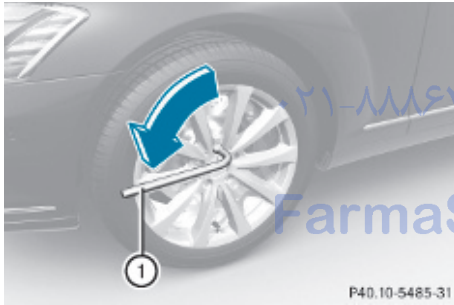

- ▶ On the wheel to be changed, loosen but do not yet remove the wheel bolts (approximately one full turn with wheel wrench ①).

The jack take-up brackets are located directly behind the front wheel housings and in front of the rear wheel housings.

#### Warning!

The jack is designed exclusively for jacking up the vehicle at the jack take-up brackets. Make sure the jack arm is fully seated in the jack take-up bracket.

If you do not position the jack correctly in the jack take-up bracket, the vehicle can fall off the jack and seriously or fatally injure you or others.

- ❗ Do not position the jack on the body of the vehicle, as this may cause damage to the vehicle.

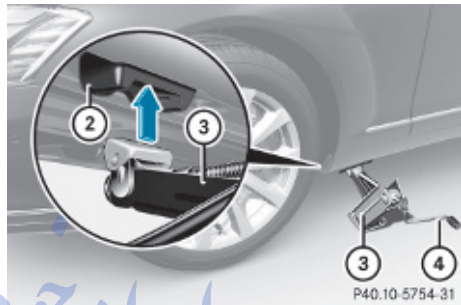

- ▶ Place jack ③ on firm ground.
- ▶ Position jack ③ under take-up bracket ② so that it is always vertical as seen from the side, even if the vehicle is parked on an incline.

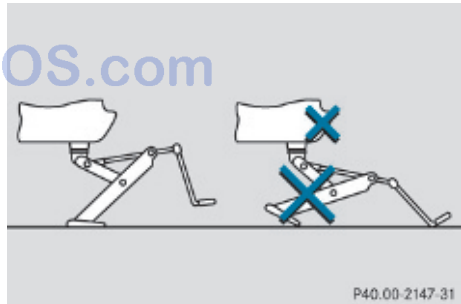

- ▶ Turn crank ④ clockwise until jack ③ is fully seated in take-up bracket ② and the jack base evenly meets the ground.
- ▶ Jack up the vehicle until the wheel is a maximum of 1.2 in (3 cm) from the ground.

## Removing the wheel

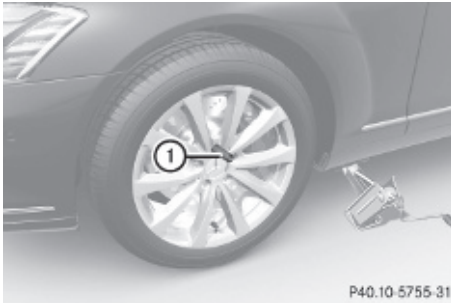

- ▶ Unscrew the uppermost wheel bolt and remove it.
  - ▶ Replace this wheel bolt with alignment bolt ①.
  - ▶ Remove the remaining bolts.
- !** Do not place wheel bolts in sand or dirt. This could result in damage to the wheel bolts and wheel hub threads.
- ▶ Remove the wheel.

## Attaching the spare wheel

### **Warning!**

Always replace wheel bolts that are damaged or rusted.

Never apply oil or grease to wheel bolts.

Damaged wheel hub threads should be repaired immediately. Do not continue to drive under these circumstances! Contact an authorized Mercedes-Benz Center or call Roadside Assistance.

Incorrect wheel bolts or improperly tightened wheel bolts can cause the wheel to come off. This could cause an accident. Make sure to use the correct wheel bolts.

### **Warning!**

Only use genuine Mercedes-Benz wheel bolts. Other wheel bolts may come loose.

Do not tighten the wheel bolts when the vehicle is raised. Otherwise the vehicle could fall off the jack.

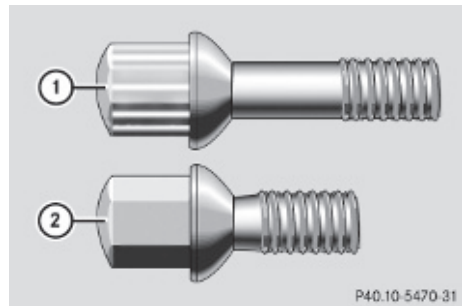

Wheel bolt ① must be used for light alloy rims and the Minispare wheel with light alloy rim. Wheel bolt ② must be used for the Minispare wheel with steel rim. The wheel bolts for the Minispare wheel with steel rim are located in the trunk with the Minispare wheel.

**!** Wheel bolts ① must be used when mounting the Minispare wheel with light alloy rim. The use of any wheel bolts other than wheel bolts ① for the Minispare wheel with light alloy rim will damage the vehicle's brakes.

Wheel bolts ② must be used when mounting the Minispare wheel with steel rim. The use of any wheel bolts other than wheel bolts ② for the Minispare wheel with steel rim will damage the vehicle's brakes.

### **Warning!**

Make sure to use the original length wheel bolts when remounting the original wheel after it has been repaired.

- ▶ Clean contact surfaces of wheel and wheel hub.
- !** To avoid paint damage, place wheel flat against hub and hold it there while installing first wheel bolt.

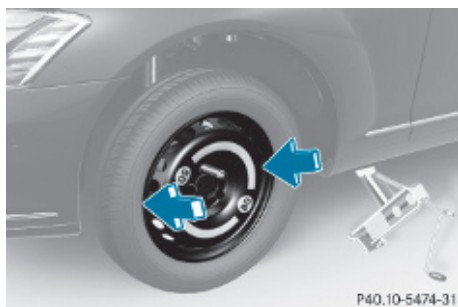

- ▶ Guide the spare wheel onto the alignment bolt and push it on.
- ▶ Insert the wheel bolts and tighten them slightly.
- ▶ Unscrew the alignment bolt.
- ▶ Install the last wheel bolt and tighten it slightly.

### Lowering the vehicle

- ▶ Lower the vehicle by turning the crank counterclockwise until the vehicle is resting fully on its own weight.
- ▶ Remove the jack.



- ▶ Tighten the five wheel bolts evenly, following the diagonal sequence illustrated (① to ⑤), until all bolts are tight. Observe a tightening torque of 110 lb-ft (150 Nm).

#### **Warning!**

Have the tightening torque checked after changing a wheel. The wheels could come

loose if they are not tightened to a torque of 110 lb-ft (150 Nm).

- ▶ Fully collapse the jack, with handle folded in (storage position), see (> page 451).
- ▶ Store the jack and the other vehicle tools in the designated storage space.

For information on storing the spare wheel after it has been replaced by a regular road wheel, see (> page 451).

- i** Do not restart the tire inflation pressure monitor until a full size wheel/tire with functioning sensor has been placed back into service on the vehicle.

## Battery

### Safety notes

A battery should always be sufficiently charged in order to achieve its rated service life. Refer to Maintenance Booklet for battery maintenance intervals.

If you use your vehicle mostly for short-distance trips, you will need to have the battery charge checked more frequently.

When replacing a battery, always use a battery approved by Mercedes-Benz.

If you do not intend to operate your vehicle for an extended period of time, contact an authorized Mercedes-Benz Center about steps you need to observe.

#### **Warning!**

HYBRID vehicles: It is imperative that you read the HYBRID Supplemental Operating Instructions included in your vehicle literature portfolio. You may otherwise not receive all necessary safety information and warning for the operation of your vehicle.

#### **Warning!**

Observe all safety instructions and precautions when handling automotive batteries.



Risk of explosion.



Fire, open flames and smoking are prohibited when handling batteries. Avoid creating sparks.



Battery acid is caustic. Do not allow it to come into contact with skin, eyes or clothing.

Wear suitable protective clothing, especially gloves, apron and faceguard.



Wear eye protection.

Rinse any acid spills immediately with clear water. Contact a physician if necessary.



Keep children away.



Follow the instructions in this Operator's Manual.

A battery contains materials that can harm the environment if disposed of improperly. A large 12 V storage battery contains lead. Recycling of the battery is the preferred method of disposal. Many states (USA only) or provinces (Canada only) require sellers of batteries to accept the old battery for recycling.

#### **Warning!**

Failure to follow these instructions can result in severe injury or death.

Never lean over batteries while connecting. You might get injured.

Battery fluid contains sulfuric acid. Do not allow this fluid to come in contact with eyes, skin or clothing. In case it does, immediately

flush affected area with water and seek medical help if necessary.

A battery will also produce hydrogen gas, which is flammable and explosive. Keep flames or sparks away from battery, avoid improper connection of jumper cables, smoking etc.

#### **Warning!**

Do not place metal objects on the battery as this could result in a short circuit.

Use leak-proof batteries only to avoid the risk of acid burns in the event of an accident.

Take care that you do not become statically charged, e.g. by wearing synthetic clothing or rubbing against textiles. For this reason, you also should not pull or push the battery over carpets or other synthetic materials.

Never touch the battery first. First touch the outside body of the vehicle in order to release any possible electrostatic charges.

Do not rub the battery with rags or cloths. The battery could explode if touched due to electrostatic charge or due to spark formation.

The battery is a Valve-Regulated Lead Acid (VRLA) battery, also referred to as “fleece” battery.

Such batteries do not require topping-up of the electrolyte level. VRLA batteries therefore do not have cell caps and the battery cover is non-removable. Do not attempt to open the battery as otherwise the battery will be damaged.

VRLA batteries do not require topping-up of the electrolyte level. They cannot be opened to check the electrolyte level. However, the battery condition must be checked periodically by performing a battery conductance test. Refer to Maintenance Booklet for battery condition testing intervals.

The factory-equipped battery may only be replaced with a battery that

- has the same security features
- is of identical size
- is of identical voltage
- is of identical capacity

**!** As any other battery, the battery may discharge if you do not operate the vehicle for an extended period of time. Have the battery disconnected at a qualified workshop or an authorized Mercedes-Benz Center in such a case. You may also connect an accessory battery charge unit expressly approved by Mercedes-Benz for your vehicle model to maintain the battery charge. Contact an authorized Mercedes-Benz Center for further information.

The battery, the battery ventilation hose and the lateral plug must always be securely installed when the vehicle is in operation.

**!** Switch off the engine and switch off the vehicle's internal electrical functions before you disconnect or remove the battery's terminal clamps. You could otherwise destroy electronic assemblies such as the generator.

Remove SmartKey from starter switch (vehicles with KEYLESS-GO: Make sure the vehicle's on-board electronics have status **0**) when you turn off the engine and no longer require any electrical consumers. The vehicle then uses very little power and the battery is spared.

If the battery is discharged, you must use the mechanical key to unlock the vehicle.

### Charging the battery

#### Warning!

Never charge a battery while still installed in the vehicle unless the accessory battery

charge unit approved by Mercedes-Benz is being used. Gases may escape during charging and could cause an explosion that may result in personal injury, paint damage or corrosion.

An accessory battery charge unit specially adapted for Mercedes-Benz vehicles and tested and approved by Mercedes-Benz is available. It permits the charging of the battery in its installed position. Contact an authorized Mercedes-Benz Center for information and availability.

Charge battery in accordance with the separate instructions for the accessory battery charger.

Have the battery charged at an authorized Mercedes-Benz Center. If you charge the battery yourself, follow the operating instructions for your charging device. Only use a battery charge unit with a maximum charging voltage of 14.8 V.

► Charge battery in accordance with the instructions of the battery charger manufacturer.

### Jump starting

#### Warning!

Failure to follow these directions will cause damage to the electronic components, and can lead to a battery explosion and severe injury or death.

Never lean over batteries while connecting or jump starting. You might get injured.

Battery fluid contains sulfuric acid. Do not allow this fluid to come in contact with eyes, skin or clothing. In case it does, immediately flush affected area with water, and seek medical help if necessary.

A battery will also produce hydrogen gas, which is flammable and explosive. Keep flames or sparks away from battery, avoid

improper connection of jumper cables, smoking, etc.

Attempting to jump start a frozen battery can result in it exploding, causing personal injury.

Read all instructions before proceeding.

### **Warning!**

HYBRID vehicles: It is imperative that you read the HYBRID Supplemental Operating Instructions included in your vehicle literature portfolio. You may otherwise not receive all necessary safety information and warning for the operation of your vehicle.

**!** Do not tow-start the vehicle. You could otherwise seriously damage the automatic transmission which is not covered by the Mercedes-Benz Limited Warranty.

**!** Jump starting should only be performed using the jump-start terminals located in the engine compartment.

Avoid repeated and lengthy starting attempts.

Do not attempt to start the engine using a battery quick-charge unit.

If the engine does not run after several unsuccessful starting attempts, have it checked at the nearest authorized Mercedes-Benz Center.

Excessive unburned fuel generated by repeated failed starting attempts may damage the catalytic converter and may present a fire risk.

Make sure the jumper cables do not have loose or missing insulation.

Make sure the cable clamps do not touch any other metal part while the other end is still attached to a battery.

If the battery is discharged, the engine can be started with jumper cables and the fully charged battery of another vehicle or an equivalent starter pack. Observe the following:

- Access to the battery is not possible on all vehicles. If you cannot access the battery of the other vehicle, provide jump start power by an external battery or starter pack.
  - Jump starting should only be performed when the engine and catalytic converter are cold.
  - Do not jump start the engine or charge the battery if the battery is frozen. Let the battery thaw out first.
  - Only jump start from batteries with the same voltage rating (12 V). Jump starting with a more powerful battery could damage the vehicle's electrical system. Such damage will not be covered by the Mercedes-Benz Limited Warranty.
  - Only use jumper cables with sufficient cross-section and insulated terminal clamps.
  - Always make sure the jumper cables are not on or near pulleys, fans or other parts that move when an engine is started or running.
  - Should the battery be drained completely, let the donating power source charge the vehicle for several minutes before reattempting the starting process.
- ▶ Make sure the two vehicles do not touch.
  - ▶ Switch off all electrical consumers.
  - ▶ Engage the electronic parking brake.
  - ▶ Make sure the automatic transmission is in park position **P**.
  - ▶ Open the hood (▷ page 404).



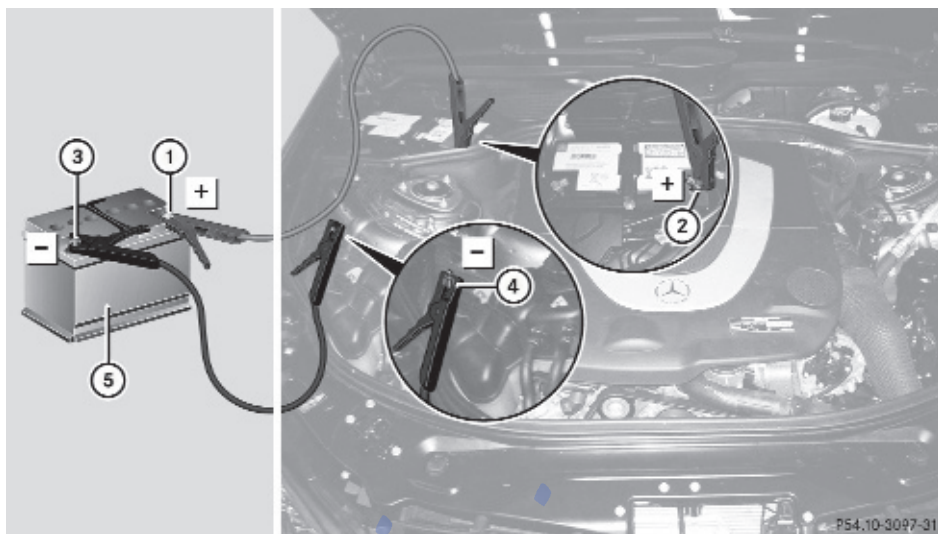

Position ⑤ represents the charged battery of another vehicle or an equivalent starter pack.

**!** Never invert the terminal connections!

- ▶ Connect positive terminal ① of charged battery ⑤ with positive terminal ② with a jumper cable. Clamp the cable to positive terminal ① of charged battery ⑤ first.
- ▶ Start engine of the vehicle with charged battery ⑤ and run at idle speed.
- ▶ Connect negative terminal ③ of charged battery ⑤ with negative terminal ④ with a jumper cable. Clamp the cable to negative terminal ③ of charged battery ⑤ first.
- ▶ Start engine of the vehicle with the discharged battery and run at idle speed. You can now turn on the electrical consumers. Do not switch on the headlamps under any circumstances.
- ▶ Remove the jumper cables from negative terminals ③ and ④ first.

▶ Remove the jumper cables from positive terminals ① and ②.

You can now switch on the headlamps.

▶ Have the battery checked at the nearest authorized Mercedes-Benz Center.

## Towing the vehicle

### Safety notes

#### **!** Warning!

The vehicle is braked when the HOLD function or DISTRONIC PLUS is activated. Therefore, deactivate the HOLD function or DISTRONIC PLUS if the vehicle is to be towed.

Mercedes-Benz recommends that the vehicle be transported with all wheels off the ground using flatbed or appropriate wheel lift/dolly equipment. This method is preferable to other types of towing.

#### **!** Warning!

HYBRID vehicles: It is imperative that you read the HYBRID Supplemental Operating Instructions included in your vehicle literature portfolio. You may otherwise not receive all

necessary safety information and warning for the operation of your vehicle.

- ❗ To prevent damage during transport, do not tie down vehicle by its chassis or suspension parts.

If circumstances do not permit the recommended towing methods, the vehicle may be towed with all wheels on the ground or front axle raised (except vehicles with 4MATIC) only so far as necessary to have the vehicle moved to a safe location where the recommended towing methods can be employed.

- ❗ Before towing the vehicle observe the following instructions:

- Do not tow-start the vehicle. You could otherwise seriously damage the automatic transmission which is not covered by the Mercedes-Benz Limited Warranty.
- Do not tow with sling-type equipment. Towing with sling-type equipment over bumpy roads will damage radiator and supports.
- Towing of the vehicle should only be done using the properly installed towing eye bolt. Never attach a tow cable, tow rope or tow rod to the vehicle chassis, frame or suspension parts.

#### **Warning!**

With the engine not running, there is no power assistance for the brake and steering systems. In this case, it is important to keep in mind that a considerably higher degree of effort is necessary to brake and steer the vehicle. Adapt your driving accordingly.

- ❗ Avoid pulling the vehicle abruptly or diagonally, since it could result in damage to the chassis alignment.

- ❗ Do not use the towing eye bolt for recovery, as this could damage the vehicle. If in doubt, recover the vehicle with a crane.

- i If the battery is disconnected or discharged

- the SmartKey will not turn in the starter switch
- the automatic transmission will remain in park position **P**

For more information see “Battery” (▷ page 512) or “Jump starting” (▷ page 514).

#### **Installing towing eye bolt**

Depending on whether you are towing a vehicle or you are being towed, the towing eye bolt can be screwed into threaded holes which are located behind covers on each bumper.

The towing eye bolt is supplied with the vehicle tool kit, located underneath the trunk floor (▷ page 450).

- ▶ Take the vehicle tool kit out of the trunk.

#### **Removing cover in front bumper**



P00.60.2145.31

- ▶ Press mark on cover ① as indicated by the arrow.
- ▶ Lift cover ① off to reveal the threaded hole for the towing eye bolt.

## Removing cover in rear bumper

### Warning!

In order to avoid possible serious burns or injury, use extreme caution when removing the rear cover, because the rear exhaust pipe is extremely hot.

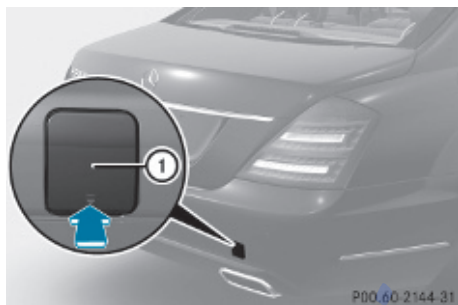

- ▶ Press mark on cover ① as indicated by the arrow.
- ▶ Lift cover ① off to reveal the threaded hole for the towing eye bolt.

## Fixing towing eye bolt



Example illustration front bumper

- ▶ Take the towing eye bolt and, if so equipped, the wheel wrench from the vehicle tool kit (▷ page 450).
- ▶ Screw towing eye bolt ② clockwise into threaded hole to its stop.

- ▶ Insert wheel wrench into towing eye and tighten towing eye bolt ② by turning it clockwise.

or

- ▶ If your vehicle is not equipped with a wheel wrench, use a suitable object to turn the towing eye bolt.

## Removing towing eye bolt

- ▶ Loosen towing eye bolt ② by turning it counterclockwise.
- ▶ Unscrew towing eye bolt ②.
- ▶ **Reinstalling cover:** Fit cover ① (▷ page 517) and snap it into place.
- ▶ Store the towing eye bolt ② and wheel wrench back into the vehicle tool kit.

## Towing with all wheels on the ground

### Warning!

If circumstances require towing the vehicle with all wheels on the ground, always tow with a tow bar if:

- the engine will not run
- there is a malfunction in the brake system
- there is a malfunction in the power supply or in the vehicle's electrical system

This is necessary to adequately control the towed vehicle.

Prior to towing the vehicle with all wheels on the ground, make sure the SmartKey is in starter switch position 2.

### Warning!

With the engine not running, there is no power assistance for the brake and steering systems. In this case, it is important to keep in mind that a considerably higher degree of effort is necessary to brake and steer the vehicle. Adapt your driving accordingly.

- ▶ Make sure the ignition is switched on.
- ▶ With the vehicle at a standstill, depress the brake pedal and keep it pressed.
- ▶ Shift the automatic transmission into neutral position **N**.
- ▶ Release the brake pedal.
- ▶ If engaged, release the electronic parking brake.
- ▶ Switch on the hazard warning flasher (▷ page 302).

**!** Keep in mind that it is important to have the ignition switched on. Removing the SmartKey from the starter switch or opening a front door with the ignition switched off will automatically shift the automatic transmission into park position **P**.

**!** The vehicle may be towed only for distances up to 30 miles (50 km) and at a speed not to exceed 30 mph (50 km/h).

**i** While being towed with the hazard warning flasher in use, use the combination switch in the usual manner to signal turns. Only the selected turn signal will operate. Upon canceling the turn signal, the hazard warning flasher will operate again.

### Towing with front axle raised

**!** The vehicle may be towed only for distances up to 30 miles (50 km) and at a speed not to exceed 30 mph (50 km/h).

**!** Vehicles with 4MATIC: Do not tow with one axle raised. Doing so could damage the transfer case, which is not covered by the Mercedes-Benz Limited Warranty. All wheels must be on or off the ground. Observe instructions for towing the vehicle with all wheels on the ground.

- ▶ Switch off the automatic central locking (▷ page 210).
- ▶ Switch on the hazard warning flasher (▷ page 302).
- ▶ Make sure the automatic transmission remains in neutral position **N**. Observe instructions, see “Remaining in neutral position **N**” (▷ page 319).

**!** Vehicles without 4MATIC:

Because the ESC operates automatically, the engine and ignition must be shut off (SmartKey in starter switch position **0** or **1** or KEYLESS-GO start/stop button in position **0** or **1**) when the vehicle is being towed with one axle raised.

Active braking action through the ESC may otherwise seriously damage the brake system which is not covered by the Mercedes-Benz Limited Warranty.

**!** Keep in mind that it is important for the SmartKey to be left in starter switch with the ignition switched off. As soon as the SmartKey is removed from the starter switch the automatic transmission will shift to park position **P**.

## Fuses

### Introduction

The electrical fuses in your vehicle serve to switch off malfunctioning power circuits. If a fuse is blown, the components and systems secured by that fuse will stop operating.

#### Warning!

Only use fuses approved by Mercedes-Benz with the specified amperage for the system in question and do not attempt to repair or bridge a blown fuse. Using other than approved fuses or using repaired or bridged fuses may cause an overload leading to a fire, and/or cause damage to electrical components and/or systems. Have the cause

determined and remedied by an authorized Mercedes-Benz Center.

- ❗ Switch off the vehicle's internal electrical functions when you are working on the fuses.

A blown fuse must be replaced by an appropriate spare fuse (recognizable by its color or the fuse rating given on the fuse) of the amperage recommended in the fuse chart. Any Mercedes-Benz Center will be glad to advise you on this subject.

- i In case of a blown fuse contact Roadside Assistance or an authorized Mercedes-Benz Center.

If a newly inserted fuse blows again, have the cause determined and rectified by an authorized Mercedes-Benz Center.

The fuse chart is located in the trunk with the vehicle tool kit (▷ page 450). The fuse chart explains the fuse allocation and fuse amperages.

### Before replacing fuses

- ▶ Engage the electronic parking brake.
- ▶ Make sure the automatic transmission is in park position **P**.

The transmission position indicator in the multifunction display should be on **P**.

- ▶ Switch off all electrical consumers.
- ▶ Turn off the engine.

### Fuse box in passenger compartment

- ❗ Do not use sharp objects such as a screwdriver to open the fuse box cover in the dashboard. You could damage the fuse box cover or the dashboard.



Fuse box on driver's side



Fuse box on passenger side

- ▶ Open the respective door.
- ▶ Using your hands, pull cover ① in direction of arrow and remove it.
- ▶ **Closing:** Hook fuse box cover ① into the opening at the front.

- ❗ The fuse box cover must be properly positioned as described. Otherwise, moisture or dirt could enter the fuse box and possibly impair fuse operation.

## Fuse box in the rear passenger compartment

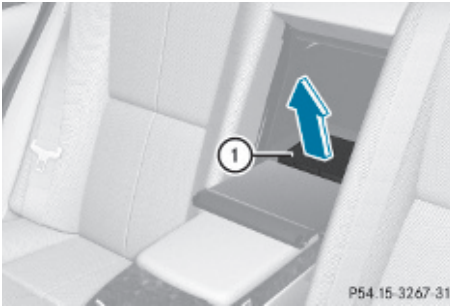

- ▶ **Opening:** Swing down center armrest.
- ▶ Open cover behind center armrest.
- ▶ Pull cover (1) forward in direction of arrow.
- ▶ **Closing:** Press cover (1) backward and engage.

❗ Make sure the seal in the cover is not damaged during opening or closing.

- ▶ Loosen screws (1) with crank.
- ▶ Remove bracket (3).
- ▶ Remove fuse box cover (2).
- ▶ **Installing cover:** Attach fuse box cover (2).
- ▶ Attach bracket (3).
- ▶ Tighten screws (1) with crank.

❗ The fuse box cover must be properly positioned as described. Otherwise, moisture or dirt could enter the fuse box and possibly impair fuse operation.

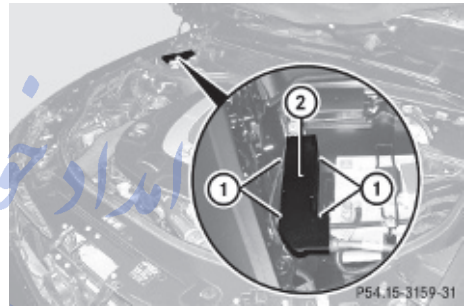

Example illustration fuse box on passenger side

- ▶ **Removing cover:** Press retaining lugs (1).
- ▶ Remove fuse box cover (2).
- ▶ **Installing cover:** Attach fuse box cover (2).
- ▶ Press fuse box cover (2) down.

❗ The fuse box cover must be properly positioned as described. Otherwise, moisture or dirt could enter the fuse box and possibly impair fuse operation.

- ▶ Close the hood after checking or replacing fuses.

## Fuse box in engine compartment

The fuse boxes are located in the engine compartment on the driver's and passenger side.

- ▶ Open the hood.

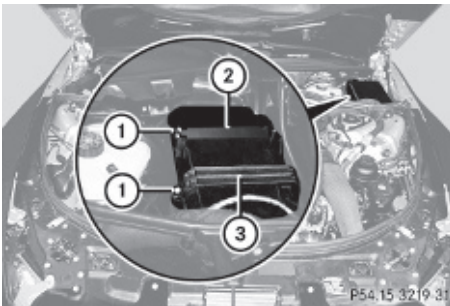

Fuse box on driver's side

- ▶ S 63 AMG: Remove the control box above the fuse box.
- ▶ **Removing cover:** Take the crank from the Operator's Manual pouch.

## Emergency engine shutdown

If the engine cannot be turned off as described (▷ page 316), you may use the following emergency procedure.

- ▶ Take the fuse chart from the vehicle tool kit (▷ page 450).
- ▶ Find row “Emergency engine shutdown” in the fuse chart table to identify the fuses that have to be removed as well as their locations.
- ▶ Remove the respective fuses.

امداد خودرو فارما

تلفن شبانه روزی: ۰۲۱-۸۸۸۶۲۰۸۵

FarmaSOS.com



Vehicle equipment .....	524
Parts service .....	524
Warranty coverage .....	524
Identification labels .....	524
Vehicle specification S 450 4MATIC (221.084) .....	527
Vehicle specification S 550 (221.171) .....	527
Vehicle specification S 550 4MATIC (221.186) .....	528
Vehicle specification S 600 (221.176) .....	529
Vehicle specification S 63 AMG (221.177) .....	530
Vehicle specification S 65 AMG (221.179) .....	531
Rims and tires .....	532
Fuels, coolants, lubricants, etc. ....	537

ایم آر ایدو فارما

تلفن شبانه روزی: ۰۲۱-۸۸۸۶۲۰۸۵

FarmaSOS.com



## Vehicle equipment

**i** This Operator's Manual describes all features, standard or optional, potentially available for your vehicle at the time of purchase. Please be aware that your vehicle might not be equipped with all features described in this manual.

## Parts service

All authorized Mercedes-Benz Centers maintain a stock of Genuine Mercedes-Benz Parts required for maintenance and repair work. In addition, strategically located parts distribution centers provide quick and reliable parts service.

More than 300 000 different parts for Mercedes-Benz models are available.

Genuine Mercedes-Benz Parts are subjected to stringent quality inspections. Each part has been specifically developed, manufactured or selected for and adapted to Mercedes-Benz vehicles.

Therefore, Genuine Mercedes-Benz Parts should be installed.

**!** Do not use non-genuine Mercedes-Benz parts and accessories not authorized by Mercedes-Benz. Doing so could damage the vehicle, which is not covered by the Mercedes-Benz Limited Warranty. Also, it could compromise the vehicle's durability or safety.

## Warranty coverage

Your vehicle is covered under the terms of the warranties printed in the Service and Warranty Information booklet.

Your authorized Mercedes-Benz Center will exchange or repair any defective parts originally installed in the vehicle in accordance with the terms of the following warranties:

- New Vehicle Limited Warranty
- Emission System Warranty
- Emission Performance Warranty
- California, Connecticut, Maine, Massachusetts, New York, Pennsylvania, Rhode Island, and Vermont Emission Control Systems Warranty
- State Warranty Enforcement Laws (Lemon Laws)

Replacement parts and accessories are covered by the Mercedes-Benz Parts and Accessories warranties, copies of which are available at any authorized Mercedes-Benz Center.

## Loss of Service and Warranty Information booklet

Should you lose your Service and Warranty Information booklet, have an authorized Mercedes-Benz Center arrange for a replacement. It will be mailed to you.

## Identification labels



P30.00-2010-31

The Vehicle Identification Number (VIN) can be found

- on certification label ① on the driver's door B-pillar
- embossed underneath a cover behind the rear center armrest (▷ page 525)
- on the lower edge of the windshield (▷ page 525)

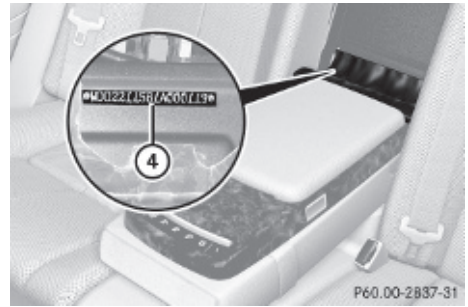

Rear center armrest

- ▶ Fold down the rear center armrest.

The VIN is embossed underneath a cover behind the rear center armrest.

- ▶ Open the cover.  
VIN ④ is now visible.

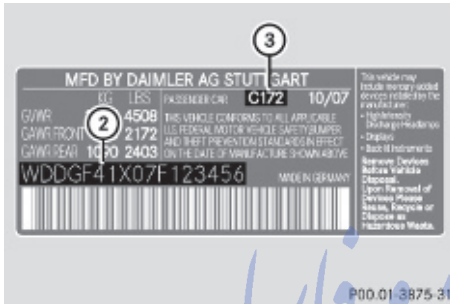

Example certification label (U.S. vehicles)

- ② VIN
- ③ Paintwork code

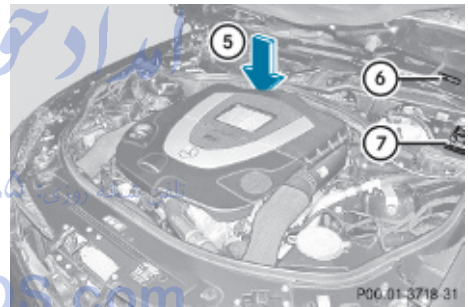

All models except AMG vehicles

- ⑤ Engine number (engraved on engine)
- ⑥ VIN (on lower edge of windshield)
- ⑦ Emission control information label, includes both federal and California certification exhaust emission standards



Example certification label (Canada vehicles)

- ② VIN
- ③ Paintwork code

**i** Data shown on certification label are for illustration purposes only. These data are specific to each vehicle and may vary from data shown in the illustration. Refer to certification label on vehicle for actual data specific to your vehicle.

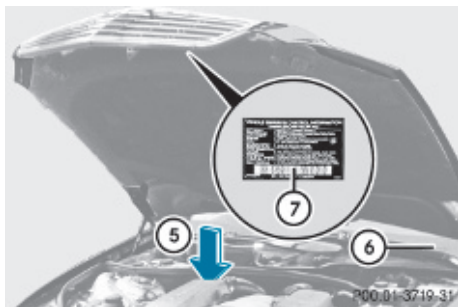

- i** When ordering parts, please specify vehicle identification and engine number.

AMG vehicles

- ⑤ Engine number (engraved on engine)
- ⑥ VIN (on lower edge of windshield)
- ⑦ Emission control information label, includes both federal and California certification exhaust emission standards

امداد خودرو فارما

تلفن شبانه روزی: ۰۲۱-۸۸۸۶۲۰۸۵

FarmaSOS.com

**Vehicle specification S 450 4MATIC  
(221.084)**

The quoted data apply only to the standard vehicle. Contact an authorized Mercedes-Benz Center for the corresponding data of all special bodies and special equipment.

**i** The S 450 4MATIC is available in Canada only.

<b>Engine S 450 4MATIC</b>	
<b>Engine, type</b>	273
<b>Mode of operation</b>	4-stroke engine, gasoline injection
<b>No. of cylinders</b>	8
<b>Bore</b>	3.66 in (92.90 mm)
<b>Stroke</b>	3.39 in (86.00 mm)
<b>Total piston displacement</b>	284.6 cu in (4 663 cm <sup>3</sup> )
<b>Compression ratio</b>	10.5:1
<b>Output acc. to SAE J 1349<sup>46</sup></b>	335 hp/6 000 rpm (250 kW/6 000 rpm)
<b>Maximum torque acc. to SAE J 1349</b>	339 lb-ft/ 2 700 - 5 000 rpm (460 Nm/ 2 700 - 5 000 rpm)
<b>Maximum engine speed</b>	6 500 rpm
<b>Firing order</b>	1-5-4-2-6-3-7-8
<b>Poly-V-belt</b>	2 404 mm

**Electrical system S 450 4MATIC**

<b>Alternator</b>	14 V/180 A
<b>Starter motor</b>	12 V/1.7 kW

**Electrical system S 450 4MATIC**

<b>Battery</b>	12 V/95 Ah
<b>Spark plugs, type</b>	NGK PLKR 6A
	Bosch Y 7 MPP33
<b>Spark plugs, electrode gap</b>	0.031 in (0.8 mm)
<b>Spark plugs, tightening torque</b>	15 - 18 lb-ft (20 - 25 Nm)

**Main dimensions S 450 4MATIC**

<b>Overall vehicle length</b>	200.1 in (5 100 mm)
<b>Overall vehicle width<sup>47</sup></b>	83.5 in (2 120 mm)
<b>Overall vehicle height</b>	58.2 in (1 479 mm)
<b>Wheelbase</b>	119.5 in (3 035 mm)
<b>Track, front</b>	63.0 in (1 600 mm)
<b>Track, rear</b>	63.2 in (1 606 mm)
<b>Turning circle</b>	38.7 ft (11.8 m)

**Weights S 450 4MATIC**

<b>Roof load</b>	max. 220 lb (100 kg)
<b>Trunk load</b>	max. 220 lb (100 kg)

**Vehicle specification S 550 (221.171)**

The quoted data apply only to the standard vehicle. Contact an authorized Mercedes-Benz Center for the corresponding data of all special bodies and special equipment.

**i** The S 550 is available in the USA only.

<sup>46</sup> Premium fuel required. Performance may vary with fuel octane rating.

<sup>47</sup> Exterior rear view mirrors folded out.

Engine S 550	
Engine, type	273
Mode of operation	4-stroke engine, gasoline injection
No. of cylinders	8
Bore	3.86 in (98.00 mm)
Stroke	3.56 in (90.50 mm)
Total piston displacement	333.3 cu in (5 461 cm <sup>3</sup> )
Compression ratio	10.7:1
Output acc. to SAE J 1349 <sup>48</sup>	382 hp/6 000 rpm (285 kW/6 000 rpm)
Maximum torque acc. to SAE J 1349	391 lb-ft/3 000 rpm (530 Nm/3 000 rpm)
Maximum engine speed	6 500 rpm
Firing order	1-5-4-2-6-3-7-8
Poly-V-belt	2 404 mm

Electrical system S 550	
Alternator	14 V/180 A
Starter motor	12 V/1.7 kW
Battery	12 V/95 Ah
Spark plugs, type	NGK PLKR 6A
	Bosch Y 7 MPP33
Spark plugs, electrode gap	0.031 in (0.8 mm)
Spark plugs, tightening torque	15 - 18 lb-ft (20 - 25 Nm)

Main dimensions S 550	
Overall vehicle length	206.7 in (5 250 mm)
Overall vehicle width <sup>49</sup>	83.5 in (2 120 mm)
Overall vehicle height	58.2 in (1 479 mm)
Wheelbase	124.6 in (3 165 mm)
Track, front	63.0 in (1 600 mm)
Track, rear	63.2 in (1 606 mm)
Turning circle	40.0 ft (12.2 m)

Weights S 550	
Roof load	max. 220 lb (100 kg)
Trunk load	max. 220 lb (100 kg)

### Vehicle specification S 550 4MATIC (221.186)

The quoted data apply only to the standard vehicle. Contact an authorized Mercedes-Benz Center for the corresponding data of all special bodies and special equipment.

Engine S 550 4MATIC	
Engine, type	273
Mode of operation	4-stroke engine, gasoline injection
No. of cylinders	8
Bore	3.86 in (98.00 mm)
Stroke	3.56 in (90.50 mm)
Total piston displacement	333.3 cu in (5 461 cm <sup>3</sup> )

<sup>48</sup> Premium fuel required. Performance may vary with fuel octane rating.

<sup>49</sup> Exterior rear view mirrors folded out.

Engine S 550 4MATIC	
Compression ratio	10.5:1
Output acc. to SAE J 1349 <sup>50</sup>	382 hp/6 000 rpm (285 kW/6 000 rpm)
Maximum torque acc. to SAE J 1349	391 lb-ft/ 2 800 - 4 800 rpm (530 Nm/ 2 800 - 4 800 rpm)
Maximum engine speed	6 500 rpm
Firing order	1-5-4-2-6-3-7-8
Poly-V-belt	2 404 mm

Electrical system S 550 4MATIC	
Alternator	14 V/180 A
Starter motor	12 V/1.7 kW
Battery	12 V/95 Ah
Spark plugs, type	NGK PLKR 6A Bosch Y 7 MPP33
Spark plugs, electrode gap	0.031 in (0.8 mm)
Spark plugs, tightening torque	15 - 18 lb-ft (20 - 25 Nm)

Main dimensions S 550 4MATIC	
Overall vehicle length	206.7 in (5 250 mm)
Overall vehicle width <sup>51</sup>	83.5 in (2 120 mm)
Overall vehicle height	58.2 in (1 479 mm)

Main dimensions S 550 4MATIC	
Wheelbase	124.6 in (3 165 mm)
Track, front	63.0 in (1 600 mm)
Track, rear	63.2 in (1 606 mm)
Turning circle	40.0 ft (12.2 m)

Weights S 550 4MATIC	
Roof load	max. 220 lb (100 kg)
Trunk load	max. 220 lb (100 kg)

### Vehicle specification S 600 (221.176)

The quoted data apply only to the standard vehicle. Contact an authorized Mercedes-Benz Center for the corresponding data of all special bodies and special equipment.

Engine S 600	
Engine, type	275
Mode of operation	4-stroke engine, gasoline injection
No. of cylinders	12
Bore	3.23 in (82.00 mm)
Stroke	3.43 in (87.00 mm)
Total piston displacement	336.4 cu in (5 513 cm <sup>3</sup> )
Compression ratio	9.0:1
Output acc. to SAE J 1349 <sup>52</sup>	510 hp/5 000 rpm (380 kW/5 000 rpm)

<sup>50</sup> Premium fuel required. Performance may vary with fuel octane rating.

<sup>51</sup> Exterior rear view mirrors folded out.

<sup>52</sup> Premium fuel required. Performance may vary with fuel octane rating.



Engine S 600	
Maximum torque acc. to SAE J 1349	612 lb-ft/ 1 800 - 3 500 rpm (830 Nm/ 1 800 - 3 500 rpm)
Maximum engine speed	5 950 rpm
Firing order	1-12-5-8-3-10- 6-7-2-11-4-9
Poly-V-belt	2 370 mm

Electrical system S 600	
Alternator	14 V/220 A
Starter motor	12 V/2.0 kW
Battery	12 V/95 Ah
Spark plugs, type	NGK IFR 6Q-G
Spark plugs, electrode gap	0.028 in (0.7 mm)
Spark plugs, tightening torque	15 - 22 lb-ft (20 - 30 Nm)

Main dimensions S 600	
Overall vehicle length	206.7 in (5 250 mm)
Overall vehicle width <sup>53</sup>	83.5 in (2 120 mm)
Overall vehicle height	58.2 in (1 479 mm)
Wheelbase	124.6 in (3 165 mm)
Track, front	63.0 in (1 600 mm)
Track, rear	63.2 in (1 606 mm)
Turning circle	40.0 ft (12.2 m)

Weights S 600	
Roof load	max. 220 lb (100 kg)
Trunk load	max. 220 lb (100 kg)

### Vehicle specification S 63 AMG (221.177)

The quoted data apply only to the standard vehicle. Contact an authorized Mercedes-Benz Center for the corresponding data of all special bodies and special equipment.

Engine S 63 AMG	
Engine, type	156
Mode of operation	4-stroke engine, gasoline injection
No. of cylinders	8
Bore	4.02 in (102.20 mm)
Stroke	3.72 in (94.60 mm)
Total piston displacement	378.8 cu in (6 208 cm <sup>3</sup> )
Compression ratio	11.3:1
Output acc. to SAE J 1349 <sup>54</sup>	518 hp/6 800 rpm (386 kW/6 800 rpm)
Maximum torque acc. to SAE J 1349	465 lb-ft/5 200 rpm (630 Nm/5 200 rpm)
Maximum engine speed	7 200 rpm
Firing order	1-5-4-2-6-3-7-8
Poly-V-belt	2 360 mm

<sup>53</sup> Exterior rear view mirrors folded out.

<sup>54</sup> Premium fuel required. Performance may vary with fuel octane rating.

Electrical system S 63 AMG	
Alternator	14 V/220 A
Starter motor	12 V/2.1 kW
Battery	12 V/95 Ah
Spark plugs, type	NGK ILZKAR 7A10
Spark plugs, electrode gap	0.039 in (1.0 mm)
Spark plugs, tightening torque	15 - 18 lb-ft (20 - 25 Nm)

Main dimensions S 63 AMG	
Overall vehicle length	207.1 in (5 261 mm)
Overall vehicle width <sup>55</sup>	83.5 in (2 120 mm)
Overall vehicle height	58.7 in (1 490 mm)
Wheelbase	124.6 in (3 165 mm)
Track, front	63.0 in (1 600 mm)
Track, rear	63.2 in (1 606 mm)
Turning circle	40.0 ft (12.2 m)

Weights S 63 AMG	
Roof load	max. 220 lb (100 kg)
Trunk load	max. 220 lb (100 kg)

### Vehicle specification S 65 AMG (221.179)

The quoted data apply only to the standard vehicle. Contact an authorized Mercedes-Benz Center for the corresponding data of all special bodies and special equipment.

<sup>55</sup> Exterior rear view mirrors folded out.

<sup>56</sup> Premium fuel required. Performance may vary with fuel octane rating.

Engine S 65 AMG	
Engine, type	275
Mode of operation	4-stroke engine, gasoline injection
No. of cylinders	12
Bore	3.25 in (82.60 mm)
Stroke	3.66 in (93.00 mm)
Total piston displacement	364.9 cu in (5 980 cm <sup>3</sup> )
Compression ratio	9.0:1
Output acc. to SAE J 1349 <sup>56</sup>	603 hp/ 4 800 - 5 100 rpm (450 kW/ 4 800 - 5 100 rpm)
Maximum torque acc. to SAE J 1349	738 lb-ft/ 2 000 - 4 000 rpm (1 000 Nm/ 2 000 - 4 000 rpm)
Maximum engine speed	5 950 rpm
Firing order	1-12-5-8-3-10- 6-7-2-11-4-9
Poly-V-belt	2 370 mm

Electrical system S 65 AMG	
Alternator	14 V/220 A
Starter motor	12 V/1.7 kW
Battery	12 V/95 Ah
Spark plugs, type	NGK IFR 6Q-G

### Electrical system S 65 AMG

Spark plugs, electrode gap	0.028 in (0.7 mm)
----------------------------	-------------------

Spark plugs, tightening torque	15 - 22 lb-ft (20 - 30 Nm)
--------------------------------	-------------------------------

### Main dimensions S 65 AMG

Overall vehicle length	207.1 in (5 261 mm)
------------------------	---------------------

Overall vehicle width <sup>57</sup>	83.5 in (2 120 mm)
-------------------------------------	--------------------

Overall vehicle height	58.7 in (1 490 mm)
------------------------	--------------------

Wheelbase	124.6 in (3 165 mm)
-----------	---------------------

Track, front	63.0 in (1 600 mm)
--------------	--------------------

Track, rear	63.2 in (1 606 mm)
-------------	--------------------

Turning circle	40.0 ft (12.2 m)
----------------	------------------

### Weights S 65 AMG

Roof load	max. 220 lb (100 kg)
-----------	----------------------

Trunk load	max. 220 lb (100 kg)
------------	----------------------

## Rims and tires

### Notes

**!** Only use tires which have been tested and approved by Mercedes-Benz. Tires approved by Mercedes-Benz are developed to provide best possible performance in conjunction with the driving safety systems on your vehicle such as the ABS or the ESC. Tires specially developed for your vehicle and tested and approved by Mercedes-

Benz can be identified by finding the following on the tire's sidewall:

- MO = Mercedes-Benz Original equipment tires

Using tires other than those approved by Mercedes-Benz may result in damage that is not covered by the Mercedes-Benz Limited Warranty.

**!** Using tires other than those approved by Mercedes-Benz can have detrimental effects, such as

- poor handling characteristics
- increased noise
- increased fuel consumption

Moreover, tires and rims not approved by Mercedes-Benz may, under load, exhibit dimensional variations and different tire deformation characteristics that could cause them to come into contact with the vehicle body or axle parts. Damage to the tires or the vehicle may be the result.

**i** Further information on tires and rims is available at any authorized Mercedes-Benz Center. The Tire and Loading Information placard with the recommended tire inflation pressures for cold tires is located on the driver's door B-pillar. Supplemental tire inflation pressure information for driving at high speeds or for vehicle loads less than the maximum loaded vehicle condition can be found on the tire inflation pressure label. The tire inflation pressure label is located on the inside of the fuel filler flap. The tire inflation pressure should be checked regularly and should only be adjusted on cold tires. Follow tire manufacturer's maintenance recommendation included with the vehicle.



For information on recommended tire inflation pressure and supplemental tire inflation pressure information for special driving situations, see (▷ page 411).



<sup>57</sup> Exterior rear view mirrors folded out.

- i** Please keep in mind that the vehicle must be equipped
- with wheels of identical dimensions on each axle (left and right)
  - with tires of identical characteristics all around, i.e. summer tires, winter tires, or all-season tires etc.
- i** The following pages also list the approved rim and tire sizes for equipping your vehicle with winter tires. Winter tires are not

available as standard or optional factory equipment, but can be purchased from an authorized Mercedes-Benz Center. Equipping your vehicle with winter tires approved for your vehicle model may require the purchase of rims of the recommended size for use with these winter tires. This depends on vehicle model and the standard or optional factory-equipped wheel rim/tire configuration on your vehicle. For more information contact an authorized Mercedes-Benz Center.

### Same size tires

		S 450 4MATIC <sup>58</sup> S 550 <sup>59</sup> S 550 4MATIC	S 600
18" wheels	Rims (light alloy) Wheel offset	8.5 J x 18 H2 1.69 in (43 mm)	8.5 J x 18 H2 1.69 in (43 mm)
	All-season tires <sup>60</sup>	255/45 R18 99H M+S	—
	Winter tires <sup>60,61,62</sup>	255/45 R18 99V M+S 	255/45 R18 99V M+S 

		S 450 4MATIC <sup>58</sup> S 550 4MATIC	S 600
19" wheels	Rims (light alloy) Wheel offset	8.5 J x 19 H2 1.69 in (43 mm)	8.5 J x 19 H2 1.69 in (43 mm)
	All-season tires <sup>60</sup>	255/40 R19 100V XL (Extra Load) M+S	—
	Winter tires <sup>60,61,62</sup>	255/40 R19 100V XL (Extra Load) M+S 	255/40 R19 100V XL (Extra Load) M+S 

<sup>58</sup> Canada only.

<sup>59</sup> USA only.

<sup>60</sup> Radial-ply tires.

<sup>61</sup> For use with snow chains contact an authorized Mercedes-Benz Center.

<sup>62</sup> Not available as factory equipment.

		<b>S 450 4MATIC (AMG Sport Package)<sup>58</sup></b> <b>S 550 4MATIC (AMG Sport Package)</b>
19" wheels	<b>AMG rims (light alloy)</b>	8.5 J x 19 H2
	<b>Wheel offset</b>	1.69 in (43 mm)
	<b>All-season tires<sup>60</sup></b>	255/40 R19 100V XL (Extra Load) M+S
	<b>Winter tires<sup>60,61,62</sup></b>	255/40 R19 100V XL (Extra Load) M+S 

		<b>S 63 AMG</b> <b>S 63 AMG (Performance Package)</b> <b>S 65 AMG</b>
19" wheels	<b>AMG rims (light alloy)</b>	8.5 J x 19 H2
	<b>Wheel offset</b>	1.69 in (43 mm)
	<b>Winter tires<sup>60,61,62</sup></b>	255/40 R19 100V XL (Extra Load) M+S 

امداد خودرو فارما

تلفن شبانه روزی: ۰۲۱-۸۸۸۶۲۰۸۵

FarmaSOS.com

<sup>58</sup> Canada only.

<sup>60</sup> Radial-ply tires.

<sup>61</sup> For use with snow chains contact an authorized Mercedes-Benz Center.

<sup>62</sup> Not available as factory equipment.



Mixed size tires				
				<b>S 550<sup>63</sup></b> <b>S 600<sup>63</sup></b>
18" wheels	Front axle	Rims (light alloy)	8.5 J x 18 H2	
		Wheel offset	1.69 in (43 mm)	
		All-season tires <sup>64</sup>	255/45 R18 99H M+S	
	Rear axle	Rims (light alloy)	9.5 J x 18 H2	
		Wheel offset	1.69 in (43 mm)	
		All-season tires <sup>64,65</sup>	275/45 R18 103H M+S	
				<b>S 550<sup>63</sup></b> <b>S 600</b>
19" wheels	Front axle	Rims (light alloy)	8.5 J x 19 H2	
		Wheel offset	1.69 in (43 mm)	
		All-season tires <sup>64</sup>	255/40 R19 100V XL (Extra Load) M+S	
	Rear axle	Rims (light alloy)	9.5 J x 19 H2	
		Wheel offset	1.69 in (43 mm)	
		All-season tires <sup>64,65</sup>	275/40 R19 101V M+S	
				<b>S 550 (AMG Sport Package)</b> <b>S 600 (AMG Sport Package)<sup>66</sup></b>
19" wheels	Front axle	AMG rims (light alloy)	8.5 J x 19 H2	
		Wheel offset	1.69 in (43 mm)	
		All-season tires <sup>64</sup>	255/40 R19 100V XL (Extra Load) M+S	
	Rear axle	AMG rims (light alloy)	9.5 J x 19 H2	
		Wheel offset	1.69 in (43 mm)	
		All-season tires <sup>64,65</sup>	275/40 R19 101V M+S	

<sup>63</sup> USA only.

<sup>64</sup> Radial-ply tires.

<sup>65</sup> Must not be used with snow chains.

<sup>66</sup> Canada only.

			S 63 AMG S 65 AMG
19" wheels	Front axle	AMG rims (light alloy)	8.5 J x 19 H2
		Wheel offset	1.69 in (43 mm)
	Winter tires <sup>64,67</sup>		255/40 R19 100V XL (Extra Load) M+S 
	Rear axle	AMG rims (light alloy)	9.5 J x 19 H2
Wheel offset		1.69 in (43 mm)	
		Winter tires <sup>64,65,67</sup>	275/40 R19 105V XL (Extra Load) M+S 

			S 63 AMG S 63 AMG (Performance Package) S 65 AMG
20" wheels	Front axle	AMG rims (light alloy)	8.5 J x 20 H2
		Wheel offset	1.69 in (43 mm)
	Summer tires <sup>64</sup>		255/35 ZR20 XL (Extra Load)
	Rear axle	AMG rims (light alloy)	9.5 J x 20 H2
Wheel offset		1.69 in (43 mm)	
		Summer tires <sup>64,65</sup>	275/35 ZR20 XL (Extra Load)

### Spare wheel

**!** Compare the recommended tire inflation pressure for your vehicle with the tire inflation pressure on the yellow label located on the spare wheel rim.

If the tire inflation pressure on the yellow label on the spare wheel rim differs from the values given in this Operator's Manual, inflate the tire to the recommended tire inflation pressure given on the yellow label on the spare wheel rim.

**i** Please note that the tire inflation pressure of the spare wheel differs from the tire inflation pressure of the road tires.

<sup>64</sup> Radial-ply tires.

<sup>67</sup> Not available as factory equipment.

<sup>65</sup> Must not be used with snow chains.



	All models (except AMG vehicles)	S 63 AMG S 63 AMG (Performance Package) S 65 AMG
Rim (steel)	4.5 B x 19 H2	—
Rim (light alloy)	—	4.5 B x 19 H2
Wheel offset	1.38 in (35 mm)	1.38 in (35 mm)
Minispare tire <sup>68</sup>	T 155/70 R19 113M	T 155/70 R19 113M
Recommended tire inflation pressure	61 psi (4.2 bar)	61 psi (4.2 bar)

## Fuels, coolants, lubricants, etc.

### Capacities

Vehicle components and their respective lubricants must match. Therefore only use products tested and approved by Mercedes-Benz.

For information on tested and approved products, contact an authorized Mercedes-Benz Center or visit [www.mbusa.com](http://www.mbusa.com) (USA only).

fluids. Otherwise you could endanger persons or the environment.

Keep service fluids out of the reach of children.

For health reasons, you should prevent service fluids from coming into direct contact with your skin or clothing.

If a service fluid is swallowed, contact a physician immediately.

### Warning!

Comply with all valid regulations with respect to handling, storing, and disposing of service

	Model	Capacity	Fuels, coolants, lubricants, etc.
Engine with oil filter	S 450 4MATIC <sup>69</sup> S 550 <sup>70</sup> S 550 4MATIC	9.0 US qt (8.5 l)	Approved engine oils
	S 600 S 65 AMG	9.5 US qt (9.0 l)	
	S 63 AMG <sup>71</sup>	9.9 US qt (9.35 l)	

<sup>68</sup> Must not be used with snow chains.

<sup>69</sup> Canada only.

<sup>70</sup> USA only.

<sup>71</sup> Engine with oil cooler.

	Model	Capacity	Fuels, coolants, lubricants, etc.
<b>Automatic transmission</b>	S 450 4MATIC <sup>69</sup> S 550 4MATIC	10.6 US qt (10.0 l)	MB Automatic Transmission Fluid
	S 550 <sup>70</sup>	9.8 US qt (9.3 l)	
	S 600	7.9 US qt (7.5 l)	
	S 63 AMG <sup>72</sup>	9.25 US qt (8.75 l)	
	S 65 AMG	9.2 US qt (8.7 l)	
<b>Rear axle</b>	S 450 4MATIC <sup>69</sup> S 550 4MATIC	1.9 US qt (1.8 l)	Hypoid gear oil (SAE 85W-90)
	S 550 <sup>70</sup>	1.3 US qt (1.2 l)	
	S 600	2.1 US qt (2.0 l)	
	S 63 AMG	1.3 US qt (1.2 l)	Fuchs Titan EG 5010 D
	S 65 AMG	1.7 US qt (1.6 l)	
<b>Hydraulic system for active body control (ABC)</b>	S 550 <sup>70</sup> S 600 S 63 AMG S 65 AMG	4.2 US qt (4.0 l)	MB ABC Fluid
<b>Power steering</b>	S 450 4MATIC <sup>69</sup> S 550 <sup>70</sup> S 550 4MATIC S 63 AMG	approx. 1.1 US qt (1.0 l)	MB Power Steering Fluid (Chevron Texaco PSF 9109)
	S 600 S 65 AMG	approx 1.3 US qt (1.2 l)	
<b>Brake system</b>	All models	0.63 US qt (0.6 l)	MB Brake Fluid (DOT 4+)
<b>Cooling system, vehicles without rear climate control</b>	S 450 4MATIC <sup>69</sup>	approx. 15.6 US qt (14.8 l)	MB 325.0 Anticorrosion/Antifreeze
	S 550 <sup>70</sup> S 550 4MATIC	approx. 12.2 US qt (11.5 l)	

<sup>69</sup> Canada only.

<sup>70</sup> USA only.

<sup>72</sup> Automatic transmission with oil cooler.

	Model	Capacity	Fuels, coolants, lubricants, etc.
<b>Cooling system, vehicles with rear climate control</b>	S 450 4MATIC <sup>69</sup>	approx. 17.1 US qt (16.2 l)	
	S 550 <sup>70</sup> S 550 4MATIC	approx. 13.8 US qt (13.1 l)	
	S 600 S 65 AMG	approx. 15.9 US qt (15.0 l)	
	S 63 AMG	approx. 11.8 US qt (11.2 l)	
	S 600 S 65 AMG	approx. 2.8 US qt (2.6 l) approx. 3.3 US qt (3.1 l)	
<b>Low temperature cooling system</b>			
<b>Fuel tank</b>	All models	23.8 US gal (90.0 l)	Premium unleaded gasoline (Minimum Posted Octane 91 [Avg. of 96 RON/86 MON])
<b>Fuel tank reserve</b>	S 450 4MATIC <sup>69</sup> S 550 <sup>70</sup> S 550 4MATIC S 600	approx. 2.9 US gal (11.0 l)	
	S 63 AMG S 65 AMG	approx. 3.7 US gal (14.0 l)	
	All models	—	
<b>Air conditioning system</b>	All models	—	R134a refrigerant and special PAG lubricant oil (never R 12)
<b>Washer system and headlamp cleaning system</b>	All models	6.9 US qt (6.5 l)	MB Windshield Washer Concentrate <sup>73</sup> (▷ page 544) Washer fluid mixing ratio (▷ page 544)

### Approved engine oils

Engine oils are specifically tested for their suitability in our engines and durability for our service intervals. Therefore, only use approved engine oils and oil filters required for vehicles with the Maintenance System.

For a listing of approved engine oils and oil filters, contact an authorized Mercedes-Benz Center or visit [www.mbusa.com](http://www.mbusa.com) (USA only).

**!** Using engine oils and oil filters of a specification other than those expressly

<sup>69</sup> Canada only.

<sup>70</sup> USA only.

<sup>73</sup> Mixed with water or commercially available premixed washer solvent/antifreeze.

required for the Maintenance System, or changing of oil and oil filter at change intervals longer than those called for by the Maintenance System will result in engine or emission control system damage not covered by the Mercedes-Benz Limited Warranty.

Please follow Maintenance System recommendations for scheduled oil changes. Failure to do so will result in engine or emission control system damage not covered by the Mercedes-Benz Limited Warranty.

Mercedes-Benz recommends MOBIL OIL.

Use the table below to determine the MB sheet number.

Model	Engine, type	MB sheet number
S 450 4MATIC <sup>74</sup>	273	229.5
S 550 <sup>75</sup>	273	229.5
S 550 4MATIC	273	229.5
S 600	275	229.5
S 63 AMG	156	229.5 <sup>76</sup>
S 65 AMG	275	229.5

**i** MB sheet numbers are printed on the outside of oil containers.

## Viscosity grades for engine oils

Using the chart below, select oil viscosity according to the lowest air temperature expected before the next oil change.

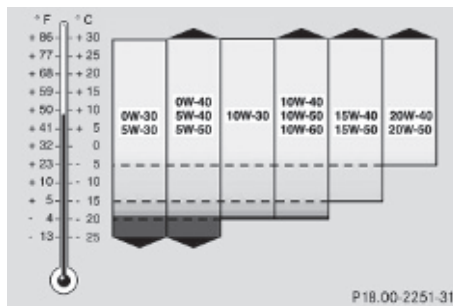

## Engine oil additives

**!** Do not blend oil additives with engine oil. They may damage the engine. Damage or malfunctions resulting from blending oil additives are not covered by the Mercedes-Benz Limited Warranty.

## Air conditioning refrigerant

R134a (HFC) refrigerant and special PAG lubricating oil are used in the air conditioning system.

**!** Never use R 12 (CFC) or mineral-based lubricating oil. Otherwise damage to the system will occur.

## Brake fluid

### **!** Warning!

During vehicle operation, the boiling point of the brake fluid is continuously reduced through the absorption of moisture from the atmosphere.

<sup>74</sup> Canada only.

<sup>75</sup> USA only.

<sup>76</sup> Restriction: Only SAE 0W-40/SAE 5W-40 engine oils may be used.

Under extremely strenuous operating conditions, this moisture content can lead to the formation of bubbles in the system, thus reducing the system's efficiency.

Therefore, the brake fluid must be replaced regularly. Refer to your vehicle's Maintenance Booklet for replacement interval.

Only brake fluid approved by Mercedes-Benz is recommended. Any authorized Mercedes-Benz Center will provide you with additional information.

### Premium unleaded gasoline

#### Warning!

Gasoline is highly flammable and poisonous. It burns violently and can cause serious personal injury.

Never allow sparks, flames or smoking materials near gasoline!

Turn off the engine before refueling.

Whenever you are around gasoline, avoid inhaling fumes and any skin or clothing contact. Extinguish all smoking materials.

Direct skin contact with fuels and the inhalation of fuel vapors are damaging your health.

**I** To maintain the engine's durability and performance, premium unleaded gasoline must be used.

If premium unleaded gasoline is not available and low octane gasoline is used, follow these precautions:

- Have the fuel tank only partially filled with unleaded regular gasoline and fill up with premium unleaded gasoline as soon as possible.
- Avoid full throttle driving and abrupt acceleration.
- Do not exceed an engine speed of 3 000 rpm if the vehicle is loaded with a

light load such as two persons and no luggage.

- Do not exceed  $\frac{2}{3}$  of maximum accelerator pedal position if the vehicle is fully loaded or operating in mountainous terrain.

### Fuel requirements

Only use premium unleaded gasoline. The octane number (posted at the pump) must be 91 min. It is an average of both the Research Octane Number (RON) and the Motor Octane Number (MON):  $(RON+MON)/2$ . This is also known as the ANTI-KNOCK INDEX.

Reformulated gasolines (RFG) and/or unleaded gasoline containing oxygenates such as ethanol, TAME, ETBE, IPA, IBA, and TBA can be used provided the ratio of any one of these oxygenates to gasoline does not exceed 10%; MTBE must not exceed 15%.

The ratio of methanol to gasoline must not exceed 3% plus additional cosolvents.

Using mixtures of ethanol and methanol is not allowed. Gasohol, which contains 10% ethanol and 90% unleaded gasoline, can be used.

These blends must also meet all other fuel requirements, such as resistance to spark knock, boiling range, vapor pressure, etc.

### Gasoline additives

A major concern among engine manufacturers is carbon build-up caused by gasoline. Mercedes-Benz recommends only the use of quality gasoline containing additives that prevent the build-up of carbon deposits.

After an extended period of using fuels without such additives carbon deposits can build up, especially on the intake valves and in the combustion area, leading to engine performance problems such as:

- Warm-up hesitation
- Unstable idle
- Knocking/pinging
- Misfire
- Power loss

In areas where carbon deposits may be encountered due to lack of availability of gasoline which contains these additives, the use of Mercedes-Benz approved additives is recommended.

Contact an authorized Mercedes-Benz Center or visit [www.mbusa.com](http://www.mbusa.com) (USA only) for a listing of approved products. Follow directions on the product label.

Do not blend other fuel additives with fuel. This only results in unnecessary cost and may be harmful to the engine operation.

**!** Damage or malfunction resulting from poor fuel quality or from blending additional fuel additives other than those tested and approved by us for use on Mercedes-Benz vehicles are not covered by the Mercedes-Benz Limited Warranty or by any pre-owned or Extended Limited Warranties.

### Coolants

The engine coolant is a mixture of water and anticorrosion/antifreeze, which provides:

- Corrosion protection
- Freeze protection
- Boiling protection (by increasing the boiling point)

The cooling system was filled at the factory with a coolant providing freeze protection to approximately -35°F (-37°C) and corrosion protection.

**!** Add premixed coolant solution only. Adding water and MB 325.0 Anticorrosion/Antifreeze separately from each other, could cause engine damage not covered by the Mercedes-Benz Limited Warranty.

If the antifreeze mixture is effective to -35°F (-37°C), the boiling point of the coolant in the pressurized cooling system is reached at approximately 266°F (130°C).

The coolant solution must be used year round to provide the necessary corrosion protection and increase boil-over protection. Refer to the Maintenance Booklet for replacement interval.

Coolant system design and coolant used determine the replacement interval. The replacement interval published in the Maintenance Booklet is only applicable if MB 325.0 Anticorrosion/Antifreeze solution or other Mercedes-Benz approved products of equal specification are used to renew the coolant concentration or bring it back up to the proper level.

For information on other Mercedes-Benz approved products of equal specification, contact an authorized Mercedes-Benz Center or visit [www.mbusa.com](http://www.mbusa.com) (USA only).

To provide important corrosion protection, the solution must be at least 50% anticorrosion/antifreeze (equivalent to freeze protection to approximately -35°F [-37°C]).

If you use a solution that is more than 55% anticorrosion/antifreeze (freeze protection to approximately -49°F [-45°C]), the engine temperature will increase due to the lower heat transfer capability of the solution. Therefore, do not use more than this amount of anticorrosion/antifreeze.

If the coolant level is low, water and MB 325.0 Anticorrosion/Antifreeze should be used to bring it up to the proper level (have cooling system checked for signs of leakage). Please make sure the mixture is in accordance with label instructions.

The water in the cooling system must meet minimum requirements, which are usually satisfied by normal drinking water.

If you are not sure about the water quality, contact an authorized Mercedes-Benz Center.

### **Anticorrosion/antifreeze**

---

Your vehicle contains a number of aluminum parts. The use of aluminum components in motor vehicle engines necessitates that anticorrosion/antifreeze coolant used in such engines be specifically formulated to protect the aluminum parts. Failure to use such anticorrosion/antifreeze coolant will result in a significantly shortened service life.

Therefore, the following product is strongly recommended for use in your vehicle:  
MB 325.0 Anticorrosion /Antifreeze agent.

Before the start of the winter season (or once a year in hot southern regions), you should have the anticorrosion/antifreeze concentration checked.

The coolant is also regularly checked each time you bring your vehicle to an authorized Mercedes-Benz Center for service.

FarmaSOS.com



	Model	Approximate freeze protection	
		-35°F (-37°C)	-49°F (-45°C)
Cooling system, vehicles without rear climate control	S 450 4MATIC <sup>77</sup>	7.8 US qt (7.4 l)	8.6 US qt (8.1 l)
	S 550 <sup>78</sup>	6.1 US qt (5.75 l)	6.7 US qt (6.3 l)
	S 550 4MATIC		
Cooling system, vehicles with rear climate control	S 450 4MATIC <sup>77</sup>	8.6 US qt (8.1 l)	9.4 US qt (8.9 l)
	S 550 <sup>78</sup>	6.9 US qt (6.55 l)	7.6 US qt (7.2 l)
	S 550 4MATIC		
	S 600	7.9 US qt (7.5 l)	8.7 US qt (8.3 l)
	S 63 AMG	6.0 US qt (5.6 l)	7.0 US qt (6.2 l)
	S 65 AMG	7.4 US qt (7.0 l)	8.1 US qt (7.7 l)
Low temperature cooling system	S 600	1.4 US qt (1.3 l)	1.5 US qt (1.4 l)
	S 65 AMG	1.6 US qt (1.55 l)	1.8 US qt (1.7 l)

### Washer system and headlamp cleaning system

#### Warning!

Washer solvent/antifreeze is highly flammable. Do not spill washer solvent/antifreeze on hot engine parts, because it may ignite and burn. You could be seriously burned.

(1.34 fl oz [40 ml] “MB SummerFit” to 1 gal [4.0 l] water)

For temperatures below freezing point:

1 part “MB SummerFit” to 100 parts solvent  
(1.34 fl oz [40 ml] “MB SummerFit” to 1 gal [4.0 l] solvent)

- ▶ Use MB Windshield Washer Concentrate “MB SummerFit”.
- ▶ Mix with water for temperatures above freezing point.
- ▶ Mix with commercially available premixed washer solvent/antifreeze for temperatures below freezing point.

### Washer fluid mixing ratio

For temperatures above the freezing point:  
1 part “MB SummerFit” to 100 parts water

<sup>77</sup> Canada only.

<sup>78</sup> USA only.

## Service and Literature

Your authorized Mercedes-Benz Center has trained technicians and Genuine Mercedes-Benz Parts to service your vehicle properly. For expert advice and quality service, contact an authorized Mercedes-Benz Center.

If you are interested in obtaining service literature for your vehicle, please contact an authorized Mercedes-Benz Center.

We consider this the best way for you to obtain accurate information for your vehicle. For further information you can find us on the Mercedes-Benz web site **www.mbusa.com** (USA only) or **www.mercedes-benz.ca** (Canada only).

### **Warning!**

To help avoid personal injury, be extremely careful when performing any service work or repairs. Improper or incomplete service or the use of incorrect or inappropriate parts or materials may damage the vehicle or its equipment, which may in turn result in personal injury.

If you have any questions about carrying out any type of service, turn to the advice of an authorized Mercedes-Benz Center.

We reserve the right to make changes in design and equipment.

Therefore, information, illustrations and descriptions in this Operator's Manual might differ from your vehicle.

Reprinting, translation and copying, even of excerpts, is not permitted without our prior authorization in writing.

Press time July 30, 2009

GSP/OIS

Printed in U. S. A.

امداد خود را  
تلفن شبانه روزی: ۰۲۱-۸۸۸۶۲۰۸۵  
FarmaSOS.com

# امداد خودرو فارما

تلفن شبانه روزی: ۰۲۱-۸۸۸۶۲۰۸۵

**FarmaSOS.com**



2215847682

Order no. 6515 2344 13 Part no. 221 584 76 82 Edition B 2010