



اپد خودرو فارما
تلفون نمبر: ۰۲۱-۸۸۸۶۲۰۸۵
FarmaSOS.com

SLK

Operator's Manual



1725840300

Order no. 6515 3326 13 Part no. 172 584 03 00 Edition B 2013

SLK Operator's Manual



Mercedes-Benz

Symbols

Registered trademarks:

- Bluetooth® is a registered trademark of Bluetooth SIG Inc.
- DTS is a registered trademark of DTS, Inc.
- Dolby and MLP are registered trademarks of DOLBY Laboratories.
- BabySmart™, ESP® and PRE-SAFE® are registered trademarks of Daimler AG.
- HomeLink® is a registered trademark of Prince.
- iPod® and iTunes® are registered trademarks of Apple Inc.
- Logic7® is a registered trademark of Harman International Industries.
- Microsoft® and Windows media® are registered trademarks of Microsoft Corporation.
- SIRIUS is a registered trademark of Sirius XM radio Inc.
- HD Radio is a registered trademark of iBiquity Digital Corporation.
- Gracenote® is a registered trademark of Gracenote, Inc.
- ZAGATSurvey® and related brands are registered trademarks of ZagatSurvey, LLC.

In this Operator's Manual, you will find the following symbols:

WARNING

Warning notes draw your attention to hazards that endanger your health or life, or the health or life of others.

Environmental note

Environmental notes provide you with information on environmentally aware actions or disposal.

- ! Notes on material damage alert you to dangers that could lead to damage to your vehicle.

 Practical tips or further information that could be helpful to you.

- ▶ This symbol indicates an instruction that must be followed.
- ▶ Several of these symbols in succession indicate an instruction with several steps.
- (▷ page) This symbol tells you where you can find more information about a topic.
- ▷▷ This symbol indicates a warning or an instruction that is continued on the next page.

Display This font indicates a display in the multifunction display/COMAND display.

Parts of the software in the vehicle are protected by copyright © 2005 The FreeType Project
<http://www.freetype.org>. All rights reserved.

Publication details

Internet

Further information about Mercedes-Benz vehicles and about Daimler AG can be found on the following websites:

<http://www.mbusa.com> (USA only)

<http://www.mercedes-benz.ca> (Canada only)

Editorial office

Not to be reprinted, translated or otherwise reproduced, in whole or in part, without the written permission of Daimler AG.

امداد خودرو فارما

تلفن شبانه روزی: ۰۲۱-۸۸۶۲۰۸۵

FarmaSOS.com

Welcome to the world of Mercedes-Benz

Before you first drive off, read this Operator's Manual carefully and familiarize yourself with your vehicle. For your own safety and a longer vehicle life, follow the instructions and warning notices in this manual. Disregarding them may lead to damage to the vehicle or personal injury.

Vehicle damage resulting from the disregard of the instructions is not covered by the Mercedes-Benz Limited Warranty.

The equipment or model designation of your vehicle may differ according to:

- model
- order
- country variant
- availability

Mercedes-Benz therefore reserves the right to introduce changes in the following areas:

- design
- equipment
- technical features

Therefore, descriptions may vary from those of your own vehicle.

The following are integral components of the vehicle:

- Operator's Manual
- Maintenance Booklet
- Equipment-dependent supplements

Keep printed copies of the documents in the vehicle at all times. If you sell the vehicle, always pass the documents on to the new owner.

The technical documentation team at Daimler AG wishes you safe and pleasant motoring.

Mercedes-Benz USA, LLC

Mercedes-Benz Canada, Inc.

A Daimler Company



امداد خودرو فارما

تلفن شبانه روزی: ۰۲۱-۸۸۸۶۲۰۸۵

FarmaSOS.com

Index	4	At a glance	27
Introduction	20	Safety	37
		Opening/closing	69
		Seats, steering wheel and mirrors	93
		Lights and windshield wipers	105
		Climate control	119
		Driving and parking	133
		On-board computer and displays	191
		Stowage and features	255
		Maintenance and care	275
		Breakdown assistance	289
		Wheels and tires	307
		Technical data	345

اراد خودرو فارما

۰۲۱-۸۸۸۶۲۰۸۸

FarmaSOC.com

1, 2, 3 ...

12 V socket

see Sockets

A**ABS (Anti-lock Braking System)**

Display message	212
Function/notes	59
Important safety notes	59
Warning lamp	244

Activating/deactivating cooling

with air dehumidification 125

Active light function 110**ADAPTIVE BRAKE** 65**Adaptive Highbeam Assist**

Display message	225
Function/notes	110
Switching on/off (on-board computer)	204

Additional speedometer 204**Additives (engine oil)** 351**Air bags**

Display message	221
Front air bag (driver, front passenger)	42
Head bag	44
Important safety notes	41
Knee bag	43
PASSENGER AIR BAG OFF indicator lamp	45
Safety guidelines	40
Side impact air bag	43

Air-conditioning system

see Climate control

AIRGUIDE 90**AIRSCARF**

Problem (malfunction)	98
Setting the vents	131
Switching on/off	98

Air vents

Important safety notes	130
Setting	130
Setting the AIRSCARF vents	131
Setting the center air vents	130
Setting the side air vents	130
Switching AIRSCARF on/off	98

Alarm system

see ATA (Anti-Theft Alarm system)

Ambient lighting

Setting the brightness (on-board computer)	204
Setting the color (on-board computer)	205

AMG menu (on-board computer) 207**Anti-lock braking system**

see ABS (Anti-lock Braking System)

Anti-theft alarm system

see ATA (Anti-Theft Alarm system)

Ashtray 260**Assistance menu (on-board****computer)** 201**ASSYST PLUS**

Displaying a service message	280
Hiding a service message	280
Resetting the service interval display	280
Service message	280
Special service requirements	281

ATA (Anti-Theft Alarm system)

Activating/deactivating	67
Function	67
Switching off the alarm	67

ATTENTION ASSIST

Activating/deactivating	202
Display message	228
Function/notes	184

Audio menu (on-board computer) 199**Authorized Centers**

see Qualified specialist workshop

Authorized Mercedes-Benz Center

see Qualified specialist workshop

Authorized workshops

see Qualified specialist workshop

AUTO lights

Display message	225
-----------------------	-----

see Lights

Automatic engine start (ECO start/stop function) 141**Automatic engine switch-off (ECO start/stop function)** 141**Automatic headlamp mode** 107

Automatic transmission

Accelerator pedal position	147
Automatic drive program	148
Changing gear	147
Display message	237
Driving tips	147
Emergency running mode	152
Kickdown	147
Manual drive program	150
Overview	145
Problem (malfunction)	152
Program selector button	147
Pulling away	138
Releasing the parking lock manually	152
Selector lever	145
Shift ranges	149
Starting the engine	137
Steering wheel paddle shifters	148
Transmission position display	146
Transmission positions	146

Automatic transmission

emergency mode	152
-----------------------------	-----

B**Backup lamp**

Changing bulbs	115
----------------------	-----

BAS (Brake Assist System)	60
--	----

BAS PLUS (Brake Assist System PLUS)	60
--	----

Battery (SmartKey)

Checking	73
Important safety notes	73
Replacing	73

Battery (vehicle)

Charging	298
Display message	227
Important safety notes	296
Jump starting	299
Overview	296

Blind Spot Assist

Activating/deactivating	202
Display message	230
Notes/function	186

Bottle holder	259
----------------------------	-----

Brake Assist

see BAS (Brake Assist System)

Brake fluid

Display message	217
Notes	351

Brake lamps

Display message	223
-----------------------	-----

Brakes

ABS	59
BAS	60
BAS PLUS	60
Brake fluid (notes)	351
Display message	212
Driving tips	160
High-performance brake system	161
Important safety notes	160
Maintenance	162
Parking brake	156
Warning lamp	244

Breakdown

see Flat tire
see Towing away

Bulbs

see Changing bulbs

C**California**

Important notice for retail customers and lessees	21
--	----

Calling up a malfunction

see Display messages

Car

see Vehicle

Care

Carpets	287
Car wash	282
Display	285
Exterior lights	285
Gear or selector lever	286
Interior	285
Matte finish	283
Notes	281
Paint	283
Plastic trim	286
Power washer	283
Roof lining	287
Seat belt	287
Seat cover	286
Sensors	285

- Steering wheel 286
- Tail pipes 285
- Trim pieces 286
- Washing by hand 282
- Wheels 284
- Windows 284
- Wiper blades 284
- Wooden trim 286
- Car keys**
 - see SmartKey
- Car wash (care)** 282
- CD player/CD changer (on-board computer)** 199
- Center console**
 - Lower section 33
 - Upper section 32
- Central locking**
 - Automatic locking (on-board computer) 206
 - Locking/unlocking (SmartKey) 71
- Changing bulbs**
 - High-beam headlamps 114
 - Important safety notes 112
 - Low-beam headlamps 114
 - Overview of bulb types 113
 - Removing/replacing the cover (front wheel arch) 114
 - Reversing lamps 115
 - Side marker lamps (rear) 114
 - Turn signals (front) 115
- Children**
 - In the vehicle 56
 - Restraint systems 56
 - Special seat belt retractor 58
- Cigarette lighter** 261
- Cleaning**
 - Mirror turn signal 285
- Climate control**
 - Air-conditioning system 121
 - Automatic climate control (dual-zone) 123
 - Controlling automatically 126
 - Cooling with air dehumidification .. 125
 - Defrosting the windows 128
 - Defrosting the windshield 128
 - Important safety notes 120
 - Indicator lamp 126
 - Maximum cooling 128
 - Notes on using automatic climate control 124
 - Notes on using the air-conditioning system 122
 - Overview of systems 120
 - Problems with cooling with air dehumidification 126
 - Problem with the rear window defroster 129
 - Setting the air distribution 127
 - Setting the airflow 127
 - Setting the air vents 130
 - Setting the temperature 126
 - Switching air-recirculation mode on/off 129
 - Switching on/off 125
 - Switching residual heat on/off 129
 - Switching the rear window defroster on/off 128
 - Switching the ZONE function on/off 127
- Cockpit**
 - Overview 28
 - see Instrument cluster
- Collapsible spare wheel**
 - Inflating 341
 - see Emergency spare wheel
- COMAND display**
 - Cleaning 285
- Combination switch** 108
- Consumption statistics (on-board computer)** 196
- Convenience closing feature** 83
- Convenience opening feature**
 - see Side windows
- Coolant (engine)**
 - Checking the level 279
 - Display message 226
 - Filling capacity 352
 - Important safety notes 351
 - Temperature (on-board computer) . 207
 - Temperature gauge 193
 - Warning lamp 250
- Cooling**
 - see Climate control
- Cornering light function**
 - Display message 222
 - Function/notes 109

- Crash-responsive emergency lighting** 112
- Cruise control**
- Cruise control lever 164
 - Deactivating 165
 - Display message 233
 - Driving system 163
 - Function/notes 164
 - Important safety notes 163
 - Setting a speed 165
 - Storing and maintaining current speed 164
- Cup holder**
- Center console 259
 - Important safety notes 259
- Customer Assistance Center (CAC)** ... 24
- Customer Relations Department** 24
- D**
- Dashboard**
- see Instrument cluster
- Dashboard lighting**
- see Instrument cluster lighting
- Data**
- see Technical data
- Daytime running lamps**
- Display message 225
 - Function/notes 107
 - Switching on/off (on-board computer) 204
- Dealerships**
- see Qualified specialist workshop
- Delayed switch-off**
- Exterior lighting (on-board computer) 205
 - Interior lighting 205
- Diagnostics connection** 23
- Digital speedometer** 197
- Display messages**
- ASSYST PLUS 280
 - Calling up (on-board computer) 211
 - Driving systems 228
 - Engine 226
 - General notes 211
 - Hiding (on-board computer) 211
 - KEYLESS-GO 241
 - Lights 222
 - Safety systems 212
 - SmartKey 240
 - Tires 234
 - Vehicle 237
- Distance display (on-board computer)** 201
- Distance recorder** 196
- Distance warning (warning lamp)** 252
- DISTRONIC PLUS**
- Cruise control lever 169
 - Deactivating 173
 - Display message 231
 - Displays in the multifunction display 173
 - Driving tips 174
 - Function/notes 168
 - Important safety notes 166
 - Setting the specified minimum distance 172
 - Warning lamp 252
- Doors**
- Automatic locking (on-board computer) 206
 - Automatic locking (switch) 78
 - Central locking/unlocking (SmartKey) 71
 - Control panel 35
 - Display message 239
 - Emergency locking 78
 - Emergency unlocking 78
 - Important safety notes 76
 - Opening (from inside) 77
 - Overview 76
- Drinking and driving** 159
- Drinks holder**
- see Bottle holder
 - see Cup holder
- Drive program**
- Automatic 148
 - Display 146
 - Manual 150
 - SETUP (on-board computer) 208
- Driver's door**
- see Doors
- Driving abroad**
- Mercedes-Benz Service 281
 - Symmetrical low beam 106
- Driving on flooded roads** 162

Driving safety systems

ABS (Anti-lock Braking System)	59
ADAPTIVE BRAKE	65
BAS (Brake Assist System)	60
BAS PLUS (Brake Assist System PLUS)	60
Electronic brake force distribution ...	64
ESP® (Electronic Stability Program) .	61
ETS (Electronic Traction System)	62
Important safety information	59
Overview	59
PRE-SAFE® Brake	65

Driving systems

ATTENTION ASSIST	184
Blind Spot Assist	185
Cruise control	163
Display message	228
DISTRONIC PLUS	166
Driving Assistance package	185
Dynamic handling package	176
HOLD function	176
Lane Keeping Assist	187
Parking Guidance	181
PARKTRONIC	178

Driving tips

Automatic transmission	147
Brakes	160
Break-in period	134
DISTRONIC PLUS	174
Downhill gradient	160
Drinking and driving	159
Driving abroad	106
Driving in winter	163
Driving on flooded roads	162
Driving on wet roads	162
Exhaust check	159
Fuel	159
General	158
Hydroplaning	162
Icy road surfaces	163
Limited braking efficiency on salted roads	161
Snow chains	311
Symmetrical low beam	106
Wet road surface	161

Drowsiness detection assistance system

see ATTENTION ASSIST

DVD audio

Operating (on-board computer) 199

DVD video

Operating (on-board computer) 200

Dynamic handling package

Function/notes
 176 |

E**EASY-ENTRY feature**

Activating/deactivating	206
Function/notes	99

EASY-EXIT feature

Crash-responsive	100
Function/notes	99
Switching on/off	206

EBD (electronic brake force distribution)

Display message	214
Function/notes	64

ECO display

Function/notes	159
On-board computer	196

ECO start/stop function

Deactivating/activating	140
General information	139
Important safety notes	139

Electronic Stability Program

see ESP® (Electronic Stability Program)

Electronic Traction System

see ETS (Electronic Traction System)

Emergency release

Driver's door	78
Trunk	81
Vehicle	78

Emergency spare wheel

Important safety notes	339
Points to remember	339
Removing	340
Stowing	340
Technical data	343

Emergency Tensioning Devices

Function	55
Safety guidelines	40

Emissions control

Service and warranty information 20

Engine

Check Engine warning lamp 250

Display message 226

ECO start/stop function 139

Engine number 348

Irregular running 143

Jump-starting 299

Starting problems 143

Starting the engine with the

SmartKey 137

Starting with KEYLESS-GO 138

Switching off 156

Tow-starting (vehicle) 303

Engine electronics

Problem (malfunction) 143

Engine jump starting

see Jump starting (engine)

Engine oil

Adding 278

Additives 351

Checking the oil level 277

Checking the oil level using the

dipstick 278

Display message 227

Filling capacity 350

Notes about oil grades 350

Notes on oil level/consumption 277

Temperature (on-board computer) . 207

Viscosity 351

ESP® (Electronic Stability**Program)**

AMG menu (on-board computer) ... 208

Deactivating/activating (AMG

vehicles) 63

Deactivating/activating (notes;

except AMG vehicles) 62

Display message 212

ETS 62

Function/notes 61

Important safety information 61

Warning lamp 246

ETS (Electronic Traction System) 62

Exhaust check 159

Exhaust tail pipe (cleaning

instructions) 285

Exterior lighting

Setting options 106

see Lights

Exterior mirrors

Adjusting 100

Dipping (automatic) 101

Folding in/out (automatically) 101

Folding in/out (electrically) 101

Folding in when locking (on-board

computer) 207

Out of position (troubleshooting) ... 101

Storing settings (memory function) 103

Storing the parking position 102

Eyeglasses compartment 257

F**Filler cap**

see Fuel filler flap

Filling capacities (Technical data) ... 348

Fire extinguisher 291

First-aid kit 290

Flat tire

MOExtended tires 292

Preparing the vehicle 291

TIREFIT kit 293

see Emergency spare wheel

Floormats 273

Fog lamps

Switching on/off 108

Front fog lamps

Display message 224

Switching on/off 108

Fuel

Additives 350

Consumption statistics 196

Displaying the current

consumption 196

Displaying the range 196

Driving tips 159

Fuel gauge 29

Grade (gasoline) 349

Important safety notes 348

Problem (malfunction) 155

Refueling 152

Tank content/reserve fuel 349

Fuel filler flap

Opening/closing 153

Fuel level

Calling up the range (on-board computer) 196

Fuel tank

Capacity 349
Problem (malfunction) 155

Fuse allocation chart (vehicle tool kit) 291**Fuses**

Allocation chart 304
Before changing 304
Fuse box in the engine compartment 304
Fuse box in the trunk 305
Important safety notes 303

G**Garage door opener**

Clearing the memory 265
Important safety notes 262
Opening/closing the garage door .. 264
Programming (button in the rear-view mirror) 263

Gear indicator (on-board computer) 207**Genuine parts** 346**Glove box** 256**H****Handbrake**

see Parking brake

Hazard warning lamps 109

Display message 240

Head bags

Display message 219
Operation 44

Headlamps

Adding fluid to cleaning system 279
Cleaning system (capacity) 353
Cleaning system (function) 109
Cleaning system (notes) 352
Fogging up 111
see Automatic headlamp mode

Head level heating (AIRSCARF) 98**Head restraints**

Adjusting 97
see NECK-PRO head restraints

Heating

see Climate control

High-beam headlamps

Changing bulbs 114
Display message 223
Switching Adaptive Highbeam Assist on/off 111
Switching on/off 109

Hill start assist 139**HOLD function**

Display message 229
Function/notes 177

Hood

Closing 277
Display message 239
Opening 276

Hydroplaning 162**I****Ignition lock**

see Key positions

Immobilizer 66**Indicator lamps**

see Warning and indicator lamps

Instrument cluster

Overview 29
Warning and indicator lamps 30

Instrument cluster lighting 192**Interior lighting** 111

Automatic control 112
Delayed switch-off (on-board computer) 205
Emergency lighting 112
Manual control 112
Overview 111
Reading lamp 111
Setting the brightness of the ambient lighting (on-board computer) 204
Setting the color of the ambient lighting (on-board computer) 205

J**Jack**

- Storage location 291
- Using 331

Jump starting (engine) 299**K****KEYLESS-GO**

- Convenience closing feature 83
- Display message 241
- Locking 71
- Start/Stop button 136
- Starting the engine 138
- Unlocking 71

Key positions

- KEYLESS-GO 136
- SmartKey 135

Kickdown

- Driving tips 147
- Manual drive program 151

Knee bag 43**L****Lamps**

- see Warning and indicator lamps

Lane Keeping Assist

- Activating/deactivating 202
- Display message 229
- Function/information 187

Lap time (RACETIMER) 208**License plate lamp (display message) 224****Light function, active**

- Display message 225

Lighting

- Light switch 106

Lights

- Activating/deactivating the interior lighting delayed switch-off 205
- Active light function 110
- Automatic headlamp mode 107
- Cornering light function 109
- Driving abroad 106
- Fog lamps 108
- Hazard warning lamps 109
- High beam flasher 109

- High-beam headlamps 109
- Low-beam headlamps 107
- Parking lamps 108
- Rear fog lamp 108

- Setting the brightness of the ambient lighting (on-board computer) 204
- Setting the color of the ambient lighting (on-board computer) 205
- Standing lamps 108
- Switching Adaptive Highbeam Assist on/off 204
- Switching the daytime running lamps on/off (on-board computer) 204
- Switching the exterior lighting delayed switch-off on/off (on-board computer) 205
- Switching the surround lighting on/off (on-board computer) 205
- Turn signals 108
- see Changing bulbs
- see Interior lighting

Light sensor (display message) 225**Locking**

- see Central locking

Locking (doors)

- Automatic 78
- Emergency locking 78
- From inside (central locking button) 77

Locking centrally

- see Central locking

Locking verification signal (on-board computer) 206**Low-beam headlamps**

- Changing bulbs 114
- Display message 222
- Setting for driving abroad (symmetrical) 106
- Switching on/off 107

Luggage cover

- see Trunk partition

Lumbar support 97**M****M+S tires 310****MAGIC SKY CONTROL 91**

- Malfunction message**
see Display messages
- Manual transmission**
Engaging reverse gear 145
Gear lever 144
Pulling away 138
Shifting to neutral 144
Shift recommendation 145
Starting the engine 137
- Matte finish (cleaning instructions)** 283
- mbrace**
Call priority 269
Display message 218
Downloading destinations
(COMAND) 269
Downloading routes 272
Emergency call 266
Geo fencing 273
Important safety notes 265
Locating a stolen vehicle 271
MB info call button 268
Remote vehicle locking 271
Roadside Assistance button 267
Search & Send 270
Self-test 266
Speed alert 273
System 265
Triggering the vehicle alarm 273
Vehicle remote malfunction
diagnosis 271
Vehicle remote unlocking 270
- Mechanical key**
Function/notes 72
Locking vehicle 78
Unlocking the driver's door 78
- Memory card (audio)** 199
- Memory function** 103
- Message memory (on-board
computer)** 211
- Messages**
see Display messages
- Mirrors**
see Exterior mirrors
see Rear-view mirror
see Vanity mirror (in the sun visor)
- Mobile phone**
Menu (on-board computer) 200
- Modifying the programming
(SmartKey)** 72
- MOExtended tires** 292
- Mounting wheels**
Lowering the vehicle 334
Mounting a new wheel 333
Preparing the vehicle 330
Raising the vehicle 331
Removing a wheel 333
Securing the vehicle against
rolling away 331
- MP3**
see separate operating instructions
- Multifunction display**
Function/notes 195
Permanent display 204
- Multifunction steering wheel**
Operating the on-board computer . 194
Overview 31
- N**
- Navigation**
Menu (on-board computer) 197
- Neck-level heating**
see AIRSCARF تلفز
- NECK-PRO head restraints**
Operation 50
Resetting after being triggered 51
- Notes on breaking-in a new vehicle** 134
- O**
- Occupant Classification System
(OCS)**
Faults 49
Operation 45
System self-test 48
- Occupant safety**
Children in the vehicle 56
Important safety notes 38
- OCS**
Faults 49
Operation 45
System self-test 48
- Odometer** 196
- Oil**
see Engine oil

- On-board computer**
- AMG menu 207
 - Assistance menu 201
 - Audio menu 199
 - Convenience submenu 206
 - Displaying a service message 280
 - Display messages 211
 - DISTRONIC PLUS 173
 - Factory settings submenu 203
 - Important safety notes 192
 - Instrument cluster submenu 203
 - Lighting submenu 204
 - Menu overview 195
 - Message memory 211
 - Navigation menu 197
 - Operation 194
 - RACETIMER 208
 - Service menu 203
 - Settings menu 203
 - Standard display 196
 - Telephone menu 200
 - Trip menu 196
 - Vehicle submenu 206
 - Video DVD operation 200
- Operating system**
see On-board computer
- Outside temperature display** 193
- Overhead control panel** 34
- P**
- Paint code number** 347
- Paintwork (cleaning instructions)** ... 283
- Panic alarm** 38
- Parking** 155
- Important safety notes 155
 - Parking brake 156
 - Position of exterior mirror, front-passenger side 102
 - see PARKTRONIC
- Parking aid**
- Parking Guidance 181
 - see Exterior mirrors
 - see PARKTRONIC
- Parking brake**
- Display message 214
 - Electric parking brake 156
 - Warning lamp 249
- Parking Guidance**
- Display message 230
 - Important safety notes 181
- Parking lamps**
- Switching on/off 108
- PARKTRONIC**
- Deactivating/activating 180
 - Driving system 178
 - Function/notes 178
 - Important safety notes 178
 - Problem (malfunction) 181
 - Range of the sensors 179
 - Warning display 179
- PASSENGER AIR BAG OFF indicator lamp** 45
- Pivoting draft stop**
• see AIRGUIDE
- Plastic trim (cleaning instructions)** . 286
- Power washers** 283
- Power windows**
see Side windows
- PRE-SAFE® (anticipatory occupant protection)**
- Display message 218
 - Operation 50
- PRE-SAFE® Brake**
- Activating/deactivating 202
 - Display message 218
 - Function/notes 65
 - Warning lamp 252
- Product information** 20
- Program selector button** 147
- Pulling away**
- Automatic transmission 138
 - Manual transmission 138
- Q**
- Qualified specialist workshop** 23
- R**
- RACETIMER (on-board computer)** 208
- Radar sensor system**
- Activating/deactivating 206
 - Display message 229
- Radio**
- Selecting a station 199

- Reading lamp** 111
- Rear fog lamp**
- Display message 224
 - Switching on/off 108
- Rear-view mirror**
- Anti-glare (manual) 100
 - Dipping (automatic) 101
- Rear window defroster**
- Problem (malfunction) 129
 - Switching on/off 128
- Refueling**
- Fuel gauge 29
 - Important safety notes 152
 - Refueling process 153
 - see Fuel
- Releasing the parking lock manually (automatic transmission)** 152
- Remote control**
- Programming (garage door opener) 263
- Reporting safety defects** 24
- Reserve (fuel tank)**
- see Fuel
- Reserve fuel**
- Display message 228
 - Warning lamp 250
 - see Fuel
- Residual heat (climate control)** 129
- Restraint system**
- see SRS (Supplemental Restraint System)
- Reverse gear**
- Engaging (automatic transmission) 145
 - Engaging (manual transmission) 145
- Reversible floor panel (trunk)** 258
- Reversing lamps (display message)** 224
- Roadside Assistance (breakdown)** 21
- Roof**
- Display message 239
 - Important safety notes 85
 - Opening/closing (with roof switch) .. 86
 - Opening/closing (with SmartKey) 87
 - Overview 85
 - Problem (malfunction) 92
 - Relocking 87
- Roof carrier** 258
- Roof lining and carpets (cleaning guidelines)** 287
- Roof switch** 86

S

Safety

- Children in the vehicle 56
- Child restraint systems 56
- Occupant Classification System (OCS) 45

Safety systems

see Driving safety systems

Seat belts

- Adjusting the driver's and front-passenger seat belt 54
- Belt force limiters 55
- Cleaning 287
- Correct usage 52
- Emergency Tensioning Devices 55
- Fastening 53
- Important safety guidelines 51
- Releasing 54
- Safety guidelines 40
- Switching belt adjustment on/off (on-board computer) 207
- Warning lamp 242
- Warning lamp (function) 55

Seats

- Adjusting (electrically) 96
- Adjusting (manually) 96
- Adjusting the 4-way lumbar support 97
- Adjusting the head restraint 97
- Cleaning the cover 286
- Correct driver's seat position 94
- Important safety notes 95
- Overview 95
- Seat heating problem 97
- Storing settings (memory function) 103
- Switching AIRSCARF on/off 98
- Switching seat heating on/off 97

Selector lever

- Cleaning 286

Sensors (cleaning instructions)

- 285

Service

see ASSYST PLUS

Service menu (on-board computer)

- 203

- Service products**
- Brake fluid 351
 - Coolant (engine) 351
 - Engine oil 350
 - Fuel 348
 - Important safety notes 348
 - Washer fluid 352
- Settings**
- Factory (on-board computer) 203
 - On-board computer 203
- Setting the air distribution** 127
- Setting the airflow** 127
- SETUP (on-board computer)** 208
- Side impact air bag** 43
- Side marker lamp**
- Changing bulbs (rear) 114
- Side marker lamp (display message)** 224
- Side windows**
- Cleaning 284
 - Convenience closing feature 83
 - Important safety information 82
 - Opening/closing (all) 82
 - Opening/closing (front) 82
 - Overview 82
 - Problem (malfunction) 85
 - Resetting 84
- SmartKey**
- Changing the battery 73
 - Changing the programming 72
 - Checking the battery 73
 - Convenience opening feature 83
 - Display message 240
 - Door central locking/unlocking 71
 - Important safety notes 70
 - Loss 75
 - Mechanical key 72
 - Opening/closing the roof 87
 - Overview 70
 - Positions (ignition lock) 135
 - Problem (malfunction) 75
 - Starting the engine 137
- Snow chains** 311
- Sockets**
- Center console 261
 - General notes 261
 - Under the armrest 261
- Spare wheel**
- Stowing 340
- Specialist workshop** 23
- Special seat belt retractor** 58
- Speed, controlling**
- see Cruise control
- Speedometer**
- Activating/deactivating the additional speedometer 204
 - Digital 197
 - In the Instrument cluster 29
 - Segments 193
 - Selecting the unit of measurement 203
 - see Instrument cluster
- SPORT handling mode**
- Activating/deactivating (AMG vehicles) 63
 - Warning lamp 247
- SRS (Supplemental Restraint System)**
- Display message 219
 - Introduction 39
 - Warning lamp 249
 - Warning lamp (function) 39
- Standing lamps**
- Display message 224
 - Switching on/off 108
- Starting (engine)** 137
- Steering (display message)** 239
- Steering wheel**
- Adjusting (electrically) 99
 - Adjusting (manually) 98
 - Button overview 31
 - Buttons (on-board computer) 194
 - Cleaning 286
 - Important safety notes 98
 - Paddle shifters 148
 - Storing settings (memory function) 103
- Steering wheel paddle shifters** 148
- Stopwatch (RACETIMER)** 208
- Stowage areas** 256
- Stowage compartments**
- Armrest (under) 257
 - Center console 257
 - Cup holders 259
 - Door 257
 - Eyeglasses compartment 257

- Glove box 256
 - Important safety information 256
 - Rear wall 257
 - Stowage net 258
 - Stowage net** 258
 - Summer tires** 310
 - Sun visor** 260
 - Supplement Restraint System**
see SRS (Supplemental Restraint System)
 - Surround lighting (on-board computer)** 205
 - Suspension tuning**
SETUP (on-board computer) 208
 - Switching air-recirculation mode on/off** 129
 - Switching off the alarm (ATA)** 67
- T**
- Tachometer** 193
 - Tail lamps**
Display message 223
 - Tank content**
Fuel gauge 29
 - Technical data**
Capacities 348
Emergency spare wheel 343
Notes 346
Tires/wheels 335
Vehicle data 353
 - TELEAID**
Call priority 269
Downloading destinations (COMAND) 269
Downloading routes 272
Emergency call 266
Geo fencing 273
Important safety notes 265
Locating a stolen vehicle 271
MB info call button 268
Remote vehicle locking 271
Roadside Assistance button 267
Search & Send 270
Self-test 266
Speed alert 273
System 265
Triggering the vehicle alarm 273
 - Vehicle remote malfunction diagnosis 271
 - Vehicle remote unlocking 270
 - Telephone**
Accepting a call 200
Display message 239
Menu (on-board computer) 200
Number from the phone book 201
Redialing 201
Rejecting/ending a call 200
 - Temperature**
Coolant 193
Coolant (on-board computer) 207
Engine oil (on-board computer) 207
Outside temperature 193
Setting (climate control) 126
 - Theft deterrent systems**
ATA (Anti-Theft Alarm system) 67
Immobilizer 66
 - Time**
see separate operating instructions
 - Timing (RACETIMER)** 208
 - TIREFIT kit** 293
 - Tire pressure**
Calling up (on-board computer) 316
Checking manually 315
Display message 234
Maximum 314
Notes 313
Not reached (TIREFIT) 294
Reached (TIREFIT) 295
Recommended 311
 - Tire pressure loss warning system**
Important safety notes 315
Restarting 315
 - Tire pressure monitoring system**
Function/notes 316
Restarting 318
Warning lamp 253
 - Tires**
Aspect ratio (definition) 329
Average weight of the vehicle occupants (definition) 327
Bar (definition) 327
Changing a wheel 329
Characteristics 327
Checking 309

- Definition of terms 327
 Direction of rotation 330
 Display message 234
 Distribution of the vehicle
 occupants (definition) 329
 DOT, Tire Identification Number
 (TIN) 326
 DOT (Department of
 Transportation) (definition) 327
 GAWR (Gross Axle Weight Rating)
 (definition) 328
 GVW (Gross Vehicle Weight)
 (definition) 328
 GVWR (Gross Vehicle Weight
 Rating) (definition) 328
 Important safety notes 308
 Increased vehicle weight due to
 optional equipment (definition) 328
 Kilopascal (kPa) (definition) 328
 Labeling (overview) 323
 Load bearing index (definition) 329
 Load index 326
 Load index (definition) 328
 Maximum loaded vehicle weight
 (definition) 328
 Maximum load on a tire (definition) 328
 Maximum permissible tire
 pressure (definition) 328
 Maximum tire load 326
 Maximum tire load (definition) 328
 MOExtended tires 310
 Optional equipment weight
 (definition) 329
 Overview 308
 PSI (pounds per square inch)
 (definition) 328
 Replacing 329
 Service life 310
 Sidewall (definition) 329
 Speed rating (definition) 328
 Storing 330
 Structure and characteristics
 (definition) 327
 Temperature 323
 TIN (Tire Identification Number)
 (definition) 329
 Tire bead (definition) 329
 Tire pressure (definition) 329
 Tire pressures (recommended) 327
 Tire size (data) 335
 Tire size designation, load-bearing
 capacity, speed rating 323
 Tire tread 309
 Tire tread (definition) 329
 Total load limit (definition) 329
 Traction 322
 Traction (definition) 329
 Tread wear 322
 Uniform Tire Quality Grading
 Standards 322
 Uniform Tire Quality Grading
 Standards (definition) 327
 Unladen weight (definition) 328
 Wear indicator (definition) 329
 Wheel rim (definition) 328
 see Flat tire
- Towing**
- Important safety guidelines 301
 Installing the towing eye 302
 Removing the towing eye 302
 With the rear axle raised 302
- Towing away**
- With both axles on the ground 302
- Tow-starting**
- Emergency engine starting 303
 Important safety notes 301
 Installing the towing eye 302
 Removing the towing eye 302
- Transmission**
- Selector lever 145
 see Automatic transmission
 see Manual transmission
- Transporting the vehicle** 303
- Trim pieces (cleaning instructions)** . 286
- Trip computer (on-board computer)** 196
- Trip odometer**
- Calling up 196
 Resetting (on-board computer) 197
- Trunk**
- Emergency release 81
 Important safety notes 79
 Locking separately 80
 Opening/closing (manually from
 outside) 80

- Opening (automatically from outside) 80
 Overview 79
- Trunk lid**
 Display message 239
 Opening/closing 79
 Opening dimensions 353
- Trunk load (maximum)** 353
- Trunk partition**
 Display message 239
 General notes 88
 Opening/closing 88
- Turn signals**
 Changing bulbs (front) 115
 Display message 222
 Switching on/off 108
- Type identification plate**
 see Vehicle identification plate
- U**
- Unlocking**
 Emergency unlocking 78
 From inside the vehicle (central unlocking button) 77
- V**
- Vanity mirror (in the sun visor)** 260
- Vehicle**
 Correct use 23
 Data acquisition 24
 Display message 237
 Equipment 20
 Individual settings 203
 Limited Warranty 24
 Loading 319
 Locking (in an emergency) 78
 Locking (SmartKey) 71
 Lowering 334
 Maintenance 21
 Parking for a long period 158
 Pulling away 138
 Raising 331
 Reporting problems 24
 Securing from rolling away 331
 Towing away 301
 Tow-starting 301
 Transporting 303
 Unlocking (in an emergency) 78
 Unlocking (SmartKey) 71
 Vehicle data 353
- Vehicle battery**
 see Battery (vehicle)
- Vehicle data** 353
- Vehicle dimensions** 353
- Vehicle emergency locking** 78
- Vehicle identification number**
 see VIN
- Vehicle identification plate** 347
- Vehicle tool kit** 291
- Video**
 Operating the DVD 200
- VIN** 347
- W**
- Warning and indicator lamps**
 ABS 244
 Brakes 244
 Check Engine 250
 Coolant 250
 Distance warning 252
 DISTRONIC PLUS 252
 ESP® 246
 ESP® OFF 247
 Fuel tank 250
 Overview 30
 PASSENGER AIR BAG OFF indicator lamp 45
 Reserve fuel 250
 Seat belt 242
 SPORT handling mode 247
 SRS 249
 Tire pressure monitor 253
- Warning triangle** 290
- Warranty** 346
- Washer fluid**
 Display message 240
- Wheel bolt tightening torque** 334
- Wheel check** 331
- Wheels**
 Changing a wheel 329
 Checking 309
 Cleaning 284
 Cleaning (warning) 330

Emergency spare wheel	339
Important safety notes	308
Interchanging/changing	329
Mounting a new wheel	333
Mounting a wheel	330
Overview	308
Removing a wheel	333
Storing	330
Tightening torque	334
Wheel size/tire size	335
Windows	
see Side windows	
Wind screen	
Inserting and removing	88
Preparing for installation	89
see AIRGUIDE	
Windshield	
Defrosting	128
Windshield washer fluid	
see Windshield washer system	
Windshield washer system	
Adding washer fluid	279
Filling capacity	353
Notes	352
Windshield wipers	تلفن شبانه روزی: ۰۲۱-۸۸۶۲۰۸۵
Display message	240
Problem (malfunction)	117
Replacing the wiper blades	116
Switching on/off	115
Winter driving	
Important safety notes	310
Slippery road surfaces	163
Snow chains	311
Winter operation	
Overview	310
Winter tires	
M+S tires	310
Wiper blades	
Cleaning	284
Important safety notes	116
Replacing	116
Wooden trim (cleaning instructions)	286
Workshops	
see Qualified specialist workshop	

Product information

Mercedes-Benz recommends that you use genuine Mercedes-Benz parts, conversion parts and accessories that have been approved for your vehicle.

Mercedes-Benz tests genuine parts as well as conversion parts and accessories that have been specifically approved for your vehicle for their reliability, safety and suitability. Despite ongoing market research, Mercedes-Benz is unable to assess other parts. Therefore, Mercedes-Benz accepts no responsibility for the use of such parts in Mercedes-Benz vehicles. This is also the case, even if they have been independently or officially approved. The use of non-approved parts could affect your vehicle's operating safety.

Genuine Mercedes-Benz parts, approved conversion parts and accessories are available from any authorized Mercedes-Benz Center. Here, you will receive advice about permissible technical modifications, and the parts will be professionally installed.

Operator's Manual

General notes

Before you first drive off, read this Operator's Manual carefully and familiarize yourself with your vehicle.

For your own safety and a longer vehicle life, follow the instructions and warning notices in this manual. Disregarding them may lead to damage to the vehicle or personal injury.

Vehicle damage resulting from the disregard of the instructions is not covered by the Mercedes-Benz Limited Warranty.

Vehicle equipment

This Operator's Manual describes all models and all standard and optional equipment of your vehicle available at the time of going to print. Country-specific differences are

possible. Please note that your vehicle may not be equipped with all features described. This also applies to safety-related systems and functions. The equipment in your vehicle may therefore differ from some of the descriptions or illustrations.

The original purchase agreement lists all systems installed in your vehicle.

Contact an authorized Mercedes-Benz Center if you have any questions about equipment or operation.

The Operator's Manual and Maintenance Booklet are important documents and should be kept in the vehicle.

Service and vehicle operation

Service and literature

Your vehicle is covered under the terms of the warranties printed in the Service and Warranty Information booklet. Your authorized Mercedes-Benz Center will exchange or repair any defective parts originally installed in the vehicle in accordance with the terms of the following warranties:

- New Vehicle Limited Warranty
- Emission Systems Warranty
- Emission Performance Warranty
- California, Connecticut, Maine, Massachusetts, New York, Pennsylvania, Rhode Island and Vermont Emission Control Systems Warranty
- State warranty enforcement laws (lemon laws)

Information for customers in California

Under California law you may be entitled to a replacement of your vehicle or a refund of the purchase price or lease price, if after a reasonable number of repair attempts Mercedes-Benz USA, LLC and/or its authorized repair or service facilities fail to fix one or more substantial defects or malfunctions in the vehicle that are covered by its express warranty. During the period of 18 months from original delivery of the vehicle or the accumulation of 18,000 miles (approximately 29,000 km) on the odometer of the vehicle, whichever occurs first, a reasonable number of repair attempts is presumed for a retail buyer or lessee if one or more of the following occurs:

- (1) the same substantial defect or malfunction results in a condition that is likely to cause death or serious bodily injury if the vehicle is driven, that defect or malfunction has been subject to repair two or more times, and you have directly notified Mercedes-Benz USA, LLC in writing of the need for its repair,
- (2) the same substantial defect or malfunction of a less serious nature than category (1) has been subject to repair four or more times and you have directly notified us in writing of the need for its repair, or
- (3) the vehicle is out of service by reason of repair of the same or different substantial defects or malfunctions for a cumulative total of more than 30 calendar days.

Please send your written notice to:

Mercedes-Benz USA, LLC
Customer Assistance Center
One Mercedes Drive
Montvale, NJ 07645-0350

Maintenance

The Service and Warranty Booklet describes all the necessary maintenance work which should be done at regular intervals.

Always have the Service and Warranty Booklet with you when you bring the vehicle to an authorized Mercedes-Benz Center. The service advisor will record every service for you in the Service and Warranty Booklet.

Roadside Assistance

The Mercedes-Benz Roadside Assistance Program offers technical help in the event of a breakdown. Calls to the toll-free Roadside Assistance Hotline are answered by our agents 24 hours a day, 365 days a year.

**1-800-FOR-MERCEdes(1-800-367-6372)
(USA)**

1-800-387-0100 (Canada)

For additional information, refer to the Mercedes-Benz Roadside Assistance Program brochure (USA) or the "Roadside Assistance" section in the Service and Warranty booklet (Canada). You will find both in your vehicle literature portfolio.

Change of address or change of ownership

In the event of a change of address, please send us the "Notification of Address Change" in the Service and Guarantee booklet or simply call the Mercedes-Benz Customer Assistance Center (USA) at the hotline number

1-800-FOR-MERCEdes(1-800-367-6372) or Customer Service Center (Canada) at 1-800-387-0100. This will assist us in contacting you in a timely manner should the need arise.

If you sell your Mercedes, please leave the entire literature in the vehicle so that it is available to the next owner.

If you have purchased a used car, please send us the "Notification of Used Car Purchase" in the Service and Guarantee booklet or simply call the Mercedes-Benz Customer Assistance Center (USA) at the hotline number 1-800-FOR-MERCEdes(1-800-367-6372) or Customer Service (Canada) at 1-800-387-0100.

Vehicle operation outside the USA and Canada

If you plan to operate your vehicle in foreign countries, please be aware that:

- service facilities or replacement parts may not be readily available.
- unleaded fuel for vehicles with a catalytic converter may not be available. Leaded fuel may cause damage to the catalytic converter.
- the fuel may have a considerably lower octane rating. Unsuitable fuel can cause engine damage.

Some Mercedes-Benz models are available for delivery in Europe through our European Delivery Program. For details, consult an authorized Mercedes-Benz Center or write to one of the following addresses.

In the USA

Mercedes-Benz USA, LLC
European Delivery Department
One Mercedes Drive
Montvale, NJ 07645-0350

In Canada

Mercedes-Benz Canada, Inc.
European Delivery Department
98 Vanderhoof Avenue
Toronto, Ontario M4G 4C9

Operating safety

Important safety notes

WARNING

Work improperly carried out on electronic components and associated software could cause them to cease functioning. Because the vehicle's electronic components are interconnected, any modifications made may produce an undesired effect on other systems. Electronic malfunctions could seriously impair the operating safety of your vehicle.

Contact an authorized Mercedes-Benz Center for repairs or modifications to electronic components.

Other improper work or modifications on the vehicle could also have a negative impact on the operating safety of the vehicle.

Some safety systems only function when the engine is running. You should therefore never turn off the engine while driving.

WARNING

Heavy blows against the vehicle underbody or tires/wheels may cause serious damage and impair the operating safety of your vehicle. Such blows can be caused, for example, by running over an obstacle, road debris or a pothole.

If you feel a sudden significant vibration or ride disturbance, or you suspect that damage to your vehicle has occurred:

- turn on your hazard warning flashers.
- slow down carefully.
- drive with caution to an area which is a safe distance from the road.

Inspect the vehicle underbody and tires/wheels for possible damage. If the vehicle appears unsafe, have it towed to the nearest authorized Mercedes-Benz Center or other qualified maintenance or repair facility for further inspection or repairs.

Declarations of conformity

Vehicle components which receive and/or transmit radio waves

USA: "The wireless devices of this vehicle comply with Part 15 of the FCC Rules. Operation is subject to the following two conditions: 1) These devices may not cause harmful interference, and 2) These devices must accept any interference received, including interference that may cause undesired operation. Changes or modifications not expressly approved by the party responsible for compliance could void the user's authority to operate the equipment."

Canada: "The wireless devices of this vehicle comply with Industry Canada license-exempt RSS standard(s). Operation is subject to the following two conditions: (1) These devices may not cause interference, and (2) These devices must accept any interference, including interference that may cause undesired operation of the device."

Diagnostics connection

WARNING

If you connect equipment to the on-board diagnostics connection, it can affect the operation of the vehicle systems. This can impair the operating safety of your vehicle while driving. There is a risk of an accident. Do not connect any equipment to the on-board diagnostics connection.

WARNING

Loose equipment or equipment cables which are connected to the on-board diagnostics connection can obstruct the area around the pedals. The equipment or the cables could come between the pedals in the event of sudden braking or acceleration. This may affect the function of the pedals. There is a risk of an accident.

Do not attach any equipment or cables in the driver's footwell.

 If the engine is switched off and equipment on the diagnostics connection is used, the starter battery may discharge.

The diagnostics connection is only intended for the connection of diagnostic equipment at a qualified specialist workshop.

Connecting equipment to the diagnostics connection can, for example, lead to emissions monitoring information being reset. This may lead to the vehicle failing to meet the requirements of the next emissions test during the main inspection.

Qualified specialist workshop

An authorized Mercedes-Benz Center is a qualified specialist workshop. It has the necessary specialist knowledge, tools and qualifications to correctly carry out the work required on your vehicle. This is especially the case for work relevant to safety.

Observe the notes in the Maintenance Booklet.

Always have the following work carried out at an authorized Mercedes-Benz Center:

- work relevant to safety
- service and maintenance work
- repair work
- alterations, installation work and modifications
- work on electronic components

Correct use

WARNING

There are various warning stickers affixed to your vehicle. Their purpose is to alert you and others to various dangers. Therefore, do not remove any warning stickers unless the sticker clearly states that you may do so.

If you remove any warning stickers, you or others could fail to recognize certain dangers and be injured.

When driving your vehicle observe the following information:

- the safety notes in this manual
- the Technical Data section in this manual
- traffic rules and regulations
- laws and safety standards pertaining to motor vehicles

Problems with your vehicle

If you should experience a problem with your vehicle, particularly one that you believe may affect its safe operation, we urge you to contact an authorized Mercedes-Benz Center immediately to have the problem diagnosed and rectified. If the problem is not resolved to your satisfaction, please discuss the problem again with a Mercedes-Benz Center or contact us at one of the following addresses.

In the USA

Customer Assistance Center
Mercedes-Benz USA, LLC
One Mercedes Drive
Montvale, NJ 07645-0350

In Canada

Customer Relations Department
Mercedes-Benz Canada, Inc.
98 Vanderhoof Avenue
Toronto, Ontario M4G 4C9

Reporting safety defects

USA only:

The following text is reproduced as required of all manufacturers according to Title 49, Code of U.S. Federal Regulations, Part 575 pursuant to the National Traffic and Motor Vehicle Safety Act of 1966.

If you believe that your vehicle has a defect which could cause a crash or could cause

injury or death, you should immediately inform the National Highway Traffic Safety Administration (NHTSA) in addition to notifying Mercedes-Benz USA, LLC.

If NHTSA receives similar complaints, it may open an investigation, and if it finds that a safety defect exists in a group of vehicles, it may order a recall and remedy campaign. However, NHTSA cannot become involved in individual problems between you, your dealer, or Mercedes-Benz USA, LLC.

To contact NHTSA, you may call the Vehicle Safety Hotline toll-free at 1-888-327-4236 (TTY: 1-800-424-9153); go to <http://www.safercar.gov>; or write to: Administrator, NHTSA, 400 Seventh Street, SW., Washington, DC 20590.

You can obtain additional information about vehicle safety from:

<http://www.safercar.gov>

Limited Warranty

- 1. Follow the instructions in this manual about the proper operation of your vehicle as well as about possible vehicle damage. Damage to your vehicle that arises from culpable contraventions against these instructions is not covered either by the Mercedes-Benz Limited Warranty or by the New or Used-Vehicle Warranty.

Data stored in the vehicle

Information about electronic data acquisition in the vehicle

(Including notice pursuant to California Code § 9951)

Your vehicle records electronic data. If your vehicle is equipped with mbrace (Canada: TELE AID), data is transmitted in the event of an accident.

This information helps, for example, to test vehicle systems after an accident and to continually improve vehicle safety.

Daimler AG can access this data and submit it:

- for safety research or vehicle diagnosis purposes
- with the consent of the vehicle owner
- on the instruction of prosecuting authorities
- for use in arbitration of disputes that involve Daimler AG, its affiliates or its sales and service organizations
- as otherwise required or permitted by law.

Please check your mbrace (Canada: TELE AID) purchase agreement to find out more about data that can be recorded and transmitted by this system.

امداد خودرو فارما

تلفن شبانه روزی: ۰۲۱-۸۸۸۶۲۰۸۵

FarmaSOS.com

امداد خودرو فارما

تلفن شبانه روزی: ۰۲۱-۸۸۸۶۲۰۸۵

FarmaSOS.com

Cockpit	28
Instrument cluster	29
Multifunction steering wheel	31
Center console	32
Overhead control panel	34
Door control panel	35

امداد خودرو فارما

تلفن شبانه روزی: ۰۲۱-۸۸۸۶۲۰۸۵

FarmaSOS.com

Cockpit

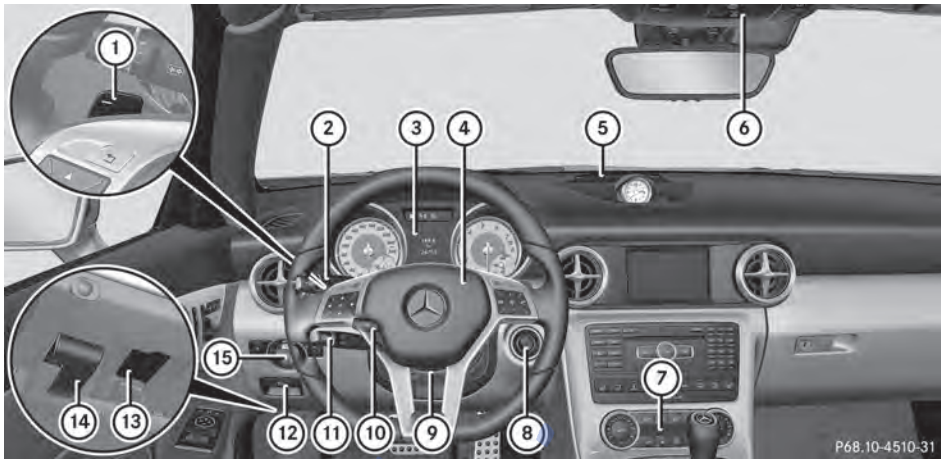

P68.10-4510-31

	Function	Page	Function	Page	
①	Steering wheel paddle shifters	148	⑨	Adjusting the steering wheel manually	98
②	Combination switch	108	⑩	Adjusting the steering wheel electrically	98
③	Instrument cluster	29	⑪	Cruise control lever	164
④	Horn		⑫	Electric parking brake	156
⑤	PARKTRONIC warning display	178	⑬	Diagnostics connection	23
⑥	Overhead control panel	34	⑭	Opening the hood	276
⑦	Climate control systems	120	⑮	Light switch	106
⑧	Ignition lock Start/Stop button	135 136			

Instrument cluster

Displays and controls



P54.33-2083-31

Function	Page	Function	Page
① Speedometer with segments	193	④ Coolant temperature	193
② Fuel gauge	193	⑤ Multifunction display	195
③ Tachometer	193	⑥ Instrument lighting	192

FarmaSOS.com

Warning and indicator lamps



P54.33-2084-31













	Function	Page
①	Low-beam headlamps	107
②	High-beam headlamps	109
③	ESP®	246
④	Electric parking brake (red)	244
⑤	Electric parking brake (yellow)	244
⑥	Distance warning	252
⑦	Turn signals	108
⑧	Tire pressure monitor	316
⑨	SRS	249

	Function	Page
⑩	Seat belt	242
⑪	SPORT handling mode in AMG vehicles	247
⑫	Coolant	250
⑬	Rear fog lamp	108
⑭	Front fog lamps	108
⑮	Check Engine	250
⑯	Reserve fuel	250
⑰	ESP® OFF	246
⑱	ABS	244
⑲	Brakes	244

Multifunction steering wheel



P46.10-3292-31









	Function	Page		Function	Page
①	Multifunction display	195	⑤	  Selects a menu	194
②	COMAND display; see the separate Operating Instructions			  Selects a submenu or scrolls through lists	194
③	 Switches on the Voice Control System; see the separate operating instructions			 Confirms your selection	194
④	 Rejects or ends a call Exits phone book/redial memory  Makes or accepts a call Switches to the redial memory   Adjusts the volume  Mute	200	⑥	 Back Switches off the Voice Control System; see the separate operating instructions	194

Center console

Center console, upper section





P68.20-4445-31

	Function	Page	Function	Page	
①	COMAND; see the separate operating instructions		⑥	 Hazard warning lamps	109
②	 Seat heating	97	⑦	 PASSENGER AIR BAG OFF indicator lamp	45
③	 AIRSCARF	98	⑧	 ESP®	61
④	 PARKTRONIC	178	⑨	 Dynamic handling package with sports mode	176
⑤	 ECO start/stop function (AMG vehicles)	139			

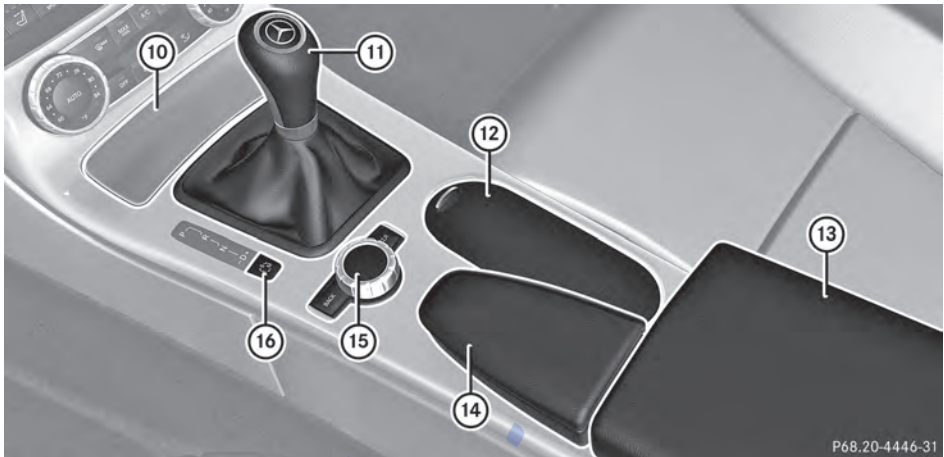
Center console, lower section







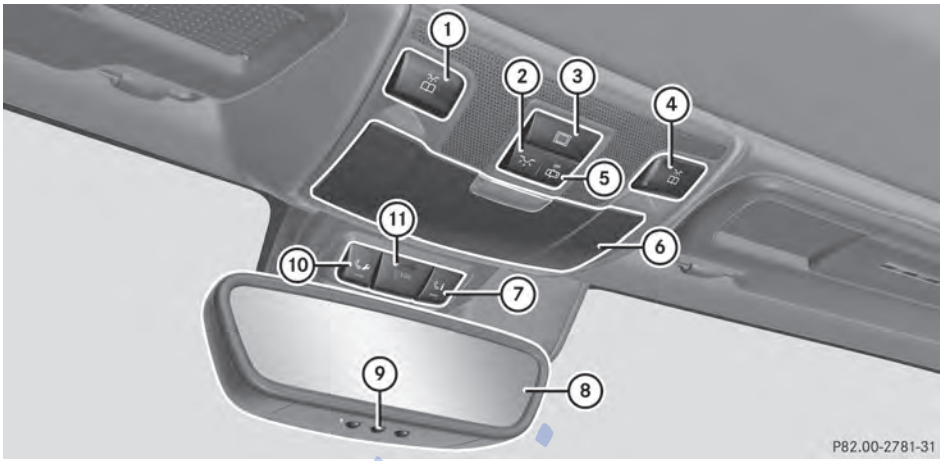



	Function	Page		Function	Page
⑩	Stowage compartment	256	⑭	Roof switch cover	86
	Ashtray	260		⑮	COMAND controller; see the separate operating instructions
	Cigarette lighter	261	⑯		 Selects the drive program
	Power socket	261		 Selects the drive program (AMG vehicles)	
⑪	Selector lever	145			
⑫	Cup holders	259			
⑬	Stowage compartment	256			

Overhead control panel



P82.00-2781-31

	Function	Page		Function	Page
①	 Switches the left-hand reading lamp on/off	111	⑦	 MB Info call button (mbrace system)	268
②	 Switches the interior lighting on/off	112	⑧	Rear-view mirror	100
③	 Operates MAGIC SKY CONTROL	91	⑨	Buttons for the garage door opener	264
④	 Switches the right-hand reading lamp on/off	111	⑩	 Roadside Assistance call button (mbrace system)	267
⑤	 Switches the automatic interior lighting control on/off	112	⑪	 SOS button (mbrace system)	266
⑥	Eyeglasses compartment	257			

Door control panel

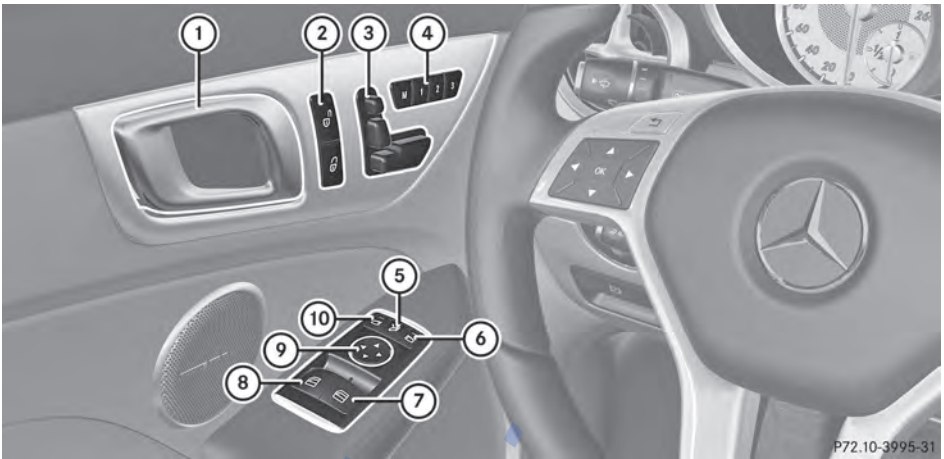

P72.10-3995-31

	Function	Page		Function	Page
①	Opens the door	77	⑥	Selects the right exterior mirror	100
②	Unlocks/locks the vehicle	77	⑦	Opens/closes the right side window	82
③	Adjusts the seats electrically	96	⑧	Opens/closes the left side window	82
④	Stores settings for the seat, exterior mirrors and steering wheel	103	⑨	Adjusts the exterior mirrors	100
⑤	Folds the exterior mirrors in/out	101	⑩	Selects the left exterior mirror	100

امداد خودرو فارما

تلفن شبانه روزی: ۰۲۱-۸۸۸۶۲۰۸۵

FarmaSOS.com

Useful information	38
Panic alarm	38
Occupant safety	38
Child restraint systems	56
Driving safety systems	59
Theft deterrent locking system	66

امداد خودرو فارما

تلفن شبانه روزی: ۰۲۱-۸۸۸۶۲۰۸۵

FarmaSOS.com

Useful information

- 1 This Operator's Manual describes all models and all standard and optional equipment of your vehicle available at the time of publication of the Operator's Manual. Country-specific differences are possible. Please note that your vehicle may not be equipped with all features described. This also applies to safety-related systems and functions.
- 1 Read the information on qualified specialist workshops: (▷ page 23).

Panic alarm



- ▶ **To activate:** press **PANIC** button 1 for at least one second.
An alarm sounds and the exterior lighting flashes.
 - ▶ **To deactivate:** press **PANIC** button 1 again.
- or
- ▶ Insert the SmartKey into the ignition lock.
- or
- ▶ Press the KEYLESS-GO Start/Stop button.
The KEYLESS-GO key must be in the vehicle.
- 1 USA only:
This device complies with Part 15 of the FCC Rules. Operation is subject to the following two conditions:

1. This device may not cause interference, and
2. this device must accept any interference received, including interference that may cause undesired operation.

Any unauthorized modification to this device could void the user's authority to operate the equipment.

The Product label with FCC ID and IC certification number can be found in the battery case of the SmartKey.

- 1 Canada only:

This device complies with RSS-Gen of Industry Canada. Operation is subject to the following two conditions:

1. This device may not cause interference, and
2. this device must accept any interference received, including interference that may cause undesired operation.

Any unauthorized modification to this device could void the user's authority to operate the equipment.

The Product label with FCC ID and IC certification number can be found in the battery case of the SmartKey.

Occupant safety

Important safety notes

WARNING

Modifications to or work improperly conducted on restraint system components or their wiring, as well as tampering with interconnected electronic systems, can lead to the restraint systems no longer functioning as intended.

Air bags or Emergency Tensioning Devices (ETDs), for example, could deploy inadvertently or fail to deploy in accidents although the deceleration threshold for air bag deployment is exceeded. Therefore, never modify the restraint systems. Do not

tamper with electronic components or their software.

In this section, you will learn the most important facts about the restraint system components of the vehicle.

The restraint system consists of:

- seat belts
- child restraint systems

Additional protection is provided by:

- SRS (Supplemental Restraint System)
- NECK-PRO head restraints
- PRE-SAFE®
- Air bag system components with:
 - PASSENGER AIR BAG ON/OFF indicator lamp¹
 - Front-passenger seat with Occupant Classification System (OCS)

The different air bag systems work independently of each other. The protective functions of the system work in conjunction with each other. Not all air bags are always deployed in an accident.

- i** See "Children in the vehicle" for information on infants and children traveling with you in the vehicle and restraint systems for infants and children (▷ page 56).

SRS (Supplemental Restraint System)

Introduction

SRS consists of:

- the  SRS warning lamp
- air bags
- the air bag control unit with crash sensors
- Emergency Tensioning Devices
- belt force limiters

SRS reduces the risk of occupants coming into contact with the vehicle's interior in the

event of an accident. It can also reduce the effect of the forces to which occupants are subjected during an accident.

SRS warning lamp

WARNING

The SRS self-check has detected a malfunction if the  SRS indicator lamp:

- does not light up at all
- does not go out after approximately four seconds after the engine is started
- lights up after the engine is started or while the vehicle is in motion

For your safety, Mercedes-Benz strongly recommends that you have the system checked as soon as possible at a qualified specialist workshop. SRS may otherwise fail to activate when it is needed in the event of an accident, which could lead to serious or fatal injuries. SRS might also be activated unexpectedly and unnecessarily, which could also result in injury.

In addition, work carried out improperly on SRS may render SRS inoperative or cause unintended air bag deployment. Work on the SRS system should only be carried out by qualified specialist personnel. Consult a qualified specialist workshop.

If it is necessary to modify an air bag system to accommodate a person with disabilities, contact an authorized Mercedes-Benz Center for details. USA only: for further information, contact our Customer Assistance Center at 1-800-FOR-MERCEdes (1-800-367-6372).

The  SRS warning lamp in the instrument cluster lights up when the ignition is switched on. It goes out no later than a few seconds after the engine is started.

SRS functions are checked regularly when the engine is running. Therefore, malfunctions can be detected in good time.

¹ The PASSENGER AIR BAG ON indicator lamp has no function. When switching on the ignition, it lights up briefly and then goes out again.

The SRS components are in operational readiness when the SRS  indicator lamp goes out while the engine is running.

Safety guidelines for seat belts, Emergency Tensioning Devices (ETDs) and air bags

WARNING

- Damaged seat belts or seat belts that have been subjected to stress in an accident must be replaced. Their anchoring points must also be checked. Only use seat belts installed or supplied by an authorized Mercedes-Benz Center.
- Air bags and pyrotechnic Emergency Tensioning Devices (ETDs) contain perchlorate material, which may require special handling and regard for the environment. Check your national disposal guidelines. California residents, see www.dtsc.ca.gov/HazardousWaste/Perchlorate/index.cfm.
- Air bags and ETDs are designed to function on a one-time-only basis. An air bag or ETD that has deployed must be replaced.
- Do not pass seat belts over sharp edges. They could tear.
- Do not make any modification that could change the effectiveness of the seat belts.
- Do not bleach or dye seat belts as this may severely weaken them. In a crash they may not be able to provide adequate protection.
- No modifications of any kind may be made to any components or wiring of the SRS.
- Do not change or remove any component or part of the SRS.
- Do not install additional trim material, seat covers, badges, etc. over the steering wheel hub, front-passenger front air bag cover, outer sides of the seat backrests, door trim panels, or door frame trims.
- Do not install additional electrical/electronic equipment on or near SRS components and wiring.
- Keep area between air bags and occupants free of objects (e.g. packages, purses, umbrellas, etc.).
- Air bag system components will be hot after an air bag has inflated. Do not touch them.
- Never place your feet on the instrument panel, dashboard, or on the seat. Always keep both feet on the floor in front of the seat.
- Improper repair work on the SRS creates a risk of rendering the SRS inoperative or causing unintended air bag deployment. Work on the SRS must therefore only be performed by qualified technicians. Contact an authorized Mercedes-Benz Center.
- For your protection and the protection of others, when scrapping the air bag unit or ETD, our safety instructions must be followed. These instructions are available from any authorized Mercedes-Benz Center.
- Given the considerable deployment speed, required inflation volume, and the material of the air bags, there is the possibility of abrasions or other, potentially more serious injuries resulting from air bag deployment.

If you sell your vehicle, Mercedes-Benz strongly recommends that you inform the subsequent owner that the vehicle is equipped with SRS. Also, refer them to the applicable section in the Operator's Manual.

Air bags

Important safety notes

WARNING

Air bags are designed to reduce the incidence of injuries and fatalities in certain situations:

- frontal impacts (driver's and front-passenger front air bags and knee bags)
- side impacts (side impact air bags and head bags)
- rollover (head bags)

However, no system available today can completely eliminate injuries and fatalities.

When the air bags are deployed, a small amount of powder is released. The powder generally does not constitute a health hazard and does not indicate that there is a fire in the vehicle. In order to prevent potential breathing difficulties, you should leave the vehicle as soon as it is safe to do so. If you have any breathing difficulty but cannot get out of the vehicle after the air bag inflates, then get fresh air by opening a window or door.

WARNING

In order to reduce the potential danger of injuries caused during the deployment of the front air bags, the driver and front passenger must always be correctly seated and wear their seat belts.

For maximum protection in the event of a collision, you must always be in the normal seat position with your back against the backrest. Fasten your seat belt and make sure that it is correctly positioned on your body.

As the air bag inflates with considerable speed and force, a proper seating position and correct positioning of the hands on the steering wheel will help to keep you at a safe distance from the air bag. Occupants who are not wearing their seat belt, are not seated properly or are too close to the air bag can be seriously injured or killed by an air bag, as it inflates with great force instantaneously:

- sit with the seat belt fastened correctly and in a position that is as upright as possible with your back against the backrest.
- move the driver's seat as far back as possible, still permitting proper operation of vehicle controls. The distance from the center of the driver's chest to the middle of the air bag cover on the steering wheel must be at least 10 inches (25 cm). You should be able to accomplish this by adjusting the seat and steering wheel. If you have any difficulties, please contact a qualified specialist workshop.
- do not lean your head or chest close to the steering wheel or dashboard.
- only hold the steering wheel on the outside. Placing hands and arms inside the rim of the steering wheel can increase the risk and potential severity of hand/arm injuries if the air bag inflates.
- adjust the front-passenger seat as far back as possible from the dashboard when the seat is occupied.
- occupants, especially children, should never place their bodies or lean their heads in the area of the door where the side impact air bag and/or head bag inflates. This could result in serious injuries or death should the side impact air bag/head bag be deployed. Always sit as upright as possible, wear the seat belt properly and use an appropriately sized infant restraint, toddler restraint or booster seat recommended for the size and weight of the child.

Failure to follow these instructions can result in severe injuries to you or other occupants.

If you sell your vehicle, it is important that you make the buyer aware of this safety information. Be sure to give the buyer this Operator's Manual.

WARNING

If the side impact air bag and/or head bag is deployed in the event of a side impact and the front passenger, especially a child, is not properly seated or restrained when next to a side impact air bag/head bag, injuries are possible due to the rapid inflation of the side impact air bag/head bag.

To help avoid the possibility of injury, please follow these guidelines:

- (1) Always sit as upright as possible, and use the seat belts properly. Make sure that children 12 years old and under use an appropriately sized child restraint, infant restraint or booster seat recommended for the size and weight of the child.
- (2) Always wear seat belts properly.

If the air bags are deployed, you will hear a bang, and a small amount of powder may also be released. Only in rare cases will the bang affect your hearing. The powder that is released generally does not constitute a health hazard. The  SRS warning lamp lights up.

The air bags are deployed if the air bag control unit detects the need for deployment. Only in the event of such a situation will the air bags provide their supplemental protection.

If the driver and front passenger do not wear their seat belts, it is not possible for the air bags to provide their supplemental protection.

In the event of other types of impacts and impacts below air bag deployment thresholds, the air bags will not deploy. The driver and passengers will then be protected to the extent possible by a properly fastened seat belt. A properly fastened seat belt is also

needed to provide the best possible protection in a rollover.

Air bags provide additional protection; they are not, however, a substitute for seat belts. All vehicle occupants must fasten their seat belts.

It is important for your safety and that of your passengers to have deployed air bags replaced and to have any malfunctioning air bags repaired. This will help to make sure the air bags continue to perform their protective function for the vehicle occupants in the event of a crash.

Front air bags



- ① Driver's air bag
- ② Front-passenger front air bag
- ③ Front-passenger knee bag
- ④ Driver's knee bag

Driver's air bag ① deploys in front of the steering wheel; front-passenger front air bag ② deploys in front of and above the glove box.

The front air bags increase protection against head and chest injuries.

They are deployed:

- in the event of certain frontal impacts
- if the system determines that air bag deployment can offer additional protection to that provided by the seat belt

- depending on whether the seat belt is being used
- independently of other air bags in the vehicle

If the vehicle overturns, the front air bags are generally not deployed. If the system detects high vehicle deceleration in a longitudinal direction, the front air bags are deployed.

Your vehicle has adaptive, two-stage front air bags. In the event of a collision, the air bag control unit evaluates the vehicle deceleration. In the first deployment stage, the front air bag is filled with enough propellant gas to reduce the risk of injuries. The front air bag is fully deployed if a second deployment threshold is exceeded within a few milliseconds.

The deployment of the front-passenger front air bag is also influenced by the weight category of the front passenger, which is determined by the Occupant Classification System (OCS) (▷ page 45).

The lighter the passenger side occupant, the higher the vehicle deceleration rate required (predicted at the start of the impact) for second-stage inflation of the front-passenger front air bag. In the second stage, the front air bags are inflated with the maximum amount of propellant gas available.

The front air bags are not deployed in situations where a low impact severity is predicted. You will then be protected by the fastened seat belt.

Front-passenger front air bag will only deploy if:

- the system, based on the OCS weight sensor readings, has detected that the front-passenger seat is occupied.
- the  indicator lamp on the center console is not lit (▷ page 45).
- the air bag control unit predicts a high impact severity.

Knee bags

Driver's knee bag ④ (▷ page 42) deploys underneath the steering column and front-passenger knee bag ③ (▷ page 42) underneath the glove box. They deploy together with the front air bags. They are designed to operate together with the front air bags in frontal impacts if certain thresholds are exceeded. The knee bags operate at best in conjunction with correctly positioned and fastened seat belts.

Knee bags provide increased protection for the driver and front passenger against the risk of:

- knee injuries
- thigh injuries
- lower leg injuries

Side impact air bags

WARNING

The pressure sensors for side impact air bag control are located in the doors. Do not modify any components of the doors or door trim panels including, for example, the addition of door speakers.

Improper repair work on the doors or the modification or addition of components to the doors create a risk of rendering the side impact air bags inoperative or causing unintended air bag deployment. Work on the doors must therefore only be performed by qualified technicians. Contact an authorized Mercedes-Benz Center.

WARNING

Only use seat covers which have been tested and approved by Mercedes-Benz for your vehicle model. Using other seat covers may interfere with or prevent the deployment of the side impact air bags. Contact an authorized Mercedes-Benz Center for availability.

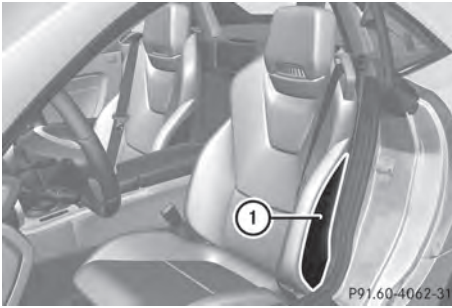

Example: side impact air bag on the driver's side

Side impact air bags ① deploy next to the outer side bolsters of the seat backrest.

When deployed, the side impact air bags offer additional protection for the thorax of the vehicle occupants on the side of the vehicle on which the impact occurs. However, they do not protect the:

- head
- neck
- arms

The side impact air bags are deployed:

- on the side on which an impact occurs
- at the start of an accident with a high rate of lateral vehicle deceleration or acceleration, e.g. in a side impact
- depending on whether the seat belt is being used
- independently of the front air bags
- independently of the ETDs

If the vehicle overturns, the side impact air bags are generally not deployed. Side impact air bags are deployed if the system detects high vehicle deceleration or acceleration in a lateral direction and determines that side impact air bag deployment can offer additional protection to that provided by the seat belt.

Side impact air bags will not deploy in side impacts which do not exceed the system's preset deployment thresholds for lateral acceleration/deceleration. You will then be protected by the fastened seat belt.

The side impact air bag on the front-passenger side does not deploy under the following conditions:

- the OCS system detects that the front-passenger seat is not occupied, and
- the front-passenger seat belt is not fastened.

The side impact air bag on the front-passenger side will deploy if the front-passenger seat belt is fastened, regardless of whether the front-passenger seat is occupied or not.

Head bags

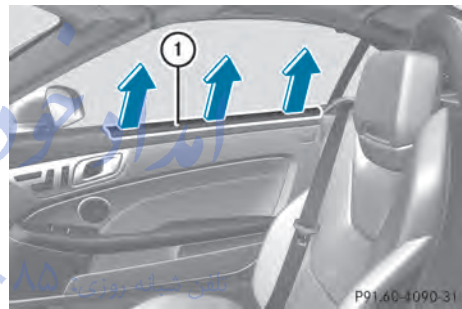

Example: headbag on the front-passenger side

Headbags ① deploy in the area of the side windows at the front. Headbags enhance the level of protection for the head, but not chest or arms, of the vehicle occupants on the side of the vehicle on which the impact occurs.

The headbags are deployed:

- at the start of an accident with a high rate of lateral vehicle deceleration or acceleration, e.g. in a side impact
- on the side on which an impact occurs
- on the driver's side and passenger side, in the event of a vehicle rollover and if the system determines that air bag deployment can offer the vehicle occupants additional protection to that provided by the seat belt
- independently of the use of the seat belt
- independently of the front air bags

Headbags will not deploy in side impacts which do not exceed the system's preset

deployment thresholds for lateral acceleration/deceleration. You will then be protected by the fastened seat belt.

The head bag on the front-passenger side is not deployed in the following situations:



- the OCS system detects that the front-passenger seat is not occupied, and
- the front-passenger seat belt is not fastened.

The head bag on the front-passenger side will deploy if the front-passenger seat belt is fastened, regardless of whether the front-passenger seat is occupied or not.

Occupant Classification System (OCS)

Method of operation

WARNING

If the  PASSENGER AIR BAG OFF indicator lamp illuminates when an adult or someone larger than a small individual is in the front-passenger seat, have the front passenger reposition himself or herself in the seat until the  PASSENGER AIR BAG OFF indicator lamp goes out.



In the event of a collision, the air bag control unit will not allow front-passenger front air bag and front-passenger knee bag deployment when the OCS has classified the front-passenger occupant as weighing as much as or less than a typical 12 month old child in a standard child restraint or if the front-passenger seat is classified as being unoccupied.

When the OCS senses that the front-passenger seat occupant is classified as being up to or less than the weight of a typical 12-month-old child in a standard child restraint, the  PASSENGER AIR BAG OFF indicator lamp will illuminate when the engine is started and remain illuminated. This indicates that the front-passenger front air

bag and the front-passenger knee bag are deactivated.

When the OCS senses that the front-passenger seat is classified as being empty, the  PASSENGER AIR BAG OFF indicator lamp will illuminate when the engine is started and remain illuminated. This indicates that the front-passenger front air bag and the front-passenger knee bag are deactivated.

When the OCS senses that the front-passenger seat occupant is classified as being heavier than the weight of a typical 12-month-old child seated in a standard child restraint or as being a small individual (such as a young teenager or a small adult), the  PASSENGER AIR BAG OFF indicator lamp will illuminate for approximately 6 seconds when the engine is started.

Depending on occupant weight sensor readings from the seat, it will then remain illuminated or go out. If the  PASSENGER AIR BAG OFF indicator lamp is illuminated, the front-passenger front air bag and the front-passenger knee bag are deactivated. If the  PASSENGER AIR BAG OFF indicator lamp is not illuminated, the front-passenger front air bag and the front-passenger knee bag are activated.

When the OCS senses that the front-passenger seat occupant is classified as an adult or someone larger than a small individual, the  PASSENGER AIR BAG OFF indicator lamp will illuminate for approximately six seconds when the engine is started and then go out. This indicates that the front-passenger front air bag and the front-passenger knee bag are activated.

If the  PASSENGER AIR BAG OFF indicator lamp is illuminated, the front-passenger front air bag and the front-passenger knee bag are deactivated and are not deployed.

If the  PASSENGER AIR BAG OFF indicator lamp is not illuminated, the front-passenger front air bag and the front-passenger knee bag are activated and are deployed:

- in certain front impacts
- independently of the side impact air bag and head bag
- if the impact has exceeded a predetermined threshold value for deployment

If the front-passenger front air bag is deployed, the rate of inflation will be influenced by:

- the rate of vehicle deceleration as assessed by the air bag control unit
- the front passenger's weight category as determined by the OCS

WARNING

Children under 12 years must be secured correctly in a suitable infant or child restraint system or booster seat suitable for the size and weight of the child.

The infant or child restraint must be properly secured with the vehicle's seat belt fully in accordance with the child seat manufacturer's instructions.





Occupants, in particular children, must sit as upright as possible, fasten the seat belt correctly and use a suitable infant restraint system, child restraint system or booster seat suitable for the size and weight of the child.

Children can be seriously or even fatally injured by an air bag deploying.



Observe the following information:

- Your vehicle is equipped with air bag technology designed to deactivate the front-passenger front air bag and the front-passenger knee bag in your vehicle when the system senses the weight of a typical 12-month-old child or less along with the

weight of a standard appropriate child restraint on the front-passenger seat.

- A child in a rear-facing child restraint system on the front-passenger seat will be seriously injured or even killed if the front-passenger front air bag inflates in a collision despite the air bag technology installed in your vehicle, which could occur under some circumstances.
- If you must install a rearward-facing child restraint on the front-passenger seat, make sure the  PASSENGER AIR BAG OFF indicator lamp is illuminated, indicating that the front-passenger front air bag and front-passenger knee bag are deactivated. If the  PASSENGER AIR BAG OFF indicator lamp does not light up or goes out when a rearward-facing child restraint system is installed, please check installation. Periodically check the  PASSENGER AIR BAG OFF indicator lamp while driving to make sure the  PASSENGER AIR BAG OFF indicator lamp is illuminated. If the  PASSENGER AIR BAG OFF indicator lamp goes out or remains out do not carry a child on the front-passenger seat.
- A child in a rearward-facing child restraint system on the front-passenger seat will be seriously injured or even killed if the front-passenger air bag is deployed.
- When securing a child in a child restraint system on the front-passenger seat, you must:
 - move the front-passenger seat as far back as possible
 - use a child restraint system that is suitable for the age, size and weight of the child
 - observe the manufacturer's installation instructions in order to install and secure the child restraint system correctly.
- For children larger than the typical 12-month-old child, the front-passenger front air bag may or may not be activated.

WARNING

If the red  SRS warning lamp in the instrument cluster and the  PASSENGER AIR BAG OFF indicator lamp light up simultaneously, the OCS is malfunctioning.

The front-passenger front air bag and the front-passenger knee bag will be deactivated in this case. Have the system checked as soon as possible by qualified technicians. Consult an authorized Mercedes-Benz Center.

Only have the seat repaired at an authorized Mercedes-Benz Center.

In order to ensure correct operation of the air bag system and OCS:



- sit with the seat belt fastened correctly and in a position that is as upright as possible with your back against the backrest.
- while seated, an occupant should not position themselves in such a way as to cause their weight to be lifted from the seat cushion as this may result in OCS being unable to correctly assess the occupant's weight category.
- read and observe all warnings in this section.



If the key has been removed from the ignition lock or is in position **0**, the  indicator lamp ① does not light up.

The  indicator lamp ② is inoperative. It lights up briefly when the ignition is switched on and then goes out again.

Occupant Classification System (OCS) categories the occupant on the front-

passenger seat using a weight sensor. The front-passenger front air bag and the front-passenger knee bag are deactivated automatically for certain weight categories. The  indicator lamp ① shows you the current status. If the  indicator lamp ① lights up, the front-passenger air bag and the front-passenger knee bag are disabled.

The OCS weight sensor reading is affected if the occupant's weight is transferred, e.g. by leaning on the armrest.

Both the driver and the front passenger should always observe the  indicator lamp ① to determine whether or not the front passenger is positioned correctly. Also observe the air bag display messages, which appear in the instrument cluster (▷ page 221).

The system does not deactivate:

- the side impact air bag
- the front-passenger head bag
- the Emergency Tensioning Devices

To be classified correctly, the front passenger must sit:

- with the seat belt fastened correctly
- in a position that is as upright as possible with their back against the seat backrest
- with their feet on the floor

If the driver's air bag deploys, this does not mean that the front-passenger front air bag will also deploy.

The OCS may have detected that the seat:

- is empty or occupied by the weight of a typical child up to twelve months old, seated in a child restraint system
- is occupied by a small individual, such as a young teenager or a small adult
- is occupied by a child in a child restraint system whose weight is greater than that of a typical twelve month old child.

These are examples of when the OCS deactivates the front-passenger front air bag and front-passenger knee bag. Deactivation

takes place although the collision fulfills the criteria for deploying the driver's air bag.

If the front-passenger seat, the seat cover or the seat cushion are damaged, have the necessary repair work carried out at a qualified specialist workshop.

Mercedes-Benz recommends that you only use seat accessories which have been approved by Mercedes-Benz.

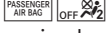
If the seat is not occupied and the OCS detects that the front-passenger seat is empty, the  indicator lamp will continue to light up. The  front-passenger front air bag warning lamp then stays lit continuously.

For more information about the OCS, see "Problems with the Occupant Classification System" (> page 49).

System self-test

WARNING

If the  PASSENGER AIR BAG OFF indicator lamp does not illuminate, the system is not functioning. Consult an authorized Mercedes-Benz Center before seating a child on the front-passenger seat.

WARNING

Never place anything between seat cushion and child seat (e.g. a pillow), since it reduces the effectiveness of the OCS. The underside and rear side child restraint system must be placed entirely on the seat cushion and the backrest of the front-passenger seat backrest.

If necessary, adjust the tilt of the passenger seat backrest.

An incorrectly mounted child seat could cause injuries to the child in case of an accident, instead of increasing protection for the child.

Follow the manufacturer's instructions for installation of child restraint systems.

The  indicator lamp lights up:

- if you turn the SmartKey in the ignition lock to position **1** or **2**
- if you press the KEYLESS-GO Start/Stop button once or twice on vehicles with KEYLESS-GO
- if an adult is seated properly on the front-passenger seat and the OCS classifies the occupant as an adult

The  indicator lamp goes out after approximately 6 seconds.

Problems with the occupant classification system



WARNING

If the  PASSENGER AIR BAG OFF indicator lamp illuminates and remains illuminated when the weight of a typical adult or an individual that is the size of a typical adult has been detected on the front-passenger seat, do not allow any occupant to use the front-passenger seat until the system has been repaired.

WARNING

If the  PASSENGER AIR BAG OFF indicator lamp does not illuminate or remains out with the weight of a typical 12-month-old child in a standard child restraint or less, or is unoccupied, on the front-passenger seat, do not transport a child on the front-passenger seat until the system has been repaired.

Problem	Possible causes/consequences and ► Solutions
<p>The  indicator lamp lights up and stays on.</p> <p>The person on the front-passenger seat:</p> <ul style="list-style-type: none"> • has the weight of a typical adult • has been determined by the system not to be a child 	<p>The OCS is malfunctioning.</p> <ul style="list-style-type: none"> ► Have the OCS checked as soon as possible at a qualified specialist workshop. ► Observe the additional messages in the multifunction display (► page 221).

Problem	Possible causes/consequences and ► Solutions
<p>The  indicator lamp does not light up and/or does not stay on.</p> <p>The front-passenger seat is:</p> <ul style="list-style-type: none"> • unoccupied • occupied with a weight up to that of a typical twelve-month-old child in a standard child restraint system 	<p>The OCS is malfunctioning.</p> <ul style="list-style-type: none"> ► Make sure there is nothing between the seat cushion and the child seat. ► Check the installation of the child restraint system. ► Make sure that no objects are applying additional weight onto the seat. ► If the  indicator lamp remains off, have the OCS checked as soon as possible at a qualified specialist workshop. Do not transport a child on the front-passenger seat as long as the OCS is not functioning. ► Observe the additional messages in the multifunction display (► page 221).

PRE-SAFE® (preventative occupant protection)

- 1 AMG vehicles do not include the PRE-SAFE® system.

All vehicles (except AMG vehicles): the PRE-SAFE® system is only available in vehicles with DISTRONIC PLUS.

WARNING

Make sure that nobody can become trapped as you adjust the seat.

WARNING

The PRE-SAFE® system reduces the impact of an accident on vehicle occupants, as long as their seat belts have been fastened correctly. Although your vehicle is equipped with a PRE-SAFE® system, the possibility of injury in the event of an accident cannot be ruled out. You should therefore always drive carefully and adapt your driving style to the prevailing road, weather and traffic conditions.

- 1 Make sure that there are no objects in the footwell or behind the seats when resetting the seats. There is a risk that the seats and/or the objects could be damaged.

PRE-SAFE® takes preemptive measures to protect occupants in certain hazardous situations.

PRE-SAFE® intervenes:

- if BAS intervenes, e.g. in emergency braking situations.
- when BAS PLUS intervenes powerfully on vehicles with DISTRONIC PLUS.
- when the radar sensor system detects an imminent danger of collision in certain situations on vehicles with DISTRONIC PLUS.
- in critical driving situations, e.g. when physical limits are exceeded and the vehicle understeers or oversteers severely.

PRE-SAFE® takes the following measures depending on the hazardous situation detected:

- the seat belts are pre-tensioned.
- on vehicles with memory function for the front-passenger seat: the front-passenger seat is adjusted if it is in an unfavorable position.
- if the vehicle skids, the side windows are closed almost completely.

If the hazardous situation passes without resulting in an accident, PRE-SAFE® slackens the belt pretensioning. All settings made by PRE-SAFE® can then be reversed.

If the seat belts are not released:

- Move the backrest or seat back slightly, but only when the vehicle is stationary. The belt pretensioning is reduced and the locking mechanism is released.

More information about seat belt adjustment, a convenience function integrated into PRE-SAFE (▷ page 54).

NECK-PRO head restraints

Important safety notes

WARNING

Do not secure any objects (e.g. coat hangers) on the NECK-PRO head restraints. Otherwise, the NECK-PRO head restraints may not function properly, or in the event of a rear-end collision may not be able to offer the level of protection they are designed to provide.

WARNING

Seat or head restraint covers can cause a malfunction when the NECK-PRO head restraints are activated or when the side impact air bags are deployed, or they can prevent this completely. The NECK-PRO head restraints or side impact air bags can therefore not provide the intended protection. Do not use any seat or head restraint covers.

WARNING

For your protection, drive only with properly positioned head restraints.

Adjust the head restraint so that it is as close to the head as possible and the center of the head restraint supports the back of the head at eye level. This will reduce the potential for injury to the head and neck in the event of an accident or similar situation.

WARNING

For safety reasons, have the NECK-PRO head restraints checked at a qualified specialist workshop after a rear-end collision.

The NECK-PRO head restraints reduce the likelihood of head and chest injuries. The NECK-PRO head restraints on the driver's and front-passenger seats are moved forwards and upwards in the event of a rear-end collision of a certain severity. This provides better head support.

If the NECK-PRO head restraints have been triggered in an accident, reset the NECK-PRO head restraints on the driver's and front-passenger seat (▷ page 51). Otherwise, the additional protection will not be available in the event of another rear-end collision. You can recognize when NECK-PRO head restraints have been triggered by the fact that they have moved forwards and can no longer be adjusted.

Resetting triggered NECK-PRO head restraints

WARNING

When pushing back the NECK-PRO head restraint cushion, make sure your fingers do not become caught between the head restraint cushion and the cover. Failure to observe this could result in injuries.

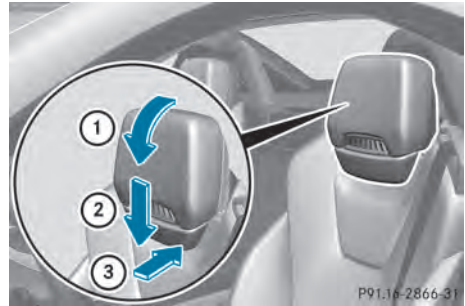

- ▶ Tilt the top of the NECK-PRO head restraint cushion forwards in the direction of arrow ①.
 - ▶ Push the NECK-PRO head restraint cushion down in the direction of arrow ② as far as it will go.
 - ▶ Firmly push the NECK-PRO head restraint cushion back in the direction of arrow ③ until the cushion engages.
 - ▶ Repeat this procedure for the second NECK-PRO head restraint.
- i** Resetting the NECK-PRO head restraints requires a lot of strength. If you have difficulty resetting the NECK-PRO head restraints, have this work carried out at a qualified specialist workshop.

Seat belts

Important safety notes

WARNING

Always fasten your seat belt before driving off. Always make sure your passenger is properly restrained. You and your passenger should always wear seat belts.

Failure to wear and properly fasten and position your seat belt considerably increases your risk of injuries and their likely severity in an accident.

If you are ever in an accident, your injuries could be considerably more severe if you have not fastened your seat belt correctly. If you do not fasten your seat belt, you are much more likely to collide with parts of the vehicle

interior or be ejected from it. This may result in serious or fatal injury.

In the same crash, the possibility of serious or fatal injury is considerably reduced if you wear your seat belt properly. The air bags can only offer the intended protection if the occupants are wearing their seat belts properly.

WARNING

Never ride in a moving vehicle with the seat backrest in an excessively reclined position as this can be dangerous. You could slide under the seat belt in a collision. If you slide under it, the seat belt would apply force at the abdomen or neck. That could cause serious or even fatal injuries. The seat backrest and seat belt provide the best restraint when the wearer is in a position that is as upright as possible and the seat belt is properly positioned on the body.

WARNING

Never let more people ride in the vehicle than there are seat belts available. Make sure everyone riding in the vehicle is correctly restrained with a separate seat belt. Never use a seat belt for more than one person at a time.

WARNING

Always have damaged seat belts or seat belts that have been subjected to a load in an accident replaced and the anchorages checked.

Only use seat belts that have been approved by Mercedes-Benz.

Never tamper with seat belts. This can result in the unintended deployment of the Emergency Tensioning Devices or the failure to deploy when necessary.

Do not bleach or dye seat belts, as this may severely weaken them. In the event of a collision, they may be unable to provide adequate protection.

Have all work carried out only by qualified technicians. Consult a qualified specialist workshop.

The use of seat belts and infant and child restraint systems is required by law in:

- all 50 states
- U.S. territories
- the District of Columbia
- all Canadian provinces

Even where this is not required by law, all vehicle occupants should correctly fasten their seat belts before starting the journey.

-  See "Children in the vehicle" (▷ page 56) for further information on infants and children traveling in the vehicle as well as on child restraint systems.

Proper use of the seat belts

WARNING

USE SEAT BELTS PROPERLY

- Seat belts can only work when used properly. Never wear seat belts in any other way than as described in this section, as that could result in serious injuries in the event of an accident.
- Each occupant should wear their seat belt at all times, because seat belts help reduce the likelihood of and potential severity of injuries in accidents, including rollovers. The integrated restraint system includes SRS (driver front air bag, knee bags, front-passenger front air bag, side impact air bags, head air bags), Emergency Tensioning Devices (ETDs) and seat belt force limiters. The system is designed to enhance the protection offered to properly belted occupants in certain frontal (front air bags, knee bags and ETDs) and side (side impact air bags, head air bags and ETDs) impacts which exceed preset deployment thresholds.
- Never wear the shoulder belt under your arm, across your neck or off your shoulder.

In a frontal crash, your body would move too far forward. That would increase the chance of head and neck injuries. The seat belt would also apply too much force to the ribs or abdomen, which could severely injure internal organs such as your liver or spleen.

Adjust the seat belt so that the shoulder section is located as close as possible to the middle of the shoulder (it should not touch the neck).

- Position the lap belt as low as possible on your hips and not across the abdomen. If the lap belt is positioned across your abdomen, it could cause serious injuries in a crash.
- Never wear seat belts over rigid or breakable objects in or on your clothing, such as eyeglasses, pens, keys etc., as these might cause injuries.
- Make sure the seat belt is always fitted snugly. Take special care of this when wearing loose clothing.
- Never use a seat belt for more than one person at a time. Do not fasten a seat belt around a person and another person or other objects at the same time.
- Seat belts should not be worn twisted. In a crash, you would not have the full width of the seat belt to distribute impact forces. The twisted seat belt against your body could cause injuries.
- Pregnant women should also always use a lap-shoulder belt. The lap belt portion should be positioned as low as possible on the hips to avoid any possible pressure on the abdomen.
- Place the seat backrest in a position that is as upright as possible.
- Check your seat belt during travel to make sure it is properly positioned.
- Never place your feet on the instrument panel, dashboard, or on the seat. Always

keep both feet on the floor in front of the seat.

- When using a seat belt to secure infant restraints, toddler restraints, or children in booster seats, always follow the child seat manufacturer's instructions.

WARNING

Do not pass seat belts over sharp edges. They could tear.

Do not allow the seat belt to get caught in the door or in the seat adjustment mechanism. This could damage the seat belt.

Never attempt to make modifications to seat belts. This could impair the effectiveness of the seat belts.

Fastening seat belts

WARNING

Children 12 years old and under must be seated and properly secured in an appropriately sized infant restraint, child restraint system, or booster seat recommended for the size and weight of the child. For additional information, see the "Children in the vehicle" section.

A child's risk of serious or fatal injuries is significantly increased if the child restraints are not properly secured in the vehicle and/or the child is not properly secured in the child restraint.

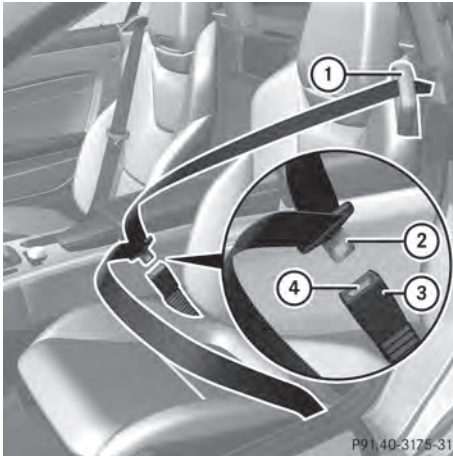

- ▶ Adjust the seat and move the backrest to an almost vertical position (▷ page 94).
- ▶ Pull the seat belt smoothly through belt loop ①.
- ▶ Without twisting it, guide the shoulder section of the seat belt across the middle of your shoulder and the lap section across your pelvis.
- ▶ Engage belt tongue ② in buckle ③.
Seat-belt adjustment: if necessary, the driver's and front-passenger seat belts automatically adjust to the upper body (▷ page 54).
- ▶ If necessary, pull upwards on the shoulder section of the seat belt to tighten the belt across your body.

The seat belt on the front-passenger side is equipped with a special seat belt retractor to secure a child restraint system properly to the front-passenger seat. Further information on the "Special seat belt retractor" (▷ page 58).

Information on releasing the seat belt with release button ④ (▷ page 54).

Seat belt adjustment

- ❗ AMG vehicles do not include the seat-belt adjustment function.

The seat-belt adjustment function adjusts the driver's and front-passenger seat belt to the upper body of the occupants.

The belt strap is tightened slightly when:

- you engage the belt tongue in the belt buckle and you then turn the SmartKey to position **2** in the ignition lock.
- the SmartKey is in position **2** in the ignition lock and you then engage the belt tongue in the buckle.

The seat-belt adjustment will apply a retraction force if any slack is detected between the occupant and the seat belt. Do not hold on to the seat belt tightly while it is adjusting. You can switch the seat-belt adjustment on and off in the on-board computer (▷ page 207).

The seat belt adjustment is a convenience function integrated in PRE-SAFE® (preventative occupant protection). More information on PRE-SAFE® (▷ page 50).

Releasing seat belts

- ❗ Make sure that the seat belt is fully rolled up. Otherwise, the seat belt or belt tongue will be trapped in the door or in the seat mechanism. This could damage the door, the door trim panel and the seat belt. Damaged seat belts can no longer fulfill their protective function and must be replaced. Visit a qualified specialist workshop.

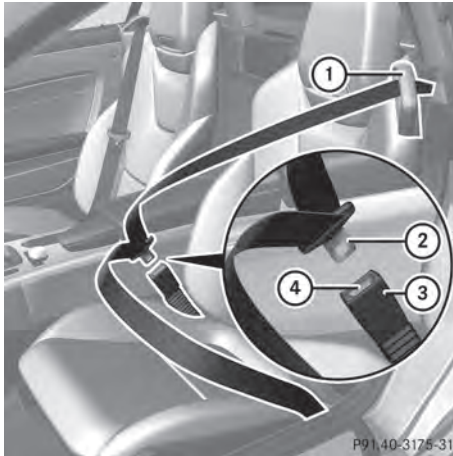

- ▶ Press release button ④ on belt buckle ③.
- ▶ Guide belt tongue ② back to seat belt loop ①.

Belt warning for the driver and front passenger

Regardless of whether the driver's and front-passenger seat belts have already been fastened, the  seat belt warning lamp lights up for six seconds each time the engine is started. It then goes out if the driver and the front passenger have fastened their seat belts.

If the driver's seat belt is not fastened when the engine is started, an additional warning tone will sound. The warning tone goes out after approximately six seconds or once the driver's seat belt is fastened.

If after six seconds the driver or front passenger have not fastened their seat belts and the doors are closed, the  seat belt warning lamp lights up:

- until the driver's or front passenger's seat belt is fastened
- if a vehicle speed of 15 mph (25 km/h) is exceeded, a warning tone also sounds with increasing intensity for a maximum of 60 seconds or until the driver or front passenger have fastened their seat belts.

If the driver/front passenger unfasten their seat belt while the vehicle is in motion, the  seat belt warning lamp lights up and a warning tone sounds again.

The warning tone ceases even if the driver or front passenger have still not fastened their seat belt after 60 seconds. The  seat belt warning lamp stops flashing but remains illuminated.

After the vehicle comes to a standstill, the warning tone is reactivated and the  seat belt warning lamp flashes again if the vehicle speed again exceeds 15 mph (25 km/h).

The  seat belt warning lamp only goes out if:

- both the driver and the front passenger have fastened their seat belts.
- or
- the vehicle is stationary and a door is open.

i For more information on the  seat belt warning lamp, see "Warning and indicator lamps in the instrument cluster, seat belt" (> page 242).

Emergency Tensioning Devices, belt force limiters

WARNING

Pyrotechnic ETDs that were activated must be replaced.

For your safety, when disposing of the pyrotechnic ETDs always follow our safety instructions. These are available at any authorized Mercedes-Benz Center.

- !** If the front-passenger seat is not occupied, do not engage the seat belt tongue in the buckle on the front-passenger seat. Otherwise, the Emergency Tensioning Device could be triggered in the event of an accident.

The seat belts are equipped with Emergency Tensioning Devices and belt force limiters. The ETDs tighten the seat belts in an accident, pulling them close against the body.

The ETDs do not correct incorrect seat positions or incorrectly fastened seat belts.

The ETDs do not pull vehicle occupants back towards the backrest.

When triggered, seat belt force limiters help to reduce the peak force exerted by the seat belt on the vehicle occupant.

The seat belt force limiters are synchronized with the front air bags, which take on a part of the deceleration force. Thus, the force exerted on the occupant is distributed over a greater area.

The ETDs can only be activated when:

- the ignition is switched on.
- the restraint systems are operational; see "SRS warning lamp" (▷ page 39).
- the belt tongue is engaged in the buckle on each of the three-point seat belts.

The ETDs are triggered depending on the type and severity of an accident:

- if, in the event of a head-on or rear-end collision, the vehicle decelerates or accelerates rapidly in a longitudinal direction during the initial stages of the impact
- if, in the event of a side impact, on the side opposite the impact the vehicle decelerates or accelerates rapidly in a lateral direction
- if, in certain situations where the vehicle overturns, the system determines that it can provide additional protection

If the ETDs are deployed, you will hear a bang, and a small amount of powder may also be released. Only in rare cases will the bang affect your hearing. The powder that is released generally does not constitute a health hazard. The  SRS warning lamp lights up.

Child restraint systems

Important safety notes



WARNING



Children 12 years old and under must be seated and properly secured in an appropriate infant restraint, toddler restraint, or booster seat recommended for the size and weight of the child.

The infant or child restraint system must be correctly secured using the vehicle's seat belt in complete accordance with the child seat manufacturer's instructions.

Occupants, in particular children, must sit as upright as possible, fasten the seat belt correctly and use a suitable infant restraint system, child restraint system or booster seat suitable for the size and weight of the child.

Children can be seriously or even fatally injured by an air bag deploying. Observe the following information:

- Your vehicle is equipped with air bag technology designed to deactivate the front-passenger front air bag in your vehicle when the system senses the weight of a typical 12-month-old child or less along with the weight of a standard appropriate child restraint on the passenger seat.
- A child in a rearward-facing child restraint system on the front-passenger seat could be seriously injured or even killed if the front-passenger air bag inflates in a collision despite the air bag technology installed in your vehicle, which could occur under some circumstances.
- If you install a rearward-facing child restraint on the front-passenger seat, make sure that the  PASSENGER AIR BAG OFF indicator lamp is illuminated, indicating that the front-passenger front air bag is deactivated. Should the  PASSENGER AIR BAG OFF indicator lamp not illuminate or go out while a rearward-facing child restraint system is installed, please check installation. Periodically

check the  PASSENGER AIR BAG OFF indicator lamp while driving to make sure it is illuminated. If the  PASSENGER AIR BAG OFF indicator lamp goes out or remains out, do not transport a child on the front-passenger seat.

- A child in a rearward-facing child restraint system on the front-passenger seat can be seriously injured or even killed if the front-passenger air bag is deployed.
- When securing a child in a child restraint system on the front-passenger seat, you must:
 - move the front-passenger seat as far back as possible
 - use a child restraint system that is suitable for the age, size and weight of the child
 - observe the manufacturer's installation instructions in order to install and secure the child restraint system correctly.
- For children larger than the typical 12-month-old child, the front-passenger front air bag may or may not be activated.

WARNING

Infants and small children should never share a seat belt with another occupant. In the event of an accident, they could be crushed between the occupant and seat belt.

A child's risk of serious or fatal injuries is significantly increased if the child restraints are not properly secured in the vehicle and/or the child is not properly secured in the child restraint.

Children that are too large for a child restraint must travel in seats using normal seat belts. Position the shoulder belt across the chest and shoulder, not face or neck. A booster seat may be necessary to achieve proper seat belt positioning for children over 41 lb (18 kg) until they reach a height where a lap-shoulder belt fits properly without a booster.

When the child restraint is not in use, remove it from the vehicle or secure it with the seat

belt to prevent the child restraint from becoming a projectile in the event of an accident.

WARNING

When leaving the vehicle, always remove the SmartKey from the ignition lock. Always take the SmartKey with you and lock the vehicle. Do not leave children unattended in the vehicle, even if they are secured in a child restraint system, or with access to an unlocked vehicle. A child's unsupervised access to a vehicle could result in an accident and/or serious personal injury. The children could:

- injure themselves on parts of the vehicle
- be seriously or fatally injured through excessive exposure to extreme heat or cold
- injure themselves or cause an accident with vehicle equipment that can be operated even if the SmartKey is removed from the ignition lock or removed from the vehicle, such as seat adjustment, steering wheel adjustment, or the memory function

If children open a door, they could injure other persons or get out of the vehicle and injure themselves or be injured by following traffic. Do not expose the child restraint system to direct sunlight. The child restraint system's metal parts, for example, could become very hot, and the child could be burned on these parts.

WARNING

Do not carry heavy or hard objects in the passenger compartment unless they are firmly secured in place.

Unsecured or improperly positioned cargo increases a child's risk of injury in the event of:

- strong braking maneuvers
- sudden changes of direction
- an accident

Information on the safe storage of loads
(▷ page 256).

If an infant or child is traveling in the vehicle:

- ▶ Secure the child with a child or infant seat restraint system appropriate to the age and weight of the child.
- ▶ Make sure that the infant or child is properly secured at all times while the vehicle is in motion.

Mercedes-Benz recommends that you always properly secure all infants and children with a child or infant seat restraint system for the trip.

The use of seat belts and infant and child restraint systems is required by law in:

- all 50 states
- U.S. territories
- the District of Columbia
- all Canadian provinces

Infants and children must always be seated in an appropriate infant or child restraint system recommended for the size and weight of the child. The infant or child restraint system must be properly secured with a three-point seat belt in accordance with the manufacturer's instructions.

All infant or child restraint systems must meet the following standards:

- U.S. Federal Motor Vehicle Safety Standards 213 and 225
- Canadian Motor Vehicle Safety Standards 213 and 210.2

An information label on the child restraint system indicates whether it meets these standards. This information is also provided in the installation instructions supplied with the child restraint system.

Always read and follow the manufacturer's instructions when using an infant or child restraint system or booster seat.

Observe the warning labels in the vehicle interior or on the infant or child restraint.

Special seat belt retractor

WARNING

If you release the seat belt when driving, the special seat belt retractor is deactivated.

The released seat belt cannot be engaged again while driving, because the inertia reel pulls in the seat belt a small distance. The child restraint system is no longer properly secured. There is an increased risk of serious injury or even fatal injury.

Always keep the seat belt of the activated special seat belt retractor engaged when driving.

The seat belt on the front-passenger side is equipped with a special seat belt retractor. When activated, the special seat belt retractor ensures that the seat belt will not slacken once the child restraint system has been secured.

Installing a child restraint system:

- ▶ Always comply with the manufacturer's installation instructions.
- ▶ Pull the seat belt smoothly from the seat belt retractor.
- ▶ Engage the seat belt tongue in the belt buckle.

Activating the special seat belt retractor:

- ▶ Pull the seat belt out fully and let the seat belt retractor retract it again. While the seat belt is retracting, you should hear a ratcheting sound. The special seat belt retractor is activated.
- ▶ Push down on the child restraint system to take up any slack.

Removing a child restraint system/
deactivating the special seat belt retractor:

- ▶ Always comply with the manufacturer's installation instructions.
- ▶ Press the seat belt release button and guide the belt tongue to the belt outlet. The special seat belt retractor is deactivated.

If necessary:

- ▶ Additionally move the seat backwards. The special seat belt retractor is deactivated.

If necessary:

- ▶ Additionally remove the seat belt from the seat belt guide on the seat backrest and guide the seat belt back to the belt sash guide. The special seat belt retractor is deactivated.

Driving safety systems

Driving safety systems overview

In this section, you will find information about the following driving safety systems:

- ABS (**A**nti-**l**ock **B**raking **S**ystem) (▷ page 59)
- BAS (**B**rake **A**ssist **S**ystem) (▷ page 60)
- BAS PLUS (**B**rake **A**ssist **S**ystem **PL**US) (▷ page 60)
- ESP® (**E**lectronic **S**tability **P**rogram) (▷ page 61)
- EBD (**e**lectronic **b**rake **f**orce **d**istribution) (▷ page 64)
- ADAPTIVE BRAKE (▷ page 65)
- PRE-SAFE® Brake (▷ page 65)

Important safety notes

If you fail to adapt your driving style or become distracted, the driving safety systems can neither reduce the risk of accident nor override the laws of physics. Driving safety systems are merely aids designed to assist driving. You are responsible for the distance to the vehicle in front, for vehicle speed and for braking in good time. Always adapt your driving style to suit the prevailing road and weather conditions and maintain a safe distance from the vehicle in front. Drive carefully.

- i** The driving safety systems described only work as effectively as possible when there is adequate contact between the tires and the road surface. Please pay special attention to the notes on tires, recommended minimum tire tread depths, etc. (▷ page 308).

In wintry driving conditions, always use winter tires (M+S tires) and if necessary, snow chains. Only in this way will the driving safety systems described in this section work as effectively as possible.

ABS (Anti-lock Braking System)

Important safety notes

- i** Observe the "Important safety notes" section (▷ page 59).

WARNING

If ABS is faulty, the wheels could lock when braking. The steerability and braking characteristics may be severely impaired. Additionally, further driving safety systems are deactivated. There is an increased danger of skidding and accidents.

Drive on carefully. Have ABS checked immediately at a qualified specialist workshop.

When ABS is malfunctioning, other systems, including driving safety systems, will also become inoperative. Observe the information on the ABS warning lamp (▷ page 244) and display messages which may be shown in the instrument cluster (▷ page 212).

ABS regulates brake pressure in such a way that the wheels do not lock when you brake. This allows you to continue steering the vehicle when braking.

ABS works from a speed of about 5 mph (8 km/h) upwards, regardless of road-surface conditions. ABS works on slippery surfaces, even if you only brake gently.

The yellow  ABS warning lamp in the instrument cluster lights up when the ignition

is switched on. It goes out when the engine is running.

Braking

- ▶ **If ABS intervenes:** continue to depress the brake pedal vigorously until the braking situation is over.
- ▶ **To make a full brake application:** depress the brake pedal with full force.

If ABS intervenes when braking, you will feel a pulsing in the brake pedal.

The pulsating brake pedal can be an indication of hazardous road conditions, and functions as a reminder to take extra care while driving.

BAS (Brake Assist System)

- ❗ Observe the "Important safety notes" section (▷ page 59).

WARNING

If BAS is malfunctioning, the braking distance in an emergency braking situation is increased. There is a risk of an accident.

In an emergency braking situation, depress the brake pedal with full force. ABS prevents the wheels from locking.

BAS operates in emergency braking situations. If you depress the brake pedal quickly, BAS automatically boosts the braking force, thus shortening the stopping distance. The brakes will function as usual once you release the brake pedal. BAS is deactivated.

BAS PLUS (Brake Assist System Plus)

- ❗ Observe the "Important safety notes" section (▷ page 59).

BAS PLUS is only available in vehicles equipped with DISTRONIC PLUS.

BAS PLUS provides braking assistance in hazardous situations at speeds greater than

20 mph (30 km/h) and uses radar sensor technology to assess the traffic situation.

With the help of the radar sensor system, BAS PLUS can detect obstacles that are in the path of your vehicle for an extended period of time.

At speeds up to 40 mph (70 km/h), BAS PLUS may also detect stationary obstacles, for example, stopped or parked vehicles.

To prevent a front-end collision, BAS PLUS calculates the brake force necessary if:

- you approach an obstacle, and
- BAS PLUS has detected a risk of collision

Should you apply the brakes forcefully, BAS PLUS will automatically increase the braking force to a level suitable for the traffic conditions.

If BAS PLUS demands particularly high braking force, preventative passenger protection measures (PRE-SAFE®) are activated simultaneously.

- ▶ Keep the brake pedal depressed until the emergency braking situation is over. ABS prevents the wheels from locking.

BAS PLUS is deactivated and the brakes function as usual, if:

- you release the brake pedal.
- there is no longer any danger of a rear-end collision.
- no obstacle is detected in front of your vehicle.

For BAS PLUS to assist you when driving, the radar sensor system must be:

- switched on (▷ page 206)
- be operational (▷ page 229)

If the radar sensor system is malfunctioning, BAS PLUS will not be available. The brake system is still available with complete brake boosting effect and BAS.

WARNING

BAS PLUS cannot always clearly identify objects and complex traffic situations. BAS

PLUS cannot intervene in these cases. There is a risk of an accident.

Always pay careful attention to the traffic situation and be ready to brake.

In particular, the detection of obstacles can be impaired if there is:

- dirt on the sensors or anything else covering the sensors
- snow or heavy rain
- interference by other radar sources
- the possibility of strong radar reflections, for example in parking garages
- a narrow vehicle traveling in front, e.g. a motorbike
- a vehicle traveling in front on a different line relative to the center of your vehicle

WARNING

BAS PLUS does not react:

- to people or animals
- to oncoming vehicles
- to crossing traffic
- when cornering

As a result, BAS PLUS may not intervene in all critical situations. There is a risk of an accident.

Always pay careful attention to the traffic situation and be ready to brake.

Following damage to the front end of the vehicle, have the configuration and operation of the radar sensors checked at a qualified specialist workshop. This also applies to collisions at low speeds where there is no visible damage to the front of the vehicle.

- i** This device has been approved by the FCC as a "Vehicular Radar System". The radar sensor is intended for use in an automotive radar system only. Removing, altering or tampering with the device will void any warranties, and is not permitted by the FCC. Do not tamper with, alter, or use the device in any non-approved way.

Any unauthorized modification to this device could void the user's authority to operate the equipment.

ESP® (Electronic Stability Program)

Important safety notes

- i** Observe the "Important safety notes" section (▷ page 59).

WARNING



If ESP® is malfunctioning, ESP® is unable to stabilize the vehicle. Additionally, further driving safety systems are deactivated. This increases the risk of skidding and an accident.

Drive on carefully. Have ESP® checked at a qualified specialist workshop.

- !** When testing the electric parking brake on a braking dynamometer, switch off the ignition. Application of the brakes by ESP® may otherwise destroy the brake system.

When towing the vehicle with the rear axle raised, observe the notes on ESP® (▷ page 302).

ESP® is deactivated if the  warning lamp in the instrument cluster lights up continuously when the engine is running.

If the  warning lamp and the  warning lamp are lit continuously, ESP® is not available due to a malfunction.

Observe the information on warning lamps (▷ page 246) and display messages which may be shown in the instrument cluster (▷ page 212).

If ESP® detects that the vehicle is deviating from the direction desired by the driver, one or more wheels are braked to stabilize the vehicle. The engine output is also modified to keep the vehicle on the desired course within physical limits. ESP® assists the driver when pulling away on wet or slippery roads. ESP® can also stabilize the vehicle during braking.

If ESP® intervenes, the  ESP® warning lamp flashes in the instrument cluster.

If ESP® intervenes:

- ▶ Do not deactivate ESP® under any circumstances.
- ▶ Only depress the accelerator pedal as far as necessary when pulling away.
- ▶ Adapt your driving style to suit the prevailing road and weather conditions.

- 1** Only use wheels with the recommended tire sizes. Only then will ESP® function properly.

4ETS (Electronic Traction System)

- i** Observe the "Important safety notes" section (▷ page 59).

Traction control is part of ESP®.

Traction control brakes the drive wheels individually if they spin. This enables you to pull away and accelerate on slippery surfaces, for example if the road surface is slippery on one side.

Traction control remains active if you deactivate ESP®.

Deactivating/activating ESP® (except AMG vehicles)

- i** Observe the "Important safety notes" section (▷ page 59).

WARNING

If you deactivate ESP®, ESP® no longer stabilizes the vehicle. There is an increased risk of skidding and an accident.

Only deactivate ESP® in the situations described in the following.

- !** Avoid spinning the driven wheels for an extended period with ESP® deactivated. You could otherwise damage the drivetrain.



- ▶ **To switch off:** press button **1**.

The  ESP® OFF warning lamp in the instrument cluster lights up.

- ▶ **To switch on:** press button **1**.

The  ESP® OFF warning lamp in the instrument cluster goes out.

ESP® is activated automatically when the engine is started.

The ECO start/stop function switches the engine off automatically if the vehicle stops moving. The engine starts automatically when the driver wants to pull away again. ESP® remains in its previously selected status.

Example: if ESP® was deactivated before the engine was switched off, ESP® remains deactivated when the engine is switched on again.

If ESP® is deactivated and one or more wheels start to spin, the  ESP® warning lamp in the instrument cluster flashes. In such situations, ESP® will not stabilize the vehicle.

It may be best to deactivate ESP® in the following situations:

- when using snow chains
- in deep snow
- on sand or gravel

If you deactivate ESP®:

- ESP® no longer improves driving stability.
- traction control is still activated.

- ESP® still provides support when you brake.
- engine torque is not limited and the drive wheels are able to spin. The spinning wheels produce a cutting effect for better traction.

Deactivating/activating ESP® (AMG vehicles)

Activating/deactivating SPORT handling mode

WARNING

When SPORT handling mode is activated, there is a greater risk of skidding and accidents.

Only activate SPORT handling mode in the situations described in the following.



- **To activate:** briefly press button ①. The **SPORT** SPORT handling mode warning lamp in the instrument cluster lights up. The **SPORT handling mode** message appears in the multifunction display. SPORT handling mode is designed for driving on designated roads when the vehicle's own oversteering and understeering characteristics are desired. Driving in SPORT handling mode requires an extremely qualified and experienced driver who is able to cope with these critical driving conditions.
- **To deactivate:** briefly press button ①. The **SPORT** SPORT handling mode warning lamp in the instrument cluster goes out.

ESP® is activated automatically when the engine is started.

It may be best to activate SPORT handling mode in the following situations:

- when using snow chains
- in deep snow
- on sand or gravel

If SPORT handling mode is activated and one or more wheels start to spin, the  ESP® warning lamp in the instrument cluster flashes. ESP® only stabilizes the vehicle to a limited degree.

When SPORT handling mode is activated:

- ESP® only improves driving stability to a limited degree.
- traction control is still activated.
- ESP® still provides support when you brake firmly.
- engine torque is only restricted to a limited degree, and the drive wheels are able to spin. The spinning wheels produce a cutting effect for better traction.

Vehicles with ECO start/stop function: the ECO start/stop function switches the engine off automatically when the vehicle comes to a stop. The engine starts automatically when the driver wants to pull away again. ESP® remains in its previously selected status.

Example: if ESP® was deactivated before the engine was switched off, ESP® remains deactivated when the engine is switched on again.

Deactivating/activating ESP®

WARNING

If you deactivate ESP®, ESP® no longer stabilizes the vehicle. There is an increased risk of skidding and an accident.

Only deactivate ESP® in the situations described in the following.

- Avoid spinning the driven wheels for an extended period with ESP® deactivated. You could otherwise damage the drivetrain.





► **To deactivate:** press button ① until the  ESP® OFF warning lamp lights up in the instrument cluster.

The  OFF message appears in the multifunction display.

Deactivate ESP® when driving on designated roads when the vehicle's own oversteering and understeering characteristics are desired. Driving without ESP® requires an extremely qualified and experienced driver who is able to cope with these critical driving conditions.

► **To activate:** briefly press button ①.

The  ESP® OFF warning lamp in the instrument cluster goes out. The  ON message appears in the multifunction display.

ESP® is activated automatically when the engine is started.

If ESP® is deactivated and one or more wheels start to spin, the ESP®  warning lamp in the instrument cluster does not flash. In such situations, ESP® will not stabilize the vehicle. It may be best to deactivate ESP® in the following situations:

- when using snow chains
- in deep snow
- on sand or gravel

If you deactivate ESP®:

- ESP® no longer improves driving stability.
- traction control is still activated.

- PRE-SAFE® is no longer available, nor is it activated if you brake firmly and ESP® intervenes.
- PRE-SAFE® Brake is no longer available, it is also not activated if you brake firmly and ESP® intervenes.
- ESP® still provides support when you brake firmly.
- engine torque is no longer limited and the drive wheels are able to spin. The spinning wheels produce a cutting effect for better traction.

Vehicles with ECO start/stop function: the ECO start/stop function switches the engine off automatically when the vehicle comes to a stop. The engine starts automatically when the driver wants to pull away again. ESP® remains in its previously selected status.

Example: if ESP® was deactivated before the engine was switched off, ESP® remains deactivated when the engine is switched on again.

EBD (electronic brake force distribution)

 Observe the "Important safety notes" section (► page 59).

WARNING

If EBD has malfunctioned, the rear wheels can still lock, e.g. under full braking. This increases the risk of skidding and an accident. You should therefore adapt your driving style to the different handling characteristics. Have the brake system checked at a qualified specialist workshop.

Observe information regarding indicator and warning lamps (► page 244) as well as display messages (► page 214).

EBD monitors and controls the brake pressure on the rear wheels to improve driving stability while braking.

ADAPTIVE BRAKE

ADAPTIVE BRAKE enhances braking safety and offers increased braking comfort. In addition to the braking function, ADAPTIVE BRAKE also has the HOLD function (▷ page 177) and hill start assist (▷ page 139).

PRE-SAFE® Brake

i Observe the "Important safety notes" section (▷ page 59).

PRE-SAFE® Brake is only available in vehicles with DISTRONIC PLUS.

PRE-SAFE® Brake can help you to minimize the risk of a collision with a vehicle ahead or reduce the effects of such a collision. If PRE-SAFE® Brake detects a risk of collision, you will be warned visually and acoustically as well as by automatic braking. PRE-SAFE® Brake cannot prevent a collision without your intervention.

Starting at a speed of around 20 mph (30 km/h), this function warns you if you very quickly approach a vehicle in front. An intermittent warning tone will then sound and the  distance warning lamp will light up in the instrument cluster.

► Brake immediately in order to increase the distance from the vehicle in front.

or

► Take evasive action provided it is safe to do so.

From a speed of approximately 20 mph (30 km/h), if the driver and front passenger have fastened their seat belts, PRE-SAFE® Brake can brake the vehicle automatically at speeds up to approximately 124 mph (200 km/h).

Due to the nature of the system, particularly complicated driving conditions may cause unnecessary warnings or the unnecessary intervention of PRE-SAFE® Brake.

You can prevent the intervention of the PRE-SAFE® Brake at any time by:

- depressing the accelerator pedal further
- activating kickdown
- releasing the brake pedal.

The braking action of PRE-SAFE® Brake is ended automatically if:

- you maneuver to avoid the obstacle.
- there is no longer any danger of a rear-end collision.
- there is no longer an obstacle detected in front of your vehicle.

With the help of the radar sensor system, PRE-SAFE® Brake can detect obstacles that are in front of your vehicle for an extended period of time.

At speeds up to approximately 40 mph (70 km/h), PRE-SAFE® Brake can also detect stationary obstacles such as stopped or parked vehicles.

If you approach an obstacle and PRE-SAFE® Brake detects a risk of a collision, the system will alert you both visually and acoustically. If you do not brake or take evasive action, the system will warn you by automatically braking the vehicle gently. If there is an increased risk of collision, preventative passenger protection measures (PRE-SAFE®) are activated (▷ page 50).

If a risk of collision remains and you do not brake, take evasive action or significantly accelerate, automatic braking may be performed up to a level of automatic emergency braking. Automatic emergency braking is not performed until immediately prior to an accident that can no longer be avoided.

WARNING

PRE-SAFE® Brake will initially brake your vehicle by a partial application of the brakes if a danger of collision is detected. There may be a collision unless you also brake. Automatic emergency braking cannot prevent a collision. There is a risk of an accident.

Always apply the brakes yourself and try to take evasive action.

WARNING

PRE-SAFE® Brake cannot always clearly identify objects and complex traffic conditions.

In these cases, PRE-SAFE® Brake may:

- give an unnecessary warning and then brake the vehicle
- not give a warning or intervene

There is a risk of an accident.

Always pay particular attention to the traffic situation and be ready to brake, especially if PRE-SAFE® Brake warns you. Terminate the intervention in a non-critical driving situation.

In particular, the detection of obstacles can be impaired if there is:

- dirt on the sensors or anything else covering the sensors
- snow or heavy rain
- interference by other radar sources
- the possibility of strong radar reflections, for example in parking garages
- a narrow vehicle traveling in front, e.g. a motorbike
- a vehicle traveling in front on a different line relative to the center of your vehicle

WARNING



PRE-SAFE® Brake does not react:

- to people or animals
- to oncoming vehicles
- to crossing traffic
- when cornering

As a result, PRE-SAFE® Brake may neither give warnings nor intervene in all critical situations. There is a risk of an accident.

Always pay careful attention to the traffic situation and be ready to brake.

In order to maintain the appropriate distance to the vehicle in front and thus prevent a collision, you must apply the brakes yourself.

► **To activate/deactivate:** activate or deactivate PRE-SAFE® Brake in the on-board computer (▷ page 202).
When PRE-SAFE® Brake is activated, the  symbol appears in the multifunction display as long as the HOLD function is deactivated (▷ page 177). On vehicles with Parking Guidance, the  symbol is displayed when position **P** is engaged or you are driving faster than 22 mph (35 km/h).

For PRE-SAFE® Brake to assist you when driving, the radar sensor system must be switched on (▷ page 206) and be operational.

Following damage to the front end of the vehicle, have the configuration and operation of the radar sensors checked at a qualified specialist workshop. This also applies to collisions at low speeds where there is no visible damage to the front of the vehicle.

i USA only: This device has been approved by the FCC as a "Vehicular Radar System". The radar sensor is intended for use in an automotive radar system only. Removing, altering or tampering with the device will void any warranties, and is not permitted by the FCC. Do not tamper with, alter, or use the device in any non-approved way. Any unauthorized modification to this device could void the user's authority to operate the equipment.

Theft deterrent locking system

Immobilizer

- **To activate with the SmartKey:** remove the SmartKey from the ignition lock.
- **To activate with KEYLESS-GO:** switch the ignition off and open the driver's door.
- **To deactivate:** switch on the ignition.

The immobilizer prevents your vehicle from being started without the correct SmartKey. When leaving the vehicle, always take the SmartKey with you and lock the vehicle. The engine can be started by anyone with a valid SmartKey that is left inside the vehicle.

i The immobilizer is always deactivated when you start the engine.

In the event that the engine cannot be started when the starter battery is fully charged, the immobilizer may be faulty. Contact an authorized Mercedes-Benz Center or call 1-800-FOR-MERCEDES (in USA) or 1-800-387-0100 (in Canada).

ATA (anti-theft alarm system)





► **To arm:** lock the vehicle with the SmartKey or KEYLESS-GO.

Indicator lamp ① flashes. The alarm system is armed after approximately 15 seconds.

► **To disarm:** unlock the vehicle with the SmartKey or KEYLESS-GO.

A visual and audible alarm is triggered if the alarm system is armed and you open:

- a door
- the vehicle with the mechanical key
- the trunk
- the hood
- the glove box
- the stowage space under the armrest
- a stowage compartment in the rear

► **To turn the alarm off with the SmartKey:** press the  or  button on the SmartKey.

The alarm is switched off.

or

► Insert the SmartKey into the ignition lock. The alarm is switched off.

► **To stop the alarm using KEYLESS-GO:** grasp the outside door handle. The SmartKey must be outside the vehicle. The alarm is switched off.

or

► Press the Start/Stop button on the dashboard. The SmartKey must be inside the vehicle.

The alarm is switched off.

The alarm is not switched off, even if you close the open door that has triggered it, for example.

i If the alarm stays on for more than 30 seconds, the emergency call system (USA only) or the TELE AID system (Canada only) initiates a call to the Customer Assistance Center automatically. The Tele Aid system will initiate the call provided that:

- you have subscribed to the Tele Aid service.
- the Tele Aid service has been activated properly.
- the required mobile phone, power supply and GPS are available.

امداد خودرو فارما

تلفن شبانه روزی: ۰۲۱-۸۸۸۶۲۰۸۵

FarmaSOS.com

Useful information	70
SmartKey	70
Doors	76
Trunk	79
Side windows	82
Roof	85

امداد خودرو فارما

تلفن شبانه روزی: ۰۲۱-۸۸۸۶۲۰۸۵

FarmaSOS.com

Useful information

- 1 This Operator's Manual describes all models and all standard and optional equipment of your vehicle available at the time of publication of the Operator's Manual. Country-specific differences are possible. Please note that your vehicle may not be equipped with all features described. This also applies to safety-related systems and functions.
- 1 Read the information on qualified specialist workshops: (▷ page 23).

SmartKey

Important safety notes

WARNING

When leaving the vehicle, always remove the SmartKey from the ignition lock. Always take the SmartKey with you and lock the vehicle. Do not leave children unsupervised in the vehicle, even if they are secured in a child restraint system, and do not give them access to an unlocked vehicle. A child's unsupervised access to a vehicle could result in an accident and/or serious personal injury. They could:

- injure themselves on vehicle parts
- be seriously or fatally injured by extreme heat or cold
- injure themselves or have an accident with vehicle equipment that may still be in operation even after the SmartKey has been removed from the ignition, such as the seat adjustment, steering wheel adjustment or memory function.

If children open a door, they could cause severe or even fatal injury to other persons; if they get out of the vehicle, they could injure themselves when doing so or be seriously or even fatally injured by any passing traffic.

Do not expose the child restraint system to direct sunlight. The child restraint system's metal parts, for example, could become very

hot, and a child could be burned on these parts.

WARNING

If a key ring is too heavy or too large, the weight acting on the SmartKey could cause it to turn in the ignition lock or catch on the steering wheel. This could cause the engine to be switched off suddenly. You could lose control of the vehicle and cause an accident. Do not attach any heavy or large key rings to the SmartKey that is inserted in the ignition.

USA only:

This device complies with Part 15 of the FCC Rules. Operation is subject to the following two conditions:

1. This device may not cause interference, and
2. this device must accept any interference received, including interference that may cause undesired operation.

Any unauthorized modification to this device could void the user's authority to operate the equipment.

The Product label with FCC ID and IC certification number can be found in the battery case of the SmartKey.

Canada only:

This device complies with RSS-210 of Industry Canada. Operation is subject to the following two conditions:

1. This device may not cause interference, and
2. this device must accept any interference received, including interference that may cause undesired operation.

Any unauthorized modification to this device could void the user's authority to operate the equipment.

The Product label with FCC ID and IC certification number can be found in the battery case of the SmartKey.

- Do not keep the SmartKey:
 - with electronic devices, e.g. a mobile phone or another SmartKey
 - with metallic objects, e.g. coins or metal foil
 - inside metallic objects, e.g. a metal case

This can affect the SmartKey's functionality.

Keep the SmartKey away from strong magnetic fields. Otherwise, the remote control function could be affected.

- the stowage compartment in the center console
- the fuel filler flap



When unlocking, the turn signals flash once. When locking, they flash three times.

You can also set an audible signal to confirm that the vehicle has been locked. The audible signal can be activated and deactivated using the on-board computer (▷ page 206).

When it is dark, the surround lighting also comes on if it is activated in the on-board computer (▷ page 205).

SmartKey functions



- ①  To lock the vehicle
- ②  To unlock the trunk lid
- ③  To unlock the vehicle

- ▶ **To unlock centrally:** press the  button.

If you do not open the vehicle within approximately 40 seconds of unlocking:

- the vehicle is locked again.
- the theft deterrent locking system is armed again.

- ▶ **To lock centrally:** press the  button.

The SmartKey centrally locks/unlocks:

- the doors
- the trunk lid
- the glove box

KEYLESS-GO

General notes

Bear in mind that the engine can be started by any of the vehicle occupants if there is a KEYLESS-GO key in the vehicle.

Locking and unlocking centrally

You can start, lock or unlock the vehicle using KEYLESS-GO. To do this, you only need carry the SmartKey with you. When you touch the surface of the sensors on the vehicle's outside door handles, KEYLESS-GO establishes a radio connection between the vehicle and the SmartKey. When the engine is started and whilst you are driving, KEYLESS-GO also checks whether a valid SmartKey is in the vehicle by periodically establishing radio contact.

You can combine the functions of KEYLESS-GO with those of a conventional key. Unlock the vehicle by using KEYLESS-GO, for instance, and lock it using the  button on the SmartKey.

When locking or unlocking with KEYLESS-GO, the distance between the SmartKey and the corresponding door handle must not be greater than 3 ft (1 m).

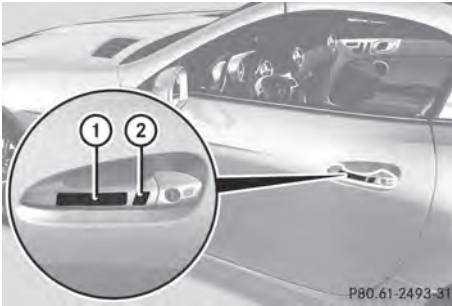





- ▶ **To unlock the vehicle:** touch the inner surface of the door handle.
- ▶ **To lock the vehicle:** touch sensor surface ①.
- ▶ **Convenience closing feature:** touch recessed sensor surface ② for an extended period (▷ page 83).

Further information on the convenience closing feature (▷ page 83).



If you pull on the handle of the trunk lid, only the trunk of the vehicle is unlocked.

Changing the settings of the locking system



You can change the settings of the locking system. This means only the driver's door, the lockable stowage compartments in the vehicle interior and the fuel filler flap are unlocked when the vehicle is unlocked. This is useful if you frequently travel on your own.

- ▶ **To change the setting:** press and hold down the  and  buttons simultaneously for approximately six seconds until the battery check lamp flashes twice (▷ page 73).
- ❗ If the setting of the locking system is changed within the signal range of the vehicle, pressing the  or  button:
 - locks or
 - unlocks the vehicle

The SmartKey now functions as follows:

- ▶ **To unlock the driver's door:** press the  button once.
- ▶ **To unlock centrally:** press the  button twice.
- ▶ **To lock centrally:** press the  button.

The KEYLESS-GO function is changed as follows:

- ▶ **To unlock the driver's door:** touch the inner surface of the door handle on the driver's door.
- ▶ **To unlock centrally:** touch the inner surface of the front-passenger door handle.
- ▶ **To lock centrally:** touch the outer sensor surface on one of the door handles.
- ▶ **To restore the factory settings:** press and hold down the  and  buttons simultaneously for approximately six seconds until the battery check lamp flashes twice (▷ page 73).



Mechanical key

General notes

If the vehicle can no longer be locked or unlocked with the SmartKey, use the mechanical key.

If you use the mechanical key to unlock and open the driver's door or the trunk lid, the anti-theft alarm system will be triggered (▷ page 67).

There are several ways to turn off the alarm:

- ▶ **To turn the alarm off with the SmartKey:** press the  or  button on the SmartKey.
- or
- ▶ Insert the SmartKey into the ignition lock.
- or
- ▶ **To deactivate the alarm with KEYLESS-GO:** press the Start/Stop button in the ignition lock. The SmartKey must be in the vehicle.

or

- ▶ Lock or unlock the vehicle using KEYLESS-GO. The SmartKey must be outside the vehicle.

If you unlock the vehicle using the mechanical key, the fuel filler flap will not be unlocked automatically.

- ▶ **To unlock the fuel filler flap:** insert the SmartKey into the ignition lock.

Removing the mechanical key



- ▶ Push release catch ① in the direction of the arrow and at the same time, remove mechanical key ② from the SmartKey.

SmartKey battery

Important safety notes

WARNING

Batteries contain toxic and caustic substances. For this reason, keep batteries out of the reach of children.

If a battery has been swallowed, seek medical help immediately.

WARNING





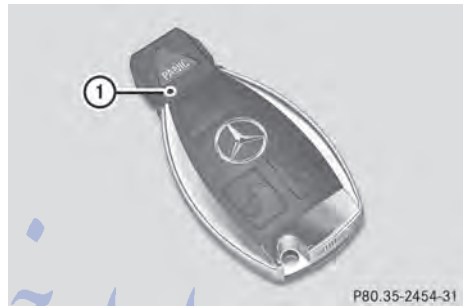

The SmartKey batteries contain perchlorate material, which may require special handling and regard for the environment. Observe government disposal guidelines. California residents, see www.dtsc.ca.gov/

HazardousWaste/Perchlorate/ index.cfm.

Mercedes-Benz recommends that you have the batteries replaced at a qualified specialist workshop.

Checking the battery



- ▶ Press the  or  button. The battery is working properly if battery check lamp ① lights up briefly. The battery is discharged if battery check lamp ① does not light up briefly.
- ▶ Changing the battery (▷ page 73)
-  If the SmartKey battery is checked within the signal reception range of the vehicle, pressing the  or  button:
 - locks or
 - unlocks the vehicle
-  You can get a battery in any qualified specialist workshop.

Replacing the battery

You require a CR 2025 3 V cell battery.

- ▶ Take the mechanical key out of the SmartKey (▷ page 72).





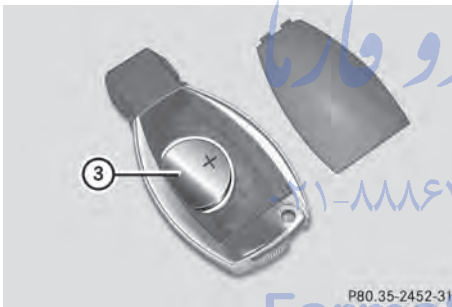



- ▶ Press mechanical key ② into the opening in the key in the direction of the arrow until battery compartment cover ① opens. When doing so, do not hold battery compartment cover ① shut.
- ▶ Remove battery compartment cover ①.



- ▶ Repeatedly tap the SmartKey against your palm until battery ③ falls out.
- ▶ Insert the new battery with the positive terminal facing upwards. Use a lint-free cloth to do so.
- ▶ Make sure that the surface of the battery is free from lint, grease and all other forms of contamination.
- ▶ Insert the front tabs of battery compartment cover ① into the housing and then press to close it.
- ▶ Insert mechanical key ② into the SmartKey.
- ▶ Check the function of all SmartKey buttons on the vehicle.

Problems with the SmartKey

Problem	Possible causes/consequences and ► Solutions
<p>You cannot lock or unlock the vehicle using the SmartKey.</p>	<p>The SmartKey battery is discharged or nearly discharged.</p> <ul style="list-style-type: none"> ► Try again to lock/unlock the vehicle using the remote control function of the SmartKey. Point the tip of the SmartKey at the driver's door handle from close range and press the  or  button. <p>If this does not work:</p> <ul style="list-style-type: none"> ► Check the SmartKey battery (▷ page 73) and replace it if necessary (▷ page 73). ► Lock (▷ page 78) or unlock (▷ page 78) the vehicle using the mechanical key. <p>The SmartKey is faulty.</p> <ul style="list-style-type: none"> ► Unlock (▷ page 78) or lock (▷ page 78) the vehicle using the mechanical key. ► Have the SmartKey checked at a qualified specialist workshop.
<p>You can no longer lock or unlock the vehicle using KEYLESS-GO.</p>	<p>There is interference from a powerful source of radio waves.</p> <ul style="list-style-type: none"> ► Lock/unlock the vehicle using the remote control function of the SmartKey. Point the tip of the SmartKey at the driver's door handle from close range and press the  or  button. <p>There is a malfunction with KEYLESS-GO.</p> <ul style="list-style-type: none"> ► Lock/unlock the vehicle using the remote control function of the SmartKey. Point the tip of the SmartKey at the driver's door handle from close range and press the  or  button. ► Have KEYLESS-GO checked at a qualified specialist workshop. <p>If this does not work:</p> <ul style="list-style-type: none"> ► Check the SmartKey battery (▷ page 73) and replace it if necessary (▷ page 73). ► Lock (▷ page 78) or unlock (▷ page 78) the vehicle using the mechanical key.
<p>You have lost a SmartKey.</p>	<ul style="list-style-type: none"> ► Have the SmartKey deactivated at a qualified specialist workshop. ► Report the loss immediately to the vehicle insurers. ► If necessary, have the locks changed as well.
<p>You have lost the mechanical key.</p>	<ul style="list-style-type: none"> ► Report the loss immediately to the vehicle insurers. ► If necessary, have the locks changed as well.

Problem	Possible causes/consequences and ► Solutions
The engine cannot be started using the SmartKey.	<p>the on-board voltage is too low.</p> <ul style="list-style-type: none"> ► Switch off non-essential consumers, e.g. seat heating or interior lighting, and try to start the engine again. <p>If this does not work:</p> <ul style="list-style-type: none"> ► Check the starter battery and charge it if necessary (▷ page 298). <p>or</p> <ul style="list-style-type: none"> ► Jump-start the vehicle (▷ page 299). <p>or</p> <ul style="list-style-type: none"> ► Consult a qualified specialist workshop.
The engine cannot be started using KEYLESS-GO. The SmartKey is in the vehicle.	<p>A door is open. Therefore, the SmartKey cannot be detected as easily.</p> <ul style="list-style-type: none"> ► Close the door and try to start the vehicle again. <p>There is interference from a powerful source of radio waves.</p> <ul style="list-style-type: none"> ► Start your vehicle with the SmartKey in the ignition lock.

Doors

Important safety notes

WARNING

When leaving the vehicle, always remove the SmartKey from the ignition lock. Always take the SmartKey with you and lock the vehicle. Do not leave children unsupervised in the vehicle, even if they are secured in a child restraint system, and do not give them access to an unlocked vehicle. A child's unsupervised access to a vehicle could result in an accident and/or serious personal injury. They could:

- injure themselves on vehicle parts
- be seriously or fatally injured by extreme heat or cold
- injure themselves or have an accident with vehicle equipment that may still be in operation even after the SmartKey has been removed from the ignition, such as the seat adjustment, steering wheel adjustment or memory function.

If children open a door, they could cause severe or even fatal injury to other persons; if they get out of the vehicle, they could injure themselves when doing so or be seriously or even fatally injured by any passing traffic.

Do not expose the child restraint system to direct sunlight. The child restraint system's metal parts, for example, could become very hot, and a child could be burned on these parts.

WARNING

Do not carry heavy or hard objects in the passenger compartment unless they are firmly secured in place.

Unsecured or improperly positioned cargo increases a child's risk of injury in the event of:

- strong braking maneuvers
- sudden changes of direction
- an accident

Unlocking and opening doors from the inside

i The side windows will not open/close if the battery is discharged or if the side windows have iced up. It will then not be possible to close the door. Do not attempt to force the door closed. You could otherwise damage the door or the side window.

You can open a door from inside the vehicle even if it has been locked.

If the vehicle was previously locked with the SmartKey or with KEYLESS-GO, opening the vehicle from the inside will activate the anti-theft alarm system. Switch off the alarm (▷ page 67).

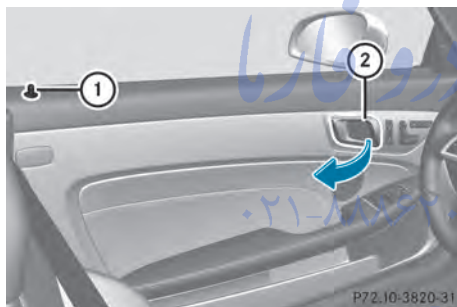

► Pull door handle (2).
If the door is locked, locking knob (1) pops up. The door is unlocked and can be opened.

i When a door is opened, the side window on that side opens slightly. When the door is closed, the side window closes again.

Centrally locking and unlocking the vehicle from the inside

You can centrally lock or unlock the vehicle from the inside. For example, you can unlock the front-passenger door from the inside or lock the vehicle before you pull away.

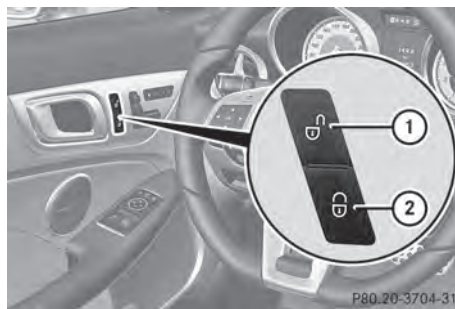

► **To unlock:** press button (1).

► **To lock:** press button (2).

If the front-passenger door is closed, the vehicle locks.

The central locking/unlocking button does not lock or unlock the fuel filler flap or the stowage compartments, such as the glove box.

You cannot unlock the vehicle centrally from the inside if the vehicle has been locked with the SmartKey or KEYLESS-GO.

You can open a door from inside the vehicle even if it has been locked.

If the vehicle has been locked using the locking button for the central locking, or has been locked automatically, and a door is opened from the inside:

- the vehicle will be fully unlocked if it had previously been fully unlocked
- only the door which has been opened from the inside is unlocked if only the driver's door had been previously unlocked

Automatic locking feature

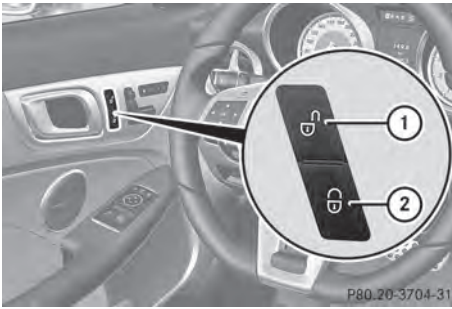

- ① Disarming
- ② Arming

- ▶ **To disarm:** press and hold button ① for about five seconds until a tone sounds.
- ▶ **To arm:** press and hold button ② for about five seconds until a tone sounds.

i If you press one of the two buttons and do not hear a tone, the relevant setting has already been selected.

The vehicle is locked automatically when the ignition is switched on and the wheels are turning.

You could therefore lock yourself out if:

- the vehicle is being pushed.
- the vehicle is being towed.
- the vehicle is on a roller dynamometer.

You can also switch the automatic locking function on and off using the on-board computer (▷ page 206).

Unlocking the driver's door (mechanical key)

If the vehicle can no longer be unlocked with the SmartKey, use the mechanical key.

If you use the mechanical key to unlock and open the driver's door, the anti-theft alarm system will be triggered (▷ page 67).

- ▶ Take the mechanical key out of the SmartKey (▷ page 72).
- ▶ Insert the mechanical key into the lock of the driver's door as far as it will go.

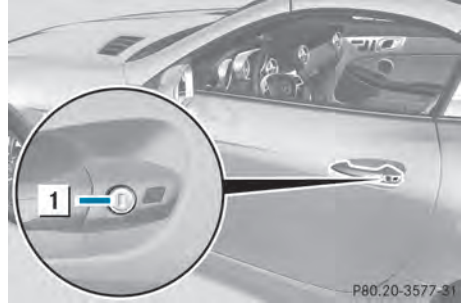

- ▶ Turn the mechanical key counter-clockwise to position 1.
- ▶ The door is unlocked.
- ▶ Turn the mechanical key back and remove it.
- ▶ Insert the mechanical key into the SmartKey.

Locking the vehicle (mechanical key)

If the vehicle can no longer be locked with the SmartKey, use the mechanical key.

- ▶ Open the driver's door.
- ▶ Close the front-passenger door and the trunk lid.
- ▶ Press the locking button (▷ page 77).
- ▶ Check whether the locking knob on the front-passenger door is still visible. If necessary, press the locking knob down by hand (▷ page 77).
- ▶ Close the driver's door.
- ▶ Take the mechanical key out of the SmartKey (▷ page 72).
- ▶ Insert the mechanical key into the lock of the driver's door as far as it will go.

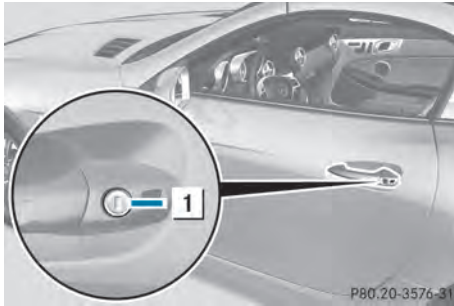

1 Locking

- ▶ Turn the mechanical key clockwise as far as it will go to position 1.
- ▶ Turn the mechanical key back and remove it.
- ▶ Make sure that the doors and the trunk lid are locked.
- ▶ Insert the mechanical key into the SmartKey.

i If you lock the vehicle as described above, the fuel filler flap is not locked. The anti-theft alarm system is not armed.

Trunk

Important safety notes

! WARNING

When leaving the vehicle, always remove the SmartKey from the ignition lock. Always take the SmartKey with you and lock the vehicle. Do not leave children unsupervised in the vehicle, even if they are secured in a child restraint system, and do not give them access to an unlocked vehicle. A child's unsupervised access to a vehicle could result in an accident and/or serious personal injury. They could:

- injure themselves on vehicle parts
- be seriously or fatally injured by extreme heat or cold
- injure themselves or have an accident with vehicle equipment that may still be in operation even after the SmartKey has been removed from the ignition, such as the

seat adjustment, steering wheel adjustment or memory function.

If children open a door, they could cause severe or even fatal injury to other persons; if they get out of the vehicle, they could injure themselves when doing so or be seriously or even fatally injured by any passing traffic.

Do not expose the child restraint system to direct sunlight. The child restraint system's metal parts, for example, could become very hot, and a child could be burned on these parts.

! WARNING

Do not carry heavy or hard objects in the passenger compartment or trunk unless they are firmly secured in place.

Unsecured or improperly positioned cargo increases a child's risk of injury in the event of

- strong braking maneuvers
- sudden changes of direction
- an accident

! WARNING

Make sure the trunk lid is closed when the engine is running and while driving. Among other dangers, deadly carbon monoxide (CO) gases may enter the vehicle interior resulting in unconsciousness and death.

! The trunk lid swings upwards when opened. Therefore, make sure that there is sufficient clearance above the trunk lid.

i Opening dimensions of the trunk lid (▷ page 353).

Do not leave the SmartKey in the trunk. You could otherwise lock yourself out.

The trunk lid can be:

- opened and closed from outside
- opened automatically from outside
- locked separately
- unlocked with the mechanical key
- opened with the emergency release button

Opening/closing from outside

Opening





- ▶ Press the  button on the SmartKey.
- ▶ Pull handle ①.
- ▶ Raise the trunk lid.

Closing

WARNING

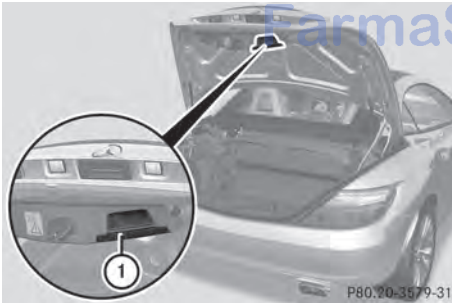
To prevent possible personal injury, always keep hands and fingers away from the trunk opening when closing the trunk lid. Be especially careful when small children are around.



- ▶ Pull the trunk lid down using recess ①.
 - ▶ Lock the vehicle if necessary with the  button on the SmartKey or with KEYLESS-GO.
- i** If a KEYLESS-GO key is detected in the trunk, the trunk lid cannot be locked and then opens again.

Opening automatically from the outside

Important safety notes

WARNING

Make sure the trunk lid is closed when the engine is running and while driving. Among other dangers, deadly carbon monoxide (CO) gases may enter the vehicle interior resulting in unconsciousness and death.

- !** The trunk lid swings upwards when opened. Therefore, make sure that there is sufficient clearance above the trunk lid.

i Opening dimensions of the trunk lid (▶ page 353).

Opening

You can open the trunk lid automatically using the SmartKey or the handle in the trunk lid.

- ▶ Press and hold the  button on the SmartKey until the trunk lid opens.
- or
- ▶ If the trunk lid is unlocked, pull the trunk lid handle and let it go again immediately.

Locking the trunk separately

You can lock the trunk separately. If you then unlock the vehicle centrally, the trunk remains locked and cannot be opened.

- ▶ Close the trunk lid.
- ▶ Take the mechanical key out of the SmartKey (▶ page 72).

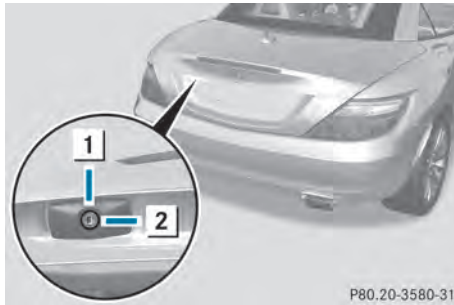

- 1 Basic position
- 2 Locking

- ▶ Insert the mechanical key into the trunk lid lock as far as the stop.
- ▶ Turn the mechanical key clockwise from position 1 to position 2.
- ▶ Remove the mechanical key.
- ▶ Insert the mechanical key into the SmartKey.

Unlocking the trunk (mechanical key)

- ⚠ The trunk lid swings upwards when opened. Therefore, make sure that there is sufficient clearance above the trunk lid.

If the trunk cannot be unlocked with the SmartKey or KEYLESS-GO, use the mechanical key.

If you use the mechanical key to unlock and open the trunk lid, the anti-theft alarm system will be triggered (▷ page 67).

- ▶ Take the mechanical key out of the SmartKey (▷ page 72).
- ▶ Insert the mechanical key into the trunk lid lock as far as the stop.

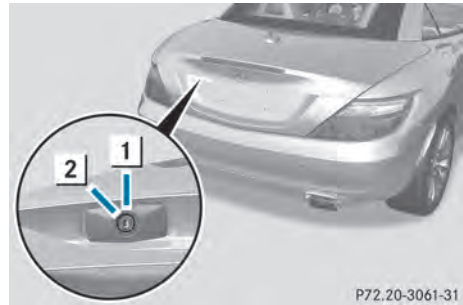

- 1 Basic position
- 2 To unlock

- ▶ Turn the mechanical key counter-clockwise as far as it will go from position 1 to position 2.
- ▶ Pull the trunk lid handle. The trunk is unlocked.
- ▶ Turn the mechanical key back to position 1 and remove it.
- ▶ Insert the mechanical key into the SmartKey.

Trunk emergency release

You can unlock the trunk lid from the inside with the emergency release button.



- ▶ Press emergency release button 1 briefly. The trunk lid unlocks and opens.

The trunk lid can be unlocked with the trunk lid emergency release when the vehicle is stationary or while driving.

The trunk lid emergency release does not unlock the trunk lid if the battery is disconnected or discharged.

Trunk lid emergency release light:

- emergency release button ① flashes for 30 minutes after the trunk lid is opened
- emergency release button ① flashes for 60 minutes after the trunk lid is closed

Side windows

Important safety notes

WARNING

When opening or closing the door windows, make sure that there is no danger of anyone being harmed by the opening/closing procedure.

The front door windows are equipped with automatic operation and the anti-entrapment feature. If in automatic mode a front door window encounters an obstruction that blocks its path, the anti-entrapment feature will stop the door window and open it slightly.

The door windows operate differently when the switch is pulled. See the "Problems with door windows" section for more details.

The closing of the door windows can be immediately halted by releasing the switch or, if the switch was pulled past the resistance point and released, by pressing or pulling the respective switch.

If a door window encounters an obstruction that blocks its path in a circumstance where you are closing the windows by pressing and holding  button on the SmartKey or by pressing and holding the lock button (vehicles with KEYLESS-GO) on an outside door handle, the anti-entrapment feature will not operate.

Opening and closing the side windows in the front

The switches for the front side windows are located on the driver's door. There is also a

switch for the front-passenger side window on the front-passenger door.

The switches on the driver's door take precedence.

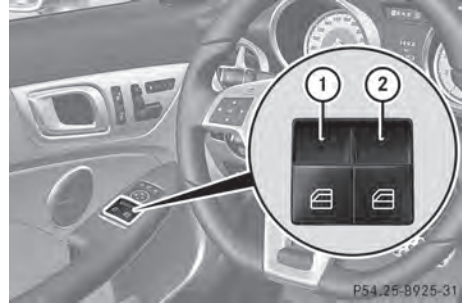

- ① Left
- ② Right

► Turn the SmartKey to position **1** or **2** in the ignition lock.

i You can continue to operate the side windows after you switch off the engine. This function is available for up to five minutes or until the driver's or front-passenger door is opened.

► **To open:** press the corresponding switch.

► **To close:** pull the corresponding switch.

► **Automatic operation:** press or pull the corresponding switch beyond the point of resistance.

The side window opens or closes fully.

► **To interrupt automatic operation:** press or pull the corresponding switch again.

Opening and closing all side windows

Using the switch on the center console

You can use the button on the center console to close all side windows simultaneously.

► Open the cover in the lower center console. The switch for all side windows is under the cover.

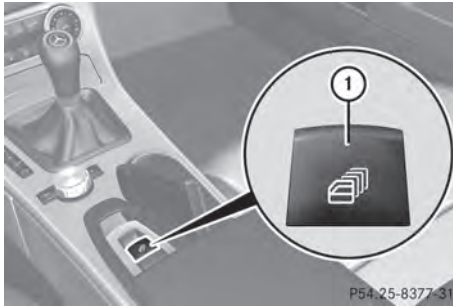



- ▶ **To open all side windows:** press switch ① to the point of resistance.
- ▶ **To open all side windows fully:** press switch ① beyond the point of resistance. All side windows open simultaneously.
- ❗ If, after opening the windows, you then close a side window using the switch on the door control panel, the other side windows will remain open. To close the other side windows, you must pull the switch on the center console and hold it. The front side window will close first, then the rear side windows.
- ▶ **To close all side windows:** pull switch ①.
The rear side windows close after the front side windows.
- ▶ Make sure that all the side windows are fully closed.
- ❗ When the roof is open, only the two front side windows can be operated using the switch on the center console.

Using the SmartKey





WARNING

Make sure that nobody can become trapped as you close the side windows.

Proceed as follows if there is a risk of entrapment:

- release the  key.
- press and hold the  key until the side windows open again.

You can use the SmartKey to open or close all side windows simultaneously.

- ▶ Close the roof (▷ page 86).
- ▶ Open the trunk partition (▷ page 88).
- ▶ **Vehicles without KEYLESS-GO:** point the tip of the SmartKey at the door handle on the driver's door.
- ▶ **Vehicles with KEYLESS-GO:** the SmartKey must be within 6 ft (2 m) of the vehicle.
- ▶ **To open all side windows:** press the  button on the SmartKey until the side windows are fully opened.
- ▶ **To interrupt the opening procedure:** release the  button.
- ▶ **To close all side windows:** press the  button on the SmartKey until the side windows are fully closed.
- ▶ **To interrupt the closing procedure:** release the  button.

Convenience closing with KEYLESS-GO

WARNING

When using the convenience closing feature, make sure that nobody can become trapped.

Proceed as follows if there is a risk of entrapment:

- release the locking button on the door handle.
- pull the door handle immediately and hold it.

The side windows open.

With KEYLESS-GO you can close all side windows simultaneously. The KEYLESS-GO key must be outside the vehicle. All the doors must be closed.

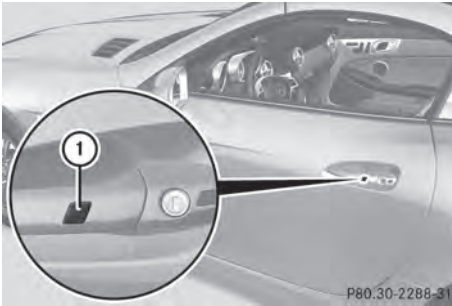

P80.30-2288-31

- ▶ Touch recessed sensor surface ① on the door handle until the side windows are fully closed.
- ❗ Make sure you only touch recessed sensor surface ①.
- ▶ Make sure that all the side windows are closed.
- ▶ **To interrupt convenience closing:** release recessed sensor surface ① on the door handle.

Resetting the side windows

تلفن شبانه روزی: ۰۸۵ ۸۸۶۲۰۸۵

If a side window can no longer be closed fully, you must reset it.

- ▶ Close all the doors.
- ▶ Turn the SmartKey to position **1** or **2** in the ignition lock.
- ▶ Pull the corresponding switch on the door control panel until the side window is completely closed. (▷ page 82)
- ▶ Hold the switch for an additional second.

If the side window opens again slightly:

- ▶ Immediately pull the corresponding switch on the door control panel until the side window is completely closed (▷ page 82).
- ▶ Hold the switch for an additional second.
- ▶ If the corresponding side window remains closed after the button has been released, the side window has been reset correctly. If this is not the case, repeat the steps above again.

Problems with the side windows

WARNING

Closing the side windows with increased force or without the anti-entrapment feature could lead to serious or even fatal injury. Make sure that nobody can become trapped when closing the side windows.

WARNING

Pulling and holding the switch to close the door window immediately after it had been blocked two times will cause the door window to close without the anti-entrapment feature for as long as you hold the switch.

Problem	Possible causes/consequences and ► Solutions
A side window cannot be closed because it is blocked by objects, e.g. leaves in the window guide.	<ul style="list-style-type: none"> ► Remove the objects. ► Close the side window.
A side window cannot be closed and you cannot see the cause.	<p>If a side window is obstructed during closing and reopens again slightly:</p> <ul style="list-style-type: none"> ► Immediately after the window blocks, pull the corresponding switch again until the side window has closed. The side window is closed with increased force. <p>If a side window is obstructed again during closing and reopens again slightly:</p> <ul style="list-style-type: none"> ► Immediately after the window blocks, pull the corresponding switch again until the side window has closed. The side window is closed without the anti-entrapment feature.

Roof

Important safety notes

WARNING

Always open or close the roof fully before driving.

If the roof does not open or close fully, the roof hydraulic system is depressurized and the roof is lowered:

- after about seven minutes if the ignition is switched on
- after about 15 seconds if the ignition is switched off

A warning tone sounds shortly beforehand. The  symbol and **Vario-Roof Lowering** message appear in the multifunction display.

Lock the roof again before driving on. Otherwise, the unlocked roof could open during the journey and cause you to lose control of your vehicle. You and/or other persons could be injured as a result.

WARNING

Closing the roof manually is a complex, technically challenging procedure.

Attempting to manually close the roof may cause damage to the roof and/or injury.

For this reason, the manual closing process should only be carried out at a qualified specialist workshop.

- ❗ Never sit on the rear shelf or store heavy objects there. You will otherwise damage the roof and the rear shelf of your vehicle.
- ❗ Do not forget that the weather can change abruptly. Make certain that the roof is closed when you leave the vehicle. The vehicle electronics can be damaged if water enters the vehicle interior.
- ❗ When opening and closing the roof, make sure that:
 - there is sufficient clearance, as the roof swings upwards.
 - there is sufficient clearance behind the vehicle, as the trunk lid swings backwards beyond the bumper.
 - the trunk is only loaded to below the trunk partition.
 - the trunk partition is not pushed up by the load.
 - the trunk partition is closed.
 - the trunk lid is closed.
 - the outside temperature is above 5 °F (-15 °C).

You could otherwise damage the roof, trunk and other parts of the vehicle.

- ❗ Make sure that the roof and rear window are clean and dry before opening the roof. Otherwise, water or dirt could enter the vehicle interior or trunk.





Opening and closing using the roof switch

Important safety notes

⚠ WARNING

Before operating the retractable hardtop (vario-roof), make sure there is no danger of

anyone being injured by the moving parts (retractable hardtop, roof frame, and trunk lid).

Hands must never be placed near the roof frame, upper windshield area, hardtop, shelf behind roll bars, or trunk lid while the retractable hardtop is being raised or lowered. Serious personal injury may occur. If potential danger exists, release the retractable hardtop switch or the  or  button on the SmartKey. This immediately interrupts the raising or lowering procedure. You can then operate the retractable hardtop switch or press the  or  button on the SmartKey to raise or lower the retractable hardtop away from the danger zone.

Opening/closing

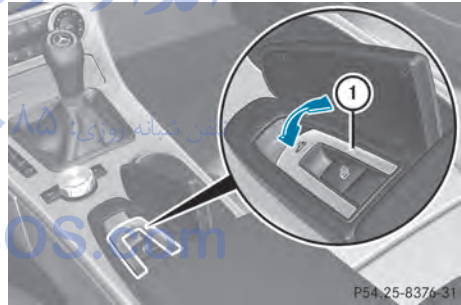

- ▶ Secure the vehicle against rolling away (▷ page 155).
- ▶ Close the trunk partition (▷ page 88).
- ▶ Close the trunk lid.
- ▶ Turn the SmartKey to position **2** in the ignition lock.
- ▶ Open the cover in the lower center console. Roof switch **1** is located under the cover.
- ▶ **To open:** pull roof switch **1** until the roof has been fully retracted into the trunk and the **Vario-Roof in Operation** message disappears from the multifunction display. All of the side windows open.
- ▶ **To close:** press roof switch **1** until the roof is fully closed and the **Vario-Roof in**

Operation message disappears from the multifunction display.

All of the side windows open.

- ▶ To close all side windows, pull the switch under the cover of the center console (▷ page 82).
- ❗ If you operate the roof switch and the **Trunk Partition Open** message appears in the multifunction display, the trunk partition has not been closed correctly.





Opening and closing using the SmartKey

Important safety notes

WARNING

Before operating the retractable hardtop (vario-roof), make sure there is no danger of anyone being injured by the moving parts (retractable hardtop, roof frame, and trunk lid).

Hands must never be placed near the roof frame, upper windshield area, hardtop, shelf behind roll bars, or trunk lid while the retractable hardtop is being raised or lowered. Serious personal injury may occur.

If potential danger exists, release the retractable hardtop switch or the  or  button on the SmartKey. This immediately interrupts the raising or lowering procedure. You can then operate the retractable hardtop switch or press the  or  button on the SmartKey to raise or lower the retractable hardtop away from the danger zone.

Opening/closing

- ▶ Close the trunk partition (▷ page 88).
- ▶ Close the trunk lid (▷ page 79).
- ▶ **Vehicles without KEYLESS-GO:** point the tip of the SmartKey at the door handle on the driver's door.

▶ **Vehicles with KEYLESS-GO:** the SmartKey must be within 6 ft (2 m) of the vehicle.

▶ **To open:** press and hold the  button on the SmartKey until the roof is fully opened.

The roof and the rear side windows open. The front side windows close.

▶ **To interrupt the opening procedure:** release the  button.

▶ **To open the front side windows:** press and hold the  button on the SmartKey again.

▶ **To close:** press and hold the  button on the SmartKey until the roof is fully closed.

The roof and the side windows close.

▶ **To interrupt the closing procedure:** release the  button.

❗ When the roof is closed and the trunk partition is open, the roof cannot be opened using the SmartKey functions.

Instead, all of the side windows open or close simultaneously (▷ page 82).

Additionally, the **Trunk Partition Open** message appears in the multifunction display.



Locking the roof again

Important safety notes

WARNING

Stop the vehicle in a safe location or as soon as it is safe to do so and lock the retractable hardtop before continuing to drive. You could otherwise endanger yourself and others.

The roof is not locked if:

- the  symbol and **Vario-Roof In Operation** message appear in the multifunction display
- the  symbol and **Open/Close Vario-Roof Completely** message appear and you hear a warning tone
- you hear a warning tone for up to 10 seconds when pulling away or while driving.

Locking

You can lock the roof again if it is not locked fully.

- ▶ Pull over and stop the vehicle safely as soon as possible, paying attention to road and traffic conditions.
- ▶ Make sure that the SmartKey is in position **2** in the ignition lock.
- ▶ Press the roof switch (▶ page 86).

Trunk partition

General notes

- ❗ To avoid damaging the roof or luggage when folding back the roof, you should:
 - only load the trunk to below the trunk partition
 - not place any objects on or in front of the trunk partition
 - not place any objects on the cover behind the roll bars
 - not allow the cargo to push the trunk partition upwards

The trunk partition can be used to cover luggage and loads in the trunk.

Opening/closing



- ▶ **To close:** pull back trunk partition **1** by the handle in the direction of the arrow until it engages on both sides in the eyelets on the cargo compartment lip.
- ▶ **To open:** grip the handle of trunk partition **1**.
 - ▶ Press the release button in the handle of trunk partition **1**. Trunk partition **1** is unlocked.
 - ▶ Pull trunk partition **1** up out of the eyelets on the cargo compartment lip.
 - ▶ Push trunk partition **1** forwards against the direction of the arrow by handle .

Wind screen

Important safety notes

WARNING

If you use the wind screen when it is dark or in other conditions offering poor visibility, your view to the rear is further impaired. As a result of the poor visibility, you could cause an accident and injure yourself or others.

For this reason, remove the wind screen as soon as it is dark or if your vision is otherwise restricted.

WARNING

You could lose control of the vehicle and injure yourself or others if you operate the wind screen while driving.

Install or remove the wind screen only when the vehicle is stationary.

WARNING

If the wind screen is not correctly engaged, it may break free and thus obstruct traffic behind you or lead to an accident.

Each time before driving with the roof down, check that the wind screen is properly engaged.

- ❗ Install or remove the wind screen only when the roof is open. You could otherwise damage the wind screen or the vehicle interior.

The wind screen offers protection from the wind when driving with the roof down. The wind screen can be installed or removed from the driver's side or passenger side. Perform operations involving the wind screen preferably on the side facing away from traffic, after you have stopped the vehicle, paying attention to road and traffic conditions.

Installing and removing the wind screen

Preparing for installation

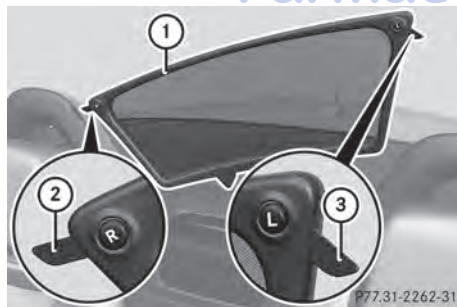

Preparing for installation from the left side of the vehicle (example)

- ① Wind screen
- ② Locked latch
- ③ Unlocked latch

- ▶ The following conditions must be fulfilled for installation:

- unlocking buttons **R** and **L** point in the direction of travel.
- latch ③ facing you is unlocked.
- latch ② facing away from you is locked.

- ▶ **To unlock the latch:** press unlocking button **R** or **L** on the locked latch.
- ▶ **To lock the latch:** push the unlocked latch upwards by hand until it engages.

Installing

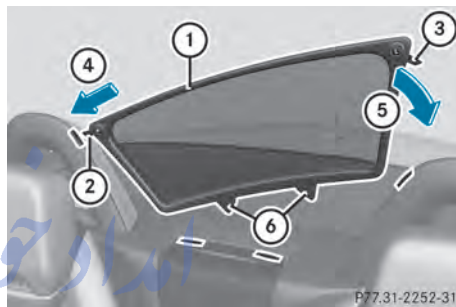

Installation from the left side of the vehicle (example)

- ▶ Stop the vehicle, paying attention to road and traffic conditions.
- ▶ Take the wind screen out of the trunk.
- ▶ Prepare for installing (> page 89).
- ▶ Hold wind screen ① at an angle and slide it with locked latch ② in the direction of arrow ④ into the bracket of the opposite roll bar.
- ▶ Press wind screen ① on the side of the vehicle facing you downwards in the direction of arrow ⑤ until it engages. Make sure that studs ⑥ and latch ③ fit into the respective brackets.
- ▶ Check whether wind screen ① is fully inserted into all four brackets and is sitting securely.
- ▶ If this is not the case, remove wind screen ① again and repeat the steps above.

Removing

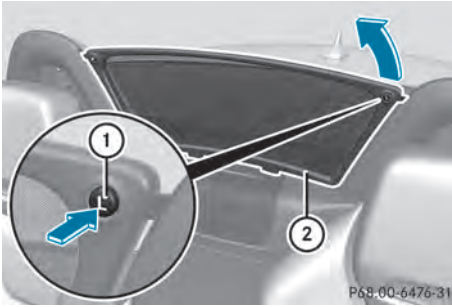

Removing from the left side of the vehicle (example)

- ▶ Stop the vehicle, paying attention to road and traffic conditions.
- ▶ Press unlocking button **L** ①. Meanwhile, pull wind screen ② on the side of the vehicle facing you upwards and tilt it.

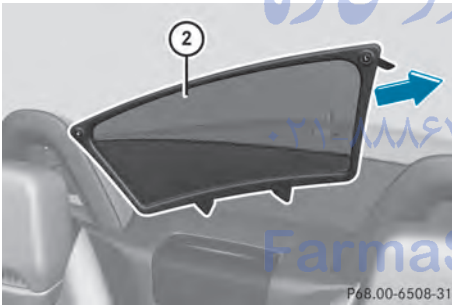

Removing from the left side of the vehicle (example)

- ▶ Pull wind screen ② out of the bracket of the opposite roll bar in the direction of the arrow.
- ▶ Secure wind screen ② to the trunk floor by the rubber strips (▷ page 258).

AIRGUIDE

Important safety notes

⚠ WARNING

You could lose control of the vehicle and injure yourself or others if you operate AIRGUIDE while driving.

Only fold the AIRGUIDE discs out or in when the vehicle is stationary.

- ❗ AIRGUIDE can only be positioned correctly by folding it in or out. AIRGUIDE cannot be dismantled. Do not try to remove AIRGUIDE from its anchorage. Otherwise, you could damage AIRGUIDE or the vehicle.

AIRGUIDE can be folded out or back in from the driver's side or passenger side.

Perform operations involving AIRGUIDE preferably on the side facing away from traffic, after you have stopped the vehicle, paying attention to road and traffic conditions.

Operating AIRGUIDE

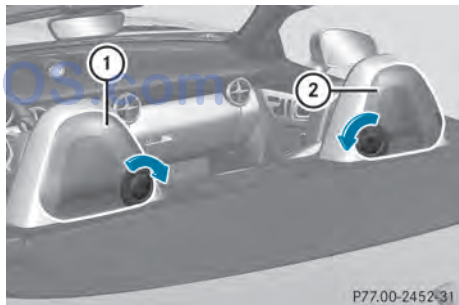

Example: folding out from the left side of the vehicle

- ▶ Stop the vehicle, paying attention to road and traffic conditions.
- ▶ **To fold out AIRGUIDE:** turn disc ① in the direction of the arrow towards the middle of the vehicle to the stop.
- ▶ Repeat with disc ②.
- ▶ **To fold in AIRGUIDE:** turn discs ① and ② back behind the roll bar to the stop.

- ❶ Discs ❶ and ❷ can also be used independently of each other, e.g. when you are driving without a passenger.

MAGIC SKY CONTROL

General notes

MAGIC SKY CONTROL is a glass roof, the transparency of which can be changed by applying electrical voltage.

MAGIC SKY CONTROL can be switched between darkened and transparent states.

- ❶ MAGIC SKY CONTROL darkens automatically when you turn the SmartKey to position 0 in the ignition lock or remove the SmartKey.

Risk of electric shock

DANGER

The MAGIC SKY CONTROL electrical system works at high voltage.

If the cover behind the overhead control unit is damaged or is removed, electrical components of MAGIC SKY CONTROL are exposed. These may be live. If you touch these components, you may get an electric shock and could be seriously or even fatally injured.

For this reason, never remove the cover behind the overhead control unit. Never touch parts of the electrical system (control unit, cables or cable connections).

Have all work on MAGIC SKY CONTROL carried out at a qualified specialist workshop.

The electrical components of MAGIC SKY CONTROL are protected by a paneling behind the overhead control panel.

The MAGIC SKY CONTROL control unit is marked with a yellow warning sticker that warns you of high voltage. The high-voltage cables are orange in color.

Operating MAGIC SKY CONTROL

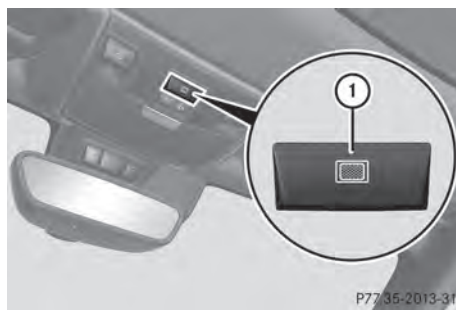

- ▶ Turn the SmartKey to position 1 or 2 in the ignition lock. MAGIC SKY CONTROL switches to the status it was set to before the engine was switched off.
- ▶ **To change the degree of transparency:** press button ❶.

- ❶ At sub-zero temperatures, the change is slower and uneven. The entire process may take some time.

Problems with the roof	
Problem	Possible causes/consequences and ► Solutions
The roof will not open or close.	The trunk partition is not closed and not properly engaged. ► Close the trunk partition (► page 88).
	The trunk lid is open. ► Close the trunk lid (► page 80).
	The on-board voltage is too low. ► Leave the engine running.
	The roof has been opened and closed several times in a row. The roof drive has been automatically deactivated. You can open and close the roof again after approximately ten minutes. ► Switch off the ignition and turn it back on. ► Repeat the opening or closing procedure. The automatic roof mechanism is faulty. ► Consult a qualified specialist workshop.

تلفن شبانه روزی: ۰۲۱-۸۸۸۶۲۰۸۵

FarmaSOS.com

Useful information	94
Correcting the driver's seat position	94
Seats	95
Steering wheel	98
Mirrors	100
Memory function	103

امداد خودرو فارما

تلفن شبانه روزی: ۰۲۱-۸۸۸۶۲۰۸۵

FarmaSOS.com

Useful information

i This Operator's Manual describes all models and all standard and optional equipment of your vehicle available at the time of publication of the Operator's Manual. Country-specific differences are possible. Please note that your vehicle may not be equipped with all features described. This also applies to safety-related systems and functions.

i Read the information on qualified specialist workshops: (▷ page 23).

Correcting the driver's seat position

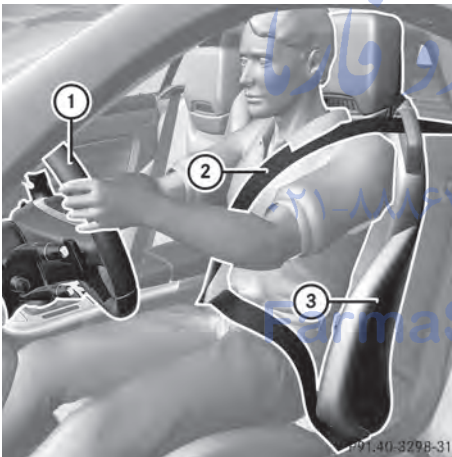

► Observe the safety guidelines on seat adjustment (▷ page 95).

► Make sure that seat ③ is adjusted properly.

Manual seat adjustment (▷ page 96)

Electrical seat adjustment (▷ page 96)

When adjusting the seat, make sure that:

- you are as far away from the driver's air bag as possible.
- you are sitting in a normal upright position.
- you can fasten the seat belt properly.

- you have moved the backrest to an almost vertical position.
- you have set the seat cushion angle so that your thighs are gently supported.
- you can depress the pedals properly.

► Check whether the head restraint is adjusted properly.

When doing so, make sure that you have adjusted the head restraint so that the back of your head is supported at eye level by the center of the head restraint.

► Observe the safety guidelines on steering wheel adjustment (▷ page 98).

► Make sure that steering wheel ① is adjusted properly.

Adjusting the steering wheel manually (▷ page 98)

Adjusting the steering wheel electrically (▷ page 99)

When adjusting the steering wheel, make sure that:

- you can hold the steering wheel with your arms slightly bent.
 - you can move your legs freely.
 - you can see all the displays in the instrument cluster clearly.
- Observe the safety guidelines for seat belts (▷ page 51).
- Check whether you have fastened seat belt ② properly (▷ page 53).

The seat belt should:

- fit snugly across your body
 - be routed across the middle of your shoulder
 - be routed in your pelvic area across the hip joints
- Before starting off, adjust the rear-view mirror and the exterior mirrors in such a way that you have a good view of road and traffic conditions (▷ page 100).
- **Vehicles with a memory function:** save the seat, steering wheel and exterior mirror settings (▷ page 103).

Seats

Important safety notes

WARNING

The seats can still be adjusted when there is no key in the ignition lock. For this reason, children should never be left unsupervised in the vehicle. They could otherwise become trapped when adjusting the seat.

WARNING

Make sure that the back of your head is supported at eye level by the central area of the head restraint. If your head is not supported correctly by the head restraint, you could suffer a severe neck injury in the event of an accident. Never drive if the head restraints are not engaged and set correctly.

WARNING

In order to avoid possible loss of vehicle control, all seat, head restraint, steering wheel and rear view mirror adjustments, as well as fastening of seat belts, must be done before setting the vehicle in motion.

WARNING

Do not adjust the driver's seat while driving. Adjusting the seat while driving could cause the driver to lose control of the vehicle.

Never travel in a moving vehicle with the seat backrest in an excessively reclined position as this can be dangerous. You could slide under the seat belt in a collision. If you slide under it, the seat belt would apply force at the abdomen or neck. This could cause serious or fatal injuries. The seat backrest and seat belts provide the best restraint when the wearer is in a position that is as upright as possible and seat belts are properly positioned on the body.

WARNING

Your seat belt must be adjusted so that you can correctly fasten your seat belt.

Observe the following points:

- adjust the seat backrest until your arms are slightly angled when holding the steering wheel.
- adjust the seat to a comfortable seating position that still allows you to reach the accelerator/brake pedal safely. The position should be as far back as possible with the driver still able to operate the controls properly.
- adjust the head restraint so that it is as close to the head as possible and the center of the head restraint supports the back of the head at eye level.
- never place hands under the seat or near any moving parts while a seat is being adjusted.

Failure to do so could result in an accident and/or serious personal injury.

WARNING

Children 12 years old and under must be seated and properly secured in an appropriately sized infant restraint, child restraint system, or booster seat recommended for the size and weight of the child. For additional information, see the "Children in the vehicle" section.

A child's risk of serious or fatal injuries is significantly increased if the child restraints are not properly secured in the vehicle and/or the child is not properly secured in the child restraint.

WARNING

Children 12 years old and under must be seated and properly secured in an appropriate infant restraint, toddler restraint, or booster seat recommended for the size and weight of the child. Additional information can be found under "Children in the vehicle".

A child's risk of serious or fatal injuries is significantly increased if the child restraints are not properly secured in the vehicle and/or the child is not properly secured in the child restraint.

! To avoid damage to the seats and the seat heating, observe the following information:

- keep liquids from spilling on the seats. If liquid is spilled on the seats, dry them as soon as possible.
- if the seat covers are damp or wet, do not switch on the seat heating. The seat heating should also not be used to dry the seats.
- clean the seat covers as recommended; see the "Interior care" section.
- do not transport heavy loads on the seats. Do not place sharp objects on the seat cushions, e.g. knives, nails or tools. The seats should only be occupied by passengers, if possible.
- when the seat heating is in operation, do not cover the seats with insulating materials, e.g. blankets, coats, bags, seat covers, child seats or booster seats.

! Make sure that there are no objects in the footwell or behind the seats when resetting the seats. There is a risk that the seats and/or the objects could be damaged.

1 The head restraints are installed with the NECK-PRO system (▷ page 50). For this reason, it is not possible to remove the head restraints from the seats.

For more information, contact a qualified specialist workshop.

Adjusting the seats manually

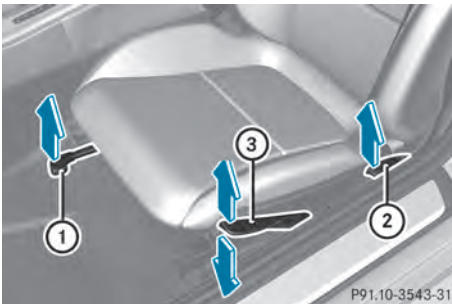

► **To set seat fore-and-aft adjustment:** lift lever ① and slide the seat forwards or backwards.

► Release lever ① again. Make sure that you hear the seat engage in position.

► **To adjust the backrest angle:** relieve the pressure on the backrest.

► Pull handle ② and adjust the backrest to the desired angle.

► Release handle ② again. The backrest must audibly engage.

► **To adjust the seat height:** pull handle ③ upwards or push it down repeatedly until the seat has reached the desired height.

Adjusting the seats electrically

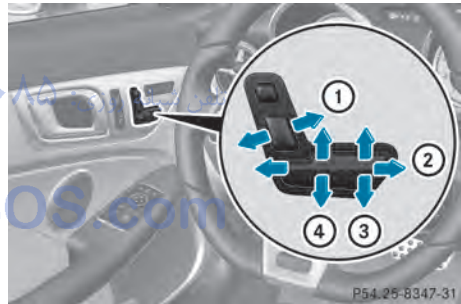

① Backrest angle

② Seat fore-and-aft adjustment

③ Seat cushion angle

④ Seat height

1 You can store the seat settings using the memory function (▷ page 103).

Adjusting the head restraints

Adjusting the head restraints manually



- ▶ **To raise/lower:** push the head restraint upwards or pull it down into the desired position.

Adjusting the 4-way lumbar support

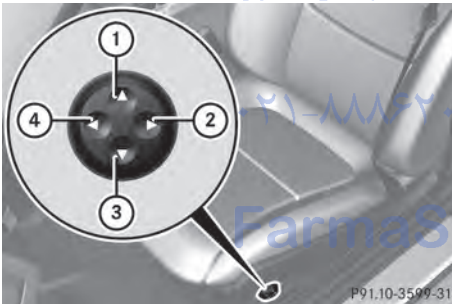

- ① To raise the backrest contour
- ② To soften the backrest contour
- ③ To lower the backrest contour
- ④ To harden the backrest contour

You can adjust the contour of the seat backrests individually to provide optimum support for your back.

Switching the seat heating on/off

Activating/deactivating



Driver's and front-passenger seat

The three red indicator lamps in the button indicate the heating level you have selected. The system automatically switches down from level 3 to level 2 after approximately five minutes.

The system automatically switches down from level 2 to level 1 after approximately ten minutes.

The system automatically switches off approximately 20 minutes after it is set to level 1.

- ▶ Make sure that the SmartKey is in position 1 or 2 in the ignition lock.
- ▶ **To switch on:** press button ① repeatedly until the desired heating level is set.
- ▶ **To switch off:** press button ① repeatedly until all the indicator lamps go out.

Problems with the seat heating

The seat heating has switched off prematurely or cannot be switched on. The vehicle's electrical system voltage is too low because too many electrical consumers are switched on.

- ▶ Switch off electrical consumers that you do not need, such as the rear window defroster or interior lighting.
- ▶ Once the battery is sufficiently charged, switch on the seat heating again.

AIRSCARF

Activating/deactivating

WARNING

Very hot air can flow out of the AIRSCARF vents in the head restraints when AIRSCARF is in operation. This can cause burns on unprotected skin near the AIRSCARF vents. Lower the heating output in good time, when necessary.

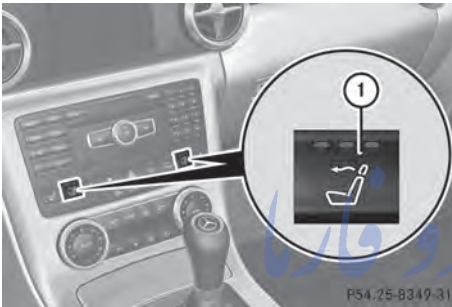

The AIRSCARF function warms the head and neck area of vehicle occupants with warm air. The warm air flows out of the holes in the head restraints.

The three red indicator lamps in the button indicate the heating level you have selected.

- ▶ Make sure that the SmartKey is in position **2** in the ignition lock.
 - ▶ **To switch on:** press button **1**.
Three red indicator lamps in the button light up. The blower starts up after a preheating phase of seven seconds.
 - ▶ Press button **1** repeatedly until the desired heating level is set.
 - ▶ **To switch off:** press button **1** repeatedly until all the indicator lamps go out.
- i** The blower continues running for seven seconds to cool down the heating elements.
- i** If the battery voltage is too low, AIRSCARF may switch off.

Problems with AIRSCARF

AIRSCARF has switched off prematurely or will not switch on. The vehicle's electrical system voltage is too low because too many electrical consumers are switched on.

- ▶ Switch off electrical consumers that you do not need, such as the rear window defroster or interior lighting.
- ▶ Switch on AIRSCARF again.

Steering wheel

Important safety notes

WARNING

Do not adjust the steering wheel while driving. Adjusting the steering wheel while driving could cause the driver to lose control of the vehicle.

The electrical steering wheel adjustment feature can be operated at any time. Therefore, do not leave children unattended in the vehicle, or with access to an unlocked vehicle. A child's unsupervised access to a vehicle could result in an accident and/or serious personal injury.

Adjusting the steering wheel manually

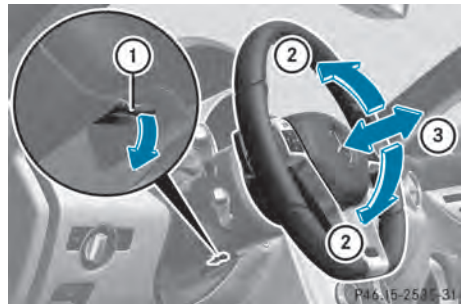

- 1** Release lever
- 2** To adjust the steering wheel height
- 3** To adjust the steering wheel position (fore-and-aft adjustment)

- ▶ Push release lever ① down completely in the direction of the arrow.
The steering column is unlocked.
- ▶ Adjust the steering wheel to the desired position.
- ▶ Push release lever ① up completely.
The steering column is locked.
- ▶ Check if the steering column is locked.
When doing so, try to push the steering wheel up or down or try to move it in the fore-and-aft direction.

Adjusting the steering wheel electrically

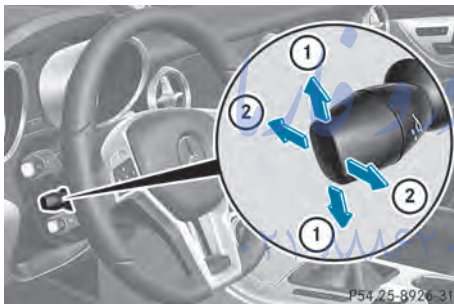

- ① To adjust the steering wheel height
- ② To adjust the steering wheel position (fore-and-aft adjustment)

- ❗ Further related subjects:
 - EASY-ENTRY/EXIT feature (▷ page 99)
 - Storing settings (▷ page 103)

EASY-ENTRY/EXIT feature

Important safety notes

WARNING

Make sure that nobody can become trapped when you activate the EASY-ENTRY/EXIT feature.

If there is a risk of someone becoming trapped, stop the adjustment procedure. To halt the procedure:

- press the steering column adjustment button.
- press one of the memory function position buttons.

The steering column stops moving immediately.

Do not keep the memory function position button pressed as this will start the memory function and set the steering wheel and seat in motion.

Do not leave children unattended in the vehicle. They could open the driver's door and thereby unintentionally activate the EASY-ENTRY/EXIT feature and become trapped.

WARNING

Let the system complete the adjustment procedure before setting the vehicle in motion. All steering wheel adjustment must be completed before setting the vehicle in motion. Driving off with the steering wheel still adjusting could cause the driver to lose control of the vehicle.

The EASY-ENTRY/EXIT feature makes getting in and out of your vehicle easier.

You can activate and deactivate the EASY-ENTRY/EXIT feature in the on-board computer (▷ page 206).

Position of the steering wheel when the EASY-ENTRY/EXIT feature is active

The steering wheel swings upwards when you:

- remove the SmartKey from the ignition lock
- open the driver's door and KEYLESS-GO is in position 1
- open the driver's door and the SmartKey is in position 0 or 1 in the ignition lock

- 1 The steering wheel only moves upwards if it has not already reached the upper end stop.

Position of the steering wheel for driving

The steering wheel is moved to the last selected position when:

- the driver's door is closed.
- you insert the SmartKey into the ignition lock.
or
- you press the Start/Stop button once on vehicles with KEYLESS-GO.

When you close the driver's door with the ignition switched on, the steering wheel is also automatically moved to the previously set position.

The last position of the steering wheel is stored when you switch off the ignition or when you store the setting with the memory function (> page 103).

Crash-responsive EASY-EXIT feature

If the crash-responsive EASY-EXIT feature is triggered in an accident, the steering column will move upwards when the driver's door is opened. This occurs irrespective of the position of the SmartKey in the ignition lock. This makes it easier to exit the vehicle and rescue the occupants.

The crash-responsive EASY-EXIT feature is only operational if the EASY-EXIT/ENTRY feature is activated in the on-board computer.

Mirrors

Rear-view mirror



P68.40-2182-31

- **Anti-glare mode:** flick anti-glare lever ① forwards or back.

Exterior mirrors

Adjusting the exterior mirrors

⚠ WARNING

The exterior mirrors reduce the size of the image. Objects are actually closer than they appear. You could misjudge the distance from vehicles driving behind and cause an accident, e.g. when changing lane. For this reason, make sure of the actual distance from the vehicle driving behind by glancing over your shoulder.



P88.70-2657-31

- ▶ Make sure that the SmartKey is in position 1 or 2 in the ignition lock.
- ▶ Press button ① for the left-hand exterior mirror or button ② for the right-hand exterior mirror.
The indicator lamp in the corresponding button lights up in red.
The indicator lamp goes out again after some time. You can adjust the selected mirror using adjustment button ③ as long as the indicator lamp is lit.
- ▶ Press adjustment button ③ up, down, to the right or to the left.
The exterior mirror must be set to a position that provides you with a good overview of traffic conditions.

The convex exterior mirrors provide a larger field of vision.

The exterior mirrors are automatically heated after starting the vehicle if the rear window defroster is switched on and the outside temperature is low. Heating up takes not more than 10 minutes.

- ❗ You can also heat up the exterior mirrors manually by switching on the rear window defroster.

Folding the exterior mirrors in or out electrically



- ▶ Make sure that the SmartKey is in position 1 or 2 in the ignition lock.
- ▶ Briefly press button ①.
Both exterior mirrors fold in or out.

- ❗ Make sure that the exterior mirrors are always folded out fully while driving. They could otherwise vibrate.

Folding the exterior mirrors in or out automatically

If the "Fold in mirrors when locking" function is activated in the on-board computer (▷ page 207):

- the exterior mirrors fold in automatically as soon as you lock the vehicle from the outside.
- the exterior mirrors fold out again automatically as soon as you unlock the vehicle and then open the driver's or front-passenger door.

- ❗ The exterior mirrors do not fold out if they have been folded in manually.

Exterior mirror out of position

If an exterior mirror has been pushed out of position, proceed as follows:

- ▶ **Vehicles without electrically folding exterior mirrors:** move the exterior mirror into the correct position manually.
- ▶ **Vehicles with electrically folding exterior mirrors:** press and hold mirror-folding button ① until you hear a click and then the mirrors engage in position (▷ page 101).
The mirror housing is engaged again and you can adjust the exterior mirrors as usual (▷ page 100).

Automatic anti-glare mirrors

⚠ WARNING

If incident light from headlamps is prevented from striking the sensor in the rear-view mirror, for instance, by luggage piled too high in the vehicle, the mirror's automatic anti-glare function will not operate.

Incident light could then blind you. This may distract you from the traffic conditions and, as a result, you may cause an accident.

The rear-view mirror and the exterior mirror on the driver's side automatically go into anti-glare mode if the following conditions are met simultaneously:

- the ignition is switched on and
- incident light from headlamps strikes the sensor in the rear-view mirror.

The mirrors do not go into anti-glare mode if reverse gear is engaged or if the interior lighting is switched on.

Parking position for the exterior mirror on the front-passenger side

Setting and storing the parking position

Using reverse gear

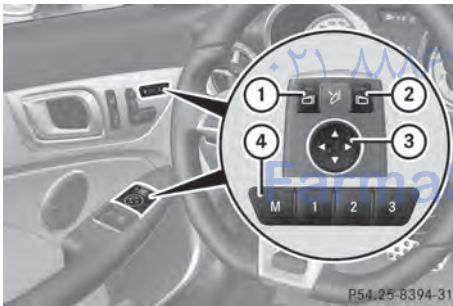

You can position the front-passenger side exterior mirror in such a way that you can see the rear wheel on that side as soon as you engage reverse gear. You can store this position.

- ▶ Make sure that the vehicle is stationary and that the SmartKey is in position **2** in the ignition lock.
- ▶ Press button **②** for the exterior mirror on the front-passenger side.

- ▶ Engage reverse gear.
The exterior mirror on the front-passenger side moves to the preset parking position.
- ▶ Use adjustment button **③** to adjust the exterior mirror to a position that allows you to see the rear wheel and the curb.
The parking position is stored.

i If you shift the transmission to another position, the exterior mirror on the front-passenger side returns to the driving position.

Using the memory button

You can position the front-passenger side exterior mirror in such a way that you can see the rear wheel on that side as soon as you engage reverse gear. This setting can be stored using memory button **M ④**.

- ▶ Make sure that the SmartKey is in position **2** in the ignition lock.
- ▶ With the exterior mirror on the front-passenger side activated, use adjustment button **③** to adjust the exterior mirror. In the exterior mirror, the rear wheel and the curb should be visible.
- ▶ Press memory button **M ④** and one of the arrows on adjustment button **③** within three seconds.
The parking position is stored if the exterior mirror does not move.
- ▶ If the mirror moves out of position, repeat the steps.

Calling up a stored parking position setting

- ▶ Turn the SmartKey to position **2** in the ignition lock.
- ▶ Adjust the exterior mirror on the front-passenger side using button **②**.
- ▶ Engage reverse gear.
The exterior mirror on the front-passenger side moves to the stored parking position.

The exterior mirror on the front-passenger side moves back to its original position:

- as soon as you exceed a speed of 9 mph (15 km/h)
- if you press button ① for the exterior mirror on the driver's side

steering wheel and exterior mirrors are in the stored position.

- ❗ The setting procedure is interrupted as soon as you release the storage position button.

Memory function

Storing settings

WARNING

Only use the memory function on the driver's side when the vehicle is stationary. You could otherwise be distracted from the traffic conditions by the seat moving of its own accord, and as a result cause an accident.



- ▶ Adjust the seat electrically (▷ page 96).
- ▶ On the driver's side, adjust the steering wheel (▷ page 99) and the exterior mirrors (▷ page 100).
- ▶ Press memory button **M** and one of the storage position buttons **1**, **2** or **3** within three seconds.

The settings are stored in the selected preset position. A tone sounds when the settings have been completed.

Calling up a stored setting

- ▶ Press and hold the relevant storage position button **1**, **2** or **3** until the seat,

امداد خودرو فارما

تلفن شبانه روزی: ۰۲۱-۸۸۸۶۲۰۸۵

FarmaSOS.com

Useful information	106
Exterior lighting	106
Interior lighting	111
Replacing bulbs	112
Windshield wipers	115

امداد خودرو فارما

تلفن شبانه روزی: ۰۲۱-۸۸۸۶۲۰۸۵

FarmaSOS.com

Useful information

1 This Operator's Manual describes all models and all standard and optional equipment of your vehicle available at the time of publication of the Operator's Manual. Country-specific differences are possible. Please note that your vehicle may not be equipped with all features described. This also applies to safety-related systems and functions.

i Read the information on qualified specialist workshops: (▷ page 23).

Exterior lighting

Important safety notes

For reasons of safety, Mercedes-Benz recommends that you drive with the lights switched on even during the daytime. In some countries, operation of the headlamps varies due to legal requirements and self-imposed obligations.

Driving abroad

Symmetrical low-beam headlamps

Switch the headlamps to symmetrical low beam in countries in which traffic drives on the opposite side of the road from the country where the vehicle is registered. This prevents glare to oncoming traffic. When using symmetrical lights, the edge of the road is not lit as widely and as far ahead as normal.

Have the headlamps converted at a qualified specialist workshop as close to the border as possible before driving in these countries.

Asymmetrical low beam

Have the headlamps converted back to asymmetrical low-beam headlamps at a qualified specialist workshop as soon as possible after crossing the border again.

Setting the exterior lighting

Setting options

Exterior lighting can be set using the:

- light switch
- combination switch (▷ page 108)
- the on-board computer (▷ page 204)

Light switch

Operation

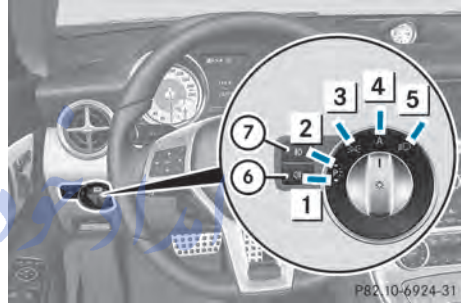

- 1** Left-hand standing lamps
- 2** Right-hand standing lamps
- 3** Parking lamps, license plate and instrument cluster lighting
- 4** **AUTO** Automatic headlamp mode, controlled by the light sensor
- 5** Low-beam/high-beam headlamps
- 6** Rear fog lamp
- 7** Fog lamps (only vehicles with front fog lamps)

If you hear a warning tone when you leave the vehicle, the lights may still be switched on.

► Turn the light switch to **AUTO**.

The exterior lighting (except the parking/standing lamps) switches off automatically if you:

- remove the SmartKey from the ignition lock
- open the driver's door with the SmartKey in position **0**.

Automatic headlamp mode

WARNING

If the light switch is set to **AUTO** and it is foggy, snowing or there is poor visibility, the low-beam headlamps will not come on automatically. This could endanger you and others. In such situations turn the light switch to .

The automatic headlamp feature is only an aid. The driver is responsible for the vehicle's lighting at all times.

AUTO is the favored light switch setting. The light setting is automatically selected according to the brightness of the ambient light (exception: poor visibility due to weather conditions such as fog, snow or spray):

- SmartKey in position **1** in the ignition lock: the parking lamps are switched on or off automatically depending on the brightness of the ambient light.
- With the engine running: if you have activated the daytime running lamps function via the on-board computer, the daytime running lamps or the low-beam headlamps and parking lamps are switched on or off automatically depending on the brightness of the ambient light.

► **To switch on automatic headlamp mode:** turn the light switch to **AUTO**.

Only for Canada:

The daytime running lamps improve the visibility of your vehicle during the day. The daytime running lamps function is required by law in Canada. It cannot therefore be deactivated.

When the engine is running and the vehicle is stationary: if you move the selector lever from a drive position to **P**, the daytime running lamps/low-beam headlamps go out after three minutes.



When the engine is running, the vehicle is stationary and in high ambient light brightness: if you turn the light switch

to , you turn on the daytime running lamps and parking lamps.

If the engine is running and you turn the light switch to , the manual settings take precedence over the daytime running lamps.

USA only:

The daytime running lamps improve the visibility of your vehicle during the day. To do this, the daytime running lamps function must be switched on using the on-board computer (► page 204).

If the engine is running and you turn the light switch to  or , the manual settings take precedence over the daytime running lamps.

- ❗ In the USA, the daytime running lamps are deactivated upon delivery from the factory.



Low-beam headlamps

WARNING

If the light switch is set to **AUTO** and it is foggy, snowing or there is poor visibility, the low-beam headlamps will not come on automatically. This could endanger you and others. In such situations turn the light switch to .





The automatic headlamp feature is only an aid. The driver is responsible for the vehicle's lighting at all times.

Even if the light sensor does not detect that it is dark, the parking lamps and low-beam headlamps switch on when the SmartKey is inserted into the ignition lock and the light switch is set to the  position. This is a particularly useful function in the event of rain and fog.

- **To switch on the low-beam headlamps:** turn the SmartKey in the ignition lock to position **2** or start the engine.
- Turn the light switch to . The green  indicator lamp in the instrument cluster lights up.

Front fog lamps





In conditions where visibility is poor due to fog, snow or rain, the fog lamps improve visibility as well as making it easier for other road users to see you. They can be operated together with the parking lamps or together with the parking lamps and low-beam headlamps.

- ▶ **To switch on the front fog lamps:** turn the SmartKey in the ignition lock to position **2** or start the engine.
- ▶ Turn the light switch to  or **AUTO**.
- ▶ Press the  button.
The green  indicator lamp in the instrument cluster lights up.
- ▶ **To switch off the front fog lamps:** press the  button.
The green  indicator lamp in the instrument cluster goes out.

Only vehicles with front fog lamps have the fog lamps function.



Rear fog lamp

The rear fog lamp improves visibility of your vehicle for the traffic behind in the event of heavy fog. Please take note of the country-specific regulations for the use of rear fog lamps.

- ▶ **To switch on the rear fog lamp:** turn the SmartKey in the ignition lock to position **2** or start the engine.
- ▶ Turn the light switch to  or **AUTO**.
- ▶ Press the  button.
The yellow  indicator lamp in the instrument cluster lights up.
- ▶ **To switch off the rear fog lamp:** press the  button.
The yellow  indicator lamp in the instrument cluster goes out.

Parking lamps



! If the battery has been excessively discharged, the parking lamps or standing lamps are automatically switched off to enable the next engine start. Always park

your vehicle safely and sufficiently lit according to legal standards. Avoid the continuous use of the  parking lamps for several hours. If possible, switch on the  right or the  left standing lamp.

- ▶ **To switch on:** turn light switch to .

Standing lamps

Switching on the standing lamps ensures the corresponding side of the vehicle is illuminated.

- ▶ **To switch on the standing lamps:** the SmartKey is not in the ignition lock or it is in position **0**.
- ▶ Turn the light switch to  (left-hand side of the vehicle) or  (right-hand side of the vehicle).

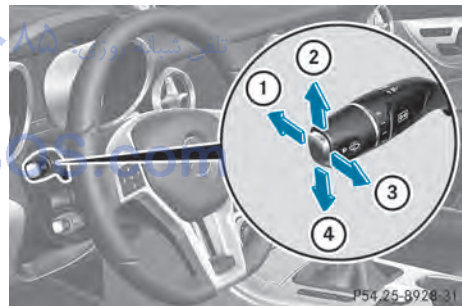

Combination switch

Turn signals



- ① High-beam headlamps
- ② Turn signal, right
- ③ High-beam flasher
- ④ Turn signal, left
- ▶ **To indicate briefly:** press the combination switch briefly to the pressure point in the direction of arrow ② or ④.
The corresponding turn signal flashes three times.
- ▶ **To indicate:** press the combination switch beyond the pressure point in the direction of arrow ② or ④.

High-beam headlamps

- ▶ **To switch on the high-beam headlamps:** turn the SmartKey in the ignition lock to position **2** or start the engine.
 - ▶ Turn the light switch to  or **AUTO**.
 - ▶ Press the combination switch beyond the pressure point in the direction of arrow **①**.
In the **AUTO** position, the high-beam headlamps are only switched on when it is dark and the engine is running.
- The  indicator lamp in the instrument cluster lights up when the high-beam headlamps are switched on.
- ▶ **To switch off the high-beam headlamps:** move the combination switch back to its normal position.
The  indicator lamp in the instrument cluster goes out.

High-beam flasher

- ▶ **To switch on:** turn the SmartKey in the ignition lock to position **1** or **2** or start the engine.
- ▶ Pull the combination switch in the direction of arrow **③**.

only the turn signal lamp on the corresponding side of the vehicle will flash.

- ▶ **To switch off the hazard warning lamps:** press button **①**.

The hazard warning lamps automatically switch on if:

- an air bag is deployed.
- the vehicle is slowed down rapidly from a speed of over 45 mph (70 km/h) and comes to a halt.

If the vehicle returns to a speed of over 6 mph (10 km/h) after a full application of the brakes, the hazard warning lamps are deactivated automatically.

- i** The hazard warning lamps still operate if the ignition is switched off.

Headlamp cleaning system

The headlamps are cleaned automatically if the "Wipe with washer fluid" function is operated five times (▶ page 115) while the lights are on and the engine is running. When you switch off the ignition, the automatic headlamp cleaning system is reset and counting is resumed from 0.

Hazard warning lamps



- ▶ **To switch on the hazard warning lamps:** press button **①**.
All turn signals flash. If you now switch on a turn signal using the combination switch,

Cornering light function



The cornering light function improves the illumination of the road over a wide angle in the direction you are turning, enabling better visibility in tight bends, for example. The cornering light function can only be activated

when the low-beam headlamps are switched on.

Active:

- if you are driving at speeds below 25mph (40 km/h) and switch on the turn signal or turn the steering wheel.
- if you are driving at speeds between 25mph (40 km/h) and 45mph (70 km/h) and turn the steering wheel

Not active: if you are driving at speeds above 25 mph (40 km/h) or switch off the turn signals or turn the steering wheel to the straight-ahead position.

The cornering light function may remain lit for a short time, but is automatically switched off after no more than three minutes.

Active light function



The active light function is a system that moves the headlamps according to the steering movements of the front wheels. In this way, relevant areas remain illuminated while driving. This allows you to recognize pedestrians, cyclists and animals.

Active: when the lights are switched on.

Adaptive Highbeam Assist

Important safety notes

⚠ WARNING

The Adaptive Highbeam Assist is only an aid intended to support you while driving. The

driver is and remains responsible for proper vehicle lighting in accordance with the prevailing light, sight and traffic conditions.

The system may be impaired or unavailable when

- visibility is poor, e.g. due to snow, rain, fog, or heavy spray
- the optical sensor area of the windshield is dirty, fogged up, or covered by a sticker for example

The system cannot recognize the following road users:

- Road users without a lighting system of their own, e.g. pedestrians
- Road users with dim lighting of their own, e.g. cyclists
- Road users whose lighting is obstructed, e.g. road users behind a guardrail
- In some seldom cases, even road users with a lighting system of their own may be recognized too late or not at all.

The automatic high-beam headlamps will then not be deactivated or it will be activated in spite of preceding or oncoming road users.

This could endanger you and/or others and cause an accident. Always pay close attention to the traffic situation and switch off the high beam manually if necessary.



You can use this function to set the headlamps to change between low beam and high beam automatically. The system recognizes vehicles with their lights on, either approaching from the opposite direction or traveling in front of your vehicle, and consequently switches the headlamps from high beam to low beam.

The system automatically adapts the low-beam headlamp range depending on the distance to the other vehicle. Once the system no longer detects any other vehicles, it reactivates the high-beam headlamps.

The system's optical sensor is located behind the windshield near the overhead control panel.

Switching Adaptive Highbeam Assist on/off

- ▶ **To activate:** activate the Adaptive Highbeam Assist function using the on-board computer (▷ page 204).
- ▶ Turn the light switch to **AUTO**.
- ▶ Press the combination switch beyond the pressure point in the direction of arrow ① (▷ page 108).

The  indicator lamp in the multifunction display lights up if it is dark and the light sensor activates the low-beam headlamps.



If you drive at speeds above approximately 28 mph (45 km/h):

the headlamp range is set automatically depending on the distance between the vehicle and other road users.

If you are driving at speeds above approximately 35 mph (55 km/h) and no other road users have been detected:

the high-beam headlamps are switched on automatically. The  indicator lamp in the instrument cluster also lights up.

If you drive at speeds below approximately 30 mph (45 km/h) or if other road users are identified or if the roads are sufficiently illuminated:

the high-beam headlamps are switched off automatically. The  indicator lamp in the instrument cluster goes out. The  indicator lamp in the multifunction display remains lit.

- ▶ **To deactivate:** move the combination switch back to its normal position. The  indicator lamp in the instrument cluster goes out.

Headlamps fogged up on the inside

The headlamps may fog up on the inside if there is high atmospheric humidity.

- ▶ Switch on the lights and drive off. The level of fogging diminishes, depending on the length of the journey and the weather conditions (humidity and temperature).

If the level of fogging does not diminish:



- ▶ Have the headlamps checked at a qualified specialist workshop.

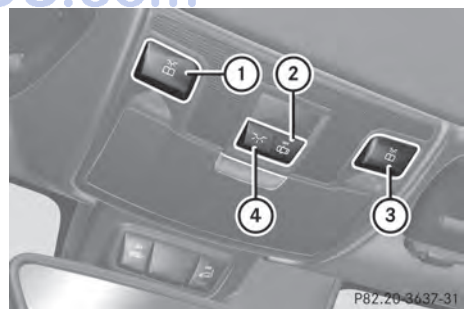

Interior lighting

Overview of interior lighting



Overhead control panel

- ①  Switches the left-hand reading lamp on/off
- ②  Switches the automatic interior lighting control on/off

- ③  Switches the right-hand reading lamp on/off
- ④  Switches the interior lighting on/off

Interior lighting control

General notes

In order to prevent the vehicle's battery from discharging, the interior lighting functions are automatically deactivated after some time unless the SmartKey is in position **2** in the ignition lock.

The color and brightness of the ambient lighting may be set using the on-board computer (▷ page 204).

Automatic interior lighting control



- **To activate/deactivate:** press the  button.
- When the automatic interior lighting control is activated, the button is flush with the overhead control panel.

The interior lighting automatically switches on if you:

- unlock the vehicle
- open a door
- remove the SmartKey from the ignition lock

The interior light is activated for a short while when the SmartKey is removed from the ignition lock. You can activate this delayed switch-off using the on-board computer (▷ page 205).

Manual interior lighting control

- **To switch the interior lighting on/off:** press the  button.
- **To switch the reading lamps on/off:** press the  button.

Crash-responsive emergency lighting

The interior lighting is activated automatically if the vehicle is involved in an accident.

- **To switch off the crash-responsive emergency lighting:** press the hazard warning lamp button.

or

- Lock and then unlock the vehicle using the SmartKey.

Replacing bulbs

Important safety notes

Xenon bulbs

DANGER

Xenon bulbs carry a high voltage. You could get an electric shock and be seriously or even fatally injured if you touch the electric contacts on Xenon bulbs. Therefore, never remove the cover from Xenon bulbs.

Do not change the Xenon bulbs yourself, but have them replaced at a qualified workshop.

If your vehicle is equipped with Xenon bulbs, you can recognize this by the following: the cone of light from the Xenon bulbs moves from the top to the bottom and back again when you start the engine. For this to be observed, the lights must be switched on before starting the engine.

Bulbs and lamps are an important aspect of vehicle safety. You must therefore make sure that these function correctly at all times. Have the headlamp setting checked regularly.

Other bulbs

WARNING

Bulbs and lamps can become very hot. For this reason, allow them to cool down before changing them. Otherwise, you could burn yourself when you touch them.

Keep bulbs out of the reach of children. Otherwise, they could, for example, damage the bulbs and injure themselves. Never use a bulb which has been dropped. Such a bulb may explode and injure you. Halogen bulbs are pressurized and could explode when you change them, especially if they are very hot. You should therefore wear eye protection and gloves when you are changing them.

There are bulbs other than the Xenon bulbs that you cannot replace. Replace only the bulbs listed (▷ page 113). Have the bulbs that you cannot replace yourself changed at a qualified specialist workshop.

If you require assistance changing bulbs, consult a qualified specialist workshop.

Do not touch the glass tube of new bulbs with your bare hands. Even minor contamination can burn into the glass surface and reduce the service life of the bulbs. Always use a lint-free cloth or only touch the base of the bulb when installing.

Only use bulbs of the correct type.

If the new bulb still does not light up, consult a qualified specialist workshop.

Bulbs and lamps are an important aspect of vehicle safety. You must therefore make sure that these function correctly at all times. Have the headlamp setting checked regularly.

Overview: changing bulbs/bulb types

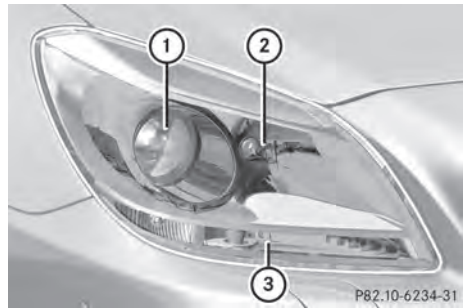

Halogen headlamps

- ① Low-beam headlamp: H7 55 W
- ② High-beam headlamp: H7 55 W
- ③ Turn signal lamp: PY 21 W

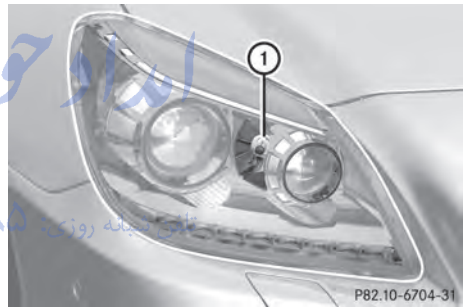

Bi-Xenon headlamps

- ① Cornering lamp: H7 55 W

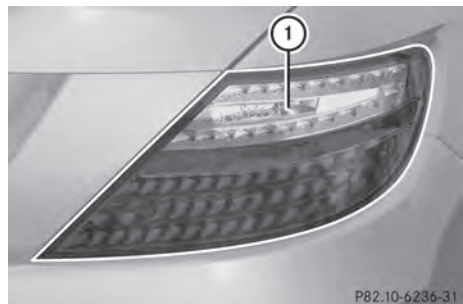

Tail lamp

- ① Backup lamp: W 16 W

Changing the front bulbs

Removing/mounting the cover in the front wheel housing



P40.10-5913-31

- ▶ **To remove:** switch off the lights.
- ▶ Turn the front wheels inwards.
- ▶ Slide cover ① up and remove it.
- ▶ **To install:** insert cover ① again and slide down until it engages.

Low-beam headlamps (halogen headlamps)

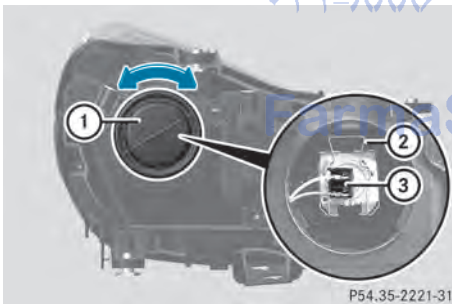

P54.35-2221-31

- ▶ Remove the cover in the front wheel housing (▷ page 114).
- ▶ Turn housing cover ① counter-clockwise and pull it out.
- ▶ Press retainer ② up.
- ▶ Remove connector ③ with the bulb.
- ▶ Pull the bulb out of connector ③.
- ▶ Insert the new bulb into connector ③ and into bracket for retainer ②.

Make sure the bulb is positioned correctly.

- ▶ Press retainer ② down.
- ▶ Attach housing cover ① and turn it clockwise until it engages.
- ▶ Replace the cover in the front wheel housing (▷ page 114).

High-beam headlamps (halogen headlamps)/cornering lamps (Bi-Xenon headlamps)

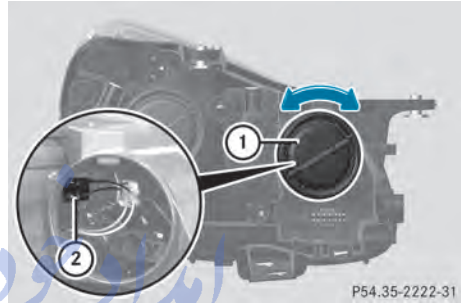

P54.35-2222-31

- ▶ Switch off the lights.
- ▶ Open the hood.
- ▶ Turn housing cover ① counter-clockwise and pull it out.
- ▶ At the bulb holder, push the bulb upwards, disconnect it and pull it out of bulb holder ②.
- ▶ Insert the new bulb into bulb holder ②, push it down and secure it in place.
- ▶ Attach housing cover ① and turn it clockwise until it engages.

Side marker lamps (halogen headlamps)

Due to their location, have the bulbs in the side marker lamp changed at a qualified specialist workshop.

Turn signal lamp (halogen headlamps)

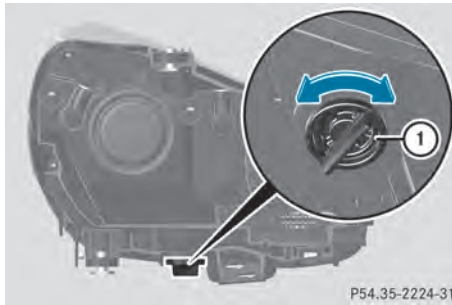

- ▶ Switch off the lights.
- ▶ Open the hood.
- ▶ Turn bulb holder ① counter-clockwise and pull it out.
- ▶ Take the bulb out of bulb holder ①.
- ▶ Insert the new bulb into bulb holder ①.
- ▶ Insert bulb holder ① and turn it clockwise until it engages.

Changing the rear bulbs

Backup lamp

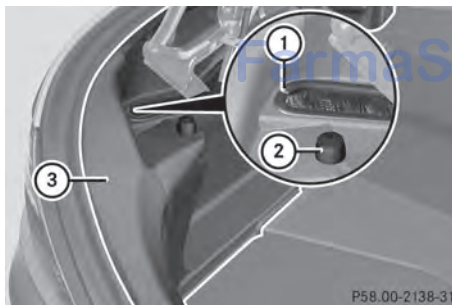

- ▶ Switch off the lights.
- ▶ Make sure that the roof is closed.
- ▶ Open the trunk.
- ▶ Turn and pull out buffer stop ②.
- ▶ Unclip catch ① for side paneling ③.

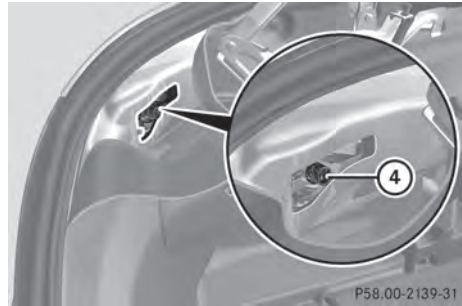

- ▶ Reach upwards into side paneling ③, loosen and pull downwards until holder ④ of the backup lamp is easily accessible.
- ▶ Pull out bulb holder ④.
- ▶ Pull out the bulb.
- ▶ Insert the new bulb into bulb holder ④.
- ▶ Insert holder ④ until it engages.
- ▶ re-install side paneling ③ precisely.
- ▶ Clip in catch ① for side paneling ③.
- ▶ Push in and tighten buffer stop ②.

Windshield wipers

Switching the windshield wipers on/off

WARNING

The windshield will no longer be wiped properly if the wiper blades are worn. This could prevent you from observing the traffic conditions, thereby causing an accident. Replace the wiper blades twice a year, ideally in spring and fall.

- ❗ Do not operate the windshield wipers when the windshield is dry, as this could damage the wiper blades. Moreover, dust that has collected on the windshield can scratch the glass if wiping takes place when the windshield is dry.

If it is necessary to switch on the windshield wipers in dry weather conditions, always

use washer fluid when operating the windshield wipers.

! If the windshield wipers leave smears on the windshield after the vehicle has been washed in an automatic car wash, wax or other residues may be the reason for this. Clean the windshield using washer fluid after washing the vehicle in an automatic car wash.

! Intermittent wiping with rain sensor: due to optical influences and the windshield becoming dirty in dry weather conditions, the windshield wipers may be activated inadvertently. This could then damage the windshield wiper blades or scratch the windshield.

For this reason, you should always switch off the windshield wipers in dry weather.

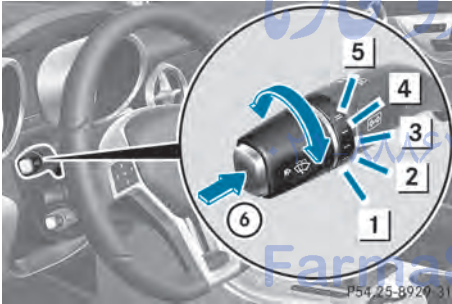

Combination switch

- 1 0 Windshield wipers off
- 2 ... Intermittent wipe, low (rain sensor set to low sensitivity)
- 3 Intermittent wipe, high (rain sensor set to high sensitivity)
- 4 — Continuous wipe, slow
- 5 = Continuous wipe, fast
- 6 Single wipe/ To wipe the windshield using washer fluid

- Switch on the ignition.
- Turn the combination switch to the corresponding position.

In the ... or position, the appropriate wiping frequency is set automatically

according to the intensity of the rain. In the position, the rain sensor is more sensitive than in the ... position, causing the windshield wipers to wipe more frequently.

Replacing the wiper blades

Important safety notes

WARNING

For safety reasons, switch off the windshield wipers and remove the SmartKey from the ignition lock before changing the wiper blades (vehicles with KEYLESS-GO: make sure that the on-board electronics are in state 0). Otherwise, the wiper motor could be switched on suddenly and cause injury.

! To avoid damaging the wiper blades, make sure that you touch only the wiper arm of the wiper.

! Never open the hood if a windshield wiper arm has been folded away from the windshield.

Never fold a windshield wiper arm without a wiper blade back onto the windshield.

Hold the windshield wiper arm firmly when you change the wiper blade. If you release the windshield wiper arm without a wiper blade and it falls onto the windshield, the windshield may be damaged by the force of the impact.

Mercedes-Benz recommends that you have the wiper blades changed at a qualified specialist workshop.

! Always position the windshield wiper arms vertically before folding them away from the windshield. By doing so, you will avoid damage to the hood.

Replacing the wiper blades

Removing the wiper blades

- ▶ Turn the SmartKey to position **1** or **2** in the ignition lock.
- ▶ Set the windshield wipers to position .
- ▶ When the wiper arms have reached a vertical position, turn the SmartKey to position **0** and remove it from the ignition lock.
- ▶ Fold the windshield wiper arms away from the windshield.

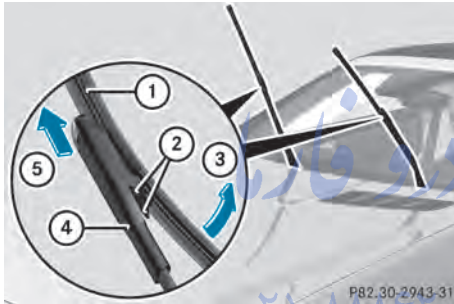

- ▶ Press both release clips (2).
- ▶ Fold wiper blade (1) in the direction of arrow (3) away from wiper arm (4).
- ▶ Remove wiper blade (1) in the direction of arrow (5).

Installing the wiper blades

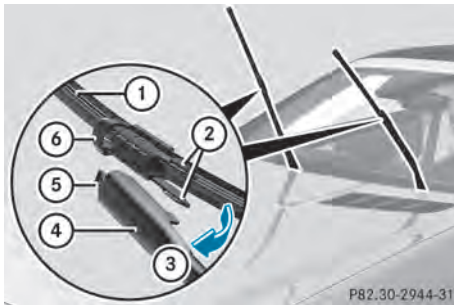

- ▶ Position new wiper blade (1) with recess (6) on lug (5).
- ▶ Fold wiper blade (1) in the direction of arrow (3) onto the wiper arm, until retaining clips (2) engage in bracket (4).
- ▶ Make sure that wiper blade (1) is seated correctly.
- ▶ Fold the wiper arm back onto the windshield.

Problems with the windshield wipers

The windshield wipers are obstructed

- ▶ For safety reasons, you should remove the SmartKey from the ignition lock.
- or
- ▶ Switch off the engine using the Start/Stop button and open the driver's door.
 - ▶ Remove the cause of the obstruction.
 - ▶ Switch the windshield wipers back on.

The windshield wipers are inoperative

The windshield wiper drive is malfunctioning.

- ▶ Select another wiper speed on the combination switch.
- ▶ Have the windshield wipers checked at a qualified specialist workshop.

The spray nozzles are misaligned

The windshield washer fluid from the spray nozzles no longer hits the center of the windshield. The spray nozzles are misaligned.

- ▶ Have the spray nozzles adjusted at a qualified specialist workshop.

امداد خودرو فارما

تلفن شبانه روزی: ۰۲۱-۸۸۸۶۲۰۸۵

FarmaSOS.com

Useful information	120
Overview of climate control systems	120
Operating the climate control systems	125
Setting the air vents	130

امداد خودرو فارما

تلفن شبانه روزی: ۰۲۱-۸۸۸۶۲۰۸۵

FarmaSOS.com

Useful information

- i** This Operator's Manual describes all models and all standard and optional equipment of your vehicle available at the time of publication of the Operator's Manual. Country-specific differences are possible. Please note that your vehicle may not be equipped with all features described. This also applies to safety-related systems and functions.
- i** Read the information on qualified specialist workshops: (▷ page 23).

i Ventilate the vehicle for a brief period during warm weather. This will speed up the cooling process and the desired vehicle interior temperature will be reached more quickly.

i The integrated filter can filter out most particles of dust, and completely filters out pollen. A clogged filter reduces the amount of air supplied to the vehicle interior. For this reason, you should always observe the interval for replacing the filter, which is specified in the Maintenance Booklet. Since the replacement interval depends on environmental conditions, e.g. heavy air pollution, the interval may be shorter than stated in the Maintenance Booklet.

Overview of climate control systems

Important safety notes

WARNING

Observe the settings recommended on the following pages. The windows could otherwise fog up. This could prevent you from observing the traffic conditions, thereby causing an accident.

WARNING

Severe conditions (e.g. strong air pollution) may require replacement of the filter before its scheduled replacement interval. A clogged filter will reduce the air volume to the interior and the windows could fog up, impairing visibility and endangering you and others. Have a clogged filter replaced as soon as possible at a qualified specialist workshop.

Climate control regulates the temperature and the humidity in the vehicle interior and filters undesirable substances out of the air.

Climate control is only operational when the engine is running. The system only works optimally when the side windows and the roof are closed.

The residual heat function can only be activated or deactivated with the ignition switched off (▷ page 129).

Air-conditioning system control panel

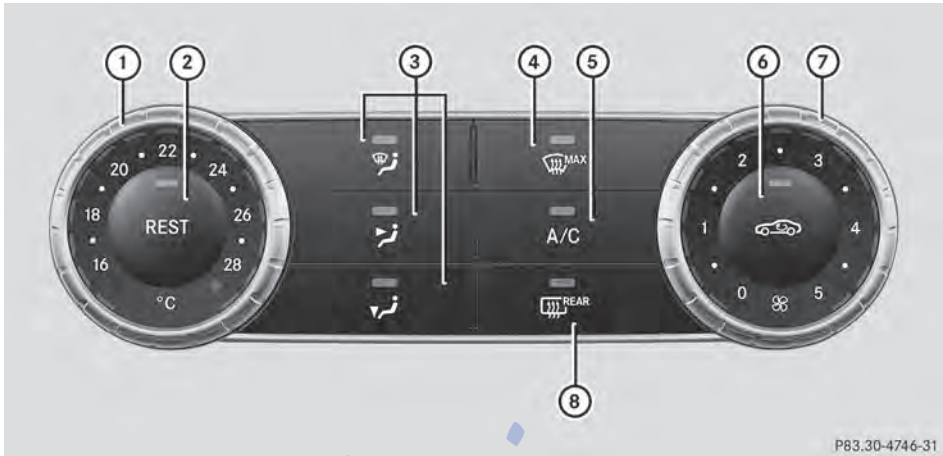

P83.30-4746-31

Canada only

- ① Sets the temperature (▷ page 126)
- ② Activates/deactivates the residual heat function (▷ page 129)
- ③ Sets the air distribution (▷ page 127)
- ④ Defrosts the windshield (▷ page 128)
- ⑤ Activates/deactivates cooling with air dehumidification (▷ page 125)
- ⑥ Activates/deactivates air-recirculation mode (▷ page 129)
- ⑦ Sets the airflow (▷ page 127)
- ⑧ Switches the rear window defroster on/off (▷ page 128)

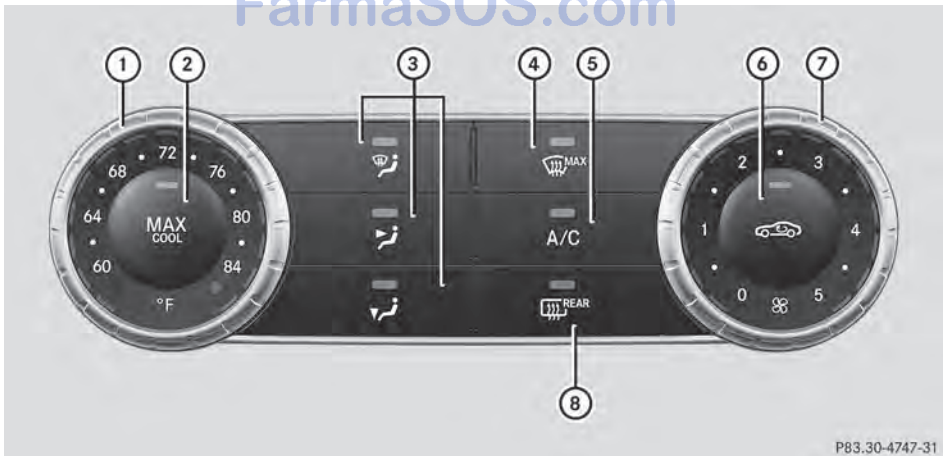

P83.30-4747-31





USA only

- ① Sets the temperature (▷ page 126)
- ② Switches maximum cooling MAX COOL on/off (▷ page 128)

- ③ Sets the air distribution (▷ page 127)
- ④ Defrosts the windshield (▷ page 128)
- ⑤ Activates/deactivates cooling with air dehumidification (▷ page 125)
- ⑥ Activates/deactivates air-recirculation mode (▷ page 129)
- ⑦ Sets the airflow (▷ page 127)
- ⑧ Switches the rear window defroster on/off (▷ page 128)

Notes on using the air-conditioning system

Below, you can find a number of notes and recommendations to help you use the air-conditioning system optimally.

- Switch on climate control using the  button. The indicator lamp in the  button lights up.
- Set the temperature to 72 °F (22 °C).
- **Recommendation for air distribution in winter:** set the  and  settings.

Recommendation for air distribution in summer: set the  setting.

- Only use the "defrosting" function briefly until the windshield is clear again.
- Only use "air-recirculation" mode briefly, e.g. if there are unpleasant outside odors or when in a tunnel. The windows could otherwise fog up, since no fresh air is drawn into the vehicle in air-recirculation mode.

Control panel for 2-zone automatic climate control

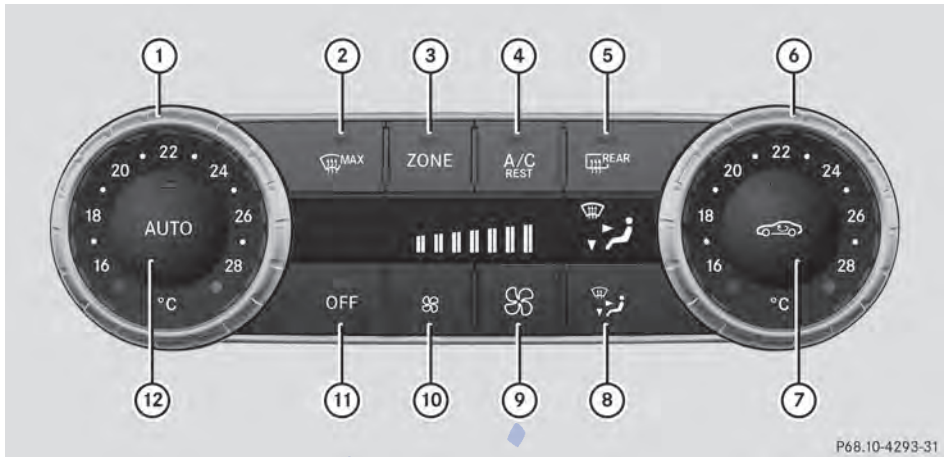

Canada only

- ① Sets the temperature, left (▷ page 126)
- ② Defrosts the windshield (▷ page 128)
- ③ Switches the ZONE function on/off
- ④ Activates/deactivates cooling with air dehumidification (▷ page 125)
Activates/deactivates the residual heat function (▷ page 129)
- ⑤ Switches the rear window defroster on/off (▷ page 128) تلفن شمار
- ⑥ Sets the temperature, right (▷ page 126)
- ⑦ Activates/deactivates air-recirculation mode (▷ page 129)
- ⑧ Sets the air distribution (▷ page 127) FarmaSOS.com
- ⑨ Increases the airflow (▷ page 127)
- ⑩ Reduces the airflow (▷ page 127)
- ⑪ Switches climate control on/off (▷ page 125)
- ⑫ Sets climate control to automatic (▷ page 126)

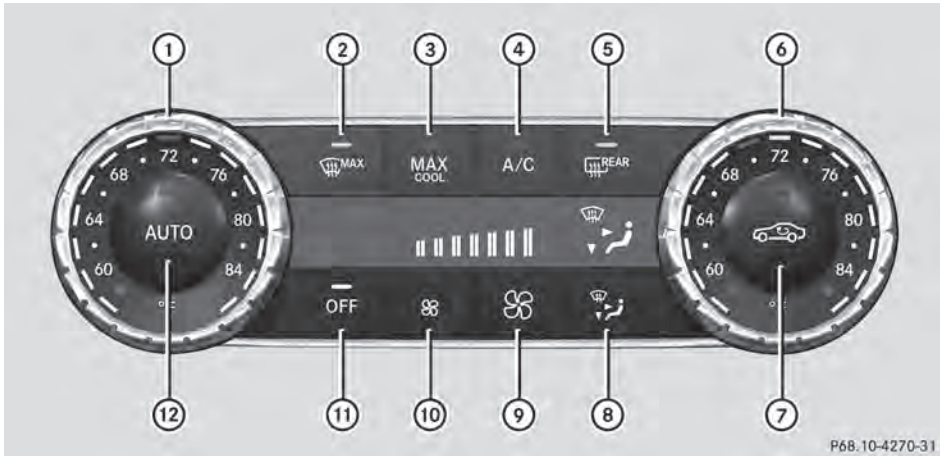

P68.10-4270-31

USA only

- ① Sets the temperature, left (▷ page 126)
- ② Defrosts the windshield (▷ page 128)
- ③ Switches maximum cooling MAX COOL on/off (▷ page 128)
- ④ Activates/deactivates cooling with air dehumidification (▷ page 125)
- ⑤ Switches the rear window defroster on/off (▷ page 128)
- ⑥ Sets the temperature, right (▷ page 126)
- ⑦ Activates/deactivates air-recirculation mode (▷ page 129)
- ⑧ Sets the air distribution (▷ page 127)
- ⑨ Increases the airflow (▷ page 127)
- ⑩ Reduces the airflow (▷ page 127)
- ⑪ Switches climate control on/off (▷ page 125)
- ⑫ Sets climate control to automatic (▷ page 126)

Information about using 3-zone automatic climate control

The following contains instructions and recommendations to enable you to get the most out of your automatic climate control.

- Activate climate control using the **AUTO** and **A/C** or **A/C REST** buttons. The indicator lamps in the **AUTO** and **A/C** or **A/C REST** buttons light up.
- Set the temperature to 72 °F (22 °C).
- Only use the "defrosting" function briefly until the windshield is clear again.
- Only use "air-recirculation" mode briefly, e.g. if there are unpleasant outside odors or when in a tunnel. The windows could otherwise fog up, since no fresh air is drawn into the vehicle in air-recirculation mode.
- Use the ZONE function to adopt the temperature settings on the driver's side for the front-passenger side as well. The indicator lamp in the **ZONE** button goes out.
- Use the residual heat function if you want to heat or ventilate the vehicle interior when the ignition is switched off. The "residual heat" function can only be

activated or deactivated with the ignition switched off.

Operating the climate control systems

Activating/deactivating climate control



General notes

WARNING

When the climate control system is switched off, the outside air supply and circulation are also switched off. Only choose this setting for a short time when the retractable hardtop (vario-roof) is closed. Otherwise, the windows could fog up, impairing visibility and endangering you and others.

- i** Switch on climate control primarily using the **AUTO** button (▷ page 126).

Air-conditioning system

- ▶ **To activate:** turn airflow control  (▷ page 121) clockwise to the desired position (except position **0**).
- ▶ **To deactivate:** turn airflow control  (▷ page 121) counter-clockwise to position **0**.

3-zone automatic climate control

- ▶ Turn the SmartKey to position **2** in the ignition lock.
- ▶ **To switch on:** press the **AUTO** button. The indicator lamp in the **AUTO** button lights up. Airflow and air distribution are set to automatic mode.

or

- ▶ Press the **OFF** button. The indicator lamp in the **OFF** button goes out. The previously selected settings are restored.
- ▶ **To switch off:** press the **OFF** button. The indicator lamp in the **OFF** button lights up.

Activating/deactivating cooling with air dehumidification

General notes









WARNING

If you switch off the cooling function, the vehicle will not be cooled when weather conditions are warm. The windows can fog up more quickly. This may prevent you from observing the traffic conditions, thereby causing an accident.



The cooling with air dehumidification function is only available when the engine is running. The air inside the vehicle is cooled and dehumidified according to the temperature selected.

Condensation may drip from the underside of the vehicle when it is in cooling mode. This is normal and not a sign that there is a malfunction.

Activating/deactivating

- ▶ **To switch on:** press the  or  button.
The indicator lamp in the  or  button lights up.
- ▶ **To deactivate:** press the  or  button.
The indicator lamp in the  or  button goes out. The cooling with air dehumidification function has a delayed switch-off feature.

Problems with the cooling with air dehumidification function

When you press the  or  button, the indicator lamp in the button flashes three times or remains off. You can no longer switch on the cooling with air dehumidification function.

- ▶ Visit a qualified specialist workshop.







Setting climate control to automatic

WARNING

If you switch off the cooling function, the vehicle will not be cooled when weather conditions are warm. The windows can fog up more quickly. Window fogging may impair visibility and endanger you and others.

In automatic mode, the set temperature is maintained automatically at a constant level. The system automatically regulates the temperature of the dispensed air, the airflow and the air distribution.

Automatic mode will achieve optimal operation if cooling with air dehumidification is also activated. If desired, cooling with air dehumidification can be deactivated.

- ▶ Turn the SmartKey to position **2** in the ignition lock.
- ▶ Set the desired temperature.
- ▶ **To activate:** press the  button.
The indicator lamp in the  button lights up. Automatic air distribution and airflow are activated.
- ▶ **To deactivate:** press the  button.
or
- ▶ Press the  or  button.
The indicator lamp in the  button goes out.

Setting the temperature



Air-conditioning system

- ▶ Turn the SmartKey to position **2** in the ignition lock.
- ▶ **To increase/reduce:** turn control  **1** clockwise or counter-clockwise (▷ page 121).

Only change the temperature setting in small increments. Start at 72 °F (22 °C).

3-zone automatic climate control



Different temperatures can be set for the driver's and front-passenger sides.

- ▶ Turn the SmartKey to position **2** in the ignition lock.
- ▶ **To increase/reduce:** turn controls  **1** and  **6** (▷ page 123) clockwise or counter-clockwise.

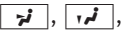

Only change the temperature setting in small increments. Start at 72 °F (22 °C).

Setting the air distribution

Air-conditioning system

- ▶ Turn the SmartKey to position **2** in the ignition lock.
- ▶ Press one or more of the , ,  buttons.
The corresponding indicator lamp lights up briefly.

The following air distribution settings can be selected:





-  Directs air through the defroster vents
-  Directs the airflow through the footwell air vents
-  Directs air through the center and side air vents



i You can also activate several air distribution settings simultaneously. To do this, press multiple air distribution buttons. The air is then directed through various vents.

3-zone automatic climate control

- ▶ Turn the SmartKey to position **2** in the ignition lock.
- ▶ Press the  button repeatedly until the desired symbol appears in the display.

The following air distribution settings can be selected:

-  Directs air through the center and side air vents
-  Directs the airflow through the footwell air vents
-  Directs air through the center, side and footwell vents
-  Directs air through the defroster vents
-  Directs the airflow through the defroster, center and side air vents²

-  Directs air through the defroster and footwell vents
-  Directs the airflow through the defroster, center and side air vents as well as the footwell air vents



i Regardless of the air distribution setting, airflow is always directed through the side air vents. You can only close the side air vents, by fully closing the adjuster on the side air vents (▶ page 130).

Setting the airflow

Air-conditioning system





- ▶ Turn the SmartKey to position **2** in the ignition lock.
- ▶ **To increase/reduce:** turn control  clockwise or counter-clockwise (▶ page 121).

3-zone automatic climate control

- ▶ Turn the SmartKey to position **2** in the ignition lock.
- ▶ **To increase/reduce:** press the  or  button.

Switching the ZONE function on/off

This function is only available with 3-zone automatic climate control.



- ▶ **To switch on:** press the  button. The indicator lamp in the  button lights up. The temperature setting for the driver's side is not adopted for the front-passenger side.
- ▶ **To switch off:** press button . The indicator lamp in the  button goes out. The temperature setting for the driver's side is adopted for the front-passenger side.



² Canada only.

Defrosting the windshield



You can use this function to defrost the windshield or to defrost the inside of the windshield and the side windows.

Switch off the "defrosting" function as soon as the windshield is clear again.

- ▶ Turn the SmartKey to position **2** in the ignition lock.
- ▶ **To activate:** press the  button. The indicator lamp in the  button lights up. The climate control system switches to the following functions:
 - cooling with air dehumidification (if desired)
 - high airflow (depending on the outside temperature)
 - high temperature (depending on the outside temperature)
 - air distribution to the windshield and front side windows
 - air-recirculation mode off

- ▶ **To deactivate:** press the  button. The indicator lamp in the  button goes out. The previously selected settings are restored. Air-recirculation mode remains deactivated.

or

- ▶ Press the  button. The indicator lamp in the  button goes out. Airflow and air distribution are set to automatic mode.

MAX COOL maximum cooling

The MAX COOL function is only available in vehicles for the USA.

MAX COOL is only operational when the engine is running.

- ▶ **To activate:** press the  button. The indicator lamp in the button lights up.
- ▶ **To activate:** press off-road button  again. The indicator lamp goes out. The previously selected settings are restored.

When you activate MAX COOL, climate control switches to the following functions:



- maximum cooling
- maximum airflow
- air-recirculation mode on

Defrosting the windows

Windows fogged up on the inside

- ▶ Activate the cooling with air dehumidification function .
- ▶ Activate automatic mode .
- ▶ If the windows continue to fog up, activate the defrosting function (▷ page 128).
- ▶ You should only select this setting until the windshield is clear again.

Windows fogged up on the outside

- ▶ Activate the windshield wipers.
- ▶ Press the  button repeatedly until the  or  symbol appears in the display.
- ▶ You should only select this setting until the windshield is clear again.

Rear window defroster

Activating/deactivating



WARNING

Clear all windows of ice or snow before setting off. Otherwise, impaired visibility could endanger you and others.

The rear window defroster has a high current draw. You should therefore switch it off as soon as the rear window is clear. Otherwise,

the rear window defroster switches off automatically after several minutes.



If the battery voltage is too low, the rear window defroster may switch off.

- ▶ Turn the SmartKey to position **2** in the ignition lock.
- ▶ Press the  button.
The indicator lamp in the  button lights up or goes out.

Problems with the rear window defroster



If the indicator lamp in the  rear window defroster button flashes, the on-board voltage is too low or the roof is open. The rear window defroster has deactivated prematurely or cannot be activated.

- ▶ Switch off any consumers that are not required, e.g. reading lamps or interior lighting.
When the battery is sufficiently charged, the rear window defroster is activated again automatically.
- or
- ▶ Close the roof.
The rear window defroster can be activated again.

- ▶ Turn the SmartKey to position **2** in the ignition lock.
- ▶ **To activate:** press the  button.
The indicator lamp in the  button lights up.

i Air-recirculation mode is automatically activated at high levels of pollution or at high outside temperatures. When air-recirculation mode is activated automatically, the indicator lamp in the  button is not lit.

Outside air is added after about 30 minutes.

- ▶ **To deactivate:** press the  button.
The indicator lamp in the  button goes out.

i Air-recirculation mode deactivates automatically:

- after approximately five minutes at outside temperatures below approximately 41 °F (5 °C)
- after approximately five minutes if cooling with air dehumidification is deactivated
- after approximately 30 minutes at outside temperatures above approximately 41 °F (5 °C)

Activating/deactivating air-recirculation mode



WARNING

At low outside temperatures, only switch over to air-recirculation mode for brief periods. Otherwise, the windows could fog up, thus impairing visibility and endangering yourself and others. This may prevent you from observing the traffic conditions and thereby cause an accident.

Activating/deactivating the residual heat function

The residual heat function is only available on vehicles for Canada.

It is possible to make use of the residual heat of the engine to continue heating the stationary vehicle for up to 30 minutes after the engine has been switched off. The heating time depends on the temperature that has been set.

Depending on the equipment level, the control panel has either the  button or the  button.

► Turn the SmartKey to position **0** in the ignition lock or remove it.

► **To switch on:** press the **REST** or **A/C REST** button.

The indicator lamp in the **REST** or **A/C REST** button lights up.

i The blower will run at a low speed regardless of the airflow setting.

i If you activate the residual heat function at high temperatures, only the ventilation will be activated. The blower runs at medium speed.

► **To deactivate:** press the **REST** or **A/C REST** button.

The indicator lamp in the **REST** or **A/C REST** button goes out.

Residual heat is deactivated automatically:

- after approximately 30 minutes
- when the ignition is switched on
- if the battery voltage drops
- when the auxiliary heating is activated

Setting the air vents

Important safety notes

⚠ WARNING

Very hot or very cold air can flow from the air vents. This could cause burns or frostbite to bare skin in the immediate vicinity of the vents. Keep bare skin away from these air vents. If necessary, direct the airflow away to a different area of the vehicle interior.

In order to ensure the direct flow of fresh air through the air vents into the vehicle interior, please observe the following notes:

- keep the air inlet grille on the hood and in the engine compartment on the front-passenger side free of blockages, such as ice, snow or leaves.
- never cover the air vents or air intake grilles in the vehicle interior.

i You can move the adjusters for the air vents vertically or horizontally to set the direction of the airflow.

i For optimal climate control in the vehicle, open the air vents completely and set the adjusters to the central position.

Setting the center air vents

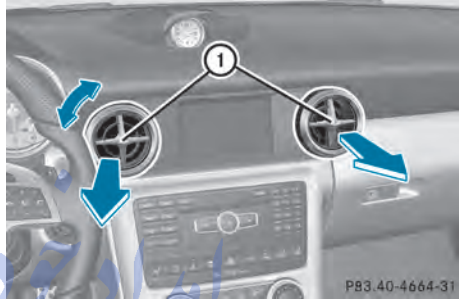

► **To open the center air vent:** turn the adjuster in one of center air vents **①** counter-clockwise.

► **To close the center air vent:** turn the adjuster in one of center air vents **①** clockwise until it engages.

Setting the side air vents

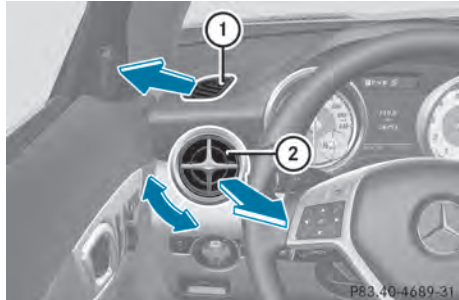

① Side window defroster vent

② Side air vent

- ▶ **To open a side air vent:** turn the adjuster in side air vent ② counter-clockwise.
- ▶ **To close a side air vent:** turn the adjuster in side air vent ② clockwise until it engages.

AIRSCARF, setting the vents

WARNING

When operating the climate control, the air that enters the passenger compartment through the air vents can be very hot or very cold (depending on the set temperature). This could cause burns or frostbite to unprotected skin in the immediate area of the air vents.

Always keep sufficient distance between unprotected parts of the body and the air vents. If necessary, use the air distribution adjustment to direct the air to air vents in the vehicle interior that are not in the immediate area of unprotected skin.

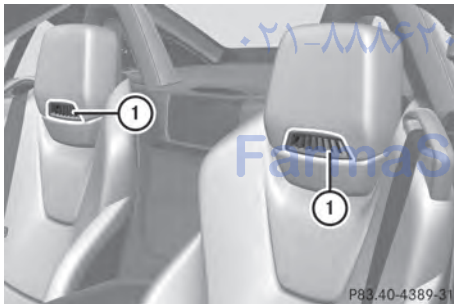

You can adjust the blower output of AIRSCARF vents ① using the AIRSCARF button (> page 98).

امداد خودرو فارما

تلفن شبانه روزی: ۰۲۱-۸۸۸۶۲۰۸۵

FarmaSOS.com

Useful information	134
Breaking-in notes	134
Driving	135
Manual transmission	144
Automatic transmission	145
Refueling	152
Parking	155
Driving tips	158
Driving systems	163

امداد خودرو فارما

تلفن شبانه روزی: ۰۲۱-۸۸۸۶۲۰۸۵

FarmaSOS.com

Useful information

- i** This Operator's Manual describes all models and all standard and optional equipment of your vehicle available at the time of publication of the Operator's Manual. Country-specific differences are possible. Please note that your vehicle may not be equipped with all features described. This also applies to safety-related systems and functions.
- i** Read the information on qualified specialist workshops: (▷ page 23).

Breaking-in notes

Important safety notes

New and replaced brake pads and discs only reach their optimum braking effect after several hundred kilometers of driving. Compensate for this by applying greater force to the brake pedal.

The first 1,000miles (1,500 km)

The more you look after the engine when it is new, the more satisfied you will be with its performance in the future.

- You should therefore drive at varying vehicle and engine speeds for the first 1,000miles (1,500km).
- Avoid heavy loads, e.g. driving at full throttle, during this period.
- Change gear in good time, before the tachometer needle is $\frac{2}{3}$ of the way to the red area of the tachometer.
- Do not manually shift to a lower gear to brake the vehicle.

Vehicles with automatic transmission:

- Ideally, drive for the first 1,000 miles (1,500km) in drive program **C**.
- If possible, do not depress the accelerator pedal past the point of resistance (kickdown).
- Only select shift ranges **3**, **2** or **1** when driving slowly, e.g. in mountainous terrain.

After 1,000 miles (1,500km), you can increase the engine speed gradually and bring the vehicle up to full speed.

Additional breaking-in notes for AMG vehicles:

- Do not drive faster than 85 mph (140 km/h) for the first 1,000 miles (1,500 km).
- Only allow the engine to reach a maximum engine speed of 4,500 rpm briefly.
- Change gear in good time.

- i** You should also observe these breaking-in notes if the engine or parts of the drive train on your vehicle have been replaced.
- i** Always observe the respective speed limits.

AMG vehicles with rear axle locking differential

Your vehicle is equipped with a self-locking differential on the rear axle. To improve the protection of the differential on the rear axle, change the oil after a break-in distance of 2000 miles (3000 km). This oil change extends the service life of the differential. Have the oil change carried out at a qualified specialist workshop. Mercedes-Benz recommends that you use an authorized Mercedes-Benz Center for this purpose.

Driving

Important safety notes

WARNING

Objects in the driver's footwell can restrict the pedal travel or obstruct a depressed pedal. The operating and road safety of the vehicle is jeopardized. There is a risk of an accident. Make sure that all objects in the vehicle are stowed correctly, and that they cannot enter the driver's footwell. Install the floor mats securely and as specified in order to ensure sufficient clearance for the pedals. Do not use loose floor mats.

WARNING

Unsuitable footwear can hinder correct usage of the pedals, e.g.:

- shoes with thick soles
- shoes with high heels
- slippers

There is a risk of an accident.

Wear suitable footwear to ensure correct usage of the pedals.

WARNING

If you switch off the ignition while driving, safety-relevant functions are only available with limitations, or not at all. This could affect, for example, the power steering and the brake boosting effect. You will require considerably more effort to steer and brake. There is a risk of an accident.

Do not switch off the ignition while driving.

WARNING

If the parking brake has not been fully released when driving, the parking brake can:

- overheat and cause a fire
- lose its hold function.

There is a risk of fire and an accident. Release the parking brake fully before driving off.

! Warm up the engine quickly. Do not use the engine's full performance until it has reached operating temperature.

Only shift the automatic transmission to the desired drive position when the vehicle is stationary.

Where possible, avoid spinning the drive wheels when pulling away on slippery roads. You could otherwise damage the drive train.

! **AMG vehicles:** at low engine oil temperatures below 68 °F (+20 °C), the maximum engine speed is restricted in order to protect the engine. To protect the engine and maintain smooth engine operation, avoid driving at full throttle when the engine is cold.

SmartKey positions

SmartKey

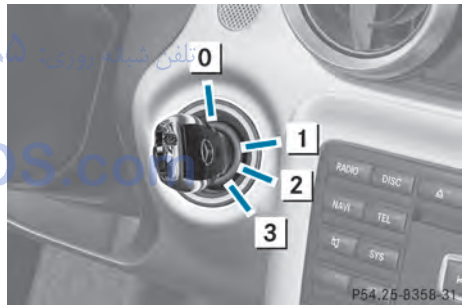

- 0** To remove the SmartKey
Vehicles with automatic transmission: shift the transmission to position **P**
- 1** Power supply for some consumers, such as the windshield wipers
- 2** Ignition (power supply for all consumers) and drive position
- 3** To start the engine
- i** The SmartKey can be turned in the ignition lock even if it is not the correct SmartKey for the vehicle. The ignition is not switched on. The engine cannot be started.

KEYLESS-GO

General notes

Vehicles with KEYLESS-GO are equipped with a SmartKey featuring an integrated KEYLESS-GO start function and a detachable Start/Stop button.

You can switch the engine on and off with the Start/Stop button. The Start/Stop button must be inserted into the ignition lock and the SmartKey must be in the vehicle.

Pressing the Start/Stop button several times in succession corresponds to the different SmartKey positions in the ignition lock. This is only the case if you are not depressing the brake pedal.

If you depress the brake pedal and press the Start/Stop button, the engine starts immediately.

The Start/Stop button can be removed from the ignition lock. Then, you can insert the SmartKey into the ignition lock.

i You do not have to remove the Start/Stop button from the ignition lock when you leave the vehicle. You should, however, always take the SmartKey with you when leaving the vehicle. As long as the SmartKey is in the vehicle:

- the vehicle can be started using the Start/Stop button and
- electrically powered equipment can be operated.

i The engine can be turned off while the vehicle is in motion by pressing and holding the Start/Stop button for approximately three seconds. This function operates independently from the ECO start/stop automatic engine switch-off function.

Key positions with KEYLESS-GO

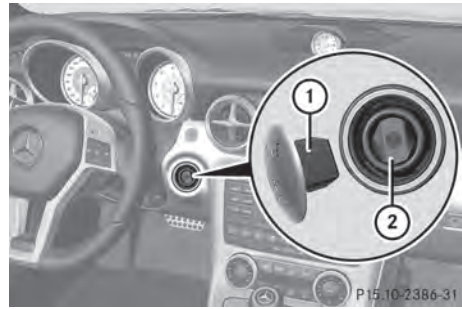

- ① Start/Stop button
- ② Ignition lock

► Insert Start/Stop button ① into ignition lock ②.

i When you insert Start/Stop button ① into ignition lock ②, the system needs approximately two seconds recognition time. You can then use Start/Stop button ①.



Start/Stop button

- ③ USA only
- ④ Canada only

Activating power supply

► If Start/Stop button ① has not yet been pressed, this corresponds to the SmartKey being removed from the ignition.

► Press Start/Stop button ① once. The power supply is switched on. You can now activate the windshield wipers, for example.

- 1 If you then open the driver's door when in this position, the power supply is deactivated.

Switching on the ignition

- ▶ Press Start/Stop button 1 twice. The ignition is switched on.

- 1 The power supply is switched off if you press Start/Stop button 1 twice when in this position and the driver's door is open.

As soon as the ignition is switched on, all the indicator lamps in the instrument cluster light up. If an indicator lamp does not go out after starting the engine or lights up while driving, there may be a technical problem (▷ page 244).

Removing the Start/Stop button



You can remove the Start/Stop button from the ignition lock and start the vehicle as normal using the SmartKey.

- ▶ Remove Start/Stop button 1 from ignition lock 2.
- 1 You do not have to remove the Start/Stop button from the ignition lock when you leave the vehicle.

Starting the engine

Important safety notes

WARNING

Combustion engines emit poisonous exhaust gases such as carbon monoxide. Inhaling

these exhaust gases leads to poisoning. There is a risk of fatal injury. Therefore never leave the engine running in enclosed spaces without sufficient ventilation.

- ! Do not depress the accelerator pedal when starting the engine.
- 1 **AMG vehicles:** the exhaust flap of the exhaust system will be checked after every cold start. A resulting noise can be heard during this process.
- 1 During a cold start, the engine runs at higher speeds to enable the catalytic converter to reach its operating temperature. The sound of the engine may change during this time.

Manual transmission

- ▶ Depress the brake pedal and keep it depressed.
- ▶ Fully depress the clutch pedal.
- ▶ Shift to neutral **N**.
- 1 You can only start the engine when the clutch pedal is fully depressed.

Automatic transmission

- ▶ Shift the transmission to position **P**. The transmission position display in the multifunction display shows **P**.
- 1 You can also start the engine when the transmission is in position **N**.

Starting procedure with the SmartKey

- ▶ Turn the key to position **3** in the ignition lock (▷ page 135) and release it as soon as the engine is running.
- 1 To start the engine using the SmartKey instead of KEYLESS-GO, pull the Start/Stop button out of the ignition lock.

Using KEYLESS-GO to start the engine

WARNING

As long as the SmartKey is in your vehicle, the vehicle can be started. Therefore, never leave children unattended in the vehicle, as they could otherwise accidentally start the engine. When leaving the vehicle, always take the SmartKey with you and lock the vehicle. Do not leave children unattended in the vehicle, or with access to an unlocked vehicle. A child's unsupervised access to a vehicle could result in an accident and/or serious personal injury.

- i** The Start/Stop button can be used to start the vehicle manually without inserting the SmartKey into the ignition lock. The Start/Stop button must be inserted into the ignition lock and the SmartKey must be in the vehicle. This mode for starting the engine operates independently of the ECO start/stop automatic engine start function.
- ▶ Depress the brake pedal and keep it depressed.
- ▶ Press Start/Stop button (▷ page 136) once.
The engine starts.

Pulling away

Manual transmission

- !** Change gear in good time and avoid spinning the wheels. You could otherwise damage the vehicle.
- ▶ Depress the brake pedal and keep it depressed.
- ▶ Fully depress the clutch pedal.
- ▶ Shift to either first gear or reverse gear **R**.
- ▶ Release the electric parking brake (▷ page 156).
- ▶ Release the brake pedal.
- ▶ Slowly release the clutch pedal and gently depress the accelerator pedal.

- i** The vehicle locks centrally once you have pulled away. The locking knobs in the doors drop down.

You can open the doors from the inside at any time.

You can also deactivate the automatic locking feature (▷ page 206).



Automatic transmission

WARNING

If the engine speed is above the idling speed and you engage transmission position **D** or **R**, the vehicle could pull away suddenly. There is a risk of an accident.

When engaging transmission position **D** or **R**, always firmly depress the brake pedal and do not simultaneously accelerate.

- i** It is only possible to shift the transmission from position **P** to the desired position if you depress the brake pedal. Only then is the shift lock released.

- ▶ Depress the brake pedal and keep it depressed.
 - ▶ Shift the transmission to position **D** or **R**.
 - ▶ Release the brake pedal.
 - ▶ Carefully depress the accelerator pedal. The electric parking brake (▷ page 156) is automatically released.
- The red  (USA only) or  (Canada only) indicator lamp in the instrument cluster goes out.

- i** The vehicle locks centrally once you have pulled away. The locking knobs in the doors drop down.

You can open the doors from the inside at any time.

You can also deactivate the automatic locking feature (▷ page 206).

- i** Upshifts take place at higher engine speeds after a cold start. This helps the catalytic converter to reach its operating temperature more quickly.

Hill start assist

WARNING

After a short time, hill start assist will no longer brake your vehicle and it could roll away. There is a risk of an accident and injury. Therefore, quickly move your foot from the brake pedal to the accelerator pedal. Never leave the vehicle when it is held by hill start assist.

Hill start assist helps you when pulling away forwards or in reverse on an uphill gradient. It holds the vehicle for a short time after you have removed your foot from the brake pedal. This gives you enough time to move your foot from the brake pedal to the accelerator pedal and to depress it before the vehicle begins to roll.

- ▶ Remove your foot from the brake pedal. The vehicle is then held for about a second.
- ▶ Pull away.

Hill start assist will not function if:

- you are pulling away on a level road or on a downhill gradient.
- on vehicles with automatic transmission, the transmission is in **N**.
- the electric parking brake is applied.
- ESP® is malfunctioning.

ECO start/stop function

Important safety notes

WARNING

If the engine is switched off automatically and you exit the vehicle, the engine is restarted automatically. The vehicle may begin moving. There is a risk of accident and injury.

If you wish to exit the vehicle, always turn off the ignition and secure the vehicle against rolling away.

General notes

The ECO start/stop function switches the engine off automatically when the vehicle stops moving.

The engine starts automatically when the driver wants to pull away again. The ECO start/stop function thereby helps you to reduce the fuel consumption and emissions of your vehicle.

Every time you switch on the engine using the SmartKey or the Start/Stop button, the ECO start/stop function is activated.

AMG vehicles: the ECO start/stop function is only available in drive program **C**.

The system is operational if all conditions for automatic engine switch-off have been fulfilled (▷ page 141) and the **ECO** symbol is shown in the multifunction display.

AMG vehicles: the AMG menu in the multifunction display additionally shows **Stop/Start Active** message.

If conditions for automatic engine switch-off have not been fulfilled (▷ page 141), the **ECO** symbol will not be shown.

AMG vehicles: the AMG menu in the multifunction display also shows the **Stop/Start Inactive** message.

If the ECO start/stop function has been manually deactivated (▷ page 140) or a malfunction has caused the system to be deactivated, the **ECO** symbol is not displayed.

AMG vehicles: the **Stop/Start Active** or **Stop/Start Inactive** display message goes out in the AMG menu of the multifunction display.

- i** **AMG vehicles:** If automatic cylinder shut-off is active in drive program **C**, the number of active cylinders **4** is also shown in the **ECO** symbol. This means that the engine is operating with four cylinders.

If cylinder shut-off is not active, the engine will operate with all eight cylinders. In this

case, the number of active cylinders **8** is shown in the **ECO** symbol.

Deactivating/activating the ECO start/stop function

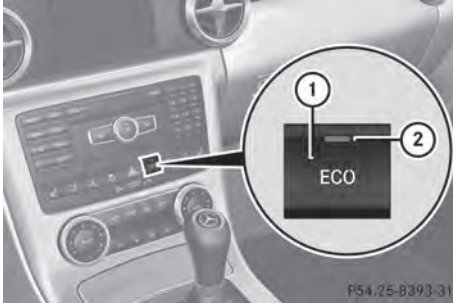

ECO button

Deactivating (except for AMG vehicles)

- ▶ Press button ①.
Indicator lamp ② on button ① and the **ECO** symbol in the multifunction display go out.

Activating (except for AMG vehicles)

- ▶ Press button ①.
Indicator lamp ② lights up. If all conditions for automatic engine switch-off (▷ page 141) are fulfilled, the **ECO** symbol is shown in the multifunction display.
If not all conditions for automatic engine switch-off (▷ page 141) are fulfilled, the **ECO** symbol is not shown in the multifunction display. If this is the case, the ECO start/stop function is not available.

Deactivating (AMG vehicles)

- ▶ Press button ① in drive program **C**.
or
- ▶ Switch to drive program **S** or **M** (▷ page 147).
Indicator lamp ② on button ① and the **ECO** symbol in the multifunction display go out.

The **Stop/Start Active** or **Stop/Start Inactive** message in the AMG menu in the multifunction display goes out.

Activating (AMG vehicles)

- ▶ Press button ①.
Indicator lamp ② lights up. If drive program **S** or **M** is active, the automatic transmission switches to drive program **C**.
If all conditions for automatic engine switch-off (▷ page 141) are fulfilled, the **ECO** symbol is shown in the multifunction display. In addition, the **Stop/Start Active** message is shown in the AMG menu in the multifunction display.
If not all conditions for automatic engine switch-off (▷ page 141) are fulfilled, the **ECO** symbol is not shown in the multifunction display. If this is the case, the ECO start/stop function is not available. In addition, the **Stop/Start Inactive** message is shown in the AMG menu in the multifunction display.

i If indicator lamp ② is off, the ECO start/stop function has been deactivated manually or as the result of a malfunction. The engine will then not be switched off automatically when the vehicle stops.

i All vehicles (except AMG vehicles): the ECO start/stop function is activated each time the engine is switched on.

i AMG vehicles: each time the engine is started, the ECO start/stop function switches to the status (on or off) that was selected before switching off the engine.

Automatic engine switch-off

Method of operation

The ECO start/stop function is operational and the **ECO** symbol is displayed in the multifunction display, if:

- the indicator lamp in the ECO button is lit green.
- the outside temperature is within the comfort range.
- the engine is at normal operating temperature.
- the set temperature for the vehicle interior has been reached.
- the battery is sufficiently charged.
- the system detects that the windshield is not fogged up when the air-conditioning system is switched on
- the hood is closed.
- the driver's door is closed and the driver's seat belt is fastened.

If conditions for automatic engine switch-off have not been fulfilled, the **ECO** symbol will not be shown.

- i All vehicles (apart from AMG vehicles):** automatic engine switch-off can take place a maximum of four times consecutively (initial stop then repeated three times). The automatic engine switch-off is then available again after the **ECO** symbol appears in the multifunction display.

- i AMG vehicles:** times which the engine can be automatically switched off.
- i** You can still activate the HOLD function when the vehicle is stationary, even if the engine has been switched off automatically. It is then not necessary to continue applying the brakes during the automatic stop phase. When you depress the accelerator pedal, the engine starts automatically and the braking effect of the HOLD function is deactivated. Depress the

accelerator pedal carefully, as the engine must be started first.

Vehicles with manual transmission



The ECO start/stop function switches off the engine automatically at low speeds.

- ▶ Brake the vehicle until it comes to a standstill.
- ▶ Engage neutral **N** (▶ page 144) (follow gearshift instruction ① to engage neutral **N**, if necessary).
- ▶ Release the clutch pedal. The engine is switched off automatically.

Vehicles with automatic transmission

If the vehicle is braked to a standstill in **D** or **N**, the ECO start/stop function switches off the engine automatically.

- i** If you shift the transmission from **R** to **D**, the ECO start/stop function is available again once the **ECO** symbol reappears in the multifunction display.

Automatic engine start

Method of operation

The engine starts automatically if:

- you switch off the ECO start/stop function by pressing the ECO button.
- you engage reverse gear **R**.
- you switch to drive program **S** or **M** (AMG vehicles).
- you unfasten your seat belt or open the driver's door.

- the vehicle starts to roll.
- the brake system requires this.
- the temperature in the vehicle interior deviates from the set range.
- the system detects moisture on the windshield when the air-conditioning system is switched on.
- the charge level of the battery is too low.

Vehicles with manual transmission

- ❗ Only engage gear when the clutch pedal is depressed.

The engine starts automatically if:

- you depress the clutch pedal.
- you depress the accelerator pedal.

Vehicles with automatic transmission

The engine starts automatically if:

- in transmission position **D** or **N** the brake pedal is released and the HOLD function is not active.
- you depress the accelerator pedal.
- you move the transmission out of position **P**.

- ❗ Shifting the transmission to position **P** does not start the engine.

Problems with the engine	
Problem	Possible causes/consequences and ► Solutions
The engine does not start.	► Try to start the engine again.
The engine does not start. The starter motor can be heard.	<ul style="list-style-type: none"> • There is a malfunction in the engine electronics. • There is a malfunction in the fuel supply. ► Turn the SmartKey back to position 0 in the ignition lock before attempting to start the engine again. or ► Press the Start/Stop button repeatedly until all indicator lamps in the instrument cluster go out. ► Try to start the engine again (> page 137). Avoid excessively long and frequent attempts to start the engine, as this will drain the battery. If the engine does not start after several attempts: ► Consult a qualified specialist workshop.
The engine does not start. You cannot hear the starter motor.	The on-board voltage is too low because the battery is too weak or discharged. ► Jump-start the vehicle (> page 299). If the engine does not start despite attempts to jump-start it: ► Consult a qualified specialist workshop.
	The starter motor was exposed to a thermal load that was too high. ► Allow the starter motor to cool down for approximately two minutes. ► Try to start the engine again. If the engine still does not start: ► Consult a qualified specialist workshop.
The engine is not running smoothly and is misfiring.	There is a malfunction in the engine electronics or in a mechanical component of the engine management system. ► Only depress the accelerator pedal slightly. Otherwise, non-combusted fuel may get into the catalytic converter and damage it. ► Have the cause rectified immediately at a qualified specialist workshop.

Problem	Possible causes/consequences and ► Solutions
<p>The coolant temperature display is showing more than 248 °F (120 °C). The coolant warning lamp may also be lit and a warning tone may sound.</p>	<p>The coolant level is too low. The coolant is too hot and the engine is no longer being cooled sufficiently.</p> <ul style="list-style-type: none"> ► Stop as soon as possible and allow the engine and the coolant to cool down. ► Check the coolant level (► page 279). Observe the warning notes as you do so and add coolant if necessary. <p>If the coolant level is correct, the engine radiator fan may be faulty. The coolant is too hot and the engine is no longer being cooled sufficiently.</p> <ul style="list-style-type: none"> ► At coolant temperatures below 248 °F (120 °C), drive to the next qualified specialist workshop. ► Avoid heavy loads on the engine as you do so, e.g. driving in mountainous terrain and stop-and-go traffic.

Manual transmission

Gear lever

! When shifting between **5th** and **6th** gear, you should always push the gear lever all the way to the right. You could otherwise shift unintentionally into **3rd** or **4th** gear and damage the transmission.

If you shift down at too high a speed (transmission braking), this can cause the engine to overrev, leading to engine damage.

Never hold the vehicle stopped on a hill by using the clutch pedal. There is otherwise a risk of damaging the clutch.

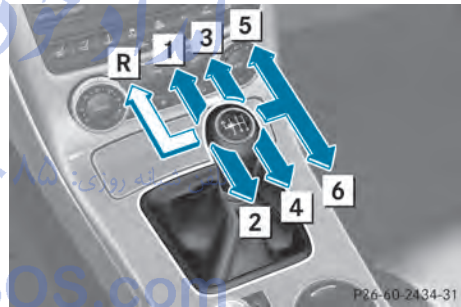

Gear lever

- R** Reverse gear
- 1** bis **6** Forward gears

Neutral N with ECO start/stop function activated

The engine is switched off, if:

- the vehicle speed is below a certain threshold in neutral **N** and
- you do not depress the clutch pedal.

Further information on the ECO start/stop function (► page 139).

Engaging reverse gear

- ❗ Only shift into reverse gear **R** when the vehicle is stationary. Otherwise, you could damage the transmission.
- ▶ Stop the vehicle.
- ▶ Depress the clutch pedal fully.
- ▶ shift to neutral **N**.
- ▶ Move the gear lever firmly to the left beyond the point of resistance and then forwards.

Shift recommendation

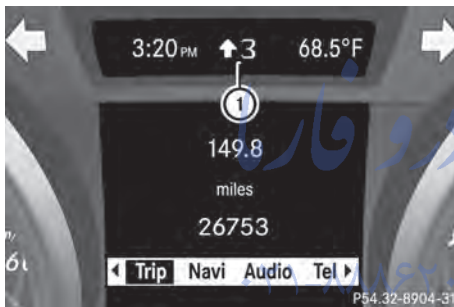

- ▶ Shift gear according to gearshift recommendation ① when shown in the multifunction display of the instrument cluster.

The gearshift recommendations assist you in adopting an economical driving style. The recommended gear is shown in the multifunction display.

Automatic transmission

Important safety notes

⚠ WARNING

If the engine speed is above the idling speed and you engage transmission position **D** or **R**, the vehicle could pull away suddenly. There is a risk of an accident.

When engaging transmission position **D** or **R**, always firmly depress the brake pedal and do not simultaneously accelerate.

⚠ WARNING

The automatic transmission switches to neutral position **N** when you switch off the engine. The vehicle may roll away. There is a risk of an accident.

After switching off the engine, always switch to parking position **P**. Prevent the parked vehicle from rolling away by applying the parking brake.

Selector lever

Overview of transmission positions



Selector lever

- P** Park position with selector lever lock
- R** Reverse gear
- N** Neutral
- D** Drive

Transmission position and drive program display

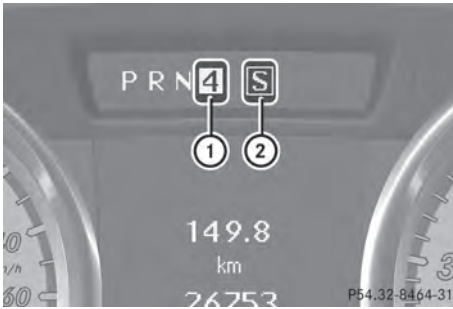

- ① Transmission position display
- ② Drive program display

The current position of the selector lever is shown by the indicators next to the selector lever.

The indicators light up when the SmartKey is inserted into the ignition lock. The indicators go out when the SmartKey is removed from the ignition lock.

Transmission positions

P Park position

Do not shift the transmission into position **P** (▷ page 145) unless the vehicle is stationary. The parking lock should not be used as a brake when parking. Always apply the electronic parking brake in addition to the parking lock in order to secure the vehicle.

The key can only be removed if the transmission is in position **P**. If the SmartKey is removed from the ignition lock, the selector lever is locked.

If the vehicle electronics are malfunctioning, the selector lever may be locked in position **P**. To release a locked selector lever, see "Manual override of parking lock" (▷ page 152).

R Reverse gear

Only shift the transmission to **R** when the vehicle is stationary.

N**Neutral**

Do not shift the transmission to **N** while driving. Otherwise, the automatic transmission could be damaged.

No power is transmitted from the engine to the drive wheels.

Releasing the brakes will allow you to move the vehicle freely, e.g. to push it or tow it.

If ESP® is deactivated or faulty: only shift the transmission to position **N** if the vehicle is in danger of skidding, e.g. on icy roads.

! Rolling in neutral **N** can damage the drive train.

D**Drive**

The automatic transmission changes gear automatically. All forward gears are available.

Changing gear

The automatic transmission shifts to the individual gears automatically when it is in transmission position **D**. This automatic gearshifting behavior is determined by:

- a shift range restriction, if selected
- the selected drive program (▷ page 147)
- the position of the accelerator pedal
- the road speed

Driving tips**Accelerator pedal position**

Your style of driving influences how the automatic transmission shifts gear:

- little throttle: early upshifts
- more throttle: late upshifts

Double-clutch function

When shifting down, the double-clutch function is active regardless of the currently selected drive program. The double-clutch function reduces load change reactions and is conducive to a sporty driving style. The sound generated by the double-clutch function depends on the drive program selected.

Kickdown

Use kickdown for maximum acceleration.

- ▶ Depress the accelerator pedal beyond the pressure point.
The transmission shifts to a lower gear depending on the engine speed.
- ▶ Ease off the accelerator pedal once the desired speed is reached.
The automatic transmission shifts back up.

Program selector button**General notes**

Example: program selector button

- ▶ Press program selector button ① repeatedly until the letter for the desired gearshift program appears in the multifunction display.

The program selector button allows you to choose between different driving characteristics.

In AMG vehicles, drive program **E** is called drive program **C**.

E Economy	Comfortable, economical driving
C Controlled Efficiency	
S Sport	Sporty driving style
M Manual	Manual gear shifting

Only change from automatic drive program **E** or **S** to manual drive program **M** when the vehicle is stationary.

i When the engine is started, the automatic transmission always switches to automatic drive program **E** (drive program **C** in AMG vehicles).

i **AMG vehicles:** when in drive program **C** and with a small load demand, the engine will automatically only operate with four cylinders. This is the case in city traffic or on a country road, for example. This reduces fuel consumption. Cylinder shut-off is inactive in drive programs **S** and **M**, so that the engine will operate with all eight cylinders.

i For further information on the automatic drive program, see (▷ page 148).

Steering wheel paddle shifters



- ① Left-hand steering wheel paddle shifter
- ② Right-hand steering wheel paddle shifter

In the automatic drive program, you can restrict or derestrict the shift range by using

the steering wheel paddle shifters (▷ page 149).

In the manual drive program, you can change gear using the steering wheel paddle shifters or the selector lever (▷ page 150).

- i** The full range of functions for the steering wheel paddle shifters is available only once operating temperature has been reached.
- i** You can only change gear with the steering wheel paddle shifters when the transmission is in position **D**.

Automatic drive program

Drive program **E** (drive program **C** on AMG vehicles) is characterized by the following:

- comfort-oriented engine and transmission settings
- optimal fuel consumption resulting from the automatic transmission shifting up sooner
- the vehicle pulling away more gently in forward and reverse gears, unless the accelerator pedal is depressed fully
- increased sensitivity. This improves driving stability on slippery road surfaces, for example
- the automatic transmission shifting up sooner. This results in the vehicle being driven at lower engine speeds and the wheels being less likely to spin

Drive program **S** is characterized by the following:

- sporty engine and transmission settings
- the vehicle pulling away in first gear
- the automatic transmission shifting up later
- the fuel consumption possibly being higher as a result of the later automatic transmission shift points

Shift ranges

Introduction

When the automatic transmission is in position **D**, it is possible to restrict or derestrict the shift range.

The set shift range appears in the multifunction display. The automatic transmission shifts only as far as the selected gear.

Driving situations

3	You can use the engine's braking effect.
2	The braking effect of the engine can be utilized on downhill gradients or when driving: <ul style="list-style-type: none"> • on steep mountain roads • in mountainous terrain • in arduous conditions
1	The braking effect of the engine can be utilized on extremely steep downhill gradients and long downhill stretches.

Restricting the shift range



- ▶ Press the selector lever to the left towards **D-**.

or

- ▶ Pull the left-hand steering wheel paddle shifter.

The automatic transmission shifts down one gear and restricts the shift range to the relevant gear.

- i** If the engine exceeds the maximum engine speed when shifting down, the automatic transmission protects against engine damage by not shifting down.
- i** If the maximum engine speed for the shift range is reached and you continue to accelerate, the automatic transmission shifts up, even if the shift range is restricted. This is to prevent the engine from overrevving.

Derestricting the shift range

- ▶ Briefly press the selector lever to the right towards **D+**.

or

- ▶ Pull the right-hand steering wheel paddle shifter.

The shift range is derestricted.

Clearing the shift range restriction

- ▶ Press and hold the selector lever towards **D+** until **D** is shown once more in the multifunction display.

or

- ▶ Pull and hold the right-hand steering wheel paddle shifter until **D** is shown again in the multifunction display.

The automatic transmission shifts from the current shift range directly to **D**.

P27.60-3568-31

Selecting the ideal shift range

- ▶ Press the selector lever to the left towards **D-** and hold it in position.

or

- ▶ Pull the left-hand steering wheel paddle shifter and hold it in position. The automatic transmission shifts to the gear which allows optimum acceleration and deceleration. To do this, the automatic transmission shifts down one or more gears.

Manual drive program

Switching on the manual drive program

Manual drive program **M** is different from drive program **S** with regard to spontaneity, responsiveness and smoothness of gear changes.

Manual drive program **M** can be selected using the program selector button. You can change gear using the steering wheel paddle shifters or the selector lever in manual drive program **M** if the transmission is in position **D**. The selected gear appears in the multifunction display.

- ▶ Press the program selector button (▷ page 147) repeatedly until **M** appears in the multifunction display.

Upshifting

- ▶ Briefly press the selector lever to the right towards **D+**.

or

- ▶ Pull the right-hand steering wheel paddle shifter (▷ page 148). The automatic transmission shifts up to the next gear.

AMG vehicles

- ❗ In manual drive program **M**, the automatic transmission does not shift up automatically even when the engine

limiting speed for the current gear is reached. When the engine limiting speed is reached, the fuel supply is cut to prevent the engine from overrevving. Always make sure that the engine speed does not reach the red area of the tachometer. There is otherwise a risk of engine damage.



- ① Gear indicator
- ② Upshift indicator

- ▶ If the color in the speedometer multifunction display changes to red and the **UP** display message is shown, shift up a gear.

Before the engine speed reaches the red area, an upshift indicator will be shown in the AMG menu of the multifunction display.

Downshifting

- ▶ Briefly press the selector lever to the left towards **D-**.

or

- ▶ Pull the left-hand steering wheel paddle shifter (▷ page 148). The automatic transmission shifts down to the next gear.

i If you brake the vehicle or stop without shifting down, the automatic transmission will shift down to a gear that will allow the vehicle to accelerate or pull away again.

i For maximum acceleration, push the selector lever to the left or pull and hold the left-hand steering wheel paddle shifter until

the transmission shifts to the optimal gear for the current speed.

Kickdown

You can also use kickdown for maximum acceleration in manual drive program **M**.

- ▶ Depress the accelerator pedal beyond the pressure point.

The transmission shifts to a lower gear depending on the engine speed.

- i** **AMG vehicles:** it is not possible to use kickdown in manual drive program **M**.

Switching off the manual drive program

- ▶ Press the program selector button (▷ page 147) repeatedly until **E** (**C** in AMG vehicles) or **S** appears in the multifunction display.

امداد خودرو فارما

تلفن شبانه روزی: ۰۲۱-۸۸۸۶۲۰۸۵

FarmaSOS.com

Problems with the transmission

Problem	Possible causes/consequences and ► Solutions
The transmission has problems shifting gear.	The transmission is losing oil. ► Have the transmission checked at a qualified specialist workshop immediately.
The acceleration ability is deteriorating. The transmission no longer changes gear.	The transmission is in emergency mode. It is only possible to shift into second gear and reverse gear. ► Stop the vehicle. ► Shift the transmission to position P . ► Switch off the engine. ► Wait at least ten seconds before restarting the engine. ► Shift the transmission to position D or R . If D is selected, the transmission shifts into second gear; if R is selected, the transmission shifts into reverse gear. ► Have the transmission checked at a qualified specialist workshop, e.g. an authorized Mercedes-Benz Center, immediately.

Releasing the parking lock manually

- ! Do not use any sharp-edged objects to remove the selector lever gaiter from the center console. This could damage the selector lever gaiter.

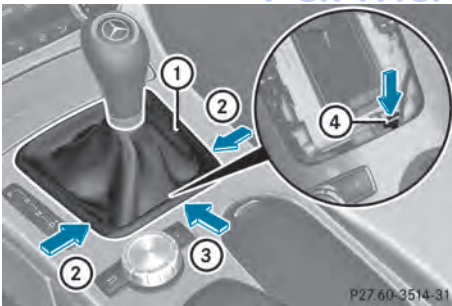

- Apply the electric parking brake.
- Press the frame of selector level gaiter ① together somewhat on the side edge at the back and hold with one hand ②.
- With the other hand, pry off the frame of selector level gaiter ① with a flat, blunt object (e.g. a screwdriver wrapped in cloth)

at rear edge ③, pulling it up and out at the same time. تلفن شبكه

- Press release button ④ down and simultaneously move the selector lever out of position **P**.
The selector lever can now be moved freely until it is returned to position **P**.

In the event of an electrical malfunction, it is possible to release the selector lever lock manually to move it out of position **P**. This is the case, for example, if you wish to tow the vehicle away.

Refueling

Important safety notes

⚠ WARNING

Gasoline is highly flammable and poisonous. It burns violently and can cause serious personal injury.
Never allow sparks, flames or smoking materials near gasoline.

Turn off the engine before refueling.
 Whenever you are around gasoline, avoid inhaling fumes and any skin or clothing contact.
 Direct skin contact with fuels and the inhalation of fuel vapors are damaging to your health.

⚠ WARNING

Overfilling of the fuel tank may create pressure in the system which could cause a gas discharge. This could cause the gasoline to spray back out when removing the fuel pump nozzle, which could cause personal injury.

- ❗ Do not use diesel to refuel vehicles with a gasoline engine. Even small amounts of the wrong fuel result in damage to the fuel system and engine.
- ❗ Do not switch on the ignition if you accidentally refuel with the wrong fuel. Otherwise, the fuel will enter the fuel lines. Notify a qualified specialist workshop and have the fuel tank and fuel lines drained completely.
- ❗ Overfilling the fuel tank could damage the fuel system.
- ❗ Take care not to spill any fuel on painted surfaces. You could otherwise damage the paintwork.
- ❗ Use a filter when refueling from a fuel can. Otherwise, the fuel lines and/or injection system could be blocked by particles from the fuel can.

Further information on fuel and on fuel grades can be found in the "Fuel" section (> page 348).

Refueling

Opening/closing the fuel filler flap

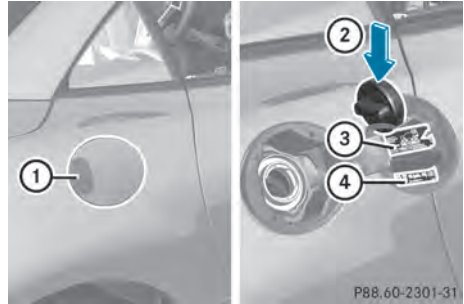

- ① Fuel filler flap
- ② To insert the fuel filler cap
- ③ Tire pressure table
- ④ Fuel type to be used

The fuel filler flap is unlocked or locked automatically when you open or close the vehicle with the SmartKey or with KEYLESS-GO.



The position of the fuel filler cap is displayed  in the instrument cluster. The arrow next to the filling pump indicates the side of the vehicle.

Opening

- ▶ Switch off the engine.
- ▶ Remove the SmartKey from the ignition lock.
- ▶ KEYLESS-GO: open the driver's door. This corresponds to SmartKey position 0, "key removed". The driver's door can be closed again.
- ▶ Press the fuel filler flap in marked area ①. Fuel filler flap ① swings up.
- ▶ Turn the fuel filler flap counter-clockwise and remove it.
- ▶ Insert the fuel filler cap into the holder bracket on the inside of filler flap ②.

- ▶ Completely insert the filler neck of the fuel pump nozzle into the tank and refuel.
- ▶ Only fill the tank until the pump nozzle switches off.
- ❶ Do not add any more fuel after the pump stops filling for the first time. Otherwise, fuel could leak out.

Closing

- ▶ Place fuel filler cap on the fuel filler neck and turn clockwise until it engages.
- ▶ Close fuel filler flap ❶.
- ❶ Close the fuel filler flap before locking the vehicle.
- ❶ The  reserve fuel light flashes if you are driving with the fuel filler cap open. A message appears in the multifunction display (▷ page 228).
In addition, the  (▷ page 250) Check Engine warning lamp may light up.

تلفن شبانه روزی: ۰۲۱-۸۸۸۶۲۰۸۵

FarmaSOS.com

Problems with fuel and the fuel tank

Problem	Possible causes/consequences and ► Solutions
Fuel is leaking from the vehicle.	<p>The fuel line or the fuel tank is faulty.</p> <p> WARNING</p> <p>There is a risk of fire or explosion.</p> <ul style="list-style-type: none"> ► Turn the SmartKey to position 0 in the ignition lock and remove it immediately (> page 135). ► Do not restart the engine under any circumstances. ► Consult a qualified specialist workshop.
The fuel filler flap cannot be opened.	<p>The fuel filler flap is not unlocked.</p> <p>or</p> <p>The SmartKey battery is discharged.</p> <ul style="list-style-type: none"> ► Unlock the vehicle (> page 71). <p>or</p> <ul style="list-style-type: none"> ► Unlock the vehicle using the mechanical key (> page 72). <p>The fuel filler flap is unlocked, but the opening mechanism is jammed.</p> <ul style="list-style-type: none"> ► Consult a qualified specialist workshop.

تلفن شبانه روزی: ۰۸۵-۸۸۸۶۲۰۲۱

Parking

Important safety notes

 **WARNING**

If flammable materials such as leaves, grass or twigs are exposed to prolonged contact to parts of the exhaust system that heat up, they could ignite. There is a risk of fire.

Park the vehicle so that no flammable materials come into contact with parts of the vehicle which are hot. Take particular care not to park on dry grassland or harvested grain fields.

 **WARNING**

If you switch off the ignition while driving, safety-relevant functions are only available with limitations, or not at all. This could affect, for example, the power steering and the brake boosting effect. You will require considerably

more effort to steer and brake. There is a risk of an accident.
Do not switch off the ignition while driving.

 **WARNING**

If you leave children unsupervised in the vehicle, they could set it in motion by, for example:

- releasing the parking brake
- shifting the automatic transmission out of the parking position **P**
- starting the engine.

They could also operate the vehicle's equipment. There is a risk of an accident and injury.

When leaving the vehicle, always take the SmartKey with you and lock the vehicle. Never leave children unsupervised in the vehicle.

⚠ WARNING

If you leave children unsupervised in the vehicle, they could set it in motion by, for example:

- releasing the parking brake
- shifting the automatic transmission out of the parking position **P**
- starting the engine.

They could also operate the vehicle's equipment. There is a risk of an accident and injury.

When leaving the vehicle, always take the SmartKey with you and lock the vehicle. Never leave children unsupervised in the vehicle.

! A moving vehicle can lead to damage to the vehicle or damage to the drive train.

To ensure that the vehicle is secured against rolling away unintentionally:

- the electric parking brake must be applied.
- on vehicles with manual transmission, engage first gear or reverse gear.
- on vehicles with automatic transmission, the transmission must be in position **P** and the SmartKey must be removed from the ignition lock.
- on steep uphill or downhill gradients, turn the front wheels towards the curb.

Switching off the engine**Important safety notes****⚠ WARNING**

The automatic transmission switches to neutral position **N** when you switch off the engine. The vehicle may roll away. There is a risk of an accident.

After switching off the engine, always switch to parking position **P**. Prevent the parked vehicle from rolling away by applying the parking brake.

Vehicles with manual transmission

- ▶ Shift to either first gear or reverse gear **R**.
- ▶ Turn the SmartKey to position **0** in the ignition lock and remove it. The immobilizer is activated.
- ▶ Apply the electric parking brake.

Vehicles with automatic transmission

- ▶ Apply the electric parking brake.
- ▶ Shift the transmission to position **P**.

Using the SmartKey

- ▶ Turn the SmartKey to position **0** in the ignition lock and remove it. The immobilizer is activated.

i The key can only be removed if the transmission is in position **P**.

Using KEYLESS-GO

- ▶ Press the Start/Stop button (▷ page 136). The engine stops and all the indicator lamps in the instrument cluster go out.

i When the driver's door is closed, this corresponds to SmartKey position **1**. When the driver's door is open, it corresponds to SmartKey position **0** or "SmartKey removed".

If you try to switch off the engine when the transmission is not in position **P**, a message appears in the multifunction display. A signal sounds.

Electric parking brake**General notes****⚠ WARNING**

If you leave children unsupervised in the vehicle, they could set it in motion by, for example:

- releasing the parking brake
- shifting the automatic transmission out of the parking position **P**
- starting the engine.

They could also operate the vehicle's equipment. There is a risk of an accident and injury.

When leaving the vehicle, always take the SmartKey with you and lock the vehicle. Never leave children unsupervised in the vehicle.

- i** The electric parking brake performs a function test at regular intervals while the engine is switched off. The sounds that can be heard while this is occurring are normal.

Engaging and releasing manually



- ▶ **To engage:** push handle ①.
When the electric parking brake is engaged, the **PARK** (USA only) or **(P)** (Canada only) red indicator lamp lights up in the instrument cluster.

- i** The electric parking brake can also be applied when the SmartKey is removed.

- ▶ **To release:** switch on the ignition.
- ▶ Pull handle ①.
The red **PARK** (USA only) or **(P)** (Canada only) indicator lamp in the instrument cluster goes out.

- i** The electric parking brake can only be released:
 - if the SmartKey is in position **1** in the ignition lock or
 - if the ignition was switched on using the Start/Stop button.

Applying automatically

The electric parking brake is applied automatically:

- if **DISTRONIC PLUS** brings the vehicle to a standstill or
- if the **HOLD** function is keeping the vehicle stationary

In addition, at least one of the following conditions must be fulfilled:

- the engine is switched off.
- the driver's seat belt is not inserted in the belt buckle and the driver's door is open.
- the vehicle is stationary for a lengthy period.

The red **PARK** (USA only) or **(P)** (Canada only) indicator lamp in the instrument cluster lights up.

Releasing automatically

The electric parking brake is released automatically when all of the following conditions are fulfilled:

- the engine is running.
- the transmission is in position **D** or **R**.
- the driver's seat belt is fastened.
- you depress the accelerator pedal.

If the transmission is in position **R**, the trunk lid must be closed.

If your seat belt is not fastened, the following conditions must be fulfilled to automatically release the electric parking brake:

- the driver's door is closed.
- you have shifted out of **P** or you have previously driven faster than 2 mph (3 km/h).

- i** The electric parking brake can only be released automatically on vehicles with automatic transmission.

Emergency braking

The vehicle can also be braked during an emergency by using the electric parking brake.

- ▶ While driving, push handle ① of the electric parking brake.
- ① The vehicle is braked for as long as the handle of the electric parking brake is pressed. The longer the electric parking brake handle is depressed, the greater the braking force.

During braking:

- a warning tone sounds.
- the **Release Parking Brake** message appears
- the red **PARK** (USA only) or **(P)** (Canada only) indicator lamp in the instrument cluster flashes.

When the vehicle has been braked to a standstill, the electric parking brake is engaged.

Parking the vehicle for a long period

If you leave the vehicle parked for longer than four weeks, the battery may be damaged by exhaustive discharging.

- ▶ Connecting a trickle charger.
- ① You can obtain information about trickle chargers from a qualified specialist workshop.

If you leave the vehicle parked for longer than six weeks, the vehicle may suffer damage as a result of lack of use.

- ▶ Visit a qualified specialist workshop and seek advice.

Driving tips

General notes

Important safety notes

WARNING

If you switch off the ignition while driving, safety-relevant functions are only available with limitations, or not at all. This could affect, for example, the power steering and the brake boosting effect. You will require considerably more effort to steer and brake. There is a risk of an accident.

Do not switch off the ignition while driving.

WARNING

Always remember that you must concentrate primarily on driving the vehicle. The driver's concentration must always be directed primarily at road traffic. For your own safety and that of others, we recommend that you stop the vehicle at a safe place and in accordance with the traffic conditions before making or accepting a phone call.

Comply with all legal requirements if you use the telephone while driving. Use the hands-free system and only use the telephone when road, weather and traffic conditions permit. In some jurisdictions, it is forbidden for drivers to use mobile phones while driving.

Only operate the audio system or COMAND (Cockpit Management and Data System) in compliance with all legal requirements and when the road, weather and traffic conditions permit. You may otherwise not be able to observe the traffic conditions, endangering yourself and others.

Remember that your vehicle covers a distance of 44 ft (approximately 14 m) a second when it is traveling at only 30 mph (approximately 50 km/h).

Drive sensibly – save fuel

Observe the following tips to save fuel:

- The tires should always be inflated to the recommended tire pressure.
- Remove unnecessary loads.
- Warm up the engine at low engine speeds.
- Avoid frequent acceleration or braking.
- Observe the service intervals in the Maintenance Booklet or in the service interval display. Have all the maintenance work carried in accordance with Daimler AG regulations.

Fuel consumption also increases when driving in cold weather, in stop-and-go traffic and in mountainous terrain.

Drinking and driving

WARNING

Drinking and driving and/or taking drugs and driving are very dangerous combinations. Even a small amount of alcohol or drugs can affect your reflexes, perceptions and judgment.

The possibility of a serious or even fatal accident are greatly increased when you drink or take drugs and drive.

Do not drink or take drugs and drive or allow anyone to drive who has been drinking or taking drugs.

Exhaust check

WARNING

Combustion engines emit poisonous exhaust gases such as carbon monoxide. Inhaling these exhaust gases leads to poisoning. There is a risk of fatal injury. Therefore never leave the engine running in enclosed spaces without sufficient ventilation.

Certain engine systems are designed to keep the level of poisonous components in exhaust fumes within legal limits.

These systems only work at peak efficiency if they are serviced exactly in accordance with the manufacturer's specifications. All work on the engine must be carried out only by qualified and authorized Mercedes-Benz technicians.

The engine settings must not be changed under any circumstances. Furthermore, all specific service work must be carried out at regular intervals and in accordance with the Mercedes-Benz service requirements. Details can be found in the Maintenance Booklet.

ECO display

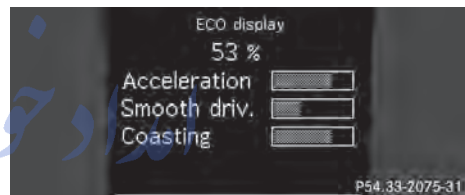

Example: ECO display

The ECO display provides feedback on how economical your driving characteristics are. The ECO display assists you in achieving the most economical driving style for the selected settings and existing conditions. Consumption can be significantly influenced by your driving style.

The ECO display consists of three bars:

- Acceleration
- Constant
- Coasting

The percentage count is the mean value of the three bar values. The three bars and the mean value begin at the value of 50%. A higher percentage count indicates a more economical driving style.

The ECO display does not indicate the actual fuel consumption. A fixed percentage count in the ECO display does not indicate a fixed consumption figure in mpg (l/100 km).

In addition to driving style, the consumption is affected by many other factors, such as:

- Load
- Tire pressure
- Cold start
- Choice of route
- the use of electrical consumers

These factors are not included in the ECO display.

The evaluation of your driving style takes the following three categories into consideration:

Acceleration (evaluation of all acceleration processes)

The bar fills up:	The bar empties:
Moderate acceleration, especially at higher speeds	Sporty acceleration

i An economical driving style involves driving with a moderate engine speed. To achieve a higher value in the categories "acceleration" and "smooth driving":

- observe the gearshift recommendation.
- drive the vehicle in drive program **E** (vehicles with automatic transmission).

i On long journeys at a constant speed, e.g. on the freeway, only the bar for "smooth driving" will change.

i The ECO display summarizes the driving characteristics from the start of the journey to its completion. Therefore, there are dynamic changes in the bars at the start of a journey. During a prolonged driving time, these changes are smaller. For dynamic changes, perform a manual reset.

For further information on the ECO display, see (▷ page 196).

Constant (assessment of driving behavior at all times)

The bar fills up:	The bar empties:
Constant speed and avoidance of unnecessary acceleration and deceleration	Fluctuations in speed

Coasting (assessment of all deceleration processes)

The bar fills up:	The bar empties:
Anticipatory driving, keeping your distance and early release of the accelerator: the vehicle can coast without use of the brakes	Frequent braking

Braking

Important safety notes

WARNING

If you shift down on a slippery road surface in an attempt to increase the engine's braking effect, the drive wheels could lose their grip. There is an increased danger of skidding and accidents.

Do not shift down for additional engine braking on a slippery road surface.

Downhill gradients

! On long, steep gradients, you must reduce the load on the brakes. In order to use engine braking effect, restrict the shift range in good time. This helps you to avoid overheating the brakes and wearing them out excessively.

When making use of the engine braking effect, it is possible that a drive wheel may not turn for some time, e.g. in the case of suddenly changing or slippery road surface

conditions. This could cause damage to the drive train. This type of damage is not covered by the Mercedes-Benz warranty.

On long and steep downhill gradients, especially if the vehicle is laden, you must shift to a lower gear in good time or select shift range **1**, **2** or **3** in vehicles with automatic transmission.

Heavy and light loads

WARNING

If you rest your foot on the brake pedal while driving, the braking system can overheat. This increases the stopping distance and can even cause the braking system to fail. There is a risk of an accident.

Never use the brake pedal as a footrest. Never depress the brake pedal and the accelerator pedal at the same time.

- I** Depressing the brake pedal constantly results in excessive and premature wear to the brake pads.

If the brakes have been subjected to a heavy load, do not stop the vehicle immediately, but drive on for a short while. This allows the airflow to cool the brakes more quickly.

Wet roads

If you have driven for a long time in heavy rain without braking, there may be a delayed reaction from the brakes when braking for the first time.

This may also occur after driving through water deep enough to wet brake components.

You have to depress the brake pedal more firmly. Maintain a greater distance from the vehicle in front.

After driving on a wet road or having the vehicle washed, brake firmly while paying attention to the traffic conditions. This will warm up the brake discs, thereby drying them more quickly and protecting them against corrosion.

Limited braking performance on salt-treated roads

If you drive on salted roads, a layer of salt residue may form on the brake discs and brake pads. This can result in a significantly longer braking distance.

- Brake occasionally to remove any possible salt residue. Make sure that you do not endanger other road users when doing so.
- Carefully depress the brake pedal at the beginning and end of a journey.
- Maintain a greater distance to the vehicle ahead.

High performance and ceramic brake system for AMG vehicles

The high-performance brake system is installed only on the SLK 55 AMG.

The AMG brake systems are designed for heavy loads. This may lead to noise when braking. This will depend on:

- speed
- braking force
- ambient conditions, e.g. temperature and humidity

The wear of individual components of the brake system, such as the brake pads/linings or brake discs, depends on the individual driving style and operating conditions.

For this reason, it is impossible to state a mileage that will be valid under all circumstances. An aggressive driving style will lead to high wear. You can obtain more information on this from a qualified specialist workshop.

New and replaced brake pads and discs only reach their optimum braking effect after several hundred kilometers of driving. Compensate for this by applying greater force to the brake pedal. Keep this in mind, and adapt your driving and braking accordingly during this break-in period.

Excessive heavy braking results in correspondingly high brake wear. Observe

the brake system warning lamp in the instrument cluster and note any brake status messages in the multifunction display. For high-performance driving in particular, it is important to maintain and have the brake system checked regularly.

Servicing the brakes

! If the red brake warning lamp lights up in the instrument cluster and you hear a warning tone while the engine is running, the brake fluid level may be too low. Observe additional warning messages in the multifunction display.

The brake fluid level may be too low due to brake pad wear or leaking brake lines.

Have the brake system checked immediately. This work should be carried out at a qualified specialist workshop.

! As the ESP® system operates automatically, the engine and the ignition must be switched off (SmartKey in position **0** or **1** in the ignition lock) if the electric parking brake is being tested on a brake dynamometer (maximum 10 seconds).

Braking triggered automatically by ESP® may seriously damage the brake system.

All checks and maintenance work on the brake system must be carried out at a qualified specialist workshop. Have this work carried out at an authorized Mercedes-Benz Center.

Have the brake pads replaced and the brake fluid renewed at a qualified specialist workshop, e.g. an authorized Mercedes-Benz Center.

If the brake system has only been subject to moderate loads, you should test the functionality of your brakes at regular intervals. To do so, press firmly on the brake pedal when driving at a high speed. This improves the grip of the brake pads.

A description of Brake Assist (BAS):
(▷ page 60)

Mercedes-Benz recommends that you only have brake pads/linings installed on your vehicle which have been approved for Mercedes-Benz vehicles or which correspond to an equivalent quality standard. Brake pads/linings which have not been approved for Mercedes-Benz vehicles or which are not of an equivalent quality could affect your vehicle's operating safety.

Mercedes-Benz recommends that you only use brake fluid that has been specially approved for your vehicle by Mercedes-Benz, or which corresponds to an equivalent quality standard. Brake fluid which has not been approved for Mercedes-Benz vehicles or which is not of an equivalent quality could affect your vehicle's operating safety.

Driving on wet roads

Hydroplaning

If water has accumulated to a certain depth on the road surface, there is a danger of hydroplaning occurring, even if:

- you drive at low speeds.
- the tires have adequate tread depth.

For this reason, in the event of heavy rain or in conditions in which hydroplaning may occur, you must drive in the following manner:

- lower your speed.
- avoid ruts.
- brake carefully.

Driving on flooded roads

! Do not drive through flooded areas. Check the depth of any water before driving through it. Drive slowly through standing water. Otherwise, water may enter the vehicle interior or the engine compartment. This can damage the electronic components in the engine or the automatic transmission. Water can also be drawn in

by the engine's air suction nozzles and this can cause engine damage.

Winter driving

Important safety notes

WARNING

If you shift down on a slippery road surface in an attempt to increase the engine's braking effect, the drive wheels could lose their grip. There is an increased danger of skidding and accidents.

Do not shift down for additional engine braking on a slippery road surface.

DANGER

If the exhaust pipe is blocked or adequate ventilation is not possible, poisonous gases such as carbon monoxide (CO) may enter the vehicle. This is the case, e.g. if the vehicle becomes trapped in snow. There is a risk of fatal injury.

If you leave the engine or the auxiliary heating running, make sure the exhaust pipe and area around the vehicle are clear of snow. To ensure an adequate supply of fresh air, open a window on the side of the vehicle that is not facing into the wind.

Have your vehicle winterproofed at a qualified specialist workshop at the onset of winter.

Observe the notes in the "Winter operation" section (▷ page 310).

Driving with summer tires

Observe the notes in the "Winter operation" section (▷ page 310).

Slippery road surfaces

WARNING

If you shift down on a slippery road surface in an attempt to increase the engine's braking effect, the drive wheels could lose their grip.

There is an increased danger of skidding and accidents.

Do not shift down for additional engine braking on a slippery road surface.

WARNING

The outside temperature indicator is not designed to serve as an ice-warning device and is therefore unsuitable for that purpose. Indicated temperatures just above the freezing point do not guarantee that the road surface is free of ice. The road may still be icy, especially in wooded areas or on bridges.

If the vehicle threatens to skid or cannot be stopped when moving at low speed:

▶ **Vehicles with manual transmission:** shift to neutral.

▶ **Vehicles with automatic transmission:** shift the transmission to position **N**.

Drive particularly carefully on slippery road surfaces. Avoid sudden acceleration, steering and braking maneuvers. Do not use cruise control. تلفن شبانه ر

 For more information on driving with snow chains, see (▷ page 311).

Driving systems

Cruise control

Important safety notes

WARNING

The cruise control is a convenience system designed to assist the driver during vehicle operation. The driver is and must always remain responsible for the vehicle's speed and for safe brake operation.

Only use the cruise control if the road, traffic, and weather conditions make it advisable to travel at a constant speed.

- The use of the cruise control can be dangerous on winding roads or in heavy

traffic because conditions do not allow safe driving at a constant speed.

- The use of the cruise control can be dangerous on slippery roads. Rapid changes in tire traction can result in wheel spin and loss of control.
- Deactivate the cruise control when driving in fog.

The "Resume" function should only be operated if the driver is fully aware of the previously set speed and wishes to resume this particular preset speed.

WARNING

The cruise control brakes automatically so that the set speed is not exceeded.

General notes

Cruise control maintains a constant road speed for you. It brakes automatically in order to avoid exceeding the set speed. On long and steep downhill gradients, especially if the vehicle is laden, you must select shift range **1, 2 or 3** in good time (▷ page 149). By doing so, you will make use of the braking effect of the engine, which relieves the load on the brake system and prevents the brakes from overheating and wearing too quickly.

Use cruise control only if road and traffic conditions make it appropriate to maintain a steady speed for a prolonged period. You can store any road speed above 20 mph (30 km/h).

Cruise control lever

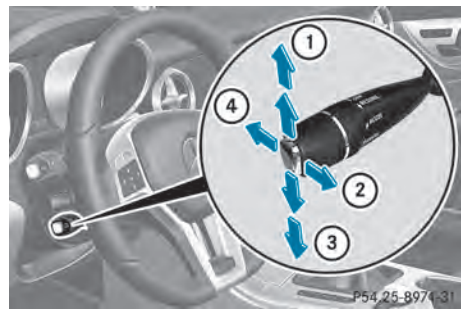

Cruise control lever

- ① To store the current speed or a higher speed
- ② To store the current speed or calling up the last stored speed
- ③ To store the current speed or a lower speed
- ④ To deactivate cruise control

When you activate cruise control, the stored speed is shown in the status indicator of the multifunction display:

- USA only: e.g. **CRUISE 55 Miles**
- Canada only: e.g.  **90 Km/h**

Storing, maintaining and calling up a speed

Storing and maintaining a speed

- ▶ Accelerate the vehicle to the desired speed.
- ▶ Briefly press the cruise control lever up ① or down ④.
- ▶ Remove your foot from the accelerator pedal.
Cruise control is activated. The vehicle automatically maintains the stored speed.

You can store the current speed if you are driving faster than 20 mph (30km/h).

- i** Cruise control may be unable to maintain the stored speed on uphill gradients. The stored speed is resumed when the gradient evens out. Cruise control maintains the

stored speed on downhill gradients by automatically applying the brakes.

- ❶ Vehicles with manual transmission:
 - Always drive at adequate, but not excessive, engine speeds.
 - Change gear in good time.
 - If possible, do not shift down several gears at a time.

Storing or calling up a speed

⚠ WARNING

The set speed stored in memory should only be set again if prevailing road conditions and legal speed limits permit. Possible acceleration or deceleration differences arising from returning to the preset speed could cause an accident and/or serious injury to you and others.

- ▶ Briefly pull the cruise control lever toward you ③.
- ▶ Remove your foot from the accelerator pedal.
The first time cruise control is activated, it stores the current speed or regulates the speed of the vehicle to the previously stored speed.

Setting a speed

⚠ WARNING

Keep in mind that it may take a brief moment until the vehicle has made the necessary adjustments.

Increase or decrease the set vehicle speed to a value that the prevailing road conditions and legal speed limits permit. Otherwise, sudden and unexpected acceleration or deceleration of the vehicle could cause an accident and/or serious injury to you and others.

- ▶ **To adjust the set speed in 1 mph increments (1 km/h increments):** briefly press the cruise control lever up ① to the

pressure point for a higher speed or down ④ for a lower speed.

Every time the cruise control lever is pressed up or down, the last speed stored is increased or reduced.

- ▶ **To adjust the set speed in 5 mph increments (10 km/h increments):**

briefly press the cruise control lever up ① past the pressure point for a higher speed or down ④ for a lower speed.

Every time the cruise control lever is pressed up or down, the last speed stored is increased or reduced.

- ❶ Cruise control is not deactivated if you depress the accelerator pedal. For example, if you accelerate briefly to overtake, cruise control adjusts the vehicle's speed to the last speed stored after you have finished overtaking.

Deactivating cruise control

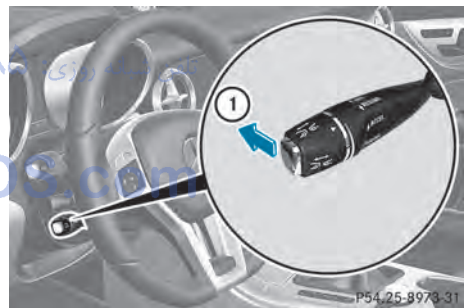

Cruise control lever

There are several ways to deactivate cruise control:

- ▶ Briefly press the cruise control lever forwards ①.

or

- ▶ Brake.

Cruise control is automatically deactivated if:

- you engage the electric parking brake.
- you are driving at less than 20 mph (30 km/h).
- ESP® intervenes or you deactivate ESP®.

ازاد خودرو فارس
FarmaSOS.com

- on vehicles with manual transmission, you shift to a gear that is too high, and as a result the engine speed is too low.
- on vehicles with manual transmission, you shift to a gear that is too high, and as a result the engine speed is too low.
- you shift the transmission to position **N** while driving.

If cruise control is deactivated, you will hear a warning tone. You will see the **Cruise Control Off** message in the multifunction display for approximately five seconds.

- 1 When you switch off the engine, the last speed stored is cleared.

DISTRONIC PLUS

Important safety notes

WARNING

The DISTRONIC PLUS requires familiarity with its operational characteristics. We strongly recommend that you review the following information carefully before operating the system.

WARNING

The DISTRONIC PLUS is a convenience system. Its speed adjustment reduction capability is intended to make cruise control more effective and usable when traffic speeds vary. It is not however, intended to, nor does it, replace the need for extreme care.

The responsibility for the vehicle's speed, distance to the preceding vehicle and, most importantly, brake operation to ensure a safe stopping distance, always remains with the driver.

The DISTRONIC PLUS cannot take street and traffic conditions into account.

Complex driving situations are not always fully recognized by the DISTRONIC PLUS. This could result in wrong or missing distance warnings.

WARNING

DISTRONIC PLUS distance is not a substitute for the active intervention of the driver. It does not detect pedestrians or stationary objects, nor can it detect, recognize or predict the road's course or the movements of vehicles in front. DISTRONIC PLUS can only brake the vehicle using 40% of the vehicle's maximum available brake force.

DISTRONIC PLUS may not detect narrow vehicles driving in front, e.g. motorcycles, or vehicles driving in the lane beyond the lane next to your vehicle, especially if the vehicles are not driving on the middle of their lane.

The driver must always pay careful attention to the road, weather and traffic conditions. The driver must drive, steer and brake in a manner which will allow him to always have control of the vehicle.

Sources of high-frequency radio waves, such as toll stations, speed-measuring radar, etc., can cause DISTRONIC PLUS to fail temporarily.

WARNING

The DISTRONIC PLUS cannot take road and traffic conditions into account. Only use the DISTRONIC PLUS if the road, weather and traffic conditions make it advisable to travel at a constant speed.

WARNING

Use of the DISTRONIC PLUS can be dangerous on slippery roads. Rapid changes in tire traction can result in wheel spin and loss of control.

The DISTRONIC PLUS does not function in adverse sight and distance conditions. Do not use the DISTRONIC PLUS during conditions of fog, heavy rain, snow or sleet.

 **WARNING**

The DISTRONIC PLUS cannot take weather conditions into account. Switch off the DISTRONIC PLUS or do not switch it on if:

- roads are slippery or covered with snow or ice. The wheels could lose traction while braking or accelerating, and the vehicle could skid.
- the DISTRONIC PLUS system sensor covers are dirty or visibility is diminished due to snow, rain or fog, for example. The distance control system functionality could be impaired.

Always pay attention to surrounding traffic conditions even while the DISTRONIC PLUS is switched on. Otherwise, you may not be able to recognize dangerous situations until it is too late. This could cause an accident in which you and/or others could be injured.

 **WARNING**

The "Resume" function should only be operated if the driver is fully aware of the previously set speed and wishes to resume this particular preset speed.

 **WARNING**

Your undivided attention to street and traffic conditions is necessary at all times whether DISTRONIC PLUS is active or not.

The use of DISTRONIC PLUS can be dangerous on winding roads or in heavy traffic because conditions do not allow safe driving at a constant speed.

DISTRONIC PLUS does not react to stationary objects on the road (for example, a vehicle stopped in traffic or an abandoned vehicle). DISTRONIC PLUS likewise does not react to oncoming vehicles.

Deactivate DISTRONIC PLUS:

- when changing to the right lane, if the vehicles in the left lane are driving slower
- when driving into a filter lane or an expressway exit
- in complex driving situations, for example in construction sites on an expressway

In these situations DISTRONIC PLUS will maintain the set speed if it is not deactivated. DISTRONIC PLUS is intended only for maintaining a set speed and a set distance from the objects moving in front of the vehicle.

 **WARNING**

An intermittent warning sounds and the distance warning lamp  in the instrument cluster is illuminated if the DISTRONIC PLUS system calculates that the distance to the vehicle ahead and your vehicle's current speed indicate that the DISTRONIC PLUS will not be capable of slowing the vehicle sufficiently to maintain the preset following distance, which creates a danger of a collision.

Immediately brake the vehicle to increase your distance to the preceding vehicle. The warning sound is intended as a final caution in which you should intercede with your own braking inputs to avoid a potentially dangerous situation. Do not wait for the operation of the warning signal to intercede with your own braking. This will result in potentially dangerous emergency braking which will not always result in an impact being avoided.

Tailgating increases the risk of an accident.

 **WARNING**

DISTRONIC PLUS brakes your vehicle with a maximum deceleration of 13 ft/s² (4 m/s²). This corresponds to approximately 40% of your vehicle's maximum braking force.

To avoid a collision, you must apply the brakes yourself. DISTRONIC PLUS brakes the vehicle

just enough to restore the preset speed or the preset distance to the vehicle in front.

WARNING

If you do not receive visual or acoustic warning signals during a critical traffic situation, DISTRONIC PLUS has either not recognized the collision risk, has been deactivated or is malfunctioning.

Remember, whether or not DISTRONIC PLUS is operating, it is ultimately always the drivers responsibility to apply the brakes in order to control the vehicle and avoid a collision.

General notes

- i** DISTRONIC PLUS is not available on AMG vehicles.

DISTRONIC PLUS regulates the speed and automatically helps you maintain the distance to the vehicle detected in front. DISTRONIC PLUS brakes automatically so that the set speed is not exceeded.

On long and steep downhill gradients, especially if the vehicle is laden, you must select shift range **1**, **2** or **3** in good time (> page 149). By doing so, you will make use of the braking effect of the engine, which relieves the load on the brake system and prevents the brakes from overheating and wearing too quickly.

If a slower-moving vehicle is detected in front, DISTRONIC PLUS brakes your vehicle. It maintains the preset distance to the vehicle in front.

If you want DISTRONIC PLUS to assist you, the radar sensor system must be activated (> page 206) and operational.

If there is no vehicle in front, DISTRONIC PLUS operates in the same way as cruise control in the speed range between 20 mph (Canada: 30 km/h) and 120 mph (Canada: 200 km/h). If a vehicle is driving in front of you, it operates in the speed range between 0 mph (0 km/h) and 120 mph (Canada: 200 km/h).

Do not use DISTRONIC PLUS while driving on roads with steep gradients.

As DISTRONIC PLUS transmits radar waves, it can resemble the radar detectors of the responsible authorities. You can refer to the relevant chapter in the Operator's Manual if questions are asked about this.

- i** USA only: This device has been approved by the FCC as a "Vehicular Radar System". The radar sensor is intended for use in an automotive radar system only. Removing, altering or tampering with the device will void any warranties, and is not permitted by the FCC. Do not tamper with, alter, or use the device in any non-approved way. Any unauthorized modification to this device could void the user's authority to operate the equipment.

- i** Canada only: This device complies with RSS-210 of Industry Canada. Operation is subject to the following two conditions:

1. This device may not cause interference, and
2. this device must accept any interference received, including interference that may cause undesired operation of the device.

Removal, tampering, or altering of the device will void any warranties, and is not permitted. Do not tamper with, alter, or use the device in any non-approved way.

Any unauthorized modification to this device could void the user's authority to operate the equipment.

Cruise control lever

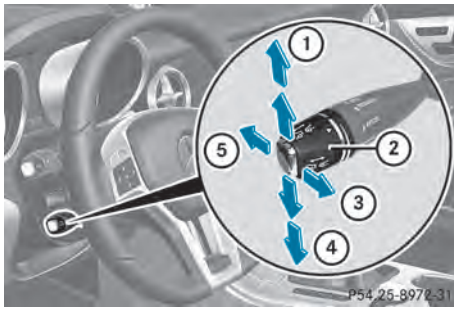

Cruise control lever

- ① To store the current speed or a higher speed
- ② To set the specified minimum distance
- ③ To store the current speed or calling up the last stored speed
- ④ To store the current speed or a lower speed
- ⑤ To deactivate DISTRONIC PLUS

Activating DISTRONIC PLUS; storing, maintaining and calling up a speed

Important safety notes

WARNING

When the DISTRONIC PLUS is switched on, the vehicle can be braked. You should therefore switch off the DISTRONIC PLUS if the vehicle must be towed.

In order to activate DISTRONIC PLUS, the following conditions must be fulfilled:

- the engine must be started. It may take up to two minutes after pulling away before DISTRONIC PLUS is operational.
- your vehicle must not be secured by the electric parking brake.
- ESP® must be activated.
- the transmission must be in position **D**.
- the hood must be closed.
- the driver's door must be closed when you shift from **P** to **D** or your seat belt must be fastened.

- the front-passenger door must be closed.
- the vehicle must not skid.

Activating while driving

- ▶ Briefly pull the cruise control lever toward you ③, up ① or down ④. DISTRONIC PLUS is selected.
- ▶ **To adjust the set speed in 1 mph increments (1 km/h increments):** briefly press the cruise control lever up ① to the pressure point for a higher speed or down ④ for a lower speed. Every time the cruise control lever is pressed up or down, the last speed stored is increased or reduced.

or

- ▶ **To adjust the set speed in 5 mph increments (10 km/h increments):** briefly press the cruise control lever up ① past the pressure point for a higher speed or down ④ for a lower speed. Every time the cruise control lever is pressed up or down, the last speed stored is increased or reduced.

- ▶ Remove your foot from the accelerator pedal.

Your vehicle adapts its speed to that of the vehicle in front, but only up to the desired stored speed.

If the vehicle in front has been detected and is shown in the multifunction display, you can also activate DISTRONIC PLUS when driving at speeds below 20 mph (30km/h). If the vehicle in front is no longer detected and displayed, for example because it has changed lanes, DISTRONIC PLUS is deactivated. You will hear a warning tone if this is the case.

- i** If you do not fully release the accelerator pedal, the **DISTRONIC PLUS Override** message appears in the multifunction display. The set distance to a slower-moving vehicle in front will then not be maintained. You will be driving at the speed you determine by the position of the accelerator pedal.

Activating when driving towards a stationary vehicle

- ▶ Briefly pull the cruise control lever toward you ③, up ① or down ④. DISTRONIC PLUS is selected.
- ▶ **To adjust the set speed in 1 mph increments (1 km/h increments):** briefly press the cruise control lever up ① to the pressure point for a higher speed or down ④ for a lower speed. Every time the cruise control lever is pressed up or down, the last speed stored is increased or reduced.

or

- ▶ **To adjust the set speed in 5 mph increments (10 km/h increments):** briefly press the cruise control lever up ① past the pressure point for a higher speed or down ④ for a lower speed. Every time the cruise control lever is pressed up or down, the last speed stored is increased or reduced.

If the vehicle in front of you is stationary, you can only activate DISTRONIC PLUS once your vehicle is stationary as well.

- ① DISTRONIC PLUS can only be activated at under 20 mph (30km/h) if a vehicle in front has been detected. Therefore, the DISTRONIC PLUS distance display in the instrument cluster should be activated (▷ page 201).
- ① You can use the cruise control lever to set the stored speed and the control on the cruise control lever to set the specified minimum distance (▷ page 172).

Pulling away and driving

WARNING

When you step on the brake pedal, you switch off the DISTRONIC PLUS except when the vehicle is at a standstill. The DISTRONIC PLUS will no longer brake your vehicle. You are always responsible for maintaining a distance from other vehicles, observing road speeds and braking well in advance.

- ▶ **If the vehicle in front pulls away:** remove your foot from the brake pedal.
 - ▶ Briefly pull the cruise control lever toward you ③.
- or
- ▶ Accelerate briefly.

Your vehicle pulls away and adapts its speed to that of the vehicle in front.

If there is no vehicle in front, DISTRONIC PLUS operates in the same way as cruise control.

If DISTRONIC PLUS detects that the vehicle in front has slowed down, it brakes your vehicle. It maintains the preset distance to the vehicle in front.

If DISTRONIC PLUS detects a faster-moving vehicle in front, it increases the driving speed. However, the vehicle is only accelerated up to the speed you have stored.

Changing lanes

WARNING

DISTRONIC PLUS and Active Blind Spot Assist are only aids designed to assist driving.

They do not relieve you of the responsibility of paying attention. The driver remains fully responsible for the vehicle's distance from other vehicles, the vehicle's speed and for braking in good time. Always pay attention to traffic conditions and your surroundings. Otherwise, you may fail to recognize dangers in time, cause an accident and injure yourself and others.

If you wish to change to the passing lane (in countries where traffic drives on the right, the passing lane is the left-hand lane), DISTRONIC PLUS supports you if:

- you are driving faster than 40mph (60 km/h).
- DISTRONIC PLUS is maintaining the distance to a vehicle in front.

- you have switched on the corresponding turn signal.
- DISTRONIC PLUS does not detect a danger of collision.

If these conditions are fulfilled, your vehicle is accelerated. Acceleration will be interrupted if changing lanes takes too long or if the distance between your vehicle and the vehicle in front becomes too small.

Stopping

WARNING

Never get out of the vehicle when DISTRONIC PLUS is activated.

DISTRONIC PLUS must also never be operated, activated or deactivated by a passenger or from outside the vehicle.

DISTRONIC PLUS does not replace the electric parking brake and must not be used for parking.

The DISTRONIC PLUS braking effect is canceled and the vehicle can start moving if:

- DISTRONIC PLUS is deactivated using the cruise control lever.
- you accelerate.
- there is a malfunction in the system or an interruption in the power supply, e.g. battery failure.
- the electrical system in the engine compartment, the battery or the fuses are tampered with.
- the battery is disconnected.

If you wish to leave the vehicle or park it, deactivate DISTRONIC PLUS and secure the vehicle against rolling away.

If DISTRONIC PLUS detects that the vehicle in front is stopping, it brakes your vehicle until it is stationary.

Once your vehicle is stationary, it remains stationary and you do not need to depress the brake. After a time, the electric parking brake secures the vehicle and relieves the service brake.

Depending on the specified minimum distance, your vehicle will come to a standstill at a sufficient distance behind the vehicle in front. The specified minimum distance is set using the control on the cruise control lever.

The electric parking brake automatically secures the vehicle if DISTRONIC PLUS is activated and:

- the driver's door is open and the driver's seat belt is unfastened.
- the engine is switched off, unless it is automatically switched off by the ECO start/stop function.
- the hood is opened.
- a system malfunction occurs.
- the power supply is not sufficient.

If there is a malfunction in the vehicle electronics, a warning message may also appear in the multifunction display.

Brake Immediately

- ▶ Immediately depress the brake pedal firmly until the warning message in the multifunction display goes out. DISTRONIC PLUS is deactivated.

Shift to 'P'

- ▶ Shift the transmission to position **P** to prevent the vehicle from rolling away. DISTRONIC PLUS is deactivated. The warning message in the multifunction display disappears.

The horn will also sound at regular intervals if DISTRONIC PLUS is activated and you:

- switch the engine off, open the driver's door and remove your seat belt
- open the hood

The sounding of the horn alerts you to the fact that the vehicle has been parked while DISTRONIC PLUS is still activated. The sound becomes louder if you attempt to lock the vehicle. The vehicle is not locked until DISTRONIC PLUS is deactivated.

- i** If the engine has been switched off, it cannot be started again until DISTRONIC PLUS has been deactivated.

Storing the current speed or calling up the last stored speed

WARNING

The set speed stored in memory should only be set again if prevailing road conditions and legal speed limits permit. Possible acceleration or deceleration differences arising from returning to the preset speed could cause an accident and/or serious injury to you and others.

- ▶ Briefly pull the cruise control lever toward you ③.
- ▶ Remove your foot from the accelerator pedal. DISTRONIC PLUS is activated. The first time it is activated, the current speed is stored. Otherwise, it sets the vehicle cruise speed to the previously stored value.

Setting a speed

WARNING

Keep in mind that it may take a brief moment until the vehicle has made the necessary adjustments.

Increase or decrease the set vehicle speed to a value that the prevailing road conditions and legal speed limits permit. Otherwise, sudden and unexpected acceleration or deceleration of the vehicle could cause an accident and/or serious injury to you and others.

- ▶ **To adjust the set speed in 1 mph increments (1 km/h increments):** briefly press the cruise control lever up ① to the pressure point for a higher speed or down ④ for a lower speed. Every time the cruise control lever is pressed up or down, the last speed stored is increased or reduced.
- ▶ **To adjust the set speed in 5 mph increments (10 km/h increments):** briefly press the cruise control lever

up ① past the pressure point for a higher speed or down ④ for a lower speed. Every time the cruise control lever is pressed up or down, the last speed stored is increased or reduced.

Setting the specified minimum distance

WARNING

It is up to the driver to exercise discretion to select the appropriate setting given road conditions, traffic, driver's preferred driving style and applicable laws and driving recommendations for safe following distance.

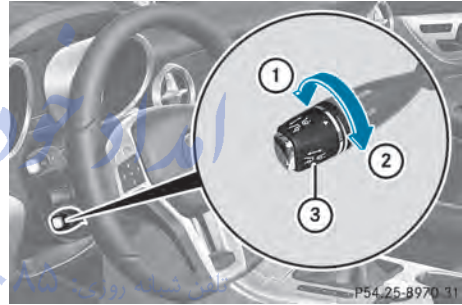

Cruise control lever

- ▶ **To increase:** turn control ③ toward ②. DISTRONIC PLUS then maintains a greater distance between your vehicle and the vehicle in front.
- ▶ **To decrease:** turn control ③ toward ①. DISTRONIC PLUS then maintains a shorter distance between your vehicle and the vehicle in front.

You can set the specified minimum distance for DISTRONIC PLUS by varying the time span between one and two seconds. With this function, you can set the minimum distance that DISTRONIC PLUS keeps to the vehicle in front, dependent on vehicle speed. You can see this distance in the multifunction display (> page 173).

Make sure that you maintain a sufficiently safe distance from the vehicle in front. Adjust the distance to the vehicle in front if necessary.

DISTRONIC PLUS displays in the instrument cluster

Displays in the speedometer



When DISTRONIC PLUS is activated, one or two segments ② in the set speed range light up.

If DISTRONIC PLUS detects a vehicle in front, segments ② between speed of the vehicle in front ① and stored speed ③ light up.

i For design reasons, the speed displayed in the speedometer may differ slightly from the speed set for DISTRONIC PLUS.

Display when DISTRONIC PLUS is deactivated

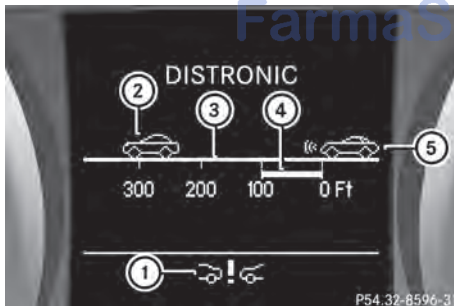

- ① Symbol for activated PRE-SAFE® Brake
- ② Vehicle in front, if detected
- ③ Distance indicator, current distance to the vehicle in front
- ④ Specified minimum distance to the vehicle in front; adjustable
- ⑤ Own vehicle

- ▶ Select the **Distance Display** function using the on-board computer (▷ page 201).

In the Assistance menu of the on-board computer, you can also activate or deactivate PRE-SAFE® Brake (▷ page 202).

Display when DISTRONIC PLUS is activated

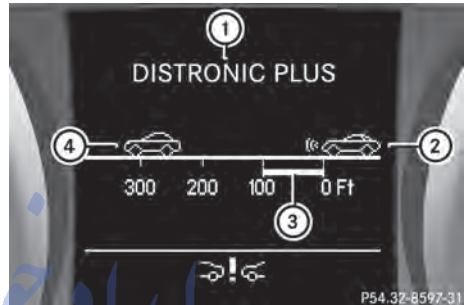

- ① DISTRONIC PLUS activated
- ② Own vehicle
- ③ Specified minimum distance to the vehicle in front; adjustable
- ④ Vehicle in front, if detected

- ▶ Select the **Distance Display** function using the on-board computer (▷ page 201).

You will initially see the stored speed for about five seconds when you activate DISTRONIC PLUS.

Deactivating DISTRONIC PLUS

⚠ WARNING

DISTRONIC PLUS is deactivated and releases the brakes if the vehicle is slowed down to a speed below 20 mph (30km/h) by the system, provided that DISTRONIC PLUS does not detect a vehicle directly in front. At this point, the driver must apply the brakes in order to slow down further and bring the vehicle to a standstill.

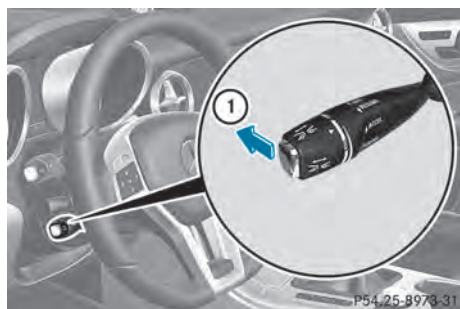

Cruise control lever

There are several ways to deactivate DISTRONIC PLUS:

- ▶ Briefly press the cruise control lever forwards ①.

or

- ▶ Brake, unless the vehicle is stationary.

When you deactivate DISTRONIC PLUS, you will see the **DISTRONIC PLUS Off** message in the multifunction display for approximately five seconds.

- ① The last speed stored remains stored until you switch off the engine.

- ① DISTRONIC PLUS is not deactivated if you depress the accelerator pedal. If you accelerate to overtake, DISTRONIC PLUS adjusts the vehicle's speed to the last speed stored after you have finished overtaking.

DISTRONIC PLUS is automatically deactivated if:

- you engage the electric parking brake or if the vehicle is automatically secured with the electric parking brake.
- you are driving slower than 15 mph (25 km/h) and there is no vehicle in front, or if the vehicle in front is no longer detected.
- ESP® intervenes or you deactivate ESP®.
- the transmission is in the **P**, **R** or **N** position.
- you switch off the radar sensor system (▶ page 206).

- you pull the cruise control lever towards you in order to pull away and the front-passenger door is open.
- the vehicle has skidded.

If DISTRONIC PLUS is deactivated, you will hear a warning tone. You will see the **DISTRONIC PLUS Off** message in the multifunction display for approximately five seconds.

Tips for driving with DISTRONIC PLUS

Important safety notes

WARNING

The DISTRONIC PLUS works to maintain the speed selected by the driver unless a moving obstacle proceeding directly ahead of it in the same travel direction is detected (e.g. following another vehicle ahead of you at your set distance).

This means that:

- Your vehicle can pass another vehicle after you have changed lanes.
- While in a sharp turn or if the preceding vehicle is in a sharp turn, the DISTRONIC PLUS could lose sight of the preceding vehicle. Your vehicle could then accelerate to the previously selected speed.

The DISTRONIC PLUS regulates only the distance between your vehicle and those directly ahead of it. It may not register stationary objects in the road, e.g.:

- a stopped vehicle in a traffic jam
- a disabled vehicle
- an oncoming vehicle

The driver must always be alert, observe all traffic and intercede as required by means of steering or braking the vehicle.

WARNING

The DISTRONIC PLUS should not be used in snowy or icy road conditions.

The following contains descriptions of certain road and traffic conditions in which you must

be particularly attentive. In such situations, brake if necessary. DISTRONIC PLUS is then deactivated.

Cornering, going into and coming out of a bend

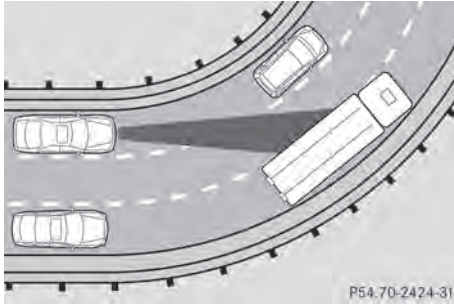

The ability of DISTRONIC PLUS to detect vehicles when cornering is limited. Your vehicle may brake unexpectedly or late.

Vehicles traveling on a different line

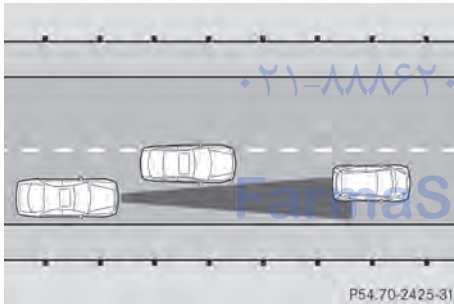

DISTRONIC PLUS may not detect vehicles traveling on a different line. The distance to the vehicle in front will be too short.

Other vehicles changing lanes

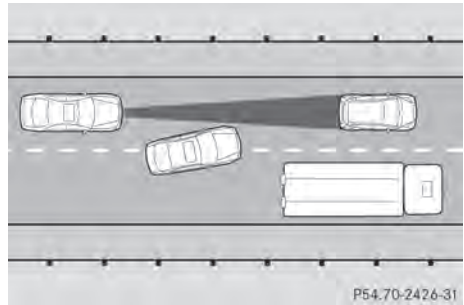

DISTRONIC PLUS has not detected the vehicle cutting in yet. The distance to this vehicle will be too short.

Narrow vehicles

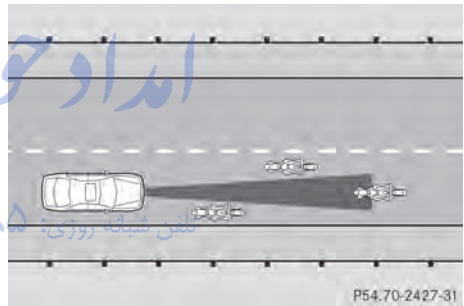

DISTRONIC PLUS has not yet detected the vehicle in front on the edge of the road, because of its narrow width. The distance to the vehicle in front will be too short.

Obstructions and stationary vehicles

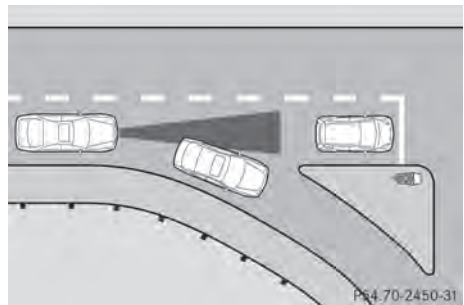

DISTRONIC PLUS does not brake for obstacles or stationary vehicles. If, for

example, the detected vehicle turns a corner and reveals an obstacle or stationary vehicle, DISTRONIC PLUS will not brake for these.

Crossing vehicles

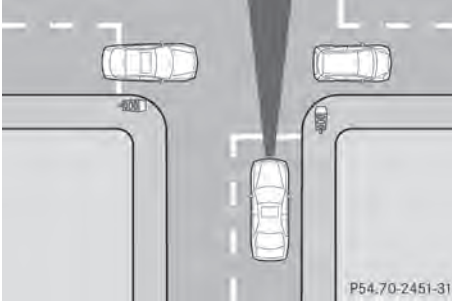

DISTRONIC PLUS may mistakenly detect vehicles that are crossing your lane. Activating DISTRONIC PLUS at traffic lights with crossing traffic, for example, could cause your vehicle to pull away unintentionally.

Dynamic handling package

General notes



The adjustable damping system adapts to the current driving conditions. The adjustment depends on whether you have selected sport or comfort mode. Your selection remains stored even if you remove the SmartKey from the ignition lock.

Sports tuning

The firmer setting of the suspension tuning in sports mode ensures even better contact with the road. Select this mode if you want more direct contact with the road when employing a sporty driving style, e.g. on winding country roads.

► **If indicator lamp ① is not lit:** press button ②.

Indicator lamp ① lights up. You have selected the suspension for a sporty driving style.

Comfort tuning

Select comfort mode if you prefer a more comfortable driving style.

► **If indicator lamp ① is lit:** press button ②.

Indicator lamp ① goes out. You have selected the suspension for a comfortable driving style.

HOLD function

Important safety notes

WARNING

The vehicle's brakes are applied when the HOLD function is activated. For this reason, deactivate the HOLD function if the vehicle is to be set in motion by other means (e.g. in a car wash or by towing).

WARNING

Never get out of the vehicle when the HOLD function is activated.

The HOLD function must never be operated or deactivated by a passenger or from outside the vehicle.

The HOLD function does not replace the electric parking brake and must not be used for parking.

The braking effect of the HOLD function is canceled and the vehicle could roll away if:

- the HOLD function is deactivated by depressing the accelerator pedal or the brake pedal.
- there is a malfunction in the system or an interruption in the power supply, e.g. battery failure.
- the electrical system in the engine compartment, the battery or the fuses are tampered with.
- the battery is disconnected.

If you leave the vehicle or park it, deactivate the HOLD function and secure the vehicle against rolling away.

General notes

The HOLD function can assist the driver in the following situations:

- when pulling away, especially on steep slopes
- when maneuvering on steep slopes
- when waiting in traffic

The vehicle is kept stationary without the driver having to depress the brake pedal.

The braking effect is canceled and the HOLD function deactivated when you depress the accelerator pedal to pull away.

Activation conditions

You can activate the HOLD function if:

- the vehicle is stationary.
- the engine is running or if it has been automatically switched off by the ECO start/stop function.
- the driver's door is closed or your seat belt is fastened.
- the hood is closed.
- the electric parking brake is released.
- the selector lever is in position **D**, **R** or **N** on vehicles with automatic transmission.
- DISTRONIC PLUS is deactivated.

Activating the HOLD function



- ▶ Make sure that the activation conditions are met.
- ▶ Depress the brake pedal.
- ▶ Quickly depress the brake pedal further until **1 HOLD** appears in the multifunction display.

The HOLD function is activated. You can release the brake pedal.

- i** If depressing the brake pedal the first time does not activate the HOLD function, wait briefly and then try again.

Deactivating the HOLD function

The HOLD function is deactivated automatically if:

- you accelerate. On vehicles with automatic transmission: only when the transmission is in position **D** or **R**.
- you shift the transmission to position **P** on vehicles with automatic transmission.
- you apply the brakes again with a certain amount of pressure until **HOLD** disappears from the multifunction display.
- you secure the vehicle using the electric parking brake.
- you activate DISTRONIC PLUS.
- i** After a time, the electric parking brake secures the vehicle and relieves the service brake.

The electric parking brake automatically secures the vehicle if the HOLD function is activated and:

- the driver's door is open and the driver's seat belt is unfastened.
- the engine is switched off, unless it is automatically switched off by the ECO start/stop function.
- the hood is opened.
- a system malfunction occurs.
- the power supply is not sufficient.

If there is a malfunction in the vehicle electronics, a warning message may also appear in the multifunction display.

Brake Immediately

- ▶ Immediately depress the brake pedal firmly until the warning message in the multifunction display goes out. The HOLD function is deactivated.

In vehicles with automatic transmission: Shift to 'P'.

- ▶ Shift the transmission to position **P** to prevent the vehicle from rolling away. The HOLD function is deactivated. The warning message in the multifunction display disappears.

A horn will also sound at regular intervals if the HOLD function is activated and you:

- switch the engine off, open the driver's door and remove your seat belt
- open the hood

The sounding of the horn alerts you to the fact that the vehicle has been parked while the HOLD function is still activated. If you attempt to lock the vehicle, the tone becomes louder. The vehicle is not locked until the HOLD function is deactivated.

- ❗ If the engine has been switched off, it can't be started again until the HOLD function has been deactivated.

PARKTRONIC

Important safety notes

⚠ WARNING

The PARKTRONIC is a supplemental system. It is not intended to, nor does it replace, the need for extreme care. The responsibility during parking and other critical maneuvers always remains with the driver.

⚠ WARNING

Make sure no persons or animals are in or near the area in which you are parking/maneuvering. Otherwise, they could be injured.

- ❗ When parking, pay particular attention to objects above or below the sensors, such as flower pots or trailer drawbars.

PARKTRONIC does not detect such objects when they are in the immediate vicinity of the vehicle. You could damage the vehicle or the objects.

The sensors may not detect snow and other objects that absorb ultrasonic waves.

Ultrasonic sources such as an automatic car wash, the compressed-air brakes on a truck or a pneumatic drill could cause PARKTRONIC to malfunction.

PARKTRONIC may not function correctly on uneven terrain.

PARKTRONIC is an electronic parking aid with ultrasonic sensors. It indicates visually and audibly the distance between your vehicle and an object.

PARKTRONIC is activated automatically when you:

- switch on the ignition
- move the selector lever to position **D**, **R** or **N** on vehicles with automatic transmission
- release the electric parking brake

PARKTRONIC is deactivated at speeds above 11 mph (18km/h). It is reactivated at lower speeds.

PARKTRONIC monitors the area around your vehicle using six sensors in the front bumper and four sensors in the rear bumper.

Range of the sensors

General notes

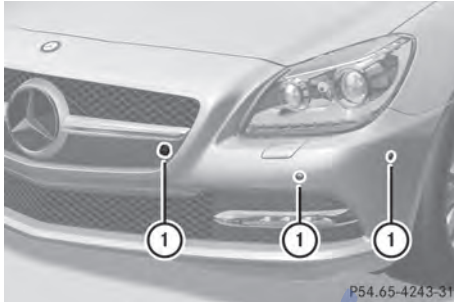

- ① Example: sensors in the front bumper, left-hand side

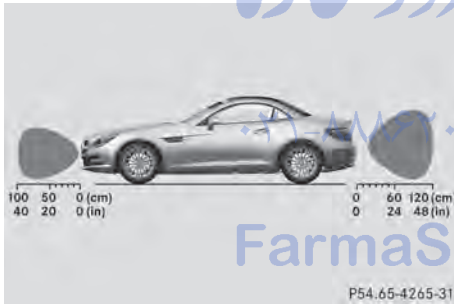

Side view

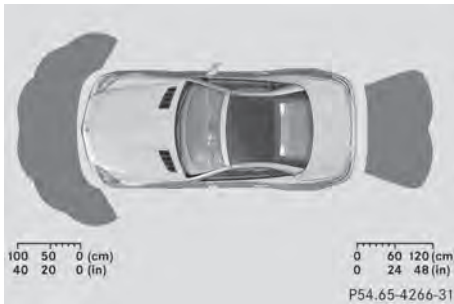

Top view

The sensors must be free from dirt, ice or slush. They can otherwise not function correctly. Clean the sensors regularly, taking

care not to scratch or damage them (> page 285).

Front sensors

Center	Approx. 40 in (approx. 100 cm)
Corners	Approx. 24 in (approx. 60 cm)

Rear sensors

Center	Approx. 48in (approx. 120cm)
Corners	Approx. 32 in (approx. 80 cm)

Minimum distance

Center	Approx. 8in (approx. 20cm)
Corners	Approx. 6 in (approx. 15 cm)

If there is an obstacle within this range, the relevant warning displays light up and a warning tone sounds. If the distance falls below the minimum, the distance may no longer be shown.

Warning displays

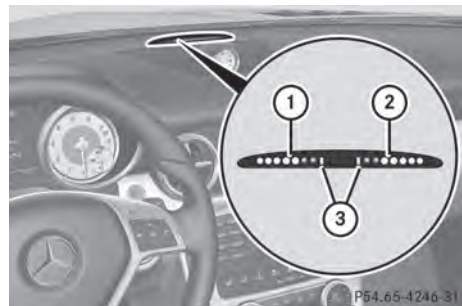

Warning display for the front area

- ① Segments on the left-hand side of the vehicle
- ② Segments on the right-hand side of the vehicle
- ③ Segments showing operational readiness

The warning displays show the distance between the sensors and the obstacle. The warning display for the front area is located on the dashboard above the center air vents. The warning display for the rear area is located between the roll bars.

The warning display for each side of the vehicle is divided into five yellow and two red segments. PARKTRONIC is operational if yellow segments showing operational readiness ③ light up.

Manual transmission:

Gear lever position	Warning display
Forwards gear or Neutral	Front area activated
Reverse gear, or the vehicle is rolling backwards	Rear and front areas activated

Automatic transmission: تلفن شبانه روزی: ۰۲۱-۸۸۸۶۲۰۸۵

Transmission position	Warning display
D	Front area activated
R, N or the vehicle rolls backward	Rear and front areas activated
P	No areas activated

One or more segments light up as the vehicle approaches an obstacle, depending on the vehicle's distance from the obstacle.

From the:

- sixth segment onwards, you will hear an intermittent warning tone for approximately two seconds.
- seventh segment onwards, you will hear a warning tone for approximately two seconds. This indicates that you have now reached the minimum distance.

Deactivating/activating PARKTRONIC

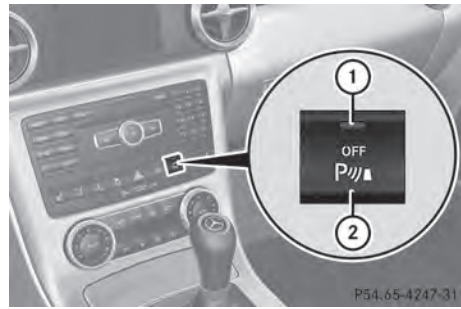

- ① Indicator lamp
- ② To deactivate/activate PARKTRONIC

If indicator lamp ① is on then PARKTRONIC is deactivated. Parking Guidance is also deactivated.

- ① PARKTRONIC is automatically activated when you turn the SmartKey to position 2 in the ignition lock.

Problems with PARKTRONIC

Problem	Possible causes/consequences and ► Solutions
Only the red segments in the PARKTRONIC warning displays are lit. You also hear a warning tone for approximately two seconds. PARKTRONIC is deactivated after approximately 20 seconds, and the indicator lamp in the PARKTRONIC button lights up.	<p>PARKTRONIC has malfunctioned and has switched off.</p> <ul style="list-style-type: none"> ► If problems persist, have PARKTRONIC checked at a qualified specialist workshop.
Only the red segments in the PARKTRONIC warning displays are lit. PARKTRONIC is deactivated after approximately five seconds.	<p>The PARKTRONIC sensors are dirty or there is interference.</p> <ul style="list-style-type: none"> ► Clean the PARKTRONIC sensors (► page 285). ► Switch the ignition back on. <p>The problem may be caused by an external source of radio or ultrasound waves.</p> <ul style="list-style-type: none"> ► See if PARKTRONIC functions in a different location.

Parking Guidance

Important safety notes

WARNING

Parking Guidance is merely an aid and may display parking spaces that are not suitable for parking, for example:

- no-parking areas
- parking spaces with unsuitable surfaces (road surface)
- driveways
- entrances and exits

Parking Guidance detects and measures potential parking spaces while driving past. Changes to the parking space after this point are not taken into account, for example if the vehicle in front of or behind the parking space changes position or objects in the parking space are moved.

Even when using Parking Guidance, you are still responsible for driving carefully. If you rely on Parking Guidance alone, you could cause an accident and injure yourself and others.

Safety always remains your responsibility and you must continue paying careful attention to your immediate surroundings when parking and maneuvering.

WARNING

Objects located above the height range of Parking Guidance will not be detected when the parking space is measured. These objects are not taken into account when the parking procedure is calculated, e.g. overhanging loads, tail sections or loading ramps of goods vehicles. Under some circumstances, Parking Guidance might therefore issue steering instructions too soon. This may lead to a

collision. For this reason, you should avoid using Parking Guidance in such situations.

WARNING

Make sure that no persons or animals are in the maneuvering range. Otherwise, they could be injured.

! Pay particular attention to low objects or objects with flat surfaces, such as trailer drawbars, posts, cross beams and curbs. These types of objects cannot be detected by Parking Guidance and may damage the vehicle.

! If unavoidable, you should drive over obstacles such as curbs slowly and not at a sharp angle. Otherwise, you may damage the wheels or tires.

Parking Guidance is an electronic parking aid with ultrasound. Ultrasound is used to measure the road on both sides of the vehicle. A suitable parking space is indicated by the parking symbol. You receive steering instructions when parking. You may also use PARKTRONIC (▷ page 178).

When PARKTRONIC is deactivated, Parking Guidance is also unavailable.

Use Parking Guidance for parking spaces:

- that are parallel to the direction of travel
- that are on straight roads, not bends
- that are on the same level as the road, i.e. not on the pavement, for example. Parking Guidance may not detect flat curbs

Parking tips:

- on narrow roads, drive past the parking space as close as possible.
- parking spaces that are littered, overgrown or partially occupied by trailer drawbars might be identified incorrectly or not at all.
- snowfall or heavy rain may lead to a parking space being measured inaccurately.
- pay attention to the PARKTRONIC (▷ page 179) warning messages during the parking procedure.

- when transporting a load which protrudes from your vehicle, you must not use Parking Guidance.
- never use Parking Guidance with snow chains or an emergency spare wheel mounted.
- make sure that the tire pressures are always correct. This has a direct effect on the steering instructions.
- the way your vehicle is positioned in the parking space after parking is dependent on various factors. These include the position and shape of the vehicles parked in front and behind it and the conditions of the location. In some cases, Parking Guidance may guide you too far or not far enough into a parking space. In some cases, it may also lead you across or onto the curb. If necessary, cancel the parking procedure with Parking Guidance.

Detecting a parking space



- ① Detected parking space on the left
- ② Parking symbol
- ③ Detected parking space on the right

Parking Guidance is automatically activated when you drive forwards. The system is operational at speeds of up to approximately 22 mph (35 km/h). While in operation, the system independently locates and measures parking spaces on both sides of the vehicle. When driving at speeds below 19 mph (30km/h), you will see parking symbol ② as a status indicator in the instrument cluster.

When a parking space has been detected, an arrow towards the right ③ or the left ① also appears. Parking Guidance only displays parking spaces on the front-passenger side as standard. Parking spaces on the driver's side are displayed as soon as the turn signal on the driver's side is activated. To park on the driver's side, you must leave the driver's side turn signal switched on until you have engaged reverse gear.

Parking Guidance will only detect parking spaces:

- that are parallel to the direction of travel
- that are at least 5 ft (1.5 m) wide
- that are at least 4.3 ft (1.3 m) longer than your vehicle

A parking space is displayed while you are driving past it, and until you are approximately 50 ft (15 m) away from it.

Parking

Important safety notes

WARNING

The Parking Guidance is only an aid and may not detect all obstacles. The Parking Guidance does not relieve you of the responsibility to pay attention. You are always responsible for safety and must continue to pay attention to your immediate surroundings when parking and maneuvering. Otherwise, you could endanger yourself and others.

Moving the vehicle into the stop position

- ▶ Stop the vehicle when the parking space symbol shows the desired parking space in the instrument cluster.
- ▶ Vehicles with manual transmission: shift to reverse gear.

Vehicles with automatic transmission: shift into position **R**.

The **Check Vehicle Surroundings Press 'OK' to Confirm** message appears in the multifunction display.



- ▶ Press the **OK** button on the multifunction steering wheel to confirm. The multifunction display switches to Parking Guidance.

Depending on your distance from the parking space, the **Please Drive Backward** message appears in the multifunction display.

- ▶ If necessary, reverse towards the parking space. This is indicated by an arrow pointing backwards. Continue backing up until you hear a tone. Stop – the parking position has been reached. The arrow is white.

The **Please Steer Wheel to the Right** or **Please Steer Wheel to the Left** message appears in the multifunction display.

Backing up into the parking space



- ▶ While the vehicle is stationary, turn the steering wheel in the specified direction

until the arrow is white and a warning tone sounds.

- ▶ **To reverse into the parking space:** maintain the steering wheel angle and reverse carefully.
- ▶ Stop as soon as you hear a warning tone, The vehicle has reached the position in which you need to countersteer.
The **Please Steer Wheel to the Right** or **Please Steer Wheel to the Left** message appears in the multifunction display.
- ▶ **Countersteering:** while the vehicle is stationary, turn the steering wheel in the specified direction until the arrow is white and a warning tone sounds.
- ▶ **To reverse into the parking space:** maintain the steering wheel angle and reverse carefully.
- ▶ Stop as soon as you hear a warning tone, at the latest when PARKTRONIC sounds the continuous warning tone.
The **Parking Guidance Finished** message appears in the multifunction display and a tone sounds. You may be asked to steer in a different direction and then change gear. In this case, further displays in the multifunction display will direct you to the final position.
- ▶ Maneuver if necessary.
- ▶ Always observe the warning messages displayed by PARKTRONIC (▷ page 179).

Canceling Parking Guidance

- ▶ Press the PARKTRONIC button on the center console (▷ page 180).
Parking Guidance is canceled immediately and PARKTRONIC is deactivated.

Parking Guidance is canceled automatically if it is no longer possible to guide you into the parking space, or if a malfunction occurs.

The parking space symbol goes out and a warning tone sounds. The **Parking Guidance Canceled** message appears in the multifunction display.

ATTENTION ASSIST

Important safety notes

WARNING

The ATTENTION ASSIST is only an aid to the driver. It might not recognize fatigue or increasing inattentiveness in time or fail to recognize them at all. The system cannot substitute a rested and attentive driver.

Fatigue can cause you to recognize dangers too late, to misjudge potential dangers, or to react slower. Therefore, make sure to be rested before and during your trip. Take rests early enough and regularly, especially during long trips. Failure to do so could cause you to recognize dangers too late which could result in an accident and serious injury to you and/or others.

ATTENTION ASSIST helps you during long, monotonous journeys such as on freeways and interstate highways. It is active in the range between 50 mph (80 km/h) and 112 mph (180 km/h).

If ATTENTION ASSIST detects typical indicators of fatigue or increasing lapses in concentration on the part of the driver, it suggests you take a break.

ATTENTION ASSIST assesses your level of fatigue or lapses in concentration by taking the following criteria into account:

- your personal driving style, e.g. steering characteristics
- driving conditions, e.g. time, driving time

The functionality of ATTENTION ASSIST is restricted and warnings may be delayed or not occur at all:

- if the road condition is poor, e.g. if the surface is uneven or if there are potholes
- if there is a strong side wind
- if you have adopted a sporty driving style with high cornering speeds or high rates of acceleration

- if you are predominantly driving slower than 50 mph (80 km/h) or faster than 112 mph (180 km/h)
- if you are currently using COMAND or making a telephone call with it
- if the time has been set incorrectly
- in active driving situations, such as when you change lanes or change your speed

Warning and display messages in the multifunction display



- ▶ Activate ATTENTION ASSIST using the on-board computer (▷ page 202). Symbol ① appears in the multifunction display.

If ATTENTION ASSIST is active, you will be warned no sooner than 20 minutes after your journey has begun. You then hear an intermittent warning tone twice and the **Attention Assist: Take a Break!** message appears in the multifunction display.

- ▶ If necessary, take a break.
- ▶ Press the **OK** or **↩** button to confirm the message.

On long journeys, take regular breaks in good time to allow yourself to rest properly. If you do not take a break and ATTENTION ASSIST still detects increasing lapses in concentration, you will be warned again after 15 minutes at the earliest.

ATTENTION ASSIST is reset when you continue your journey and starts assessing your tiredness again if:

- you switch off the engine.
- you take off your seat belt and open the driver's door, e.g. for a change of drivers or to take a break.

Driving Assistance package

General notes

The Driving Assistance package consists of DISTRONIC PLUS (▷ page 166), Blind Spot Assist (▷ page 186) and Lane Keeping Assist (▷ page 187).

Blind Spot Assist

Important safety notes

⚠ WARNING

Blind Spot Assist is only an aid designed to assist driving. It may fail to detect some vehicles and is no substitute for attentive driving.

Blind Spot Assist cannot detect road and traffic conditions. It may fail to detect narrow vehicles, such as motorcycles or bicycles, or may only detect them too late.

Monitoring may be affected by dirty sensors, strong spray or poor visibility caused by snow, rain or mist, for example. In this case, vehicles are detected late or not at all.

Always pay attention to traffic conditions and your surroundings. Otherwise, you may fail to recognize dangers in time, cause an accident and injure yourself and others.

i USA only:

This device has been approved by the FCC as a "Vehicular Radar System". The radar sensor is intended for use in an automotive radar system only. Removal, tampering, or altering of the device will void any warranties, and is not permitted by the

FCC. Do not tamper with, alter, or use in any non-approved way.

Any unauthorized modification to this device could void the user's authority to operate the equipment.

General notes

Blind Spot Assist uses a radar sensor system to monitor the areas on both sides of your vehicle. It is active from a speed of approx. 20 mph (30 km/h). A warning display in the exterior mirrors draws your attention to vehicles detected in the monitored area. If you then switch on the corresponding turn signal to change lane, you will also receive an optical and audible collision warning. Blind Spot Assist uses sensors in the rear bumper for monitoring purposes.

For Blind Spot Assist to assist you when driving, the radar sensor system must be activated (▷ page 206) and operational.

Monitoring range of the sensors

WARNING

Blind Spot Assist monitors certain areas in the immediate vicinity of your vehicle. Vehicles that approach and drive past at high speeds are not detected. There is no display and no warning.

If the lanes are very wide, it may not be possible to monitor the complete width of the neighboring lane. For this reason, vehicles in the next lane may not be detected, especially if they are driving in a staggered formation. This may be the case if vehicles are driving at that edge of their lane which is furthest away from your vehicle.

Always pay attention to traffic conditions and your surroundings. Otherwise, you may fail to recognize dangers in time, cause an accident and injure yourself and others.

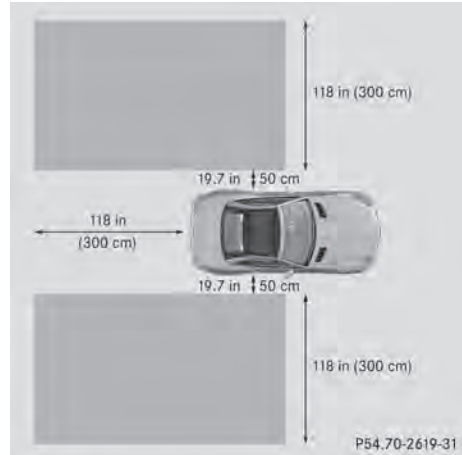

Blind Spot Assist monitors the area up to 10 ft (3.0m) behind your vehicle and directly next to your vehicle, as shown in the diagram. For this purpose, Blind Spot Assist uses radar sensors in the rear bumper.

If the lanes are narrow, vehicles driving in the lane beyond the lane next to your vehicle may be indicated, especially if the vehicles are not driving in the middle of their lane. This may be the case if there are vehicles driving at the inner edge of their lanes.

Due to the nature of the system:

- warnings may be issued in error when driving close to crash barriers or similar solid lane borders.
- the warning is canceled when driving for an extended period next to long vehicles, such as trucks.

The two radar sensors for Blind Spot Assist are integrated into the sides of the rear bumper. Make sure that the bumper is free from dirt, ice or slush around the sensors. The sensors must not be covered, for example by cycle racks or overhanging loads. Following a severe impact or in the event of damage to the bumpers, have the function of the sensors checked at a qualified specialist workshop. Blind Spot Assist may otherwise not work properly.

Indicator and warning display

WARNING

Blind Spot Assist is not active at speeds below approximately 20 mph (30 km/h). The indicator lamps in the exterior mirrors are yellow. Vehicles in the monitoring range are then not indicated.

Always pay attention to traffic conditions and your surroundings. Otherwise, you may fail to recognize dangers in time, cause an accident and injure yourself and others.

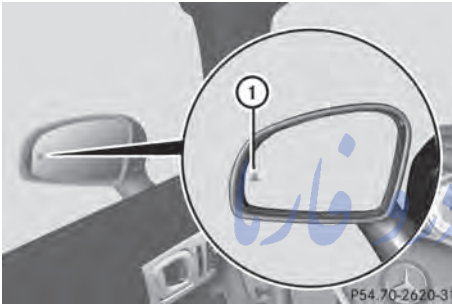

① Yellow indicator lamp/red warning lamp

When Blind Spot Assist is activated, indicator lamp ① lights up yellow in the exterior mirrors up to a vehicle speed of 20 mph (30 km/h). From a speed of 20 mph (30 km/h) the indicator lamp goes out and Blind Spot Assist is operational.

If a vehicle is detected in the monitoring range of Blind Spot Assist from a speed of approx. 20 mph (30 km/h), warning lamp ① lights up red on the corresponding side. This warning is always emitted when a vehicle enters the blind spot monitoring range from behind or from the side. If you overtake a vehicle, a warning will only be given if the difference in speed is less than 7 mph (12 km/h).

The yellow indicator lamp goes out if reverse gear is engaged. In this event, Blind Spot Assist is no longer active.

The brightness of the indicator/warning lamps is adjusted automatically according to the ambient light.

Collision warning

If a vehicle is detected in the monitoring range of Blind Spot Assist and you switch on the corresponding turn signal, a double warning tone sounds. Red warning lamp ① flashes. If the turn signal remains on, vehicles detected are indicated by the flashing of red warning lamp ①. There are no further warning tones.

Switching on Blind Spot Assist

- ▶ Make sure that the radar sensor system (▷ page 206) and Blind Spot Assist (▷ page 202) are activated in the on-board computer.
- ▶ Turn the SmartKey to position **2** in the ignition lock. Warning lamps ① in the exterior mirrors light up red for approx. 1.5 seconds and then yellow.

Lane Keeping Assist

Important safety notes

WARNING

Lane Keeping Assist does not keep your vehicle in its lane. It is only an aid and may detect the lane markings on the road incorrectly or not at all.

The system may be impaired or may not function if:

- there is poor visibility, e.g. due to insufficient illumination of the road, or due to snow, rain, fog or spray.
- there is glare, e.g. from oncoming traffic, the sun, or reflection from other vehicles.
- the windshield is dirty, fogged up or covered, for instance by a sticker, in the vicinity of the camera.
- several or no lane markings for a single lane are present.
- the lane markings are worn away, dark or covered up, e.g. by dirt or snow.
- the distance to the vehicle in front is too small and the lane markings thus cannot be detected.

- the lane markings on the road are unclear, e.g. near roadworks.
- the lane markings change quickly, e.g. lanes branch off, cross one another or merge.
- the road is narrow and winding.

Lane Keeping Assist cannot detect road and traffic conditions. It is not a substitute for attentive driving. You are responsible for the vehicle's speed, braking in good time, and steering correctly. Always adapt your driving style to suit the prevailing road and weather conditions. Always pay attention to traffic conditions and your surroundings. Otherwise, you may fail to recognize dangers in time, cause an accident and injure yourself and others.

General notes

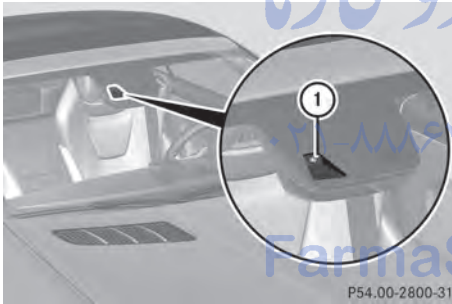

Lane Keeping Assist monitors the area in front of your vehicle with camera ①, which is mounted at the top of the windshield. Lane Keeping Assist detects lane markings on the road and warns you before you leave your lane unintentionally.

If you select **km** on the on-board computer in the **Display Unit Speed-/Odometer:** (▷ page 203) function, Lane Keeping Assist is active starting at a speed of 60 km/h. If the **miles** display unit is selected, the assistance range begins at 40 mph.

A warning may be given if a front wheel passes over a lane marking. It will warn you by means of intermittent vibration in the steering wheel for up to 1.5 seconds.

Switching on Lane Keeping Assist



- ▶ Switch on Active Lane Keeping Assist using the on-board computer; to do so, select **Standard** or **Adaptive** (▷ page 202). Symbol ① appears in the multifunction display.

If your speed exceeds 40 mph (60 km/h) and lane markings are detected, symbol ① is highlighted in green. Lane Keeping Assist is ready for use.

Standard

If **Standard** is selected, no warning vibration occurs if:

- you switch on the turn signals. In this event, the warnings are suppressed for a certain period of time.
- a driving safety system intervenes, such as ABS, BAS or ESP®.

Adaptive

If **Adaptive** is selected, no warning vibration occurs if:

- you switch on the turn signals. In this event, the warnings are suppressed for a certain period of time.
- a driving safety system intervenes, e.g. ABS, BAS or ESP®.
- you accelerate hard, e.g. kickdown.
- you brake hard.
- you steer actively, e.g. swerve to avoid an obstacle or change lane quickly.
- you cut the corner on a sharp bend.

In order that you are warned only when necessary and in good time if you cross the lane marking, the system recognizes certain conditions and warns you accordingly.

The warning vibration occurs earlier if:

- you approach the outer lane marking on a bend.
- the road has very wide lanes, e.g. a freeway.
- the system recognizes solid lane markings.

The warning vibration occurs later if:

- the road has narrow lanes.
- you cut the corner on a bend.

امداد خودرو فارما

تلفن شبانه روزی: ۰۲۱-۸۸۸۶۲۰۸۵

FarmaSOS.com

امداد خودرو فارما

تلفن شبانه روزی: ۰۲۱-۸۸۸۶۲۰۸۵

FarmaSOS.com

Useful information	192
Important safety notes	192
Displays and operation	192
Menus and submenus	195
Display messages	211
Warning and indicator lamps	242

امداد خودرو فارما

تلفن شبانه روزی: ۰۲۱-۸۸۸۶۲۰۸۵

FarmaSOS.com

Useful information

- 1 This Operator's Manual describes all models and all standard and optional equipment of your vehicle available at the time of publication of the Operator's Manual. Country-specific differences are possible. Please note that your vehicle may not be equipped with all features described. This also applies to safety-related systems and functions.
- i Read the information on qualified specialist workshops: (▷ page 23).

Important safety notes

WARNING

The driver's concentration must always be directed primarily at road traffic.

For your safety and the safety of others, selecting features through the multifunction steering wheel should only be done by the driver when traffic and road conditions permit it to be done safely.

Bear in mind that at a speed of only 30 mph (approximately 50 km/h), the vehicle covers a distance of 44 feet (approximately 14 m) per second.

WARNING

No messages will be displayed if either the instrument cluster or the multifunction display is inoperative.

As a result, you will not be able to see information about your driving conditions, such as

- speed
- outside temperature
- warning/indicator lamps
- malfunction/warning messages
- failure of any systems

Driving characteristics may be impaired.

If you must continue to drive, do so with added caution. Contact an authorized Mercedes-Benz Center as soon as possible.

WARNING

Malfunction and warning messages are only displayed for certain systems and are intentionally not very detailed. The malfunction and warning messages are simply a reminder with respect to the operation of certain systems. They do not replace the owner's and/or driver's responsibility to maintain the vehicle's operating safety. Have all required maintenance services and safety checks performed on the vehicle. Bring the vehicle to an authorized Mercedes-Benz Center to address the malfunction and warning messages.

WARNING

All categories of messages contain important information which should be taken note of and, where a malfunction is indicated, addressed as soon as possible at an authorized Mercedes-Benz Center.

Failure to repair the condition noted may cause damage not covered by the Mercedes-Benz Limited Warranty, or result in property damage or personal injury.



For an illustration of the instrument cluster, see (▷ page 29).

Displays and operation

Instrument lighting

The lighting in the instrument cluster, in the displays and the controls in the vehicle interior can be adjusted using the brightness control knob.

The brightness control knob is on the bottom left of the instrument cluster (▷ page 29).

- Turn the brightness control knob counter-clockwise or clockwise.
If the light switch is set to **AUTO**,  or , the brightness is dependent upon the brightness of the ambient light.

- i** The light sensor in the instrument cluster automatically controls the brightness of the multifunction display.

In daylight, the displays in the instrument cluster are not lit.

Coolant temperature display

WARNING

Driving when your engine is overheated can cause some fluids which may have leaked into the engine compartment to catch fire. You could be seriously burned.

Steam from an overheated engine can cause serious burns which can occur just by opening the engine hood. Stay away from the engine if you see or hear steam coming from it.

Stop the vehicle in a safe location away from other traffic. Turn off the engine, get out of the vehicle and do not stand near the vehicle until the engine has cooled down.

- i** A display message is shown if the coolant temperature is too high.

If the coolant temperature is over 248 °F (120 °C), do not continue driving. The engine will otherwise be damaged.

The coolant temperature gauge is in the instrument cluster on the right-hand side (▷ page 29).

Under normal operating conditions and with the specified coolant level, the coolant temperature may rise to 248 °F (120 °C).

Tachometer

- i** Do not drive in the overrevving range, as this could damage the engine.

The red band in the tachometer indicates the engine's overrevving range.

The fuel supply is interrupted to protect the engine when the red band is reached.

Outside temperature display

WARNING

The outside temperature indicator is not designed to serve as an ice-warning device and is therefore unsuitable for that purpose. Indicated temperatures just above the freezing point do not guarantee that the road surface is free of ice. The road may still be icy, especially in wooded areas or on bridges.

The outside temperature display is in the multifunction display (▷ page 195).

Changes in the outside temperature are displayed after a short delay.

Speedometer with segments

The segments in the speedometer indicate which speed range is available.

- Cruise control activated (▷ page 163):
The segments light up from the stored speed to the maximum speed.
- DISTRONIC PLUS activated (▷ page 166):
One or two segments in the set speed range light up.
- DISTRONIC PLUS detects a vehicle in front:
The segments between the speed of the vehicle in front and the stored speed light up.

Operating the on-board computer

Overview



- ① Multifunction display
- ② Right control panel
- ③ Left control panel

► **To activate the on-board computer:** turn the SmartKey to position **1** in the ignition lock.

You can control the multifunction display and the settings in the on-board computer using the buttons on the multifunction steering wheel.

Left control panel



- Calls up the menu and menu bar



Press briefly:

- Scrolls in lists
- Selects a submenu or function
- In the **Audio** menu: selects a stored station, an audio track or a video scene
- In the **Te1** (telephone) menu: switches to the phone book and selects a name or telephone number



Press and hold:

- In the **Audio** menu: selects the previous/next station or selects an audio track or a video scene using rapid scrolling
- In the **Te1** (Telephone) menu: starts rapid scrolling if the phone book is open



- Confirms a selection/display message
- In the **Te1** (telephone) menu: switches to the telephone book and starts dialing the selected number
- In the **Audio** menu: stops the station search function at the desired station

Right control panel



- Rejects or ends a call
- Exits phone book/redial memory



- Makes or accepts a call
- Switches to the redial memory





- Adjusts the volume



- Mute

Back button

	<p>Press briefly:</p> <ul style="list-style-type: none"> • Back • Switches off the Voice Control System; see the separate operating instructions • Hides display messages/calls up the last Trip menu function used • Exits the telephone book/redial memory
	<p>Press and hold:</p> <ul style="list-style-type: none"> • Calls up the standard display in the Trip menu



Example: multifunction display for automatic transmission

- ① Transmission position (▷ page 146)
- ② Drive program (▷ page 146)
- ③ Description field
- ④ Menu bar
- ⑤ Outside temperature or speed (▷ page 204)
- ⑥ Time





▶ **To show menu bar** (4): press the ◀ or ▶ button on the steering wheel.

Menu bar (4) disappears after a few seconds. Text field (3) shows the selected menu or submenu as well as display messages.

i You can set the time using the audio system or COMAND; see the separate operating instructions.

Vehicles with manual transmission: the clock and the outside temperature or speed are shown instead of transmission position (1) and drive program (2).

The following messages may appear in the multifunction display:

- ↑ Gearshift recommendation (▷ page 145)
- ← P → Parking Guidance (▷ page 181)
- CRUISE** Cruise control (▷ page 163)
-  Adaptive high-beam Assist (▷ page 111)
-  ATTENTION ASSIST (▷ page 184)
- ECO** ECO start/stop function (▷ page 139)
-  Lane Keeping Assist (▷ page 187)
- HOLD** HOLD function (▷ page 176)
-  PRE-SAFE® Brake (▷ page 65)

Menus and submenus

Menu overview

Press the ◀ or ▶ button on the steering wheel to call up the menu bar and select a menu.

Operating the on-board computer (▷ page 194).

Depending on the equipment installed in the vehicle, you can call up the following menus:

- **Trip** menu (▷ page 196)
- **Navi** menu (navigation instructions) (▷ page 197)
- **Audio** menu (▷ page 199)

- **Te1** menu (telephone) (▷ page 200)
- **DriveAssist** menu (assistance) (▷ page 201)
- **Service** menu (▷ page 203)
- **Sett.** menu (▷ page 203)
- **AMG** menu in AMG vehicles (▷ page 207)

Trip menu

Standard display







- ▶ Press and hold the  button on the steering wheel until the Trip menu with trip odometer ① and odometer ② is shown.

Trip computer "From Start" or "From Reset"



Example: trip computer "From Start"

- ① Distance
 - ② Time
 - ③ Average speed
 - ④ Average fuel consumption
- ▶ Press the  or  button on the steering wheel to select the Trip menu.
 - ▶ Press the  or  button to select **From Start** or **From Reset**.

The values in the **From Start** submenu are calculated from the start of a journey whilst the values in the **From Reset** submenu are

calculated from the last time the submenu was reset (▷ page 197).

The **From Start** trip computer is automatically reset when:



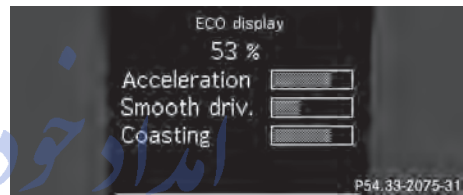

- The ignition has been switched off for more than four hours.
- 999 hours have been exceeded.
- 9,999 miles have been exceeded.

The **From Reset** trip computer is automatically reset if the value exceeds 9,999 hours or 99,999 miles.

ECO display



Example: ECO display

- ▶ Press the  or  button on the steering wheel to select the Trip menu.
- ▶ Press the  or  button to select the **ECO DISPLAY**.





If the ignition remains switched off for longer than four hours, the ECO display will be automatically reset.

For further information on the ECO display, see (▷ page 159).

Displaying the range and current fuel consumption



- ① Approximate range
- ② Current fuel consumption (not for AMG vehicles)





- ▶ Press the  or  button on the steering wheel to select the **Trip** menu.
- ▶ Press the  or  button to select the current fuel consumption (not for AMG vehicles) and the approximate range.

The approximate range that can be covered depends on the fuel level and your current driving style. If there is only a small amount of fuel left in the fuel tank, the display shows a vehicle being refueled  instead of the range.

Digital speedometer



- ① Shift recommendation
- ② Digital speedometer

- ▶ Press the  or  button on the steering wheel to select the **Trip** menu.
- ▶ Press the  or  button to select digital speedometer ②.





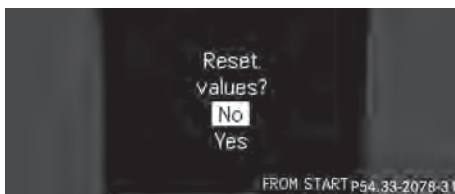

Further information on gearshift recommendations (▷ page 145).

- ❗ If the gearshift recommendation is shown in the multifunction display, it is not shown in the status bar.

Resetting values



Example: resetting the trip computer "From Start"

- ▶ Press the  or  button on the steering wheel to select the **Trip** menu.
- ▶ Press the  or  button to select the function that you wish to reset.
- ▶ Press the  button.
- ▶ Press the  button to select **Yes** and press the  button to confirm.

You can reset the values of the following functions:



- Trip odometer
- "From Start" trip computer
- "From Reset" trip computer
- ECO display

- ❗ When you reset the values in the "ECO display", the values in the trip computer "From start" are likewise reset. When you reset the values in the trip computer "From start", the values in the "ECO display" are likewise reset.

Navigation system menu

Displaying navigation instructions

In the **Navi** menu, the multifunction display shows navigation instructions. For more information on navigation, see the separate operating instructions.

- ▶ Switch on Audio 20 with Becker® MAP PILOT or COMAND (see the separate operating instructions).
- ▶ Press the  or  button on the steering wheel to select the **Navi** menu.

Route guidance not active

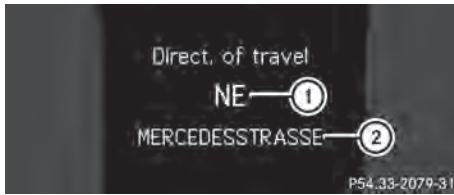

- ① Direction of travel
- ② Current street

Route guidance active

No change of direction announced



- ① Distance to the destination
- ② Distance to the next change of direction
- ③ Current street
- ④ Symbol "follow the road's course"

Change of direction announced without a lane recommendation



- ① Road into which the change of direction leads
- ② Distance to change of direction and visual distance display
- ③ Change-of-direction icon

When a change of direction has been announced, you will see visual distance display ② next to the symbol for change of direction ③. This shortens from the bottom

to the top of the display as you approach the point of the announced change of direction.

Change of direction announced with a lane recommendation



- ① Road into which the change of direction leads
- ② Distance to change of direction and visual distance display
- ③ Lane recommendation
- ④ New lane during a change of direction
- ⑤ Uninterrupted lane
- ⑥ Change-of-direction icon

On multilane roads, the system can display lane recommendation ③ for the next change of direction. During the change of direction, additional lanes may be displayed.

Lane recommendations are only displayed if the relevant data is available on the digital map.

Other status indicators of the navigation system

-  : you have reached the destination or an intermediate destination.
- **New Route...** or **Calculating Route:** calculating a new route
- **Off Map** or **Off Mapped Road:** the vehicle position is outside the area of the digital map (off-map position).
- **No Route:** no route could be calculated to the selected destination.

Audio menu

Selecting a radio station



- ① Waveband
- ② Station frequency with memory position

i Station ② is displayed with the station frequency or station name. The memory position is only displayed along with station ② if this has been stored.

- ▶ Switch on the audio system or COMAND and select Radio; see the separate operating instructions.
- ▶ Press the ◀ or ▶ button on the steering wheel to select the **Audio** menu.
- ▶ **To select a stored station:** briefly press the ▲ or ▼ button.
- ▶ **To select a station from the station list:** press and briefly hold the ▲ or ▼ button.

If no station list is received:

- ▶ **To select a station using the station search:** press and briefly hold the ▲ or ▼ button.

i For information on changing waveband and storing stations, see the separate operating instructions.

i SIRIUS XM satellite radio functions like a normal radio.

For more information on satellite radio operation, see the separate operating instructions.

Operating an audio player or audio media



Display CD/DVD changer (example)

- ① Current CD in the CD/DVD changer
- ② Current title

Audio data from various audio devices or media can be played, depending on the equipment installed in the vehicle.

- ▶ Switch on the audio system or COMAND and activate audio CD/DVD mode or MP3 mode; see the separate operating instructions.

- ▶ Press the ◀ or ▶ button on the steering wheel to select the **Audio** menu.

- ▶ **To select the next/previous track:** briefly press the ▲ or ▼ button.

- ▶ **To select a track from the track list (rapid scrolling):** press and hold the ▲ or ▼ button until desired track ② has been reached.

If you press and hold ▲ or ▼, the rapid scrolling speed is increased. Not all audio drives or data carriers support this function.

If track information is stored on the audio device or medium, the multifunction display will show the number and title of the track.

The current track does not appear in audio AUX mode (**A**uxiliary audio mode: external audio source connected).

Video DVD operation



Display CD/DVD changer (example)

- ① Current DVD in the CD/DVD changer
- ② Current scene

- ▶ Switch on COMAND and select video DVD; see the separate operating instructions.
- ▶ Press the ◀ or ▶ button on the steering wheel to select the **Audio** menu.
- ▶ **To select the next/previous scene:** briefly press the ▲ or ▼ button.
- ▶ **To select a scene from the scene list (rapid scrolling):** press and hold the ▲ or ▼ button until desired scene ② has been reached.

Telephone menu

Introduction

⚠ WARNING

The driver's attention to the road must always be his/her primary focus when driving. For your safety and the safety of others, we recommend that you pull over to a safe location and stop before placing or taking a telephone call. If you choose to use the telephone while driving, please use the hands-free device and only use the telephone when road, weather and traffic conditions permit. Some jurisdictions prohibit the driver from using a mobile phone while driving a vehicle. Bear in mind that at a speed of just 30 mph (approximately 50 km/h), your vehicle covers a distance of 44 feet (approximately 14 m) every second.

- ▶ Switch on your mobile phone and audio system or COMAND, see the separate operating instructions.
- ▶ Establish a Bluetooth® connection to the audio system or COMAND; see the separate operating instructions.
- ▶ Press the ◀ or ▶ button on the steering wheel to select the **Te1** menu.

You will see one of the following display messages in the multifunction display:

- **Phone READY** or the name of the network provider: the mobile phone has found a network and is ready to receive.
- **Phone No Service:** there is no network available or the mobile phone is searching for a network.

Accepting a call

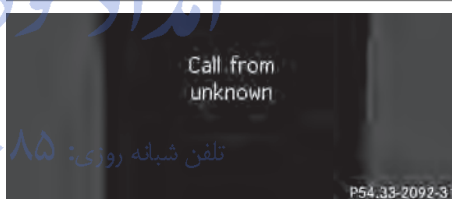

- ▶ Press the ☎ button on the steering wheel to accept an incoming call.

If someone calls you when you are in the **Te1** menu, a display message appears in the multifunction display.

You can accept a call even if you are not in the **Te1** menu.

Rejecting or ending a call

- ▶ Press the ☎ button on the steering wheel.

You can end or reject a call even if you are not in the **Te1** menu.

Dialing a number from the phone book

- ▶ Press the ◀ or ▶ button on the steering wheel to select the **Te1** menu.
- ▶ Press the ▲, ▼ or OK button to switch to the phone book.
- ▶ Press the ▲ or ▼ button to select the desired name.

or

- ▶ **To begin rapid scrolling:** press and hold the ▲ or ▼ button for longer than one second.
Rapid scrolling stops when you release the button or reach the end of the list.
- ▶ **If only one telephone number is stored for a name:** press the ☎ or OK button to start dialing.

or

- ▶ **If there is more than one number for a particular name:** press the ☎ or OK button to display the numbers.
- ▶ Press the ▲ or ▼ button to select the number you want to dial.
- ▶ Press the ☎ or OK button to start dialing.

or

- ▶ **To exit the telephone book:** press the ☎ or ↩ button.

Redialing

The on-board computer saves the last names or numbers dialed in the redial memory.

- ▶ Press the ◀ or ▶ button on the steering wheel to select the **Te1** menu.
- ▶ Press the ☎ button to switch to the redial memory.
- ▶ Press the ▲ or ▼ button to select the desired name or number.
- ▶ Press the ☎ or OK button to start dialing.

or

- ▶ **To exit the redial memory:** press the ☎ or ↩ button.

Assistance menu

Introduction



In the **DriveAssist** menu, you have the following options:

- Showing the distance display (▷ page 201)
- Activating/deactivating the PRE-SAFE® Brake (▷ page 202)
- Activating/deactivating ATTENTION ASSIST (▷ page 202)
- Activating/deactivating Blind Spot Assist (▷ page 202)
- Activating/deactivating Lane Keeping Assist (▷ page 202)

Showing the distance display







- ▶ Press ◀ or ▶ on the steering wheel to select the **DriveAssist** menu.
- ▶ Press the ▲ or ▼ button to select **Distance Display**.
- ▶ Press the OK button.
The **DISTRONIC PLUS** distance display appears in the multifunction display (▷ page 173).

If the **Sensors Deactivated** message appears, the radar sensor system is deactivated.



- ▶ Switch on the radar sensor system (▷ page 206).

Activating/deactivating PRE-SAFE® Brake

PRE-SAFE® Brake is only available in vehicles with DISTRONIC PLUS.

- ▶ Press  or  on the steering wheel to select the **DriveAssist** menu.
- ▶ Press the  or  button to select **PRE-SAFE Brake**.
- ▶ Press the  button.
The current selection is displayed.
- ▶ **To activate/deactivate:** press the  button again.

When PRE-SAFE® Brake is activated, the multifunction display shows the  symbol as long as the HOLD function is not activated (▷ page 176).







Vehicles with Parking Guidance: if PARKTRONIC is activated and you are driving at a speed 22 under 35 km/h, the  Parking Guidance symbol is shown instead of the  symbol (▷ page 181).

If the **PRE-SAFE Brake: Sensors Deactivated** message appears, the radar sensor system is deactivated.

- ▶ Switch on the radar sensor system (▷ page 206).

For more information on PRE-SAFE® Brake, see (▷ page 65).







Activating/deactivating ATTENTION ASSIST

- ▶ Press  or  on the steering wheel to select the **DriveAssist** menu.
- ▶ Press the  or  button to select **Attention Asst.**
- ▶ Press the  button.
The current selection is displayed.
- ▶ **To activate/deactivate:** press the  button again.

When ATTENTION ASSIST is activated, the  symbol appears in the multifunction display when the ignition is on.

For further information about ATTENTION ASSIST, see (▷ page 184).

Activating/deactivating Blind Spot Assist









- ▶ Press  or  on the steering wheel to select the **DriveAssist** menu.
- ▶ Press the  or  button to select **Blind Spot Asst.**
- ▶ Press the  button.
The current selection is displayed.
- ▶ **To activate/deactivate:** press the  button again.

If the **Blind Spot Assist Deactivated** message appears, the radar sensor system is deactivated.

- ▶ Switch on the radar sensor system (▷ page 206).

For further information about Blind Spot Assist, see (▷ page 185)

Activating/deactivating Lane Keeping Assist

- ▶ Press  or  on the steering wheel to select the **DriveAssist** menu.
- ▶ Press the  or  button to select **Lane Keep. Asst.**
- ▶ Press the  button.
The current selection is displayed.
- ▶ Press  to confirm.
- ▶ Press  or  to set **Off**, **Standard** or **Adaptive**.
- ▶ Press the  button to save the setting.

When Lane Keeping Assist is activated, the  symbol appears in the multifunction display when the ignition is on.

For further information about Lane Keeping Assist, see (▷ page 187).

Service menu

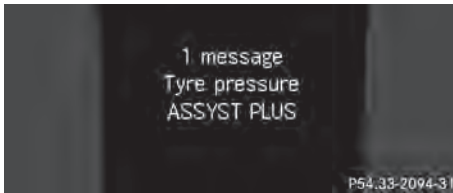

In the **Serv.** menu, you have the following options:

- calling up display messages (▷ page 211)
- restarting the tire pressure loss warning system (▷ page 315)
- checking tire pressure electronically (▷ page 316)
- calling up a service due date (▷ page 280)

Settings menu

Introduction



In the **Sett.** menu, you have the following options:

- change the instrument cluster settings (▷ page 203)
- change the light settings (▷ page 204)
- change the vehicle settings (▷ page 206)
- change the convenience settings (▷ page 206)
- restore the factory settings (▷ page 203)

Restoring the factory settings

- ▶ Press the or button on the steering wheel to select the **Sett.** menu.
- ▶ Press the or button to select the **Factory Setting** submenu.

- ▶ Press to confirm.

The **Reset All Settings?** message appears.

- ▶ Press the or button to select **No** or **Yes**.

- ▶ Press the button to confirm the selection.

If you have selected **Yes**, the multifunction display shows a confirmation message.

For safety reasons, the **Daytime Running Lights:** function in the **Lights** submenu is only reset if the vehicle is stationary.

Instrument cluster

Selecting the unit of measurement for distance

You can determine whether the multifunction display shows some messages in miles or kilometers.

- ▶ Press the or button on the steering wheel to select the **Sett.** menu.
- ▶ Press the or button to select the **Instr. Cluster** submenu.
- ▶ Press to confirm.
- ▶ Press the or button to select the **Display Unit Speed-/Odometer:** function.

You will see the selected setting: **km** or **miles**.

- ▶ Press the button to save the setting.

The selected unit of measurement for distance applies to:

- the digital speedometer in the **Trip** menu
- odometer and the trip odometer
- trip computer
- current consumption and the range
- the navigation instructions in the **Nav i** menu
- cruise control
- DISTRONIC PLUS
- ASSYST PLUS service interval display

Switching the additional speedometer on or off

Only vehicles with manual transmission have this function.

- ▶ Press the ◀ or ▶ button on the steering wheel to select the **Sett.** menu.
- ▶ Press the ▼ or ▲ button to select the **Instr. Cluster** submenu.
- ▶ Press **OK** to confirm.
- ▶ Press the ▼ or ▲ button to select the **Speedometer [mph]**: function.
You will see the selected setting: **On** or **Off**.
- ▶ Press the **OK** button to save the setting.

i Speed is displayed in mph.

The **Speedometer [mph]** function allows you to choose whether the status area in the multifunction display always shows the speed in mph instead of the outside temperature.

Selecting the permanent display function

You can determine whether the multifunction display permanently shows your speed or the outside temperature.

- ▶ Press the ◀ or ▶ button on the steering wheel to select the **Sett.** menu.
- ▶ Press the ▼ or ▲ button to select the **Instr. Cluster** submenu.
- ▶ Press **OK** to confirm.
- ▶ Press the ▼ or ▲ button to select the **Permanent Display**: function.
You will see the selected setting **Outside Temperature** or **Speedometer [km/h]** (USA)/**Speedometer [mph]** (Canada).
- ▶ Press the **OK** button to save the setting.

i The speed is shown in km/h (USA)/mph (Canada).

Lights

Setting the daytime running lamps

i This function is not available in Canada.

- ▶ Press the ◀ or ▶ button on the steering wheel to select the **Sett.** menu.
- ▶ Press the ▼ or ▲ button to select the **Lights** submenu.
- ▶ Press **OK** to confirm.
- ▶ Press the ▼ or ▲ button to select the **Daytime Running Lights**: function.
You will see the selected setting: **Enabled** or **Disabled**.
- ▶ Press the **OK** button to save the setting.

Further information on daytime running lamps (▷ page 107).





Switching Adaptive Highbeam Assist on/off

- ▶ Press the ◀ or ▶ button on the steering wheel to select the **Sett.** menu.
- ▶ Press the ▼ or ▲ button to select the **Lights** submenu.
- ▶ Press **OK** to confirm.
- ▶ Press the ▼ or ▲ button to select the **Adaptive Highbeam Assist**: function.
You will see the selected setting: **Enabled** or **Disabled**.
- ▶ Press the **OK** button to save the setting.













For further information about Adaptive Highbeam Assist, see (▷ page 111).

Setting the brightness of the ambient lighting









- ▶ Press the ◀ or ▶ button on the steering wheel to select the **Sett.** menu.
- ▶ Press the ▼ or ▲ button to select the **Lights** submenu.
- ▶ Press **OK** to confirm.
- ▶ Press the ▼ or ▲ button to select the **Ambient Light Brightness**: function.
You will see the selected setting.
- ▶ Press **OK** to confirm.

- ▶ Press the  or  button to adjust the brightness to any level from **Off** to **Level 5** (bright).
- ▶ Press the  or  button to save the setting.

Setting the ambient lighting color

- ▶ Press the  or  button on the steering wheel to select the **Sett.** menu.
- ▶ Press the  or  button to select the **Lights** submenu.
- ▶ Press  to confirm.
- ▶ Press the  or  button to select the **Ambient Light Color:** function.
- ▶ Press  to confirm.
- ▶ Press  or  to set the color to **SOLAR**, **POLAR** or **NEUTRAL**.
- ▶ Press the  or  button to save the setting.

Activating/deactivating surround lighting and exterior lighting delayed switch-off

- ▶ Press the  or  button on the steering wheel to select the **Sett.** menu.
- ▶ Press the  or  button to select the **Lights** submenu.
- ▶ Press  to confirm.
- ▶ Press the  or  button to select the **Locator Lighting:** function. You will see the selected setting: **Enabled** or **Disabled**.
- ▶ Press the  button to save the setting.

Deactivating delayed switch-off of the exterior lighting temporarily:

- ▶ Before leaving the vehicle, turn the SmartKey to position **0** in the ignition lock.
- ▶ Turn the SmartKey to position **2** in the ignition lock. The exterior lighting delayed switch-off is deactivated.

Delayed switch-off of the exterior lighting is reactivated the next time you start the engine.

If you have activated the **Locator Lighting:** function and the light switch is set to **AUTO**, the following functions are activated when it is dark:





- **surround lighting:** the exterior lighting remains lit for 40 seconds after unlocking with the key. If you start the engine, the surround lighting is switched off and automatic headlamp mode is activated (▷ page 107).
- **exterior lighting delayed switch-off:** the exterior lighting remains lit for 60 seconds after the engine is switched off. If you close all the doors and the trunk lid, the exterior lighting goes off after 15 seconds.



i Depending on your vehicle's equipment, when the surround lighting and delayed switch-off exterior lighting are on, the following light up:

- Parking lamps
- Front fog lamps
- Low-beam headlamps
- Daytime running lamps
- Side marker lamps
- Surround lighting in the exterior mirrors

Activating/deactivating the interior lighting delayed switch-off









If you activate the **Interior Lighting Delay:** function, the interior lighting remains on for 20seconds after you remove the key from the ignition lock.

- ▶ Press the  or  button on the steering wheel to select the **Sett.** menu.
- ▶ Press the  or  button to select the **Lights** submenu.
- ▶ Press  to confirm.

- ▶ Press the  or  button to select the **Interior Lighting Delay:** function. You will see the selected setting: **Enabled** or **Disabled**.
- ▶ Press the  button to save the setting.

Vehicle

Activating/deactivating the automatic door locking mechanism









- ▶ Press the  or  button on the steering wheel to select the **Sett.** menu.
- ▶ Press the  or  button to select the **Vehicle** submenu.
- ▶ Press  to confirm.
- ▶ Press the  or  button to select the **Automatic Door Lock:** function. You will see the selected setting: **Enabled** or **Disabled**.
- ▶ Press the  button to save the setting.

If you select the **Automatic Door Locks:** function, the vehicle is centrally locked above a speed of around 9 mph (15 km/h).









For further information on the automatic locking feature, see (▷ page 78).

Activating/deactivating the acoustic locking verification signal

If you switch on the **Acoustic Lock Feedback:** function, an acoustic signal sounds when you lock the vehicle.

- ▶ Press the  or  button on the steering wheel to select the **Sett.** menu.
- ▶ Press the  or  button to select the **Vehicle** submenu.
- ▶ Press  to confirm.
- ▶ Press the  or  button to select the **Acoustic Lock Feedback:** function. You will see the selected setting: **Enabled** or **Disabled**.
- ▶ Press the  button to save the setting.

Activating/deactivating the radar sensor system

- ▶ Press the  or  button on the steering wheel to select the **Sett.** menu.
- ▶ Press the  or  button to select the **Vehicle** submenu.
- ▶ Press  to confirm.
- ▶ Press the  or  button to select **Radar Sensor (See Oper. Manual):**. You will see the selected setting: **Enabled** or **Disabled**.
- ▶ Press the  button to save the setting.

The following systems are switched off when the radar sensor system is deactivated:

- DISTRONIC PLUS (▷ page 166)
- BAS PLUS (▷ page 60)
- PRE-SAFE® Brake (▷ page 65)

Convenience





Activating/deactivating the EASY-ENTRY/EXIT feature



WARNING

You must make sure no one can become trapped or injured by the moving steering wheel when the easy-entry/exit feature is activated.









To stop steering wheel movement, move steering wheel adjustment lever or press one of the memory position buttons.

Do not leave children unattended in the vehicle, or with access to an unlocked vehicle. Children could open the driver's door and unintentionally activate the easy-entry/exit feature, which could result in an accident and/or serious personal injury.

- ▶ Press the  or  button on the steering wheel to select the **Sett.** menu.
- ▶ Press the  or  button to select the **Convenience** submenu.
- ▶ Press  to confirm.

- ▶ Press the  or  button to select the **Easy Entry/Exit**: function.
You will see the selected setting **on** or **off**.
 - ▶ Press the  button to save the setting.
- Further information on the EASY-ENTRY/EXIT feature (▷ page 99).

Switching the belt adjustment on/off

- ▶ Press the  or  button on the steering wheel to select the **Sett.** menu.
- ▶ Press the  or  button to select the **Convenience** submenu.
- ▶ Press  to confirm.
- ▶ Press the  or  button to select the **Belt Adjustment** function.
You will see the selected setting: **Enabled** or **Disabled**.
- ▶ Press the  button to save the setting.





For further information on belt adjustment, see (▷ page 54).



Switching the fold-in mirrors when locking feature on/off

This function is only available on vehicles with Memory Function (▷ page 103).

If you switch on the **Fold Mirrors in when Locking**: function, the exterior mirrors fold in when you lock the vehicle. If you unlock the vehicle and then open a door, the exterior mirrors fold out again.

If you have switched on the **Fold Mirrors in when Locking**: function and you fold the exterior mirrors in using the button on the door (▷ page 101), they will not fold out automatically. The exterior mirrors can then only be folded out using the button on the door.

- ▶ Press the  or  button on the steering wheel to select the **Sett.** menu.
- ▶ Press the  or  button to select the **Convenience** submenu.
- ▶ Press  to confirm.

- ▶ Press the  or  button to select the **Fold Mirrors in when Locking**: function.
You will see the selected setting: **Enabled** or **Disabled**.
- ▶ Press the  button to save the setting.



If you have switched the function on and you fold the exterior mirrors in using the button on the door (▷ page 101), they will not fold out automatically. The exterior mirrors can then only be folded out using the button on the door.

AMG menu in AMG vehicles

AMG displays



- ① Digital speedometer
- ② Gear indicator
- ③ Upshift indicator
- ④ Engine oil temperature
- ⑤ Coolant temperature
- ⑥ Status indicator for ECO start/stop function (▷ page 139)

- ▶ Press  or  on the steering wheel to select the **AMG** menu.

Upshift indicator **UP** ③ indicates that the engine has reached the overrevving range when in the manual gearshift program. Upshift indicator **UP** ③ fades out other messages until you have shifted up.

If the engine oil temperature is below 176 °F (80 °C) the oil temperature is shown in blue.

Avoid driving at full engine output during this time.

SETUP

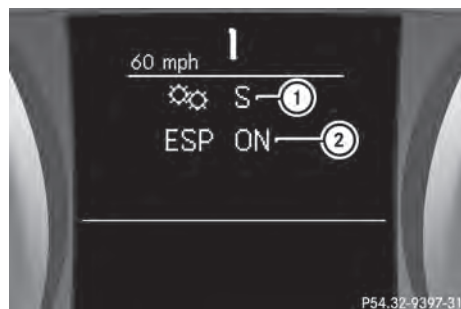

- ① Drive program (C/S/M)
- ② ESP® mode (ON/OFF) or SPORT handling mode (SPORT)

SETUP shows the drive program, the ESP® (Electronic Stability Program) mode and the SPORT handling mode.

- ▶ Press or on the steering wheel to select the AMG menu.
- ▶ Press the button repeatedly until SETUP is displayed.

RACETIMER

Displaying and starting RACETIMER

WARNING

The RACETIMER feature is only for use on roads and in conditions where high speed driving is permitted. Racing on public roads is prohibited under all circumstances. The driver is and must always remain responsible for following posted speed limits.



- ① Lap
- ② RACETIMER

You can start the RACETIMER when the engine is running or if the SmartKey is in position 2 in the ignition lock.

- ▶ Press or on the steering wheel to select the AMG menu.
- ▶ Press the button repeatedly until the RACETIMER is shown.
- ▶ **To start:** press the button to start the RACETIMER.

Displaying the intermediate time

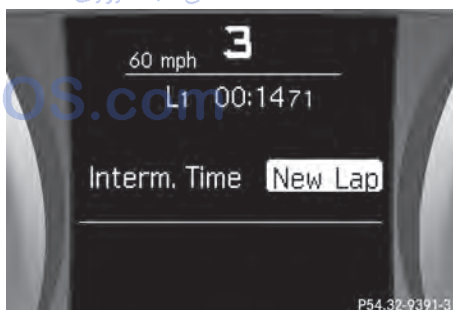

- ▶ Press the or button to select **Interm. Time**.
- ▶ Press to confirm.
The intermediate time is displayed for five seconds.

Starting a new lap

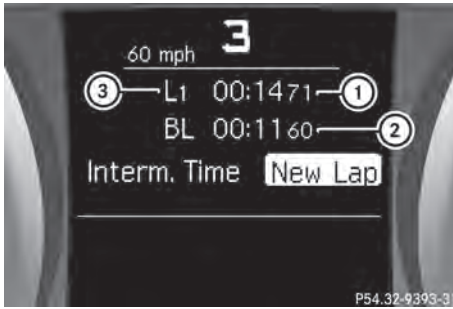

- ① RACETIMER
- ② Fastest lap time (best lap)
- ③ Lap

▶ Press to confirm **New Lap**.

i It is possible to store a maximum of sixteen laps. The 16th lap can only be completed with **Finish Lap**.

Stopping the RACETIMER

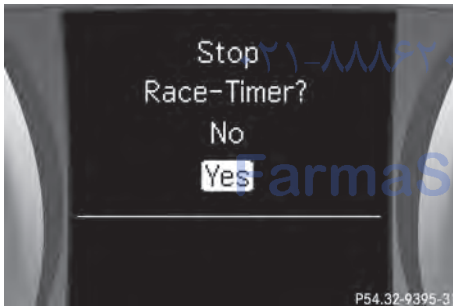

- ▶ Press the button on the steering wheel.
- ▶ Press to confirm **Yes**.

The RACETIMER interrupts timing when you stop the vehicle and turn the SmartKey to position **1** in the ignition lock. If you turn the key to position **2** or **3** and then press to confirm **Start**, timing is continued.

Resetting the current lap

- ▶ Stop the RACETIMER.
- ▶ Press the or button to select **Reset Lap**.
- ▶ Press to reset the lap time to "0".

Deleting all laps



If you switch off the engine, the RACETIMER is reset to "0" after 30 seconds. All laps are deleted.

You cannot delete individual stored laps. If you have stopped 16 laps, the current lap does not have to be reset.

- ▶ Reset the current lap.
- ▶ Press to confirm **Reset**. **Reset Race Timer?** appears in the multifunction display.
- ▶ Press the button to select **Yes** and press the button to confirm. All laps are deleted.

Overall statistics

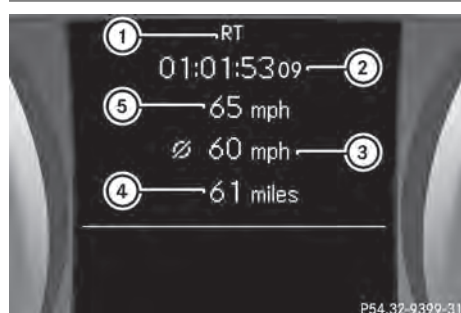

- ① RACETIMER overall evaluation
- ② Total time driven
- ③ Average speed
- ④ Distance covered
- ⑤ Maximum speed

This function is shown if you have stored at least one lap and stopped the RACETIMER.

- ▶ Press or on the steering wheel to select the AMG menu.
- ▶ Press the button repeatedly until the overall evaluation is shown.

This function is only available if you have stored at least two laps and have stopped the RACETIMER.

- ▶ Press or on the steering wheel to select the AMG menu.
- ▶ Press the button repeatedly until the lap evaluation is shown. Each lap is shown in a separate submenu. The fastest lap is indicated by flashing symbol ①.
- ▶ Press the or button to select a different lap evaluation.

Lap statistics

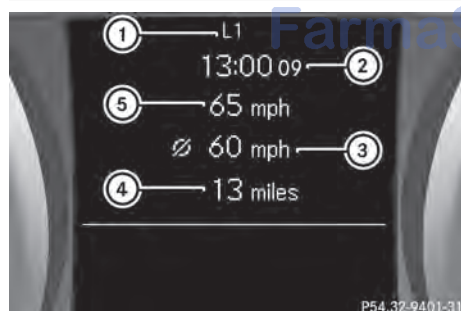

- ① Lap
- ② Lap time
- ③ Average lap speed
- ④ Lap length
- ⑤ Top speed during lap

Display messages

Introduction

General notes

Display messages appear in the multifunction display.

Display messages with graphic displays may be shown in simplified form in the Operator's Manual and may differ from the messages shown in the multifunction display.

Please respond in accordance with the display messages and follow the additional notes in this Operator's Manual.

Certain display messages are accompanied by an audible warning tone or a continuous tone. When you stop and park the vehicle, please observe the notes on:

- HOLD function (▷ page 176)
- Parking (▷ page 155)

Hiding display messages







- ▶ Press the  or  button on the steering wheel to hide the display message. The display message is cleared.

The multifunction display shows high-priority display messages in red. Some high-priority display messages cannot be hidden.

The multifunction display shows these messages continuously until the causes for the messages have been remedied.

Message memory

The on-board computer saves certain display messages in the **message memory**. You can call up the display messages:

- ▶ Press the  or  button on the steering wheel to select the **Serv.** menu. If there are display messages, the multifunction display shows **2 Messages**, for example.
- ▶ Press the  or  button to select the entry, e.g. **2 Messages**.
- ▶ Press  to confirm.
- ▶ Press the  or  button to scroll through the display messages.

When the ignition is switched off, all display messages are deleted, apart from some high-priority display messages. Once the causes of the high-priority display messages have been rectified, the corresponding display messages are also deleted.

Safety systems

Display messages



Possible causes/consequences and ► Solutions



Currently
Unavailable See
Operator's Manual

ABS (Anti-lock Braking System), ESP[®] (Electronic Stability Program), BAS (Brake Assist), PRE-SAFE[®], the HOLD function and hill start assist are temporarily unavailable.

BAS PLUS and PRE-SAFE[®] Brake may also have failed.

In addition, the ,  and  warning lamps light up in the instrument cluster.

ATTENTION ASSIST is deactivated.

Possible causes are:

- Self-diagnosis is not yet complete.
- The on-board voltage may be insufficient.

 **WARNING**

The brake system continues to function normally, but without the functions listed above. The wheels could therefore lock if you brake hard, for example.

The steerability and braking characteristics may be severely affected. The braking distance in an emergency braking situation can increase.

If ESP[®] is not operational, ESP[®] is unable to stabilize the vehicle. There is an increased risk of skidding and an accident.

- Carefully drive a suitable distance, making slight steering movements at a speed above 12 mph (20 km/h).

If the display message disappears, the functions mentioned above are available again.

If the display message continues to be displayed:





- Drive on carefully.
- Visit a qualified specialist workshop.



Inoperative See
Operator's Manual

ABS, ESP[®], BAS, PRE-SAFE[®], the HOLD function and hill start assist are unavailable due to a malfunction.



BAS PLUS and PRE-SAFE[®] Brake may also have failed.













The  (USA only)/ (Canada only), ,  and  warning lamps in the instrument cluster also light up.









ATTENTION ASSIST is deactivated.







 **WARNING**







The brake system continues to function normally, but without the functions listed above. The wheels could therefore lock if you brake hard, for example.

Display messages	Possible causes/consequences and ► Solutions
	<p>The steerability and braking characteristics may be severely affected. The braking distance in an emergency braking situation can increase.</p> <p>If ESP® is not operational, ESP® is unable to stabilize the vehicle. There is an increased risk of skidding and an accident.</p> <ul style="list-style-type: none"> ► Drive on carefully. ► Visit a qualified specialist workshop immediately.
 <p>Currently Unavailable See Operator's Manual</p>	<p>ESP®, BAS, PRE-SAFE®, the HOLD function and hill start assist are temporarily unavailable.</p> <p>BAS PLUS and PRE-SAFE® Brake may also have failed. In addition, the  and  warning lamps light up in the instrument cluster.</p> <p>ATTENTION ASSIST is deactivated.</p> <p>The self-diagnosis function might not be complete, for example.</p> <p>⚠ WARNING</p> <p>The brake system continues to function normally, but without the functions listed above.</p> <p>The braking distance in an emergency braking situation can thus increase.</p> <p>If ESP® is not operational, ESP® is unable to stabilize the vehicle. There is an increased risk of skidding and an accident.</p> <ul style="list-style-type: none"> ► Carefully drive a suitable distance, making slight steering movements at a speed above 12 mph (20 km/h). If the display message disappears, the functions mentioned above are available again. <p>If the display message continues to be displayed:</p> <ul style="list-style-type: none"> ► Drive on carefully. ► Visit a qualified specialist workshop.







Display messages	Possible causes/consequences and ► Solutions
 <p>Inoperative See Operator's Manual</p>	<p>ESP®, BAS, PRE-SAFE®, the HOLD function and hill start assist are unavailable due to a malfunction.</p> <p>BAS PLUS and PRE-SAFE® Brake may also have failed.</p> <p>In addition, the  and  warning lamps light up in the instrument cluster.</p> <p>ATTENTION ASSIST is deactivated.</p> <p>⚠ WARNING</p> <p>The brake system continues to function normally, but without the functions listed above.</p> <p>The braking distance in an emergency braking situation can thus increase.</p> <p>If ESP® is not operational, ESP® is unable to stabilize the vehicle. There is an increased risk of skidding and an accident.</p> <ul style="list-style-type: none"> ► Drive on carefully. ► Visit a qualified specialist workshop.
   <p>Inoperative See Operator's Manual</p>	<p>EBD (electronic brake force distribution), ABS, ESP®, BAS, PRE-SAFE®, the HOLD function and hill start assist are unavailable due to a malfunction.</p> <p>BAS PLUS and PRE-SAFE® Brake may also have failed.</p> <p>In addition, the ,  and  warning lamps light up in the instrument cluster and a warning tone sounds.</p> <p>⚠ WARNING</p> <p>The brake system continues to function normally, but without the functions listed above. The front and rear wheels could therefore lock if you brake hard, for example.</p> <p>The steerability and braking characteristics may be severely affected. The braking distance in an emergency braking situation can increase.</p> <p>If ESP® is not operational, ESP® is unable to stabilize the vehicle. There is an increased risk of skidding and an accident.</p> <ul style="list-style-type: none"> ► Drive on carefully. ► Visit a qualified specialist workshop immediately.
 (USA only)  (Canada only) <p>Please Release Parking Brake</p>	<p>The red  (USA only)/ (Canada only) indicator lamp flashes and a warning tone sounds. A condition for automatic release of the electric parking brake is not fulfilled (> page 156). You are driving with the electric parking brake applied.</p> <ul style="list-style-type: none"> ► Release the electric parking brake manually.

Display messages	Possible causes/consequences and ► Solutions
	<p>The red  (USA only)/ (Canada only) indicator lamp flashes and a warning tone sounds.</p> <p>You are using the electric parking brake for emergency braking (► page 156).</p>
<p> (USA only)  (Canada only)</p> <p>Parking Brake See Operator's Manual</p>	<p>The yellow  warning lamp lights up.</p> <p>The electric parking brake is malfunctioning.</p> <p>To apply:</p> <ul style="list-style-type: none"> ► Switch the ignition off. ► Press the electric parking brake handle for at least ten seconds. ► Vehicles with manual transmission: engage first gear. ► Vehicles with automatic transmission: shift the transmission to P. ► Consult a qualified specialist workshop. <p>The yellow  warning lamp and the red  (USA only)/ (Canada only) indicator lamp light up.</p> <p>The electric parking brake is malfunctioning.</p> <p>To release:</p> <ul style="list-style-type: none"> ► Switch off the ignition and turn it back on. ► Release the electric parking brake manually. <p>or</p> <ul style="list-style-type: none"> ► Vehicles with manual transmission: release the electric parking brake using the automatic emergency release (► page 156). ► Vehicles with automatic transmission: release the electric parking brake automatically (► page 156). <p>If the yellow  warning lamp remains lit or continues to flash:</p> <ul style="list-style-type: none"> ► Do not drive on. ► Consult a qualified specialist workshop.





Display messages	Possible causes/consequences and ► Solutions
<p>PARK (USA only)  (Canada only)</p> <p>Parking Brake Inoperative</p>	<p>The yellow  warning lamp lights up. The red PARK (USA only) /  (Canada only) indicator lamp flashes for about ten seconds after the electric parking brake has been applied or released. It then goes out or remains lit.</p> <p>The electric parking brake is malfunctioning, e.g. because of overvoltage or undervoltage.</p> <ul style="list-style-type: none"> ► Remove the cause for the overvoltage or undervoltage, e.g. by charging the battery or restarting the engine. ► Engage or release the electric parking brake. <p>If it remains impossible to apply or release the electric parking brake:</p> <ul style="list-style-type: none"> ► Switch off the ignition and turn it back on. ► Engage or release the electric parking brake. <p>If the electric parking brake still cannot be released:</p> <ul style="list-style-type: none"> ► Consult a qualified specialist workshop. <p>The display message is only shown while the vehicle is in motion. The yellow  warning lamp lights up and the red PARK (USA only) /  (Canada only) indicator lamp flashes.</p> <p>It is not possible to apply the electric parking brake manually.</p> <ul style="list-style-type: none"> ► Vehicles with manual transmission: engage first gear. ► Vehicles with automatic transmission: shift the transmission to P. ► Visit a qualified specialist workshop.
<p>PARK (USA only)  (Canada only)</p> <p>Turn On The Ignition to Release the Parking Brake</p>	<p>The red PARK (USA only) /  (Canada only) indicator lamp lights up.</p> <p>You attempted to release the electric parking brake while the ignition was switched off.</p> <ul style="list-style-type: none"> ► SmartKey: turn the SmartKey to position 1 in the ignition lock. ► KEYLESS-GO: switch on the ignition.

Display messages	Possible causes/consequences and ► Solutions
 Brake Immediately	<p>A malfunction has occurred while the HOLD function or DISTRONIC PLUS is active.</p> <p>A tone may also sound at regular intervals. If you attempt to lock the vehicle, the tone becomes louder.</p> <p>You cannot start the engine.</p> <ul style="list-style-type: none"> ► Paying attention to the traffic situation, immediately depress the brake pedal firmly and hold until the display message disappears. ► Secure the vehicle against rolling away (> page 155). You can restart the engine.
 Brake Immediately	<p>A malfunction has occurred while the HOLD function or DISTRONIC PLUS is active.</p> <p>A tone may also sound at regular intervals. If you attempt to lock the vehicle, the tone becomes louder.</p> <p>You cannot start the engine.</p> <ul style="list-style-type: none"> ► Paying attention to the traffic situation, immediately depress the brake pedal firmly and hold until the display message disappears. ► Prevent the vehicle from rolling away before you leave it (> page 331). You can restart the engine.
 Check Brake Fluid Level	<p>There is not enough brake fluid in the brake fluid reservoir.</p> <p>In addition, the  (USA only)/ (Canada only) warning lamp lights up in the instrument cluster and a warning tone sounds.</p> <p> WARNING</p> <p>The braking effect may be impaired.</p> <p>There is a risk of an accident.</p> <ul style="list-style-type: none"> ► Pull over and stop the vehicle safely as soon as possible, paying attention to road and traffic conditions. Do not continue driving under any circumstances. ► Secure the vehicle against rolling away (> page 155). ► Consult a qualified specialist workshop. ► Do not add brake fluid. This does not correct the malfunction.
 Check Brake Pad Wear	<p>The brake pads/linings have reached their wear limit.</p> <ul style="list-style-type: none"> ► Visit a qualified specialist workshop.

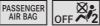
Display messages	Possible causes/consequences and ► Solutions
 mbrace Inoperative	<p>One or more main features of the mbrace system are malfunctioning.</p> <ul style="list-style-type: none"> ► Have the mbrace system checked immediately at a qualified specialist workshop.
PRE-SAFE Inoperative See Operator's Manual	<p>Important functions of PRE-SAFE® have failed. All other occupant safety systems, e.g. air bags, remain available.</p> <ul style="list-style-type: none"> ► Visit a qualified specialist workshop immediately.
PRE-SAFE Functions Currently Limited See Operator's Manual	<p>PRE-SAFE® Brake is deactivated or temporarily inoperative. Possible causes are:</p> <ul style="list-style-type: none"> • function is impaired due to heavy rain or snow. • the sensors in the radiator grill and the bumper are dirty. • the radar sensor system is temporarily inoperative, e.g. due to electromagnetic radiation emitted by nearby TV or radio stations or other sources of electromagnetic radiation. • AMG vehicles: ESP® is deactivated. • the system is outside the operating temperature range. • the on-board voltage is too low. <p>When the causes stated above no longer apply, the display message disappears. <i>تلفن شبانه روزی: ۸۵</i></p> <p>PRE-SAFE® Brake is operational again.</p> <ul style="list-style-type: none"> ► Pull over and stop the vehicle safely as soon as possible, paying attention to road and traffic conditions. ► Secure the vehicle against rolling away (► page 155). ► Clean the sensors in the radiator grill and the bumper (► page 285). ► Restart the engine. ► AMG vehicles: reactivate ESP® (► page 63).
PRE-SAFE Functions Limited See Operator's Manual	<p>PRE-SAFE® Brake is inoperative due to a malfunction. BAS PLUS or the distance warning signal may also have failed.</p> <ul style="list-style-type: none"> ► Visit a qualified specialist workshop.

Display messages	Possible causes/consequences and ► Solutions
 <p>SRS Malfunction Service Required</p>	<p>There is a malfunction in the SRS (Supplemental Restraint System). The  warning lamp also lights up in the instrument cluster.</p> <p>⚠ WARNING</p> <p>The air bags or Emergency Tensioning Devices may either be triggered unintentionally or, in the event of an accident, may not be triggered.</p> <p>There is an increased risk of injury.</p> <p>► Visit a qualified specialist workshop.</p> <p>For further information about the Supplemental Restraint System, see (► page 39).</p>
 <p>Front Left Malfunction Service Required or Front Right Malfunction Service Required</p>	<p>SRS has malfunctioned at the front on the left or right. The  warning lamp also lights up in the instrument cluster.</p> <p>⚠ WARNING</p> <p>The air bags or Emergency Tensioning Devices may either be triggered unintentionally or, in the event of an accident, may not be triggered.</p> <p>There is an increased risk of injury.</p> <p>► Visit a qualified specialist workshop.</p>
 <p>Left Side Curtain Airbag Malfunction Service Required or Right Side Curtain Airbag Malfunction Service Required</p>	<p>There is a malfunction in the left-hand or right-hand head bag. The  warning lamp also lights up in the instrument cluster.</p> <p>⚠ WARNING</p> <p>The left or right headbag may either be triggered unintentionally or, in the event of an accident, may not be triggered.</p> <p>There is an increased risk of injury.</p> <p>► Visit a qualified specialist workshop.</p>

Display messages	Possible causes/consequences and ► Solutions
<p>Front Passenger Airbag Enabled See Operator's Manual</p>	<p>The front-passenger air bag and front-passenger knee bag are enabled during the journey, even though:</p> <ul style="list-style-type: none"> • a child, a small adult or an object weighing less than the system's weight threshold is located on the front-passenger seat. or • the front-passenger seat is unoccupied. <p>The system may detect objects or forces applying additional weight on the seat.</p> <p>⚠ WARNING</p> <p>The front-passenger front air bag and front passenger knee bag may be triggered unintentionally. There is an increased risk of injury.</p> <ul style="list-style-type: none"> ► Pull over and stop the vehicle safely as soon as possible, paying attention to road and traffic conditions. ► Secure the vehicle against rolling away (▷ page 155). ► Switch the ignition off. ► Open the front-passenger door. ► Remove the child and the child restraint system from the front-passenger seat. ► Make sure that there are no objects on the seat adding to the weight. <p>The system may otherwise detect the additional weight and interpret the seat occupant's weight as greater than it actually is.</p> <ul style="list-style-type: none"> ► Keep the seat unoccupied, close the front-passenger door and switch on the ignition. ► Observe the  indicator lamp in the center console and the multifunction display and check the following: <p>Seat unoccupied and ignition switched on:</p> <ul style="list-style-type: none"> • the  indicator lamp must light up and remain lit. If the indicator lamp is on, OCS (Occupant Classification System) has disabled the front-passenger air bag and front-passenger knee bag (▷ page 45). • the Front Passenger Airbag Enabled See Operator's Manual or Front Passenger Airbag Disabled See Operator's Manual display message must not be shown in the multifunction display.



Display messages	Possible causes/consequences and ► Solutions
	<ul style="list-style-type: none"> ► Wait for a period of at least 60 seconds until the necessary system checks have been completed. ► Make sure that the display messages do not appear in the multifunction display. <p>If these conditions are fulfilled, the front-passenger seat can be occupied again. Whether the  indicator lamp remains lit or goes out depends on how OCS classifies the occupant.</p> <p>If the conditions are not fulfilled, the system is not operating correctly.</p> <ul style="list-style-type: none"> ► Visit a qualified specialist workshop immediately. <p>For further information about the Occupant Classification System, see (► page 45).</p>
<p>Front Passenger Airbag Disabled See Operator's Manual</p>	<p>The front-passenger air bag and front-passenger knee bag are deactivated during the journey, although:</p> <ul style="list-style-type: none"> • an adult or • a person larger than a certain size is occupying the front-passenger seat. <p>If additional forces are applied to the seat, the system may interpret the occupant's weight as lower than it actually is.</p> <p> WARNING</p> <p>The front-passenger front air bag and front passenger knee bag may not be triggered in the event of an accident. There is an increased risk of injury.</p> <ul style="list-style-type: none"> ► Pull over and stop the vehicle safely as soon as possible, paying attention to road and traffic conditions. ► Secure the vehicle against rolling away (► page 155). ► Switch the ignition off. ► Have the occupant get out of the vehicle. ► Keep the seat unoccupied, close the front-passenger door and switch on the ignition. ► Observe the  indicator lamp in the center console and the multifunction display and check the following: <p>Seat unoccupied and ignition switched on:</p> <ul style="list-style-type: none"> • the  indicator lamp must light up and remain lit. If the indicator lamp is on, OCS has disabled the front-passenger air bag and front-passenger knee bag (► page 45). • the Front Passenger Airbag Enabled See Operator's Manual or Front Passenger Airbag Disabled See







Display messages	Possible causes/consequences and ► Solutions
	<p>Operator's Manual display message must not be shown in the multifunction display.</p> <ul style="list-style-type: none"> ► Wait for a period of at least 60 seconds until the necessary system checks have been completed. ► Make sure that the display messages do not appear in the multifunction display. <p>If these conditions are fulfilled, the front-passenger seat can be occupied again. Whether the  indicator lamp remains lit or goes out depends on how OCS classifies the occupant. If the conditions are not fulfilled, the system is not operating correctly.</p> <ul style="list-style-type: none"> ► Visit a qualified specialist workshop immediately. <p>For further information about the Occupant Classification System, see (► page 45).</p>







Lights







i Display messages about LEDs:



This display message will only appear if all LEDs have failed.



Display messages	Possible causes/consequences and ► Solutions
 Check Left Cornering Light or Check Right Cornering Light	<p>The left or right-hand cornering light is defective.</p> <ul style="list-style-type: none"> ► Check whether you are permitted to replace the bulb yourself (► page 113). or ► Visit a qualified specialist workshop.
 Check Left Low Beam or Check Right Low Beam	<p>The left or right-hand low-beam headlamp is defective.</p> <ul style="list-style-type: none"> ► Check whether you are permitted to replace the bulb yourself (► page 113). or ► Visit a qualified specialist workshop.
 Check Rear Left Turn Signal or Check Rear Right Turn Signal	<p>The rear left-hand or rear right-hand turn signal is defective.</p> <ul style="list-style-type: none"> ► Check whether you are permitted to replace the bulb yourself (► page 113). or ► Visit a qualified specialist workshop.





Display messages	Possible causes/consequences and ► Solutions
 <p>Check Front Left Turn Signal or Check Front Right Turn Signal</p>	<p>The front left-hand or front right-hand turn signal is defective.</p> <ul style="list-style-type: none"> ► Check whether you are permitted to replace the bulb yourself (▷ page 113). <p>or</p> <ul style="list-style-type: none"> ► Visit a qualified specialist workshop.
 <p>Check Left Mirror Turn Signal or Check Right Mirror Turn Signal</p>	<p>The turn signal in the left-hand or right-hand exterior mirror is defective.</p> <ul style="list-style-type: none"> ► Check whether you are permitted to replace the bulb yourself (▷ page 113). <p>or</p> <ul style="list-style-type: none"> ► Visit a qualified specialist workshop.
 <p>Check Center Brake Lamp</p>	<p>The high-mounted brake lamp is faulty.</p> <ul style="list-style-type: none"> ► Check whether you are permitted to replace the bulb yourself (▷ page 113). <p>or</p> <ul style="list-style-type: none"> ► Visit a qualified specialist workshop.
 <p>Check Left Brake Lamp or Check Right Brake Lamp</p>	<p>The left or right-hand brake lamp is defective.</p> <ul style="list-style-type: none"> ► Check whether you are permitted to replace the bulb yourself (▷ page 113). <p>or</p> <ul style="list-style-type: none"> ► Visit a qualified specialist workshop.
 <p>Check Left Tail and Brake Lamps or Check Right Tail and Brake Lamps</p>	<p>The left or right-hand tail lamp/brake lamp is defective.</p> <ul style="list-style-type: none"> ► Check whether you are permitted to replace the bulb yourself (▷ page 113). <p>or</p> <ul style="list-style-type: none"> ► Visit a qualified specialist workshop.
 <p>Check Left High Beam or Check Right High Beam</p>	<p>The left or right-hand high beam is defective.</p> <ul style="list-style-type: none"> ► Check whether you are permitted to replace the bulb yourself (▷ page 113). <p>or</p> <ul style="list-style-type: none"> ► Visit a qualified specialist workshop.

Display messages	Possible causes/consequences and ► Solutions
 <p>License Plate Lamp</p>	<p>The left or right-hand license plate lamp is defective.</p> <ul style="list-style-type: none"> ► Check whether you are permitted to replace the bulb yourself (▷ page 113). <p>or</p> <ul style="list-style-type: none"> ► Visit a qualified specialist workshop.
 <p>Check Left Fog Lamp or Check Right Fog Lamp</p>	<p>The left-hand or right-hand front fog lamp is defective.</p> <ul style="list-style-type: none"> ► Check whether you are permitted to replace the bulb yourself (▷ page 113). <p>or</p> <ul style="list-style-type: none"> ► Visit a qualified specialist workshop.
 <p>Rear Fog Lamp</p>	<p>The rear fog lamp is defective.</p> <ul style="list-style-type: none"> ► Check whether you are permitted to replace the bulb yourself (▷ page 113). <p>or</p> <ul style="list-style-type: none"> ► Visit a qualified specialist workshop.
 <p>Check Front Left Parking Lamp or Check Front Right Parking Lamp</p>	<p>The front left or front right parking or standing lamp is defective.</p> <ul style="list-style-type: none"> ► Check whether you are permitted to replace the bulb yourself (▷ page 113). <p>or</p> <ul style="list-style-type: none"> ► Visit a qualified specialist workshop.
 <p>Backup Light</p>	<p>The backup lamp is defective.</p> <ul style="list-style-type: none"> ► Check whether you are permitted to replace the bulb yourself (▷ page 113). <p>or</p> <ul style="list-style-type: none"> ► Visit a qualified specialist workshop.
 <p>Check Front Left Sidemarker Lamp or Check Front Right Sidemarker Lamp</p>	<p>The left or right front side marker lamp is defective.</p> <ul style="list-style-type: none"> ► Check whether you are permitted to replace the bulb yourself (▷ page 113). <p>or</p> <ul style="list-style-type: none"> ► Visit a qualified specialist workshop.



Display messages	Possible causes/consequences and ► Solutions
 <p>Check Rear Left Sidemarkers Lamp or Check Rear Right Sidemarkers Lamp</p>	<p>The rear left or right side marker lamp is defective.</p> <ul style="list-style-type: none"> ► Check whether you are permitted to replace the bulb yourself (▷ page 113). <p>or</p> <ul style="list-style-type: none"> ► Visit a qualified specialist workshop.
 <p>Check Left Daytime Running Light or Check Right Daytime Running Light</p>	<p>The left-hand or right-hand daytime running lamp is faulty.</p> <ul style="list-style-type: none"> ► Check whether you are permitted to replace the bulb yourself (▷ page 113). <p>or</p> <ul style="list-style-type: none"> ► Visit a qualified specialist workshop.
 <p>Active Light System Inoperative</p>	<p>The active light function is defective.</p> <ul style="list-style-type: none"> ► Visit a qualified specialist workshop.
 <p>Malfunction See Operator's Manual</p>	<p>The exterior lighting is defective.</p> <ul style="list-style-type: none"> ► Visit a qualified specialist workshop.
 <p>Auto Lamp Function Inoperative</p>	<p>The light sensor is defective.</p> <ul style="list-style-type: none"> ► Visit a qualified specialist workshop.
 <p>Switch Off Lights</p>	<p>The lights are still switched on when you leave the vehicle. A warning tone also sounds.</p> <ul style="list-style-type: none"> ► Turn the light switch to AUTO.
<p>Adaptive Highbeam Assist Inoperative</p>	<p>Adaptive Highbeam Assist is faulty.</p> <ul style="list-style-type: none"> ► Visit a qualified specialist workshop.
<p>Adaptive Highbeam Assist Currently Unavailable See Operator's Manual</p>	<p>Adaptive Highbeam Assist is deactivated and temporarily inoperative. Possible causes are:</p> <ul style="list-style-type: none"> • the windshield in the camera's field of vision is dirty. • visibility is impaired due to heavy rain, snow or fog. <p>► Clean the windshield.</p> <p>If the system detects that the camera is fully operational again, the Adaptive Highbeam Assist Now Available message is displayed.</p> <p>Adaptive Highbeam Assist is operational again.</p>

Engine	
Display messages	Possible causes/consequences and ► Solutions
 <p>Check Coolant Level See Operator's Manual</p>	<p>The coolant level is too low.</p> <ul style="list-style-type: none"> ❗ Avoid making long journeys with too little coolant in the engine cooling system. The engine will otherwise be damaged. ► Add coolant, observing the warning notes before doing so (▷ page 279). ► If coolant needs to be added more often than usual, have the engine coolant system checked at a qualified specialist workshop.
	<p>The fan motor is faulty.</p> <ul style="list-style-type: none"> ► At coolant temperatures below 248 °F (120 °C), drive to the next qualified specialist workshop. ► Avoid subjecting the engine to heavy loads, e.g. driving in mountainous terrain, and stop-and-go traffic.
 <p>Coolant Too Hot Stop Vehicle Turn Engine Off</p>	<p>The coolant is too hot. A warning tone also sounds.</p> <p>⚠ WARNING</p> <p>Do not drive when your engine is overheated. This can cause some fluids which may have leaked into the engine compartment to catch fire.</p> <p>Steam from the overheated engine can also cause serious burns which can occur just by opening the hood.</p> <p>There is a risk of injury.</p> <ul style="list-style-type: none"> ► Pull over and stop the vehicle safely and switch off the engine, paying attention to road and traffic conditions. ► Secure the vehicle against rolling away (▷ page 155). ► Leave the vehicle and keep a safe distance from the vehicle until the engine has cooled down. ► Make sure that the air supply to the engine radiator is not blocked, e.g. by snow, slush or ice. ► Do not start the engine again until the display message goes out and the coolant temperature is below 248 °F (120 °C). Otherwise, the engine could be damaged. ► Pay attention to the coolant temperature display. ► If the temperature increases again, visit a qualified specialist workshop immediately. <p>Under normal operating conditions and with the specified coolant level, the coolant temperature may rise to 248 °F (120 °C).</p>



Display messages	Possible causes/consequences and ► Solutions
	<p>The battery is not being charged. A warning tone also sounds.</p> <p>Possible causes are:</p> <ul style="list-style-type: none"> • a defective alternator • a torn poly-V-belt • a malfunction in the electronics <p>► Pull over and stop the vehicle safely and switch off the engine, paying attention to road and traffic conditions.</p> <p>► Secure the vehicle against rolling away (> page 155).</p> <p>► Open the hood.</p> <p>► Check whether the poly-V-belt is torn.</p> <p>If the poly-V-belt is torn:</p> <p>! Do not continue driving. The engine could otherwise overheat.</p> <p>► Consult a qualified specialist workshop.</p> <p>If the poly-V-belt is not damaged:</p> <p>► Visit a qualified specialist workshop.</p>
 <p>Check Engine Oil At Next Refueling</p>	<p>The engine oil level has dropped to the minimum level. A warning tone also sounds.</p> <p>► Check the oil level when next refueling, at the latest (> page 278).</p> <p>► If necessary, add engine oil (> page 278).</p> <p>► Have the engine checked at a qualified specialist workshop if engine oil needs to be added more often than usual.</p> <p>! Avoid long journeys with too little engine oil. The engine will otherwise be damaged.</p> <p>Information on approved engine oils can be obtained from any qualified specialist workshop or on the Internet at http://www.mbusa.com (USA only).</p>

Display messages	Possible causes/consequences and ► Solutions
 <p>Check Engine Oil Level (Add 1 quart)</p>	<p>AMG vehicles: the engine oil level is too low.</p> <ul style="list-style-type: none"> ► Check the oil level when next refueling, at the latest (► page 278). ► If necessary, add engine oil (► page 278). ► Have the engine checked at a qualified specialist workshop if engine oil needs to be added more often than usual. <p>! Avoid long journeys with too little engine oil. The engine will otherwise be damaged.</p> <p>Information on approved engine oils can be obtained from any qualified specialist workshop or on the Internet at http://www.mbusa.com (USA only).</p>
 <p>Fuel Level Low</p>	<p>The fuel level has dropped into the reserve range.</p> <ul style="list-style-type: none"> ► Refuel at the nearest gas station.
	<p>There is only a very small amount of fuel in the fuel tank.</p> <ul style="list-style-type: none"> ► Refuel at the nearest gas station without fail.
 <p>Gas Cap Loose</p>	<p>The fuel system pressure is too low. The fuel filler cap is not closed correctly or the fuel system is leaking.</p> <ul style="list-style-type: none"> ► Check that the fuel filler cap is correctly closed. <p>If the fuel filler cap is not correctly closed:</p> <ul style="list-style-type: none"> ► Close the fuel filler cap. <p>If the fuel filler cap is correctly closed:</p> <ul style="list-style-type: none"> ► Visit a qualified specialist workshop.

Driving systems

Display messages	Possible causes/consequences and ► Solutions
 <p>Attention Assist: Take a Break!</p>	<p>Based on certain criteria, ATTENTION ASSIST has detected fatigue or a lack of concentration on the part of the driver. A warning tone also sounds.</p> <ul style="list-style-type: none"> ► If necessary, take a break. <p>During long journeys, take regular breaks in good time so you get enough rest.</p>
 <p>Attention Assist Inoperative</p>	<p>ATTENTION ASSIST is inoperative.</p> <ul style="list-style-type: none"> ► Visit a qualified specialist workshop.

Display messages	Possible causes/consequences and ► Solutions
<div style="border: 1px solid black; padding: 2px; display: inline-block; margin-bottom: 5px;">HOLD</div> Off	<p>The HOLD function is deactivated. the vehicle is skidding. A warning tone also sounds.</p> <p>► Reactivate the HOLD function later (▷ page 176).</p>
Radar Sensors Deactivated See Operator's Manual	<p>The radar sensor system is deactivated.</p> <p>► Switch on the radar sensor system (▷ page 206).</p>
Lane Keeping Assist Currently Unavailable See Operator's Manual	<p>Lane Keeping Assist is deactivated and temporarily inoperative. Possible causes are:</p> <ul style="list-style-type: none"> • the windshield in the camera's field of vision is dirty. • visibility is impaired due to heavy rain, snow or fog. • there are no lane markings for a longer period. • the lane markings are worn, dark or covered, e.g. by dirt or snow. <p>When the causes stated above no longer apply, the display message disappears.</p> <p>Lane Keeping Assist is operational again.</p> <p>If the display message does not disappear:</p> <p>► Pull over and stop the vehicle safely as soon as possible, paying attention to road and traffic conditions.</p> <p>► Secure the vehicle against rolling away (▷ page 155).</p> <p>► Clean the windshield.</p>
Lane Keeping Assist Inoperative	<p>Lane Keeping Assist is faulty.</p> <p>► Visit a qualified specialist workshop.</p>

Display messages	Possible causes/consequences and ► Solutions
<p>Blind Spot Assist Currently Unavailable See Operator's Manual</p>	<p>Blind Spot Assist is temporarily inoperative. Possible causes are:</p> <ul style="list-style-type: none"> • the sensors are dirty. • function is impaired due to heavy rain or snow. • the radar sensor system is outside the operating temperature range. • the radar sensor system is temporarily inoperative, e.g. due to electromagnetic radiation emitted by nearby TV or radio stations or other sources of electromagnetic radiation. <p>The yellow  indicator lamps also light up in the exterior mirrors.</p> <p>When the causes stated above no longer apply, the display message disappears.</p> <p>Blind Spot Assist is operational again.</p> <p>If the display message does not disappear:</p> <ul style="list-style-type: none"> ► Pull over and stop the vehicle safely as soon as possible, paying attention to road and traffic conditions. ► Secure the vehicle against rolling away (▷ page 155). ► Clean the sensors (▷ page 285). ► Restart the engine.
<p>Blind Spot Assist Inoperative</p>	<p>Blind Spot Assist is defective. تلفن شبانه روز: ۰۲۱ ۸۸۶۷۰۸۸</p> <p>The yellow  indicator lamps also light up in the exterior mirrors.</p> <ul style="list-style-type: none"> ► Visit a qualified specialist workshop.
<p>Parking Guidance Inoperative</p>	<p>Parking Guidance is malfunctioning (▷ page 181).</p> <ul style="list-style-type: none"> ► Restart the engine. <p>If the display message continues to be displayed:</p> <ul style="list-style-type: none"> ► Visit a qualified specialist workshop.

Display messages	Possible causes/consequences and ► Solutions
Parking Guidance Canceled	<p>Parking Guidance is deactivated. Possible causes are:</p> <ul style="list-style-type: none"> • the vehicle is skidding. • the sensors are dirty. • a malfunction has occurred. <p>A warning tone also sounds.</p> <p>► Reactivate Parking Guidance later (▷ page 181).</p> <p>If the parking space symbol does not appear in the multifunction display at speeds below 19 mph (30 km/h):</p> <ul style="list-style-type: none"> ► Clean the sensors (▷ page 285). ► Restart the engine. <p>If the parking space symbol still does not appear in the multifunction display at speeds below 19 mph (30 km/h):</p> <ul style="list-style-type: none"> ► Visit a qualified specialist workshop. <p>Parking Guidance has been deactivated because you are no longer following the recommended path.</p> <ul style="list-style-type: none"> ► Park again and, while doing so, observe the display messages in the multifunction display.
Parking Guidance Finished	<p>The vehicle is parked. A warning tone also sounds. The display message disappears automatically.</p>
DISTRONIC PLUS Off	<p>DISTRONIC PLUS has been deactivated (▷ page 166). If it was deactivated automatically, a warning tone also sounds.</p>
DISTRONIC PLUS Now Available	<p>DISTRONIC PLUS is operational again after having been temporarily unavailable. You can now reactivate DISTRONIC PLUS (▷ page 166).</p>

Display messages	Possible causes/consequences and ► Solutions
<p>DISTRONIC PLUS Currently Unavailable See Operator's Manual</p>	<p>DISTRONIC PLUS is temporarily inoperative. Possible causes are:</p> <ul style="list-style-type: none"> • function is impaired due to heavy rain or snow. • the sensors in the radiator grill and the bumper are dirty. • the radar sensor system is temporarily inoperative, e.g. due to electromagnetic radiation emitted by nearby TV or radio stations or other sources of electromagnetic radiation. • the system is outside the operating temperature range. • the on-board voltage is too low. <p>A warning tone also sounds.</p> <p>When the causes stated above no longer apply, the display message disappears.</p> <p>DISTRONIC is operational again.</p> <p>If the display message does not disappear:</p> <ul style="list-style-type: none"> ► Pull over and stop the vehicle safely as soon as possible, paying attention to road and traffic conditions. ► Secure the vehicle against rolling away (▷ page 155). ► Clean the sensors in the radiator grill and the bumper (▷ page 285). ► Restart the engine.
<p>DISTRONIC PLUS Inoperative</p>	<p>DISTRONIC PLUS is defective.</p> <p>BAS PLUS (Brake Assist PLUS) and PRE-SAFE® Brake may be inoperative as well.</p> <p>A warning tone also sounds.</p> <ul style="list-style-type: none"> ► Visit a qualified specialist workshop.
<p>DISTRONIC PLUS Inactive</p>	<p>You have depressed the accelerator pedal. DISTRONIC PLUS is no longer controlling the speed of the vehicle.</p> <ul style="list-style-type: none"> ► Remove your foot from the accelerator pedal.
<p>DISTRONIC PLUS --- mph</p>	<p>An activation condition for DISTRONIC PLUS is not fulfilled.</p> <ul style="list-style-type: none"> ► Check the activation conditions for DISTRONIC PLUS (▷ page 166).



Display messages	Possible causes/consequences and ► Solutions
Cruise Control Inoperative	Cruise control is defective. A warning tone also sounds. ► Visit a qualified specialist workshop.
Cruise Control --- mph	A condition for activating cruise control has not been fulfilled. You have tried to store a speed below 20 mph (30 km/h), for example. ► If conditions permit, drive faster than 20 mph (30 km/h) and store the speed. ► Check the activation conditions for cruise control (► page 163).

امداد خودرو فارما



تلفن شبانه روزی: ۰۲۱-۸۸۸۶۲۰۸۵

FarmaSOS.com

Tires	
Display messages	Possible causes/consequences and ► Solutions
Tire Pressure Check Tires	<p>The tire pressure loss warning system has detected a significant loss in pressure.</p> <p>A warning tone also sounds.</p> <p> WARNING</p> <p>With tire pressures which are too low, there is a risk of the following hazards:</p> <ul style="list-style-type: none"> • they may burst, especially as the load and vehicle speed increase. • they may wear excessively and/or unevenly, which may greatly impair tire traction. • the driving characteristics, as well as steering and braking, may be greatly impaired. <p>There is a risk of an accident.</p> <ul style="list-style-type: none"> ► Stop the vehicle without making any sudden steering or braking maneuvers. Pay attention to the traffic conditions as you do so. ► Secure the vehicle against rolling away (► page 155). ► If there is a flat tire, inspect the tires (► page 291). ► Check the tire pressures and, if necessary, correct the tire pressure. ► Restart the tire pressure loss warning system when the tire pressure is correct (► page 315).
Check Tire Pressure Then Restart Run Flat Indicator	<p>The tire pressure loss warning system generated a display message and has not been restarted since.</p> <ul style="list-style-type: none"> ► Set the correct tire pressure in all four tires. ► Restart the tire pressure loss warning system (► page 315).
Run Flat Indicator Inoperative	<p>The tire pressure loss warning system is faulty.</p> <ul style="list-style-type: none"> ► Visit a qualified specialist workshop.
Tire pressure will be displayed after driving a few minutes	<p>The tire pressure monitor is measuring the tire pressure.</p> <ul style="list-style-type: none"> ► Drive on. <p>The tire pressures appear in the multifunction display after you have been driving for a few minutes.</p>
Tire Press. Monitor Inoperative	<p>The tire pressure monitor is faulty.</p> <ul style="list-style-type: none"> ► Visit a qualified specialist workshop.

Display messages	Possible causes/consequences and ► Solutions
Tire Pressure Monitor Inoperative No Wheel Sensors	<p>The wheels mounted do not have a suitable tire pressure sensor. The tire pressure monitor is deactivated.</p> <ul style="list-style-type: none"> ► Mount wheels with suitable tire pressure sensors. The tire pressure monitor is activated automatically after driving for a few minutes.
Check Tires	<p>The tire pressure in one or more tires has dropped significantly. The wheel position is displayed in the multifunction display. A warning tone also sounds.</p> <p> WARNING</p> <p>With tire pressures which are too low, there is a risk of the following hazards:</p> <ul style="list-style-type: none"> • they may burst, especially as the load and vehicle speed increase. • they may wear excessively and/or unevenly, which may greatly impair tire traction. • the driving characteristics, as well as steering and braking, may be greatly impaired. <p>There is a risk of an accident.</p> <ul style="list-style-type: none"> ► Stop the vehicle without making any sudden steering or braking maneuvers. Pay attention to the traffic conditions as you do so. ► Secure the vehicle against rolling away (► page 155). ► If there is a flat tire, inspect the tires (► page 291). ► Check the tire pressure (► page 316). ► If necessary, correct the tire pressure.
Warning Tire Malfunction	<p>The tire pressure in one or more tires has dropped suddenly. The wheel position is shown in the multifunction display.</p> <p> WARNING</p> <p>If you drive with a flat tire, there is a risk of the following hazards:</p> <ul style="list-style-type: none"> • A flat tire affects the ability to steer or brake the vehicle. • You could lose control of the vehicle. • Continued driving with a flat tire will cause excessive heat build-up and possibly a fire. <p>There is a risk of an accident.</p> <ul style="list-style-type: none"> ► Stop the vehicle without making any sudden steering or braking maneuvers. Pay attention to the traffic conditions as you do so. ► Secure the vehicle against rolling away (► page 155). ► If there is a flat tire, inspect the tires (► page 291).







Display messages	Possible causes/consequences and ► Solutions
Correct Tire Pressure	<p>The tire pressure is too low in at least one of the tires, or the tire pressure difference between the wheels is too great.</p> <ul style="list-style-type: none"> ► Check the tire pressures at the next opportunity (▷ page 316). ► If necessary, correct the tire pressure. ► Restart the tire pressure monitor (▷ page 318).
TirePress. Sensor(s) Missing	<p>There is no signal from the tire pressure sensor of one or several wheels. The pressure of the affected tire is not displayed in the multifunction display.</p> <ul style="list-style-type: none"> ► Have the faulty tire pressure sensor replaced at a qualified specialist workshop.
Tire Press. Monitor Currently Unavailable	<p>Due to a source of radio interference, no signals can be received from the wheel sensors. The tire pressure monitor is temporarily malfunctioning.</p> <ul style="list-style-type: none"> ► Drive on. The tire pressure monitor restarts automatically as soon as the problem has been solved.
 Tire Pressure Warning Tire Failure	<p>The tire pressure in one or more tires has dropped suddenly. A warning tone also sounds.</p> <p>⚠ WARNING تلفن شبانه روزی: ۰۸۵ ۰۴۲۰۸۵</p> <p>If you drive with a flat tire, there is a risk of the following hazards:</p> <ul style="list-style-type: none"> • A flat tire affects the ability to steer or brake the vehicle. • You could lose control of the vehicle. • Continued driving with a flat tire will cause excessive heat build-up and possibly a fire. <p>There is a risk of an accident.</p> <ul style="list-style-type: none"> ► Stop the vehicle without making any sudden steering or braking maneuvers. Pay attention to the traffic conditions as you do so. ► Secure the vehicle against rolling away (▷ page 155). ► If there is a flat tire, inspect the tires (▷ page 291).





Display messages	Possible causes/consequences and ► Solutions
 <p>Check Tire Pressure</p>	<p>The tire pressure in one or more tires has dropped significantly.</p> <p> WARNING</p> <p>With tire pressures which are too low, there is a risk of the following hazards:</p> <ul style="list-style-type: none"> • they may burst, especially as the load and vehicle speed increase. • they may wear excessively and/or unevenly, which may greatly impair tire traction. • the driving characteristics, as well as steering and braking, may be greatly impaired. <p>There is a risk of an accident.</p> <ul style="list-style-type: none"> ► Stop the vehicle without making any sudden steering or braking maneuvers. Pay attention to the traffic conditions as you do so. ► Secure the vehicle against rolling away (► page 155). ► If there is a flat tire, inspect the tires (► page 291). ► Check the tire pressure (► page 316). ► If necessary, correct the tire pressure.
 <p>Correct Tire Pressure</p>	<p>The tire pressure is too low in at least one of the tires, or the tire pressure difference between the wheels is too great.</p> <ul style="list-style-type: none"> ► Check the tire pressures at the next opportunity (► page 316). ► If necessary, correct the tire pressure.

FarmaSOS.com



Vehicle	
Display messages	Possible causes/consequences and ► Solutions
<p>Shift to 'P' or 'N' to Start Engine</p>	<p>You have attempted to start the engine with the transmission in position R or D.</p> <ul style="list-style-type: none"> ► Shift the transmission to position P or N.
<p>Shift to 'P'</p>	<p>You have switched off the engine with the Start/Stop button and opened the driver's door.</p> <p>You wanted to lock the vehicle.</p> <p>A warning tone also sounds.</p> <p>or</p> <p>You have turned off the engine with the Start/Stop button and opened the driver's door while the transmission was in position N.</p> <ul style="list-style-type: none"> ► Shift the transmission to position P.







Display messages	Possible causes/consequences and ► Solutions
	<p>While the HOLD function or DISTRONIC PLUS is active, you have:</p> <ul style="list-style-type: none"> • opened the driver's door and released the seat belt or • switched off the engine or • opened the hood <p>A tone may also sound at regular intervals. If you attempt to lock the vehicle, the tone becomes louder.</p> <p>You cannot start the engine.</p> <p>► Shift the transmission to position P. You can restart the engine.</p>
<p>Auxiliary Battery Malfunction</p>	<p>The auxiliary battery for the automatic transmission is no longer being charged.</p> <p>► Visit a qualified specialist workshop at the next opportunity.</p> <p>► Until then, set the automatic transmission to position P before you switch off the engine.</p> <p>► Before leaving the vehicle, apply the electric parking brake.</p> <p>► Secure the vehicle against rolling away (▷ page 155).</p>
<p>Apply Brake to Shift from 'P'</p>	<p>You have attempted to move the transmission selector lever to position D, R or N without depressing the brake pedal.</p> <p>► Depress the brake pedal. تلفن شبانه روزی: ۰۲۱۸۸۸۸۸۸۸۸۸</p>
<p>Transmission Not in P Risk of Vehicle Rolling Away</p>	<p>The driver's door is open and the transmission is in position R, N or D.</p> <p>A warning tone also sounds.</p> <p>► Shift the transmission to position P.</p> <p>► Secure the vehicle against rolling away (▷ page 155).</p>
<p>Service Required Do Not Shift Gears Visit Dealer</p>	<p>You cannot change the transmission position due to a malfunction. A warning tone also sounds.</p> <p>If transmission position D is selected:</p> <p>► Drive to a qualified specialist workshop without shifting the transmission from position D.</p> <p>If transmission position R, N or P is selected:</p> <p>► Notify a qualified specialist workshop or breakdown service.</p>
<p>Only Shift to 'P' when Vehicle is Stationary</p>	<p>The vehicle is moving.</p> <p>► Pull over and stop the vehicle safely as soon as possible, paying attention to road and traffic conditions.</p> <p>► Shift the transmission to position P.</p>



Display messages	Possible causes/consequences and ► Solutions
	The trunk lid is open. ► Close the trunk lid.
	The hood is open. ⚠ WARNING The open hood may block your view when the vehicle is in motion. There is a risk of an accident. ► Pull over and stop the vehicle safely as soon as possible, paying attention to road and traffic conditions. ► Secure the vehicle against rolling away (▷ page 155). ► Close the hood.
	At least one door is open. A warning tone also sounds. ► Close all the doors.
 Power Steering Malfunction See Operator's Manual	The power steering is malfunctioning. A warning tone also sounds. ⚠ WARNING You will need to use more force to steer. There is a risk of an accident. تلفن شبانه ► Check whether you are able to apply the extra force required. ► If you are able to steer safely: carefully drive on to a qualified specialist workshop. ► If you are unable to steer safely: do not drive on. Contact the nearest qualified specialist workshop.
 Trunk Partition Open	The trunk partition is open. ► Close the trunk partition (▷ page 88).
Phone No Service	Your vehicle is outside the network provider's transmitter/receiver range. ► Wait until the mobile phone operational readiness symbol appears in the multifunction display.
 Decrease Speed	You wanted to open the roof while the vehicle was in motion. ► Pull over and stop the vehicle safely as soon as possible, paying attention to road and traffic conditions. ► Open the roof (▷ page 86).

Display messages	Possible causes/consequences and ► Solutions
 Vario-Roof Lowering	<p>The roof is not fully opened or closed. The hydraulics are depressurized.</p> <ul style="list-style-type: none"> ► Fully open or close the roof (► page 86).
 Open/Close Vario-Roof Completely	<p>The roof is not locked.</p> <ul style="list-style-type: none"> ► Pull over and stop the vehicle safely as soon as possible, paying attention to road and traffic conditions. ► Push or pull the roof switch until the roof is fully open or closed (► page 86).
 Start Engine See Operator's Manual	<p>The on-board voltage is too low.</p> <ul style="list-style-type: none"> ► Start the engine. <p>The roof has been opened and closed several times in a row. The roof drive has been switched off automatically for safety reasons. You can open and close the roof again after approximately ten minutes.</p> <ul style="list-style-type: none"> ► Switch off the ignition and turn it back on. ► Repeat the opening or closing procedure (► page 86).
 Check Washer Fluid	<p>The washer fluid level in the washer fluid reservoir has dropped below the minimum.</p> <ul style="list-style-type: none"> ► Add washer fluid (► page 279).
Wiper Malfunctioning	<p>The windshield wipers are malfunctioning.</p> <ul style="list-style-type: none"> ► Visit a qualified specialist workshop.
Hazard Warning Flashers Malfunctioning	<p>The hazard warning lamps are faulty.</p> <ul style="list-style-type: none"> ► Visit a qualified specialist workshop.

SmartKey

Display messages	Possible causes/consequences and ► Solutions
 Key Does Not Belong to Vehicle	<p>You have put the wrong SmartKey in the ignition lock.</p> <ul style="list-style-type: none"> ► Use the correct SmartKey.
 Take Your Key from Ignition	<p>The SmartKey is in the ignition lock.</p> <ul style="list-style-type: none"> ► Remove the SmartKey.



Display messages	Possible causes/consequences and ► Solutions
 <p>Obtain a New Key</p>	<p>The SmartKey needs to be replaced.</p> <ul style="list-style-type: none"> ► Visit a qualified specialist workshop.
 <p>Replace Key Battery</p>	<p>The batteries of the KEYLESS-GO key are discharged.</p> <ul style="list-style-type: none"> ► Change the batteries (► page 73).
 <p>Don't Forget Your Key</p>	<p>The display message is shown for a maximum of 60 seconds and is only a reminder.</p> <p>You have opened the driver's door with the engine switched off. The KEYLESS-GO key is not in the ignition lock.</p> <ul style="list-style-type: none"> ► Remember to take the KEYLESS-GO key with you when you leave the vehicle.
 <p>Key Not Detected (red display message)</p>	<p>The KEYLESS-GO key is not in the vehicle.</p> <p>A warning tone also sounds.</p> <p>If the engine is switched off, you can no longer lock the vehicle centrally or start the engine.</p> <ul style="list-style-type: none"> ► Pull over and stop the vehicle safely as soon as possible, paying attention to road and traffic conditions. ► Secure the vehicle against rolling away (► page 155). ► Locate the KEYLESS-GO key. <p>The KEYLESS-GO key is not detected while the engine is running because there is interference from a strong source of radio waves.</p> <p>A warning tone also sounds.</p> <ul style="list-style-type: none"> ► Pull over and stop the vehicle safely as soon as possible, paying attention to road and traffic conditions. ► Secure the vehicle against rolling away (► page 155). ► Operate the vehicle with the SmartKey in the ignition lock.
 <p>Key Not Detected (white display message)</p>	<p>The KEYLESS-GO key cannot be detected at present.</p> <ul style="list-style-type: none"> ► Change the location of the SmartKey with the KEYLESS-GO functions in the vehicle. <p>If the KEYLESS-GO key is still not detected:</p> <ul style="list-style-type: none"> ► Operate the vehicle with the SmartKey in the ignition lock.
 <p>Key Detected in Vehicle</p>	<p>The KEYLESS-GO key has been detected inside the vehicle during locking.</p> <ul style="list-style-type: none"> ► Remove the KEYLESS-GO key from the vehicle.

Display messages	Possible causes/consequences and ► Solutions
 <p>Remove Start Button Then Insert Key</p>	<p>The KEYLESS-GO key can continuously not be detected. KEYLESS-GO is temporarily malfunctioning or is defective. A warning tone also sounds.</p> <ul style="list-style-type: none"> ► Insert the SmartKey into the ignition lock and turn it to the desired position. ► Visit a qualified specialist workshop.
 <p>Close Doors to Lock Vehicle</p>	<p>At least one door is open. A warning tone also sounds.</p> <ul style="list-style-type: none"> ► Close all doors and lock the vehicle again.

Warning and indicator lamps

Safety

Seat belts

Problem	Possible causes/consequences and ► Solutions
 <p>After starting the engine, the red seat belt warning lamp lights up for 6 seconds.</p>	<p>The seat belt warning lamp reminds the driver and front passenger to fasten their seat belts.</p> <ul style="list-style-type: none"> ► Fasten your seat belt (► page 53). <small>تلفن ش: ۰۲۱ ۸۸۶۰۰۸۵</small>
 <p>After starting the engine, the red seat belt warning lamp lights up. In addition, a warning tone sounds for up to six seconds.</p>	<p>The driver's seat belt is not fastened.</p> <ul style="list-style-type: none"> ► Fasten your seat belt (► page 53). The warning tone ceases.
 <p>The red seat belt warning lamp lights up after the engine starts, as soon as the driver's or the front-passenger door is closed.</p>	<p>The driver or front passenger has not fastened their seat belt.</p> <ul style="list-style-type: none"> ► Fasten your seat belt (► page 53). The warning lamp goes out. <p>There are objects on the front-passenger seat.</p> <ul style="list-style-type: none"> ► Remove the objects from the front-passenger seat and stow them in a secure place. The warning lamp goes out.





Problem	Possible causes/consequences and ► Solutions
 <p>The red seat belt warning lamp flashes and an intermittent audible warning sounds.</p>	<p>The driver or front passenger has not fastened their seat belt. The car is being driven faster than 15 mph (25 km/h) or has briefly been driven faster than 15 mph (25 km/h).</p> <ul style="list-style-type: none"> ► Fasten your seat belt (► page 53). The warning lamp goes out and the intermittent warning tone ceases. <p>There are objects on the front-passenger seat. The car is being driven faster than 15 mph (25 km/h) or has briefly been driven faster than 15 mph (25 km/h).</p> <ul style="list-style-type: none"> ► Remove the objects from the front-passenger seat and stow them in a secure place. The warning lamp goes out and the intermittent warning tone ceases.



امداد خودرو فارما





تلفن شبانه روزی: ۰۲۱-۸۸۸۶۲۰۸۵





FarmaSOS.com



Safety systems





Problem	Possible causes/consequences and ► Solutions
<p> (USA only)</p> <p> (Canada only)</p> <p>The red brake system warning lamp comes on while the engine is running. A warning tone also sounds.</p>	<p>There is not enough brake fluid in the brake fluid reservoir.</p> <p> WARNING</p> <p>The braking effect may be impaired. There is a risk of an accident.</p> <ul style="list-style-type: none"> ► Pull over and stop the vehicle safely as soon as possible, paying attention to road and traffic conditions. Do not continue driving under any circumstances. ► Secure the vehicle against rolling away (> page 155). ► Do not add brake fluid. Topping up will not remedy the malfunction. ► Consult a qualified specialist workshop. ► Observe the additional display messages in the multifunction display.
<p></p> <p>The yellow ABS warning lamp is lit while the engine is running.</p>	<p>ABS (Anti-lock Brake System) is deactivated due to a malfunction. BAS (Brake Assist), BAS PLUS, ESP® (Electronic Stability Program), PRE-SAFE®, PRE-SAFE® Brake, the HOLD function and hill start assist are therefore also deactivated, for example. ATTENTION ASSIST is deactivated.</p> <p> WARNING</p> <p>The brake system continues to function normally, but without the functions listed above. The wheels could therefore lock if you brake hard, for example.</p> <p>The steerability and braking characteristics may be severely affected. The braking distance in an emergency braking situation can increase.</p> <p>If ESP® is not operational, ESP® is unable to stabilize the vehicle. There is an increased risk of skidding and an accident.</p> <ul style="list-style-type: none"> ► Observe the additional display messages in the multifunction display. ► Drive on carefully. ► Visit a qualified specialist workshop. <p>If the ABS control unit is faulty, there is also a possibility that other systems, such as the navigation system or the automatic transmission, will not be available.</p>





Problem	Possible causes/consequences and ► Solutions
 <p>The yellow ABS warning lamp is lit while the engine is running.</p>	<p>ABS is temporarily unavailable. BAS, BAS PLUS, ESP®, EBD (electronic brake force distribution), PRE-SAFE®, PRE-SAFE® Brake, the HOLD function, hill start assist are therefore also deactivated, for example.</p> <p>Possible causes are:</p> <ul style="list-style-type: none"> • Self-diagnosis is not yet complete. • The on-board voltage may be insufficient. <p>ATTENTION ASSIST is deactivated.</p> <p> WARNING</p> <p>The brake system continues to function normally, but without the functions listed above. The front and rear wheels could therefore lock if you brake hard, for example.</p> <p>The steerability and braking characteristics may be severely affected. The braking distance in an emergency braking situation can increase.</p> <p>If ESP® is not operational, ESP® is unable to stabilize the vehicle. There is a risk of an accident.</p> <ul style="list-style-type: none"> ► Carefully drive a suitable distance, making slight steering movements at a speed above 12 mph (20 km/h). <p>The functions mentioned above are available again when the warning lamp goes out.</p> <p>If the warning lamp is still on:</p> <ul style="list-style-type: none"> ► Observe the additional display messages in the multifunction display. ► Drive on carefully. ► Visit a qualified specialist workshop.



Problem	Possible causes/consequences and ► Solutions
 <p>The yellow ABS warning lamp is lit while the engine is running. A warning tone also sounds.</p>	<p>EBD is not available due to a malfunction. Therefore, ABS, BAS, BAS PLUS, ESP[®], PRE-SAFE[®], PRE-SAFE[®] Brake, the HOLD function and hill start assist are also unavailable, for example. ATTENTION ASSIST is deactivated.</p> <p>⚠ WARNING</p> <p>The brake system continues to function normally, but without the functions listed above. The front and rear wheels could therefore lock if you brake hard, for example.</p> <p>The steerability and braking characteristics may be severely affected. The braking distance in an emergency braking situation can increase.</p> <p>If ESP[®] is not operational, ESP[®] is unable to stabilize the vehicle. There is an increased risk of skidding and an accident.</p> <ul style="list-style-type: none"> ► Observe the additional display messages in the multifunction display. ► Drive on carefully. ► Visit a qualified specialist workshop.
<p>BRAKE (USA only)</p> <p> (Canada only)</p> <p>  </p> <p>The red brake warning lamp, the yellow ESP[®] and ESP[®] OFF warning lamps and the yellow ABS warning lamp are lit while the engine is running.</p>	<p>ABS and ESP[®] are not available due to a malfunction. Therefore, BAS, BAS PLUS, EBD, PRE-SAFE[®], PRE-SAFE[®] Brake, the HOLD function and hill start assist, for example, are not available either. ATTENTION ASSIST is deactivated.</p> <p>⚠ WARNING</p> <p>The brake system continues to function normally, but without the functions listed above. The front and rear wheels could therefore lock if you brake hard, for example.</p> <p>The steerability and braking characteristics may be severely affected. The braking distance in an emergency braking situation can increase.</p> <p>If ESP[®] is not operational, ESP[®] is unable to stabilize the vehicle. There is an increased risk of skidding and an accident.</p> <ul style="list-style-type: none"> ► Observe the additional display messages in the multifunction display. ► Drive on carefully. ► Visit a qualified specialist workshop.

Problem	Possible causes/consequences and ► Solutions
 <p>The yellow ESP[®] warning lamp flashes while the vehicle is in motion.</p>	<p>ESP[®] or traction control has intervened because there is a risk of skidding or at least one wheel has started to spin. Cruise control or DISTRONIC PLUS is deactivated.</p> <ul style="list-style-type: none"> ► When pulling away, only depress the accelerator pedal as far as necessary. ► Ease off the accelerator pedal while the vehicle is in motion. ► Adapt your driving style to suit the road and weather conditions. ► Do not deactivate ESP[®]. <p>For exceptions, see: (► page 61).</p>
 <p>The yellow ESP[®] OFF warning lamp is lit while the engine is running.</p>	<p>ESP[®] is deactivated.</p> <p> WARNING</p> <p>If ESP[®] is switched off, ESP[®] is unable to stabilize the vehicle. There is an increased risk of skidding and an accident.</p> <ul style="list-style-type: none"> ► Reactivate ESP[®]. <p>For exceptions, see: (► page 61).</p> <ul style="list-style-type: none"> ► Adapt your driving style to suit the road and weather conditions. <p>If ESP[®] cannot be activated:</p> <ul style="list-style-type: none"> ► Drive on carefully. ► Have ESP[®] checked at a qualified specialist workshop.
 <p>AMG vehicles only: The yellow SPORT handling mode warning lamp is lit while the engine is running.</p>	<p>SPORT handling mode is activated.</p> <p> WARNING</p> <p>When SPORT handling mode is switched on, ESP[®] is unable to stabilize the vehicle. There is an increased risk of skidding and an accident.</p> <ul style="list-style-type: none"> ► Only switch to SPORT handling mode in accordance with the conditions written in the "Activating/deactivating SPORT handling mode" section (► page 63).

Problem	Possible causes/consequences and ► Solutions
 <p>The yellow ESP[®] and ESP[®] OFF warning lamps are lit while the engine is running.</p>	<p>ESP[®], BAS, BAS PLUS, PRE-SAFE[®], PRE-SAFE[®] Brake, the HOLD function and hill start assist are not available due to a malfunction. ATTENTION ASSIST is deactivated.</p> <p>⚠ WARNING</p> <p>The brake system continues to function normally, but without the functions listed above.</p> <p>The braking distance in an emergency braking situation can thus increase.</p> <p>If ESP[®] is not operational, ESP[®] is unable to stabilize the vehicle. There is an increased risk of skidding and an accident.</p> <ul style="list-style-type: none"> ► Observe the additional display messages in the multifunction display. ► Drive on carefully. ► Visit a qualified specialist workshop.
 <p>The yellow ESP[®] and ESP[®] OFF warning lamps are lit while the engine is running.</p>	<p>ESP[®], BAS, PRE-SAFE[®], the HOLD function and hill start assist are temporarily unavailable.</p> <p>BAS PLUS and PRE-SAFE[®] Brake may also have failed. ATTENTION ASSIST is deactivated. Self-diagnosis is not yet complete.</p> <p>⚠ WARNING</p> <p>The brake system continues to function normally, but without the functions listed above.</p> <p>The braking distance in an emergency braking situation can thus increase.</p> <p>If ESP[®] is not operational, ESP[®] is unable to stabilize the vehicle. There is an increased risk of skidding and an accident.</p> <ul style="list-style-type: none"> ► Carefully drive a suitable distance, making slight steering movements at a speed above 12 mph (20 km/h). The functions mentioned above are available again when the warning lamp goes out. <p>If the warning lamp is still on:</p> <ul style="list-style-type: none"> ► Observe the additional display messages in the multifunction display. ► Drive on carefully. ► Visit a qualified specialist workshop.

Problem	Possible causes/consequences and ► Solutions
<p> (USA only)</p> <p> (Canada only)</p> <p>The red electric parking brake indicator lamp flashes or lights up and/or</p> <p> warning lamp for the electric parking brake lights up.</p>	<p>► Observe the additional display messages in the multifunction display.</p>
<p></p> <p>The red SRS warning lamp is lit while the engine is running.</p>	<p>There is a malfunction in the SRS (Supplemental Restraint System).</p> <p> WARNING</p> <p>The air bags or Emergency Tensioning Devices may either be triggered unintentionally or, in the event of an accident, may not be triggered.</p> <p>There is an increased risk of injury.</p> <p>► Drive on carefully.</p> <p>► Have SRS checked at a qualified specialist workshop immediately.</p> <p>For further information about the Supplemental Restraint System, see (► page 39).</p>

Engine	
Problem	Possible causes/consequences and ► Solutions
 <p>The yellow Check Engine warning lamp lights up while the engine is running.</p>	<p>There may be a malfunction, for example:</p> <ul style="list-style-type: none"> • in the engine management • in the fuel injection system • in the exhaust system • in the ignition system • in the fuel system <p>The emission limit values may be exceeded and the engine may be running in emergency mode.</p> <p>► Have the vehicle checked as soon as possible at a qualified specialist workshop.</p> <p>i In some states, you must immediately visit a qualified specialist workshop as soon as the yellow Check Engine warning lamp lights up. This depends on the locally applicable legal requirements. If in doubt, check whether such legal regulations apply in the state in which you are currently driving.</p>
 <p>The yellow reserve fuel warning lamp lights up while the engine is running.</p>	<p>The fuel level has dropped into the reserve range.</p> <p>► Refuel at the nearest gas station.</p>
 <p>The yellow reserve fuel warning lamp flashes while the vehicle is in motion.</p> <p>In addition, the  Check Engine warning lamp may light up.</p>	<p>The fuel system pressure is too low. The fuel filler cap is not closed correctly or the fuel system is leaking.</p> <p>► Check that the fuel filler cap is correctly closed.</p> <p>► If the fuel filler cap is not correctly closed: close the fuel filler cap.</p> <p>► If the fuel filler cap is closed: visit a qualified specialist workshop.</p>
 <p>The red coolant warning lamp lights up while the engine is running and the coolant temperature gauge is at the start of the scale.</p>	<p>The temperature sensor for the coolant temperature gauge is defective.</p> <p>The coolant temperature is no longer being monitored. There is a risk of engine damage if the coolant temperature is too high.</p> <p>► Pull over and stop the vehicle safely and switch off the engine, paying attention to road and traffic conditions. Do not continue driving under any circumstances.</p> <p>► Secure the vehicle against rolling away (> page 155).</p> <p>► Consult a qualified specialist workshop.</p>





Problem	Possible causes/consequences and ► Solutions
 <p>The red coolant warning lamp comes on while the engine is running.</p>	<p>The coolant level is too low.</p> <p>If the coolant level is correct, the airflow to the engine radiator may be blocked or the electric engine radiator fan may be malfunctioning.</p> <p>The coolant is too hot and the engine is no longer being cooled sufficiently.</p> <ul style="list-style-type: none"> ► Observe the additional display messages in the multifunction display. ► Pull over and stop the vehicle safely and switch off the engine, paying attention to road and traffic conditions. ► Secure the vehicle against rolling away (► page 155). ► Leave the vehicle and keep a safe distance from the vehicle until the engine has cooled down. ► Check the coolant level and add coolant, observing the warning notes (► page 279). ► If you need to add coolant more often than usual, have the engine coolant system checked. ► Make sure that the air supply to the engine radiator is not blocked, e.g. by snow, slush or ice. ► Do not start the engine again until the coolant temperature is below 248 °F (120 °C). Otherwise, the engine could be damaged. ► Drive to the nearest qualified specialist workshop. ► Avoid subjecting the engine to heavy loads, e.g. driving in mountainous terrain, and stop-and-go traffic.
 <p>The red coolant warning lamp comes on while the engine is running. A warning tone also sounds.</p>	<p>The coolant temperature has exceeded 248 °F (120 °C). The airflow to the engine radiator may be blocked or the coolant level may be too low.</p> <p>⚠ WARNING</p> <p>The engine is not being cooled sufficiently and may be damaged. Do not drive when your engine is overheated. This can cause some fluids which may have leaked into the engine compartment to catch fire.</p> <p>Steam from the overheated engine can also cause serious burns which can occur just by opening the hood.</p> <p>There is a risk of injury.</p> <ul style="list-style-type: none"> ► Observe the additional display messages in the multifunction display. ► Pull over and stop the vehicle safely and switch off the engine, paying attention to road and traffic conditions. ► Secure the vehicle against rolling away (► page 155).

Problem	Possible causes/consequences and ► Solutions
	<ul style="list-style-type: none"> ► Leave the vehicle and keep a safe distance from the vehicle until the engine has cooled down. ► Check the coolant level and add coolant, observing the warning notes (▷ page 279). ► If you need to add coolant more often than usual, have the engine coolant system checked. ► Make sure that the air supply to the engine radiator is not blocked, e.g. by snow, slush or ice. ► At coolant temperatures below 248 °F (120 °C), drive to the next qualified specialist workshop. ► Avoid subjecting the engine to heavy loads, e.g. driving in mountainous terrain, and stop-and-go traffic.

Driving systems

Problem	Possible causes/consequences and ► Solutions
 <p>The red distance warning lamp lights up while the vehicle is in motion. A warning tone also sounds.</p>	<p>You are approaching a vehicle or a stationary obstacle in your line of travel at too high a speed.</p> <ul style="list-style-type: none"> ► Be prepared to brake immediately. ► Pay careful attention to the traffic situation. You may have to brake or take evasive action. <p>Further information on DISTRONIC PLUS (▷ page 168). Further information on PRE-SAFE® Brake (▷ page 65).</p>

Tires

Problem	Possible causes/consequences and ► Solutions
 <p>USA only: The yellow tire pressure monitor warning lamp (pressure loss/malfunction) is lit.</p>	<p>The tire pressure monitor has detected a loss of pressure in at least one of the tires.</p> <p> WARNING</p> <p>With tire pressures which are too low, there is a risk of the following hazards:</p> <ul style="list-style-type: none"> • they may burst, especially as the load and vehicle speed increase. • they may wear excessively and/or unevenly, which may greatly impair tire traction. • the driving characteristics, as well as steering and braking, may be greatly impaired. <p>There is a risk of an accident.</p> <ul style="list-style-type: none"> ► Stop the vehicle without making any sudden steering or braking maneuvers. Pay attention to the traffic conditions as you do so. ► Secure the vehicle against rolling away (▷ page 155). ► Observe the additional display messages in the multifunction display. ► If there is a flat tire, inspect the tires (▷ page 291). ► Check the tire pressure (▷ page 316). ► If necessary, correct the tire pressure.
 <p>USA only: The yellow tire pressure monitor warning lamp (pressure loss/malfunction) flashes for approximately one minute and then remains lit.</p>	<p>The tire pressure monitor is faulty.</p> <p> WARNING</p> <p>The system is possibly unable to recognize or register low tire pressure.</p> <p>There is a risk of an accident.</p> <ul style="list-style-type: none"> ► Observe the additional display messages in the multifunction display. ► Visit a qualified specialist workshop.

امداد خودرو فارما

تلفن شبانه روزی: ۰۲۱-۸۸۸۶۲۰۸۵

FarmaSOS.com

Useful information	256
Stowage areas	256
Features	259

امداد خودرو فارما

تلفن شبانه روزی: ۰۲۱-۸۸۸۶۲۰۸۵

FarmaSOS.com

Useful information

- 1** This Operator's Manual describes all models and all standard and optional equipment of your vehicle available at the time of publication of the Operator's Manual. Country-specific differences are possible. Please note that your vehicle may not be equipped with all features described. This also applies to safety-related systems and functions.
- i** Read the information on qualified specialist workshops: (▷ page 23).

Stowage areas

Stowage space

Important safety notes

WARNING

To help avoid personal injury during a collision or sudden maneuver, exercise care when storing objects in the vehicle. Put luggage or cargo in the trunk if possible.

Do not pile luggage or cargo higher than the seat backrests.

Keep compartment lids closed. This will help to prevent stored objects from being thrown about and injuring vehicle occupants during

- braking
- vehicle maneuvers
- an accident

Glove box

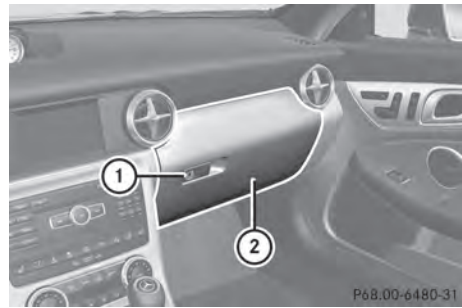

- ▶ **To open:** pull handle ① and open glove box flap ②.
- ▶ **To close:** fold glove box flap ② upwards until it engages.

The glove box flap contains brackets for coins, pens, and credit and service cards.

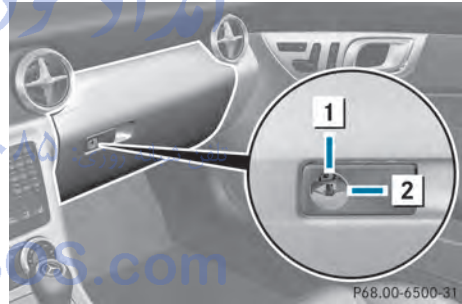

The glove box can be locked and unlocked using the mechanical key.

- ▶ **To lock:** insert the mechanical key into the lock and turn it to position ②.
- ▶ **To unlock:** insert the mechanical key into the lock and turn it to position ①.

Storage compartment/telephone compartment under the armrest

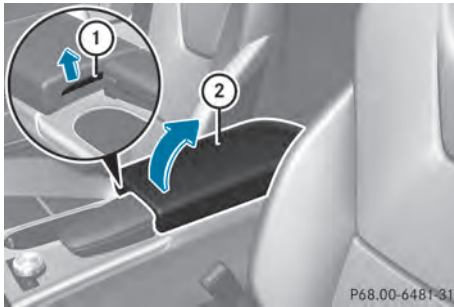

- ▶ **To open:** push button ① up and raise armrest ②.

The storage compartment can be locked and unlocked centrally using the SmartKey (▷ page 71).

① Depending on the vehicle's equipment, a 12 V socket, a USB socket, and an AUX IN connection or Media Interface are installed in the storage compartment. A Media Interface is a universal interface for mobile audio equipment, e.g. for an iPod® or MP3 player (see the separate COMAND Operating Instructions).

Eyeglasses compartment



- ▶ **To open:** press marking ①.

Storage compartment in the center console

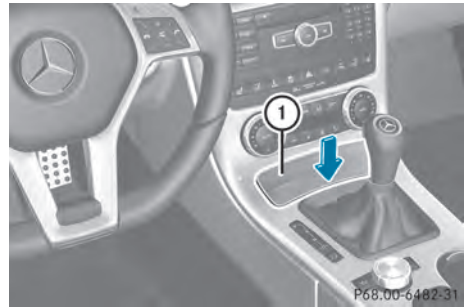

- ▶ **To open:** briefly press the lower section of cover ①.
- ▶ **To remove the insert:** pull the left-hand side of the insert up and out.
- ▶ **To install the insert:** press the insert into the housing.

Depending on the vehicle equipment, there may be an ashtray in the center console instead of a storage compartment.

Storage compartment in the doors

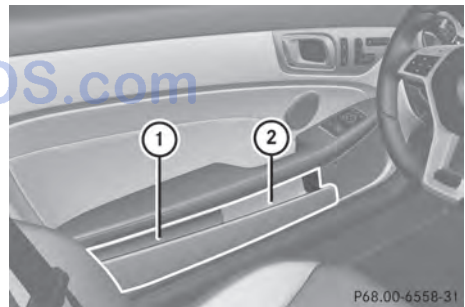

In the door trim, there is a ruffled pocket ② with storage slot ①.

Storage box in the rear wall between the seats

A ruffled pocket is located on the rear wall between the seats.

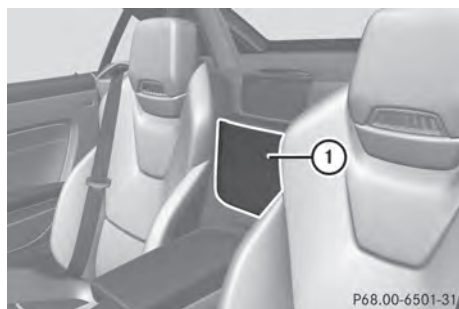

① Ruffled pocket

Stowage net

⚠ WARNING

Stowage nets are only intended for transporting light loads such as road maps, mail, etc.

Do not use stowage nets to transport heavy, bulky, sharp-edged or fragile objects. In an accident, during hard braking or during a change of direction, they could be thrown around inside the vehicle and cause injury to vehicle occupants.

Stowage nets cannot protect the transported loads in the event of an accident.

Stowage nets are located in the front-passenger footwell and on the rear wall behind the driver's seat.

Reversible floor panel in the trunk

Using the flat side of the reversible floor panel will give you a level trunk. If you turn the reversible floor panel over, you can transport objects, for example a drinks crate, on it.

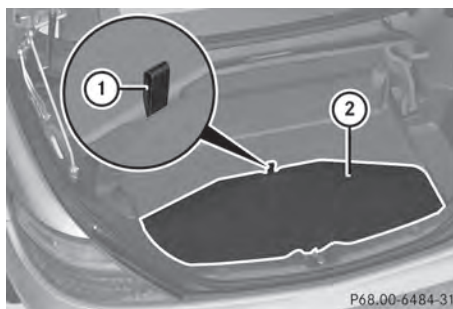

► **To turn over:** pull up reversible floor panel (2) using strap (1).

► Turn over reversible floor panel (2) and re-insert it.

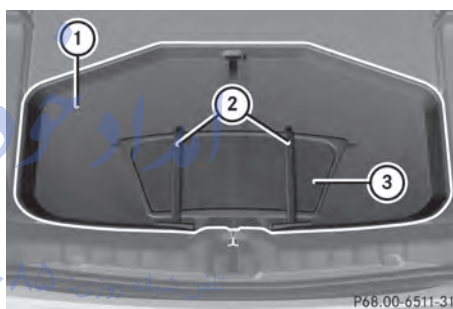

Attached to the reversible floor panel are two flexible straps (2) that you can use to secure objects, for example wind screen (3), when reversible floor panel (1) has been turned over.

Roof carrier

⚠ This vehicle is not designed to transport items on the roof. Roof carriers and other devices which are mounted on the roof that have not been specifically approved for this model by Mercedes-Benz must not be used as they could damage the vehicle and the retractable hardtop (vario-roof).

At the time of going to print, Mercedes-Benz does not offer any roof carrier or other roof-installed devices for this model.

⚠ This vehicle is not designed to transport any items on the trunk lid or to allow

luggage carriers or equipment of any kind to be installed to the trunk lid. Otherwise the vehicle and the retractable hardtop could be damaged.

Features

Cup holders

Important safety notes

WARNING

In order to help prevent spilling liquids on vehicle occupants and/or vehicle equipment, only use containers that fit into the cup holder. Use lids on open containers and do not fill containers to a height where the contents, especially hot liquids, could spill during braking, vehicle maneuvers, or in an accident. Liquids spilled on vehicle occupants may cause serious personal injury. Liquids spilled on vehicle equipment may cause damage not covered by the Mercedes-Benz Limited Warranty.

When not in use, keep the cup holder closed. An open cup holder may cause injury to you or others when contacted during braking, vehicle maneuvers, or in an accident.

Keep in mind that objects placed in the cup holder may come loose during braking, vehicle maneuvers, or in an accident and be thrown around in the vehicle interior. Objects thrown around in the vehicle interior may cause an accident and/or serious personal injury.

Cup holder in the center console

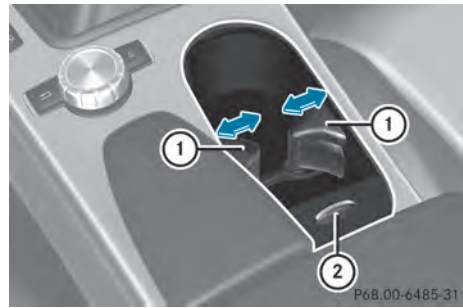

- ▶ **To open:** slide cover ② back.
- ▶ **To remove the insert:** slide catch ① inwards on both sides in the direction of the arrow.
- ▶ Remove the cup holder insert upwards.
- ▶ **To re-install the insert:** place the insert in the stowage space.
- ▶ Slide catch ① outwards in the direction of the arrow until it engages.

You can remove the cup holder insert for cleaning. Clean with clear, lukewarm water only.

Bottle holder

WARNING

Do not transport heavy, sharp-edged, or fragile bottles in the bottle holder.

In the event of an accident, the bottle holder cannot secure a bottle sufficiently. You and/or vehicle occupants could be injured.

- ❗ Make sure that any bottles weighing more than 1.1 lb(0.5 kg) that are stored in the bottle holder, rest on the vehicle floor. The bottle holder could otherwise be damaged.

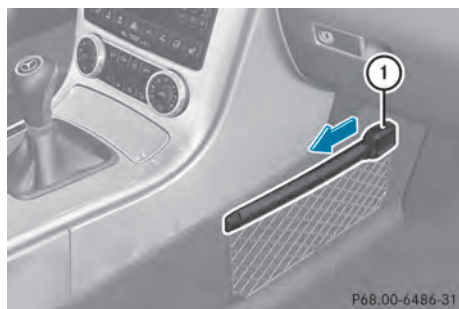

- ▶ Press the outer edge of button ① and slide in the direction of the arrow until the bottle fits into the opening.
- ▶ Insert the bottle into the bottle holder.

The bottle holder is designed for bottles with a capacity of 25 fl. oz. (0.7 l) up to 54 fl. oz. (1.5 l).

The bottle holder does not secure the bottles; it merely prevents them from tipping over.

Sun visors

Overview

WARNING

Do not use the vanity mirror while driving. Keep the vanity mirrors in the sun visors closed while the vehicle is in motion. Reflected glare can endanger you and others.

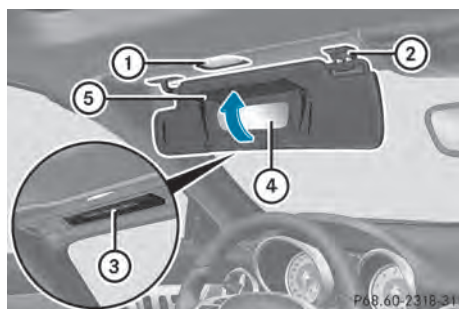

- ① Mirror light
- ② Bracket
- ③ Retaining strip, e.g. for a car park ticket

- ④ Vanity mirror
- ⑤ Mirror cover

i When driving at high speeds with the side window or roof open:

If you have inserted a car park ticket into retaining strip ③, make sure that it is not blown away by the wind.

Vanity mirror in the sun visor

Mirror light ① only functions if the sun visor is clipped into retainer ② and mirror cover ⑤ has been folded up.

Glare from the side

- ▶ Fold down the sun visor.
- ▶ Pull the sun visor out of retainer ②.
- ▶ Swing the sun visor to the side.
- ▶ Slide the sun visor forwards and back as required.

Ashtray



- ▶ **To open:** push the lower section of cover ①. The cover opens.
- ▶ **To remove the insert:** lift insert ③ up ② and out.
- ▶ **To re-install the insert:** press insert ③ into the holder until it engages.

Cigarette lighter

⚠ WARNING

Never touch the heating element or sides of the lighter; they are extremely hot. Hold the knob only.

Make sure any children traveling with you do not injure themselves or start a fire with the hot cigarette lighter.

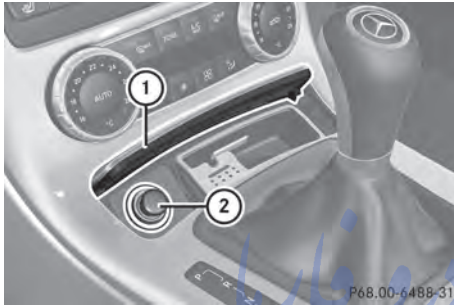

- ▶ Turn the SmartKey to position **2** in the ignition lock (▶ page 135).
- ▶ **To open:** push the lower section of cover **1**.
The ashtray opens.
- ▶ Press in cigarette lighter **2**.
Cigarette lighter **2** will pop out automatically when the heating element is red-hot.

12 V sockets

General notes

! If you are using all sockets in the vehicle, make sure that you do not exceed the maximum current draw of 55 A. Otherwise, you will overload the fuses.

The sockets can be used for accessories with a maximum draw of 180 W (15 A). Accessories include such items as lamps or chargers for mobile phones.

- ▶ Turn the SmartKey to position **1** in the ignition lock (▶ page 135).

If you use the sockets for long periods when the engine is switched off, the battery may discharge.

- i** An emergency cut-out ensures that the on-board voltage does not drop too low. If the on-board voltage is too low, the power to the sockets is automatically cut. This ensures that there is sufficient power to start the engine.

Socket under the armrest

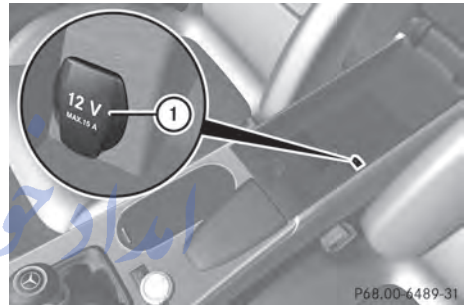

- ▶ Open the stowage compartment under armrest **1** (▶ page 257).
- ▶ Lift up the cover of socket **2**.

On vehicles without ashtrays or lighters, there is an additional socket in the center console.

Socket in the front-compartment center console



- ▶ **To open:** push the lower section of cover **1**.
The stowage compartment opens.
- ▶ Lift up the cover of socket **2**.

Garage door opener

Important safety notes

WARNING

Before programming the integrated remote control to a garage door opener or gate operator, make sure people and objects are out of the way of the device to prevent potential harm or damage. When programming a garage door opener, the door moves up or down. When programming a gate operator, the gate opens or closes.

Do not use the integrated remote control with any garage door opener that lacks safety stop and reverse features as required by U.S. federal safety standards (this includes any garage door opener model manufactured before April 1, 1982). A garage door that cannot detect an object - signaling the door to stop and reverse - does not meet current U.S. federal safety standards.

When programming a garage door opener, park vehicle outside the garage.

Do not run the engine while programming the integrated remote control. Inhalation of exhaust gas is hazardous to your health. All exhaust gas contains carbon monoxide (CO), and inhaling it can cause unconsciousness and possible death. All exhaust gas contains carbon monoxide (CO), and inhaling it can cause unconsciousness and possible death.

The HomeLink® garage door opener integrated in the rear-view mirror allows you to operate up to three different door and gate systems.

- i** Certain garage door drives are incompatible with the integrated garage door opener. If you have difficulty programming the integrated garage door opener, contact an authorized Mercedes-Benz Center.

Alternatively, you can call the following telephone assistance services:

- **USA:** Mercedes-Benz Customer Assistance Center at 1-800-FOR-MERcedes
- **Canada:** Customer Service at 1-800-387-0100
- HomeLink® hotline 1-800-355-3515 (free of charge)

More information on HomeLink® and/or compatible products is also available online at <http://www.homelink.com>.

i USA only:

This device complies with part 15 of the FCC Rules. Operation is subject to the following two conditions:

1. This device may not cause harmful interference, and
2. this device must accept any interference received, including interference that may cause undesired operation.

Any unauthorized modification to this device could void the user's authority to operate the equipment.

FCC ID: CB2HMIHL4

i Canada only:

This device complies with the RSS-210 Rules of Industry Canada. Operation is subject to the following two conditions:

1. This device may not cause harmful interference, and
2. this device must accept any interference received, including interference that may cause undesired operation of the device.

Any unauthorized modification to this device could void the user's authority to operate the equipment.

IC: 279B-HMIHL4

Programming

Programming buttons

WARNING

Only press the button on the integrated garage door opener if there are no persons or objects present within the sweep of the garage door. Persons could otherwise be injured as the door moves.

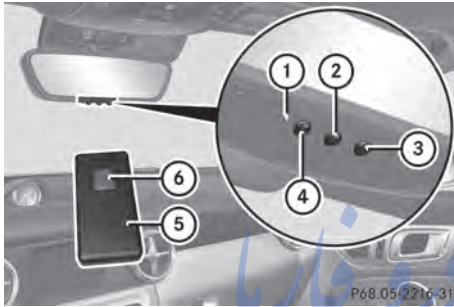

Integrated garage door opener on the rear-view mirror

Garage door remote control ⑤ is not part of the integrated garage door opener.

- ▶ Before programming for the first time, clear the memory of the integrated garage door opener (▷ page 265).
- ▶ Turn the SmartKey to position **2** in the ignition lock.
- ▶ Press and hold one of buttons ② to ④ on the integrated garage door opener. After a short time, indicator lamp ① lights up yellow.
- ❗ Indicator lamp ① lights up yellow as soon as button ②, ③ or ④ is programmed for the first time. If the selected button has already been programmed, indicator lamp ① will only light up yellow after ten seconds have elapsed.
- ▶ Release button ②, ③ or ④. Indicator lamp ① flashes yellow.
- ▶ Point garage door remote control ⑤ towards buttons ② to ④ on the rear-view

mirror at a distance of 2 to 8 inches (5 to 20 cm).

- ❗ The required distance between remote control ⑤ and the integrated garage door opener depends on the garage door drive system. Several attempts might be necessary. You should test every position for at least 25 seconds before trying another position.
- ▶ Press and hold button ⑥ on remote control ⑤ until indicator lamp ① lights up green. If indicator lamp ① lights up green or flashes, then programming has been successful.
- ▶ Release button ⑥ on remote control ⑤ for the garage door drive system.
- ▶ If indicator lamp ① lights up red: repeat the programming procedure for the corresponding button on the rear-view mirror. When doing so, vary the distance between remote control ⑤ and the rear-view mirror.

- ❗ If the indicator lamp flashes green after successful programming, the garage door system is using a rolling code. After programming, you must synchronize the garage door opener integrated in the rear-view mirror with the receiver of the garage door system.

Synchronizing the rolling code

Your vehicle must be within reach of the garage door or exterior gate drive. Make sure that neither your vehicle nor any persons/objects are present within the sweep of the door or gate.

Observe the safety notes when performing the rolling code synchronization.

- ▶ Turn the SmartKey to position **2** in the ignition lock.
- ▶ Press the programming button of the door or gate drive (see the door or gate drive operating instructions, e.g. under "Programming of additional remote controls").

- 1 Usually, you now have 30seconds to initiate the next step.
- ▶ Press previously programmed button ②, ③ or ④ of the integrated garage door opener until the door closes. The rolling code synchronization is then complete.

Notes on programming the remote control

Canadian radio frequency laws require a "break" (or interruption) of the transmission signals after broadcasting for a few seconds. Therefore, these signals may not last long enough for the integrated garage door opener. The signal is not recognized during programming. Comparable with Canadian law, some U.S. garage door openers are designed to "time-out" in the same manner.

Proceed as follows:

- if you live in Canada
- if you have difficulties programming the garage door opener (regardless of where you live) when using the programming steps
- ▶ Press and hold one of buttons ② to ④ on the integrated garage door opener. After a short time, indicator lamp ① lights up yellow.
- ▶ Release the button. Indicator lamp ① flashes yellow.
- ▶ Press button ⑥ of garage door remote control ⑤ for two seconds, then release it for two seconds.
- ▶ Press button ⑥ again for two seconds.
- ▶ Repeat this sequence on button ⑥ of remote control ⑤ until indicator lamp ① lights up green. If indicator lamp ① turns red, repeat the process.
- ▶ Continue with the other programming steps (see above).

Problems when programming

If you are experiencing problems programming the integrated garage door opener on the rear-view mirror, take note of the following instructions:

- Check the transmitter frequency of garage door drive remote control ⑤. This can usually be found on the back of the remote control.

The integrated garage door opener is compatible with devices that have units which operate in the frequency range of 280to 433MHz.

- Replace the batteries in garage door remote control ⑤. This increases the likelihood that garage door remote control ⑤ will transmit a strong and precise signal to the integrated garage door opener in the rear-view mirror.
- When programming, hold remote control ⑤ at varying distances and angles from the button that you are programming. Try various angles at a distance between 2and 12 inches (5to 30 cm) or at the same angle but at varying distances.
- If another remote control for the same garage door drive is available, repeat the same programming steps with this remote control. Before performing these steps, make sure that new batteries have been installed in garage door drive remote control ⑤.
- Note that some remote controls only transmit for a limited amount of time (the indicator lamp on the remote control goes out). Press button ⑥ on remote control ⑤ again before transmission ends.
- Align the antenna cable of the garage door opener unit. This can improve signal reception/transmission.

Opening/closing the garage door

After it has been programmed, the integrated garage door opener performs the function of the garage door system remote control.

Please also read the operating instructions for the garage door system.

- ▶ Turn the SmartKey to position **2** in the ignition lock.
- ▶ Press button ②, ③ or ④ which you have programmed to operate the garage door. Garage door system with a fixed code: indicator lamp ① lights up green.
Garage door system with a rolling code: indicator lamp ① flashes green.

i The transmitter will transmit a signal as long as the button is pressed. The transmission is halted after a maximum of ten seconds and indicator lamp ① lights up yellow. Press button ②, ③ or ④ again if necessary.

Clearing the memory

- ▶ Turn the SmartKey to position **2** in the ignition lock.
- ▶ Press buttons ② and ④.
The indicator lamp lights up yellow.
- ▶ Press and hold buttons ② and ④ until the indicator lamp turns green.

i Make sure that you clear the memory of the integrated garage door opener before selling the vehicle.

mbrace

Important safety notes

i A license agreement must exist in order to activate the mbrace service. Ensure that your system is activated and ready for use, and press the  MB Info call button to register. If any of the steps mentioned is not carried out, the system may not be activated.

If you have questions about the activation, contact one of the following telephone assistance services:

- **USA:** Mercedes-Benz Customer Assistance Center under

1-800-FOR-MERcedes
(1-800-367-6372) or 1-888-990-9007

- **Canada:** Customer Service at 1-888-923-8367

Shortly after successfully registering with the mbrace service (Canada: TELEAID), a user ID and password will be sent to you by post. USA only: you can use this password to log onto the mbrace area under "Owners Online" at <http://www.mbusa.com>.

The mbrace system is available if:



- it has been activated and is operational
- the corresponding mobile phone network is available for transmitting data to the Customer Center
- a service subscription is available
- the starter battery is sufficiently charged

i Determining the location of the vehicle on a map is only possible if:

- GPS reception is available
- the vehicle position can be forwarded to the Customer Assistance Center

The mbrace system

To adjust the volume during an mbrace call, proceed as follows:

- ▶ Press the  or  button on the multifunction steering wheel.

or

- ▶ Use the volume controller of the audio system/COMAND.

The mbrace system provides various services, e.g.:





- automatic and manual emergency call
- Roadside Assistance call
- MB Info call

USA only: you can find information and a description of all available features under "Owners Online" at <http://www.mbusa.com>.

System self-test

After you have switched on the ignition, the system carries out a self-diagnosis.

A malfunction in the system has been detected if one of the following conditions occurs:

- the indicator lamp in the SOS button does not come on during the system self-test.
- the indicator lamp in the  Roadside Assistance button does not light up during self-diagnosis of the system.
- the indicator lamp in the  MB-Info call button does not light up during self-diagnosis of the system.
- the indicator lamp in one or more of the following buttons continues to light up red after the system self-diagnosis:
 - SOS button
 - Roadside Assistance call button 
 - MB Info call button 
- The **mbrace Inoperative** or **mbrace Service Not Activated** message appears in the multifunction display after the system self-diagnosis.

If a malfunction is indicated as outlined above, the system may not operate as expected. In the event of an emergency, assistance must be summoned by other means.

Have the system checked at the nearest authorized Mercedes-Benz Center or contact the following service hotlines:

- **USA:** Mercedes-Benz Customer Assistance center at 1-800-FOR-MERCEdes (1-800-367-6372) or 1-888-990-9007
- **Canada:** Customer Service at 1-888-923-8367

Emergency call

Important safety notes

WARNING

If the indicator lamp in the SOS button is flashing continuously and no voice connection with the Response center has been established, then the mbrace system has not been able to initiate an emergency call (e.g. the relevant mobile phone network is not available).

The **Call Failed** message is displayed in the multifunction display and must be confirmed. Should this occur, assistance must be summoned by other means.

- A license agreement must exist in order to activate the mbrace service. Ensure that your system is activated and ready for use, and press the  MB Info call button to register. If any of the steps mentioned is not carried out, the system may not be activated.

If you have questions about the activation, contact one of the following telephone assistance services:

- **USA:** Mercedes-Benz Customer Assistance Center under 1-800-FOR-MERCEdes (1-800-367-6372) or 1-888-990-9007
- **Canada:** Customer Service at 1-888-923-8367

An emergency call is dialed automatically if an air bag or Emergency Tensioning Device is triggered.

- ⓘ You cannot end an automatically triggered emergency call yourself.

An emergency call can also be initiated manually.

As soon as the emergency call has been initiated, the indicator lamp in the SOS button flashes. The **Connecting Call** message appears on the multifunction display.

The audio output is muted.

Once the connection has been made, the **Call Connected** message appears in the multifunction display.

All important information on the emergency is transmitted, for example:

- current location of the vehicle (as determined by the GPS system)
- vehicle identification number
- information on serious accidents

Shortly after the emergency call has been initiated, a voice connection is automatically established between the Mercedes-Benz Customer Assistance Center and the vehicle occupants. If the vehicle occupants respond, the Mercedes-Benz Customer Assistance Center attempts to get more information on the emergency.

- ❗ If there is no response from the vehicle occupants, an ambulance is immediately sent to the vehicle.

Making an emergency call

⚠️ WARNING

If you feel at any way in jeopardy when in the vehicle (e.g. smoke or fire in the vehicle, vehicle in a dangerous road location), please do not wait for voice contact after you have pressed the SOS button. Carefully leave the vehicle and move to a safe location. The Response Center will automatically contact local emergency officials with the vehicle's approximate location if they receive an automatic SOS signal and cannot make voice contact with the vehicle occupants.



- ▶ **To initiate an emergency call manually:** press cover ① briefly to open.
- ▶ Press SOS button ② briefly. The indicator lamp in SOS button ② flashes until the emergency call is concluded.
- ▶ Wait for a voice connection to the Mercedes-Benz Customer Assistance Center.
- ▶ After the emergency call, close cover ①.

Roadside Assistance button



- ▶ Press Roadside Assistance button ①. This initiates a call to the Mercedes-Benz Customer Assistance Center. The indicator lamp in Roadside Assistance button ① flashes while the call is active. The **Connecting Call** message appears on the multifunction display. The audio output is muted.

If a connection can be made, the **Call Connected** message appears in the multifunction display.

If a cellular phone network is available and there is sufficient GPS reception, the mbrace system transmits data to the Mercedes-Benz Customer Assistance Center, for example:

- current location of the vehicle
- vehicle identification number

- ❗ The display of the audio system or COMAND shows that an mbrace call is active. During the call, you can change to

the navigation menu by pressing the NAVI button on COMAND, for example.

Voice output is not available.

A voice connection is established between the Mercedes-Benz Customer Assistance Center and the vehicle occupants.

From the vehicle remote malfunction diagnosis, the Mercedes-Benz Customer Assistance center can ascertain the nature of the problem (▷ page 271).

The Mercedes-Benz Customer Assistance Center either sends a qualified Mercedes-Benz technician or organizes for your vehicle to be transported to the nearest authorized Mercedes-Benz Center. You may be charged for services such as repair work and/or towing. Further details are available in your mbrace manual.

i The mbrace system failed to initiate a Roadside Assistance call if:

- the indicator lamp for Roadside Assistance call button ① is flashing continuously
- no voice connection to the Mercedes-Benz Customer Assistance Center was established

This may be because the corresponding mobile phone network is not available.

The **Call Failed** message appears in the multifunction display.

► **To end a call:** press the  button on the multifunction steering wheel.

or

► Press the corresponding button for ending a phone call on the audio system or on COMAND.

MB Info call button



► Press MB Info call button ①.

This initiates a call to the Mercedes-Benz Customer Assistance Center. The indicator lamp in MB Info call button ① flashes while the connection is being made. The **Connecting Call** message appears on the multifunction display. The audio system is muted.

If a connection can be made, the **Call Connected** message appears in the multifunction display.

If a cellular phone network is available and there is sufficient GPS reception, the mbrace system transmits data to the Mercedes-Benz Customer Assistance Center, for example:

- current location of the vehicle
- vehicle identification number

i The display of the audio system or COMAND shows that an mbrace call is active. During the call, you can change to the navigation menu by pressing the NAVI button on COMAND, for example.

Voice output is not available.

A voice connection is established between the Mercedes-Benz Customer Assistance Center and the vehicle occupants. You can obtain information on how to operate your vehicle's systems, on the location of the nearest authorized Mercedes-Benz Center, and on further products and services offered by Mercedes-Benz USA.

USA only: you can find further information on the mbrace system under "Owners Online" at <http://www.mbusa.com>.

i The mbrace system failed to initiate an MB Info call if:

- the indicator lamp in MB Info call button  is flashing continuously
- no voice connection to the Mercedes-Benz Customer Assistance Center was established

This may be because the corresponding mobile phone network is not available.

The **Call Failed** message appears in the multifunction display.

▶ **To end a call:** press the  button on the multifunction steering wheel.

or

▶ Press the corresponding button for ending a phone call on the audio system or on COMAND.

Call priority

When service calls are active, e.g. Roadside Assistance or MB Info calls, an emergency call can still be initiated. In this case, an emergency call will take priority and override all other active calls.

The indicator lamp of the respective button flashes until the call is ended. An emergency call can only be terminated by the Mercedes-Benz Customer Assistance Center.

All other calls can be ended by pressing:

- the  button on the multifunction steering wheel
- the corresponding button on the audio system or on COMAND to end the voice call

i If an mbrace call is initiated, audio output is muted. The mobile phone is no longer connected to COMAND. However, if you want to use your mobile phone, do so only when the vehicle is stationary and in a safe location.



Downloading destinations in COMAND

Downloading destinations

Downloading destinations gives you access to a data bank with over 15 million Points of Interest (POIs). These can be downloaded on the navigation system in your vehicle. If you know the destination, the address can be downloaded. Alternatively, you can obtain the location of Points of Interest (POIs)/ important destinations in the vicinity.

Furthermore, you can download routes with up to 20 way points.

You are prompted to confirm route guidance to the address entered.

▶ Select **Yes** with the  or  buttons on the COMAND system.

▶ Confirm with the  button on the COMAND system.

The system calculates the route and subsequently starts the route guidance with the address entered.

i If you select **No**, the address can be stored in the address book.

i The Destination Download function is available if the corresponding mobile phone network is available and data transfer is possible.

i You can only use the Destination Download function if the vehicle is equipped with a navigation system.

Route Assistance

This service is part of the mbrace PLUS Package and cannot be purchased separately.

i You can also use the Route Assistance function if your vehicle is not equipped with a navigation system.

Within the framework of this service, you receive a professional and reliable form of navigation support without having to leave your vehicle.

The customer service representative finds a suitable route depending on your vehicle's current position and the desired destination. You will then be guided live through the current route section.

Search and send

General notes

i To use "Search & Send", your vehicle must be equipped with mbrace and a navigation system. You must also have an mbrace service subscription.

"Search & Send" is a destination entry service. A destination address which is found on Google Maps® can be transferred via mbrace directly to your vehicle's navigation system.

Specifying and sending the destination address

► Go to the website <http://www.maps.google.com> and enter a destination address into the entry field.

► **To send the destination address to the e-mail address of your mbrace account:** click on the corresponding button.

i Example:

If you select 'Send to vehicle' and then 'Mercedes-Benz', the destination address will be sent to your vehicle.

► When the "Send" dialog window appears: In the relevant field, enter the e-mail address which you specified when activating your mbrace account.

► Click "Send".

i Information on specific commands such as "Address entry" or "Sending" can be found on the website.

Calling up destination addresses

► Switch on the ignition.
The destination address is loaded into the vehicle's navigation system.

A display message appears, asking whether navigation should be started.

► Select **Yes** by sliding $\leftarrow \odot \rightarrow$ and turning $\left\{ \odot \right\}$ the COMAND controller and press \odot to confirm.

The system calculates the route and subsequently starts the route guidance with the address entered.

i If you select **No**, the address can be stored in the address book.

i If you have sent more than one destination address, each individual destination must be confirmed separately.

i Destination addresses are loaded in the same order as the order in which they were sent. If you own multiple Mercedes-Benz vehicles with mbrace and activated mbrace accounts:

if multiple vehicles are registered under the same e-mail address, the destination will be sent to all the vehicles.

Vehicle remote opening

You can use the vehicle remote opening if you have unintentionally locked your vehicle and a replacement SmartKey is not available. The vehicle can be opened by the Mercedes-Benz Customer Assistance center.

The vehicle can be immediately remotely opened within four days of the ignition being turned off. After this time, the remote opening may be delayed by 15 to 60 minutes. After 30 days the vehicle can no longer be opened remotely.

► Contact the following service hotlines:

- **USA:** Mercedes-Benz Customer Assistance center at 1-800-FOR-MERCEdes

(1-800-367-6372) or 1-888-990-9007

- **Canada:** Customer Service at 1-888-923-8367

You will be asked for your password.

- ▶ Return to your vehicle at the time agreed upon with the Mercedes-Benz Customer Assistance Center.

USA only: alternatively, the vehicle can be opened via:

- the Internet, under the "Owners Online" section
- the telephone application (e.g. iPhone®, Blackberry)

To do this, you will need your identification number and password.

- ❗ Vehicle remote opening is only possible if the corresponding mobile phone network is accessible.

Vehicle remote closing

The remote closing feature can be used when you have forgotten to lock the vehicle and you are no longer nearby. The vehicle can then be locked by the Mercedes-Benz Customer Assistance center.

The vehicle can be immediately remotely locked within four days of the ignition being turned off. After this time, the remote closing may be delayed by 15 to 60 minutes. After 30 days the vehicle can no longer be closed remotely.

- ▶ Contact the following service hotlines:
 - **USA:** Mercedes-Benz Customer Assistance center at 1-800-FOR-MERcedes (1-800-367-6372) or 1-888-990-9007
 - **Canada:** Customer Service at 1-888-923-8367
- You will be asked for your PIN.

The next time you are inside the vehicle and you switch on the ignition, the **Doors Locked Remotely** message appears in the multifunction display.

USA only: alternatively, the vehicle can be locked via:

- the Internet, under the "Owners Online" section
- the telephone application (e.g. iPhone®, Blackberry)

To do this, you will need your identification number and password.

- ❗ The vehicle remote closing feature is available when the relevant mobile phone network is available and data connection is possible.

Stolen vehicle recovery service

If your vehicle has been stolen:

- ▶ Notify the police. The police will issue a numbered incident report.
- ▶ This number will be forwarded to the Mercedes-Benz Customer Assistance Center together with your PIN. The Mercedes-Benz Customer Assistance Center then attempts to locate the mbrace system. The Mercedes-Benz Customer Assistance Center contacts you and the local law enforcement agency if the vehicle is located. However, only the law enforcement agency is informed of the location of the vehicle.
- ❗ If the anti-theft alarm system is activated for longer than 30 seconds, the Mercedes-Benz Customer Assistance center is automatically informed.

Vehicle remote malfunction diagnosis

With the vehicle remote malfunction diagnosis (Vehicle Health Check), the Customer Assistance center can provide improved support for problems with your vehicle. During an existing call, vehicle data is transferred to the Customer Assistance center. The customer service representative can use the received data to decide what kind of assistance is required. You are then, for

example, guided to the nearest Mercedes-Benz Service center or a recovery vehicle is called.

If vehicle data needs to be transferred during an MB Info call or a Roadside Assistance call, this is initiated by the Customer Assistance center. You will see the **Roadside Assistance Connected** message in the COMAND display. If the vehicle remote malfunction diagnosis is able to be started, the **Request for vehicle diagnosis received. Start vehicle diagnosis?** message appears in the display.

- ▶ Press **Yes** to confirm the message.
- ▶ If the **Vehicle Diagnosis: Please switch on ignition.** message appears: turn the key to position **2** in the ignition lock.
- ▶ If the **Please follow the instructions received by phone and move your vehicle to a safe position.** message appears: follow the instructions of the customer service representative. The message in the display disappears. If you select **Cancel**, the vehicle remote malfunction diagnosis is canceled completely. The vehicle operating state check begins. Meanwhile, the **Vehicle diagnosis activated** message appears.

When the check is finished, the **Sending vehicle diagnosis data...(Voice connection may be interrupted during data transfer.)** message appears. The vehicle data can now be sent to the Customer Assistance center.

- ▶ Press **OK** to confirm the message. The voice connection with the Customer Assistance center is terminated. The **Vehicle Diagnosis: Transferring data...** appears. The vehicle data is sent to the Customer Assistance center.

Depending on what the customer service representative agreed with you, the voice connection is re-established after the transfer is complete. If necessary, you will be contacted at a later time by another means, e.g. by E-Mail or telephone.

Further functions of the vehicle remote malfunction diagnosis include, for example:

- transfer of service data to the Customer Assistance center. If a service is overdue, the COMAND display shows a message about various special offers at your workshop.
- monthly status information E-Mail on oil level, air pressure, maintenance, brakes, etc. If applicable, you will receive information on special offers in the E-Mail. USA only: this information can also be called up under "Owners Online" at <http://www.mbusa.com>.

Information on the data stored in the vehicle (▷ page 24).

Information on roadside assistance (▷ page 21).
تلفن شبانه: ۰۲۱-۸۸۸۶۲۰۰۰

Downloading routes

Downloading routes allows you to transfer and save predefined routes in the navigation system. To do this, an SD memory card must be inserted into the COMAND system. If no SD memory card is inserted, you must insert the card into the card slot on the COMAND system before saving.

A route can be prepared and sent either by a customer service representative or via the mbrace portal on the Internet. Each route can include up to 20 way points. When a route has been received by the navigation system, **'Route name' has been saved to memory card. Do you want to start route guidance?** appears on the COMAND display. The route is saved to the SD memory card.

- ▶ **To start route guidance:** select **Yes**.
An overview of the route is shown in the display.
- ❶ If you select **No**, the saved route can be called up later in the navigation menu.
- ▶ Select **Start**.
Route guidance is started.
- ❶ Downloaded and saved data can be called up again in COMAND. Further information can be found in the "COMAND", "Online and Internet services" and "Download destination/route" sections.

Speed alert

You can define the upper speed limit, which must not be exceeded by the vehicle. If this selected speed is exceeded by the vehicle, a message will be sent to the Customer Assistance center. The Customer Assistance center then forwards this information to you. You can select the way in which you receive this information beforehand. Possible options include SMS, E-Mail or an automated call.

The data which is sent to the Customer Assistance center contains the following information:

- the location where the speed limit was exceeded
- the time at which the speed limit was exceeded
- the selected speed limit which was exceeded

Geo fencing

Geo fencing allows you to select areas which the vehicle should not enter or leave. You will be informed if the vehicle crosses the boundaries of the selected areas. You can select the way in which you receive this information beforehand. Possible options include SMS, E-Mail or an automated call.

The area can be determined as either a circle or a polygon with a maximum of ten corners. You can specify up to ten areas

simultaneously. Different settings are possible for each area.

USA only: these settings can be called up under "Owners Online" at <http://www.mbUSA.com>.

Alternatively, you can trigger an MB Info call and inform the customer service representative that you wish to activate geo fencing.

Currently inactive areas can be activated by SMS.

Triggering the vehicle alarm

With this function, you can trigger the vehicle's panic alarm via SMS. An alarm sounds and the exterior lighting flashes. Depending on the setting, the panic alarm lasts five or ten seconds. Afterwards, the alarm switches off.

Floormats

⚠ WARNING

Whenever you are using a floormat, make sure there is enough clearance and that the floormat is securely fastened.

The floormat should always be securely fastened using the fastening equipment.

Before driving off, check that the floormat is securely in place and adjust it if necessary. A loose floormat could slip and hinder proper functioning of the pedals.

Do not place several floormats on top of each other as this may impair pedal movement.

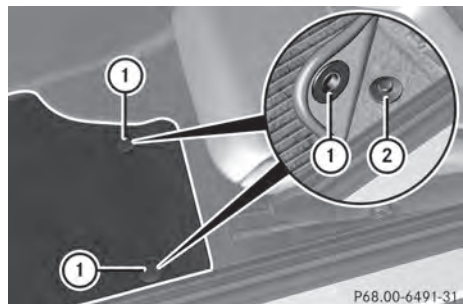

P68.00-6491-31

- ▶ Slide the seat backwards.
- ▶ **To install:** place the floormat in the footwell.
- ▶ Press studs ① onto retainers ②.
- ▶ **To remove:** pull the floormat off retainers ②.
- ▶ Remove the floormat.

امداد خودرو فارما

تلفن شبانه روزی: ۰۲۱-۸۸۸۶۲۰۸۵

FarmaSOS.com

Useful information	276
Engine compartment	276
ASSYST PLUS	280
Care	281

امداد خودرو فارما

تلفن شبانه روزی: ۰۲۱-۸۸۸۶۲۰۸۵

FarmaSOS.com

Useful information

- 1 This Operator's Manual describes all models and all standard and optional equipment of your vehicle available at the time of publication of the Operator's Manual. Country-specific differences are possible. Please note that your vehicle may not be equipped with all features described. This also applies to safety-related systems and functions.
- 1 Read the information on qualified specialist workshops: (▷ page 23).

Engine compartment

Hood

Opening the hood

WARNING

Do not pull the release lever while the vehicle is in motion. Otherwise, the hood could be forced open by passing air flow.

This could cause the hood to come loose and injure you and/or others.

WARNING

Do not open the hood when the engine is overheated. You could be seriously injured. Observe the coolant temperature gauge to determine whether the engine may be overheated. If you see flames or smoke coming from the engine compartment, move away from the vehicle. Wait until the engine has cooled. If necessary, call the fire department.

WARNING

There is a risk of injury if the hood is open, even if the engine is not running.

Some engine components can become very hot.

To avoid the risk of burns, only touch those components described in the Operator's Manual and observe the relevant safety notes.

WARNING

To avoid injury, stay clear of moving parts when the hood is open and the engine is running.

The radiator fan may continue to run for approximately 30seconds or may even restart after the engine has been switched off. For this reason, you must not reach into the fan rotation area.

WARNING

The engine is equipped with a transistorized ignition system. Because of the high voltage, it is dangerous to touch any components (ignition coils, spark plug sockets, diagnostic socket) of the ignition system:

- with the engine running
- while starting the engine
- when the ignition is switched on and the engine is turned manually

WARNING

The windshield wipers and wiper linkage could be set in motion.

When the hood is open, you or others could be injured by the wiper linkage.

Make sure that the windshield wipers are switched off. Remove the SmartKey or make sure that no ignition position has been selected with KEYLESS-GO. All indicator lamps must be off in the instrument panel.

- 1 Make sure that the windshield wipers are not folded away from the windshield. You could otherwise damage the windshield wipers or the hood.



- ▶ Make sure that the windshield wipers are turned off.
- ▶ Pull release lever ① on the hood. The hood is released.

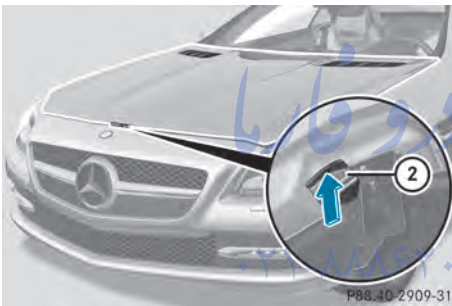

- ▶ Reach into the gap, pull hood catch handle ② up and lift the hood. If you lift the hood approximately 15 inches (40 cm), the hood is opened and held open automatically by the gas-filled struts.

Closing the hood

⚠ WARNING

When closing the hood, use extreme caution not to catch hands or fingers. Be careful that you do not close the hood on anyone.

Make sure the hood is securely engaged before driving off. Do not continue driving if the hood can no longer engage after an accident, for example. The hood could otherwise come loose while the vehicle is in motion and injure you and/or others.

- ▶ Lower the hood and let it fall from a height of approximately 8 inches (20cm).
- ▶ Check that the hood has engaged properly. If the hood can be raised slightly, it is not properly engaged. Open it again and close it with a little more force.

Engine oil

Notes on the oil level

Depending on the driving style, the vehicle consumes up to 0.9 US qt (0.8l) of oil over a distance of 600 miles (1000km). The oil consumption may be higher than this when the vehicle is new or if you frequently drive at high engine speeds.

AMG vehicles: before operation on race tracks, check the oil level and (▷ page 278) add oil if necessary (▷ page 278). Race track operation is only permitted with a maximum engine oil level.

Depending on the engine, the oil dipstick may be in a different location.

When checking the oil level:

- park the vehicle on a level surface.
- the engine should be switched off for approximately five minutes if the engine is at normal operating temperature.
- if the engine is not at normal operating temperature, e.g. if the engine was only started briefly: wait about 30 minutes before carrying out the measurement.

Checking the oil level using the oil dipstick

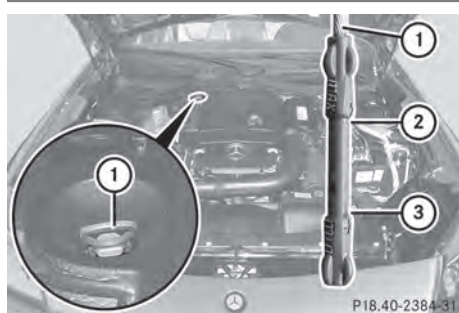

Example

- ▶ Pull oil dipstick ① out of the dipstick guide tube.
- ▶ Wipe off oil dipstick ①.
- ▶ Slowly slide oil dipstick ① into the guide tube to the stop, and take it out again. If the level is between MIN mark ③ and MAX mark ②, the oil level is correct.
- ▶ If the oil level has dropped to MIN mark ③ or below, add 1.1 US qt (1.0 liter) of engine oil.

Adding engine oil

⚠ WARNING

If engine oil comes into contact with hot engine parts, it may ignite and you could burn yourself. Do not spill any engine oil on hot engine parts.

♻ Environmental note

When adding oil, take care not to spill any. If oil enters the soil or waterways, it is harmful to the environment.

- ⚠ Use only engine oils and oil filters that have been approved for vehicles equipped with a service system. A list of the engine oils and oil filters tested and approved in accordance with the Mercedes-Benz Specifications for Service Products can be called up by visiting <http://www.mbusa.com> (USA only). More

information about tested and approved engine oils and oil filters is available from any authorized Mercedes-Benz Center. Damage to the engine or exhaust system is caused by the following:

- using engine oils and oil filters which have not been specifically approved for the service system.
- replacing the engine oil or oil filter after the replacement interval required by the service system has elapsed
- using engine oil additives.

- ⚠ Do not add too much oil. If the oil level is above the "max" mark on the dipstick, too much oil has been added. This can lead to damage to the engine or the catalytic converter. Have excess oil siphoned off.

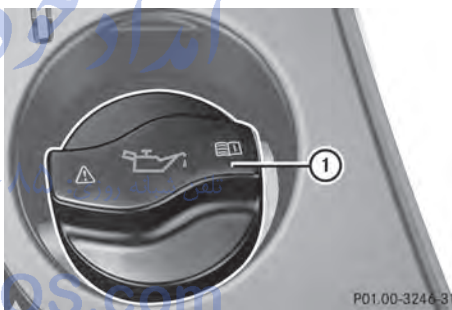

Example: engine oil cap

- ▶ Turn cap ① counter-clockwise and remove it.
- ▶ Add engine oil. If the oil level is at or below the MIN mark on the oil dipstick, add 1.1 US qt (1.0 liter) of engine oil.
- ▶ Replace cap ① on the filler neck and turn clockwise. Ensure that the cap locks into place securely.
- ▶ Check the oil level again with the oil dipstick (▷ page 278).

Further information on engine oil (▷ page 350).

Checking and adding other service products

Checking the coolant level

⚠ WARNING

In order to avoid potentially serious burns:

- use extreme caution when opening the hood if there are any signs of vapor or coolant leaking from the cooling system, or if the coolant temperature display indicates that the coolant is overheated.
- do not remove the pressure cap on the coolant tank if the coolant temperature is above 158 °F (70 °C). Allow the engine to cool down before removing the cap. The coolant tank contains hot fluid and is under pressure.
- using a cloth, slowly turn the cap approximately 1/2 turn to relieve excess pressure. If you open the cap immediately, pressurized scalding hot fluid and vapor will be blown out.
- do not spill antifreeze on hot engine parts. Antifreeze contains ethylene glycol which may burn if it comes into contact with hot engine parts.

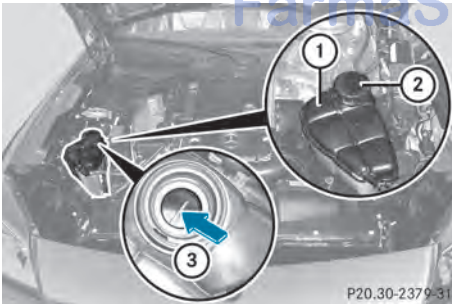

Example

- ▶ Park the vehicle on a level surface.
Only check the coolant level when the vehicle is on a level surface and the engine has cooled down.
- ▶ Turn the SmartKey to position **2** in the ignition lock (▷ page 135).

On vehicles with KEYLESS-GO, press the Start/Stop button twice (▷ page 136).

- ▶ Check the coolant temperature gauge in the multifunction display.
The coolant temperature must be below 158 °F (70 °C).
- ▶ Turn the SmartKey to position **0** (▷ page 135) in the ignition lock.
- ▶ Slowly turn cap **2** half a turn counter-clockwise to allow excess pressure to escape.
- ▶ Turn cap **2** further counter-clockwise and remove it.
If the coolant is at the level of marker bar **3** in the filler neck when cold, there is enough coolant in coolant expansion tank **1**.
If the coolant level is approximately 0.6 in (1.5 cm) above marker bar **3** in the filler neck when warm, there is enough coolant in coolant expansion tank **1**.
- ▶ If necessary, add coolant that has been tested and approved by Mercedes-Benz.
- ▶ Replace cap **2** and turn it clockwise as far as it will go.

For further information on coolant, see (▷ page 351).

Windshield washer system and headlamp cleaning system

⚠ WARNING

Washer solvent/antifreeze is highly flammable. Do not spill washer solvent/antifreeze on hot engine parts, because it may ignite and burn. You could be seriously burned.

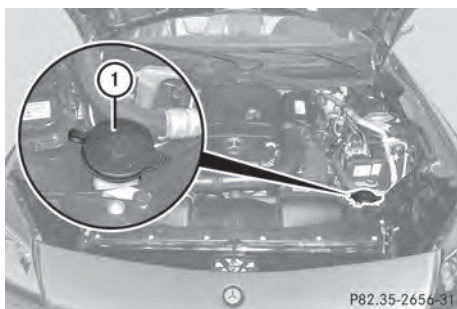

Example

- ▶ **To open:** pull cap ① upwards by the tab.
- ▶ Add the premixed washer fluid.
- ▶ **To close:** press cap ① onto the filler neck until it engages.

The washer fluid reservoir is used for both the windshield washer system and the headlamp cleaning system.

For further information on the windshield washer system and headlamp cleaning system, see (▷ page 352).

ASSYST PLUS

Service messages

The ASSYST PLUS service interval display informs you of the next service due date.

Information on the type of service and service intervals (see the separate Maintenance Booklet).

You can obtain further information from an authorized Mercedes-Benz Center or at <http://www.mbusa.com> (USA only).

- ❗ The ASSYST PLUS service interval display does not show any information on the engine oil level. Observe the notes on the engine oil level (▷ page 277).

The multifunction display shows a service message for several seconds, e.g.:

Next Service A Due in .. Days
 Service A Due
 Service A Exceeded by ... Days

The letter **A** or **B**, possibly in connection with a number or another letter, shows the type of service. **A** stands for a minor service and **B** for a major service.

You can obtain further information from any authorized Mercedes-Benz Center.

The ASSYST PLUS service interval display does not take into account any periods of time during which the battery is disconnected.



Maintaining the time-dependent service schedule:

- ▶ Note down the service due date displayed in the multifunction display before disconnecting the battery.





or

- ▶ After reconnecting the battery, subtract the battery disconnection periods from the service date shown on the display.

Hiding a service message

- ▶ Press the  or  button on the steering wheel.

Displaying service messages

- ▶ Switch on the ignition.
- ▶ Press the  or  button on the steering wheel to select the **Service** menu.
- ▶ Press  or  to select the **ASSYST PLUS** submenu and press  to confirm. The service due date appears in the multifunction display.

Information about Service

Resetting the ASSYST PLUS service interval display

- ❗ If the ASSYST PLUS service interval display has been inadvertently reset, this

setting can be corrected at a qualified specialist workshop.

Have service work carried out as described in the Maintenance Booklet. This may otherwise lead to increased wear and damage to the major assemblies or the vehicle.

A qualified specialist workshop, e.g. an authorized Mercedes-Benz Center, will reset the ASSYST PLUS service interval display after the service work has been carried out. You can also obtain further information on maintenance work, for example.

Special service requirements

Arduous operating conditions or increased loads on the vehicle will require some service work to be performed more often than for a vehicle in normal use. Such arduous conditions include regular city driving with frequent intermediate stops and use in mountainous terrain or on poor road surfaces.

For example, if the vehicle is used under arduous operating conditions, have air filters, engine oil and oil filters changed frequently and check the wheels often. Further information can be obtained at a qualified specialist workshop, e.g. an authorized Mercedes-Benz Center.

Driving abroad

An extensive Mercedes-Benz Service network is also available in other countries. You can obtain further information from any authorized Mercedes-Benz Center.

Care

Notes on care

WARNING

Many cleaning products can be hazardous. Some are poisonous, others are flammable. Always follow the instructions on the

particular container. Always open your vehicle's doors or windows when cleaning the inside.

Never use fluids or solvents that are not designed for cleaning your vehicle.

Always lock away cleaning products and keep them out of reach of children.

Environmental note

Dispose of empty packaging and cleaning cloths in an environmentally responsible manner.

 For cleaning your vehicle, do not use any of the following:

- dry, rough or hard cloths
- abrasive cleaning agents
- solvents
- cleaning agents containing solvents

Do not scrub.

Do not touch the surfaces or protective films with hard objects, e.g. a ring or ice scraper. You could otherwise scratch or damage the surfaces and protective film.

 Do not park the vehicle for an extended period straight after cleaning it, particularly after having cleaned the wheels with wheel cleaner. Wheel cleaners could cause increased corrosion of the brake discs and brake pads/linings. For this reason, you should drive for a few minutes after cleaning. Braking heats the brake discs and the brake pads/linings, thus drying them. The vehicle can then be parked.

Regular care of your vehicle is a condition for retaining the quality in the long term.

Use care products and cleaning agents recommended and approved by Mercedes-Benz.

Washing the vehicle and cleaning the paintwork

Automatic car wash

WARNING

Braking efficiency is reduced after washing the vehicle. This could cause an accident. For this reason, you must drive particularly carefully after washing the vehicle until the brakes have dried.

WARNING

The vehicle is braked when the HOLD function or DISTRONIC PLUS is activated. Therefore, deactivate the HOLD function and DISTRONIC PLUS before the vehicle is washed in an automatic car wash.

! It is preferable to use car washes with adjustable high-pressure pre-cleaning that corresponds to the specification for the Cabriolet program. In car washes that use high water pressures, there is a risk that a small amount of water may leak into the vehicle.

! Lock the car if you wash it in an automatic car wash. Otherwise, the vehicle might be damaged.

! Never clean your vehicle in a Touchless Automatic Car Wash as these use special cleaning agents. These cleaning agents can damage the paintwork or plastic parts.

! Make sure that the automatic transmission is in position **N** when washing your vehicle in a tow-through car wash. The vehicle could be damaged if the transmission is in another position.

! Make sure that:

- the side windows and roof are completely closed.
- the blower for the ventilation/heating is switched off (OFF button is depressed/ airflow control is turned to position **0**).
- the windshield wiper switch is at position **0**.

The vehicle could otherwise be damaged.

You can wash the vehicle in an automatic car wash from the very start.

If the vehicle is very dirty, pre-wash it before cleaning it in an automatic car wash.

After using an automatic car wash, wipe off wax from the windshield and the wiper blades. This will prevent smears and reduce wiping noises caused by residue on the windshield.

Washing by hand

In some countries, washing by hand is only allowed at specially equipped washing bays. Observe the legal requirements in all countries concerned.

- ▶ Do not use hot water and do not wash the vehicle in direct sunlight.
- ▶ Use a soft sponge to clean.
- ▶ Use a mild cleaning agent, such as a car shampoo approved by Mercedes-Benz.
- ▶ Thoroughly hose down the vehicle with a gentle jet of water.
- ▶ Do not point the water jet directly towards the air inlet.
- ▶ Use plenty of water and rinse out the sponge frequently.
- ▶ Rinse the vehicle with clean water and dry thoroughly with a chamois.
- ▶ Do not let the cleaning agent dry on the paintwork.

When using the vehicle in winter, remove all traces of road salt deposits carefully and as soon as possible.

Power washers

WARNING

Do not use power washers with circular-jet nozzles (dirt grinders) to clean your vehicle, in particular the tires. You could otherwise damage the tires and cause an accident.

- ❗ Always maintain a distance of at least 11.8 in (30 cm) between the vehicle and the power washer nozzle. Information about the correct distance is available from the equipment manufacturer.

Move the power washer nozzle around when cleaning your vehicle.

Do not aim directly at any of the following:

- tires
- door gaps, roof gaps, joints, etc.
- electrical components
- battery
- connectors
- lights
- seals
- trim
- ventilation slots

Damaged seals or electrical components can lead to leaks or failures.

- ❗ Do not use high-pressure cleaners if the tank recess is open while you clean it. This can cause damage to the seals or other components.

Cleaning the paintwork

- ❗ Do not affix:
 - stickers
 - films
 - magnetic plates or similar items
 to painted surfaces. You could otherwise damage the paintwork.

Scratches, corrosive deposits, areas affected by corrosion and damage caused by inadequate care cannot always be completely

repaired. In such cases, visit a qualified specialist workshop.

- ▶ Remove dirt immediately, where possible, while avoiding rubbing too hard.
- ▶ Soak insect remains with insect remover and rinse off the treated areas afterwards.
- ▶ Soak bird droppings with water and rinse off the treated areas afterwards.
- ▶ Remove coolant, brake fluid, tree resin, oils, fuels and greases by rubbing gently with a cloth soaked in petroleum ether or lighter fluid.
- ▶ Use tar remover to remove tar stains.
- ▶ Use silicone remover to remove wax.

If water no longer forms "beads" on the paint surface, use the paint care products recommended and approved by Mercedes-Benz. This is the case approximately every three to five months, depending on the climate conditions and the care product used.

If dirt has penetrated the paint surface or if the paint has become dull, the paint cleaner recommended and approved by Mercedes-Benz should be used.

Do not use these care products in the sun or on the hood while the hood is hot.

- ▶ Use a suitable touch-up stick, e.g. MB Touch-Up Stick, to repair slight damage to the paintwork quickly and provisionally.

Matte finish care

- ❗ Never polish the vehicle or the light alloy wheels. Polishing causes the finish to shine.
- ❗ The following may cause the paint to become shiny and thus reduce the matte effect:
 - Vigorous rubbing with unsuitable materials.
 - Frequent use of car washes.
 - Washing the vehicle in direct sunlight.
- ❗ Never use paint cleaner, buffing or polishing products, or gloss preserver, e.g.

wax. These products are only suitable for high-gloss surfaces. Their use on vehicles with matte finish leads to considerable surface damage (shiny, spotted areas).

Always have paintwork repairs carried out at a qualified specialist workshop.

- ❗ Do not use wash programs with a hot wax treatment under any circumstances.

Observe these notes if your vehicle has a clear matte finish. This will help you to avoid damage to the paintwork due to incorrect treatment.

These notes also apply to light alloy wheels with a clear matte finish.

- ❗ The vehicle should preferably be washed by hand using a soft sponge, car shampoo and plenty of water.
- ❗ Use only insect remover and car shampoo from the range of recommended and approved Mercedes-Benz care products.

Cleaning the vehicle parts

Cleaning the wheels

- ❗ Do not use acidic wheel cleaning products to remove brake dust. This could damage wheel bolts and brake components.
- ❗ Do not park the vehicle for an extended period straight after cleaning it, particularly after having cleaned the wheels with wheel cleaner. Wheel cleaners could cause increased corrosion of the brake discs and brake pads/linings. For this reason, you should drive for a few minutes after cleaning. Braking heats the brake discs and the brake pads/linings, thus drying them. The vehicle can then be parked.

Cleaning the windows

WARNING

Before cleaning the windshield or wiper blades, switch off the windshield wipers and remove the SmartKey from the ignition lock.

On vehicles with KEYLESS-GO, press the Start/Stop button repeatedly until all indicator lamps in the instrument cluster have gone out. The windshield wipers could otherwise move and injure you.

WARNING

Do not clean the rear window with the retractable hardtop (vario-roof) in a position other than the fully raised and closed position. Otherwise, the retractable hardtop may move unexpectedly which may result in personal injury to you or others.

- ❗ Do not use dry cloths, abrasive products, solvents or cleaning agents containing solvents to clean the inside of the windows. Do not touch the insides of the windows with hard objects, e.g. an ice scraper or ring. There is otherwise a risk of damaging the windows.
- ❗ Clean the water drainage channels of the windshield and the rear window at regular intervals. Deposits such as leaves, petals and pollen may under certain circumstances prevent water from draining away. This can lead to corrosion damage and damage to electronic components.
- ▶ Clean the inside and outside of the windows with a damp cloth and a cleaning agent that is recommended and approved by Mercedes-Benz.

Cleaning the wiper blades

WARNING

Before cleaning the windshield or wiper blades, switch off the windshield wipers and remove the SmartKey from the ignition lock. On vehicles with KEYLESS-GO, press the Start/Stop button repeatedly until all indicator lamps in the instrument cluster have gone out. The windshield wipers could otherwise move and injure you.

- ❗ Do not pull the wiper blade. Otherwise, the wiper blade could be damaged.

- ❗ Do not clean wiper blades too often and do not rub them too hard. Otherwise, the graphite coating could be damaged. This could cause wiper noise.
- ❗ Hold the wiper arm securely when folding back. The windshield could be damaged if the wiper arm smacks against it suddenly.
- ▶ Fold the windshield wiper arms away from the windshield.
- ▶ Carefully clean the wiper blades with a damp cloth.
- ▶ Fold the windshield wiper arms back again before switching on the ignition.

Cleaning the exterior lighting

- ❗ Only use cleaning agents or cleaning cloths which are suitable for plastic light lenses. Unsuitable cleaning agents or cleaning cloths could scratch or damage the plastic light lenses.
- ▶ Clean the plastic lenses of the exterior lighting using a wet sponge and a mild cleaning agent, e.g. Mercedes-Benz car shampoo or cleaning cloths.

Mirror turn signals

- ❗ Only use cleaning agents or cleaning cloths that are suitable for plastic lenses. Unsuitable cleaning agents or cleaning cloths could scratch or damage the plastic lenses of the mirror turn signals.
- ▶ Clean the plastic lenses of the mirror turn signals in the exterior mirror housing using a wet sponge and mild cleaning agent, e.g. Mercedes-Benz car shampoo or cleaning cloths.

Cleaning the sensors

- ❗ If you clean the sensors with a power washer, make sure that you keep a distance of at least 11.8 in (30 cm) between the vehicle and the power washer nozzle. Information about the correct distance is

available from the equipment manufacturer.

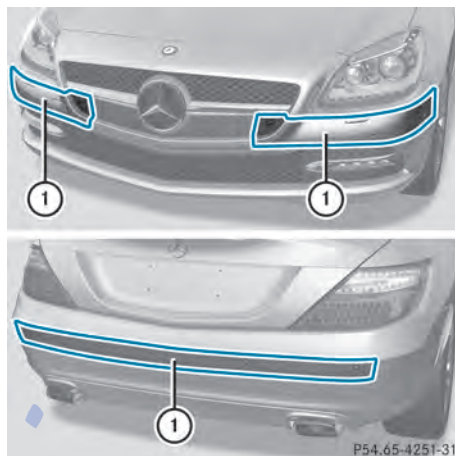

- ▶ Clean sensors ① of the driving systems with water, car shampoo and a soft cloth.

Cleaning the exhaust pipe

- ❗ Do not clean the exhaust pipe with acidic cleaning agents, such as sanitary or wheel cleaners.
- ▶ Clean the exhaust pipe with a chrome care product tested and approved by Mercedes-Benz.

Impurities combined with the effects of road grit and corrosive environmental factors may cause flash rust to form on the surface. You can restore the original shine of the exhaust pipe by cleaning it regularly, especially in winter and after washing.

Interior care

Cleaning the display

- ❗ For cleaning, do not use any of the following:
 - alcohol-based thinner or gasoline
 - abrasive cleaning agents
 - commercially-available household cleaning agents

These may damage the display surface. Do not put pressure on the display surface when cleaning. This could lead to irreparable damage to the display.

- ▶ Before cleaning the display, make sure that it is switched off and has cooled down.
- ▶ Clean the display surface using a commercially available microfiber cloth and TFT/LCD display cleaner.
- ▶ Dry the display surface using a dry microfiber cloth.

Cleaning the plastic trim

WARNING

When cleaning the steering wheel boss and dashboard, do not use cockpit sprays or cleaning agents containing solvents. Cleaning agents containing solvents cause the surface to become porous, and as a result, plastic parts may break away and be thrown around the interior when an air bag is deployed, which may result in severe injuries.

! Do not affix the following to plastic surfaces:

- stickers
- films
- scented oil bottles or similar items

You can otherwise damage the plastic.

! Do not allow cosmetics, insect repellent or sunscreen to come into contact with the plastic trim. This maintains the high-quality look of the surfaces.

- ▶ Wipe the plastic trim with a damp, lint-free cloth, e.g. a microfiber cloth.
- ▶ **Heavy soiling:** use car care and cleaning products recommended and approved by Mercedes-Benz. The surface may change color temporarily. Wait until the surface is dry again.

Cleaning the steering wheel and gear or selector lever

- ▶ Thoroughly wipe with a damp cloth or use leather care agents that have been recommended and approved by Mercedes-Benz.

Cleaning genuine wood and trim elements

! Do not use solvent-based cleaning agents such as tar remover, wheel cleaners, polishes or waxes. There is otherwise a risk of damaging the surface.

! Do not use chrome polish on trim pieces. The trim pieces have a chrome look but are mostly made of anodized aluminum and can lose their shine if chrome polish is used. Use a damp, lint-free cloth instead when cleaning the trim pieces.

If the chrome-plated trim pieces are very dirty, you can use a chrome polish. If you are unsure as to whether the trim pieces are chrome-plated or not, consult an authorized Mercedes-Benz Center.

- ▶ Wipe the wooden trim and trim pieces with a damp, lint-free cloth, e.g. a microfiber cloth.
- ▶ **Heavy soiling:** use car care and cleaning products recommended and approved by Mercedes-Benz.

Cleaning the seat covers

! Observe the following when cleaning:

- clean genuine leather covers carefully with a damp cloth and then wipe the covers down with a dry cloth. Make sure that the leather does not become soaked. It may otherwise become rough and cracked. Only use leather care agents that have been tested and approved by Mercedes-Benz. You can

obtain these from a qualified specialist workshop.

- clean artificial leather covers with a cloth moistened with a solution containing 1% detergent (e.g. dish washing liquid).
- clean cloth covers with a microfiber cloth moistened with a solution containing 1% detergent (e.g. dish washing liquid). Rub carefully and always wipe entire seat sections to avoid leaving visible lines. Let the seat dry afterwards. Cleaning results depend on the type of dirt and how long it has been there.
- clean DINAMICA covers with a damp cloth. Make sure that you wipe entire seat sections to avoid leaving visible lines.

! Do not use microfiber cloths to clean genuine leather, artificial leather or DINAMICA covers. If used often, these can damage the cover.

i Note that regular care is essential to ensure that the appearance and comfort of the covers is retained over time.

Cleaning the seat belts

WARNING

Do not bleach or dye seat belts as this may severely weaken them. In a crash, they may not be able to provide adequate protection.

- !** Do not clean the seat belts using chemical cleaning agents. Do not dry the seat belts by heating at temperatures above 176 °F (80 °C) or in direct sunlight.
- ▶ Use clean, lukewarm water and soap solution.

Cleaning the headliner and carpets

- ▶ **Headliner:** if it is very dirty, use a soft brush or dry shampoo.
- ▶ **Carpets:** use the carpet and textile cleaning agents recommended and approved by Mercedes-Benz.

امداد خودرو فارما

تلفن شبانه روزی: ۰۲۱-۸۸۸۶۲۰۸۵

FarmaSOS.com

Useful information	290
Where will I find...?	290
Flat tire	291
Battery (vehicle)	296
Jump-starting	299
Towing and tow-starting	301
Fuses	303

امداد خودرو فارما

تلفن شبانه روزی: ۰۲۱-۸۸۸۶۲۰۸۵

FarmaSOS.com

Useful information

- i** This Operator's Manual describes all models and all standard and optional equipment of your vehicle available at the time of publication of the Operator's Manual. Country-specific differences are possible. Please note that your vehicle may not be equipped with all features described. This also applies to safety-related systems and functions.
- i** Read the information on qualified specialist workshops: (▷ page 23).

Where will I find...?

Warning triangle

Removing the warning triangle

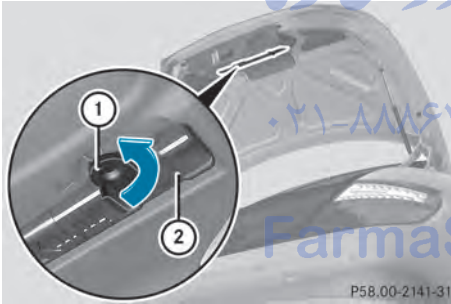

Warning triangle (2) is secured on the inside of the trunk lid.

- ▶ Open the trunk lid.
- ▶ Turn catch (1) in the direction of the arrow.
- ▶ Remove warning triangle (2).

Setting up the warning triangle

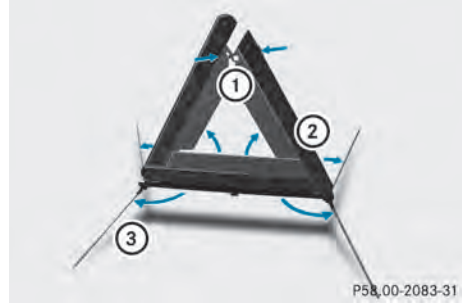

- ▶ Fold feet (3) down and out to the side.
- ▶ Pull side reflectors (2) upwards to form a triangle and lock them at the top using upper press-stud (1).

First-aid kit

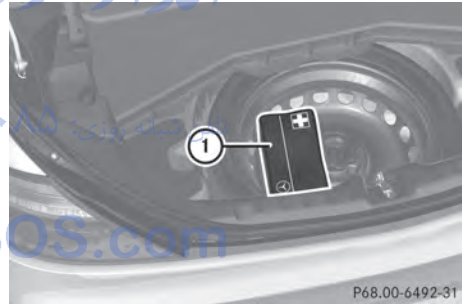

First-aid kit (1) is located in the trunk under the trunk floor.

- ▶ Open the trunk lid.
- ▶ Lift the trunk floor upwards (▷ page 258).
- ▶ Remove first-aid kit (1).

- i** Check the expiration date on the first-aid kit at least once a year. Replace the contents if necessary, and replace missing items.

Fire extinguisher

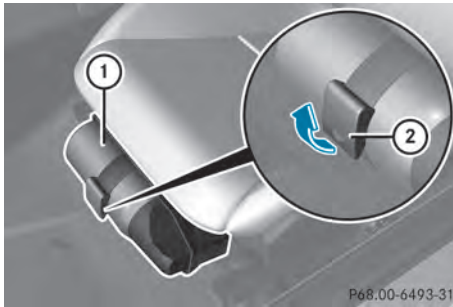

The fire extinguisher is located underneath the front of the driver's seat.

- ▶ Pull tab ② upwards.
- ▶ Remove fire extinguisher ①.

i Have fire extinguisher ① refilled after each use and checked every one to two years. It may otherwise fail in an emergency.

Observe the legal requirements in all countries concerned.

Vehicle tool kit

General notes

The vehicle tool kit can be found in the stowage well under the trunk floor.

i Apart from certain country-specific variations, vehicles are not equipped with a tire-change tool kit. Some tools for changing a wheel are specific to the vehicle. For more information on which tools are required to perform a wheel change on your vehicle, consult a qualified specialist workshop.

Necessary wheel-changing tools can include, for example:

- Jack
- Wheel chock
- Lug wrench
- Ratchet wrench
- Alignment bolt

Vehicles with a collapsible spare wheel

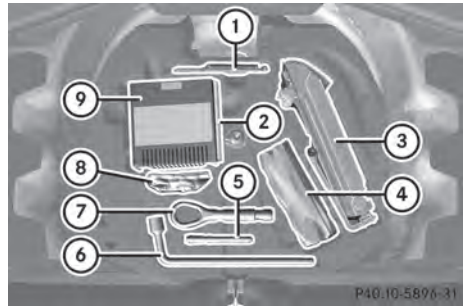

- ① Folding wheel chock
- ② Fuse allocation chart
- ③ Jack
- ④ Sheet for faulty wheel
- ⑤ Alignment bolt
- ⑥ Lug wrench
- ⑦ Towing eye
- ⑧ Valve extractor
- ⑨ Tire inflation compressor

- ▶ Lift the trunk floor up.
- ▶ Remove the collapsible spare wheel (▷ page 340).
- ▶ **AMG vehicles:** loosen the central screw of the bracket counter-clockwise and remove it together with the bracket.

Flat tire

Preparing the vehicle

Information on changing/mounting a wheel (▷ page 329).

Vehicle preparation is not necessary on vehicles with MOExtended tires.

Your vehicle may be equipped with:

- MOExtended tires (tires with run-flat characteristics) (▷ page 292)
- an emergency spare wheel (▷ page 339)

- ▶ Stop the vehicle on solid, non-slippery and level ground, as far away as possible from traffic.
- ▶ Switch on the hazard warning lamps.
- ▶ Secure the vehicle against rolling away (▷ page 155).
- ▶ Bring the front wheels into the straight-ahead position.
- ▶ Switch off the engine.
- ▶ **Vehicles without KEYLESS-GO:** remove the SmartKey from the ignition lock.
- ▶ **Vehicles with KEYLESS-GO:** open the driver's door.
The on-board electronics have status **0**, which is the same as the SmartKey having been removed.
- ▶ **Vehicles with KEYLESS-GO:** remove the Start/Stop button from the ignition lock (▷ page 136).
- ▶ All occupants must get out of the vehicle. Make sure that they are not endangered as they do so.
- ▶ Make sure that no one is near the danger area while a wheel is being changed.
Anyone who is not directly assisting in the wheel change should, for example, stand behind the barrier.
- ▶ Get out of the vehicle. Pay attention to traffic conditions when doing so.
- ▶ Close the driver's door.

MOExtended tires (tires with run-flat properties)

WARNING

When driving in emergency mode, the driving characteristics deteriorate, e.g. when cornering, accelerating quickly and when braking. There is a risk of an accident.

Do not exceed the stated maximum speed. Avoid abrupt steering and driving maneuvers, and driving over obstacles (curbs, potholes, off-road). This applies in particular to a laden vehicle.

Stop driving in emergency mode if:

- you hear banging noises.
- the vehicle starts to shake.
- you see smoke and smell rubber.
- ESP® is intervening constantly.
- there are tears in the sidewalls of the tire.

After driving in emergency mode, have the wheel rims checked at a qualified specialist workshop with regard to their further use. The defective tire must be replaced in every case.

With MOExtended tires (tires with run flat characteristics), you can continue to drive your vehicle even if there is a total loss of pressure in one or more tires.

MOExtended tires may only be used in conjunction with an active tire pressure loss warning system or with an active tire pressure monitor.

The maximum driving distance is approximately 50 miles (80 km) when the vehicle is partially laden, and approximately 18 miles (30 km) when the vehicle is fully laden.

In addition to the vehicle load, the driving distance possible depends upon:

- Speed
- Road condition
- Outside temperature

The driving distance possible in run-flat mode may be reduced by extreme driving conditions/maneuvers, or it can be increased through a moderate style of driving.

The maximum permissible distance which can be driven in run-flat mode is counted from the moment the tire pressure loss warning appears in the multifunction display.

You must not exceed a maximum speed of 50 mph (80 km/h).

- i** When changing or replacing one or all of the tires, note the label "MOExtended". Take note also of the size specified for the vehicle.

- i** Vehicles equipped with MOExtended tires are not equipped with a TIREFIT kit at the factory. It is therefore recommended that you additionally equip your vehicle with a TIREFIT kit if you mount tires that do not feature run-flat properties, e.g. winter tires. A TIREFIT kit is available, for example, from a qualified specialist workshop.

TIREFIT kit

Using the TIREFIT kit

TIREFIT is a tire sealant.

TIREFIT can be used to seal small punctures of up to 0.16 inches (4 mm), particularly on the tire tread. You can use TIREFIT at outside temperatures down to -4 °F (-20 °C).

WARNING

In the following situations, the tire sealant is unable to provide sufficient breakdown assistance, as it is unable to seal the tire properly:

- there are cuts or punctures in the tire larger than those mentioned above.
- the wheel rim is damaged.
- you have driven at very low tire pressures or on a flat tire.

There is a risk of an accident.

Do not drive any further. Contact a qualified specialist workshop.

WARNING

The tire sealant is harmful and causes irritation. It must not come into contact with your skin, eyes or clothing or be swallowed. Do not inhale TIREFIT fumes. Keep tire sealant away from children. There is a risk of injury.

If you come into contact with the tire sealant, observe the following:

- Rinse off the tire sealant from your skin immediately with water.
- If the tire sealant comes into contact with your eyes, immediately rinse them thoroughly with clean water.
- If tire sealant is swallowed, immediately rinse your mouth out thoroughly and drink plenty of water. Do not induce vomiting, and seek medical attention immediately.
- Immediately change out of clothing which has come into contact with tire sealant.
- If an allergic reaction occurs, seek medical attention immediately.

- !** Do not operate the tire inflation compressor for longer than eight minutes at a time without a break. It may otherwise overheat.

The tire inflation compressor can be operated again once it has cooled down.

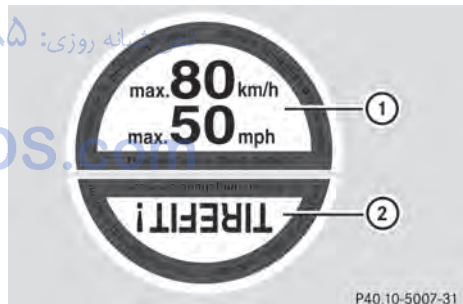

TIREFIT sticker, 2-part

- ▶ Do not remove any foreign objects which have penetrated the tire, e.g. screws or nails.
- ▶ Remove the tire sealant bottle, the accompanying TIREFIT sticker and the tire inflation compressor from the stowage well underneath the trunk floor (▶ page 291).
- ▶ Affix part ① of the TIREFIT sticker within the driver's field of vision.
- ▶ Affix part ② of the TIREFIT sticker near the valve on the wheel with the defective tire.

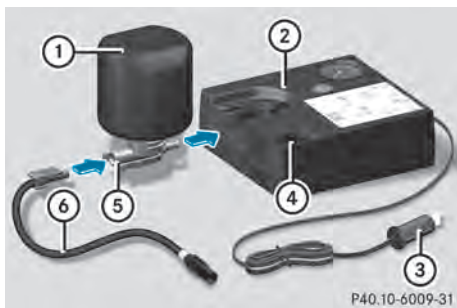

- ▶ Remove filler hose (6) and plug (3) from the bottom section of the tire inflation compressor housing.
- ▶ Slide the yellow filler hose connector into the mounting on yellow cap (5) of tire sealant bottle (1) until the plug engages.
- ▶ With the sealing rings in front, slide yellow cap (5) of tire sealant bottle (1) into the mounting of tire inflation compressor (2) until the cap and both hooks engage.

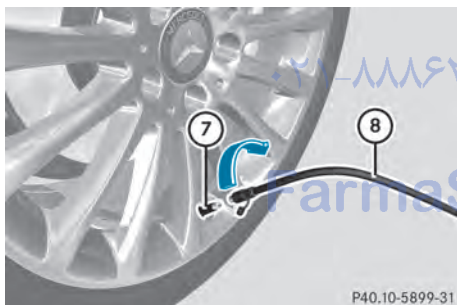

- ▶ Remove the cap from valve (7) on the faulty tire.
- ▶ Screw filler hose (8) onto valve.
- ▶ Insert plug (3) into the socket of the cigarette lighter (▷ page 261) or into a 12 V power socket in your vehicle (▷ page 261).
- ▶ Turn the SmartKey to position 1 (▷ page 135) in the ignition lock.
- ▶ Press on/off switch (4) on the tire inflation compressor to **ON**.
The tire inflation compressor is switched on. The tire is inflated.

i First, tire sealant is pumped into the tire. The pressure can briefly rise to approximately 500 kPa (5 bar/73 psi).

Do not switch off the tire inflation compressor during this phase.

- ▶ Let the tire inflation compressor run for a maximum of ten minutes. The tire should then have attained a pressure of at least 200 kPa (2.0 bar/29 psi).

If a pressure of 200 kPa (2.0 bar/29 psi) has been attained after a maximum of after ten minutes, see (▷ page 295).

If a pressure of 200 kPa (2.0 bar/29 psi) has not been attained after a maximum of ten minutes, see (▷ page 294).

i If tire sealant leaks out, allow it to dry. It can then be removed like a layer of film.

If your clothes are soiled with tire sealant, have them cleaned with perchloroethylene at a dry cleaner as soon as possible.

Tire pressure of at least 180 kPa (1.8 bar/26 psi) is not reached

If a maximum pressure 200 kPa (2.0 bar/29 psi) has not been attained after a maximum of ten minutes:

- ▶ Switch off the tire inflation compressor.
- ▶ Unscrew the filler hose from the valve of the faulty tire.
- ▶ Very slowly drive forwards or reverse approximately 30 ft (10 m).
- ▶ Pump up the tire again.

After a maximum of ten minutes, the tire pressure must be at least 200 kPa (2.0 bar/29 psi).

⚠ WARNING

If the required tire pressure is not reached after the specified time, the tire is too badly damaged. The tire sealant cannot repair the tire in this instance. Damaged tires and a tire pressure that is too low can significantly impair the vehicle's braking and driving characteristics. There is a risk of accident.

Do not continue driving. Contact a qualified specialist workshop.

Tire pressure of 180 kPa (1.8 bar/ 26 psi) is reached

WARNING

A tire temporarily sealed with tire sealant impairs the driving characteristics and is not suitable for higher speeds. There is a risk of accident.

You should therefore adapt your driving style accordingly and drive carefully. Do not exceed the specified maximum speed with a tire that has been repaired using tire sealant.

- ❗ Residue from the tire sealant may come out of the filler hose after use. This could cause stains.

Therefore, place the filler hose in the plastic bag which contained the TIREFIT kit.

Environmental note

Have the used tire sealant bottle disposed of professionally, e.g. at a qualified specialist workshop.

If a pressure of 200 kPa (2.0 bar/29 psi) has been attained after a maximum of ten minutes:

- ▶ Switch off the tire inflation compressor.
- ▶ Unscrew the filler hose from the valve of the faulty tire.
- ▶ Stow the tire sealant bottle and the tire inflation compressor.
- ▶ **Pull away immediately.**
The maximum speed for a tire sealed with tire sealant is 50 mph (80 km/h). The upper part of the TIREFIT sticker must be affixed to the instrument cluster in the driver's field of vision.
- ▶ Stop after driving for approximately ten minutes and check the tire pressure with the tire inflation compressor.
The tire pressure must now be at least 130 kPa (1.3 bar/19 psi).

WARNING

If the required tire pressure is not reached after driving for a short period, the tire is too badly damaged. The tire sealant cannot repair the tire in this instance. Damaged tires and a tire pressure that is too low can significantly impair the vehicle's braking and driving characteristics. There is a risk of accident.
Do not continue driving. Contact a qualified specialist workshop.

- ▶ Correct the tire pressure if it is still at least 130 kPa (1.3 bar/19 psi) (for the values, see the Tire and Loading Information placard on the B-pillar on the driver's side or tire pressure table on the fuel filler flap).
- ▶ **To increase the tire pressure:** switch on the tire inflation compressor.

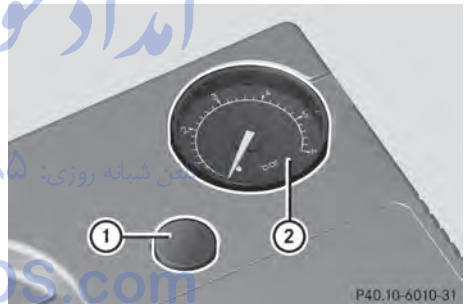

- ▶ **To reduce the tire pressure:** depress pressure release button (1) next to pressure gauge (2).
- ▶ If the tire pressure is correct, unscrew the filler hose from the valve of the repaired tire.
- ▶ Screw the valve cap onto the valve of the repaired tire.

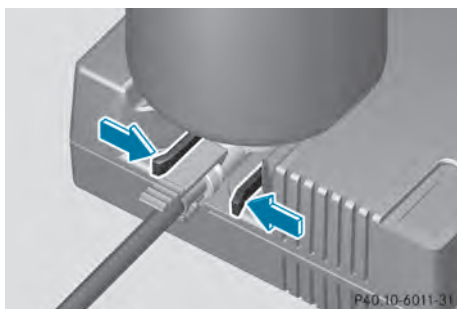

- ▶ To remove the tire sealant bottle from the tire inflation compressor, press together the locking tabs on the yellow cap.
- ▶ Pull the tire sealant bottle out of the tire inflation compressor.
The filler hose remains attached to the tire sealant bottle.
- ▶ Stow the tire sealant bottle and the tire inflation compressor.
- ▶ Drive to the nearest qualified specialist workshop and have the tire changed there.
- ▶ Have the tire sealant bottle and the filler hose replaced as soon as possible at a qualified specialist workshop.
- ▶ Have the tire sealant bottle replaced every four years at a qualified specialist workshop.

Battery (vehicle)

Important safety notes

Special tools and expert knowledge are required when working on the battery, e.g. removal and installing. You should therefore have all work involving the battery carried out at a qualified specialist workshop.

WARNING

Work carried out incorrectly on the battery can, for example, lead to a short circuit and damage your vehicle's electronic system. This can disrupt driving safety systems such as ABS (anti-lock braking system) or ESP® (Electronic Stability Program).

- If ABS malfunctions, the wheels can lock during braking. This limits the steerability of the vehicle when braking and the braking distance may increase. There is a risk of accident.
- If ESP® malfunctions, the vehicle will not be stabilized if it starts to skid or a wheel starts to spin. There is a risk of accident.

You should therefore have all work involving the battery carried out at a qualified specialist workshop.

WARNING

Comply with safety precautions and take protective measures when handling batteries.

Risk of explosion



Fire, open flames and smoking are prohibited when handling the battery. Avoid creating sparks.



Battery acid is caustic. Avoid contact with the skin, eyes or clothing.



Wear suitable protective clothing, in particular gloves, an apron and a face mask.

Immediately rinse acid splashes off with clean water. Consult a doctor if necessary.

Wear eye protection.



Keep children away.



Observe this Operator's Manual.



 **WARNING**

Failure to follow these instructions can result in severe injury or death.

Never lean over batteries while connecting. You might get injured.

Battery fluid contains sulfuric acid. Do not allow this fluid to come in contact with eyes, skin or clothing. In case it does, immediately flush affected area with water and seek medical help if necessary.

A battery will also produce hydrogen gas, which is flammable and explosive. Keep flames or sparks away from battery, avoid improper connection of jumper cables, smoking etc.

 **WARNING**

Do not place any metal objects on the battery as this could result in a short circuit.

Use leak-proof batteries only to avoid the risk of acid burns in the event of an accident.

Take care that you do not become statically charged, e.g. by wearing synthetic clothing or rubbing against textiles. For this reason, you also should not pull or push the battery over carpets or other synthetic materials.

Never touch the battery first. First, touch the outside body of the vehicle in order to release any possible electrostatic charges.

Do not rub the battery with rags or cloths. The battery could explode if touched due to electrostatic charge or due to spark formation.

 **Environmental note**





Batteries contain dangerous substances. It is against the law to dispose of them with the household rubbish. They must be collected separately and recycled to protect the environment.



Dispose of batteries in an environmentally friendly manner. Take discharged

batteries to a qualified specialist workshop or a special collection point for used batteries.

 Have the battery checked regularly at a qualified specialist workshop. Observe the service intervals in the Maintenance Booklet or contact a qualified specialist workshop for more information.

 You should have all work involving the battery carried out at a qualified specialist workshop. In the exceptional case that it is necessary for you to disconnect the battery yourself, make sure that:

- you switch off the engine and remove the key. On vehicles with KEYLESS-GO, ensure that the ignition is switched off. Check that all the indicator lamps in the instrument cluster are off. Otherwise, electronic components, such as the alternator, may be damaged.
- you first remove the negative terminal clamp and then the positive terminal clamp. Never swap the terminal clamps. Otherwise, the vehicle's electronic system may be damaged.
- in vehicles with automatic transmission, the transmission is locked in position **P** after disconnecting the battery. The vehicle is secured against rolling away. You can then no longer move the vehicle.

The battery and the cover of the positive terminal clamp must be installed securely during operation.

In order for the battery to achieve the maximum possible service life, it must always be sufficiently charged.

The vehicle battery, like other batteries, can discharge over time if you do not use the vehicle. In this case, have the battery disconnected at a qualified specialist workshop. You can also charge the battery with a charger recommended by Mercedes-

Benz. Contact a qualified specialist workshop for further information.

Have the battery charge level checked more frequently if you use the vehicle mainly for short trips or if you leave it standing idle for a lengthy period. Consult a qualified specialist workshop if you wish to leave your vehicle parked for a long period of time.

- ❶ Remove the SmartKey if you park the vehicle and do not require any electrical consumers. The vehicle will then use very little energy, thus conserving battery power.
- ❶ If the power supply has been interrupted, e.g. if you reconnect the battery, you will have to:
 - set the clock; see the separate operating instructions.

On vehicles with COMAND and a navigation system, the clock is set automatically.

 - reset the function for folding the exterior mirrors in/out automatically, by folding the mirrors out once (▷ page 101).

⚠ WARNING

There is a risk of acid burns during the charging process due to the gases which escape from the battery. Do not lean over the battery during the charging process.

⚠ WARNING

Battery acid is caustic. Avoid contact with the skin, eyes or clothing.

- ❗ Only use battery chargers with a maximum charging voltage of 14.8 V.

- ❗ Only charge the battery using the jump-starting connection point.

The jump-starting connection point is in the engine compartment.

Read the battery charger's operating instructions before charging the battery.

- ▶ Open the hood (▷ page 276).
- ▶ Connect the battery charger to the positive terminal and ground point in the same order as when connecting the donor battery in the jump-starting procedure (▷ page 299).

Charging the battery

⚠ WARNING

Never charge a battery still installed in the vehicle unless a battery charger unit approved by Mercedes-Benz is being used. Gases may escape during charging and cause explosions that may result in paint damage, corrosion or personal injury.

A battery charger unit specially adapted for Mercedes-Benz vehicles and tested and approved by Mercedes-Benz is available as an accessory. It permits the charging of the battery in its installed position. Contact an authorized Mercedes-Benz Center for further information and availability.

Charge the battery in accordance with the separate instructions for the battery charger.

Jump-starting

WARNING

Failure to follow these directions will cause damage to the electronic components, and can lead to a battery explosion and severe injury or death.

Never lean over batteries while connecting or jump starting. You might get injured.

Battery fluid contains sulfuric acid. Do not allow this fluid to come in contact with eyes, skin or clothing. In case it does, immediately flush affected area with water, and seek medical help if necessary.

A battery will also produce hydrogen gas, which is flammable and explosive. Keep flames or sparks away from battery, avoid improper connection of jumper cables, smoking, etc.

Attempting to jump start a frozen battery can result in it exploding, causing personal injury. Read all instructions before proceeding.

WARNING

Non-combusted fuel can collect in the exhaust system and ignite. There is a risk of fire. Avoid repeated and lengthy starting attempts.

- !** Avoid repeated and lengthy starting attempts. Otherwise, the catalytic converter could be damaged by the non-combusted fuel.

Do not start the vehicle using a rapid charging device. If your vehicle's battery is discharged, the engine can be jump-started from another vehicle or from a second battery using jumper cables. Observe the following points:

- The battery is not accessible in all vehicles. If the other vehicle's battery is not accessible, jump-start the vehicle using a second battery or a jump-starting device.
- You may only jump-start the vehicle when the engine and exhaust system are cold.
- Do not start the engine if the battery is frozen. Let the battery thaw first.
- Only jump-start from batteries with a 12 V voltage rating.
- Only use jumper cables which have a sufficient cross-section and insulated terminal clamps.
- If the battery is fully discharged, leave the battery that is being used to jump-start connected for a few minutes before attempting to start. This charges the empty battery a little.
- Make sure that the two vehicles do not touch.

Make sure that:

- the jumper leads are not damaged.
 - when the jumper cables are connected to the battery, uninsulated sections of the terminal clamp do not come into contact with other metal sections.
 - the jumper cables cannot come into contact with parts such as the V-belt pulley or the fan. These parts move when the engine is started and while it is running.
- ▶ Secure the vehicle by applying the electric parking brake.
 - ▶ **Manual transmission:** engage neutral.
 - ▶ **Automatic transmission:** move the selector lever to position **P**.

- ▶ Switch off all electrical consumers (e.g. radio, blower, etc.).
- ▶ Open the hood (▶ page 276).

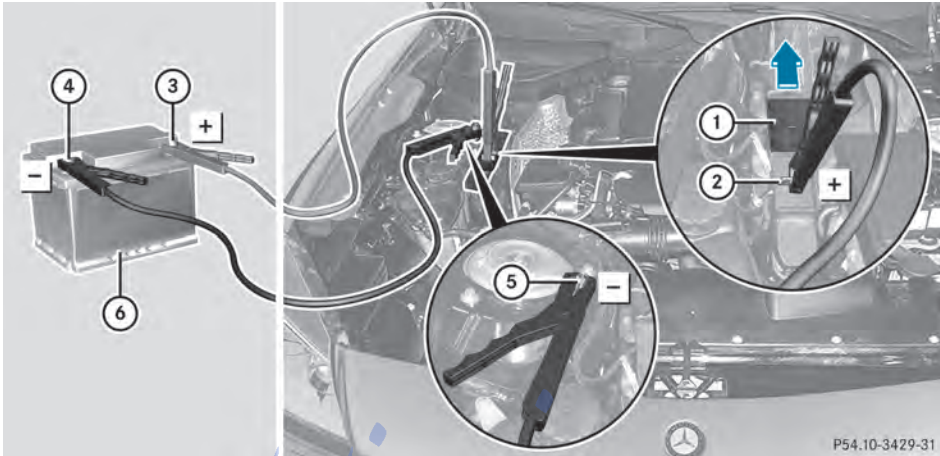

Position number ⑥ identifies the charged battery of the other vehicle or an equivalent jump-starting device.

- ▶ Slide cover ① of positive terminal ② in the direction of the arrow.
 - ▶ Connect positive terminal ② on your vehicle to positive terminal ③ of donor battery ⑥ using the jumper cable, always begin with positive terminal ② on your own vehicle first.
 - ▶ Start the engine of the donor vehicle and run it at idling speed.
 - ▶ Connect negative terminal ④ of donor battery ⑥ to ground point ⑤ of your vehicle using the jumper cable, connecting the jumper cable to donor battery ⑥ first.
 - ▶ Start the engine.
 - ▶ Before disconnecting the jumper cables, let the engine run for several minutes.
 - ▶ First, remove the jumper cables from ground point ⑤ and negative terminal ④, then from positive terminal ② and positive terminal ③, each time beginning at the contacts on your own vehicle first.
 - ▶ Close cover ① of positive terminal ② after removing the jumper cables.
 - ▶ Have the battery checked at a qualified specialist workshop.
- i** Jump-starting is not considered to be a normal operating condition.
- i** Jumper cables and further information regarding jump starting can be obtained at any qualified specialist workshop.

Towing and tow-starting

Important safety notes

WARNING

If you tow the vehicle, you must use a rigid towing bar if:

- the engine is not running.
- there is a brake system malfunction.
- there is a malfunction in the power supply or the vehicle's electrical system.





The power assistance for the steering and the brake force booster do not work when the engine is not running. You will need more force to steer and brake, you may have to depress the brake pedal with maximum force.

Before towing away, make sure that the steering can be moved and is not locked.



If you tow or tow-start another vehicle, its weight must not exceed the maximum permissible gross vehicle weight of your vehicle.

WARNING

The vehicle is braked when the HOLD function or DISTRONIC PLUS is activated. Therefore, deactivate HOLD and DISTRONIC PLUS if the vehicle is to be towed.

-  Only secure the tow rope or tow bar at the towing eyes. Otherwise, the vehicle could be damaged.
-  Do not use the towing eye for recovery, this could damage the vehicle. If in doubt, recover the vehicle with a crane.
-  When towing, pull away slowly and smoothly. If the tractive power is too high, the vehicles could be damaged.
-  Do not tow with sling-type equipment. This could damage the vehicle.
-  On vehicles with KEYLESS-GO, use the SmartKey instead of the Start/Stop button. Turn the SmartKey to position **2** in the ignition lock and shift the automatic

transmission to **N**. Then, turn the SmartKey back to **0** and leave it in the ignition lock.

-  Make sure that the electric parking brake is released. If the electric parking brake is faulty, visit a qualified specialist workshop.
-  The vehicle can be towed a maximum of 30 miles (50km). The towing speed of 30 mph (50 km/h) must not be exceeded. If the vehicle has to be towed more than 30 miles (50km), the entire vehicle must be raised and transported.
-  If you tow or tow-start another vehicle, its weight must not exceed the maximum permissible gross vehicle weight of your vehicle.

Information on your vehicle's gross vehicle weight rating can be found on the vehicle identification plate (▷ page 347).

It is better to have the vehicle transported than to have it towed.

Vehicles with automatic transmission:

when towing a vehicle, the automatic transmission must be in position **N**.

The battery must be connected and charged. Otherwise, you:

- cannot turn the SmartKey to position **2** in the ignition lock
- cannot shift the transmission to position **N** on vehicles with automatic transmission

Vehicles with automatic transmission:

release the selector lever lock manually to move it out of position **P** (▷ page 152).

-  Deactivate the automatic locking feature (▷ page 206). You could otherwise be locked out when pushing or towing the vehicle.

Installing/removing the towing eye

Installing the towing eye

WARNING

The exhaust tail pipe may be hot. You could burn yourself if you touch the tail pipe. Be particularly careful when removing the rear cover.



The mountings for the removable towing eyes are located in the bumpers. They are at the front and at the rear, under the covers.

- ▶ Press the mark on cover ① inwards in the direction of the arrow.
- ▶ Take cover ① off the opening.
- ▶ Remove the towing eye from the vehicle tool kit (▷ page 291).
- ▶ Screw the towing eye in clockwise to the stop and tighten it.

Removing the towing eye

- ▶ Loosen the towing eye and unscrew it.
- ▶ Attach cover ① to the bumper and press until it engages.
- ▶ Place the towing eye in the vehicle tool kit.

Towing the vehicle with the rear axle raised

 The ignition must be switched off if you are towing the vehicle with the rear axle raised. Intervention by ESP® could otherwise damage the brake system.

- ▶ Switch on the hazard warning lamps (▷ page 109).
- ▶ Turn the SmartKey to position **0** in the ignition lock and remove the SmartKey from the ignition lock.
- ▶ When leaving the vehicle, take the SmartKey or the KEYLESS-GO key with you.

When towing your vehicle with the rear axle raised, it is important that you observe the safety instructions (▷ page 301).

Towing a vehicle with both axles on the ground

WARNING

The power assistance for the steering and the brake force booster do not work when the engine is not running. You will then need much more effort to brake and steer the vehicle. Adapt your style of driving accordingly.

- ▶ Switch on the hazard warning lamps (▷ page 109).
-  When towing with the hazard warning lamps switched on, use the combination switch as usual to signal a change of direction. In this case, only the turn signals for the desired direction flash. When the combination switch is reset, the hazard warning lamps start flashing again.
- ▶ Turn the SmartKey to position **2** in the ignition lock.
- ▶ When the vehicle is stationary, depress the brake pedal and keep it depressed.
- ▶ **Vehicles with manual transmission:** depress the clutch pedal.
- ▶ Shift to neutral.

or

- ▶ **Vehicles with automatic transmission:** shift the automatic transmission to position **N**.
- ▶ Release the brake pedal.
- ▶ Release the electric parking brake.

It is important that you observe the safety instructions when towing away your vehicle (▷ page 301).

Transporting the vehicle

- ❗ Only lash the vehicle down by the wheels or wheel rims, not by parts of the vehicle such as axle or steering components. Otherwise, the vehicle could be damaged.

The towing eye can be used to pull the vehicle onto a trailer or transporter for transporting purposes.

- ▶ **Vehicles with manual transmission:** shift to neutral.
- ▶ **Vehicles with automatic transmission:** turn the SmartKey to position **2** in the ignition lock.
- ▶ Move the selector lever to **N**.

As soon as the vehicle is loaded:

- ▶ Prevent the vehicle from rolling away by applying the electric parking brake.
- ▶ **Vehicles with manual transmission:** shift to first gear or reverse gear.
- ▶ **Vehicles with automatic transmission:** move the selector lever to **P**.
- ▶ Turn the SmartKey to position **0** in the ignition lock and remove the SmartKey from the ignition lock.
- ▶ Secure the vehicle.

Tow-starting (emergency starting)

- ❗ Vehicles with an automatic transmission must not be tow-started. You could otherwise damage the automatic transmission.

You can find information on "Jump-starting" at (▷ page 299).

When tow-starting, it is important that you observe the safety instructions (▷ page 301).

- ▶ Switch on the hazard warning lamps (▷ page 109).
- ▶ Install the towing eye (▷ page 302).
- ▶ Secure the rigid towing bar or the towing rope.
- ▶ Depress and hold the brake pedal.
- ▶ Turn the SmartKey to position **2** in the ignition lock.
- ▶ Depress the clutch pedal and keep it depressed.
- ▶ Shift to neutral.
- ▶ Release the brake pedal.
- ▶ Tow-start the vehicle.
- ▶ Shift to second gear.
- ▶ Release the clutch pedal slowly; do not depress the accelerator pedal while doing so.
- ▶ The engine is started.
- ▶ Depress the clutch pedal and shift to neutral.
- ▶ Stop at a suitable place.

- ▶ Apply the electric parking brake.
- ▶ Remove the rigid towing bar or towing rope.
- ▶ Remove the towing eye (▷ page 302).
- ▶ Switch off the hazard warning lamps.

Before tow-starting the following conditions must be fulfilled:

- the battery is connected.
- the engine has cooled down.
- the exhaust system has cooled down.

Fuses

Important safety notes

WARNING

Only use fuses that have been approved for Mercedes-Benz vehicles and that have the correct fuse rating for the systems

concerned. Do not attempt to repair or bridge faulty fuses. Using fuses that have not been approved or attempting to repair or bridge faulty fuses could cause the fuse to be overloaded and result in a fire. Have the cause traced and rectified at a qualified specialist workshop.

- ❗ Only use fuses that have been approved for Mercedes-Benz vehicles and which have the correct fuse rating for the system concerned. Otherwise, components or systems could be damaged.

The fuses in your vehicle serve to close down faulty circuits. If a fuse blows, all the components on the circuit and their functions stop operating.

Blown fuses must be replaced with fuses of the same rating, which you can recognize by the color and value. The fuse ratings are listed in the fuse allocation chart.

If a newly inserted fuse also blows, have the cause traced and rectified at a qualified specialist workshop, e.g. an authorized Mercedes-Benz Center.

Before changing a fuse

- ▶ Secure the vehicle against rolling away (▷ page 155).
- ▶ Switch off all electrical consumers.
- ▶ Turn the SmartKey to position **0** in the ignition lock and remove it (▷ page 135).

or

- ▶ On vehicles with KEYLESS-GO, make sure the ignition is switched off (▷ page 136).

All indicator lamps in the instrument cluster must be off.

The fuses are located in various fuse boxes:

- Fuse box in the engine compartment on the left-hand side of the vehicle, when viewed in the direction of travel
- Fuse box in the trunk

The fuse allocation chart is located in the vehicle tool kit in the stowage compartment under the trunk floor (▷ page 291).

Fuse box in the engine compartment

⚠ WARNING

Make sure that the windshield wipers are switched off and that the SmartKey is removed from the ignition lock before you open the cover of the fuse box. Otherwise, the windshield wipers and the wiper rods above the cover could be set in motion. This could lead to you or others being injured by the wiper rods.

- ❗ Make sure that no moisture can enter the fuse box when the cover is open.

- ❗ When closing the cover, make sure that it is lying correctly on the fuse box. Moisture seeping in or dirt could otherwise impair the operation of the fuses.

- ▶ Make sure that the windshield wipers are turned off. تلفن شبانه ۰۸۸۶۲۰۸۸۶۲
- ▶ Open the hood.

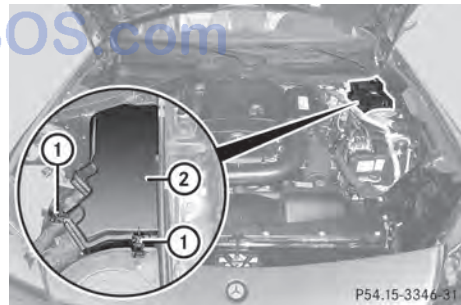

- ▶ Remove any existing moisture from the fuse box using a dry cloth.
- ▶ **To open:** open clamp ①.
- ▶ Remove fuse box cover ② forwards.

- ▶ **To close:** check whether the seal is seated correctly in cover ②.
- ▶ Insert cover ② at the rear of the fuse box into the retainer.
- ▶ Fold down cover ② and close clamps ①.
- ▶ Close the hood.

Fuse box in the trunk

- ❗ Make sure that no moisture can enter the fuse box when the cover is open.

The fuse box is located in the trunk behind the partition covering.

- ▶ Open the trunk lid.

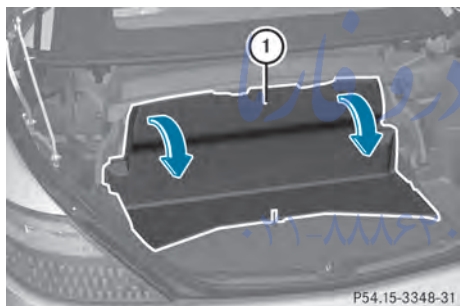

- ▶ **To open:** release cover ① on the right and left-hand sides with a flat object.
- ▶ Open cover ① downwards in the direction of the arrow.

امداد خودرو فارما

تلفن شبانه روزی: ۰۲۱-۸۸۸۶۲۰۸۵

FarmaSOS.com

Useful information	308
Important safety notes	308
Operation	308
Winter operation	310
Tire pressure	311
Loading the vehicle	319
All about wheels and tires	322
Changing a wheel	329
Wheel and tire combinations	335
Emergency spare wheel	339

امداد خودرو فارما

تلفن شبانه روزی: ۰۲۱-۸۸۸۶۲۰۸۵

FarmaSOS.com

Useful information

- 1 This Operator's Manual describes all models and all standard and optional equipment of your vehicle available at the time of publication of the Operator's Manual. Country-specific differences are possible. Please note that your vehicle may not be equipped with all features described. This also applies to safety-related systems and functions.
- i Read the information on qualified specialist workshops: (▷ page 23).

Important safety notes

WARNING

If wheels and tires of the wrong size are used, the wheel brakes or suspension components may be damaged. There is a risk of accident. Always replace wheels and tires with those that fulfill the specifications of the original part (designation, manufacturer, model).

WARNING

A flat tire severely impairs the driving, steering and braking characteristics of the vehicle. There is a risk of accident.

Tires without run-flat characteristics:

- do not drive with a flat tire.
- immediately replace the flat tire with your emergency spare wheel or spare wheel, or consult a qualified specialist workshop.

Tires with run-flat characteristics:

- pay attention to the information and warning notices on MOExtended tires (tires with run-flat characteristics).

Accessories that are not approved for your vehicle by Mercedes-Benz or are not being used correctly can impair the operating safety.

Before purchasing and using non-approved accessories, visit a qualified specialist workshop and inquire about:

- suitability
- legal stipulations
- factory recommendations

Information on dimensions and types of wheels and tires for your vehicle can be found (▷ page 335).

Information on air pressure for the tires on your vehicle can be found:

- on the vehicle's Tire and Loading Information placard on the B-pillar
- on the tire pressure label on the fuel filler flap
- under "tire pressure"

Operation

Information on driving

If the vehicle is heavily laden, check the tire pressures and correct them if necessary.

While driving, pay attention to vibrations, noises and unusual handling characteristics, e.g. pulling to one side. This may indicate that the wheels or tires are damaged. If you suspect that a tire is defective, reduce your speed immediately. Stop the vehicle as soon as possible to check the wheels and tires for damage. Hidden tire damage could also be causing the unusual handling characteristics. If you find no signs of damage, have the tires and wheels checked at a qualified specialist workshop.

When parking your vehicle, make sure that the tires do not get deformed by the curb or other obstacles. If it is necessary to drive over curbs, speed humps or similar elevations, try to do so slowly and at an obtuse angle.

Otherwise, the tires, particularly the sidewalls, may be damaged.

Regular checking of wheels and tires

WARNING

Damaged tires can cause tire inflation pressure loss. As a result, you could lose control of your vehicle. There is a risk of accident.

Check the tires regularly for signs of damage and replace any damaged tires immediately.

Regularly check the wheels and tires of your vehicle for damage at least once a month, as well as after driving off-road or on rough roads. Damaged wheels can cause a loss of tire pressure. Pay particular attention to damage such as:

- cuts in the tires
- punctures
- tears in the tires
- bulges on tires
- deformation or severe corrosion on wheels

Regularly check the tire tread depth and the condition of the tread across the whole width of the tire (▷ page 309). If necessary, turn the front wheels to full lock in order to inspect the inner side of the tire surface.

All wheels must have a valve cap to protect the valve against dirt and moisture. Do not mount anything onto the valve other than the standard valve cap or other valve caps approved by Mercedes-Benz for your vehicle. Do not use any other valve caps or systems, e.g. tire pressure monitoring systems.

Regularly check the pressure of all the tires particularly prior to long trips. Adjust the tire pressure as necessary (▷ page 311).

Observe the notes on the emergency spare wheel (▷ page 339).

The service life of tires depends on the following factors amongst other things:

- Driving style
- Tire pressure
- Distance covered

Tire tread

WARNING

Insufficient tire tread will reduce tire traction. The tire is no longer able to dissipate water. This means that on wet road surfaces, the risk of hydroplaning increases, in particular where speed is not adapted to suit the driving conditions. There is a risk of accident.

If the tire pressure is too high or too low, tires may exhibit different levels of wear at different locations on the tire tread. Thus, you should regularly check the tread depth and the condition of the tread across the entire width of all tires.

Minimum tire tread depth for:

- Summer tires: 1/8 in (3 mm)
- M+S tires: 1/6 in (4 mm)

For safety reasons, replace the tires before the legally prescribed limit for the minimum tire tread depth is reached.

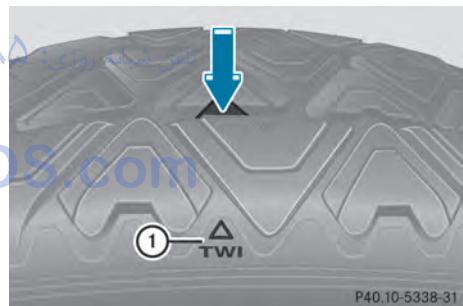

Bar indicator ① for tread wear is integrated into the tire tread.

Tread wear indicators (TWI) are required by law. Six indicators are positioned on the tire tread. They are visible once the tread depth is approximately 1/16 in (1.6 mm). If this is the case, the tire is so worn that it must be replaced.

Selecting, mounting and replacing tires

- Only mount tires and wheels of the same type and make.
- Only mount tires of the correct size onto the wheels.
- Break in new tires at moderate speeds for the first 60 miles (100 km). They only reach their full performance after this distance.
- Do not drive with tires which have too little tread depth, as this significantly reduces the traction on wet roads (hydroplaning).
- Replace the tires after six years at the latest, regardless of wear.

MOExtended tires (tires with run-flat properties)

With MOExtended tires (tires with run flat characteristics), you can continue to drive your vehicle even if there is a total loss of pressure in one or more tires.

MOExtended tires may only be used in conjunction with an active tire pressure loss warning system or with an active tire pressure monitor and on wheels specifically tested by Mercedes-Benz.

Notes on driving with MOExtended tires with a flat tire (▷ page 292).

- 1 Vehicles equipped with MOExtended tires are not equipped with a TIREFIT kit at the factory. It is therefore recommended that you additionally equip your vehicle with a TIREFIT kit if you mount tires that do not feature run-flat properties, e.g. winter tires. A TIREFIT kit can be obtained from a qualified specialist workshop.

Winter operation

General notes

Have your vehicle winterproofed at a qualified specialist workshop at the onset of winter.

Observe the notes in the "Changing a wheel" section (▷ page 329).

Driving with summer tires

At temperatures below 45 °F (+7 °C), summer tires lose elasticity and therefore traction and braking power. Change the tires on your vehicle to M+S tires. Using summer tires at very cold temperatures could cause cracks to form, thereby damaging the tires permanently. Mercedes-Benz cannot accept responsibility for this type of damage.

M+S tires

WARNING

M+S tires with a tire tread depth of less than $\frac{1}{8}$ in (4 mm) are not suitable for use in winter and do not provide sufficient traction. There is a risk of an accident.

M+S tires with a tread depth of less than $\frac{1}{8}$ in (4 mm) must be replaced immediately.

At temperatures below 45 °F (+7 °C) use winter tires or all-season tires. Both types of tire are identified by the M+S marking.

Only winter tires bearing the  snowflake symbol in addition to the M+S marking provide the best possible grip in wintry road conditions.

Only these tires will allow driving safety systems such as ABS and ESP® to function optimally in winter. These tires have been developed specifically for driving in snow. Use M+S tires of the same make and tread on all wheels to maintain safe handling characteristics.

Always observe the maximum permissible speed specified for the M+S tires you have mounted.

When you have mounted M+S tires:

- ▶ Check the tire pressures (▷ page 315).
- ▶ **Vehicles for USA:** restart the tire pressure monitor (▷ page 316).
- ▶ **Vehicles for Canada:** restart the tire pressure loss warning system (▷ page 315).

For more information on driving with the emergency spare wheel, see (▷ page 339).

Snow chains

WARNING

If snow chains are installed to the front wheels, they may drag against the vehicle body or chassis components. This could cause damage to the vehicle or the tires. There is a risk of an accident.

To avoid hazardous situations:

- never install snow chains to the front wheels
- always install snow chains in pairs to the rear wheels.

! You must drive at raised vehicle level (level 1) if snow chains have been mounted. The vehicle may otherwise be damaged.

! On some tire sizes there is not enough space for snow chains. To avoid damage to the vehicle or tires, observe the "Wheel and tire combinations" section under "Tires and wheels".

! **Vehicles with steel wheels:** if you wish to mount snow chains on steel wheels, make sure that you remove the respective wheels' hubcaps first. The hubcaps may otherwise be damaged.

For safety reasons, Mercedes-Benz recommends that you only use snow chains that have been specially approved for your vehicle by Mercedes-Benz, or are of a corresponding standard of quality.

If you intend to mount snow chains, please bear the following points in mind:

- Snow chains may not be mounted on all wheel/tire combinations. Permissible wheel-tire combinations (▷ page 335).
- Only use snow chains when driving on roads completely covered by snow. Remove the snow chains as soon as possible when you come to a road that is not snow-covered.
- Local regulations may restrict the use of snow chains. Observe the appropriate regulations if you wish to install snow chains.
- Do not exceed the maximum permissible speed of 30 mph (50 km/h).

i You may wish to deactivate ESP® when pulling away with snow chains installed (▷ page 61). This way you can allow the wheels to spin in a controlled manner, achieving an increased driving force (cutting action).

For more information on driving with the emergency spare wheel, see (▷ page 339).

Tire pressure

Tire pressure specifications

Important safety notes

WARNING

Tires with tire pressures that are too low or too high are associated with the following hazards:

- they can burst, in particular if the vehicle is heavily laden or when driven at high speeds.
- the tires can wear excessively and/or unevenly, which can severely impair tire traction.
- the driving, steering and braking characteristics may be severely impaired.

There is a risk of accident.

Follow recommended tire inflation pressures and check the pressure of all the tires including the spare wheel:

- monthly, at least
- if the load changes
- before beginning a long journey
- under different operating conditions, e.g. off-road driving

If necessary, correct the tire pressure.

- i** The specifications on the sample Tire and Loading Information placard and tire pressure tables are examples. Tire pressure specifications are vehicle-specific and may deviate from the data shown here. The tire pressure specifications that are valid for your vehicle can be found on the Tire and Loading Information placard and tire pressure table on the vehicle.

General notes

The recommended tire pressures for the tires mounted at the factory can be found on the labels described here.

Operation with the emergency spare wheel (▷ page 339).

Further information on tire pressures can be obtained at a qualified specialist workshop.

Tire and Loading Information placard

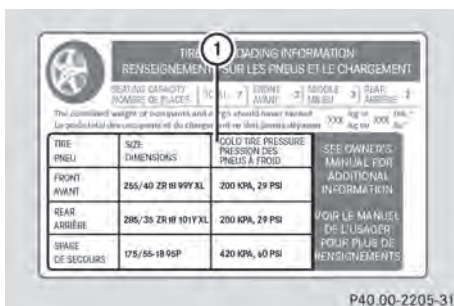

- 1** Recommended tire pressures

The Tire and Loading Information placard is on the B-pillar on the driver's side (▷ page 319).

The Tire and Loading Information placard contains the recommended tire pressures for cold tires. The recommended tire pressures are valid for the maximum permissible load and up to the maximum permissible vehicle speed.

Tire pressure table

The tire pressure table is on the inside of the fuel filler flap.

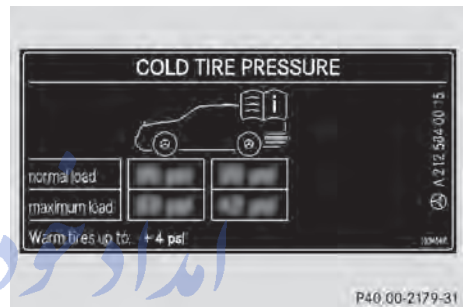

Example: tire pressure table for all tires permitted for this vehicle by the factory

The tire pressure table contains the recommended pressures for cold tires for various operating conditions, i.e. differing load and speed conditions.

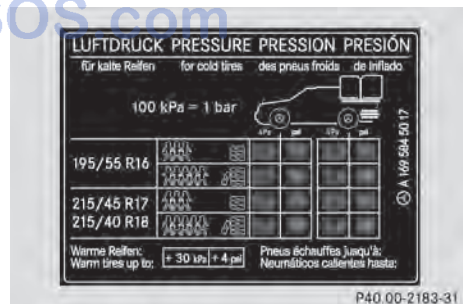

Example: tire pressure table with tire dimensions

If a tire size precedes a tire pressure, the tire pressure information following is only valid for that tire size. The load conditions "partially laden" and "fully laden" are defined in the table for different numbers of occupants and amounts of luggage. The actual number of seats may differ.

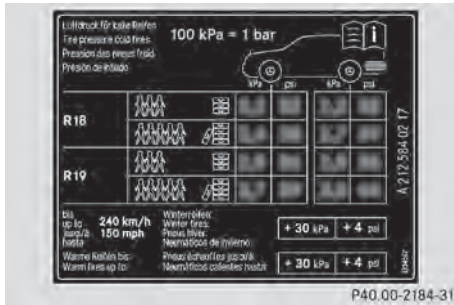

Some tire pressure tables show only the rim diameters instead of the full tire size, e.g.

R18. The rim diameter is part of the tire size and can be found on the tire sidewall (▷ page 323).

If the tire pressures have been set to the lower values for lighter loads and/or lower road speeds, the pressures should be reset to the higher values:

- if you want to drive with an increased load and/or
- if you want to drive at higher road speeds.

i The tire pressures for increased loads and/or higher road speeds, shown in the tire pressure table, may have a negative effect on driving comfort.

If the tire pressure is not set correctly, this can lead to an excessive build up of heat and a sudden loss of pressure.

For more information, contact a qualified specialist workshop.

Important notes on tire pressure

! WARNING

If the tire pressure drops repeatedly, the wheel, valve or tire may be damaged. Tire pressure that is too low may result in a tire blow-out. There is a risk of an accident.

- Check the tire for foreign objects.
- Check whether the wheel is losing air or the valve is leaking.

If you are unable to rectify the damage, contact a qualified specialist workshop.

! WARNING

If you fit unsuitable accessories onto tire valves, the tire valves may be overloaded and malfunction, which can cause tire pressure loss. Due to their design, retrofitted tire pressure monitors keep the tire valve open. This can also result in tire pressure loss. There is a risk of an accident.

Only screw the standard valve cap or other valve caps approved by Mercedes-Benz for your vehicle onto the tire valve.

Use a suitable pressure gauge to check the tire pressure. The outer appearance of a tire does not permit any reliable conclusion about the tire pressure. On vehicles equipped with the electronic tire pressure monitoring system, the tire pressure can be checked using the on-board computer.

The tire temperature and pressure increase when the vehicle is in motion. This is dependent on the driving speed and the load. Therefore, you should only correct tire pressures when the tires are cold.

The tires are cold:

- if the vehicle has been parked without direct sunlight on the tires for at least three hours and
- if the vehicle has been driven for less than 1 mile (1.6 km).

The tire temperature changes depending on the outside temperature, the vehicle speed and the tire load. If the tire temperature changes by 18 °F (10 °C), the tire pressure changes by approximately 10 kPa (0.1 bar/ 1.5 psi). Take this into account when checking the pressure of warm tires. Only correct the tire pressure if it is too low for the current operating conditions. If you check the tire pressure when the tires are warm, the resulting value will be higher than if the tires were cold. This is normal. Do not reduce the tire pressure to the value specified for cold

tires. The tire pressure would otherwise be too low.

Observe the recommended tire pressures for cold tires:

- on the Tire and Loading Information placard on the B-pillar on the driver's side
- in the tire pressure table on the inside of the fuel filler flap
- printed in yellow on the rim of the emergency/collapsible spare wheel (depending on vehicle equipment)

Underinflated or overinflated tires

Underinflation

WARNING

Tires with pressure that is too low can overheat and burst as a consequence. In addition, they also suffer from excessive and/or irregular wear, which can severely impair the braking properties and the driving characteristics. There is a risk of an accident. Avoid tire pressures that are too low in all the tires, including the spare wheel.

Underinflated tires may:

- overheat, leading to tire defects
- have an adverse effect on handling characteristics
- wear quickly and unevenly
- have an adverse effect on fuel consumption

Overinflation

WARNING

Tires with excessively high pressure can burst because they are damaged more easily by road debris, potholes etc. In addition, they also suffer from irregular wear, which can severely impair the braking properties and the driving characteristics. There is a risk of an accident.

Avoid tire pressures that are too high in all the tires, including the spare wheel.

Overinflated tires may:

- increase the braking distance
- have an adverse effect on handling characteristics
- wear quickly and unevenly
- have an adverse effect on ride comfort
- be more susceptible to damage

Maximum tire pressures



① Example: maximum permissible tire pressure

Never exceed the maximum permissible tire inflation pressure. Always observe the recommended tire pressure for your vehicle when adjusting the tire pressure

(▷ page 311).

 The actual values for tires are vehicle-specific and may deviate from the values in the illustration.

Checking the tire pressures

Important safety notes

Observe the notes on tire pressure (▷ page 311).

Information on air pressure for the tires on your vehicle can be found:

- on the vehicle's Tire and Loading Information placard on the B-pillar (▷ page 319)
- on the tire pressure label on the fuel filler flap (▷ page 153)
- in the "Tire pressure" section

Checking tire pressures manually

To determine and set the correct tire pressure, proceed as follows:

- ▶ Remove the valve cap of the tire that is to be checked.
- ▶ Press the tire pressure gauge securely onto the valve.
- ▶ Read the tire pressure and compare it with the recommended value on the Tire and Loading Information placard (▷ page 311).
- ▶ If the tire pressure is too low, increase it to the recommended value.
- ▶ If the tire pressure is too high, release air by pressing down the metal pin in the valve. Use the tip of a pen, for example. Then, check the tire pressure again using the tire pressure gauge.
- ▶ Screw the valve cap onto the valve.
- ▶ Repeat these steps for the other tires.

Tire pressure loss warning system (Canada only)

Important safety notes

While the vehicle is in motion, the tire pressure loss warning system monitors the set tire pressure using the rotational speed of the wheels. This enables the system to detect significant pressure loss in a tire. If the speed of rotation of a wheel changes as a result of a loss of pressure, a corresponding warning message will appear in the multifunction display.

The tire pressure warning system does not warn you of an incorrectly set tire pressure. Observe the notes on the recommended tire pressure (▷ page 311).

The tire pressure loss warning system does not replace the need to regularly check your vehicle's tire pressures, since an even loss of pressure on several tires at the same time cannot be detected by the tire pressure loss warning system.

The tire pressure monitor is not able to warn you of a sudden loss of pressure, e.g. if the tire is penetrated by a foreign object. In the event of a sudden loss of pressure, bring the vehicle to a halt by braking carefully. Avoid abrupt steering maneuvers.

The function of the tire pressure loss warning system is limited or delayed if:





- snow chains are mounted to your vehicle's tires.
- road conditions are wintry.
- you are driving on sand or gravel.
- you adopt a very sporty driving style (cornering at high speeds or driving with high rates of acceleration).
- you drive with a heavy load.

Restarting the tire pressure loss warning system





Restart the tire pressure loss warning system if you have:

- changed the tire pressure
- changed the wheels or tires
- mounted new wheels or tires
- ▶ Before restarting, make sure that the tire pressures are set properly on all four tires for the respective operating conditions. The recommended tire pressures can be found on the Tire and Loading Information placard on the B-pillar on the driver's side or the tire pressure table on the fuel filler flap.

The tire pressure loss warning system can only give reliable warnings if you have set the correct tire pressure. If an incorrect tire pressure is set, these incorrect values will be monitored.





- ▶ Observe the notes on tire pressure (▷ page 311).
- ▶ Make sure that the SmartKey is in position **2** (▷ page 135) in the ignition lock.
- ▶ Press  or  on the steering wheel to select the **Serv.** menu.
- ▶ Press the  or  button to select **Tire Pressure**.
- ▶ Press the  button.
The **Run Flat Indicator Active Press 'OK' to Restart** message appears in the multifunction display.

If you wish to confirm the restart:

- ▶ Press the  button.
The **Tire Pressure Now OK?** message appears in the multifunction display.
- ▶ Press the  or  button to select **Yes**.
- ▶ Press the  button.
The **Run Flat Indicator Restarted** message appears in the multifunction display.

After a teach-in period, the tire pressure loss warning system will monitor the set tire pressures of all four tires.

If you wish to cancel the restart:

- ▶ Press the  button.
or
- ▶ If the **Tire Pressure Now OK?** message appears, use  or to select  **Cancel**.
- ▶ Press the  button.
The tire pressure values stored at the last restart will continue to be monitored.

Tire pressure monitor (USA only)

Important safety notes

WARNING

Each tire, including the spare (if provided), should be checked at least once a month when cold and inflated to the pressure recommended by the vehicle manufacturer on the Tire and Loading Information placard on the driver's door B-pillar or the tire pressure label on the inside of the fuel filler flap. If your vehicle has tires of a different size than the size indicated on the Tire and Loading Information placard or the tire pressure label, you should determine the proper tire pressure for those tires.

As an added safety feature, your vehicle has been equipped with a tire pressure monitoring system (TPMS) that illuminates a low tire pressure telltale when one or more of your tires are significantly underinflated.

Accordingly, when the low tire pressure telltale illuminates, you should stop and check your tires as soon as possible, and inflate them to the proper pressure. Driving on a significantly underinflated tire causes the tire to overheat and can lead to tire failure.

Underinflation also reduces fuel efficiency and tire tread life, and may affect the vehicle's handling and stopping ability.

Please note that the TPMS is not a substitute for proper tire maintenance, and it is the driver's responsibility to maintain correct tire pressure, even if underinflation has not reached the level to trigger illumination of the TPMS low tire pressure telltale.

Your vehicle has also been equipped with a TPMS malfunction indicator to indicate if the system is not operating properly. The TPMS malfunction indicator is combined with the low tire pressure telltale. When the system detects a malfunction, the warning lamp will flash for approximately a minute and then remain continuously illuminated. This sequence will be repeated every time the

vehicle is started as long as the malfunction exists.

When the malfunction indicator is illuminated, the system may not be able to detect or signal low tire pressure as intended. TPMS malfunctions may occur for a variety of reasons, including the installation of incompatible replacement or alternate tires or wheels on the vehicle that prevent the TPMS from functioning properly. Always check the TPMS malfunction telltale after replacing one or more tires or wheels on your vehicle to ensure that the replacement or alternate tires and wheels allow the TPMS to continue to function properly.

It is the driver's responsibility to set the tire pressure to that recommended for cold tires which is suitable for the operating situation (▷ page 311). Note that the correct tire pressure for the current operating situation must first be taught-in to the tire pressure monitor. If there is a substantial loss of pressure, the warning threshold for the warning message is aligned to the reference values taught-in. Restart the tire pressure monitor after adjusting the pressure of the cold tires (▷ page 318). The current pressures are saved as new reference values. As a result, a warning message will appear if the tire pressure drops significantly.

The tire pressure monitor does not warn you of an incorrectly set tire pressure. Observe the notes on the recommended tire pressure (▷ page 311).

The tire pressure monitor is not able to warn you of a sudden loss of pressure, e.g. if the tire is penetrated by a foreign object. In the event of a sudden loss of pressure, bring the vehicle to a halt by braking carefully. Avoid abrupt steering maneuvers.

If a tire pressure monitor system is installed, the vehicle's wheels have sensors installed that monitor the tire pressures in all four tires. The tire pressure monitor warns you if the pressure drops in one or more of the tires. The tire pressure monitor only functions if the

correct wheel electronics units are installed on each wheel.

The tire pressure monitor has a yellow warning lamp in the instrument cluster for indicating pressure loss or a malfunction. Whether the warning lamp flashes or lights up indicates whether a tire pressure is too low or the tire pressure monitor is malfunctioning:

- if the warning lamp is lit continuously, the tire pressure on one or more tires is significantly too low. The tire pressure monitor is not malfunctioning.
- if the warning lamp flashes for around a minute and then remains lit constantly, the tire pressure monitor is malfunctioning.

Information on tire pressures is displayed in the multifunction display. After a few minutes of driving, the current tire pressure of each tire is shown in the multifunction display.

If the tire pressure monitor is malfunctioning, it may take more than ten minutes for the tire pressure warning lamp to inform you of the malfunction by flashing for approximately one minute and then remaining lit. When the malfunction has been rectified, the tire pressure warning lamp goes out after a few minutes of driving.

The tire pressure values indicated by the on-board computer may differ from those measured at a gas station with a pressure gauge. The tire pressures shown by the on-board computer refer to those measured at sea level. At high altitudes, the tire pressure values indicated by a pressure gauge are higher than those shown by the on-board computer. In this case, do not reduce the tire pressures.

The operation of the tire pressure monitor can be affected by interference from radio transmitting equipment (e.g. radio headphones, two-way radios) that may be being operated in or near the vehicle.

- ❗ This device complies with part 15 of the FCC Rules. Operation is subject to the following two conditions:

1. This device may not cause interference, and
 2. this device must accept any interference received, including interference that may cause undesired operation of the device.
- Any unauthorized modification to this device could void the user's authority to operate the equipment.

Checking tire pressure electronically

- ▶ Make sure that the SmartKey is in position **2** (▷ page 135) in the ignition lock.
- ▶ Press the ◀ or ▶ button on the steering wheel to select the **Serv.** menu.
- ▶ Press the ▲ or ▼ button to select **Tire Pressure**.
- ▶ Press button **OK**.
The current tire pressure for each wheel will be displayed in the multifunction display.

If the vehicle has been parked for longer than 20 minutes, the **Tire pressures will be displayed after driving a few minutes** message appears.

After a teach-in period, the tire pressure monitor automatically recognizes new wheels or new sensors. As long as a clear allocation of the tire pressure values to the individual wheels is not possible, the **Tire Pressure Monitor Active** message is displayed instead of the tire pressure display. The tire pressures are already being monitored.

Tire pressure monitor warning messages

If the tire pressure monitor detects a significant pressure loss on one or more tires, a warning message is shown in the multifunction display. A warning tone also sounds and the tire pressure warning lamp lights up in the instrument cluster.

Each tire that is affected by a significant loss of pressure is highlighted in the pressure display.

- ▶ If the **Correct Tire Pressure** message appears in the multifunction display, check the tire pressure on all four wheels and correct it as necessary.

i If the wheel positions on the vehicle are interchanged, the tire pressures may be displayed for the wrong positions for a short time. This is rectified after a few minutes of driving, and the tire pressures are displayed for the correct positions.

Restarting the tire pressure monitor

When you restart the tire pressure monitor, all existing warning messages are deleted and the warning lamps go out. The monitor uses the currently set tire pressures as the reference values for monitoring. In most cases, the tire pressure monitor will automatically detect the new reference values after you have changed the tire pressure. However, you can also define reference values manually as described here.

- ▶ Set the tire pressure to the value recommended for the corresponding driving situation on the Tire and Loading Information placard on the driver's side B-pillar (▷ page 311).
Additional tire pressure values for different loads can also be found on the tire pressure table on the inside of the fuel filler flap (▷ page 311).
- ▶ Make sure that the tire pressure is correct on all four wheels.
- ▶ Make sure that the SmartKey is in position **2** in the ignition lock.
- ▶ Press the ◀ or ▶ button on the steering wheel to select the **Serv.** menu.
- ▶ Press the ▲ or ▼ button to select **Tire Pressure**.
- ▶ Press the **OK** button.
The multifunction display shows the current tire pressure for each tire or the **Tire pressures will be displayed**

after driving a few minutes message.

- ▶ Press the  button. The **Use Current Pressures as New Reference Values** message appears in the multifunction display.

If you wish to confirm the restart:

- ▶ Press the  button. The **Tire Press. Monitor Restarted** message appears in the multifunction display.

After driving for a few minutes, the system checks whether the current tire pressures are within the specified range. The new tire pressures are then accepted as reference values and monitored.

If you wish to cancel the restart:

- ▶ Press the  button. The tire pressure values stored at the last restart will continue to be monitored.

corresponding pressures for tires installed at the factory.

- (2) The vehicle identification plate is on the B-pillar on the driver's side. The vehicle identification plate informs you of the gross vehicle weight rating. It is made up of the vehicle weight, all vehicle occupants, the fuel and the cargo. You can also find information about the maximum gross axle weight rating on the front and rear axle.

The maximum gross axle weight rating is the maximum weight that can be carried by one axle (front or rear axle). Never exceed the maximum load or the maximum gross axle weight rating for the front or rear axle.

Loading the vehicle

Instruction labels for tires and loads

 **WARNING**

Overloaded tires can overheat, causing a blowout. Overloaded tires can also impair the steering and driving characteristics and lead to brake failure. There is a risk of accident. Observe the load rating of the tires. The load rating must be at least half of the GAWR of your vehicle. Never overload the tires by exceeding the maximum load.

Two instruction labels on your vehicle show the maximum possible load.

- (1) The Tire and Loading Information placard is on the B-pillar on the driver's side. The Tire and Loading Information placard shows the maximum permissible number of occupants and the maximum permissible vehicle load. It also contains details of the tire sizes and

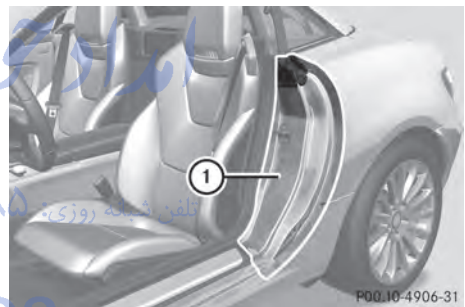

① B-pillar, driver's side

Maximum permissible gross vehicle weight rating

TIRE		LOADING INFORMATION	
REINFORMATION		SUR LES PNEUS ET LE CHARGEMENT	
SEATING CAPACITY	14	FRONT	2000 LBS
NUMBER OF SEATS	14	REAR	2000 LBS
The combined weight of occupants and cargo should never exceed 4000 kg or 8800 lbs.			
TIRE	SIZE	COLD TIRE INFLATION PRESSURE LBS	PSI
FRONT	235/40 XR H 99Y EL	200 KPA, 29 PSI	
REAR	205/55 XR H 01Y XL	200 KPA, 29 PSI	
SPARE (if equipped)	175/65-105P	400 KPA, 60 PSI	

P40.00-2206-31

- Specification for maximum gross vehicle weight $\textcircled{1}$ is listed in the Tire and Loading Information placard: "The combined weight of occupants and cargo should never exceed XXX kilograms or XXX lbs."

The gross weight of all vehicle occupants, load and luggage must not exceed the specified value.

- \textcircled{i} The specifications shown on the Tire and Loading Information placard in the illustration are examples. The maximum permissible gross vehicle weight rating is vehicle-specific and may differ from that in the illustration. You can find the valid maximum permissible gross vehicle weight rating for your vehicle on the Tire and Loading Information placard.

Number of seats

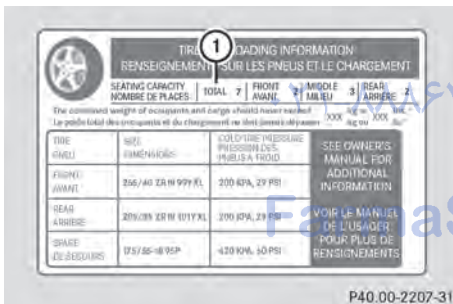

Maximum number of seats $\textcircled{1}$ indicates the maximum number of occupants allowed to travel in the vehicle. This information can be found on the Tire and Loading Information placard.

- \textcircled{i} The specifications shown on the Tire and Loading Information placard in the illustration are examples. The number of seats is vehicle-specific and can differ from the details shown. The number of seats in your vehicle can be found on the Tire and Loading Information placard.

Determining the correct load limit

Step-by-step instructions

The following steps have been developed as required of all manufacturers under Title 49, Code of U.S. Federal Regulations, Part 575 pursuant to the "National Traffic and Motor Vehicle Safety Act of 1966".

- **Step 1:** Locate the statement "The combined weight of occupants and cargo should never exceed XXX kg or XXX lbs." on your vehicle's Tire and Loading Information placard.
- **Step 2:** Determine the combined weight of the driver and passengers that will be riding in your vehicle.
- **Step 3:** Subtract the combined weight of the driver and passengers from XXX kilograms or XXX lbs.
- **Step 4:** The resulting figure equals the available amount of cargo and luggage load capacity. For example, if the "XXX" amount equals 1,400 lbs and there will be five 150 lbs passengers in your vehicle, the amount of available cargo and luggage load capacity is 650 lbs (1,400 – 750 (5 x 150) = 650 lbs).
- **Step 5:** Determine the combined weight of luggage and cargo being loaded on the vehicle. That weight may not safely exceed the available cargo and luggage load capacity calculated in step 4.

Example: steps 1 to 3

The following table shows examples on how to calculate total and cargo load capacities with varying seating configurations and number and size of occupants. The following examples use a maximum load of 1,500 lbs (680 kg). **This is for illustration purposes only.** Make sure you are using the actual load limit for your vehicle stated on your vehicle's Tire and Loading Information placard (▷ page 319).

The higher the weight of all the occupants, the smaller the maximum load for luggage.

Step 1

	Example 1	Example 2
Combined maximum weight of occupants and cargo (data from the Tire and Loading Information placard)	1500 lbs (680 kg)	1500 lbs (680 kg)

Step 3

	Example 1	Example 2
Permissible load (maximum gross vehicle weight rating from the Tire and Loading Information placard minus the gross weight of all occupants)	1500 lbs (680 kg) -175 lbs (80 kg) = 1325 lbs (600 kg)	1500 lbs (680 kg) -370 lbs (168 kg) = 1130 lbs (512 kg)

Step 2

	Example 1	Example 2
Number of people in the vehicle (driver and occupants)	1	2
Weight of the occupants	Occupant 1: 175 lbs (80 kg)	Occupant 1: 175 lbs (80 kg) Occupant 2: 195 lbs (88 kg)
Gross weight of all occupants	175 lbs (80 kg)	370 lbs (168 kg)

Vehicle identification plate

Even if you have calculated the total load carefully, you should still make sure that the gross vehicle weight rating and the gross axle weight rating are not exceeded. Details can be found on the vehicle identification plate on the B-pillar on the driver's side of the vehicle (> page 319).

Permissible gross vehicle weight: the gross weight of the vehicle, all passengers and the load must not exceed the permissible gross vehicle weight.

Gross axle weight rating: the maximum permissible weight that can be carried by one axle (front or rear axle).

To ensure that your vehicle does not exceed the maximum permissible values (gross vehicle weight and maximum gross axle weight rating), have your loaded vehicle (including driver, occupants and the load) weighed on a suitable vehicle weighbridge.

All about wheels and tires

Uniform Tire Quality Grading Standards

Overview of Tire Quality Grading Standards

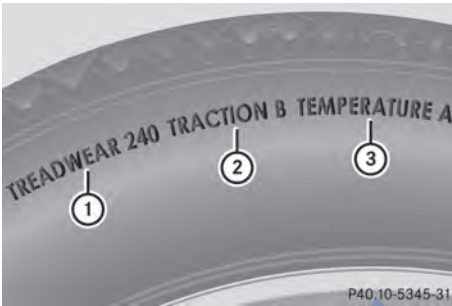

Uniform Tire Quality Grading Standards are U.S. government specifications. Their purpose is to provide drivers with uniform reliable information on tire performance data. Tire manufacturers have to grade tires using three performance factors: treadwear grade ①, traction grade ② and temperature grade ③. These regulations do not apply to Canada. Nevertheless, all tires sold in North America are provided with the corresponding quality grading markings on the sidewall of the tire.

Where applicable, the tire grading information can be found on the tire sidewall between the tread shoulder and maximum tire width.

Example:

- **Treadwear grade:** 200
- **Traction grade:** AA
- **Temperature grade:** A

All passenger car tires must conform to the statutory safety requirements in addition to these grades.

- ❗ The actual values for tires are vehicle-specific and may deviate from the values in the illustration.

Treadwear

The treadwear grade is a comparative rating based on the wear rate of the tire when tested under controlled conditions on a specified U.S. government course. For example, a tire graded 150 would wear one and one-half times as well on the government course as a tire graded 100.

The relative performance of tires depends upon the actual conditions of their use, however, and may depart significantly from the norm, due to variations in driving habits, service practices and differences in road characteristics and climate conditions.

Traction

⚠ WARNING

The traction grade assigned to this tire is based on straight-ahead braking traction tests, and does not include acceleration, cornering, hydroplaning, or peak traction characteristics.

- ❗ **Avoid wheelspin.** This can lead to damage to the drive train.

The traction grades, from highest to lowest, are AA, A, B, and C. Those grades represent the tire's ability to stop on a wet surface as measured under controlled conditions on specified government test surfaces of asphalt and concrete. A tire marked C may have poor traction performance.

The safe speed on a wet, snow covered or icy road is always lower than on dry road surfaces.

You should pay special attention to road conditions when temperatures are around freezing point.

Mercedes-Benz recommends a minimum tread depth of $\frac{1}{8}$ in (4 mm) on all four winter tires. Observe the legally required minimum tire tread depth (> page 309). Winter tires can reduce the braking distance on snow-covered surfaces in comparison with summer tires. The braking distance is still much further than

on surfaces that are not icy or covered with snow. Take appropriate care when driving. Further information on winter tires (M+S tires) (▷ page 310).

Temperature

WARNING

The temperature grade for this tire is established for a tire that is properly inflated and not overloaded. Excessive speed, underinflation, or excessive loading, either separately or in combination, can cause excessive heat build-up and possible tire failure.

The temperature grades are A (the highest), B, and C. These represent the tire's resistance to the generation of heat and its ability to dissipate heat when tested under controlled conditions on a specified indoor laboratory test wheel. Sustained high temperature can cause the material of the tire to degenerate and reduce tire life, and excessive temperature can lead to sudden tire failure. The grade C corresponds to a level of performance which all passenger car tires must meet under the Federal Motor Vehicle Safety Standard No. 109. Grades B and A represent higher levels of performance on the laboratory test wheel than the minimum required by law.

Tire labeling

Overview

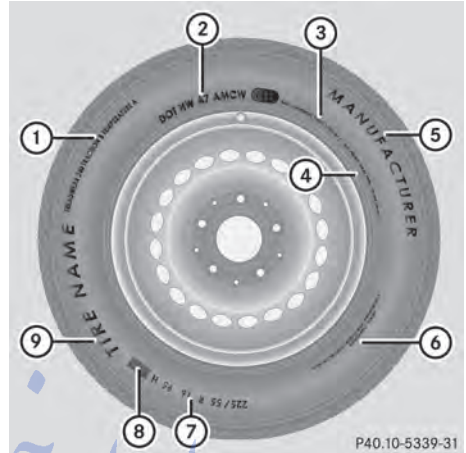

- ① Uniform Tire Quality Grading Standard (▷ page 327)
- ② DOT, Tire Identification Number (▷ page 326)
- ③ Maximum tire load (▷ page 326)
- ④ Maximum tire pressure (▷ page 314)
- ⑤ Manufacturer
- ⑥ Tire material (▷ page 327)
- ⑦ Tire size designation, load-bearing capacity and speed index (▷ page 323)
- ⑧ Load index (▷ page 326)
- ⑨ Tire name

The markings described above are on the tire in addition to the tire name (sales designation) and the manufacturer's name.

-  Tire data is vehicle-specific and may deviate from the data in the example.

Tire size designation, load-bearing capacity and speed rating

WARNING

Exceeding the stated tire load-bearing capacity and the approved maximum speed could lead to tire damage or the tire bursting. There is a risk of accident.

Therefore, only use tire types and sizes approved for your vehicle model. Observe the tire load rating and speed rating required for your vehicle.



- ① Tire width
- ② Nominal aspect ratio in %
- ③ Tire code
- ④ Rim diameter
- ⑤ Load bearing index
- ⑥ Speed rating

General: depending on the manufacturer's standards, the size imprinted in the tire wall may not contain any letters or may contain one letter that precedes the size description.

If there is no letter preceding the size description (as shown above): these are passenger vehicle tires according to European manufacturing standards.

If "P" precedes the size description: these are passenger vehicle tires according to U.S. manufacturing standards.

If "LT" precedes the size description: these are light truck tires according to U.S. manufacturing standards.

If "T" precedes the size description: these are compact emergency spare wheels at high tire pressure, to be used only temporarily in an emergency.

Tire width: tire width ① shows the nominal tire width in millimeters.

Height-width ratio: aspect ratio ② is the size ratio between the tire height and tire width and is shown in percent. The aspect

ratio is calculated by dividing the tire width by the tire height.

Tire code: tire code ③ specifies the tire type. "R" represents radial tires; "D" represents diagonal tires; "B" represents diagonal radial tires.

Optionally, tires with a maximum speed of over 149 mph (240 km/h) may have a "ZR" in the size description, depending on the manufacturer (e.g. 245/40 ZR 18).

Rim diameter: rim diameter ④ is the diameter of the bead seat, not the diameter of the rim flange. The rim diameter is specified in inches (in).

Load-bearing index: load-bearing index ⑤ is a numerical code that specifies the maximum load-bearing capacity of a tire.

Do not overload the tires by exceeding the specified load limit. The maximum permissible load can be found on the vehicle's Tire and Loading Information placard on the B-pillar on the driver's side (▷ page 319).

Example: تلفن شبانه روز

The load bearing index 91 is equivalent to a maximum load of 1356 lb (615 kg) that the tire can carry. For further information on the maximum tire load in kilograms and lbs, see (▷ page 326).

For further information on the load bearing index, see "Load index" (▷ page 326).

Speed rating: speed rating ⑥ specifies the approved maximum speed of the tire.

i Tire data is vehicle-specific and may deviate from the data in the example.

Regardless of the speed rating, always observe the speed limits. Drive carefully and adapt your driving style to the traffic conditions.

Index	Speed rating
Q	up to 100 mph (160 km/h)
R	up to 106 mph (170 km/h)
S	up to 112 mph (180 km/h)
T	up to 118mph (190 km/h)
H	up to 130mph (210 km/h)
V	up to 149 mph (240 km/h)
W	up to 168 mph (270 km/h)
Y	up to 186mph (300 km/h)
ZR...Y	up to 186mph (300 km/h)
ZR...(..Y)	over 186 mph (300 km/h)
ZR	over 149 mph (240 km/h)

- Optionally, tires with a maximum speed of over 149 mph (240 km/h) may have a "ZR" in the size description, depending on the manufacturer (e.g. 245/40 ZR 18). The service specification is made up of load-bearing index ⁵ and speed rating ⁶.
- If the size description of your tire includes "ZR" and there are no service specifications, ask the tire manufacturer in order to find out the maximum speed. If a service specification is available, the maximum speed is limited according to the speed rating in the service specification. Example: 245/40 ZR 18 97 Y. In this example, "97 Y" is the service specification. The letter "Y" represents the speed rating and the maximum speed of the tire is limited to 186 mph (300km/h).
- Every tire that has a maximum speed of more than 186 mph (300 km/h) must have a "ZR" in the size description **and** the service specification must be given in

³ Or M+S  for winter tires.

parentheses. Example: 275/40 ZR 18 (99 Y). The speed rating "(Y)" indicates that the maximum speed of the tire is over 186 mph (300 km/h). Ask the tire manufacturer about the maximum speed.

Index	Speed rating
Q M+S ³	up to 100 mph (160 km/h)
T M+S ³	up to 118mph (190 km/h)
H M+S ³	up to 130mph (210 km/h)
V M+S ³	up to 149 mph (240 km/h)

- i** Not all tires with the M+S marking provide the driving characteristics of winter tires. In addition to the M+S marking, winter tires also have the  snowflake symbol on the tire wall. Tires with this marking fulfill the requirements of the Rubber Manufacturers Association (RMA) and the Rubber Association of Canada (RAC) regarding the tire traction on snow. They have been especially developed for driving on snow.

An electronic speed limiter prevents your vehicle from exceeding the following speeds:

- all vehicles (except AMG vehicles): 130 mph (210 km/h)
- AMG vehicles: 155 mph (250 km/h)
- AMG vehicles with handling package: 174 mph (280 km/h)

The speed rating of tires mounted at the factory may be higher than the maximum speed that the electronic speed limiter permits.

Make sure that your tires have the required speed rating, e.g. when buying new tires. The required speed rating for your vehicle can be found in the "tires" section (▷ page 335).

Further information about reading tire data can be obtained from any qualified specialist workshop.

Load index



In addition to the load bearing index, load rating ① may be imprinted after the letters that identify speed rating on the sidewall of the tire (▷ page 323).

- If no specification is given: no text (as in the example above), represents a standard load (SL) tire
- XL or Extra Load: represents a reinforced tire
- Light Load: represents a light load tire
- C, D, E: represents a load range that depends on the maximum load that the tire can carry at a certain pressure

① Tire data is vehicle-specific and may deviate from the data in the example.

Maximum load rating



Maximum load rating ① is the maximum permissible weight for which the tire is approved.

Do not overload the tires by exceeding the specified load limit. The maximum permissible load can be found on the vehicle's Tire and Loading Information placard on the B-pillar on the driver's side (▷ page 319).

① The actual values for tires are vehicle-specific and may deviate from the values in the illustration. تلفن

DOT, Tire Identification Number (TIN)

U.S. tire regulations prescribe that every tire manufacturer or retreader must imprint a TIN in or on the sidewall of every tire produced.

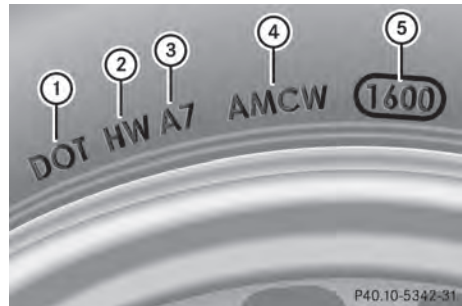

The TIN is a unique identification number. The TIN makes it easier for tire manufacturers or retreaders to notify customers of recalls or other safety-related matters. It makes it

possible for the purchaser to easily identify the affected tires.

The TIN consists of the manufacturer identification code (2), tire size (3), tire type code (4) and manufacturing date (5).

DOT (Department of Transportation): tire symbol (1) indicates that the tire complies with the requirements of the U.S. Department of Transportation.

Manufacturer identification code: manufacturer identification code (2) provides details on the tire manufacturer. New tires have a code with two symbols. Retreaded tires have a code with four symbols.

For further information about retreaded tires, see (▷ page 308).

Tire size: identifier (3) describes the tire size.

Tire type code: tire type code (4) can be used by the manufacturer as a code to describe specific characteristics of the tire.

Date of manufacture: date of manufacture (5) provides information about the age of a tire. The first and second positions represent the week of manufacture, starting with "01" for the first calendar week. Positions three and four represent the year of manufacture. For example, a tire that is marked with "3208", was manufactured in week 32 in 2008.

i Tire data is vehicle-specific and may deviate from the data in the example.

Tire characteristics



This information describes the type of tire cord and the number of layers in sidewall (1) and under tire tread (2).

i Tire data is vehicle-specific and may deviate from the data in the example.

Definition of terms for tires and loading

Tire ply composition and material used

Describes the number of plies or the number of layers of rubber-coated fabric in the tire tread and sidewall. These are made of steel, nylon, polyester and other materials.

Bar

Metric unit for tire pressure.

14.5038 pounds per square inch (psi) and 100 kilopascals (kPa) are the equivalent of 1 bar.

DOT (Department of Transportation)

DOT marked tires fulfill the requirements of the United States Department of Transportation.

Normal occupant weight

The number of occupants which the vehicle is designed for, multiplied by 68 kilograms (150 lb).

Uniform Tire Quality Grading Standards

A uniform standard to grade the quality of tires with regards to tread quality, tire traction and temperature characteristics. Ratings are determined by tire manufacturers using U.S. government testing procedures. The ratings are molded into the sidewall of the tire.

Recommended tire pressure

The recommended tire pressure applies to the tires mounted at the factory.

The Tire and Loading Information placard contains the recommended tire pressures for cold tires on a fully loaded vehicle and for the maximum permissible vehicle speed.

The tire pressure table contains the recommended pressures for cold tires for

various operating conditions, i.e. differing load and speed conditions.

Increased vehicle weight due to optional equipment

This is the combined weight of all standard and optional equipment available for the vehicle, regardless of whether it is actually installed on the vehicle or not.

Rim

This is the part of the wheel on which the tire is mounted.

GAWR (Gross Axle Weight Rating)

The GAWR is the maximum permissible axle weight. The actual load on an axle must never exceed the gross axle weight rating. The gross axle weight rating can be found on the vehicle identification plate on the B-pillar on the driver's side.

Speed rating

The speed rating is part of the tire identification. It specifies the speed range for which the tire is approved.

GVW (Gross Vehicle Weight)

The gross vehicle weight includes the weight of the vehicle including fuel, tools, the spare wheel, accessories installed, occupants, luggage and the drawbar noseweight, if applicable. The gross vehicle weight must not exceed the gross vehicle weight rating GVWR as specified on the vehicle identification plate on the B pillar on the driver's side.

GVWR (Gross Vehicle Weight Rating)

The GVWR is the maximum permissible gross weight of a fully loaded vehicle (the weight of the vehicle including all accessories, occupants, fuel, luggage and the drawbar noseweight, if applicable). The gross vehicle weight rating is specified on the vehicle identification plate on the B-pillar on the driver's side.

Maximum loaded vehicle weight

The maximum weight is the sum of:

- the curb weight of the vehicle
- the weight of the accessories
- the load limit
- the weight of the factory installed optional equipment

Kilopascal (kPa)

Metric unit for tire pressure. 6.9 kPa corresponds to 1 psi. Another unit for tire pressure is bar. There are 100 kilopascals (kPa) to 1 bar.

Load index

In addition to the load-bearing index, the load index may also be imprinted on the sidewall of the tire. This specifies the load-bearing capacity more precisely.

Curb weight

The weight of a vehicle with standard equipment including the maximum capacity of fuel, oil and coolant. It also includes the air-conditioning system and optional equipment if these are installed in the vehicle, but does not include passengers or luggage.

Maximum load rating

The maximum tire load is the maximum permissible weight in kilograms or lbs for which a tire is approved.

Maximum permissible tire pressure

Maximum permissible tire pressure for one tire.

Maximum load on one tire

Maximum load on one tire. This is calculated by dividing the maximum axle load of one axle by two.

PSI (pounds per square inch)

A standard unit of measure for tire pressure.

Aspect ratio

Relationship between tire height and tire width in percent.

Tire pressure

This is pressure inside the tire applying an outward force to each square inch of the tire's surface. The tire pressure is specified in pounds per square inch (psi), in kilopascal (kPa) or in bar. The tire pressure should only be corrected when the tires are cold.

Cold tire pressure

The tires are cold:

- if the vehicle has been parked without direct sunlight on the tires for at least three hours and
- if the vehicle has been driven for less than 1 mile (1.6 km).

Tread

The part of the tire that comes into contact with the road.

Bead

The tire bead ensures that the tire sits securely on the wheel. There are several steel wires in the bead to prevent the tire from coming loose from the wheel rim.

Sidewall

The part of the tire between the tread and the bead.

Weight of optional extras

The combined weight of those optional extras that weigh more than the replaced standard parts and more than 2.3 kilograms (5 lbs). These optional extras, such as high-performance brakes, level control, a roof rack or a high-performance battery, are not included in the curb weight and the weight of the accessories.

TIN (Tire Identification Number)

This is a unique identifier which can be used by a tire manufacturer to identify tires, for example for a product recall, and thus identify

the purchasers. The TIN is made up of the manufacturer's identity code, tire size, tire type code and the manufacturing date.

Load bearing index

The load bearing index (also load index) is a code that contains the maximum load bearing capacity of a tire.

Traction

Traction is the result of friction between the tires and the road surface.

Treadwear indicators

Narrow bars (tread wear bars) that are distributed over the tire tread. If the tire tread is level with the bars, the wear limit of $\frac{1}{16}$ in (1.6 mm) has been reached.

Occupant distribution

The distribution of occupants in a vehicle at their designated seating positions.

Total load limit

Rated cargo and luggage load plus 68 kilograms (150 lb) multiplied by the number of seats in the vehicle.

Changing a wheel**Flat tire**

Information on the procedure in the event of a flat tire (> page 291). Instructions for driving with MOExtended tires in the event of a flat tire are also provided there.

Interchanging the wheels**⚠ WARNING**

Interchanging the front and rear wheels may severely impair the driving characteristics if the wheels or tires have different dimensions. The wheel brakes or suspension components may also be damaged. There is a risk of accident.

Rotate front and rear wheels only if the wheels and tires are of the same dimensions.

! On vehicles equipped with a tire pressure monitor, electronic components are located in the wheel.

Tire-mounting tools should not be used near the valve. This could damage the electronic components.

Only have tires changed at a qualified specialist workshop.

! On vehicles equipped with a tire pressure monitor, electronic components are located in the wheel.

Tire-mounting tools should not be used near the valve. This could damage the electronic components.

Only have tires changed at a qualified specialist workshop.

Always pay attention to the instructions and safety notes when changing a wheel (> page 330).

The wear patterns on the front and rear tires differ, depending on the operating conditions. Rotate the wheels before a clear wear pattern has formed on the tires. Front tires typically wear more on the shoulders and the rear tires in the center.

If your vehicle's tire configuration allows, you can rotate the wheels according to the intervals in the tire manufacturer's warranty book in your vehicle documents. If this is not available, the tires should then be replaced every 3,000 to 6,000 miles (5,000 to 10,000 km), or earlier if the tire wear requires this. Do not change the direction of wheel rotation.

Clean the contact surfaces of the wheel and the brake disc thoroughly every time a wheel is interchanged. Check the tire pressure and, if necessary, restart the tire pressure loss warning system or the tire pressure monitor.

Direction of rotation

Tires with a specified direction of rotation have additional benefits, e.g. if there is a risk of hydroplaning. You will only gain these benefits if the correct direction of rotation is maintained.

An arrow on the sidewall of the tire indicates its correct direction of rotation.

Storing wheels

Store wheels that are not being used in a cool, dry and preferably dark place. Protect the tires from oil, grease, gasoline and diesel.

Cleaning the wheels

WARNING

The water jet from a circular jet nozzle (dirt blasters) can cause invisible exterior damage to the tires or chassis components. Components damaged in this way may fail unexpectedly. There is a risk of an accident. Do not use power washers with circular jet nozzles to clean the vehicle. Have damaged tires or chassis components replaced immediately.

Mounting a wheel

Preparing the vehicle

- ▶ Park the vehicle on firm, non-slippery and level ground.
- ▶ Apply the electric parking brake manually.
- ▶ Bring the front wheels into the straight-ahead position.
- ▶ **Vehicles with manual transmission:** shift to first gear or reverse gear.
- ▶ **Vehicles with automatic transmission:** move the selector lever to **P**.
- ▶ Switch off the engine.
- ▶ **Vehicles without KEYLESS-GO:** remove the SmartKey from the ignition lock.

- ▶ **Vehicles with KEYLESS-GO:** open the driver's door. The on-board electronics have status **0**, which is the same as the SmartKey having been removed.
- ▶ **Vehicles with KEYLESS-GO:** remove the Start/Stop button from the ignition lock (▷ page 136).
- ▶ If included in the vehicle equipment, take the tire-change tool kit out of the vehicle.
- ▶ Secure the vehicle to prevent it from rolling away.

i Due to differences in vehicle equipment, not all vehicles are equipped with a tire-change tool kit. For information on which tools are required to perform a wheel change on your vehicle, consult an authorized Mercedes-Benz Center. Necessary wheel-changing tools can include, for example:

- Jack
- Wheel chock
- Lug wrench

Securing the vehicle to prevent it from rolling away

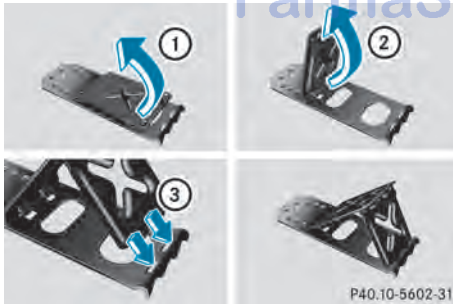

If your vehicle is equipped with a wheel chock, it can be found in the tire-change tool kit (▷ page 291).

The folding wheel chock is an additional securing measure to prevent the vehicle from rolling away, for example when changing a wheel.

- ▶ Fold both plates upwards ①.
- ▶ Fold out lower plate ②.
- ▶ Guide the lugs on the lower plate fully into the openings in base plate ③.



Securing the vehicle on level ground

- ▶ **On level ground:** place chocks or other suitable items under the front and rear of the wheel that is diagonally opposite the wheel you wish to change.



Securing the vehicle on slight downhill gradients

- ▶ **On light downhill gradients:** place chocks or other suitable items in front of the wheels of the front and rear axle.

Raising the vehicle

WARNING

If you do not position the jack correctly at the appropriate jacking point of the vehicle, the jack could tip over with the vehicle raised. There is a risk of injury.

Only position the jack at the appropriate jacking point of the vehicle. The base of the

jack must be positioned vertically, directly under the jacking point of the vehicle.

! The jack is designed exclusively for jacking up the vehicle at the jacking points. Otherwise, your vehicle could be damaged.

The following must be observed when raising the vehicle:

- to raise the vehicle, only use the vehicle-specific jack that has been tested and approved by Mercedes-Benz. If used incorrectly, the jack could tip over with the vehicle raised.
- the jack is designed only to raise and hold the vehicle for a short time while a wheel is being changed. It is not suited for performing maintenance work under the vehicle.
- avoid changing the wheel on uphill and downhill slopes.
- before raising the vehicle, secure it from rolling away by applying the parking brake and inserting wheel chocks. Never disengage the parking brake while the vehicle is raised.
- the jack must be placed on a firm, flat and non-slip surface. On a loose surface, a large, load-bearing underlay must be used. On a slippery surface, a non-slip underlay must be used, e.g. rubber mats.
- do not use wooden blocks or similar objects as a jack underlay. Otherwise, the jack will not be able to achieve its load-bearing capacity due to the restricted height.
- make sure that the distance between the underside of the tires and the ground does not exceed 1.2 in (3 cm).
- never place your hands and feet under the raised vehicle.
- never lie under the raised vehicle.
- never start the engine when the vehicle is raised.

- never open or close a door or the trunk lid when the vehicle is raised.
- make sure that no persons are present in the vehicle when the vehicle is raised.

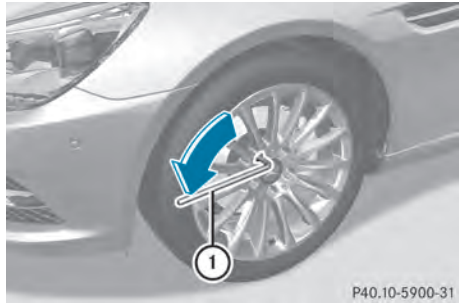

- Using lug wrench ①, loosen the bolts on the wheel you wish to change by about one full turn. Do not unscrew the bolts completely.

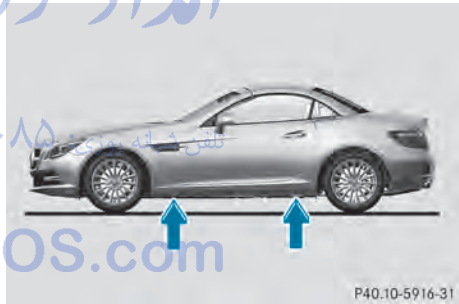

The jacking points are located just behind the front wheel housings and just in front of the rear wheel housings (arrows).

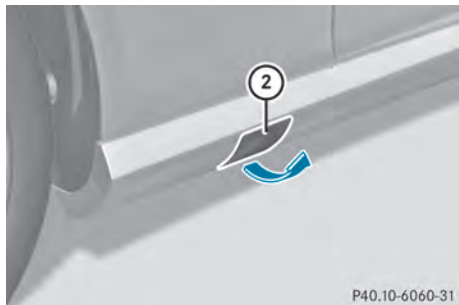

Covers, front (example: vehicles with AMG equipment)

AMG vehicles and vehicles with AMG equipment: to protect the vehicle body, the vehicle has covers next to the jacking points on the outer sills.

- ▶ **AMG vehicles and vehicles with AMG equipment:** fold cover ② upwards.

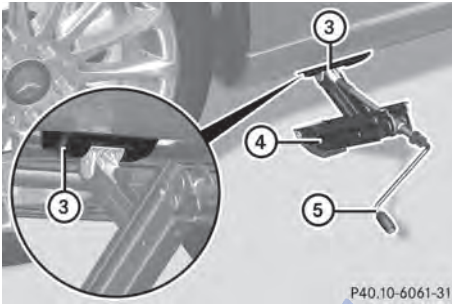

- ▶ Position jack ④ at jacking point ③.

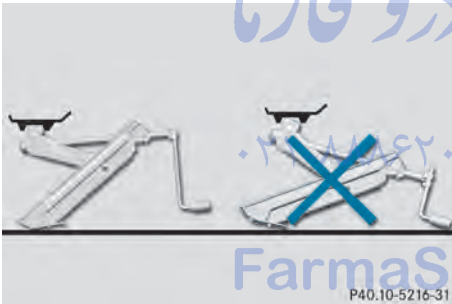

Example

- ▶ Make sure the foot of the jack is directly beneath the jacking point.
- ▶ Turn crank ⑤ clockwise until jack ④ sits completely on jacking point ③ and the base of the jack lies evenly on the ground.
- ▶ Turn crank ⑤ until the tire is raised a maximum of 1.2 in (3 cm) off the ground.

Removing a wheel

- ❗ Do not place wheel bolts in sand or on a dirty surface. The bolt and wheel hub threads could otherwise be damaged when you screw them in.



- ▶ Unscrew the uppermost wheel bolt completely.
- ▶ Screw alignment bolt ① into the thread instead of the wheel bolt.
- ▶ Unscrew the remaining wheel bolts fully.
- ▶ Remove the wheel.

Mounting a new wheel

⚠ WARNING

Oiled or greased wheel bolts or damaged wheel bolts/hub threads can cause the wheel bolts to come loose. As a result, you could lose a wheel while driving. There is a risk of accident.

Never oil or grease wheel bolts. In the event of damage to the threads, contact a qualified specialist workshop immediately. Have the damaged wheel bolts or hub threads replaced/renewed. Do not continue driving.

⚠ WARNING

If you tighten the wheel bolts or wheel nuts when the vehicle is raised, the jack could tip over. There is a risk of injury.

Only tighten the wheel bolts or wheel nuts when the vehicle is on the ground.

Always pay attention to the instructions and safety notes in the "Changing a wheel" section (> page 329).

Only use wheel bolts that have been designed for the wheel and the vehicle. For safety reasons, Mercedes-Benz recommends that you only use wheel bolts which have been

approved for Mercedes-Benz vehicles and the respective wheel.

! To prevent damage to the paintwork, hold the wheel securely against the wheel hub while screwing in the first wheel bolt.



- ▶ Clean the wheel and wheel hub contact surfaces.
- ▶ Slide the wheel to be mounted onto the alignment bolt and push it on.
- ▶ Tighten the wheel bolts until they are finger-tight.
- ▶ Unscrew the alignment bolt.
- ▶ Tighten the last wheel bolt until it is finger-tight.
- ▶ **Vehicles with a collapsible spare wheel:** inflate the collapsible spare wheel (▷ page 341). Only then lower the vehicle.

Lowering the vehicle

WARNING

The wheels could work loose if the wheel nuts and bolts are not tightened to the specified tightening torque. There is a risk of accident. Have the tightening torque immediately checked at a qualified specialist workshop after a wheel is changed.

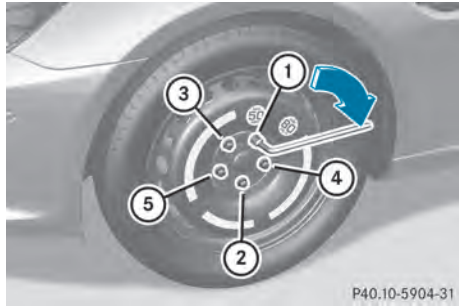

- ▶ Turn the crank of the jack counter-clockwise until the vehicle is once again standing firmly on the ground.
- ▶ Place the jack to one side.
- ▶ Tighten the wheel bolts evenly in a crosswise pattern in the sequence indicated (① to ⑤). The specified tightening torque is **96 lb-ft (130 Nm)**.
- ▶ Turn the jack back to its initial position.
- ▶ Stow the jack and the rest of the vehicle tools in the trunk again.
- ▶ **AMG vehicles and vehicles with AMG equipment:** insert the cover into the outer sill.
- ▶ Check the tire pressure of the newly installed wheel and adjust it if necessary. Observe the recommended tire pressure (▷ page 311).

i Vehicles with tire pressure loss warning system: as long as you are driving with an emergency spare wheel, the tire pressure loss warning system cannot function reliably. Only restart the tire pressure loss warning system when the defective wheel has been replaced with a new wheel.

i Vehicles with tire pressure monitor: all wheels mounted must be equipped with functioning sensors.

Wheel and tire combinations

General notes

! For safety reasons, Mercedes-Benz recommends that you only use tires and wheels which have been approved by Mercedes-Benz specifically for your vehicle.

These tires have been specially adapted for use with the control systems, such as ABS or ESP®, and are marked as follows:

- MO = Mercedes-Benz Original
- MOE = Mercedes-Benz Original Extended (tires featuring run-flat characteristics)
- MO1 = Mercedes-Benz Original (only certain AMG tires)

Mercedes-Benz Original Extended tires may only be used on wheels that have been specifically approved by Mercedes-Benz.

Only use tires, wheels or accessories tested and approved by Mercedes-Benz. Certain characteristics, e.g. handling, vehicle noise emissions or fuel consumption, may otherwise be adversely affected. In addition, when driving with a load, tire dimension variations could cause the tires to come into contact with the bodywork and axle components. This could result in damage to the tires or the vehicle.

Mercedes-Benz accepts no liability for damage resulting from the use of tires, wheels or accessories other than those tested and approved.

Information on tires, wheels and approved combinations can be obtained from any qualified specialist workshop.

! Retreaded tires are neither tested nor recommended by Mercedes-Benz, since previous damage cannot always be detected on retreaded tires. As a result, Mercedes-Benz cannot guarantee vehicle safety if retreaded tires are mounted. Do not mount used tires if you have no information about their previous usage.

Overview of abbreviations used in the following tire tables:

- BA: both axles
- FA: front axle
- RA: rear axle

The recommended pressures for various operating conditions can be found:

- on the Tire and Loading Information placard with the recommended tire pressures on the B-pillar on the driver's side
- in the tire pressure table on the inside of the fuel filler flap

Observe the notes on recommended tire pressures under various operating conditions (> page 311).

Check tire pressures regularly, and only when the tires are cold. Comply with the maintenance recommendations of the tire manufacturer in the vehicle document wallet.

Notes on the vehicle equipment – always equip the vehicle with:

- tires of the same size on a given axle (left/right) تلفن شبانه ۰۸۵۰۰۰۰۰۰۰
- the same type of tires at a given time (summer tires, winter tires, MOExtended tires)

Vehicles equipped with MOExtended tires are not equipped with a TIREFIT kit at the factory. It is therefore recommended that you additionally equip your vehicle with a TIREFIT kit if you mount tires that do not feature run-flat properties, e.g. winter tires. A TIREFIT kit may be obtained from a qualified specialist workshop.

i Not all wheel and tire combinations are available at the factory for all countries.

i On the following pages, you can find information on approved wheel rims and tire sizes for equipping your vehicle with winter tires. Winter tires are not available at the factory as standard equipment or optional extras.

If you would like to equip your vehicle with approved winter tires, you may also, in

certain circumstances, require rims of the appropriate size. The sizes of the approved winter tires may deviate from that of the standard tires. This is dependent on the model and the equipment installed at the factory.

The tires and wheel rims, as well as further information, can be obtained at a qualified specialist workshop.

امداد خودرو فارما

تلفن شبانه روزی: ۰۲۱-۸۸۸۶۲۰۸۵

FarmaSOS.com

Tires

SLK 250

Summer tires

R17



Tires	Alloy wheels
FA: 225/45 R17 91 W	FA: 7.5 J x 17 H2 Wheel offset: 1.65 in (42 mm)
FA: 245/40 R17 91 W ⁴	RA: 8.5 J x 17 H2 Wheel offset: 1.42 in (36 mm)
FA: 225/45 R17 91 W MOExtended ⁵	FA: 7.5 J x 17 H2 Wheel offset: 1.65 in (42 mm)
RA: 245/40 R17 91 W MOExtended ^{4, 5}	RA: 8.5 J x 17 H2 Wheel offset: 1.42 in (36 mm)

R18

Tires	Alloy wheels
FA: 225/40 R18 92 Y XL	FA: 7.5 J x 18 H2 Wheel offset: 1.65 in (42 mm)
RA: 245/35 R18 92 Y XL ⁴	RA: 8.5 J x 18 H2 Wheel offset: 1.42 in (36 mm)

Winter tires

R17

Tires	Alloy wheels
BA: 225/45 R17 91 H M+S 	BA: 7.5 J x 17 H2 Wheel offset: 1.65 in (42 mm)
BA: 225/45 R17 91 H M+S  MOExtended ⁵	BA: 7.5 J x 17 H2 Wheel offset: 1.65 in (42 mm)

⁴ Use of snow chains is not permitted. Observe the notes in the "Snow chains" section.

⁵ MOExtended tires (tires with run-flat characteristics) only in conjunction with an activated tire pressure loss warning system.

SLK 350

Summer tires

R17



Tires	Alloy wheels
FA: 225/45 R17 91 W	FA: 7.5 J x 17 H2 Wheel offset: 1.65 in (42 mm)
RA: 245/40 R17 91 W ⁴	RA: 8.5 J x 17 H2 Wheel offset: 1.42in (36 mm)
FA: 225/45 R17 91 W MOExtended ⁵	FA: 7.5 J x 17 H2 Wheel offset: 1.65 in (42 mm)
RA: 245/40 R17 91 W MOExtended ^{4, 5}	RA: 8.5 J x 17 H2 Wheel offset: 1.42 in (36 mm)

R18

Tires	Alloy wheels
FA: 225/40 R18 92 Y XL	FA: 7.5 J x 18 H2 Wheel offset: 1.65 in (42 mm)
RA: 245/35 R18 92 Y XL ⁴	RA: 8.5 J x 18 H2 Wheel offset: 1.42 in (36 mm)

Winter tires

R17

Tires	Alloy wheels
BA: 225/45 R17 91 H M+S 	BA: 7.5 J x 17 H2 Wheel offset: 1.65 in (42 mm)
BA: 225/45 R17 91 H M+S  MOExtended ⁵	BA: 7.5 J x 17 H2 Wheel offset: 1.65 in (42 mm)

⁴ Use of snow chains is not permitted. Observe the notes in the "Snow chains" section.

⁵ MOExtended tires (tires with run-flat characteristics) only in conjunction with an activated tire pressure loss warning system.

SLK 55 AMG



Summer tires

R18

Tires	Alloy wheels
FA: 235/40 ZR18 95 Y XL	FA: 8.0 J x 18 H2 Wheel offset: 1.69 in (43 mm)
RA: 255/35 ZR18 94 Y XL ⁴	RA: 9.0 J x 18 H2 Wheel offset: 1.65 in (42 mm)

Winter tires

R18

Tires	Alloy wheels
BA: 235/40 R18 95 V XL M+S 	BA: 8.0 J x 18 H2 Wheel offset: 1.69 in (43 mm)
FA: 235/40 R18 95 V XL M+S 	FA: 8.0 J x 18 H2 Wheel offset: 1.69 in (43 mm)
RA: 255/35 R18 94 V XL M+S  ⁴	RA: 9.0 J x 18 H2 Wheel offset: 1.65 in (42 mm)

تلفن شبانه روزی: ۰۲۱-۸۸۸۶۲۰۸۵

Emergency spare wheel

Important safety notes

 WARNING

The wheel or tire size as well as the tire type of the spare wheel or emergency spare wheel and the wheel to be replaced may differ. Mounting an emergency spare wheel may severely impair the driving characteristics. There is a risk of an accident.

To avoid hazardous situations:

- adapt your driving style accordingly and drive carefully.
- never mount more than one spare wheel or emergency spare wheel that differs in size.
- only use a spare wheel or emergency spare wheel of a different size briefly.

- do not switch ESP[®] off.
- have a spare wheel or emergency spare wheel of a different size replaced at the nearest qualified specialist workshop. Observe that the wheel and tire dimensions as well as the tire type must be correct.

When using an emergency spare wheel or spare wheel of a different size, you must not exceed the maximum speed of 50 mph (80 km/h).

Snow chains must not be mounted on emergency spare wheels.

General notes

You should regularly check the pressure of the emergency spare wheel, particularly prior to long trips, and correct the pressure as necessary (▷ page 311). The applicable value

⁴ Use of snow chains is not permitted. Observe the notes in the "Snow chains" section.

is found on the wheel or under "Technical data" (▷ page 343).

An emergency spare wheel may also be mounted against the direction of rotation. Observe the time restriction on use as well as the speed limitation specified on the emergency spare wheel.

Replace the tires after six years at the latest, regardless of wear. This also applies to the emergency spare wheel.

- ❶ When you are driving with the collapsible spare wheel mounted, the tire pressure loss warning system or the tire pressure monitor cannot function reliably. Only restart the tire pressure loss warning system/the tire pressure monitor when the damaged wheel has been replaced with a new wheel.

Vehicles with tire pressure monitor: after mounting an emergency spare wheel, the system may still display the tire pressure of the removed wheel for a few minutes. The value displayed for the mounted emergency spare wheel is not the same as the current tire pressure of the emergency spare wheel.

Removing the emergency spare wheel

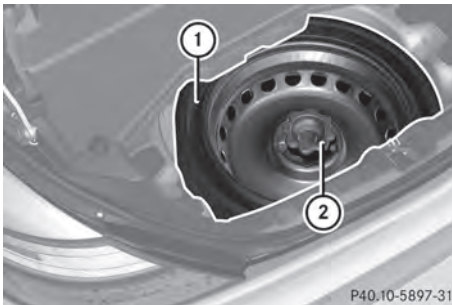

Example

The collapsible spare wheel can be found in the storage well under the trunk floor.

- ▶ Turn retaining screw ❷ counter-clockwise and remove it.
- ▶ Remove collapsible spare wheel ❶.

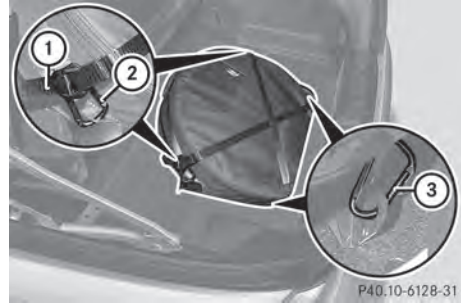

AMG vehicles

AMG vehicles: the collapsible spare wheel is packed in a bag and secured to a bracket in the trunk.

- ▶ Loosen tensioning straps ❶ on both sides.
- ▶ Unhook retaining spring hooks ❷ and ❸ tensioning strap ❶ from the bracket.
- ▶ Remove the bag with the collapsible spare wheel.
- ▶ Open the bag and remove the collapsible spare wheel.

Information on the tire-change tool kit can be found in the "Where will I find...?" section (▷ page 291).

Stowing the emergency spare wheel

- ❗ Only place the collapsible spare wheel in the vehicle when it is dry. Otherwise, moisture may get into the vehicle.

Take the following steps to stow a used collapsible spare wheel. Otherwise, the collapsible spare wheel will not install in the trunk in the intended manner. Mercedes-Benz recommends that you have this work carried out at a qualified specialist workshop.

- ▶ Unscrew the valve cap from the valve.
- ▶ If possible, unscrew the valve insert from the valve and release the air.

- ❶ Fully deflating the tires can take a few minutes.
- ▶ Screw the valve insert back into the valve.
- ▶ Screw the valve cap back on.
- ▶ Pull the protective sheet provided with the spare wheel over the collapsible spare wheel.
- ▶ Stow the collapsible spare wheel in the emergency spare wheel well under the trunk.
- ▶ Use the retaining screw to pierce the protective sheet and fasten the collapsible spare wheel in place.
- ▶ **AMG vehicles:** pull the bag over the collapsible spare wheel and close it.
- ▶ Place the bag with the collapsible spare wheel in the trunk.
- ▶ Hook in the retaining strap carabiners and lash the collapsible spare wheel to the bracket.

Inflating the collapsible spare wheel

- ❶ Inflate the collapsible spare wheel using the tire inflation compressor before lowering the vehicle. The wheel rim could otherwise be damaged.
- ❶ Do not operate the tire inflation compressor for longer than ten minutes at a time without a break. It may otherwise overheat.
The tire inflation compressor can be operated again once it has cooled down.

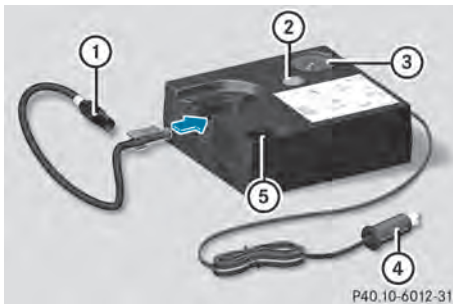

- ▶ Mount the collapsible spare wheel as described (▷ page 330).
The collapsible spare wheel must be mounted before it is inflated.
- ▶ Pull plug ❹ out of the housing.
- ▶ Take the air hose out of the housing.
- ▶ Insert the yellow hose connector of the air hose into the guide in the housing and push it into the fixture until the hose connector engages.
- ▶ Remove the cap from the valve on the collapsible spare wheel.
- ▶ Screw union nut ❶ on the air hose onto the valve.
- ▶ Make sure the tire inflation compressor's on/off switch ❸ is set to **OFF**.
- ▶ Insert plug ❹ into the socket of the cigarette lighter or into a 12 V power socket in your vehicle.
Observe the notes on the cigarette lighter (▷ page 261). Observe the notes on sockets (▷ page 261).
- ▶ Turn the SmartKey to position **1** in the ignition lock (▷ page 135).
- ▶ Press on/off switch ❸ on the tire inflation compressor to **ON**.
The tire inflation compressor is switched on. The tire is inflated. The tire pressure is shown on pressure gauge ❸.
- ▶ Inflate the tire to the specified tire pressure.
The specified tire pressure is printed on the yellow label of the emergency spare wheel.
- ▶ When the specified tire pressure has been reached, press on/off switch ❸ to **OFF**, on the tire inflation compressor.
The tire inflation compressor is switched off.
- ▶ Turn the SmartKey to position **0** in the ignition lock.
- ▶ If the tire pressure is higher than the specified pressure, press pressure release button ❷ until the correct tire pressure has been reached.

- ▶ Unscrew union nut ① on the air hose from the valve.
- ▶ Screw the valve cap onto the collapsible spare wheel valve again.

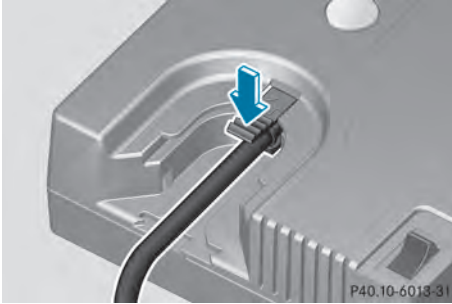

Removing an air hose

- ▶ To remove the hose from the tire inflation compressor, push down the rocker switch on the hose connector and pull out the hose.
- ▶ Stow plug ④ and the air hose in the lower section of the blower housing.
- ▶ Stow the tire inflation compressor in the vehicle.

امداد خودرو فارما

تلفن شبانه روزی: ۰۲۱-۸۸۸۶۲۰۸۵

FarmaSOS.com

Technical data**All models (except AMG vehicles)****Collapsible spare wheel⁶**

Tires	Alloy wheels
145/70 - 17 92P Tire pressure: 350 kPa (3.5 bar/51 psi)	4.5 B x 17 H2 ET 12

AMG vehicles**Collapsible spare wheel⁶**

Tires	Alloy wheels
175/55 - 18 95P Tire pressure: 350 kPa (3.5 bar/51 psi)	6.0 B x 18 H2 ET 25

Depending on the country, the engine and the wheels mounted, your vehicle may be equipped with TIREFIT or a collapsible spare wheel.

- i** The specified tire pressure is printed in yellow on the emergency spare wheel.

تلفن شبانه روزی: ۰۲۱-۸۸۸۶۲۰۸۵

FarmaSOS.com

⁶ Use of snow chains not permitted. Observe the notes in the "Snow chains" section.

امداد خودرو فارما

تلفن شبانه روزی: ۰۲۱-۸۸۸۶۲۰۸۵

FarmaSOS.com

Useful information	346
Information regarding technical data	346
Genuine Mercedes-Benz parts	346
Warranty	346
Identification plates	347
Service products and filling capacities	348
Vehicle data	353

امداد خودرو فارما

تلفن شبانه روزی: ۰۲۱-۸۸۸۶۲۰۸۵

FarmaSOS.com

Useful information

- 1 This Operator's Manual describes all models and all standard and optional equipment of your vehicle available at the time of publication of the Operator's Manual. Country-specific differences are possible. Please note that your vehicle may not be equipped with all features described. This also applies to safety-related systems and functions.
- i Read the information on qualified specialist workshops: (▷ page 23).

Information regarding technical data

- i The data stated here specifically refers to a vehicle with standard equipment. Consult a Mercedes-Benz Center for the data for all vehicle variants and trim levels.

Genuine Mercedes-Benz parts

WARNING

Driving safety may be impaired if non-approved parts, tires and wheels or safety-relevant accessories are used.

This could lead to malfunctions in safety-relevant systems, e.g. the brake system. This could cause you to lose control of your vehicle and cause an accident.

For this reason, Mercedes-Benz recommends that you use genuine Mercedes-Benz parts or parts of equal quality. Only use tires, wheels and accessories that have been specifically approved for your vehicle.

Environmental note

Daimler AG also supplies reconditioned major assemblies and parts which are of the same quality as new parts. They are covered by the same Limited Warranty entitlements as new parts.

 Air bags and Emergency Tensioning Devices, as well as control units and sensors for these restraint systems, may be installed in the following areas of your vehicle:

- doors
- door pillars
- door sills
- seats
- cockpit
- instrument cluster
- center console

Do not install accessories such as audio systems in these areas. Do not carry out repairs or welding. You could impair the operating efficiency of the restraint systems.

Have aftermarket accessories installed at a qualified specialist workshop.

Genuine Mercedes-Benz parts are subject to strict quality control. Each part has been specially developed, manufactured or selected for Mercedes-Benz vehicles and fine-tuned for them. Only genuine Mercedes-Benz parts should therefore be used.

More than 300,000 different genuine Mercedes-Benz parts are available for Mercedes-Benz models.

All Mercedes-Benz Centers maintain a supply of genuine Mercedes-Benz parts for necessary service and repair work. In addition, strategically located parts delivery centers provide quick and reliable parts service.

Always specify the vehicle identification number (VIN) (▷ page 347) and the engine number (▷ page 348) when ordering genuine Mercedes-Benz parts.

Warranty

Your vehicle is covered under the terms of the warranties printed in the Service and Warranty Information booklet.

Your authorized Mercedes-Benz Center replaces and repairs all factory-fitted parts in accordance with the following warranty terms and conditions:

- New Vehicle Limited Warranty
- Emission Systems Warranty
- Emission Performance Warranty
- California, Connecticut, Maine, Massachusetts, New York, Pennsylvania, Rhode Island and Vermont Emission Control System Warranty
- State warranty enforcement laws (Lemon Laws)

Replacement parts and accessories are covered by the Mercedes-Benz Parts and Accessories warranties. These are available at any authorized Mercedes-Benz Center.

- ① If you lose the Service and Warranty Information booklet, contact an authorized Mercedes-Benz Center to arrange a replacement. The new Service and Warranty Information booklet will be mailed to you.

Identification plates

Vehicle identification plate with vehicle identification number (VIN)

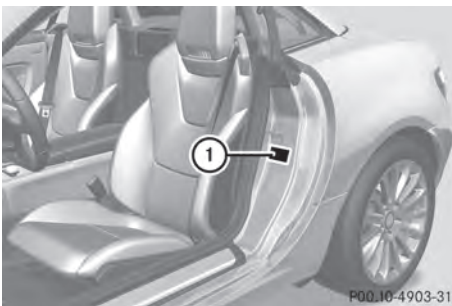

- ▶ Open the driver's door. You will see vehicle identification plate ①.



Example: vehicle identification plate (USA only)



Example: vehicle identification plate (Canada only)

- ② VIN
- ③ Paint code

- ① The data shown on the vehicle identification plate is used only as an example. This data is different for every vehicle and can deviate from the data shown here. You can find the data applicable to your vehicle on the vehicle's identification plate.

VIN



- ▶ Slide the front-passenger seat to its frontmost position.
- ▶ Fold trim ① upwards.
You will see VIN ② stamped into the vehicle body.

The VIN can also be found in the following locations:

- on the vehicle identification plate (▷ page 347)
- on the lower edge of windshield (▷ page 348)

Engine number

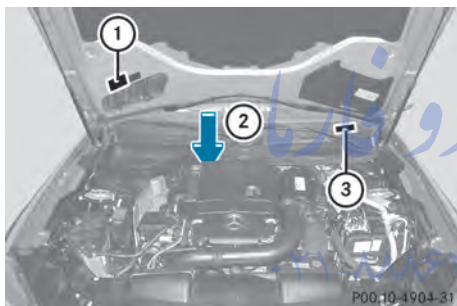

- ① Emission control information plate, including the certification of both federal and Californian emissions standards
- ② Engine number (stamped into the crankcase)
- ③ VIN (on the lower edge of the windshield)

Service products and filling capacities

Important safety notes

WARNING

Comply with all valid regulations with respect to handling, storing and disposing of service fluids. Otherwise, you could endanger persons or the environment.

Keep service fluids out of the reach of children.

For health reasons, you should prevent service fluids from coming into direct contact with your skin or clothing.

If a service fluid is swallowed, contact a physician immediately.

Environmental note

Dispose of service products in an environmentally responsible manner.

Service products include the following:

- Fuels
- Lubricants (e.g. engine oil, transmission oil)
- Coolant
- Brake fluid
- Windshield washer fluid
- Climate control system refrigerant

Components and service products must be matched. You should therefore only use products that have been tested and approved by Mercedes-Benz.

Information about tested and approved products can be obtained from an authorized Mercedes-Benz Center or on the Internet at <http://bevo.mercedes-benz.com>.

You can recognize service products approved by Mercedes-Benz by the following inscription on the containers:

- MB-Freigabe (e.g. MB-Freigabe 229.51)
- MB Approval (e.g. MB Approval 229.51)

Other designations or recommendations indicate a level of quality or a specification in accordance with an MB Sheet number (e.g. MB 229.5). They have not necessarily been approved by Mercedes-Benz.

Fuel

Important safety notes

WARNING

Gasoline is highly flammable and poisonous. It burns violently and can cause serious personal injury.

Never allow sparks, flames or smoking materials near gasoline.

Turn off the engine before refueling.

Whenever you are around gasoline, avoid inhaling fumes and any skin or clothing contact.

Direct skin contact with fuels and the inhalation of fuel vapors are damaging to your health.

Tank capacity

Model	Total capacity
All models	18.5 US gal (70.0 l)

Model	Of which reserve
All models	Approx. 2.4 US gal (9.0 l)

Gasoline

Fuel grade

I Do not use diesel to refuel vehicles with a gasoline engine. Even small amounts of the wrong fuel result in damage to the fuel system and engine.

I You should only refuel with unleaded premium-grade gasoline as this avoids damaging the catalytic converter.

If engine running problems are apparent, have the cause checked immediately and repaired. Excess unburned fuel can otherwise enter the catalytic converter, leading to overheating and possibly causing a fire.

I To ensure the longevity and full performance of the engine, only premium-grade unleaded gasoline may be used.

If there is no premium-grade unleaded gasoline available and regular unleaded gasoline must be used, please observe the following precautions:

- only fill the fuel tank to half full with regular unleaded gasoline and fill the rest with premium-grade unleaded gasoline as soon as possible.
- do not drive at the maximum speed.
- avoid sudden acceleration.
- if the vehicle is carrying a light load, e.g. two passengers without luggage, do not allow the engine to rev above 3000 rpm.
- if the vehicle is fully loaded or is being operated in mountainous terrain, do not depress the accelerator pedal further than $\frac{2}{3}$ of the pedal travel.

Only refuel using premium-grade unleaded gasoline with a minimum octane rating of 91. Reformulated Gasoline (RFG) and/or unleaded gasoline with additives can be used. The concentration of additives in the fuel, however, must not exceed 10%, e.g.:

- Ethanol
- TAME
- ETBE
- IPA
- TBA

For MTBE, the concentration should not exceed 15%.

The concentration of methanol in gasoline, including other additives, must not exceed 3%.

Using mixtures of methanol and ethanol is not permitted. Gasohol, a mixture of 10% ethanol and 90% unleaded gasoline, may be used.

All of these mix fuels must fulfill the fuel requirements, e.g.:

- knock resistance
- boiling point
- vapor pressure

You will usually find information about the fuel grade on the pump. If you cannot find the

label on the pump, ask the staff for assistance.

- i** For further information, consult an authorized Mercedes-Benz Center or on the Internet at <http://www.mbusa.com> (USA only).

Information on refueling (▷ page 152).

Additives in gasoline

- !** Do not refuel with low-grade fuel and do not use fuel additives that are not tested and approved for Mercedes-Benz vehicles. Damage to or malfunctions of the fuel system may otherwise occur.

One of the main problems of poor fuel quality is the forming of deposits that are created during the gasoline combustion process. Mercedes-Benz recommends that you use branded fuels that have additives.

If you use fuels without these additives over a longer period of time, carbon deposits may build up. These deposits form at the inlet valves and in the combustion chamber in particular.

This could lead to engine problems, e.g.:

- longer engine warm-up phase
- uneven idle
- engine noise
- misfiring
- loss of power

Carbon deposits may form if the availability of gasoline with relevant additives is insufficient (in certain regions). In this case, Mercedes-Benz recommends additives approved for use in Mercedes-Benz vehicles; see <http://bevo.mercedes-benz.com>.

For a list of approved products, consult an authorized Mercedes-Benz Center. Comply with the instructions for use on the product label.

Do not mix other fuel additives with fuel. This causes unnecessary costs and could damage the engine.

Engine oil

General notes

- !** Never use engine oil or an oil filter of a specification other than is necessary to fulfill the prescribed service intervals. Do not change the engine oil or oil filter in order to achieve longer replacement intervals than those prescribed. You could otherwise cause engine damage or damage to the exhaust gas aftertreatment.

Follow the instructions in the service interval display regarding the oil change. Otherwise, you may damage the engine and the exhaust gas aftertreatment.

The engine oils are matched to the performance of Mercedes-Benz engines and service intervals. You should therefore only use engine oils and oil filters that are approved for vehicles with maintenance systems.

For a list of approved engine oils and oil filters, consult an authorized Mercedes-Benz Center. Or visit the website <http://bevo.mercedes-benz.com>.

The table shows which engine oils have been approved for your vehicle.

Model	Engine model	MB Approval
SLK 250	271	229.5
SLK 350	276	
SLK 55 AMG	152	

Use only SAE 0W-40 or SAE 5W-40 engine oils for AMG vehicles.

- i** MB approval is indicated on the oil containers.

Filling capacities

The following values refer to an oil change including the oil filter.

Model	Capacity
SLK 250	5.8 US qt (5.5 l)
SLK 350	6.9 US qt (6.5 l)
SLK 55 AMG	With external oil cooler: 10.0 US qt(9.5 l)

Additives

- !** Do not use any additives in the engine oil. This could damage the engine.

Engine oil viscosity

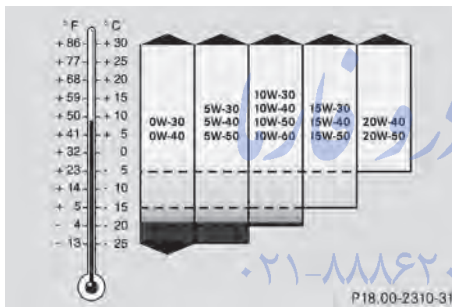

Viscosity describes the flow characteristics of a fluid. If an engine oil has a high viscosity, this means that it is thick; a low viscosity means that it is thin.

Select an engine oil with an SAE (viscosity) classification suitable for the prevailing outside temperatures. The table shows you which SAE classifications are to be used. The low-temperature characteristics of engine oils can deteriorate significantly, e.g. as a result of aging, soot and fuel deposits. It is therefore strongly recommended that you carry out regular oil changes using an approved engine oil with the appropriate SAE classification.

Brake fluid

⚠ WARNING

Over a period of time, the brake fluid absorbs moisture from the air; this lowers its boiling point.

If the boiling point of the brake fluid is too low, vapor pockets may form in the brake system when the brakes are applied hard (e.g. when driving downhill). This would impair braking efficiency.

You should have the brake fluid renewed at regular intervals. The brake fluid change intervals can be found in the Maintenance Booklet.

Only use brake fluid approved by Mercedes-Benz according to MB Approval 331.0.

Information about approved brake fluid can be obtained at any qualified specialist workshop or on the Internet at <http://bevo.mercedes-benz.com>.

- i** Have the brake fluid renewed regularly at a qualified specialist workshop.

Coolant

Important safety notes

⚠ WARNING

Antifreeze is highly flammable. Fire, open flames and smoking are prohibited when handling antifreeze.

If antifreeze comes into contact with hot engine parts, it may ignite and you could burn yourself. Do not spill any antifreeze on hot engine parts.

- !** Only add coolant that has been premixed with the desired antifreeze protection. You could otherwise damage the engine.

Further information on coolants can be found in the Mercedes-Benz Specifications for Service Products, MB Specifications for Service Products 310.1, e.g. on the Internet at

<http://bevo.mercedes-benz.com>. Or contact a qualified specialist workshop.

- Always use a suitable coolant mixture, even in countries where high temperatures prevail.

Otherwise, the engine cooling system is not sufficiently protected from corrosion and overheating.

The coolant is a mixture of water and antifreeze/corrosion inhibitor. It performs the following tasks:

- corrosion protection
- antifreeze protection
- raising the boiling point

If the coolant has antifreeze protection down to -35°F (-37°C), the boiling point of the coolant during operation is approximately 266°F (130°C).

The antifreeze/corrosion inhibitor concentration in the engine cooling system should:

- be at least 50%. This will protect the engine cooling system against freezing down to approximately -35°F (-37°C).
- not exceed 55% (antifreeze protection down to -49°F [-45°C]). Otherwise, heat will not be dissipated as effectively.

If the vehicle has lost coolant, add equal amounts of water and antifreeze/corrosion inhibitor. Mercedes-Benz recommends an antifreeze/corrosion inhibitor concentrate in accordance with MB Specifications for Service Products 310.1.

The coolant is checked with every maintenance interval at a qualified specialist workshop.

- When the vehicle is first delivered, it is filled with a coolant mixture that ensures adequate antifreeze and corrosion protection.

Filling capacities

Missing values were not available at time of going to print.

Model	Capacity
SLK 250	Approx. 10.1 US qt (9.6 l)
SLK 350	Approx. 11.0 US qt (10.4 l)
SLK 55 AMG	

- Use antifreeze/corrosion inhibitor according to MB approval 325.0 or 326.0.

Windshield/headlamp cleaning system

Important safety notes

WARNING

Washer solvent/antifreeze is highly flammable. Do not spill washer solvent/antifreeze on hot engine parts, because it may ignite and burn. You could be seriously burned.

- Only use washer fluid that is suitable for plastic lamp lenses, e.g. MB SummerFit or MB WinterFit. Unsuitable washer fluid could damage the plastic lenses of the headlamps.
- Do not add distilled or de-ionized water to the washer fluid container. Otherwise, the level sensor may be damaged.
- Only MB SummerFit and MB WinterFit washer fluid should be mixed together. The spray nozzles may otherwise become blocked.

At temperatures above freezing:

- ▶ Fill the washer fluid reservoir with a mixture of water and windshield washer fluid, e.g. MB SummerFit.
- ▶ Add 1 part MB SummerFit to 100 parts water.

At temperatures below freezing:

- ▶ Fill the washer fluid reservoir with a mixture of water and windshield washer fluid, e.g. MB WinterFit.

Adapt the mixing ratio to the outside temperature.

- Down to 14 °F (-10 °C): mix 1 part MB WinterFit with 2 parts water.
- Down to -4 °F (-20 °C): mix 1 part MB WinterFit with 1 part water.
- Down to -20.2 °F (-29 °C): mix 2 parts MB WinterFit with 1 part water.

- ❶ Add windshield washer fluid, e.g. MB SummerFit or MB WinterFit, to the washer fluid all year round.

Filling capacities

Missing values were not available at time of going to print.

Model	Capacity
SLK 250 SLK 350	3.7 US qt (3.5 l)
SLK 55 AMG	

Vehicle data

General notes

Please note that for the specified vehicle data:

- the heights specified may vary as a result of:
 - Tires
 - Load
 - Condition of the suspension
 - Optional equipment
- the vehicle length specified includes the front license plate adapter.

Dimensions and weights



Model	❶ Opening height
All models	(70.7 in) (1796 mm)

All models (except AMG vehicles)	
Vehicle length	162.9 in (4138 mm)
Vehicle width including exterior mirrors	79.0 in (2006 mm)
Vehicle height	51.3 in (1303 mm)
Wheelbase	95.7 in (2430 mm)

All models (except AMG vehicles)	
Turning radius	34.5 ft (10.52 m)
Maximum trunk load	220 lb (100 kg)

SLK 55 AMG	
Vehicle length	163.2 in (4146 mm)
Vehicle width including exterior mirrors	79.0 in (2006 mm)
Vehicle height	51.2 in (1301 mm)
Wheelbase	95.7 in (2430 mm)
Turning radius	34.6 ft (10.55 m)
Maximum trunk load	220 lb (100 kg)

تلفن شبانه روزی: ۰۲۱-۸۸۸۶۲۰۸۵

FarmaSOS.com

امداد خودرو فارما

تلفن شبانه روزی: ۰۲۱-۸۸۸۶۲۰۸۵

FarmaSOS.com

امداد خودرو فارما

تلفن شبانه روزی: ۰۲۱-۸۸۸۶۲۰۸۵

FarmaSOS.com